

Class

Book





Railway Age Gazette

MECHANICAL EDITION

INCLUDING THE
AMERICAN ENGINEER

Established 1832

INDEX TO VOLUME LXXXVII

1913

ALSO OF THE

5303

DAILY RAILWAY AGE GAZETTE

ISSUED DURING THE

M. M. AND M. C. B. CONVENTIONS

INDEX, 1913

VOLUME LXXXVII

A

Accidents on electric railways.....	130†
Accumulators, Hydro-pneumatic, Watson-Stullman Co.....	1421*
Acetylene mantle lamp.....	1468
Aeme Machine Tool Co., Turret lathe.....	677*
Aeme Supply Co., Car window.....	1499*
Aeme Supply Co., Diaphragm.....	1530*
Aeme Supply Co., Diaphragm attachment.....	1503*
Advertising pages, appearance of, in <i>American Engineer</i>	62‡
Aeroplane flight, Record for.....	366†
African railways, Gauge of.....	1417
Air brake apparatus, Grinding piston rings.....	132*
Air Brake Association (see also Meetings).	

Air Brake Association Convention.

(Reports and Discussions.)

Air hose failures.....	329
Freight trains, Operating long.....	286*
Quick action, Undesired, its prevention and remedy.....	317
Secretary's report.....	286
Steam heat traps, Location of.....	329
Triple valves, Will they operate as intended?.....	319*
Air brake, Care and maintenance of, by Ralph Wolfe.....	265
Air brake, Electro-pneumatic.....	95
Air brake hose.....	588, 5798,
Air brake hose, by J. S. Sheafe.....	1162,
Air brake hose coupling, Sheafe.....	332*
Air brake hose failures, by T. W. Dow.....	329
Air brake hose label.....	618*
Air brake hose specification, M. C. B.....	1509*
Air brake safety attachment, Sauvage.....	1423*
Air brake work, Small face plate for.....	253*
Air brakes, United States.....	508*
Air brake valve, Sauvage.....	1468*
Air brake, Variable load, Bettendorf.....	1465*
Air brake work, Small face plate for.....	253*
Air brakes, Operation of triple valves.....	319*
Air brakes, Testing slide valve feed valves in roundhouse.....	545*
Air brakes, Undesired quick action of.....	319
Air clamp for drill press, M. K. & T.....	81*
Air compressor, Gasoline driven.....	1467*
Air hammer for boiler shops, Frisco.....	191*
Air hammer, "Little David".....	332*
Air hose coupling.....	332*
Air intake for car window, Garland.....	564*
Air motors, Angle attachment for, B. & O.....	22*
Air pump, Compound, locomotive.....	104*
Air pump, Oiling the air cylinders of.....	1368*
Air pump steam head repairs.....	605*
Air pump testing stands, Frisco.....	375*
Air pump valves, Protecting in shipment, C. & N. W.....	132*
Air sander for interurban cars.....	482*
Alaska, Railway in.....	390†
Alcohol heater car, Tests of.....	441*
Alcohol Heating & Lighting Company, Tests of car.....	441*
Alden, C. L., Freight car troubles.....	266
Allen, G. G., Rolling mills at scrap docks.....	305
Alloys, Melting point of commercial copper.....	640†
American Car & Foundry Co., Car, steel refrigerator.....	84†
American Car & Foundry Co., Annual report.....	461
American Car & Foundry Co., Car, box, P. M. & St. P.....	211*
American Car & Foundry Co., Car, express refrigerator.....	149*
American Car & Foundry Co., Car, postal, M. & St. P.....	1410*
American Car & Foundry Co., Car, postal, Washab, 60-foot steel.....	609*
American Car & Foundry Co., Car, refrigerator, Union Pacific.....	263*
American Car & Foundry Co., Car, postal, frame box, Frisco.....	555*
American Car & Foundry Co., Folding lavatory.....	152*

Page numbers under 1,000 refer to *Railway Age Gazette, Mechanical Edition*; those over 1,000 refer to the *Daily Railway Age Gazette*. * Illustrated article; † editorial; ‡ short non-illustrated article or note; † communication.

American Electric Railway Association convention announcement.....	571
<i>American Engineer</i> , Change in name.....	283‡
American Flexible Bolt Co., Flexible bolt.....	1299*

American Locomotive Company,

Annual report.....	514
Associated Lines standard locomotive.....	6*
Large narrow gauge locomotive.....	20*
Throttle rigging, Improved.....	331*
Locomotive, 0-6-0 type, Ill. Cent.....	362*
Locomotive, 2-8-0 type, W. & L. E.....	641*
Locomotive, 2-8-2 type, Grand Trunk.....	1359*
Locomotive, 2-8-2 type, Lake Shore.....	231*
Locomotive, 4-6-2 type, D. L. & W.....	1390*
Locomotive, 4-6-2 type, Erie.....	1392*
Locomotive, 4-8-2 type, Mo. Pac.....	583*
American Mason Safety Tread Co., car step.....	1499*
American Museum of Safety meeting.....	680
American Packing Company, Graphometal packing.....	160*
American Railway Master Mechanics' Association (see Master Mechanics' Association).	
American Railway Tool Foremen's Association (see Tool Foremen's Association).	
American Steel Foundries, Car truck experiments.....	42*
American Society of Mechanical Engineers, (see also Meetings).	

American Society of Mechanical Engineers.

(Papers and discussions.)

Car, Box, Steel frame, by R. W. Barnett.....	651*
Car, Box, Steel underframe, by G. W. Rink.....	657*
Car, Passenger, Design of steel.....	657
Locomotive, Selection of.....	38
Locomotive, Selection of, Discussion by F. F. Games.....	12
Locomotive, Selection of, Discussion by A. W. Gibbs.....	12
Locomotive, Selection of, Discussion by G. R. Henderson.....	13
Locomotive, Selection of, Discussion by S. Hoffman.....	13
Locomotive, Selection of, Discussion by W. F. Kiesel.....	11
Locomotive, Selection of, Discussion by H. H. Vaughan.....	11
Locomotive, Selection of, Discussion by C. D. Young.....	15*
American Tool Works Co., Geared head lathe.....	1398*
American Tool Works Co., Improved radial drill.....	1264*
American Vanadium Co., Service of rods and tires.....	648
American Vanadium Co., Test of driving wheel tires.....	15*
Ames, John McE., Underframe, steel passenger car, A. S. M. E.....	261
Anderson, H. A., Inactive and obsolete stock angle coil, Improved, Kendrick.....	298
Appliances, defective on railway rolling stock.....	1265*
Appointments in the mechanical department.....	244†
Apprentice instruction on Santa Fe.....	1118
Apprentice schools, on the Erie, Cent. and Cent. of Ga.....	80*
Apprentices, number on Ill. Cent. and Cent. of Ga.....	249*
Apprentices, training.....	348‡
Apprenticeship, cost of, Ill. Cent. and Cent. of Ga.....	240*
Apprenticeship, description of system on Ill. Cent.....	249*
Apprenticeship, moving pictures in.....	174‡

Apprenticeship on the Ill. Cent.....	249*
Apprenticeship paper at General Foremen's convention.....	417
Apprenticeship training, Address by G. M. Lasford.....	351
Arbor, Expansion, Boston & Maine.....	595*
Arch bars, Airorr for inspecting.....	96*
Arch tube cleaner.....	1300*
Arch tubes, Tools for inserting.....	28*
Argentina, New railway mileage in.....	30†
Argentina, Railway difficulties in.....	404†
Argentine, Innovations on passenger cars in Arm rest, Hinged, for cab.....	241*
Arnold, B. H., Motor cars.....	324*
Ashmore, C. D., Repairs to main rods.....	29*
Ashton Valve Company, Wheel press recording gauge.....	447*
Asia Minor, Railway construction in.....	144†
Associated Lines, Standard locomotives.....	5*
Atlantic City conventions, List of exhibitors and representatives.....	1267
Atlantic Coast Line, Boiler tube rack.....	606*
Atlantic tube locomotives, Possibilities of, Discussion by W. F. Kiesel, Jr.....	11
Attachment for countersinking on drill press, B. & O.....	22*
Australia, Change of gauge in.....	344†
Australia, Railway difficulties in.....	402†
Automatic welding in locomotive fireboxes.....	670*
Automatic connector, Durbin.....	454*
Automobile car, Steel frame, P. R. R.....	1492*
Aviation record.....	717, 212†
Axle design for gondola car.....	316†
Axle lathe output, Increasing, by C. L. Dickert.....	381*
Axle lighting system, Santa Fe.....	34*
Axles, Heat treated steel.....	392†
Axles, Interchangeable wide and narrow gauge.....	1366
Ayers pipe clamp.....	30†
	234*

B

Babbitt on car journal brasses, C. & N. W.....	267*
Babeock, F. H., Portable rivet forge, P. & L. E.....	33*
Babeock safety water gauge.....	333*
Barcelo Mfg. Co., Wrench.....	1467
Barney & Smith Car Co., End construction for steel cars.....	87
Barney & Smith Car Co., N. Y. C. coach.....	89*
Barnum, M. K., goes to Baltimore & Ohio.....	1371‡
Basford, G. M., You have received, what will you give?.....	351
Basin, for comparing machine tools, L. R. Pomeroy.....	114‡
Bates, Henry A., Non-vibrating chair.....	568*
Battery, Lead storage in Europe.....	524†
Bausch Machine Tool Co., Radial drill.....	511†
Baxter charcoal car heaters.....	451*

Baldwin Locomotive Works.

East Chicago plant.....	345
Hodges trailer truck.....	74*
Locomotive, Associated Lines, standard Locomotive, 2-8-2 type, Ill. Cent.....	362*
Locomotive, 2-8-2 type, Lehigh Valley.....	1408*
Locomotive, 4-6-2 type, New Haven.....	1293*
Locomotive, 4-6-2 type, Santa Fe.....	525*
Locomotive, 2-8-2 type, Santa Fe.....	525*
Ball bearings on axle lighting generators.....	453†
Ball joints, Machine for turning.....	603*
Ballast cars, Repairing.....	608
Baltic type locomotives.....	190*
Baltimore & Ohio, Cumberland terminal.....	591*
Baltimore & Ohio, Driving box kinks.....	75*
Baltimore & Ohio engine house for Mallets.....	577‡
Baltimore & Ohio locomotive shop kinks.....	21*
Baltimore & Ohio postal car lighting tests.....	212*
Barber four-point car truck.....	1502*
Baxter charcoal car heaters.....	451*
Belgium, Railway ties in.....	574†

Baldwin Locomotive Works—(cont.)

Belt record, W. & L. E. 370*
 Belts, Slipping of, 296†
 Bender for flat rods, 136*
 Bender for round rods, G. N. 136*
 Bending machine, Air, 254*
 Bentley, F. W., Jr., Face plate for air brake
 work, 136*
 Bentley, F. W., Jr., Protecting air pump
 valves in shipment, C. & N. W. 132*
 Bentley, F. W., Jr., Spool for packing, 596*
 Bentley, F. W., Jr., Testing slide valve
 feed valves in roundhouse, 545*
 Bentley, F. W., Jr., Wrench for removing
 lubricator plugs, C. & N. W. 371*
 Bentley, H. H., Address at Fuel convention
 Boston, 289
 Betendorf Co., High capacity truck, 1503*
 Betendorf Co., Refrigerator cars, Union
 Pacific, 263*
 Betendorf Co., Varieties of bread, 1465*
 Beyer, O. S., Jr., Factors in locomotive
 selection, 9
 Beyer, O. S., Jr., Railway specifications, 50
 Birmingham, R. A., Waste retainer for journal
 boxes, 510*
 Birmingham Southern, 70 ton hopper car,
 Blackburn, H. E., Apprentice shooper on the
 Erie, 803*
 Blackburn, H. E., Hard greases, 662*
 Blacksmiths' Association (see Master Black-
 smiths' Association).
 Blacksmith shop, Forging dies, 77*
 Blacksmith shop, De Voo, Dierck, 253*
 Blacksmith shop, Use of bulldozers, 453*
 Blow torch, Universal, 453*
 Boiler check, Osman, 456*
 Boiler circular, Apparatus for testing, 65*
 Boiler design, Locomotive, Discussion, 12
 F. Gaines, A. S. M. E., 334*
 Boiler ejector for coal sprinkling, 1277*
 Boiler inspection law, Comments at Boiler
 Makers' Conv., N. C., 32
 Boiler inspector, Federal, Report of, 32
 Boiler-makers Association (see also Meetings).
 (Reports and Discussions.)
 Address of J. F. De Voo, Director, 316
 Address of J. F. Ensign, 314
 Address of Frank McNamany, 315
 Address of W. L. Park, 314
 Address of Robert Gayle, 315
 Address of C. Seley, 314
 Effect of superheaters on life of firebox
 and flues, 315
 Election of officers, 316
 Feed water, Treating, Benefits derived
 from, 316
 Grates, Best form of, 316
 Superheater tube welding, 315
 Tubes, Limit of length of boiler, 314
 Weak and unsafe condition of boiler, 314
 Welding, Oxy-acetylene and electric, 315
 Boiler scale, Device for preventing, 17*
 Boiler shells, Drilling holes in, M. K. & T., 184*
 Boiler shop kinks, 142*
 Boiler shops, Air hammer for, 191*
 Boiler studs and plugs, Form of thread and
 degree of taper, 435
 Boiler tests, 598
 Boiler tests, Low water, 606*
 Boiler tube rack, A. C. L., 23*
 Boiler tube tools, by Walter R. Hedeman, 314
 Boiler tubes, Limit of length without midway
 support, 314
 Boiler tubes, Welding superheater, 315
 Boilers, Armored squirt hose, 334*
 Boilers, Explosion, Jacobs-Shupert tests, 56†
 Boilers in New Zealand, 602*
 Boilers, Scrapping with oxy-acetylene torch,
 Boilers, Safety water glass, 333*
 Boilers, Tests of Jacobs-Shupert, 63†
 Boilers, Weak and unsafe condition, 314
 Bolster, Truck, Designing a, 158*
 Bolt, The Kiling, 636§
 Bolts, Variation in size, 636§

Books.

Air Brake Association, Proceedings
 1913 638
 Blacksmiths' Association, Proceedings,
 1912 60
 Book of Steam, National Tube Co., 230
 Calculus, An Elementary Treatise on,
 by W. S. Franklin, et al., 408
 Car Builders' Dictionary, 61
 Cement Specifications, A Treatise on,
 by J. J. Moran, 314
 Coal, by B. E. E. Somermeier, 60
 Dewey Decimal System of Classification,
 An Extension of, by L. P. Brecken-
 ridge and C. A. Goodenough, 60
 Diary of a Roundhouse Foreman, by
 T. S. Reilly, 114
 Diesel Engines for Land and Marine
 Work, by W. L. Webb, 408
 Economics of Railroad Construction, by
 W. L. Webb, 114
 Electric Motors, Investigation of Ex-
 plosion Proof 4

Books—(continued)

Electron Theory of Magnetism, by E.
 H. Williams, 114
 Engineering as a Profession, by Fleming
 and Bailey, 466
 Engineering Education, Society Proceed-
 ings, 521
 Engineer's Handbook on Patents, by
 William Macomber, 465
 Entropy-Temperature and Transmission
 Diagrams for Air, by C. R. Richards
 408
 Factory Lighting, by Clewley, 522
 Handbook of Railroad Expenses, by J.
 H. Hatfield, 115
 S. Eaton 115
 Heating and Ventilation, The Elements
 of, by A. M. Greene, Jr., 466
 Holmes Hincley, An Industrial Pioneer
 Hygiene for the Workers, by William
 G. Tolman 4
 International Railway Fuel Association,
 Proceedings, 1913 521
 Investigation of Passenger Cars, by Dr. Max
 Böttner, Bureau of Mines, 4
 Laying Out for Boilermakers, Second
 edition, 466
 Lighting of Passenger Cars, by Dr. Max
 Böttner 61
 Lined Oil and Turpentine, Density
 and Thermal Expansion of, by H. W.
 Holman, 60
 Locomotive Boiler Construction, by
 Kleinbans 522
 Locomotive Dictionary, 60
 Locomotive Operating, Practical, by
 Clarence Roberts 172
 Machine Design, by W. D. Hess, 114
 Master Blacksmiths' Association, Pro-
 ceedings, 1913 638
 Master Car and Locomotive Painters'
 Association Proceedings, 1912, 521
 Master Car Builders' Association, Pro-
 ceedings, 1912 114
 Passenger Cars Lighting of, by Dr. Max
 Böttner 61
 Railway General Foremen's Association,
 Proceedings, 1913 637
 Rules of Management, by William
 Lodge 522
 Sanitation, by Gas. A. Lauffer, 349
 Safety First, by George Bradshaw, 579
 Safety Valve Rating, by A. G. Carhart,
 Science of Burning Liquid Fuel, by W.
 N. Best 579
 Series Transformers, Characteristics and
 Limitations of, 152
 Shop Notes, by H. H. Winsor, 60
 Smoke and Smoke Prevention, Bibliog-
 raphy, 521
 Strength of Materials, Merriman, 637
 Traveling Engineers' Association, Pro-
 ceedings, 1912 115
 Traveling Engineers' Association, Pro-
 ceedings, 1913 637
 Tool Foremen's Association, Proceed-
 ings, 1913 638
 Water, Its Purification and Use, by
 Gustav 522
 Worn Gearing, by H. K. Thomas, 172
 Borer, F. J., Defective applications of brake
 apparatus 496
 Boring head, Offset, 335*
 Boring machines (see Machine tools).
 Boring mills, basis for measuring capacity,
 L. R. Pomeroy, 133*
 Boring tool, Expansion, Davis, 1469*
 Boston & Albany, Application of safety ap-
 pliances to cars, 147*
 Boston & Maine, Eccentric blade bender, 306*
 Boston & Maine, Machine shop kinks, 595*
 Boston & Maine, Spring, 192*
 Bowser, S. F., & Co., Tank for waste soak-
 ing, 1500*
 Box car, hopper bottom, Grand Trunk, 323*
 Box car, steel end, Grand Trunk, 400*
 Box car (see also Car, Box).
 Box cars, Defective, 62‡
 Boy, D. C., Moving pictures in educational
 work, 174‡
 Boyer pneumatic saw, 504‡
 Boyer speed recorder, Testing machine for,
 Erie 661*
 Brake apparatus, Defective applications of,
 Brake beam, Creco, 1437
 Brake beam hangers, Manufacture of, 368*
 Brake beams, Repairing, 191*
 Brake beams, standard recommended, 1505§
 Brake, Electro pneumatic, 95
 Brake, Friction on boring mill, C. & N. W., 138*
 Brake head, Adjustable, 1265*
 Brake pipe, Effect of size on triple valve, 319*
 Brake shoes, anti-rattle equipment, M. C. B., 1437
 Brake staffs, Upsetting, Cent. of Ga., 538*
 Brakes, Undesired quick action of, 317
 Brass, Pouring crown and hub liner in driv-
 ing boxes 165†
 Brazil, New line for, 200†
 Brazilian Railway 345†
 Breckenfeld, J. C., Air hammer for boiler
 shops 191*

Books—(continued)

Breckenfeld, J. C., Chuck for staybolt drill-
 ing 247*
 Breckenfeld, J. C., Shop kinks, Frisco, 373*
 Brick arch, Advantages of, Paper at T. E.
 A. Co. contains, 473
 Brick arch and smoke, 628‡
 Bridge, Proposed New York-New Jersey, 220†
 Bronson, C. E., Design of counterbalance
 weights, 529*
 Brotan boiler, Service of, 124*
 Buell, D. C., College men and the railroads, 580†
 Buell, D. C., Locating defective wheels, 152*
 Buell, D. C., Moving pictures in educational
 work 67
 Buffalo Brake Beam Co., Adjustable brake
 head 1265*
 Building column, Reinforcing for job crane,
 Bulleid, O. V. P., Chart for forging machine
 work 30*
 Bulldozer, Pneumatic, 309*
 Bulldozers in railway shops, by L. D. Free-
 man, 77*
 Bundy, C. L., Freight car design, 268
 Burglar-proof devices, 1470†
 Burma railways, 562†
 Burns, W. W., Steel frame box cars,
 A. S. M. E., 651*
 Burnside, III., Shop improvements, 193*
 Butt, F. W., Electrical equipment on motor
 cars, A. M. E., 260
 Butte, Anaconda & Pacific, Locomotive
 2400 v. D. C., electric, 1357*

C

C. & C. Electric & Mfg. Co., Electric arc
 welding 391*
 Cab deck, Shield for, 122*
 Cab furnishings, 241
 Cab vestibule, 1128, 117*
 Caboose levers, 82*
 Cain, D., Standard supply car, 307
 California, Elevated railway for, 397†
 Cam, C. Box, 1500
 Campbell, H. A. F., Locomotive connec-
 tion rods 175*
 Campbell, N. A., Electro-pneumatic brake, 95
 Canadian canals, Traffic through, 380†
 Canadian Locomotive Co., Power reverse
 gear 627*
 Canadian Pacific Railway, Box car for grain
 and coal traffic, 386*
 Canadian Pacific Railway Cars, Steel frame
 box 651*
 Canadian Pacific Railway, Laminated Draw-
 bar 288*
 Canadian Pacific Railway, Laying off shoes
 and wedges 307*
 Canadian Pacific Railway locomotive, 4-6-2
 type 117*
 Canadian Pacific Railway, Tender without
 underframe 120*
 Canadian Pacific Railway, Tests of alcohol
 heater car 441*
 Canadian Pacific Railway, Vestibuled cab, 120*
 Canadian Pacific Railway (see Craftings).
 Canals, New York, 438†
 Canavan, W. F., Shop kinks, M. K. & T., 81*
 Canton Foundry & Machine Co., Portable
 floor crane 568*

Car.

Application of safety appliances, 147*
 Articles in competition, 28, 57§, 111§, 170§
 Automobile, Steel frame, P. R. R., 1492*
 Baggage for scenery, C. R. R. of N. J., 615
 Ballast, Repairs (see Traffic).
 Bolster, Double body, by C. T. West-
 lake, A. S. M. E., 260
 Brake, Variable load, Betendorf, 1465
 Brake box, 326
 Box, Hopper bottom, Grand Trunk, 323*
 Box made into stock cars, C. B. & Q., 379
 Box, Steel end, New York Central, 400*
 Box, Steel end, Erie, 555
 Box, Steel frame, Grand Trunk, 323*
 Box, Steel underframe, A. S. M. E., 651*
 Box, Steel underframe, P. & R., 211*
 Box with hopper bottom, Car, Pac., 318
 Center sills, Tables for designing, 444*
 Cleaning on the Pennsylvania, 98†
 Construction 3408
 Construction as viewed by repair men, 255
 Construction of freight, Improved
 methods of, 437*
 Construction, Standing committee on, 1506§
 Coupler, Lion freight, 1504
 Coupler, Penn. freight, 1422*
 Coupler release rigging, 678*
 Coupler, Stark, 101*
 Coupler, and, 317
 Damage by improper loading, 649*
 Department notes, by Keyser, 203
 Design of freight, by C. L. Bundy, 268
 Design, Steel passenger problems, W.
 F. Rice, Jr., A. S. M. E., 257
 Design, Steel passenger roof structure,
 C. A. Seley, A. S. M. E., 258
 Design from repairman's standpoint, 143

Page numbers under 1,000 refer to *Railway Age Gazette, Mechanical Edition*; those over 1,000 refer to the *Daily Railway Age Gazette*. † Illustrated article; ‡ editorial; § short non-illustrated article or note; ¶ communication.

Car—(continued)

Designing freight, by E. G. Chenoweth. 505
 Diaphragm, Acme. 1530*
 Diaphragm attachment, Acme. 216*
 Door, Kumsky mat. 509*
 Door, Kumsky mat. 509*
 Doors, Camel. 1500*
 Doors, Frisco steel frame box car. 35*
 Draft gear for flat-top gondola. 1529*
 Draft gear, lever type. 207*
 Draft sills, Jersey Central gondola. 610*
 End, Cast steel, Washab postal. 87*
 End frames, cast steel, C. N. R. of N. J. 615*
 End, New Pullman. 207*
 End sill, Cast steel, C. K. R. of N. J. 1499*
 Ends, Pressed steel, by C. K. R. of N. J. 388*
 Flat, Eric, Special 75-ton. 1502*
 Flat, P. & R., Four-point bearing. 1502*
 Freight, Design of. 1503*
 Freight, Improved details. 437*
 Freight, Large capacity. 638*
 Freight, Repair costs. 1148*
 Freight standard. 1148*
 Freight troubles, by C. K. R. of N. J. 551*
 Freight troubles, by C. K. R. of N. J. 551*
 Gasoline for Holtan Interurban. 270*
 Gondola, Method of designing steel, by L. W. Wallace. 381*
 Gondola, 50-ton, low side, C. K. R. of N. J. 207*
 Gondola, 90-ton, N. & W. 35*
 Hand holds, Device for securing. 103*
 Heaters, Baxter charcoal. 35*
 Heating control, Thermomatic. 1522*
 Hopper, 70-ton, Birmingham Southern. 439*
 Hopper, 50-ton, C. K. R. of N. J. 439*
 Illumination of postal cars. 233*
 Inspection of postal cars, by R. V. Schulze. 33*
 Inspectors, Developing efficient, C. & N. W. 380*
 Instruction for train lighting, Pennsylvania. 655*
 Inspection, Street passenger, N. Y. C. 89*
 Interchange rules, Instruction. 154*
 Interior finish, by Felix Koch, A. S. M. E. 510*
 Journal box waste retainer. 267*
 Journal brasses, Babbiting, by E. H. Morey. 267*
 Journal jack, Duff. 1266*
 Journal jack, Retainer. 220*
 Ladder, Safety. 1469*
 Lighting, Axle generator suspension. 456*
 Lighting, Axle system, Santa Fe. 392*
 Lighting, Electric, by H. A. Currie, A. S. M. E. 259*
 Lighting, Electric fixtures for vestibules. 1420*
 Lighting, Fixture combined with electric fan. 1420*
 Lighting, Indirect, New Haven. 395*
 Lighting set, Terry. 676*
 Lighting, Specifications for postal. 607*
 Lighting tests. 14728*
 Low capacity in interchange. 1128*
 Mine rescue. 263*
 Motor, Electrical equipment, by F. W. Butt, A. S. M. E. 260*
 Motor, Gas-electric, P. & R. E. 143*
 Motor, Gasoline, Holtan Interurban. 270*
 Motor, Paper by Dodd and Arnold. 324*
 Motor, Sleeping for Australia. 38*
 Number ordered in 1912. 38*
 Painting steel passenger, C. D. Young, A. S. M. E. 259*
 Passenger, Collapsible end construction. 87*
 Passenger maintenance, Paper at Painters' Convention. 545*
 Passenger, New York Central Lines, steel. 89*
 Passenger, Painting of steel, by C. D. Young. 245*
 Postal, C. M. & St. P., Steel. 1410*
 Postal lighting fixtures, Safety car, H. & L. Co. 218*
 Postal, Test of illumination. 212*
 Postal, Washab, 60-foot steel. 609*
 Refrigerator, Express, Wells, Fargo & Co. 149*
 Refrigerator, Proportions and insulation. 620*
 Refrigerator, Tests of heater. 613*
 Refrigerator, Union Pacific. 441*
 Repair plant, J. H. Cent. 263*
 Repair sheds, Ill. Cent. 360*
 Repair track notes. 656*
 Repairing arrangements and facilities, L. S. Downing. 144*
 Repairs, Analysis of failures. 205*
 Repairs, Cost of freight, by F. F. Gaines. 205*
 Roof, Flexible arched metallic, Franklin framing, N. Y. C., Steel passenger. 93*
 Roof, Frisco box car. 14268*
 Roof, Leaky. 101*
 Roof, Outside metal, Pries. 1467*
 Seats, Steel. 324*
 Self-propelled, by Dodd and Arnold. 324*

Car—(continued)

Shedding, Selection and treatment of. 652
 Shop arrangements and facilities, L. S. Downing. 144*
 Side bearings, Anti-friction, Woods. 158*
 Side framing, N. Y. C., Steel passenger. 94*
 Sill steps, Forming dies for. 147*
 Sliding on wrecking trains. 640*
 Stake pocket, Collapsible. 178*
 Standard box. 6368*
 Standard, Development of box. 654*
 Scarf, Heat trap location. 2288*
 Steel frame box, History of. 651*
 Steel freight, Life of. 14228*
 Steel in the tropics. 5017*
 Steel passenger. 2288, 6378*
 Steel passenger air brakes, A. Humphrey, A. S. M. E. 260*
 Steel passenger, Are they needed? 650*
 Steel passenger design, A. S. M. E. 257*
 Steel passenger development of. 650*
 Steel passenger finishing, paper at painters' Convention. 539*
 Steel passenger in wreck. 601*
 Steel passenger special ends, H. M. Estarook, A. S. M. E. 262*
 Steel suspension, E. W. Sammers, A. S. M. E. 259*
 Step extension. 1504*
 Step safety, Amer. Masonry. 1499*
 Stock, Making from scrapped box cars, C. B. & O. 379*
 Subway, Proposed for New York. 302*
 Tap, Design of, H. E. Parsons. 445*
 Track, Link side bearing. 673*
 Testing plant. 18*
 Truck, Arch bar. 15058*
 Truck bolster design. 381*
 Truck equalizer design, by L. V. Curran. 96*
 Truck equalizer design, by Sigurd Holm. 3503*
 Truck four-point bearing, Barber. 1502*
 Truck, High capacity, Bettendorf. 1503*
 Truck, Location of side bearings. 14718*
 Truck locking device, Grand Trunk. 104*
 Truck, Punching spring links, Cent. of Ga. 131*
 Truck side frame design. 383*
 Truck, Six wheel for gondola car, N. & W. 38*
 Truck, Six-wheel, J. A. Pilcher, A. S. M. E. 259*
 Trucks, Comparison of rigid and loose. 43*
 Trucks, Mirror for inspecting, L. & N. Underframe, Dies forming dia- phragms. 79*
 Underframe, Frisco box car. 557*
 Underframe, Steel, G. W. Rink, A. S. M. E. 657*
 Underframe, Steel, N. Y. C. passenger. 90*
 Underframe, Steel, Washab postal. 611*
 Underframes, Steel, John McE. Ames, A. S. M. E. 261*
 Vestibule, Collapsible, Barney & Smith. 87*
 Vestibule curtain shield. 1524*
 Wheel failures. 329*
 Wheel flanges and treads, by A. Stuck. 5233*
 Wheel flanges and treads, by L. E. Wallace. 497*
 Wheels, Cast iron 70-ton car. 13698*
 Wheels, Chrome-Vanadium steel. 181*
 Wheels, Locating defective, D. C. Buel. 1529*
 Wheels, Nickelized. 204*
 Wheels, Removing flat spots from. 390*
 Wheels, Unloading. 564*
 Window air intake, Garland. 1499*
 Window, Weather-proof, Acme. 145*
 Wrecking equipment. 145*
 Car Foremen's Association of Chicago (see Meetings).
 Car Inspectors' and Car Foremen's Association report of annual convention. 380, 495
 Carline, Pressed steel, Cleveland. 511*
 Carry irons, Dies for bending. 191*
 Cars, also see Master Car Builders' Association (see notes).
 Carthy, F. J., Safety appliance application to cars. 147*
 Caruthers, C. H., Handling sand on locomotives. 1721*
 Case hardening, Paper at Blacksmith's Convention. 491*
 Casey-Cavin, Power reverse gear. 627*
 Casino, Technical Night School, address, by G. M. Basford. 351*
 Cast steel in blacksmith shop, paper at Blacksmiths' Convention. 492*
 Casting platforms, paper at Storekeepers' Convention. 313*
 Catalogs, 56, 110, 176, 281, 346, 403, 404, 461, 462, 518, 568, 634, 684.
 Cement in Russia. 634*
 Cent. Pacific, Truck center. 2194*
 Center sills, Tables for designing. 444*
 Central Electric Co., Lighting fixtures on New Haven. 395*
 Central Electric Co., Air hose coupling. 332*
 Central of Georgia, Apprenticeship on. 249*
 Central of Georgia, Increasing axle lathe output. 34*
 Central of Georgia, Machine shop kinks. 75*

Central of Georgia, Planing taper flanges. 414*
 Central of Georgia, Punching spring links. 131*
 Central of Georgia, Smith shop kinks. 253*
 Central of Georgia, Shop kinks. 537*
 Central Railroad of New Jersey car, Fifty-ton steel hopper. 439*
 Central Railroad of New Jersey car, Low side gondola. 207*
 Central Railroad of New Jersey car, Special baggage for security. 615*
 Central Railway Club, paper on Freight car troubles. 551*
 Central Railway Club (see Meetings).
 Central South African, Locomotives. 20*
 Centralia mechanical terminal, Ill. Cent. 6284*
 Chair, Non-vibrating for parlor cars. 568*
 Chambers, A., Career as locomotive engineer. 1413*
 Chambersburg Engineering Co., Hydraulic forging press. 339*
 Chart for forging machine work, by O. V. Bulleid. 30*
 Chart for tractive effort, by L. R. Pomeroy (Penoweth, E. G., Freight car designing. 436*
 Chesapeake & Ohio canal. 428*
 Chesapeake & Ohio, Cylinder repaired with concrete. 131*
 Chesapeake & Ohio, Machine for turning ball joints. 603*
 Chesapeake & Ohio, Planing shoes and wedges. 32*
 Chesapeake & Ohio, Turbine tests record. 336*
 Chief clerk to the master mechanic. 70
 Chicago, Burlington & Quincy, Special wrecking tools. 147*
 Chicago, Burlington & Quincy, Stock car from scrapped box cars. 379*
 Chicago, Milwaukee & St. Paul, Steel postal car. 1410*
 Chicago & North Western, Babbiting car wheels. 267*
 Chicago & North Western, Blower valve. 160*
 Chicago & North Western, Car brass boring machine. 266*
 Chicago & North Western, Brake rollers. 243*
 Chicago & North Western, Main rod repairs. 29*
 Chicago & North Western, Overland limited. 2561*
 Chicago & North Western, Protecting slide valve feed valve in shipment. 132*
 Chicago & North Western, Safety on end. 137*
 Chicago & North Western, Slater front end. 7*
 Chicago & North Western, Smoke abatement devices. 236*
 Chicago & North Western, Smoking burning device. 513*
 Chicago & North Western, Tool for removing driving box cellars. 142*
 Chicago & North Western, Unloading. 390*
 Chicago & North Western, Wrench for removing lubricator choke plugs. 371*
 Chicago, Peoria & St. Louis, Locomotive valve gear. 215*
 Chicago Pneumatic Tool Co., Boyer pneumatic saw. 509*
 Chicago Pneumatic Tool Co., Gasoline driven air compressor. 1467*
 Chicago Railway Equipment Co., Brake beam. 1526*
 Chicago Railway Equipment Co., Roller side bearings. 1530*
 Chicago, smoke inspectors' Assoc. report. 478
 Chinese railway completed. 1447*
 Chrome-Vanadium driving wheel tire specifications. 16*
 Chrome-Vanadium driving wheel tire test. 15*
 Chrome-Vanadium steel wheels. 181
 Chrome-Vanadium (see also Vanadium).
 Chuck for drill press, Frisco. 374*
 Chuck for tender, Can. Pac. Co. 595*
 Cincinnati Lathe & Tool Co., Engine lathe. 272*
 Cincinnati Shaper Co., Back gear shaper. 1470*
 Cincinnati Shaper Co., Heavy service crank planer. 1265*
 Clamp for cross-rod, Frisco. 377*
 Clamp for driving boxes, Frisco. 373*
 Clamp for lifting tires, Frisco. 373*
 Clamp, Pneumatic for drill press, Thomson. 1038*
 C. M. & St. P., Bolt shop kinks, by C. S. L. W. 142*
 Classification of locomotives, N. Y. C. 527*
 Cleveland Car Specialty Co., Pressed steel lining in tender, Can. Pac. Co. 511*
 Coaches, New York Central, steel. 588*
 Coal, Amount of bituminous produced in America. 677*
 Coal in Japan. 323*
 Coal, Bituminous (Lignite coal). 324*
 Coal mine accidents. 290*
 Coal mine, Construction and operation of bituminous. 290*
 Coal pusher in tender, Can. Pac. Co. 1203*
 Coal, Safety squirt hose. 624*
 Coal, September shipments of anthracite. 568*
 Coal, Shipments of anthracite in October. 602*
 Coal, Sprinkler, Ejector flow. 354*
 Coal, Sprinkler, Improved. 510*
 Coal, Storage of. 2848*
 Coal, Transporting through pipe lines. 569*
 Coale Miter & Safety Valve Co., Securing safety valves. 1522

Page numbers under 1,000 refer to Railway Age Gazette, Mechanical Edition; those over 1,000 refer to the Daily Railway Age Gazette. * Illustrated article; † editorial; ‡ short non-illustrated article or letter; † communication.

Contract stations, Modern locomotive.....	294	Delaware, Lackawanna & Western locomotive, 4-6-2 type.....	1390*	Eccentric blade bender, B. & M.....	306*
College men and the railroad, J. S. 2523, 5233, 5278	5802	Delaware, Lackawanna & Western tank wheel and valve.....	513*	Eccentric, Drilling jigs for, Frisco.....	376*
College men and the railroads, by D. C. Bredt.....	5814	Design of safety water glass shield.....	333*	Eccentric strap liners, Turning in a boring mill.....	484*
College men and the railroads, by A. C. Humphreys.....	5814	Design of car front repairman's standpoint.....	143*	Eddy, W. J., Boiler studs and plugs.....	433
College men and the railroads, by A. J. Conrad.....	6383	Design of counterbalance weights, by E. H. Bronson.....	529*	Education (see Apprenticeship).....	
Committee on main and side rods, discontinuing.....	1111	Design of locomotive connecting rods, H. A. Dickert.....	175*	Emergency of common labor on railroads.....	1403§
Committee on subjects.....	13433	Design of tank cars, H. E. Parsons.....	445*	Electric air pumps at Blacksmiths' convention.....	683
Committee reports, Improved method of handling.....	13438	Detector for fractured crank pins.....	512*	Efficiency tests on the Pennsylvania.....	434*
Committee reports in early.....	13693	Petric and Harvey, Journal bearing boring.....	566	Ejectors for coal sprinkling, Hancock.....	391*
Commonwealth Steel Co., Swing motion tender truck.....	12488	DeVoy, J. F., Address at Blacksmiths' convention.....	516	Electric arc welding, C. & C. Co.....	391*
Competition, Car department.....28, 1708, 3578	377	Diagram (see Chart).....	566	Electric circuits, Loss in transmission.....	182*
Competition, Grinding.....4058, 4638, 6358	397	Diamond Specialty Co., Automatic cylinder dies.....	101*	Electric current, the Myriawatt.....	190
Connector, Automatic, Durbin.....	454	Diaphragm, Aene apex.....	101*	Electric headlight equipment, Installation and maintenance of.....	367*, 429*, 546*
Connecting rods (see Rods).....		Dickert, C. L., Driving boxes.....	1530*	Electric locomotives.....	603*
Connectors, Flexible metallic, Greenlaw.....	1501*	Dickert, C. L., Increasing axle larhe output.....	422	Electric locomotives, Experimental in France.....	129
Consolidated Car Heating, Hose coupler.....	1500	Dickert, C. L., Machining shop kinks.....	34*	Electric power, Transmission of.....	182*
Contract, Standard form for fuel.....	289	Dickert, C. L., Planning taper flanges on driving boxes.....	414*	Electric railway companies, Number of.....	327*
Convention, Air Brake Association.....	286*	Dickert, C. L., Punching spring planks.....	131*	Electric riveting machine, C. & C. Co.....	394*
Convention, Blacksmiths' Association.....	487*	Dickert, C. L., Smith shop kinks.....	253*	Electric Storage Battery Co., Axle lighting system.....	392*
Convention, Boilermakers' Association.....	314*	Dickert, C. L., Shop kinks.....	537*	Electric traction, paper at Blacksmiths' convention.....	486*
Convention, Car department.....	285	Die head, Landis stationary for pipe.....	626*	Electrical Engineers, Association of Railway meeting.....	1428
Convention, General Foremen.....	406*	Dies for brake beam hangers.....	77	Electrical Engineers, Association of Railway, Tests in passenger car lighting.....	607
Convention Hall, Crowding in.....	12488	Dies for landing castings.....	368*	Electrification, Cost of.....	606†
Convention, Railway Fuel Association.....	289	Dies for swaging tube ends.....	142*	Electrification of Melbourne Suburban Railways.....	516†
Convention, Railway Storekeepers' Association.....	297	Dies for thread cutting, paper at Tool Foremen's convention.....	433	Electric pneumatic brake, N. Y. & R. R. Co.....	95*
Convention, Painters' Association.....	539	Dies, Forging machine, paper at Tool Foremen's convention.....	5788, 588*	Elwell-Parker Electric Co., Electric truck.....	1497*
Convention, Traveling Engineers' Association.....	467*	Diesel locomotive.....	1302*	Employees, Number of railway, in Switzerland.....	76†
Cooperation between mechanical.....	1278§	Dieter Nut Co., Safety nut.....	180*	Employment bureau, Boston.....	53†
Cooper Hewitt Electric Co., Automatic tilting lamp.....	1402*	Dodd, S. T., Motor cars.....	2278	Enamelled interior trimmings, paper at Painters' convention.....	544
Cooper-Hewitt Electric Co., Quartz lamp.....	1532*	Doe, C. S., Standard oil house.....	310	End construction for passenger cars, Colapsible.....	87*
Copper ferrule expanding tool.....	354	Door, Frisco box car.....	559*	Engine house, Boston.....	601
Copper in rails.....	344†	Door, Rumsay, mail car.....	216*	Engine house for Mallets.....	5778
Copyright, Notice of.....	12478	Door, Preparing for journal boxes, N. & W.....	509	Engine house, Log for.....	600*
Cordeal, Ernest, Efficient power plant operation.....	531	Douglas, E. J., Boiler studs and plugs.....	443	Engine house operating board.....	600*
Cosgrove, P. E., Boiler shop scarfing.....	1904†	Doud, Willard, Mechanical terminal car.....	435	Engine house organization and operation by W. Smith.....	597*
Cost, Decreasing shop operating.....	1708	Dow, T. W., Air hose failures.....	329	Engine house smoke.....	585†
Cost keeping, Locomotive.....	124	Downing, I. S., Car shop arrangements and facilities.....	144	England, Private car troubles in.....	2848
Cost of freight car repairs.....	205, 635§	Draft gear attachment, Keylock.....	1504*	Enrollment Committee, Work of.....	12478
Cotton consulting.....	406*	Draft gear, Improved lever, McCord.....	1529*	Ensign, J. E., Address at Boiler Makers' convention.....	314
Counterbalance weight design.....	529*	Draft timber bolts.....	62†	Equalizer design, by L. Curran.....	266
Coupler and parts, Marking.....	318	Drafting, False economy in, by C. J. Morrison.....	361*	Equipment defects classified.....	236†
Coupler, Engine and tender, Santa Fe.....	274*	Draper Mfg. Co., Pneumatic flue welder.....	25*	Equivalent heating surface.....	62†
Coupler horn bracer folding dies.....	1707	Draper Mfg. Co., Tool for finishing ball joints.....	1401*	Eric Railroad apprentice school.....	80*
Coupler, Major.....	470†	Draps, Mfg. Co., Welder for superheater.....	1302*	Eric Railroad, Preparing and greasing.....	662†
Coupler, New design of car.....	101*	Drawbar, Laminated locomotive, Can. Pac.....	288*	Eric Railroad, Mechanical department organization.....	645*
Coupler, Penn freight.....	1422*	Drawbar yoke, Swiveled, McCord.....	1402*	Eric Railroad, Shop kinks.....	662†
Coupler, Standard.....	1426§	Drawing time saving.....	229§	Estabrook, H. M., Special ends for steel passenger cars, A. S. M. E.....	261
Coupler yoke shear and riveter, Watson-Stillman.....	1524*	Dresses Machine Tool Co., High duty radial drill.....	1300*	European road facilities.....	185*
Crane, Compensating quadrant.....	455*	Drill press air clamp, M. K. & T.....	81*	Eveland Engineering & Mfg. Co., Electric riveting machine.....	394*
Crane, Lathie chuck, Frisco.....	377*	Drill spooler, Gram.....	339*	Exhaust system for grinding wheels.....	305
Crane, Portable floor and hoist, Canm.....	508*	Drill (see also Machine Tools).....		Feed water, cost of.....	1279§
Crane on smoke stack.....	401*	Drills, Air and electric.....	1521	Exhibit, Coal, Abington.....	407
Crane-grinder, Mummert-Dixon.....	393*	Driving box, Brass liners for shoe and joints.....	75*	Exhibits open in the evening.....	578, 1164, 1743
Crank pin crack detector.....	512*	Driving box brasses, Taming on boring mill.....	296†	Exhibits open in the evening.....	578, 1164, 1743
Crank pin turning machine, Portable, Pedrick.....	569*	Driving box collars, Tool for removing, C. K. & T.....	81*	Exhibits, Space occupied by.....	12478
Crawford, D. F., President's address, M. M. convention.....	1278§	Driving box brasses, Talm for slotting, M. K. & T.....	81*	Experiments with freight car trucks.....	42*
Curtain, Extending Car Step Co., Car step.....	1504	Driving box brasses, Talm for slotting, M. K. & T.....	81*	Faessler steel cutting machine.....	23*
Crosshead, bronze liner, N. & W.....	428*	Driving box lateral plate, by H. A. Herndon.....	8*	Faessler Mfg. Co., Mandrel for tube expanders.....	271*
Crosshead, clamps, Frisco.....	377*	Driving box oil pipe for ball.....	76*	Farmers of C. & C. Co., Operating long train.....	229
Crosshead, Filing vice for, B. & M.....	596*	Driving box plugs, Molding.....	494*	Farris, C. H., Tables for designing center sills.....	386*
Crosshead shoes, Jig for drilling, B. & M.....	596*	Driving boxes, Taking up lateral on.....	74*	Fastnut Ltd. (London), Wrenches.....	1497
Crumble Steel Co., Tests of vanadium spring steel.....	70	Driving boxes, paper at General Foremen's convention.....	420*	Feed water, cost of.....	1279§
Cumberland terminal of the B. & O.....	591*	Driving boxes, Pouring brasses in, Lake Shore.....	414*	Feet water heater and superheater, Langtry.....	71*
Cups, Oil and grease for rods.....	366*	Driving boxes, Repairing locomotive, by M. Farmer.....	200*	Feed water heaters discussion, by G. R. Henderson, A. S. M. E.....	13
Curran, L. V., Truck equalizer design.....	96*	Driving boxes, Shaper for.....	100*	Feed water treatment, Benefits derived from Ferriss, H. S., Box.....	1524*
Currie, H. A., Electric lighting of passenger cars, A. S. M. E.....	259	Driving spring, Replacing on a Mallet.....	76	Feet water heaters discussion, by G. R. Henderson, A. S. M. E.....	13
Curtain, Side for cab.....	242*	Driving wheel, A new locomotive.....	450*	Feet water treatment, Benefits derived from Ferriss, H. S., Box.....	1524*
Curtis, Supply Co., Veil curtain shield.....	1524*	Driving wheel hubs, Dynamic discussion by A. W. Gibbs.....	12	Ferguson fine welding furnace.....	24*
Curtis, Charles A., Removing dirt spots from car wheels.....	204*	Driving wheel tires, Turning.....	173†	Files, Sharpening curved tooth.....	396*
Curves (see Chart).....		Driving wheels, Collar.....	74*	Findlay, James, Turning four-bar crosshead wrist pins.....	582†
Curves of locomotive operation, by L. R. Conway.....	68*	Drop forging, paper at Blacksmiths' convention.....	487	Fire doors, Franklin improved.....	1264†
Cylinder boring bar, M. K. & T.....	82*	Drum, M. J., Engine and tender coupler.....	274*	Fire extinguisher, Pyrene crackers.....	1524*
Cylinder clock, Automatic, Watertown.....	101*	Duff, S. W., Operation of triple valves.....	319*	Firebox, Effect of superheaters on life.....	315
Cylinder repaired with concrete, C. & O.....	131*	Duff, Paul R., Filter for shop drinking water.....	662*	Fireboxes (see Locomotive firebox).....	
Cylinders, Air brake, valves.....	4208	Duffey, Paul R., Firing-up house for locomotive terminals.....	536	Fires, Forest.....	206†, 527†
Cylinders, Larger locomotive.....	4208	Duffey, Paul R., Machine for drilling tell-tale holes.....	252*	Fires, Practice on.....	285†
Cylinders, Ratio of compound.....	2278	Duffey, Paul R., Tracks in shop buildings.....	648	Firing practice on locomotives.....	293
		Durbin automatic connector.....	454*	Firemen, Work of the.....	169§

Page numbers under 1,000 refer to *Railway Age Gazette, Mechanical Edition*; those over 1,000 refer to the *Daily Railway Age Gazette*. * Illustrated article; † editorial; ‡ short non-illustrated article or note; § communication.

Fisher & Norris, Quick acting lever vise..... 674*
 Flange joints in locomotive pipe connections..... 1425*
 Flue spots, Removing from car wheels..... 204*
 Flight, Long distance in France..... 307
 Flight, Record breaking monoplane..... 282*
 Flow meter, Improved, Gen. Elect. Co..... 507*
 Plug welder, Practical..... 507*
 Flue welding, paper at Blacksmiths' Convention..... 485*
 Flues, Effect of superheaters on life of..... 315
 Flywheel breakage, Locomotive pipe connections..... 430*
 Foster, C. W., Mud ring and flue sheet drill..... 619*
 Foreign subscribers to June Dailies..... 508*
 Forest fires, Causes of..... 496*
 Forest fires, Extinguishing..... 77*
 Forging dies..... 307*
 Forging by machine in railroad shops..... 77*
 Forging machine work, Chart for, by O. V. P. Rulled..... 300*
 Forging machine (see Machine Tools).
 Forms for locomotive operation and cost..... 124*
 Fostick Machine Tool Co., Horizontal boring, drilling and milling machine..... 563*
 Fostick Machine Tool Co., Radial drill..... 619*
 Foundry, Delaware & Hudson..... 134*
 Fowler, H., Motion work kinks..... 530*
 Ft. Worth & Denver City, High speed lateral plate..... 80*
 France, Nor. Ry. Baltic type locomotive..... 129
 France, Experimental electric locomotives..... 451*
 France, Forestry in..... 109*
 France, M. D., Repairing locomotive driving boxes..... 199*
 Franklin Railway Supply Co., Flexible arched metallic roof..... 1468*
 Franklin Railway Supply Co., Improved fire door..... 1264*
 Franklin Railway Supply Co., Tank and strainer valve..... 1367*
 Franklin Railway Supply Co., Joint for engine and tender..... 1400*
 Freeman, L. D., Bulldozer in railway shops..... 77*
 Freeman, L. D., Locomotive shop kinks..... 1400*
 Freight car construction, False economy..... 520*
 Freight car troubles, by J. C. Fritts..... 551*
 Freight cars, Standard..... 113*
 Freight train, Operating long, by F. B. Farmer..... 286*
 Freight engine house..... 187*
 Freyler, Daniel, Boiler studs and plugs..... 435
 Frisco (see St. Louis & Francisco).
 Fritts, J. C., Freight car troubles..... 551*
 Fritch, B., Handling scrap material..... 115*
 Front end, Slater..... 7*
 Fuel Association (see Railway Fuel Association).
 Fuel Association, Report of convention..... 289*
 Fuel, Combustion of, on a locomotive..... 593*
 Fuel convention, Notes on..... 284*
 Fuel economy and moving pictures..... 578*
 Fuel economy and operating department, Paper at T. E. & Convention..... 469*
 Fuel for motor cars..... 327*
 Fuel record, Individual, for engineers..... 142*
 Fuel saving and locomotive capacity..... 463*
 Full of laws, and other facts..... 332*
 Fuller, C. E., Address at M. C. B. Assoc..... 1430

G

Gage, Change of, in Australia..... 344*
 Gage cock, Nathan..... 1300*
 Gage cock holes, Locating on boiler..... 21*
 Gage for setting tire, Cent. of Ga..... 537*
 Gage, Wheel press recording..... 447*
 Gages for Walschaert valve gear parts..... 205
 Gaines, F. F., Discussion of brick arch and front ends..... 475
 Gaines, F. F., Discussion of locomotive boiler design..... 12
 Gaines, F. F., Set of freight car repairs..... 362*
 Gale, W. T., Safety on the C. & N. W..... 137*
 Gardner, Henry, Effect of pigments on linseed oil..... 188*
 Gardner, Henry, Set of freight car repairs..... 423*
 Garland car window air intake..... 564*
 Gas-electric car, Pittsburgh & Lake Erie..... 149*
 Gas generator, Kerosene..... 1498*
 Gas lighting with electric stokers..... 327*
 Gee locomotive stoker..... 111*
 General Electric Co., Electric locomotive..... 1357*
 General Electric Co., Improved steam fuel..... 507*
 General Electric Co., Motor Car, P. & L. E..... 143*
 General Electric Co., Reversing motor drive for planners..... 46*
 General Foremen's Association (see also Meetings).

General Foremen's Association Convention.

(Reports and discussion.)
 Address by Robert Quayle..... 415
 Apprenticeship..... 417
 Driving boxes..... 420*

General Foremen's Association Convention—(continued)

Election of officers..... 428
 Engine house organization and operation, by W. Smith..... 507*
 Notes on convention..... 406*
 President's address..... 423*
 Shop schedules, by Henry Gardner..... 415*
 Superheater locomotives..... 416
 Generator suspension, Safety axle..... 307*
 Gerling, W., Dry lumber shed..... 144*
 Germany, Prizes offered in..... 12
 Gibbs, A. W., Discussion of dynamic wheel loads..... 142
 Gold Car Heating & Lighting Co., Thermostatic heating control..... 1522
 Gondola car (see also Car).
 Gondola car, Designing a steel, by L. W. Walker..... 381*
 Goodrich, Chas. M., Cab window ventilator..... 676*
 Goodyear Tire & Rubber Co., Flexible hose..... 1500
 Gould & Eberhardt, Shaper for heavy service..... 1365*
 Graham Manufacturing Co., Drill speeder..... 339*
 Grain car inspection, R. W. Schulze..... 33
 Grand Trunk box car with hopper bottom..... 323
 Grand Trunk improved throttle lever rigging..... 331*
 Grand Trunk loading device for car and truck..... 104*
 Grand Trunk locomotive, 2-8-2 type..... 1350*
 Grate shaker brackets, Riegel..... 1391*
 Grate shakers, Shields for..... 122*
 Grates, Best form of..... 316
 Grates, Design of, by W. R. Hedeman..... 585*
 Grease plug for side rods..... 396*
 Grease, Traffic in..... 662*
 Great lakes, Ore shipment on..... 409*
 Great Northern motion work kinks..... 136*
 Greece, Railway development in..... 569*
 Greenlaw Mfg. Co., Lock for steam hose coupling..... 1398*
 Greenlaw Mfg. Co., Metallic connectors..... 1501*
 Greenchenberg tunnel..... 574*
 Grinders (see also Dies).
 Grinding competition..... 4058*
 Grinding machine for links..... 196*
 Grinding wheels and their use, by W. R. Hedeman..... 662*
 Grinding wheels, Exchange system for..... 305
 Grindstone at rip track..... 523*
 Guard for grinding wheels, C. & N. W..... 139*
 Guard for wheel lathe, C. & N. W..... 140*
 Guards for end rods in automatic machines, C. & N. W..... 138*
 Guards for lathe feed gears, C. & N. W..... 141*
 Guards for shop machinery..... 142*
 Gulf, Colorado & Santa Fe, Grain car inspection..... 33
 Guide bar blocks, by M. H. Westbrook..... 115*

H

Hall-Scott Motor Car Co., Cars..... 270*
 Hale & Kilburn Co., Steel interior finish..... 1525*
 Hammer crane shock absorber, paper at Blacksmiths' Convention..... 493*
 Hammer for removing side rod bushings, N. & W..... 484*
 Hancock Inspirator Co., Ejector for coal sprinkler..... 334*
 Hancock Inspirator Co., Improved coal sprinkler..... 510*
 Hand holds, Device for securing..... 103*
 Hanson, F. H., Effect of specifications on Ilardem Railroad..... 299
 Hasty, J. B., Thread cutting dies..... 428*
 Hatler, W. E., Dry lumber shed..... 433
 Heat, Treatment of..... 307*
 Healdlight, Electric, Pyle National..... 628*
 Healdlight equipment, electric, Installation and maintenance of..... 367*
 Heat treatment of case hardened steel..... 426*
 Heat treatment of metals, paper at Blacksmiths' Convention..... 492
 Heater for locomotive cab..... 242*
 Heckman, A. V., Forms for locomotive operation..... 124*
 Hedeman, W. R., Boiler tube tools..... 23*
 Hedeman, W. R., Design of locomotive grates..... 585*
 Hedeman, W. R., Grinding wheels and their use..... 662*
 Hedeman, W. R., Locomotive deck shield..... 122*
 Hedeman, W. R., Molding driving box plugs..... 494*
 Henderson, G. R., Discussion of locomotive feed water heaters..... 13
 Hendey Machine Co., Double head milling machine..... 1422*
 Hendey Machine Co., Universal milling..... 1302*
 Hendrickson, B., Forging machine dies..... 434
 Herndon, H. A., Driving box lateral plate..... 396*
 Hervey, D. F., Grease plug..... 393*
 Hervey locomotive stoker..... 1420*
 Heywood Brothers & Wakefield Co., Steel car seats..... 1467

Hobart-Alfred Co., Cylinders..... 1401*
 Hodges trailer truck, New design of..... 74
 Hoffman, S., Discussion of superheaters..... 13
 Hoist, Electric..... 333*
 Hoist, Pneumatic for loading cars..... 85*
 Holm, Sigurd, Truck equalizer design..... 350*
 Hols, Bending 78"..... 191*
 Hose, Air brake (see Air Brake Hose).
 Hose, Armored..... 219*
 Hose, Armored squirt..... 330*
 Hose coupler, Steam..... 1500
 Hose coupling, Flexible..... 333*
 Hose, Flexible metallic..... 1500
 Hose, Machine for mounting, M. K. & T..... 84*
 Hose, Metallic for locomotive..... 1400*
 Hose, Non-kinking air and steam..... 84*
 Hospital room in shops..... 219*
 Humphreys, A. C., Lohleke men and the railroads..... 581*
 Humphrey, A. L., Air brakes on steel passenger cars, A. S. M. E..... 260
 Hungarian State Railways, Device for preventing scale..... 17*
 Hungarian State Railways, Engine house..... 185*
 Huntley, W. P., Cracked cylinder repaired..... 131*
 Huntley, W. P., Grindstone at rip track..... 523*
 Hydraulic forging and bending press, Chamberlaine..... 339*
 Hydroplanes..... 209*

I

Ice hauling..... 300
 Illinois Central, Apprenticeship on..... 249*
 Illinois Central, Gases firebox on locomotives..... 362*
 Illinois Central, Hold-up on the..... 392*
 Illinois Central, Locating defective car wheels on..... 152*
 Illinois central, Mechanical terminal at Centralia..... 353*
 Illinois Central, Shop improvements at Burnside..... 193*
 Illuminating Engineering Society (see Meetings).
 India, Branch line in..... 392*
 India, New line for..... 516*
 Indian railway mileage..... 100*
 Indian railway policy..... 305
 Indicator cards, Steam consumption from..... 349*
 Independent Pneumatic Tool Co., Air and electric drills..... 1521
 Ingersoll-Rand Co., "Little David" riveting hammer..... 332*
 Injector repairing, by Chas. Markel..... 243
 Injuries, Hospital room in shops..... 84*
 Inspection of arch bars, Mirror for..... 96*
 Inspection of grain cars, by R. W. Schulze..... 33
 Inspection, Locomotive, P. & R..... 470*
 Inspection, Overhead, of box cars, M. C. B. Inspectors, Developing efficient car men..... 380
 Instruction of apprentices on the Ill. Cent. and Cent. of Ga..... 249*
 Instruction of car men on interchange rules..... 154
 Insulation of refrigerators..... 613
 Interchange rules and car men..... 112*
 Interchange rules, Changes in..... 1425*
 Interchange rules, Instruction of car men..... 154
 International Engineering Congress (see Meetings).
 International Oxygen Co., Oxygen generators..... 1400
 International Railway Fuel Association (see Railway Fuel Association).
 International Railway General Foremen's Association (see General Foremen's Association).
 Interlocuted at Atlantic City Convention..... 1412
 Ireland, Warning trains of wind storm..... 366*
 Italian railway earnings..... 71*

J

Jack, Car journal, Duff..... 426*
 Jack, Car journal, Reliance..... 136*
 Jack, Hydraulic pump..... 1265*
 Jacobs, H., European roundhouse facilities..... 185*
 Jacobs-Shupert boiler tests..... 59*
 Jenkins Bros., Brass gage valve..... 1501*
 Jerguson Mfg. Co., Improved Klinger type water gage..... 1299*
 Jesson, J. A., Air pump head repairs..... 605*
 Jesson, J. A., Driving piston rings of air brake apparatus..... 137*
 Jib crane, Ball bearing, W. & L. E..... 320*
 John-Manville Co., H. W., Non-kinking air and steam hose..... 219*
 Johnson, A. G., Improved operation of roller side bearing..... 1400*
 Johnson, A. G., Roller side bearing..... 1521*
 Joliet Railway Supply Co., Truck centering center plate..... 1524*
 Journal box for the Roumanian railways..... 1530
 Journal box lid, Locked..... 1525*
 Journal box lid, Pinless, McCord..... 1522*
 Journal box with steel inserts..... 1266*
 Justice, Philip S. & Co., Journal Jack..... 1266*

Page numbers under 1,600 refer to Railway Age Gazette, Mechanical Edition; those over 1,000 refer to the Daily Railway Age Gazette. * Illustrated article; † communication.

K

Kansas City Southern, Work on bulldozers, 77*
 Kavanagh, D., Platforms for casting, 313
 Kempsmith Manufacturing Co., Milling machine, 217*
 Kendall, A. H., System as applied to the repairs of locomotives, paper at Can. Ry. Club, 341
 Kennekamp Impregnating Co., Angle cock, 1265
 Keyser, Car department notes, 204*
 Keyser, Repairing ballast cars, 608
 Keveke Railway Equipment Co., Draft gear attachment, 1504
 Kiesel, W. F., Jr., Possibilities of the Atlantic type locomotive, 11
 Kiesel, W. F., Jr., Problems of steel passenger car design, 257
 Knauer Manufacturing Co., Charcoal car heaters, 451*
 King bolt, 1583
 Knight, John C., Air brake safety attachment, 1423*
 Knight, John C., Car, 1468*
 Koeh, Felix, Steel interior finish for cars, A. S. M. E., 259
 Kropidowski, V. T., Link grinding machine, 198*
 Kropidowski, V. T., Pressing in piston valve bushings, 244*
 Kropidowski, V. T., Turning eccentric strap liners in a boring mill, 484*
 Kropidowski, V. T., Installation and maintenance of electric headlights, 307* 429*
 546*, 603*

L

Ladder, Safety, for box cars, 220*, 1469*
 Lagoda Manufacturing Co., Device for removing scale, 219*
 Lake Shore & Michigan Southern I locomotive, 2-8-2 type, 2283, 231*
 Lake Shore & Michigan Southern, Repairing driving boxes, 199*
 Lamp, Automatic, 1902*
 Lamp, Quartz electric, 1523*
 Landis Machine Co., Stationary pipe die head, 626*
 Lanz superheater and feed water heater, 73*
 Lathé, Axle, Increasing output, 34*
 Lathé capacity, A basis for measuring, by L. R. Pomeroy, 133*
 Lathé chuck crane, Frisco, 377*
 Lathé dog, Heavy, Frisco, 374*
 Lathé, Driving wheel, Niles, 336*
 Lathé milling attachment, Santa Fe, 84*
 Lathé tool post, Turret, 34*
 Lathé, Use also Machine tools, 1523*
 Lavatory, Folding, for cars, 1523*
 Laws, Analysis of caboose, 87
 Laws, Locomotive headlight, Compilation of Lawson, A. B., Cab furnishings, 214*
 Lawson, A. B., Driving box knicks, 75*
 Lawson, A. B., Cold metal saw, 1367*
 Lea-Courtney Co., Cold metal saw, 1431*
 Legal day's work in New York, 366*
 Lehigh Valley, Coal saving on, 1902*
 Lehigh Valley locomotive, 2-8-2 type, 1408*
 Lehigh Valley mine rescue car, 263
 Lehon, Tom, Letter on exhibits, 1403*
 Letter hall, Result of M. M., 615
 Letter hall, Result of M. M., 316
 Lighter Mfg. Co., Arch tube cleaners, 1300*
 Lighting fixtures for postal cars, 218*
 Lighting of postal cars, 212*
 Lighting, Tests of passenger car, 607
 Lignite, Burning successfully on locomotives, 2858
 Lignite coal analysis, 290*
 Lignite coal cost, 290*
 Lignite coal for locomotives, 290*
 Lima Locomotive Corporation locomotive, 4-6-2 type, Erie, 1392*
 Lime, Mill for grinding, 330*
 Linn, P. C., Superheater locomotives, 416
 Link grinding machine, 198*
 Link Side Bearing Co., Car truck, 673*
 Link side bearing truck, 673*
 Linseed oil, Effect of pigments on the contents, 123*
 List, The authorized, by E. J. McVeigh, 304
 Lister, F. G., Air sander for interurban cars, 482*
 Loading hoist, Pneumatic, 85*

Locomotive.

Age, 1544
 Air pump, Compound, 104*
 Arch tubes, Tools for applying, 28*
 Associated Lines, Standard, 125*
 Atlantic type and a heavy train, 529
 Atlantic type, Possibilities of, by W. F. Kiesel, Jr., 11
 Bolic type, N. Y. of France, 190*
 Boiler design discussion by F. F. Gaines, 12
 Boiler, Device for preventing scale, 17*
 Boiler explosion, An early, 1411*
 Boiler inspection, Report of federal, 32
 Boiler, Service of Broton, 128*
 Boiler tests, Jacobs-Shupert, 63*

Locomotive (continued)

Boiler tube tools, by Walter R. Hedeman, 23*
 Boiler, Ill. Cent. 3-8-2 type, 362*
 Boiler, Lake Shore 3-8-2 type, 233*
 Boiler, P. & R. 4-4-2 (Imp.) type, 430*
 Boilers, Safety devices, 160*
 Boilers, Sealing, 295
 Boilers, Weak and unsafe condition of, 314
 Blower valve, C. & O., 314
 Brake equipment, Care of, paper at A. E. A. Convention, 477
 Brake rigging, P. & R., 412*
 Broad gage, Last, in England, 337*
 Cab deck, Shield for, 122*
 Cab furnishings, 241*
 Cab vestibule, Can. Pac., 1123, 1127*
 Cab window ventilator, 676
 Coaling station, Modern, 527*
 Connecting rods, by H. A. F. Campbell, 175*
 Counterbalance weight design, by C. E. Brown, 520*
 Cylinder cock, Automatic, 101*
 Cylinder repaired with concrete, C. & O., 131*
 Cylinders, Larger, 238*
 Cylinders, Ratio in Mallets, 2278, 2373
 Cylinders, Stumpy, 450*
 Deck shield, B. & O., 304*
 Design, Errors in, 18
 Diesel, 5783
 Dimensions, Tabular comparison, 73
 Drawbar, Laminated, Can. Pac., 2888*
 Drifting device, Operation and maintenance of, 643*
 Driving box, Brass liners for shoe and wedge fit, B. & O., 129
 Driving box lateral plate, 8*
 Driving box oil pipe for hub, 76*
 Driving box, Repairing, by M. D. Francy, 199*
 Driving box, Taking up lateral, 74*
 Driving boxes, by C. L. Dickert, 422
 Driving boxes, by W. H. Logan, 436*
 Driving wheel, New, 450*
 Duplicate parts for, 1280*
 Early and train, 324*
 Electric, 1128
 Electric 2400 v. direct current, 409*
 Electric, Experimental in France, 129
 Engineer, A remarkable career, 1413*
 Equipment, Condensed record, 527*
 Factors in the selection of, by O. S. Beyer, Jr., 9
 Feed water heaters discussion by G. K. Henderson, 13
 Fires, Killing, 536
 First Baldwin, 588*
 Fitted for a fire engine, 588*
 Fire door, Improved Franklin, 1264*
 Firebox, Broton, Service of, 1138, 128*
 Fireboxes, Autogenous welding on, 670*
 Firing practice, 297
 Frame brace, P. & R., 411*
 Frame, Lake Shore, 2-8-2 type, 234*
 Frame, Vanadium cast steel, Test of, 357
 Front end for burning grate, 290*
 Front end, Slater, 7*
 Fuel and water consumption curves, 68*
 Gage cock and cut-out valve, 1266*, 1300*
 German, 1267*
 Grate, Design, by W. R. Hedeman, 585*
 Grates, Best form of, 316
 Headlight equipment, Installing electric, 603*
 Headlight laws, Compilation of, 588
 Heating surface, Equivalent, 624
 Hot boxes, 2838
 Lubricator auxiliary valve, MacMain, 235*
 Lubricator, Improved, 57*
 Main rod repairs, by C. D. Ashmore, 29*
 Mellet, Distribution of power in, by Paul Weeks, 237*
 Nurturing, 509
 Nozzle, Rectangular, Cent. of Gae, 476*
 Number ordered in 1912, 38
 Operation and cost, Forms for, 124*
 Operation, by Johnson, 50
 Operation curves, by F. Pomeroy, 68*
 One hundredth anniversary of, 380*
 Painting, Economy in, 541
 Passenger, Largest, in Europe, 190*
 Pipe clamp, 2308
 Practice, Modern, 2308
 Progress, 13448
 Ratios, Tabular comparison of, 18, 19, 72, 73
 Reverse gear, Power, 627*
 Reverse gear, Screw and lever, P. & R., 481*
 Rod brass, Improved, C. & N. W., 102*
 Rods, Comparison between American and European, 181*
 Rods, Designing, by H. A. F. Campbell, 175*
 Rod, Service of Vanadium, 648
 Safety valves, Location of, gates in, 533*
 ting, 533*
 Screw reverse gear, P. & R., 412*
 Selection of, 38
 Shoes and wedges, Laying off, Can. Pac., 307*

Locomotive—(continued)

Shoes and wedges, Planing, C. & O., 32*
 Smoke abatement devices test, 236*
 Springs, Machine for testing, P. & R., 159*
 Springs, Replacing driving, 11
 Standard, Discussion by H. H. Vaughan, 11
 Starting fires, The Associated Lines, 718
 Steam and electric, 694*
 Stoker, Gee, 1118
 Stoker, Hervey, 303*
 Stoker, Shulz, 621*, 1399*
 Sulzer-Diesel, 241*
 Superheated steam, Advantages of, discussion by C. D. Young, 15*
 Superheater, and feed water heater, Larz, 71*
 Superheater discussion by S. Hoffman, 13
 Superheater flues, Tools for applying, 27*
 Superheater, Operating, paper at T. E. A. convention, 467
 Superheater, paper at General Foremen's convention, 416
 Superheater, report at M. M. convention, 1373
 Superheater, Young, 675*
 Tabular comparison of 4-4-2, 4-6-0, 2-6-0 and switching types, 19
 Tabular comparison of 4-8-2, 4-6-2, and 2-6-2 types, 18
 Tabular comparison, 2-10-2, simple freight, Mallet type, 73
 Tender truck, Six-wheel, Santa Fe, 526*
 Tender truck, Swing motion, Commonwealth, 307*
 Tender without underframe, Can. Pac., 120
 Terminal, Ill. Cent. Central, 353*
 Testing plant, Purdue, 1718, 1348, 1350
 Tests of superheater, Report at M. M. convention, 1384*
 Tests, Pennsylvania class E-6's, 1372*
 Three cylinder, 15698
 Throttle lever rigging, Improved, 331*
 Tire heater, 309*
 Tires, Service of Canadian, Tests of, 15*
 Tires, Specifications for Chrome-Vanadium, 16*
 Tool equipment, 5778
 Tractive effort, 436*
 Trailer truck, New design, 74*
 Truck tire turning test, 466*
 Valve gear, 1698
 Valve gear driven from crosshead, 215*
 Valve gear, Formula for saddle pin offset, 647*
 Valve gear, Gages for parts of Walschaert, 669*
 Valve setting and cylinder ratios in Mallets, 237*
 Water gage, Babcock safety, 333*
 Water glass, Improved Klingner, 1290*
 Water glass shield, Delco, 333*
 Water glass shield, Lake Shore, 333*
 Water joint, Franklin, 1400*
 Watering in the engine house, 2848
 Wheel loads, Dynamic, discussion by A. W. Gibbs, 12
 0-6-0 type, Illinois Central, Gaines fire-box, 362*
 2-6-0 type, Associated Lines, 6*
 2-8-0 type, Wheeling & Lake Erie, 641*
 2-8-2 type, Associated Lines, 6*
 2-8-2 type, Comparison of recent, 233*
 2-8-2 type, Grand Trunk, 1359*
 2-8-2 type, Illinois Central, Gaines fire-box, 362*
 2-8-2 type, Lake Shore, 231*
 F. 8-2 type, Lehigh Valley, 1408*
 2-8-2 type, Northern Railway, 411*
 2-8-2 type, Santa Fe, 479*
 4-4-2 type, P. & R., 479*
 4-6-2 type, Associated Lines, 5*
 4-6-2 type, C. & N. W., 1390*
 4-6-2 type, D. I. & V., 1392*
 4-6-2 type, Erie, 1392*
 4-6-2 type, New Haven, 1293*
 4-6-2 type, Santa Fe, 525*
 4-6-2 type, Northern Railway, 411*
 4-8-2 type, Missouri Pacific, 583*
 Lodge & Shipley Machine Tool Co., Lathé, Logan, G. H., Paper on driving boxes, 420*
 Louisville & Nashville, Air brake apparatus, Grinding pistons, rings, 132*
 Louisville & Nashville, Air pump steam head repairs, 605*
 Louisville & Nashville, Mirror for inspecting trucks, 96*
 Lubricator auxiliary valve, MacMain, 235*
 Lubricator choke plugs, Wrench for removing, 371*
 Lubricator, Force feed, McCord, 1267*
 Lubricator, Force feed, Ingersoll, 157*
 Lumber, Moisture determination, Canadian Pacific, 653*
 Lumber shed, 307*
 Lutz-Whester Engineering Co., Wrench, 1503*
 Lyndon, G. W., Car wheel failures, 329*

Page numbers under 1,000 refer to Railway Age Gazette, Mechanical Edition; those over 1,000 refer to the Daily Railway Age Gazette. * Illustrated article; † editorial; ‡ short non-illustrated article or note; † communication.

M

MacBain, D. R., Address at T. E. A. convention 476
 MacBain auxiliary lubricator valve 235*
 Macedonia, Railway accident in 395†
 Machine for drilling tell-tale holes in stay-bolts 252*

Machine Tools.

Arrangement at Burnside shops 194*
 Basis for computing 114‡
 Boring, drilling and milling machine, Fosdick 563*
 Boring machine for car brasses, C. & N. W. 266*
 Boring machine, Double, for journals, Bement 396*
 Boring machine, Horizontal, Pawling & Harmselmeget 99*
 Combination machine, Quadruple, Wiener 452*
 Drill, Mud ring and flue sheet, Footen-Birt 619*
 Drill, Radial, American Tool Works Co. 1264*
 Drill, Radial, high capacity, Fosdick 619*
 Drill, Radial, high duty, Bausch 511*
 Drill, Radial, high duty, Dresser 1300*
 Exhibit 1403‡
 Feeds, cuts, speed, metal removed, etc., table 248*
 Forging machine, Heavy, National 566*
 Forging press, Chambersburg 330*
 Gearing 1404‡
 Grinder, Double spindle, Besly 628*
 Grinder for sharpening curved tooth files, Vixen 376*
 Grinder, Oilstone 293*
 Grinding for links 198*
 Grinding machine, Universal, Morse 1402*
 Grinding machine, with crane, Mummert-Dixon 1267*
 Grinding machine with crane, Mummert-Dixon 393*
 Guard (see also Guards) 137*
 Guards, C. & N. W. 137*
 Journal bearing for machine, Duplex, Detrick & Harvey 566*
 Lathe capacity, Basis for measuring 133*
 Lathe, driving wheel, New model, Niles 336*
 Lathe, flat turret, Acme 677*
 Lathe, heavy engine, Cincinnati 272*
 Lathe, improved, Lodge & Shipley 1301*
 Lathe, geared head, Reed 1366*
 Lathe, 12 speed geared head, American Tool Works Co. 1398*
 List of, at locomotive terminal, Centralia 355*
 Milling machine, double head, Henderley 1422*
 Milling machine, geared universal, Henderley 1302*
 Milling machine, heavy, Kempsmith 217*
 Milling machine tests, English 48*
 Milling machine for links, Newton 46*
 Motor drive, Reversing for planers, Gen. Elect. 46*
 Motor for shop service, Westinghouse 159*
 Nut tapper, semi-automatic, National 248*
 Operation diagram, by L. K. Portroy 1265*
 Planer, Heavy service crank, Cincinnati Planer drive reversing motor, Triumph Planers, Reversing motor drive, Gen. Elect. 46*
 Saw, Boyer pneumatic 519*
 Saw, Cold metal, Lea-Courtney 1367*
 Saw, Cut-off, Lea 1421*
 Shaper, Back gear, Cincinnati 1470*
 Shaper for driving boxes, Newton 100*
 Shaper, Heavy service, Gould & Eberhardt 1365*
 Shaper, Heavy duty back gear, Stockbridge 338*
 Shear and riveter for coupler yokes, Underpowered 408‡
 Vertical turret lathe, Speed change mechanism on 1497*
 Madden, T. P., Care of superheater tubes 350†
 Madras, Transportation in 350†
 Mahr Manufacturing Co., Oil burner, 624* 1522
 Main rods (see Rods and Locomotive rods)
 Mandrel for sectional tube expanders 271*
 Manual for firing practice 293
 Mark Manufacturing Co., Cold drawn union steel 337*
 Markel, Chas., Repairing injectors 243
 Martin, C. W., Location of steam heat traps 328*
 Marvin, C. O., Fire boring 335*
 Master Blacksmiths' Association assistance of M. M. Association 1471‡

Master Blacksmiths' Association Convention.
 (Reports and discussion.)
 Case hardening 491*
 Cast steel in the blacksmith shop 492
 Drop forging 487
 Efficiency 493
 Election of officers 494

Master Blacksmith's Association Convention—(continued)

Electric welding 486*
 Flue welding 485*
 Hammer crane shock absorber 493*
 Heat treatment of metals 492
 Notes on the convention 464‡
 Oxy-acetylene welding and cutting 490*
 Piece work 490
 Spring making and repairing 488*
 Tools and formers 486*
 Truck transoms for passenger coaches 487*
 Master Boiler Makers' Association (see Boiler Makers' Association and Meetings)

Master Car Builders' Association Convention.

(Reports and discussion.)
 Abuse of the repair card 1461
 Address of President Fuller 1430
 Air brake hose specifications 1509*
 Brake shoe and brake equipment 1437
 Capacity marking of freight cars 1490
 Car construction 1480*
 Car trucks 1480*
 Car wheels 1447*
 Coupler and draft equipment 1438*
 Loading to freight equipment by unloading machines 1507*
 Ejection of officers 1518
 Freight car repair bills 1460
 Letter ballot, Result of 615
 Letting cars 1477
 Overhead inspection of box cars 1477
 Prices for labor and material 1459
 Repair card abuse 1489
 Reamant of 20 and 25 ton cars from interchange 1487
 Revision of form of present specifications 1512
 Revision of the rules of interchange 1451
 Revision of standards and recommended practice 1432
 Rules for loading material 1475*
 Safety appliances 1475*
 Specifications for freight car bolsters and bolsters 1486
 Tank cars 1486
 Train brake and signal equipment 1435*
 Train lighting 1459*
 Train pipe connection steam heat 1484*
 Master mechanic's duties 70

Master Mechanics' Association Convention

(Reports and discussion.)
 Committees for 1913 1259
 Election of officers for 1914 1390
 Electric equipment maintenance 1491
 H. Quercau 1347*
 Locomotive testing plant, by E. C. Schmidt 1350*
 Main and side rods 1355
 Maintenance of locomotive boilers 1351*
 Mechanical stokers 1285
 Minimum requirements for locomotive headlights 1256
 Electric equipment maintenance 1281*
 Program of convention 1249
 Result of letter ballot 588
 Revision of standards 1291
 Smoke prevention 1377*
 Special alloys and heat treated steel in locomotive construction 1376
 Specifications for locomotive cast steel frames 1347
 Specifications for materials used in locomotive construction 1372
 Steel tires 1356*
 Subjects 1356
 Superheater coverings 1373
 Test of superheater locomotives by C. H. Benjamin and L. E. Endsley 1384*
 Three-cylinder locomotives, by J. Snow Bell 1374
 Hoses, engine and tender 1381*
 Master Painters' Association (see Painters' Association and Meetings)
 McConway & Torley Co., Freight coupler 1422*
 McCord & Co., Draft gear, lever type 1529*
 McCord & Co., Force feed lubricator 1377*
 McCord & Co., Journal box with steel inserts 1499*
 McCord & Co., Locked journal box lid 1525*
 McCord & Co., Pinless journal box lid 1522*
 McCord & Co., Swivel drawbar yoke 1402*
 McCord Mfg. Co., Universal weather stripping 1501*
 McGe, W. A., Shop kinks 85*, 309*
 McGe, W. A., The author's list 304
 Mechanical associations—Co-operation between 1278‡
 Mechanical department appointments 111‡
 Mechanical engineer, The 28‡
 Mechanical stokers 1278‡, 1285

Meetings

American Electric Railway Association 571
 American Museum of Safety 680
 American Railway Tool Foremen's Association 399
 American Railway Union 629
 American Society of Mechanical Engineers 50, 162, 221, 571, 629
 Air Brake Association 277
 Canadian Railway Union 341
 Car Foremen's Association of Chicago 629
 Central Railroad Club 106, 221
 Federation of Trade Press Associations 518
 General Foremen's Association 50, 161, 221, 341
 Illuminating Engineering Society convention 341
 International Engineering Congress 400
 Master Boiler Makers' Association 277
 Master Car and Locomotive Painters' Association 277
 New England Railroad Club 106, 162, 277, 399
 New York Railroad Club 50, 166, 221, 341
 Northern Railway Club 106, 162, 221, 341
 Pennsylvania Industrial Efficiency Convention 571
 Railway Business Association 50, 629
 Railway Club of Pittsburgh 572
 Railway Fire Protection Association 106
 Railway Fuel Association 161, 277
 Railway Storekeepers' Association 51, 277
 Railway Supply Manufacturers' Association 106
 Traveling Engineers' Association 341
 Western Canada Railway Club 277
 Western Railway Club 50
 Metallic connectors, flexible, Greenlaw 1501*
 Metz, August, Fire cutting dies 433
 Mill for grinding lime 339†
 Milling machine (see Machine tools)
 Minnesota rate case decision 1248‡
 Missouri, Kansas & Texas, Paint shop at Sedalia 483*
 Missouri, Kansas & Texas, Shop kinks 81*
 Missouri Pacific, Locomotive, 4-8-2 type 583*
 Monarch Steel Castings Co., Coupler 1503*
 Motor awakening in supply business 1403‡
 Morey, E. H., Rabbiting car journal brasses 267*
 Morey, E. H., Truck wheel tire turning test 466†
 Morey, E. H., Turning driving wheel tires 173†
 Motor cars, False economy in drafting 361*
 Morrison, C. J., Underpowered machine tools 408†
 Morse Twist Drill & Machine Co., Universal grinding machine 1402*
 Morton, Robert W., Oil and grease cups for rods 366*
 Motor buses in London 456†
 Motor car service in Bavaria 53†
 Motor cars, by Dudd and Arnold 324*
 Motor cars, Gen. Elect. operation 328*
 Motor for shop service, Westinghouse 159*
 Motor, Reversing, for planer drive, Gen. Elect. 46*
 Motor, Reversing, for planer drive, Triumph 269*
 Motor, Single-phase, Westinghouse 1521
 Motors, Application to tools at Burnside 196*
 Mounce, R. S., Mechanical department organization, Erie 645*
 Mounce, R. S., Special 7 1/2 ton flat car 388*
 Moving pictures in railway educational work 57‡, 67, 174†
 Mudge & Co., Car window air intake 564*
 Murrell, C. W., Grinder 273*
 Mummert-Dixon Co., Crane-grinder 393*
 Murphy X L A. roof on Frisco box cars 556*
 Murray, E. A., Kindling locomotive fires 536
 Murray, E. A., Tire turning record 62†
 Murray, E. A., Turning driving wheel tires 640†
 Myriawatt, Standardization of the 190

N

Nagle, John H., Receptacle for waste drinking cups 561*
 Narrow gauge locomotives, Central South African Railway 20*
 Nashville, Chattanooga & St. Louis, Boiler shop kinks 142*
 Natal, Flood damage in 397†
 Nathan Mfg. Co., Cut-off valve for water gages 1266*
 Nathan Mfg. Co., Gage cock 1300*
 Nathan Mfg. Co., Lubricator for air cylinder 1368*
 National Oil Gas Generator Co., Generator 1529*
 National Machinery Co., Forging machine 566*
 National Machinery Co., Semi-automatic nut tapper 45*
 National Machinery Co., Valve for water release rigging 678*
 Netherlands railway improvements 206†
 New England Railroad Club (see Meetings)
 New York Central & Hudson River, Steam box car end 40*
 New York Central & Hudson River, Traveling safety exhibit 405‡
 New York Central Lines, Record of locomotive equipment 527*

Page numbers under 1,000 refer to *Railway Age Gazette*, *Mechanical Edition*; those over 1,000 refer to the *Daily Railway Age Gazette*. * Illustrated article; ‡ editorial; † short non-illustrated article or note; ‡ communication.

New York Central Lines, Steel passenger cars, P. R. R. 589*

New York, New Haven & Hartford, Indirect car lighting 395*

New York, New Haven & Hartford, Traffic through Harlem river yard. 516†

New York Railroad Club (see Meetings).

New York State Department of Labor, Specifications for exhaust systems. 305

Newman, C. M., Boiler 606*

Newman, C. M., Paper on driving boxes. 422

Newton Machine Tool Works, Locomotive link milling machine 46*

Newton Machine Tool Works, Shaper for driving boxes 100*

Niagara Frontier Car Inspection Association, Damage to cars by improper loading Nickel-Chrome Chilled Car Wheel Co., Car wheels 1529

Niles-Bement-Pond, Boring machine, Double journal bearing 396*

Niles-Bement-Pond, Driving wheel lathe. 336*

Norfolk Southern, Box car construction and repair men 255

Norfolk & Western, Bronze liners for cross-heads 428*

Norfolk & Western, Car repair yard 442*

Norfolk & Western, Forms for locomotive operation and cost 124*

Norfolk & Western, Firing up locomotives. 64-3

Norfolk & Western, Hammer for removing side rod bushings 484*

Norfolk & Western, 90 ton gondola car. 28, 35*

Norfolk Railway Club (see Meetings).

Northern Railway of France, 4-6-4 type locomotive 190*

Northern New York Central, Paper on 345†

Nowell, H. T., Eccentric blade bender. 306*

Nowell, H. T., Machine shop kinks. 595*

Nowel, H. T., Turning four-bar crosshead wrist pins 192*

Nut, Dieter safety 1302*

Nut tapper, Semi-automatic, National. 45*

O

Oil burner for car equipment, N. & W. 443

Oil burner, Mahr 624*

Oil cups, Welding on rod straps. 253*

Oil fuel in Austria 799

Oil and grease cups for rods. 366*

Oil house, Standard, Paper at Storekeepers' convention 310

Olsen, Tinius, & Co., Testing machines for P. R. R. 159*

Operating department and fuel economy, Paper at T. E. A. convention. 469

Operation, Improvements in 112‡

Operators, Selection for oxy-acetylene welding, by J. C. Reid. 243

Ore shipment on the Great Lakes. 409†

Organization of engine houses. 597*

Organization, Mechanical department, Erie, Wis. 638

Osmer, J. E., Improved rod brass. 102*

Oven for baking paint on steel passenger cars, P. R. R. 245*

Overhead inspection of freight cars. 1471*

Owner's defects, Extension of list. 1471‡

Oxy-acetylene welding and cutting, Paper at Blacksmiths' convention 490*

Oxy-acetylene welding, Selection of operators for 243

Oxygen generators 1400

Oxygen and illuminating gas, Welding and cutting with 452*

P

Packing, Grapho-metal 160*

Packing, Metallic, for rod 565*

Packing rings, Gang tool for cutting, Cent. of Ga. 73*

Paint baked on steel passenger cars, P. R. R. Paint brushes for steel equipment, Paper at Painters' convention 242*

Paint, Effect of pigments on linseed oil. 188*

Paint, Rust inhibitive, Paper at Painters' convention 541

Paint on rusted surfaces. 627†

Paint shop at Sedalia, M. K. & T. 483*

Paint shop supplies, Paper at Painters' convention 545

Paint, Test of 188*

Painters' Association Convention.

(Reports and Discussions.)

Economy in locomotive painting. 541

Election of officers. 545

Enameled interior trimmings. 544

Finishing steel passenger cars. 539

Maintenance of passenger cars. 545

Notes on convention. 520‡

Paint brushes for steel equipment. 542

Paint protection for steel equipment. 544

President's address 539

Railway paint shop supplies. 541

Rust inhibitive paint. 545

Safety first 543

Painting steel passenger cars, by C. D. Young 245*

Pan for handling material, B. & O. 21*

Paraguay, Proposed line for 569†

Parcels record. 212†

Parish, Le Grand, Advantages of brick arch Park, W. L., Address at Boiler Makers' convention 314

Park, W. L., Address at T. E. A. convention 477

Park, W. L., Railroads and the college man 640‡

Parks, M. K., Proportions of refrigerator 613

Parsons, H. E., Tank car design. 1266*

Parsons, H. E., Tank car design. 445*

Parsons, H. E., Truck equalizer design. 408*

Patent applications 804*

Fatton, F. O., Use of sand on locomotives. 39†

Pawling & Harnischfeger, Boring machine. 99*

Peabody, F. S., Address at Fuel convention 289

Peabody, R. E., Apprentice instruction. 313*

Pedestal bender holder, Cent. of Ga. 538*

Pedrick Tool & Machine Co., Portable turning machine 569*

Penalties under Federal laws. 242†

Penn freight car coupler. 1422*

Pennsylvania, Car, Train lighting instruction 655*

Pennsylvania, Efficiency tests on 682†

Pennsylvania Industrial Welfare Efficiency convention 571

Pennsylvania Railroad, Atlantic type locomotive and a heavy train. 529

Pennsylvania Railroad, Automobile car, steel frame 1492*

Pennsylvania Railroad, Fires 204†

Pennsylvania Railroad, Gee locomotive stoker 155*

Pennsylvania Railroad, Oven for baking paint on passenger cars 245*

Pennsylvania Railroad, Painting steel passenger cars 245*

Pennsylvania Railroad, Rivet heater, Portable 256*

Pennsylvania Railroad, Testing equipment. 159*

Pensioners, Number on P. R. R. 236†

Perritt, J. F., Smith shop tools. 191†

Personals (General).

(Above grade of Master Mechanic.)

Barclay, Frank B. 342

Barratt, M. K. 342*

Bell, Robert W. 342

Bentley, H. T. 630*

Brewer, J. W. G. 342

Brown, F. S. 458

Brown, H. B. 458

Carpenter, J. H. 107

Chenoweth, E. G. 400*

Chilley, Jos. 163

Comp., J. E. 681

Cook, J. S. (obituary) 574*

Crownover, G. M. 515, 572*

Crozier, Andrew S. (obituary). 1407

Dalzell, E. E. 91

Dickerson, S. K. 163

Dunlop, P. T. 458

Enright, J. F. 638*

Ensign, J. E. (obituary) 278

Fiedler, Max 278

Freeman, Lewis D. 51

Freyl, W. J. 681

Funk, G. 681

Gardner, H. W. 242

Gardner, J. E. 242

Garstang, William 163*

Goodwin, G. S. 400

Graham, J. F. 458

Hammond, G. O. 107, 342

Hawkins, W. P. 458

Hine, Major Charles 630

Hinton, H. V. 630

Hooker, Fred 278

Horton, B. G. 278

Hull, George A. 572

Hyndman, F. T. 400

Jacks, H. B. 638*

Johann, Jacob (obituary). 163

Jones, L. B. 682

Kellogg, W. L. 107

Kellogg, W. L. (obituary). 51, 91

Kramer, J. E. (obituary). 1519

Krutschmitt, John 681

Ladley, W. E. 52

Langley, J. T. 458

Langs, D. E. 52

Lille, G. W. 400, 458, 52

MacMillan, D. A. 401

McCarthy, M. J. 107

McCormick, Geo. 163, 322

McKee, G. S. 501

McQuillen, J. E. 515

McRoberts, G. (obituary). 459

Merzheimer, Fred 630

Milner, B. R. 459

Mitchell, W. N. 401, 458

Montgomery, Hugh 515

Murray, W. 345

Nash, Joseph H. 459

Newhall, D. S. (obituary). 459

O'Brien, J. E. 631

Personals—General (continued)

Osborne, H. J. 458

Osmer, J. E. 107

Oviatt, H. C. 342

Park, E. A. 278

Payne, B. T. 107

Perry, G. E. 52

Prendergast, A. P. 107

Prendergast, R. O. 455

Quayle, Robert 631*

Richardson, L. A. 222

Ridgway, H. W., Denver, Col. 163

Robb, George W. 572

Schmitt, G. A. 278

Schlagle, Wm. 1409*

Scribner, W. H. 458

Seidel, G. W. 222

Seley, C. A. 278

Smith, J. O. 163, 222

Stewart, C. J. 572

Summerskill, T. A. 163

Symons, W. E. 52

Taylor, C. M. 222, 574

Tetfeller, O. 278

Thompson, Geo. 401

Chase, J. W. 107, 401†

Tortlerott, W. J. 574

Turner, W. B. (obituary). 278

Underwood, T. F. 574

Van Buskirk, H. C. 107, 515

Warwick, H. R. 52

Waters, J. H. 52, 515

Wildin, G. W. 342

Personals

(Master Mechanics and Road Foremen of Engines.)

Adams, A. B. 515

Akans, E. L. 631

Alling, B. W. 572

Anderson, W. E. 163

Appleton, W. F. 681

Armstrong, A. G. 458

Barker, J. A. 107

Barnes, W. E. 631

Basford, John 273

Beardsley, W. F. 342

Bedel, W. A. 342

Benizies, John 107

Bettenberg, N. C. 163

Bird, H. 342

Borbridge, W. 342

Bowden, J. F. 342

Lloyd, Frank 164

Breisch, O. 342

Burke, J. M. 342

Burnett, R. W. 1520*

Butler, W. S. 515

Byers, R. F. 681

Castro, H. G. 631

Chase, F. T. 107, 64

Connolly, F. E. 52

Cope, E. 164

Cosart, Frank 682

Crew, A. L. 342

Cross, D. W. 52

Cullum, J. W. 342

Cunningham, J. L. 459, 515*

Curley, W. A. 342

Daily, C. B. 572

Daley, J. H. 631

Davis, J. M. 164

Dempster, Gilbert 631

Dewey, Foster 515

Dougherty, J. H. 342

Dyer, W. H. 631

Evans, W. H. 164

Fitzimons, J. E. 164

Flavin, J. T. 459

Flavin, J. T. 459

Foster, H. L. 164

Foster, O. M. 164

Fowler, J. E. 515

Frank, J. 631

French, W. J. 631

French, T. L. 164

Fuller, G. E. 107

Gibbs, J. W. 631, 681*

Grenier, J. R. 278

Grewe, H. F. 682

Griffith, Henry 342

Greening, W. 459

Hackett, E. W. 682

Hale, A. E. 632

Hanchett, S. F. 459

Harris, E. J. 107

Hartel, D. 632

Hayes, H. B. 682

Hayman, C. C. 515

Hennessey, T. W. 632

Hodapp, R. 632

Hoffman, O. A. 630

Hopkins, David 401

Hopper, Frank 515

Huckett, G. O. 278

Hussey, F. A. 278

Hyle, R. C. 164

Ingling, J. E. 279

Page numbers under 1,000 refer to Railway Age Gazette, Mechanical Edition; those over 1,000 refer to the Daily Railway Age Gazette. * Illustrated article; † editorial; ‡ short non-illustrated article or note; † communication.

Personals—Master Mechanics and Road Foremen of Engines—(continued)

English, H. O.	52
Holerson, Mark	632
Johnson, Frans	632
Judy, Fred	632
Khntz, G. J.	632
Kottke, C. A.	515
Kulu, B. F.	164
Kung, J.	279
Loyce, W. T.	459
Love, J. C.	107
McAmny, J. F.	107
McAbe, J.	342, 573
McCarthy, C. A.	632
McAuley, J.	52
McDonmid, L. J.	279
McGraw, Michael	52
McIlvane, C. D.	515
McKenzie, H. D.	632
McLeod, T. R.	279
Mackenzie, H. D.	681*
Mackery, M. L.	279
Malison, A.	52
Maxfield, W. L.	682
Mischeck, L. L.	632
Mored, H. S.	632
Moffatt, F. J.	52, 632
Moriarty, G.	573, 641
Mullen, T. E.	682
Nelson, F. W.	343, 573, 632
Novinger, G.	107
O'Connor, W. J.	52
O'Neill, W. J.	632
Patterson, S. D.	107
Patterson, S. T.	52
Prendergast, R. O.	164, 573
Ramsey, Ralph	52, 164
Randall, J. B.	52, 279
Reagan, M. E.	52, 279
Records, J. W.	343, 573
Reid, C. H.	233
Rhodes, J. C.	343
Rhuark, F. W.	343
Ridley, W. J.	343
Roach, J. B.	343
Robb, G. W.	107
Robbins, F. S.	459
Ross, David	516
Ross, W. P.	632
Sealy, William C.	459
Schaefer, Hugo	52
Schraag, C. F.	52
Schultz, E.	107
Scott, J. W.	632
Sharpe, H. W.	632
Smith, J. L.	459
Stephens, H. H.	52
Stewart, J. B.	233
Stewart, R. L.	343
Stewart, T. R.	343
Stone, G. M.	632
Sweetman, E. M.	632, 681*
Sweney, D. R.	632
Tasker, W. S.	343
Tate, K.	632
Tierney, J. R.	107
Trussell, S. G.	52
Underwood, T. S.	223
Vickers, T. M.	343
Wallace, R. E.	52
Watters, J. H.	573*
Whalen, J. M.	343
Wheatley, B. J.	52
Whiteley, G. W.	223
Whitman, Harry	632
Wilkie, Charles	459
Williams, F. W.	52
Wood, R. E.	164
Yeaton, C. S.	52

Personals—Car Department—(continued.)

Martin, T.	343
McDonald, A. B.	682
McMullen, John	53
Miller, William	459
Milton, J. H.	164
Osborne, H. N.	343
Otto, John	279
Patterson, W. E.	343
Piggott, S. J.	573
Reed, James	279
Ross, D. C.	164
Rowe, J. C.	573
Schulze, J. W.	632
Senger, J. W.	53
Simpson, C. S.	632
Suart, G. E.	343
Smith, W. K.	343
Staley, R. H.	164
Taylor, C. H.	459
Thomas, J. H.	573
Thomson, Geo.	459, 573
Trantman, Avian	573
Watrous, F. C.	573
Weiler, G. S.	632
White, H. J.	343
Wilcox, E. M.	632
Wood, George D.	574

Personals—Shop and Engine House—(continued)

Kirkpatrick, J.	344*
Krueger, A. G.	682
Laking, T. G.	634
Lee, Bernard	53
Lee, S. H.	682
Lee, W. H.	53
Leverage, J. R.	516
Lightfoot, S. S.	346
Linthicum, P. S.	459
Little, A. H.	108
Logan, S.	459
Lowe, E. G.	165
Mahan, A. H.	574
McArthur, A.	108
McDowell, John	53
McElvy, G. B.	165
McGraw, M. J.	53
McMahon, E. J.	108, 108
McHerson, R.	108
McFavish, A.	402
Meadway, W. F.	53
Miller, John L.	516
Minnick, H. B.	223
Moline, Frank	165
Monroe, A. L.	108
Montgomery, R. H.	223
Moore, J. P.	401
Morton, J. H.	165
Morton, W. O.	223
Mullins, S. W.	223
Murphy, C.	279
Musgrove, J. H.	344*
Myers, H. E.	53
Nauney, T. H.	53
Newmarch, I. C.	223
Nyer, L.	165
O'Leary, M. A.	53
Parker, H. H.	342
Paul, W. J.	634
Peach, J. P.	108
Penketh, S. C.	53
Perry, C.	108
Prewitt, H. A.	516
Rauch, H. S.	279
Ray, J. M.	108
Reich, J. H.	682
Reid, W. G.	223
Renix, W. C.	108
Rhinhardt, C.	682
Robling, R. P.	682
Ringler, D. L.	53
Roberts, A. J.	402, 574
Rosser, H. S.	402
Sargent, M. E.	402
Scanlon, J. C.	632
Schorrdorfer, F. S.	402
Scott, W. W.	459
Shaffer, F. B.	53
Shank, C. L.	574
Sheppard, E. S.	108
Short, A. T.	223
Stewart, S.	165
Studer, F. A.	165
Stull, F. J.	165
Suhl, J.	279
Sullivan, D. J.	459
Trow, W. L.	344
Turton, H. L.	344
Urban, Wm.	223
Van Vahn, H. D.	108
Walther, H.	108
Warecup, C. W.	223, 279
Whitebread, E. E.	402
Whiteford, J. E.	279
Wheeler, W. E.	516
Williams, E. V.	53
Working, Harry	53
Yeager, W. W.	574

Personals—Shop and Engine House

Acker, J. W.	401
Alexander, J.	53
Aney, Al. E.	343, 401
Anderson, J. J.	682
Arbuckle, J. H.	682
Baird, A. M.	682
Baker, C.	53, 223
Bennett, A. E.	53, 343
Beyer, O. S., Jr.	459
Boertman, Chas.	682
Bodine, L. E.	459
Bonestell, J. C.	401
Bouth, Thos.	459
Brooks, C. E.	574
Brumbach, R. F.	164
Bruner, J.	401
Carmy, C.	632
Chase, M. L.	107
Chenoweth, W. B.	53
Clark, A. W.	223
Clark, F. E.	459
Clark, J. H.	574
Coe, T. W.	632
Cole, J. C.	343
Colley, C. C.	343*
Coniff, P.	53
Conley, B.	164
Cooke, W. L.	164
Costella, P. J.	107
Crawford, M. L.	223
Cruise, J. L.	344
Crawell, W. C.	344
Darling, H.	164
Davis, A. F.	164
DeLacey, M. J.	344, 401
Denue, Geo. T.	516
Dibble, Oscar C.	107
Donohue, P. J.	344
Dorr, H. G.	279
Douval, J. C.	108
Drury, C. J.	223
Duifer, J. L.	682
Dumphy, John	107
Earl, W. R.	108
Echle, F. J.	632
Falkenstein, Coburn	164
Fenstermaker, I.	223
Fitzsimmons, I. F.	279
Flickwir, J. W.	459
Flinn, R. H.	574
Fraudenmeyer, W. J.	459
Frey, C. N.	53
Frye, J. C.	682
Gaffney, T. P.	108
Gilleland, J.	165, 516
Gilley, C. H.	223
Goodwin, W. E.	516
Gordon, Thomas	223
Graham, Jos.	632
Grant, Hugh	108
Guntler, M. J.	164
Hahn, L. H.	279
Haller, J. L.	344
Hammann, P. C.	53
Hardesty, F. H.	574
Hartwell, F. S.	279
Hatsel, B. E.	574
Hay, D. W.	401
Henry, C. A.	53
Hilfrink, G. J.	516
Hitch, C. B.	344
Hitchens, H.	516
Hoff, Geo. F.	574
Howard, W. F.	574
Hunt, H. W.	459
Irves, T.	632
Jacoby, E. P.	682
Keininger, William	53
Kennedy, E.	53

Personals—Car Department

Acker, Joseph	401
Allison, A. A.	632
Alquist, W. A.	107
Alquist, P.	343*
Bannon, R. J.	573
Beshler, E. L.	223
Buss, Charles	573
Copony, A.	573
Corp, F. C.	682
Cosgrave, P. H.	516
Cousley, W. T.	164
Cupp, J. L.	459
Deane, J.	164
Downing, J. S.	459
Ellis, W. M.	52
Fleming, J. W.	52
Galarneau, P. D.	164
Hallett, W. J.	343, 401*
Hanson, F. H.	682
Herbster, Albert	573
Hodgson, John L.	401
Hull, G. A.	343
Jackson, J. S.	223
Jay, A. R.	573
Kendall, T. W.	573
Lenzner, Samuel	52
Lewis, Van R.	53
Maddox, C. W.	53

Personals—Purchasing and Storekeeping

Alexander, G. W.	516
Anthony, C. C.	402
Beggs, J. H.	108
Bennett, J. L.	165, 516
Bassnell, F. A.	516
Cain, D. G.	223
Clifford, E. A.	682
Cornors, F. E.	682
Cook, H. G.	459
Cooper, W. E.	223
Daley, E. B.	574
Downing, D.	574
Goodchild, A. A.	459
Hall, U. K.	516
Krings, G. H.	165
Killian, J. M.	633
Lowie, T. J.	165
McCool, A. E.	223
McWhorter, G. E.	516
Mahaney, J. E.	108
Mahl, F. W.	165
Main, A. C.	574
Marshall, I. F.	459
Mays, F. K.	516
Moodie, D. E.	459
Morris, H. W.	165
Mueller, J. R.	108

Page numbers under 1,000 refer to Railway Age Gazette, Mechanical Edition; those over 1,000 refer to the Daily Railway Age Gazette. * Illustrated article; † editorial; ‡ short non-illustrated article or note; † communication.

Personals—Purchasing and Storekeeping—(continued)

Pearce, H. C. 459
 Phelps, W. G. 53
 Forcher, Samuel 459
 Harlock, W. 574
 Rice, N. M. 682
 Rotureau, B. H. 516
 Shope, W. R. 633
 Simpson, R. W. 574
 Snyder, J. C. 163
 Spratt, Thomas 516
 Stokes, W. D. 574
 Turner, F. C. 682
 Waldron, N. A. 643
 Wood, L. B. 108
 Woods, R. O. 459
 Peterson, Fred, Superheater tools and their care 432
 Philadelphia & Reading, car, steel under-bearing 1502*
 Philadelphia & Reading, car, steel under-frame box 211*
 Philadelphia & Reading, locomotive 2-8-2 type 411*
 Philadelphia & Reading, locomotive, inspection 4-2 type 479*
 Philadelphia & Reading, manufacture of brake beam hangers 368*
 Pickard, F. C., president's address 415
 Piece work, paper at Blacksmiths' Convention 490
 Pigments, Effect of on castings of lined oil 188*
 Pilcher, John A., Six-wheel truck A. S. M. 239
 Pipe clamp, Ayers 234*
 Pipe threading, stationary die head for, Lands 626*
 Pipe union, Mark odd diameter steel 437*
 Pit jack, hydraulic, Watson-Stillman 1263*
 Pittsburgh & Lake Erie, gas-electric car 143*
 Pittsburgh & Lake Erie, portable rivet forge 33*
 Piston rings, Air brake apparatus 132*
 Piston rod packing, Detroit 563*
 Piston valve bushings, Pressing in, by V. T. Kropidowski 244*
 Planer attachment, Radius, Frisco 373*
 Planer tool head, Frisco 537*
 Planer (see Machine tools).
 Plating metal by deposition 530†
 Pless, Paul, Scrapping boilers with oxy-acetylene 582†
 Pneumatic bulldozer 309*
 Pollak Steel Co., axles 1366
 Pomeroy, L. R., Basis for measuring lathe capacity 133*
 Pomeroy, L. R., Curves of locomotive operation 68*
 Pomeroy, L. R., Diagram of machine tool operation 248*
 Pomeroy, L. R., Power required for punching 372*
 Pomeroy, L. R., Tractive effort chart 436*
 Pomeroy, L. R., Transmission of electric power 182*
 Portable turning machine, Pedrick 569*
 Postal car lighting fixtures 218*
 Postal car lighting, specifications 97
 Postal car (see Car).
 Power distribution in Mallets, by Paul Weeks 237*
 Power house, Centralia locomotive terminal. Power plant operation, Efficient, by Ernest Cordial 531
 Power required for punching 372*
 Power Specialty Co., Locomotive superheater 675*
 Powers, R. C., Cumberland terminal of the B. & O. 591*
 Pratt, E. W., Address at T. E. A. Convention 477
 Pratt, E. W., biography 1409*
 Press, Hydraulic forging, Chambersburg 339*
 Press, small pneumatic, Frisco 376*
 Prest-O-Lite Car, Car, Hopper 70-ton Birmingham Southern 503*
 Prest-O-Lite Co., welding outfit 220*
 Prest-O-Welder, oxy-acetylene 320*
 Prices for labor and material, M. C. B. 101*
 Propellers, High speed ship 524†
 Public regulation, Objectionable 1278*
 Pullman cars, New end construction for 504
 Punching machine, Power required 372*
 Purchase, E. R., Reclamation of scrap tool steel 432
 Purdue locomotive testing plant 171§
 Pure National Electric Headlight Co., headlight 1365*
 Pyrene Mfg. Co., Bracket for extinguisher 1524*

Q

Quayle, Robert, Address at Boiler Makers' convention 315
 Quayle, Robert, Address at General Foremen's convention 415
 Queenan, Wm., Making stock cars from scrapped box cars 379

R

Rack for short lengths of bar, W. & L. E. Radial stays, Turning and threading, Cent. of Ga. 75*
 Rails, Copper in 164†
 Railroad construction in the Philippines 347†
 Railroad stock and real estate 340†
 Railroads and the college man 645†
 3208, 5333, 5778, 5803, 6383, 6392, Railway Business Association (see Meetings).
 Railway Club of Pittsburgh (see Meetings).
 Railway difficulties in Argentina 404†
 Railway extensions in western Australia 402†

Railway Fuel Association Convention

(Reports and Discussion.)

Boilers, Scaling of locomotive 295
 Cars, Self-propelled 334
 Coal mine, Construction and operation of a bituminous 293
 Coal, Sub-bituminous and lignite 290
 Cooling station, Model locomotive 294
 Contract, Standard form of 289
 Election of officers 296
 Firing practice 293
 Railway Fuel Association Meeting 293
 Railway General Foremen's Association (see General Foremen's Association).
 Railway Specifications, paper by O. S. Bever, Jr., Western Railway Club 50

Railway Storekeepers' Association

(Reports and Discussion.)

Authorized list 304
 Effect of specification and testing on storekeepers' stock 299
 Effect of stores department on operating cost 301
 Election of officers 304
 Gas handling 300
 Inactive mills at scrap docks 297
 Rolling mills at scrap docks 305
 Standard casting platforms 313
 Standard dry lumber shed 307
 Standard oil house 310
 Standard supply car 302*
 Railway Storekeepers' Association (see also Meetings).
 Railway Supply Manufacturers' Association, Officers and committees 1250*
 Railway Supply Manufacturers' Association (see also Meetings).
 Railway Tool Foremen's Convention (see Tool Foremen's Convention).
 Railroad travel, Early 288†
 Railway Utility Co., Regulating devices 1526*
 Railway Utility Co., Ventilators 1466*
 Railways, Value of electric power 227*
 Ratio of compound cylinders 297*
 Reading (see Philadelphia & Reading).
 Reamer, Expansion, Boston & Maine 595
 Receipts for scrap 444
 Recommendations, Careful consideration of 1425§
 Record of locomotive equipment 527*
 Reed-Prentice Co., lathe 1366*
 Refrigeration, Thirty-third congress of I., Proportions of refrigerator cars 613
 Refrigerator cars (see Car).
 Reid, J. C., Selection of operators for oxy-acetylene welding 243
 Reming, C. N., Undesired quick action of brakes 317
 Repairs, cost of freight car 635§
 Reverse gear, Power, Casey-Cavin 627*
 Reverse gear, Screw and lever, P. & R. 412*, 413*
 Rice, N. M., Effect of stores department on operating cost 301
 Rolling mill shaker 1391*
 Rink, G. W., Steel underframe box cars 637*
 Rivet forge, Portable by F. H. Babcock 353*
 Rivet heater, Portable, P. R. R. 256*
 Rolling mill, Large, Hanger type 274†
 Riveter, "Little David" 332*
 Riveting machine, Electric, Evesland 394*
 Roberts, A. M., Boiler studs and plugs 435
 Rock Island Lines, Locomotive as a fire engine, Repairs to machine 583*
 Rocker arm bosses, Tool for turning, M. K. & T. 81*
 Rod brass, Improved, by J. E. Osmer 186*
 Rod oil, Large, grease cup 321*
 Rods, Cost of repairing 129*
 Rods, Designing locomotive connecting, 1708, 1795 275*
 Rods, Main, Foulder design 583*
 Rogers, R. D., Replacing driving spring on Mallet 76
 Rolling chairs, Free 1247§
 Rolling mills at scrap docks 305
 Rommel, C. T., Location of steam gages in setting safety valves 533*
 Rosenbaum, E. R., Apparatus for welding 452*
 Roth, E. F., Inactive and obsolete stock 297
 Roundhouse, B. & O., at Cumberland 591*

Roundhouse, Centralia, Ill. Cent. 353*
 Roundhouses, Facilities, Superior, European 185*
 Roundhouse foreman needed at night 519§
 Rules of interchange 463§
 Rules of interchange, Revision of, M. C. 1451
 Runsey freight car door 216*
 Runsey mail car door 509*
 Russia, Purchase of railways 403†
 Rutan, A. N., Tool for repairing triple valve 625*

S

S. K. F. Ball Bearing Company, Bearings for axle light generators 453*
 Saddle pin offset, Formula for 647*
 Safety appliance models, Norfolk & Western 442*
 Safety appliances, Application to cars 147*
 Safety appliances in Porto Rico 130†
 Safety Car Heating & Lighting Company, Axle generator suspension 456*
 Safety Car Heating & Lighting Co., Ball bearings on facilities 1466*
 Safety Car Heating & Lighting Co., Combined fan and lighting fixture 1420*
 Safety Car Heating & Lighting Co., Electric ignition of gas light 1498*
 Safety Car Heating & Lighting Co., Fixtures for vestibules 1420*
 Safety Car Heating & Lighting Co., Lighting fixtures for postal cars 218*
 Safety Car Heating & Lighting Co., by W. T. Gale 137*
 Safety devices for locomotive boilers 333*
 Safety exhibit, Traveling 405§
 Safety first 602†
 Safety first, Paper at Painters' Convention 543
 Safety gats, W. & L. E. 369*
 Safety Steel Ladder Co., Box car ladder 20*
 Safety talks in pay envelopes 513†
 Safety valves, Location of steam gages in setting 533*
 Safety valves Securing during tests 1522
 Safety valve testing, Frisco 378*
 St. Louis & San Francisco, Air hammer for boiler shops 191*
 St. Louis & San Francisco, Shop kinks 373*
 St. Louis & San Francisco, Steel frame box cars 555*
 Sand blast, Portable 86*
 Sand, handling on locomotives 172§
 Sand, use of, on locomotives, by F. E. Patton 594
 Sander, Air for interurban cars 482*
 Santa Fe, Apprentice instruction on 311*
 Santa Fe, Axle lighting system 392*
 Santa Fe, Coupler, engine and tender 274*
 Santa Fe, Lathes, milling attachment for 84*
 Santa Fe, Locomotive, 2-8-2 type 525*
 Santa Fe, Locomotive, 6-2 type 535*
 Santa Fe, Six-wheel under truck 310
 Santa Fe, Standard oil house 310
 Sauvage air brake safety attachment 1423*
 Sauvage air brake valve 1468*
 Saw, Cut-off, N. & W. 443*
 Saw (see also Machine Tools).
 Scaffold for boiler shop 494*
 Scales, Device for removing from arc tubes 219*
 Sealing of locomotive boilers 295
 Scenery, Special baggage car for 615*
 Schroeder Lamp Works, Automatic shut-off valve 450*
 Schuchardt & Schutte, Corrugated tubes 273
 Schulze, R. W., Grain car inspection 33
 Schulze, R. W., Improved methods of safety car construction 427*
 Schulze, R. W., Instruction in interchange rules 154
 Schwartz, R. M., Record of locomotives 52*
 Sealey, C. R., Sign structure, steel pipe 309†
 Scrap docks, Rolling mills at 305
 Scrap material, Handling, by B. J. Froelich 113*
 Scrap, Reclaiming 412*
 Screw reverse gear, P. & R. 232*
 Seaboard Air Line Blacksmith Shop kinks 191*
 Seaboard Air Line, Trailer truck 74*
 Searle, J. M., Practical methods of abating smoke 106
 Seat box for locomotive cab 242*
 Seat, Convertible for compartment cars 447*
 Seat, engineer's in cab 1467*
 Seats, Steel for driving boxes 147†
 Self-propelled cars, by Dodd & Arnold 324*
 Seley, C. A., Address at Boiler Makers' convention 314
 Seley, C. A., Steel structure, steel pipe 258
 car, A. S. M. E. 258
 Sellers, William & Co., Safety squirt for sprinkling car 564*
 Shafts, Steel for driving boxes 374*
 Shaper for driving boxes 100*
 Shaper, Heavy duty back geared, Stock-bridge 338*
 Shaper (see also structure, steel pipe).
 Sheafe air hose coupling 332*
 Sheafe, I. S., Air brake hose 1162, 618*

Page numbers under 1,000 refer to *Railway Age Gazette, Mechanical Edition*; those over 1,000 refer to the *Daily Railway Age Gazette*. * Illustrated article, † editorial; ‡ short non-illustrated article or note; § communication.

Sheafe, J. S., Effect of specifications on stokerkeeper's stock 299
 Shears, Pneumatic, Frisco 375*
 Shed for dry lumber 307*
 Sheehy, P., Operation of locomotive drifting device 643*
 Sheehan, J. J., Reclamation of scrap tool steel 431
 Shield for water glass 227*
 Shield for water glass, safety 333
 Shield for water glass, safety 333
 Shield for water glass, safety 333
 Shields for locomotive decks, B. & O. 122*
 Shoes and wedges, Laying off, by E. T. Spidy 307*
 Shoes and wedges, Planning, C. & O. 537*
 Shop arrangements and facilities for cars, by L. S. Downing 144
 Shop buildings, Standard gage track through Shop, The finishing 648
 Shop hospital room 84*
 Shop improvements at Burnside 193*

Shop Kinks

Air clamp for drill press, M., K. & T. 81*
 Air hammer for boiler shops, Frisco 191
 Air lift for planer tool head, Cent. of Ga. 537*
 Air motors, angle attachment for, B. & O. 222*
 Air pump testing stands, Frisco 375*
 Air and steam hose, Machine for mounting, M., K. & T. 84*
 Angle plates for planing lugs, Frisco 414*
 Arch tube pressers, Jig for splitting, Erie 661*
 Attachment for countersinking on drill press, B. & O. 32*
 Axle lathe output increased, by C. L. Dickert, Cent. of Ga. 24*
 Belt record, W. & L. E. 370*
 Blacksmith shop appliances, by C. L. Dickert 250*
 Boiler shells, Drilling holes in, M., K. & T. 84*
 Boiler tube rack, A. T. L. 606*
 Boiler hat for cylinders, M., K. & T. 82*
 Boyer speed recorder testing stand, Erie 661*
 Brake cylinder push rods, Welding jaws on 253*
 Brake staffs, Upsetting, Cent. of Ga. 538*
 Bulldozer, Pneumatic 309*
 Carry irons, Bending, Frisco 191*
 Chuck for drill press, Frisco 327*
 Chuck, Pneumatic for staybolt drilling 375*
 Chuck for threading studs, B. & M. 595*
 Clamps for crosshead, Frisco 377*
 Clamps for holding driving boxes, Frisco 373*
 Clamps for lifting tires, Frisco 373*
 Crane on smoke stack 85*
 Coupler yoke, Upsetting and punching Cut-off saw, N. & W. 443*
 Cylinders, repaired with concrete, C. & O. 131*
 Device for bending S hooks 191*
 Device for repairing brake beams 191*
 Dies for forming brake rod jaws 253*
 Dies for swaging bolts, Frisco 192*
 Driver for car axle lathe, Cent. of Ga. 34*
 Driving box, Brass liners on shoe and wedge fit, B. & O. 75*
 Driving box brass liners, Table for slotting, M., K. & T. 81*
 Driving box cellars, Removing 142*
 Driving box, Oil pipe for hub 306*
 Eccentric blade bender, B. & M. 306*
 Eccentric drilling jig, Frisco 376*
 Expansion arbor, B. & M. 595*
 Expansion reamer, B. & M. 595*
 Gage rock holes, Locating on boiler, Frisco & O. 21*
 Grinding throttle valves, M., K. & T. 81*
 Hammer for removing side rod bushings 484*
 Heavy expansion arbor, B. & M. 595*
 Hoist, Pneumatic for loading cars 85*
 Hose connections, Device for pressing in, Erie 661*
 Incline, half bearing concrete, C. & O. 596*
 Jig for drilling crosshead shoes, B. & M. 377*
 Lathe chuck crane, Frisco 377*
 Lathe dog, Heavy, Frisco 374*
 Machine for turning ball joints, C. & O. 603*
 Metal tool cabinet, Frisco 378*
 Milling attachment for lathes, Santa Fe 84*
 Motion work klips, Great Northern 136*
 Oil burner for heating tires 310*
 Packing rings, gang tool for cutting, Cent. of Ga. 75*
 Pan for handling material, B. & O. 537*
 Pipe bender, Cent. of Ga. 443*
 Pipe bending device 21*
 Piston rings of air brake apparatus, Grinding, L. & N. 132*
 Planing shoes and wedges, Cent. of Ga. 537*
 Pneumatic press, small, Frisco 376*

Shop Kinks—(continued)

Pneumatic shears and cabinet for studs and bolts, Frisco 375*
 Rack, Iron for short lengths, W. & L. Radial 76*
 Radial shaft, Cent. of Ga. 76*
 Radius attachment for slotting machines, Frisco 377*
 Ratchet planer, Frisco 378*
 Rivet heater, Portable, P. & L. E. 33*
 Rivet large, Portable 250
 Rod bender, flat 136*
 Rod bender, round 136*
 Rod twister 136*
 Safety gates, W. & L. E. 369*
 Safety valve tester, Frisco 378*
 Sand blast, Portable 38*
 Shackles for driving wheel, Frisco 374*
 Shoes and wedges, Planning, C. & O. 537*
 Slide valve feed valves, Protecting in shipment, C. & N. W. 132*
 Spring bands, Machines for pressing off, M., K. & T. 82*
 Spring planks, Punching, Cent. of Ga. 131*
 Spool for packing, C. & N. W. 596*
 Stand for driving wheels, Erie 661*
 Staybolts, Testing 377*
 Stock feeders for turret lathe, B. & M. 598*
 Tire gage, Frisco 378*
 Tire heater for locomotive 309*
 Tire setting gage, Cent. of Ga. 537*
 Tool for turning rock arm bosses, M., K. & T. 81*
 Tumbling shafts, tool for turning, M., K. & T. 83*
 Turret tool holder for axle lathe, Cent. of Ga. 34*
 Vise for filing crossheads, B. & M. 596*
 Wrench for removing lubricator choke plugs, C. & N. W. 371*
 Shop men, Safety from accidents, C. & N. W. 137*
 Shop operating costs, Decreasing 170*
 Shop output, by J. H. Tinker 666
 Shop schedules, Paper at General Foremen's convention 423*
 Shore, A. F., Locomotive driving wheel 450*
 Siemantel, E. L., Milling attachment for lathes, Santa Fe 84*
 Side bearings, Anti-friction, south 138*
 Side bearings, Roller, Economy 1530*
 Side bearings, Roller, Joliet 1521*
 Side frame, Truck, Designing a 383
 Side rod grease plug, Frisco 396*
 Side rods, Grease plug for 396*
 Side rods, Oil and grease cups for 366*
 Signals, Block in United States 345*
 Simplex tunnel, The second 562*
 Smoke density in Chicago, Test of 1521*
 Slater locomotive front end 7*
 Slotting machine, Radius attachment for, Frisco 377*
 Smith, C. & O. 32*
 Smith, C. W., Thread cutting dies 434
 Smith, Leroy, Portable rivet heater 256
 Smith, W. B., Frisco 447*
 Smith, Thomas, Piston rod packing 565*
 Smith, Walter, Organization of engine houses 578*
 Smoke abatement 1370*
 Smoke abatement devices, Test of, C. & N. W. 236*
 Smoke burning device, C. & N. W. 513*
 Smoke consumers, Number in Louisville 46f
 Smoke density in Chicago, Test of 478
 Smoke, Elimination of black, by Martin Whelan 472
 Smoke from engine houses 585*
 Smoke Inspectors' Association of Chicago, Report of 478
 Smoke and mechanical stokers 606*
 Smoke, Practical methods of abating, by J. M. Searle 106
 Smoke stack, The highest 1377*
 Society of Testing Materials, Co-operation with 1369*
 Southern Railway 2147
 Southern Australian railways 123*
 Southern Pacific, Standard supply car 303*
 Southern Railway of France, Engine house space in 187*
 Spain and France, Railroad to connect 1247*
 Spain, Railroad connections in 209*
 Spain, Railroad connections in 192*
 Specialization, Over 496*
 Specifications for Chrome and steel tires 16*
 Specifications for locomotive frames 1343*
 Specifications for postal car lighting 97
 Specifications and testing of material, Effect on stokerkeeper's stock 299
 Speed gear, Hydraulic, W. & L. E. 1527*
 Speckers, Gasoline in fire prevention 562*
 Spikes, Holding power of 130f
 Spidy, E. T., Laying off shoes and wedges 307*
 Sprague electric hoist 1400
 Spring bands, Machine for pressing off, M., K. & T. 82*
 Spring, making and repairing, paper at Blacksmiths' convention 488*

Shop Kinks—(continued)

Spring planks, Punching, (Cent. of Ga. 131*
 Springs, Tests of vanadium 70
 Squirt hose, Armored 334*
 Squirt hose, Safety, Burnside 449*
 Squirt, Safety for sprinkling coal 564*
 Stack, concrete at Burnside shops 193*
 Standard Car Truck Co., Flat car, P. & R. 1502*
 Standard locomotive stoker 621*
 Standard locomotive, discussion by H. J. Vaughan 11
 Standard Steel Castings Co., Small castings 1470*
 Standardization of the myriawatt 190
 Staybolts, Testing 377*
 Steam car for navigation 288*
 Steam consumption from indicator cards 349*
 Steam gages, Location of in setting safety valves 533*
 Steam heat traps, Location of 328
 Steam hose coupling, Lock for 1398*
 Steam meter, Improved, Gen. Elec. Co. 507*
 Steel castings, Small 151*
 Steel ends on Frisco box cars 557*
 Steel equipment, Paint protection for, paper at Painters' convention 544*
 Steel, Heat treatment of case hardened 347*
 Steel interior finish for passenger equipment 1525*
 Steel passenger car design, A. S. M. E. 257
 Steel passenger car (see Car) 257
 Steel passenger train equipment, Development of 650
 Steel, Special alloys and heat treatment for locomotives 1369*
 Steel tires 1347, 1376
 Steel tires 1356*
 Stevenson, James, Taking up lateral in driving box 74*
 Stock cars, Making from scrapped box cars, C. B. & O. 379
 Stockbridge Machine Company, Shaper 338*
 Stoker, The Gee locomotive 111*
 Stoker, Hervey, Frisco 393*
 Stoker, Mechanical 606*
 Stoker, The Standard locomotive 621*
 Stoker, Street locomotive 1504
 Stokes, W. D., Inactive and obsolete stock 298
 Stollwartz, A., Link side bearing truck 673*
 Storehouse, Platforms for castings 313
 Stokerkeepers' Association 284*
 Stokerkeepers' Association, Criticism 406*
 Stokerkeepers' Association (see Railway Stokerkeepers' Association) 298
 Stokerkeeper's stock, Inactive and obsolete 298
 Stores department, Effect on operating cost, by N. M. Rice 301
 Stucki, A., Car wheel flanges and treads, Subject locomotive cylinder 304*
 Subjects for Master Mechanics' Association 348*
 Subway for New York, Proposed new 618
 Subway for Genoa, Italy 248*
 Subway, Traffic on the New York 608*
 Sulphur and oxygen in iron and steel 220*
 Sulzer-Diesel locomotive 589*
 Summers, E. W., Suspension of steel passenger cars, A. S. M. E. 258
 Superheated steam, Advantages of, discussion by C. D. Young 15*
 Superheater tubes, Care of, by T. P. Madson 350f
 Superheater tubes, Care of, by T. P. Madson 1266*
 Superheater tubes, Welding of 315
 Superheater, Young locomotive 675*
 Superheaters, discussion by S. Hoffman, A. S. M. E. 13
 Superheaters, Effect of, on life of firebox and flues 315
 Superheaters and high water 288*
 Supplies that have failed 1608
 Supply business, Moral awakening in 1403*

Supply Trade Notes.

Allen, C. W. 575
 Allison, F. H. 166
 American Brake Shoe & Foundry Co. 166
 American Locomotive Co. 55, 166, 517
 American Vanadium Co. 166
 Armstrong, H. 224
 Ashton Valley Co. 224
 Automatic Ventilator Co. 54
 Baldwin Locomotive Works 54, 402
 Ball, H. F. 55
 Bartholomew, G. M. 167*
 Basford, G. W. 224*
 Beaver, C. W. 55
 Beaver Dam Malleable Iron Co. 575
 Berry, C. C. 54
 Best, Leigh 166

Supply Trade Notes—(continued)

Bordo, L. J. Co. 517, 575
 Bower, J. G. 402
 Bowers, S. J. & Co., Inc. 402, 460
 Bradford, C. C. 634
 Brown, Jos. M. Co. 55
 Buckley Steel Castings Co. 402
 Buda Co. 345
 Buffalo Brake & Beam Co. 54, 224
 Burden Sales Co. 109
 C. & C. Electric Co. 109
 Chadwick, A. B. 166
 Chicago Air Brake Co. 633
 Chicago Car Heating Co. 109
 Chicago-Cleveland Car Roofing Co. 109
 Chisholm, J. E. 109
 Coffin, C. A. 402
 224
 Craven, G. W. 345
 Crone, A. E. 54
 Curtin, J. M. 280
 Dayton Locomotive Works 166
 Davis-Bounnonville Co. 54
 Dearborn Chemical Co. 54
 Detroit Lubricator Co. 402
 Donald, William 280
 Easton Car Construction Co. The 234
 Easton, E. N. 234
 Economy Devices Co. 402
 Edison Storage Battery Co. 224
 Edison, Thomas A. Co. 160, 633, 683
 Edwards, O. M. Co. 166
 Eggert, C. A. 683
 Emms, J. B. Co. 55
 Equipment Improvement Co. 683
 Faessler Mfg. Co. 54
 Ferro Machine & Foundry Co. 54
 Forsyth Bros. Co. 345
 Foster, W. H. Co. 224
 Fraser, R. C. 224
 Fritz, John (obituary) 166
 Froggatt-Morrison & Co. 224
 Gardner, Frank 109
 General Electric Co. 402, 633
 General Pipe, Bending & Erecting Co. 109
 Girtlen, W. F. (obituary) 461
 Griggs, F. N. 166
 Grover, H. M. Co. 166
 Grip Nut Co. 54, 166
 Grip Nut Co. 633
 Hall, W. B. 109
 Hawley, W. P. 345
 Hess-Bright Mfg. Co. 54
 Higginbotham, J. U. 402
 Hoffhine, John 166
 Howard, Blake A. Co. 633
 Hudson, E. C. 633, 683
 Humphrey, A. L. 167
 Huthbins Car Roofing Co. 54
 Industrial Works 224
 Jacobs-Shuppert Co. S. Firebox Co. 109
 Jenkinson, W. E. Co. 402
 Johns-Manville, H. W. Co. 54
 Jones, Chester H. 633
 Jungsman, August 280
 Kerr Turbine Co. 224
 Kirkpatrick, J. B. 633
 Lavelle, H. E. 460
 Leaking, E. 633
 Lewis, B. J. (obituary) 166
 Littlefield, Fry & McCough 166
 Lima Locomotive Corporation 402
 Lindstrom, C. A. 280
 Locomotive Brick Arch Co. 109
 Locomotive Stoker Co. 167
 Lowman, Harry 109
 Lucas, Abram 224
 M. C. B. Co. 345
 McCormick, C. H. 575
 McIntosh & Seymour Corp. 683
 Maining, Maxwell & Moore, Inc. 575
 Mazzur, F. 224
 Meeker Grip Nut Co. 224
 Mesker, L. H. 54
 Mid-Western Car Supply Co. 517
 Miller, Wm. 55
 Monarch Pneumatic Tool Co. 55
 Moore, A. C. 402
 Morrison, C. J. 224
 Mudge, Burton W. & Co. 224
 Mundy, Arthur 224
 National Malleable Castings Co. (obituary) 517
 Nicholson, J. L. 402
 Noble, L. C. (obituary) 517
 Oil Power Engineering Corporation 54
 Olmstead, C. J. 166
 Oxwell Acetylene Co. 54
 Passmore, H. 166
 Payne, Nathan B. 402
 Peabody, G. Haven 402
 Pearsall, G. H. 109
 Pecknick Tool & Machine Co. 224
 Perry, H. M. 166
 Pittsburgh Spring & Steel Co. (obituary) 517
 Pittsburgh Spring & Steel Co. 575
 Pope, A. J. (obituary) 517
 Pressed Steel Car Co. 109, 280
 Proctor & Gamble Co. 166
 Pullman Co. 55
 Putnam Machine Co. 575

Supply Trade Notes—(continued)

Pyle-National Electric Headlight Co. 55
 Onigley Furnace Co., The 683
 Railway Utility Co. 683
 Ralston Steel Car Co. 683
 Reading-Bayonne Steel Castings Co. 575
 Replogle, C. N. 575
 Rice, E. W., Jr. 402*
 Rider, H. H. 683
 Robbins, Chas. 280
 Rose, W. G. 166
 Rosenthal, A. E. 280
 Rosenthal, G. D. 345
 Ross, Mark 345
 Ryan, M. F. 575
 Ryerson, Jos. T. & Son. 109, 224
 Safety Car Heating & Lighting Co. 402*
 Safety Car Heating & Lighting Co. 575*
 Sargent, G. M. 109*
 Slocum, E. F. 575*
 Standard Asphalt & Rubber Co. 166
 Standard Heat & Ventilation Co. 109, 166, 517, 575
 Star Brass Mfg. Co. 109
 Stark, J. L. 402
 Stead, W. B. 55
 Stetson, A. B. 683
 Stoy, G. E. 345
 Strauss, H. A. Co. 402
 Street, C. F. 167*
 Swan, J. S. 54
 Tate-Jones & Co., Inc. 280
 Taylor, E. C. 54
 Thompson, A. N. 280
 Thompson, H. B. & Co. 460
 Thornburgh, Wm. N. 166
 Titanium Alloy Mfg. Co. 280
 Turner, G. S. 575
 Union Railway Equipment Co. 224
 United States Light & Heating Co. 345* 634
 Universal Flexible Packing Co. 109
 Van Dorn & Dutton Co., The 55
 Van Nest Co. 54
 Vandavear Clay Products Co. 345
 Waugh Draft Gear Co. 345
 Weaver, C. R. 517
 Westcott, G. R. 345
 Westinghouse Air Brake Co. 166*
 Westinghouse Elec. & Mfg. Co. 280
 Whipple, A. L. 517
 Whyte, W. M. 54
 Williams, A. R., Mach. Co. 280
 Winslow, Horace L. 683
 Wood, M. F. 54
 Woods, Edwin S. & Co. 166
 Woods, J. S. (obituary) 683*
 Wyckoff, A. D. 575
 Yale & Towne Mfg. Co. 55
 Swenson Valve Company, Boiler check 456*

T

Tables for designing car center sills 444*
 Tables of locomotive dimensions 18
 Tank car design 445*
 Tank and strainer valve, Franklin 1367
 Tank waste soaking, Bowser 150*
 Tank well and valve, D. L. & W. 513*
 Tasmanian railways 1547
 Temperature regulating devices, Utility 1526
 Tender truck, Engineering Association 497*
 Tender truck, Six-wheel, Santa Fe. 5198, 526*
 Tender, Vestibuled, Can. Pac. 620*
 Terry Steam Turbine Co., Train lighting set 176*
 Test of brake shoes 14258
 Test with superheated steam 13708
 Test, Turning truck wheel tire 4663
 Test of Vanadium cast steel frames 397*
 Test of superheated steam, Machine 150*
 R. R. 159*
 Testing machine, Tension 1,000,000 lbs. capacity, P. R. R. 1350*
 Testing plant, The Purdue locomotive 159*, 1718, 13448, 1350*
 Tests of alcohol heater car 441*
 Tests of boring machine 99*
 Tests, Horizontal, grinding machine 104*
 Tests, Jacobs-Shuppert boiler 63*
 Tests of paints 188*
 Tests of passenger car lighting 607
 Tests of spring steel 70
 Tests of superheated locomotives 1384*
 Tests, Plant for testing cars 18
 Tests, postal car lighting 212*
 Texas State Railroad 3167
 The J. C. Nicholas Co., Device for securing hand holds 103*
 Thomson Pneumatic Tool Co., Drill clamps 103*
 Throttler lever, Improved 331*
 Throttling valve, grinding machine 31*
 Tirker, J. H., Shop output 666
 Timber, Seasoning by electricity 6242
 Time study of repairing driving boxes 202*
 Tire, Grinding, grinding machine 624
 Tire heater, Hauck 628*
 Tire heater, Gasolene 309*
 Tires, Turning driving wheel 1732
 Tires, Turning driving wheel, E. A. Murray 6402

Tire turning record 623
 Tire turning, Record for, C. & O. 336*
 Tires, Clamp for lifting, Frisco 373*
 Tires, Tests of Chrome-Vanadium 15*
 Tool, John, Shop kinks 661*
 Tool cabinet, Metal, Frisco 376*
 Tool for finishing ball joints of superheater units 1401*

Tool Foremen's Convention.

(Reports and Discussions.)

Dies for forging machines 434
 Form of thread and degree of taper for studs and plugs 435
 Making thread cutting dies 433
 Pratt, L. W. address 434
 Superheater tools and their care 432
 Tool steel, scrap, Reclamation of 431
 Tool for repairing triple valves 625*
 Tool post, Turret for axle lathe 34*
 Tools and formers, paper at Blacksmiths' convention 486
 Tools for application of boiler tubes 23*
 Tools for the blacksmith shop 191*
 Tools, Special, wrecking, C. B. & O. 147*
 Torque, Basis for measuring lathe capacity 133*
 Tracing files, Duplex spring clips for 271*
 Tractive effort chart, by L. R. Pomeroy 436*
 Tractive effort, Maximum, Speeds to be obtained 68*
 Trailer truck, New design of Hodges 74*
 Train wrecks, Equipment for clearing 445*
 Trains, Late, New York central 1344
 Transindian Railway 1651
 Transformers, Electric explained 184
 Traveling Engineers' convention, comments 4648

Traveling Engineers' Convention.

(Reports and Discussions.)

Address by F. F. Gaines 474
 Address by D. R. MacBain 476
 Address by W. J. Park 477
 Address by E. W. Pratt 477
 Address of President 480
 Advantages of the brick arch 473
 Care of locomotive brake equipment 477
 Election of officers 478
 Elimination of black smoke from locomotives 472
 Operating department and fuel economy 469
 Operating superheater locomotives 467
 Traveling Engineers' Association (see Meetings)
 Trespassers, Penalties for 3901
 Trespassers in Texas 537
 Triple valve lubrication 1403*
 Triumph Electric Co., Reversing motor plant 269*
 Truck, Arch bar 15058
 Truck bolster, Designing a 381*
 Truck, Electric, Ellwell-Parker 1497*
 Truck, Equalizer design 381*
 Truck equalizer design by L. V. Curran 96*
 Truck equalizer design, by Sigurd Holm 3502
 Truck for 70 ton car 1503*
 Truck, Equalizing 381*
 Truck side frame, Designing a 383*
 Truck, Tender, Six wheel 5198
 Truck, Tender, Equalized swing motion 397*
 Truck wheel tire turning test 4661
 Truck transoms for passenger coaches, Manufacturing 487*
 Trucks, Car, Six wheel, N. & W. 38*
 Trucks, Electric, Self-propelling 1497*
 Tube ends, Dies for swaging 142*
 Tube, Improved type of corrugated 273
 Tubes, Limit of length, without midway support 314
 Tubular, Limit of length, without midway support 314
 Tuna, F., Compound locomotive air pump 104*
 Tumbling shafts, Tool for turning, M. K. & T. 83*
 Turbine, Steam, Stages of 241
 Turbines, Lateral, marine 6507
 Turntable tractor 448*
 Turret lathe, Stock feeders for, B. & M. 596*
 Twister for rods, G. N. 136*

U

Underframe for steel gondola, designing a 384*
 Underframe, Steel passenger car, John McE. 261
 Underframe, Steel passenger car, John McE. 261
 Underframe, Steel passenger car, John McE. 261
 Union Pacific, Moving pictures in educational work 67
 Union Pacific refrigerator car 263*
 Union Pacific, Southern Pacific standard locomotives 5
 Union Pacific, Standard locomotives 18
 Union Railway Equipment Co., Metal car 101*
 Union Steel Castings Co., Test of locomotive frames 397*
 U. S. Metal & Mfg. Co., Collapsible stake pocket 678*

U. S. Metal & Manufacturing Co., The Kling bolt 158*
 United States air brake..... 508*
 Unloading machines, Damage to cars..... 1507*
 Uruguay, New port railway in..... 456†

V

Valve, Automatic shut-off 450*
 Valve, blower 160*
 Valve, Brass gate, Jenkins..... 1501*
 Valve gear, Improving 169§
 Valve gear, Locomotive, driven from cross-head 215*
 Valve setting and cylinder ratios in Mal-lets 237*
 Valve, Tank and strainer..... 1367*
 Valves, Size of reducing..... 643†
 Van Dorn, W. T. Co., Pressed steel ends..... 1499
 Van Dyken, H., Detector for fractured crank pins 512*
 Vanadium cast steel frames, Drop test of..... 397*
 Vanadium production 122†
 Vanadium spring steel, Tests of..... 70
 Vanadium steel car wheels..... 181
 Vanadium steel driving axles and frames, Service of 1254
 Vanadium steel locomotive parts, Service of standard locomotives 648
 Vaughan, H. H., General problem, Steel passenger cars, A. S. M. E..... 257
 Vehicles, Dead weight of..... 84†
 Ventilator, Locomotive cab window..... 676*
 Ventilators, Utility 1466*
 Vestibule, Collapsible for steel cars..... 87
 Vestibule locomotive cab..... 117*
 Victoria, Passenger alarms in..... 352†
 Victorian railways, Rolling stock on..... 32†
 Virginian Railway, Replacing a driver spring on a Mallet 76
 Vise, Quick acting lever..... 674*
 Vixen Tool Co., File sharpener..... 396*

W

Wabash Railroad, 60 foot steel postal car..... 609*
 Wallace, L. W., designing a steel gondola car 381*
 Wallace, L. W., Study of car wheel flanges and treads 497*
 Waste retainer for journal boxes..... 510*
 Water cooler for postal cars..... 1498
 Water coolers, Sterilizing 1500

Water gage, Babcock safety..... 333*
 Water gage, Improved Klinger type..... 1299*
 Water gage, Safety cut-out valve for..... 1266*
 Water glass shield, Deico safety..... 227§
 Water glass shield, Lake Shore..... 333*
 Water joint, Franklin 235*
 Water on trains, Pure drinking..... 1400*
 Water tube fireboxes 53†
 Water tube firebox, Service of Brotan 113§
 Water unaccounted for 128*
 Waterbury Tool Co., Hydraulic speed gear..... 153†
 Watertown Specialty Company, Cylinder cocks 1527*
 Watertown Specialty Company, Safety Squirt Hose 101*
 Watson-Stillman, Hydro-pneumatic accumu-lators 449*
 Watson-Stillman Co., Pit jack..... 48*, 1421*
 Watson-Stillman Co., Pit jack..... 271*, 1265*
 Watson-Stillman Co., Shear and riveter for coupler yoke 1523*
 Weeks, Paul, Distribution of power in Mal-lets 237*
 Weir & Craig Manufacturing Company, Turntable tractor 448*
 Welding, Oxy-acetylene and electric..... 315
 Welds, Making with the electric arc..... 391*
 Welfie, L. P., Side rod grease plug..... 568*
 Welin Marine Equipment Company, Compensating quadrant crane..... 455*
 Welin Marine Equipment Company, Express refriger-ator cars 149*
 West Disinfecting Co., Sterilizing water coolers 1500
 Westlark, C. T., Cast-steel double body bol-sters, A. S. M. E..... 115†
 Western Canada Railway Club (see Meetings).
 Western Railway Club, Paper on shop out-put 666
 Western Railway Club (see Meetings).
 Westinghouse Electric & Manufacturing Co., Motor for shop service 159*
 Westinghouse Electric & Manufacturing Co., Single-phase motor 1521
 Westinghouse Electric & Manufacturing Co., Universal blow torch..... 453*
 Westlake, C. T., Cast-steel double body bol-sters, A. S. M. E..... 260
 Wesley, Isaiah S., Manufacture of brake beam hangers 367*
 Wheel flanges and treads, Car..... 523*
 Wheel flanges and treads, Study of, by L. W. Wallace 497*
 Wheel lathe, New model 336*
 Wheel and rail, Relation of 1426§
 Wheels, Cast iron for 70 tons capacity..... 336§
 Wheels, Chrome-Vanadium steel 181
 Wheels, Locating defective on cars..... 152*

Wheels, Unloading car 390*
 Wheeling & Lake Erie, Iron rack for short lengths 76*
 Wheeling & Lake Erie, Locomotive, 2-8-0 type 641*
 Wheeling & Lake Erie, Shop kinks..... 369*
 Wheeling & Lake Erie, Shop kinks..... 472
 Wheeler, Martin, Elimination of black smoke
 Wiener Machinery Co., Quadruple combina-tion machine 452*
 Wilson, H. C., Boiler studs and plugs..... 435
 Wilmarth & Moran Co., Surface grinding machine 1267*
 Window weather stripping, Universal..... 1501*
 Winter, Preparing for 636§
 Winterrowd, W. H., 4-6-2 type locomotive..... 117*
 Wireless, Long distance 204†
 Wireless, Stopping trains by..... 606†
 Wiring diagram for electric headlight..... 367*, 429*, 546*, 603*
 Wolfe, Ralph, Care and maintenance of air brakes 265
 Wolfgang, W. H., Iron rack for short lengths 76*
 Wolfgang, W. H., Shop kinks..... 369*
 Wood, Arthur J., Railroads and the college man 638†
 Wood, Edwin S. & Co., Anti-friction side bearings 158*
 Woven Steel Hose & Rubber Company, Ar-mored squirt hose..... 334*
 Wreck, Equipment for clearing..... 145*
 Wreck statistics 561*
 Wreck, Steel passenger cars in a 574*
 Wrench, Compression 1503*
 Wrench, Non-binding, Darcalo 1467
 Wrench for removing lubricator choke plugs, C. & N. W..... 371*
 Wrist Pins, Turning four-bar crosshead, 192*, 582†
 Wymer, C. J., Developing efficient car in-spectors 380

Y

Young, C. D., Discussion of advantages of superheated steam 15*
 Young, C. D., Locomotive superheater.... 675*
 Young, C. D., Painting steel passenger cars.
 Young, O. W., Formula for saddle pin off-set 647*
 245*, 259

Z

Zinc production 378†

Page numbers under 1,000 refer to *Railway Age Gazette*, *Mechanical Edition*; those over 1,000 refer to the *Daily Railway Age Gazette*. * Illustrated article; † editorial; ‡ short non-illustrated article or note; § communication.

AMERICAN ENGINEER

"THE RAILWAY MECHANICAL MONTHLY"

(Including the Railway Age Gazette "Shop Edition.")

PUBLISHED ON THE FIRST THURSDAY OF EVERY MONTH, BY THE SIMMONS-BOARDMAN PUBLISHING COMPANY, 83 FULTON STREET, NEW YORK, N. Y.

CHICAGO: Transportation Bldg. CLEVELAND: Citizen's Bldg.
LONDON: Queen Anne's Chambers, Westminster.

EDWARD A. SIMMONS, *President.* HENRY LEE, *Secretary.*
L. B. SHEERMAN, *Vice-President.* A. E. HOOVEN, *Business Manager.*
The address of the company is the address of the officers.

ROY V. WRIGHT, *Editor.* R. E. THAYER, *Associate Editor.*
E. A. AVERILL, *Managing Editor.* A. C. LOUDON, *Associate Editor.*
GEORGE L. FOWLER, *Associate Editor.*

Subscriptions, including the eight daily editions of the *Railway Age Gazette* published in June in connection with the annual conventions of the Master Car Builders' and American Railway Master Mechanics' associations, payable in advance and postage free:

United States, Canada and Mexico.....\$2.00 a year
Foreign Countries (excepting daily editions)..... 3.00 a year
Single Copy 20 cents

Entered at the Post Office at New York, N. Y., as mail matter of the second class.

VOLUME 87. JANUARY, 1913. NUMBER 1.

CONTENTS

EDITORIALS:	
Tables of Locomotive Dimensions.....	1
Standard Locomotives of the Associated Lines.....	1
Errors in Locomotive Design.....	1
Car Testing Plant.....	1
Large Capacity Freight Cars.....	2
Car Department Competition.....	2
The Mechanical Engineer.....	2
Cars and Locomotives in 1912.....	3
Selection of a Locomotive.....	3
New Books.....	4
GENERAL:	
Locomotives for the Associated Lines.....	5
Slater Front End.....	7
Driving Box Lateral Plate.....	8
Factors in the Selection of Locomotives.....	9
Chrome-Vanadium Driving Wheel Tires.....	15
Device for Preventing Scale.....	17
Tabular Comparison of Recent Locomotives.....	18
Large Narrow Gage Locomotives.....	20
SHOP PRACTICE:	
Locomotive Shop Kinks.....	21
Locomotive Boiler Tube Tools.....	23
Repairs to Main Rods.....	29
Chart for Forging Machine Work.....	30
Planing Shoes and Wedges.....	32
Report of Federal Boiler Inspector.....	32
CAR DEPARTMENT:	
Portable Rivet Forge.....	33
Grain Car Inspection.....	33
Increasing Axle Lathe Output.....	34
Ninety-Ton High Side Gondola Car.....	35
A Strong Box Car End.....	40
Freight Car Truck Experiments.....	42
NEW DEVICES:	
Semi-Automatic Nut Tapper.....	45
New Design of Journal Jack.....	45
Locomotive Link Milling Machine.....	46
Reversing Motor Drive for Planers.....	46
Hydro-Pneumatic Accumulator.....	48
NEWS DEPARTMENT:	
Notes.....	49
Meetings and Conventions.....	50
Personals.....	51
New Shops.....	54
Supply Trade Notes.....	54
Catalogs.....	56

Tables of Locomotive Dimensions

In this issue will be found a tabular comparison of the dimensions of the various types of passenger locomotives covering the Mountain, Pacific, Prairie, Atlantic and ten-wheel types, as well as the mogul and switching types. The tables for the Mallet, Santa Fe, Mikado and consolidation types will appear in the February issue. As it is impossible to publish descriptions of all the latest and best examples of all the different types of locomotives in these columns, in many cases selections have been made from the 1912 edition of the Locomotive Dictionary for the typical examples presented, particularly those of the smaller and lighter types. It will be noted that several new ratios are given. These include the percentage of weight on drivers, the amount of evaporative heating surface per square foot of superheater heating surface and the ratio of the firebox heating surface to the grate area. It is believed that each of these is of value in outlining a design to meet specified requirements.

Standard Locomotives of the Associated Lines

In 1903 the Union Pacific System—Southern Pacific Company, then known as the Harriman Lines, adopted a series of standard locomotive designs covering all the different sizes and types that the service demanded. These standards were followed with but minor alterations for seven or eight years and, with the exception of the adoption of the Walschaert valve gear and the installation of superheaters on most of the original classes, are in force today. There is no doubt in the minds of those familiar with all of the conditions but that the close adherence to the standard locomotive designs has been most profitable, and that it is to a considerable degree responsible for the very satisfactory operating expense ratio that has been consistently exhibited on these lines. As was expected in the beginning, it was found necessary after five or six years, to add new and larger classes to the list of standards, and, as will be seen by reference to the article on page 5, the motive power of these lines has not suffered in size, range or efficiency by any fancied restrictions of the standards.

Errors in Locomotive Design

In the design of railroad equipment, and particularly in the case of locomotives, it is often difficult to best proportion and locate a part for the duty it has to perform, and at the same time have it readily accessible and removable for repairs. The latter is, however, a point which should receive more attention at the hands of the designer than it would seem to in many cases. Bolts are very frequently located so that it is next to impossible to remove the nuts, or the bolt after the nuts are removed. Driver brake cylinders are found on modern locomotives so located that it is impossible to remove the piston and spring without taking down the entire cylinder at a cost of several hours extra labor, and in some of the older moguls and consolidations it is impossible to remove the wrist pin from the crosshead without jacking up the engine. Admittedly there are many cases where the question of convenience has to be set aside for some other more pressing consideration of design, but there can be no doubt that more careful consideration of this point in the drawing office would frequently result in considerable saving in the shops and engine houses, and in the reduction of the time that power is out of service.

Car Testing Plant

A report of experiments on the performance of freight car trucks under varying conditions common in actual service will be found on another page. Important data have been obtained which should materially guide the builders and maintainers of car equipment in their future work. This was all done by a mechanical expert under the auspices of a railway supply concern. We cannot discredit any part of the information

as advertising matter. All we can say is that if the data obtained had not been in accordance with the supply company's ideas it might not have been published. We have a sort of neutral ground for testing locomotives at both the University of Illinois and at Purdue University, and also for conducting certain tests for the Master Car Builders' Association. Why should not the railroads get together and establish a testing plant for locomotives, cars and other equipment? They do support an association that constantly investigates the design, control, interchange standards, etc., of cars, but its work is limited because of the lack of proper facilities for making what might be called laboratory tests where all the conditions can be controlled, as distinguished from service tests. That such a testing plant would pay for itself there is no question, for there are vital problems constantly arising, which if properly and correctly solved would mean a considerable saving to the railroads, to say nothing of the increased safety in design. Such questions as tender derailments, the maximum life of wheels, proper design of trucks and underframes, the most economical and durable design of freight car superstructure and various other problems could be investigated.

Large Capacity Freight Cars

For nearly ten years 100,000 lbs. has been the generally adopted capacity for gondola and hopper cars and with the exception of a few special service cars of various types, a car of larger capacity than 120,000 lbs. has been a novelty. While, as a general rule, it can be stated that for this type of car the larger the capacity the greater the proportion of revenue load on a fully loaded car, and, that on those roads having a continuous traffic of mineral products, the demand for larger cars has existed for some time, it has seemed undesirable to perfect a freight car wheel and axle suitable for the heavier pressures that would result if the four-wheel truck was to be retained. The meeting of the demand, therefore, has largely depended on the development of a satisfactory six-wheel freight car truck. The normal type of six-wheel passenger car truck is too heavy, too complicated and too expensive for this service. The building of a suitable car body for this capacity presents no serious problems. Among the roads having a heavy coal traffic is the Norfolk & Western. The mechanical department officers of that road undertook the work of designing a ninety-ton gondola car and have built such a car which is fully illustrated in this issue. The six-wheel truck is entirely original and would appear to have gone a long way toward the solution of the problem. It weighs less than 15,000 lbs., uses the standard $5\frac{1}{2}$ in. x 10 in. axle, has forged steel wheels and cast steel side frames. The novel construction of side frames has avoided the use of equalizers or pedestals and the journal boxes are bolted directly to the frame in the same manner as on a four-wheel freight car truck. The incorporation of a hinged joint over the center journal box makes the frames act as equalizers and there would appear to be but little doubt that the distribution of weights and the flexibility of the truck will be satisfactory. The car body is of the continuous center sill type and is to be used with an unloading machine. For this reason and also to prevent bulging under load, the sides have been unusually well stiffened by wing plates.

Car Department Competition

Last month we made the first announcement of a car department competition to close February 15, 1913. A canvass of our subscribers shows that there is a considerable demand for a larger amount of material of special interest to car department readers. Apparently the fact that the men in this department have not contributed to our columns as freely as those in the locomotive department, or have not been as free in making suggestions or criticisms, is not due to any lack of interest or to indifference. To encourage those who are interested in the design, construction, or maintenance of cars to contribute more freely to our columns we announced last month that a first prize

of \$50 would be awarded for the best article received before February 15, 1913, dealing with some subject of prime interest to those who are interested in the work of the car department. The conditions have been made as broad as possible in order that our car department readers generally may have an opportunity of competing. For instance, the car designer may make suggestions either as to the design of detail parts or of the cars as a whole. The men who are engaged in the construction of the cars may direct attention to methods or devices which are an aid in their work, or may suggest to the designer how he may assist them in securing better results. The men who are engaged in repairing and maintaining the equipment can tell how this may be performed to the best advantage by either describing the methods in use, the appliances which it is best to use, or going into other details in which they are specially interested. In many cases they can make valuable suggestions to both the designer and constructor as to the reduction in expense of maintenance or better protection to the material which is transported in the cars, which may be made possible by improving their methods or modifying the design. These are only a very few suggestions. There are hundreds of other subjects which are of equal interest and which if properly handled will prove of great interest and value to the car department at large. In periods of heavy traffic and congestion, such as we are now experiencing, it is of vital importance that every piece of equipment be available for service as great a proportion of the time as possible, and it is at times like these that the weaknesses in the equipment are most evident. What are these weaknesses and how may they be overcome? What steps should be taken to keep the cars off of the repair track, and, if it is necessary for them to go there, what methods and devices may be used for getting them back into service at the earliest possible moment? In addition to the first prize of \$50 for the best article, any other articles accepted for publication will be paid for at our regular space rates.

The Mechanical Engineer

In a paper on "Specifications," presented before the Western Railway Club, December 17, 1912, by O. S. Beyer, Jr., the statement was made that the preparation of good, thorough specifications is the duty of the mechanical engineer and his staff, collaborating with the engineer of tests and the practical men in the field. This is undoubtedly desirable, but there are many conditions which tend to work against its obtaining in practice, even on the larger roads. As stated in the paper, limitation of staff is one of the most serious drawbacks, and the savings that can be effected by a properly equipped and organized drawing office are generally of such a nature that they cannot be shown in concrete form and thus used as an argument against an increased first cost resulting from adequate specifications.

There have been, and unfortunately still are, many higher officers who do not seem able to see beyond the question of first cost, and the idea of increasing the first cost a little in order to save on maintenance charges is to them a question entirely outside the limits of consideration. Recently, however, there has been a decided move away from this position, and more and more railroad officers have awakened to the fact that equipment properly designed and built from proper material will result in decreased maintenance charges and claims for damaged freight. This can hardly result otherwise than in greater recognition of the mechanical engineering staff and in its being placed on a higher plane.

Instances have not been altogether unknown in which the mechanical department has been overridden in the purchase of power by a general manager or a vice-president who had in mind only the increase of train loads. This has resulted in some roads being saddled with large engines which were entirely beyond the shop and engine house facilities, resulting in enormous increases in maintenance charges. All things considered, however, there is no doubt but that the mechanical engineer and his staff have

made great progress in the past few years toward the position which they should hold in a railroad organization, although this place is not yet by any means attained.

There are two considerations which work against the mechanical engineer, not only as regards the use of proper specifications but against engineering matters as a whole. One of these is that very frequently locomotives and cars are needed in such a hurry, in order to take care of a rush in business, that all engineering considerations have to be thrown aside and the road takes what it can get. The other is the question of friendship and favoritism between some railroad officers and supply men. That weeks and months of patient work in the mechanical engineer's office may frequently come to nothing because of an order for equipment being given to some friend of an official is a disgraceful condition, but it is nevertheless one which still exists and should be dealt with vigorously.

Cars and Locomotives in 1912

According to statistics published in the *Railway Age Gazette* there were 4,515 locomotives ordered during 1912 or nearly 60 per cent. more than in 1911. In the accompanying table the locomotives ordered for the two years are shown as grouped in classes together with the number fitted with superheaters in each year. The superheaters include devices giving either a high or low degree of superheat. It will be seen that 60 per cent. of the steam locomotives ordered in 1912 were fitted with superheaters as compared with only about 38 per cent. of those ordered in 1911. Of the different types ordered during the year the Mikado or 2-8-2 type is in the lead, and comprises 29 per cent. of the total number of locomotives and 29½ per cent. of the total number of steam locomotives. In 1911 this type was also in the lead, but was much more closely approached by the con-

Type.	1912.		1911.		1912.		1911.	
	Number ordered.	Per Cent. Total.	Number ordered.	Per Cent. Total.	Having Superheaters.	Per Cent.	Having Superheaters.	Per Cent.
Mikado	1,309	29.0	590	20.7	922	70	306	52.0
Consolidation	858	19.0	577	20.2	552	64	223	39.0
Switching	821	18.2	443	15.5	322	39	26	6.0
Pacific	594	13.2	486	13.2	432	73	255	52.5
Ten-wheel	364	8.0	238	8.4	297	82	112	47.0
Mallets	168	3.7	112	3.9	106	63	66	59.0
Mogul	61	1.35	127	4.45	11	18	3	2.5
Electric	75	1.65	133	4.65
Shay	23	.51	15	.52
American	8	.18	27	.95	0	0	0	0
Atlantic	5	.11	9	.33	5	100	9	100
Others	229	5.1	93	3.3	5	2.2	37	40
Total	4,515	100	2,850	100	2,652	...	1,037	...

solidation which this year is again second but with a reduced percentage. In 1911 there were about thirteen less consolidations ordered than Mikados, while in 1912 there were 451 less. An examination of the percentages of the other types shows that there has been comparatively little change in the demand for each with the exception of the American or 4-4-0 type and the Mogul or 2-6-0 type. In both years all of the locomotives of the Atlantic type reported were confined to two railways, viz., the Philadelphia & Reading and the Central Railroad of New Jersey. Of the American type, the eight ordered this year were in each case single locomotives for private lines or unimportant branches. In 1911, however, the twenty-seven of this type ordered included twenty-one for four trunk line railways. It is evident that the American, Atlantic and Mogul types have been practically superseded by other types for new power. This table does not include the experimental Atlantic type engines built by the Pennsylvania which indicate that the possibilities of this wheel arrangement have been by no means exhausted and that it can be made to satisfactorily perform a range of service which it has been generally believed required the use of a Pacific type. While as a coal burner the Mogul is probably superseded for trunk line service, when arranged for oil burning this type has possibilities which should not be overlooked. The same statement also applies to the American type.

Seventy per cent. of the Mikados, seventy-three per cent. of the Pacifics and eighty-two per cent. of the ten-wheelers ordered this year were fitted with superheaters. Comparing this with the percentages of the year previous, the present status of this economizer is clearly indicated. When it is stated that 60 per cent. of the locomotives ordered this year have superheaters it must be remembered that there are included in this 229 locomotives which are grouped under the classification of "other types," and include geared, contractor's and various odd or unusual wheel arrangements, usually of a small size. When these are excluded, this percentage is raised to nearly 63. Probably the most striking figure in this part of the table is in connection with the switching locomotives of which 322, or 39 per cent. of the total number ordered, are to be fitted with superheaters. It is evident that the value of the superheater for this service, which has been largely proved during the past year, is being generally realized.

During the year there were 234,757 freight cars and 3,642 passenger cars ordered from the builders or from the shops of the various railways. Of these 107,887 or 46 per cent. were box cars, 74,505 or nearly 32 per cent. were coal cars and 19,720 or about 8½ per cent. were refrigerator cars. The remainder consists of 12,616 flat cars, 4,951 stock cars, 1,918 tank cars and 13,161 miscellaneous cars. While the statistics show that the wooden freight car is still being built in small numbers, the all-steel or steel underframe car has become almost standard practice. One hundred all-steel box cars were ordered by the Bessemer & Lake Erie during the year and other railways have also ordered experimental equipment of the same type. Experience with all-steel box cars covering several years seems to indicate that the fears of a collection of moisture on the inner face of the sheets with sudden changes of temperature are groundless and that good ventilation will overcome any difficulties of this kind.

While the statistics of passenger cars are not as complete in regard to details of construction as are those on freight cars and locomotives, they show that at least 52 per cent. of the passenger equipment ordered during 1912 was of the all-steel type and nearly 14 per cent. had steel underframes. Practically all of the equipment that has been ordered for use on main lines is included in these classifications. The other cars are largely for the shorter branch lines and the minor railway companies. It is probable that nearly all of the equipment ordered for use in heavy passenger train service is of the all-steel type.

Selection of a Locomotive

The locomotive was considered from a broad engineering standpoint, probably for the first time at any similar meeting held in this country, at the Railroad Session of the American Society of Mechanical Engineers, held on December 5. The paper presented for discussion was by O. S. Beyer, Jr., and was entitled, "Factors in the Selection of Locomotives in Relation to the Economics of Railway Operation." An abstract of the paper and of the discussion is given in this issue. Mr. Beyer was able to but briefly refer to the many conditions that must be considered in designing a new type of locomotive if it is to be perfectly suited for a particular service. Many of these conditions are conflicting and often a compromise must be effected. No definite recommendations were made by the author who confined his remarks to simply pointing out what conditions should be considered.

There is one controlling factor which should determine the design of a new locomotive and that is net cost. It is well known that the large modern locomotive will handle very large trains with a decided reduction in the cost per ton-mile and per ton-mile per hour. But it is also well known that the cost of maintaining these larger locomotives is considerably greater and it is by no means proved that they will operate at the same relative efficiency when considerably underloaded. Thus there arises a question if it is not the wiser and more economical plan to decide on a series of standard locomotives which will be used without material

change for a reasonable number of years rather than to redesign each new lot ordered. The total cost of maintenance is effected very materially by the number of different types and classes in use. Furthermore, as was mentioned by Mr. Vaughan in discussing this feature, the motive power of a road having standards is much more flexible and can be shifted from one part of the system to another without raising the cost of repairs and without crippling the service due to holding an engine in the shop while awaiting the arrival of some necessary part. It has been the experience of those roads that have gone into standardization of motive power most extensively that there need be no reduction of development or experimental work, but that it has been necessary and normal to add a new type or class to their classification every three or four years which, however, will use many of the parts common to other locomotives. It seems that the principal difference between those roads provided with complete standards and others not so provided is that the former spend several years in experimental and development work and finally determine on a thoroughly well fitted design which is decidedly larger and more powerful than the previous standard engines for the same service, while the latter, meanwhile, may have purchased a number of different designs each of which may have been best suited for a particular condition existing at that particular time, and at the end of five or six years they have comparatively small numbers of many different classes scattered over the system. From the standpoint of net cost of furnishing transportation it would seem that the standard locomotives which are best suited to the average conditions of service will prove better than those which are especially designed for some local condition which may change even before the engines have passed their first shopping. In speaking of standard locomotives in this connection it is not to be inferred that a standard design is inviolable simply because it is standard, but it does imply that only such changes are to be made in which the new design will replace a part in such a way as not to affect the other standard parts.

One of the notable events of the year in locomotive design is the demonstration of the possibilities of the Atlantic type locomotive by the Pennsylvania Railroad. The experimental engine built for this purpose carries the largest weight per driving axle of any in this country. But, as was pointed out by Mr. Gibbs in the discussion, it is not the static wheel load alone that should be considered, but the dynamic plus the static. If the weight of the reciprocating parts can be sufficiently reduced there is no objection to raising the wheel load. W. F. Keisel, Jr., in his discussion stated that it will be possible to use a weight of 70,000 lbs. per pair of drivers if the weights of the reciprocating parts are sufficiently reduced. A number of years ago the Master Mechanics' Association adopted a rule for counterbalancing, proposed by G. R. Henderson, in which it was stated that the equivalent of the weight of the locomotive divided by four hundred, in weight of reciprocating parts, could be left unbalanced. If the counterbalance weights on each pair of wheels are carefully weighed this rule is satisfactory. It was stated by Mr. Keisel that one pound of reciprocating weight to each hundred pounds of maximum piston pressure is within the bounds of possibility. This, in connection with Henderson's rule, for Atlantic type locomotives would permit the use of counterbalances for reciprocating parts equal to one-third their weight. If this point is reached a weight of 70,000 lbs. per axle will put no more strain on the rail than is induced by the heavy locomotives now in service where the counterbalance weights are generally two-thirds of the weight of the reciprocating parts.

While the experimental locomotive does not quite reach this weight per driving axle, it carries an unusually large boiler having tubes 13 ft. 9 in. in length and is fitted with a high degree superheater. On the testing plant it gave a maximum indicated horsepower of 2,355, and when operating at a horsepower of over 2,000, a minimum steam consumption of 16 lbs. per horsepower hour was attained. The maximum equivalent evaporation of the boiler was 16.9 lbs. per sq. ft. of heating surface per hour. These tests

indicate the possibility of one horsepower per 100 lbs. of weight, or for 1½ sq. ft. of heating surface at 80 miles per hour. The results from this locomotive indicate the better engineering which the past year has shown is beginning to be applied to the locomotive as a whole. Locomotive No. 50,000 designed by the American Locomotive Company, was a revelation of what could be done with a Pacific type by careful attention to proportions and of better engineering in the design of various parts. The Atlantic type on the Pennsylvania goes a step further in the same direction. With these as an example it is probable that the coming year will bring forth further surprising results in the capacity of locomotives that are within the normal clearance limits.

It is but beginning to be understood how little is really known of the processes of combustion in a locomotive and the ways of improving it. The firebox end of a locomotive presents a rich field for investigation. With all these possibilities of improvement in mind, the difficulties of determining the design of a series of standard locomotives are great and in preparing the designs it should be kept clearly in mind that it may be desirable to replace various parts or even a complete boiler within a few years. Such alterations, however, by no means interfere with the maintenance of the standards as the term should be applied to locomotives.

NEW BOOKS

Master Car and Locomotive Painters' Association. Proceedings of the 1912 Convention. Bound in cloth. 108 pages. 6 in. x 9 in. Published by the Master Car and Locomotive Painters' Association of the United States and Canada, A. P. Dene, Secretary, Reading, Mass.

The forty-third annual convention of this association was held in Denver, Colo., September 10-13, 1912. The most important subjects considered were the Finish of the Vestibule Ends; the Report of the Test Committee, which contained valuable information on turpentine substitutes; the Essentials of a Protective Paint-Making Oil; the Use of Interior Car Renovators; the Most Economical Method of Removing Paint from Locomotive Jackets; the Care of Steel Passenger Car Roofs; the Treatment and Finish of Passenger Car Floors; and the Modern Method of Exterior Passenger Car Painting.

Investigation of Explosion Proof Motors. By H. H. Clark. Illustrated. Bound in cloth. 44 pages. 6 in. x 9 in. Published by the Bureau of Mines, Department of the Interior, Washington, D. C.

This pamphlet contains a detailed account of the apparatus used in the tests and the method of testing motors to determine their tendency to cause mine explosions. The term "explosion proof," as applied by the Bureau of Mines to an electric motor, refers to a motor enclosed by a casing so constructed that an explosion of a mixture of mine gas and air within the casing caused by a spark in the motor will not ignite a mixture of the same gas surrounding the motor. Various mixtures of gas were used in the test under various pressures and explosion indicator cards are shown for a number of the tests.

Hygiene for the Workers. By William G. Tolman, Ph.D., Director American Museum of Safety, New York City, and A. W. Guthrie, Department of Research, American Museum of Safety. Illustrated. Bound in cloth. 231 pages. 5½ in. x 7½ in. Published by the American Book Company, New York. Price, 50 cents.

This book is thoroughly practical. In addition to the general topics treated, such as clothing, food and exercise, the subjects of alcohol, tobacco and anti-tuberculosis measures, home hygiene, and the particular necessities for cold and hot weather are considered. The work is divided into 19 chapters, which not only deal with the clothing, cleanliness and general good health from a hygienic point of view, but also from the inherent value it is to a person in the business world. Among the characteristic chapters are: Applying for a Position, Good Habits of the Worker, Food and Drink, Hygiene of the Work Room, After Hours, Choice of an Occupation, First Aid to the Injured, Seasonable Hygiene, etc.

LOCOMOTIVES FOR THE ASSOCIATED LINES

Common Standard Designs Changed to Include the Walschaert Valve Gear and Superheaters.

Between 1903 and 1906 the Union Pacific System-Southern Pacific Company, commonly known as the Associated Lines, adopted a series of standard locomotives which included engines

of classes of Mallets were designed and put in operation. One of these was a very heavy 2-8-2 type and the other a 2-6-6-2 type for freight service. Both of these engines were intended pri-

GENERAL DIMENSIONS AND RATIOS OF SOME OF THE COMMON STANDARD LOCOMOTIVES FOR THE ASSOCIATED LINES.									
Type	2-8-2 Freight	2-6-6-2 Pass.	2-8-2 Pass.	2-8-2 Freight	4-6-2 Pass.	4-6-0 P. & F.	2-6-0 Freight	0-6-0 Switch	0-6-0 Coal
Fuel	Oil	Oil	Lignite	Coal	Oil	Oil	Oil	Oil	Coal
Tractive effort, lbs.	94,640	74,000	51,100	45,300	29,900	36,600	33,300	27,300	27,300
Weight in working order, lbs.	436,200	389,000*	285,000	265,700	221,100	208,750	179,750	145,700	145,700
Weight on drivers, lbs.	400,900	323,000*	214,000	206,500	141,500	162,500	151,050	145,700	145,700
Weight on leading truck, lbs.	17,900	33,000*	25,000	24,800	37,600	46,250	28,700	28,700	28,700
Weight on trailing truck, lbs.	17,400	33,000*	46,000	34,400	42,000
Weight of engine and tender in working order, lbs.	620,000	572,800	456,500	433,000	382,000	346,000	343,000	230,000	230,000
Wheel base, driving, ft. & in.	39-4	11-0	16-6	16-0	13-4	13-10	15-2	11-0	11-0
Wheel base, total, ft. & in.	36-7	51-4	35-2	34-8	33-4	25-10	24-0	11-0	11-0
Wheel base, engine and tender, ft. & in.	90-4	85-1	65-1 1/4	64-7 3/4	68-6 1/4	58-1 1/4	58-8 3/4	43	8 3/4
RATIOS.									
Weight on drivers ÷ tractive effort	4.33	4.37	4.18	4.57	4.72	4.45	4.55	5.34	5.34
Total weight ÷ tractive effort	4.61	5.25	5.58	5.85	7.36	5.71	5.40	5.34	5.34
Tractive effort × diameter drivers ÷ heating surface	959.00	841.00	763.00	617.00	870.00	960.00	1,112.00	896.00	896.00
Total heating surface ÷ grate area	82.30	59.90	60.10	57.00	53.60	75.00	38.50	51.50	51.50
Firebox heating surface ÷ total heating surface, per cent.	4.26	5.58	5.68	5.00	6.80	9.20	8.00	9.00	9.00
Weight on drivers ÷ total heating surface	72.80	70.60	50.60	49.50	53.50	67.00	80.40	93.50	93.50
Total weight ÷ total heating surface	77.50	92.10	67.50	63.50	83.40	87.60	95.40	93.50	93.50
Volume both cylinders, cu. ft.	27.00	25.00	17.20	15.40	12.32	12.32	11.20	8.52	8.52
Total heating surface ÷ volume cylinders	208.00	168.00	246.00	272.00	216.50	195.00	168.00	183.00	183.00
Grate area ÷ volume cylinders	2.54	2.81	4.09	4.76	4.01	2.60	4.42	3.54	3.54
CYLINDERS.									
Diameter, in.	26 & 40	25 & 38	26	23 3/4	22	22	21	19	19
Stroke, in.	30	28	28	30	28	28	28	28	26
WHEELS.									
Driving, diameter over tires, in.	57	63	63	57	77	63	63	51	51
Driving journals, main, diameter and length, in.	11 x 12	11 x 12	10 1/2 x 12	10 1/2 x 12	10 x 12	10 x 12	9 x 12	9 x 12	9 x 12
Driving journals, others, diameter and length, in.	10 x 12	10 x 12	9 x 12	9 x 12	9 x 12	9 x 12	9 x 12	9 x 12	9 x 12
Engine truck wheels, diameter, in.	30 1/2	30 1/2	30 1/2	30 1/2	30 1/2	30 1/2	30 1/2	30 1/2	30 1/2
Engine truck, journals, in.	6 x 10	6 x 10	6 x 10	6 x 10	6 x 10	6 x 10	6 x 10	6 x 10	6 x 10
Trailing truck wheels, diameter, in.	30 1/2	31 1/2	36	36	45	45	45	45	45
Trailing truck journals, in.	6 x 10	8 x 14	8 x 14	8 x 14
BOILER.									
Style	Str.	Str.	Str.	Str.	Str.	W. T.	W. T.	Str.	Str.
Working pressure, lbs.	200	200	200	180	200	200	200	175	175
Outside diameter of first ring, in.	84	80 1/2	82	82	70	72	70	65	65
Firebox, length, in.	126	120 3/4	120 3/4	120 3/4	108	124	108	108	108
Firebox, width, in.	78 1/4	84	84	84	66	37 1/4	66	40 3/4	40 3/4
Firebox, water space, in.	5	5	5	5	5	5	4 & 3/4	4 & 3/4
Tubes, number and outside diameter, in.	250-2 1/4	275-2	275-2	275-2	173-2	204-2	193-2	237-2	237-2
Flues, number and outside diameter, in.	36-5 1/4	36-5 3/8	36-5 3/8	36-5 3/8	24-5 3/8	28-5 3/8	26-5 3/8	26-5 3/8	26-5 3/8
Tubes, length, ft. & in.	21-0	20-6	20-6	20-6	20-0	15-0	12-3/8	11-6	11-6
Heating surface, tubes, sq. ft.	4,164	3,973	3,973	3,973	2,477	2,181	1,734	1,417	1,417
Heating surface, firebox, sq. ft.	240	235	240	208	181	221	151	140	140
Heating surface, feed water heater, sq. ft.	1,222	1,336
Heating surface, total, sq. ft.	5,626	4,208	4,213	4,181	2,658	2,402	1,885	1,557	1,557
Superheater heating surface, sq. ft.	900	865	880	825	480	483	417	417	417
Grate area, sq. ft.	68.4	70.4	70.4	70.4	49 1/2	32.1	49.5	30.2	30.2
TENDER.									
Tank	Semi-cyl.	Semi-cyl.	Water Rot.	Water Bot.	Var. derbit	Vanderbit	Vanderbit	Sloping	Sloping
Wheels, diameter, in.	33	33	33	33	33	33	33	33	33
Water capacity, gals.	9,816	9,816	9,000	9,000	9,000	7,000	9,000	4,000	4,000
Coal capacity, tons.	3,120 g.	3,120 g.	15	15	2,940 g.	2,940 g.	2,940 g.	6	6

* Estimated.

of the Atlantic type, Pacific type, ten-wheelers, consolidations, moguls and six wheel switchers. No radical changes or additions were made to these locomotives up to 1909, when two

marily for the Southern Pacific Company and were oil burners. In the following year several more classes were adopted; these included a Mikado freight locomotive, a Mikado passenger loco-

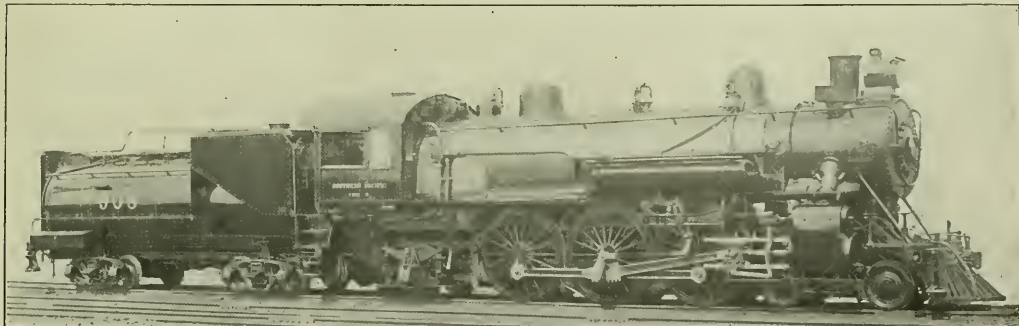

Standard Light Pacific Type Locomotive for the Associated Lines.

motive and a heavier Pacific type. During this year there was also designed an oil burning locomotive of the eight wheel type which has 100,000 lbs. on drivers, 20 in. x 26 in. cylinders and 73 in. driving wheels. A somewhat more powerful 2-6-6-2 type passenger locomotive was also built that year and the Mallet 2-8-8-2 type design was revised. The passenger engines were arranged to run with the cab ahead.

Meanwhile the original standards were maintained and addi-

exception of the Walschaert valve gear, superheater and radial stay boiler; two types of Mikado locomotives, one for freight and the other for passenger service and two types of Mallets in addition to the new eight wheel type mentioned above.

While this comprises the standard locomotives for the Associated Lines, it is not to be understood that experimental and development work has been throttled by their existence. There are in service several locomotives which are not standard and are

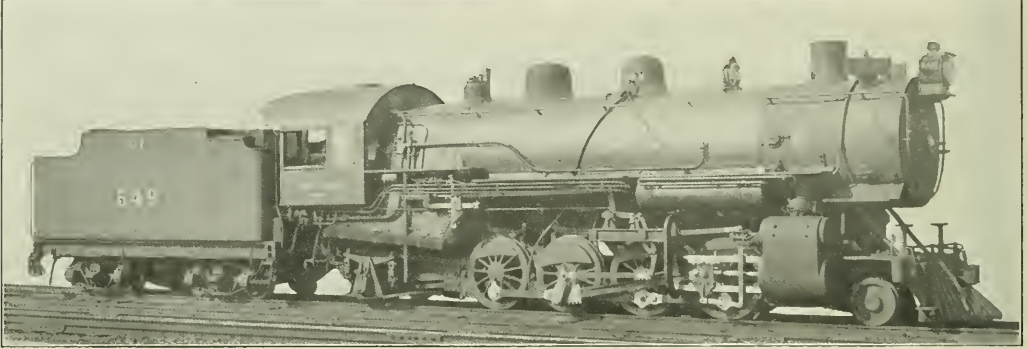

Standard Mikado Locomotive With Superheater for the Associated Lines.

tional locomotives were purchased with but minor alterations, as the service demanded. During 1911 and 1912 changes were made in all designs which had not been previously fitted with the Walschaert valve gear, and this gear is now standard on all locomotives with the exception of the consolidation and Atlantic types. The boilers have been arranged to permit the application of high degree superheaters in practically all classes that are now being built.

The common standard types of locomotives at present are

intended for special work in certain districts. The most noticeable of these is the lignite burning Pacific types of the Oregon Railroad and Navigation Company and the balanced compound Atlantic types for the Union Pacific.

During 1912 one hundred and fifty-six locomotives were built for the Associated Lines by the Baldwin Works, and forty by the American Locomotive Company, all of them being of the modified and present standard for each type. These consisted of 36 switching locomotives; 55 freight Mikados; 10 passenger

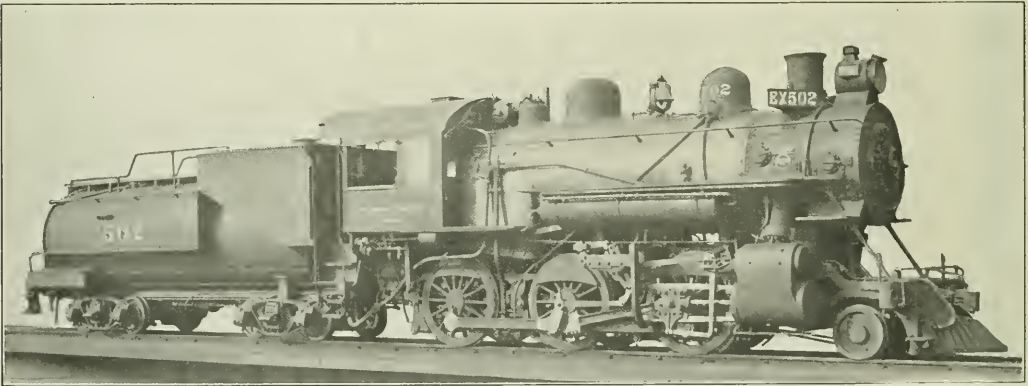

Mogul Locomotive With Superheater for the Associated Lines.

therefore the original Atlantic and consolidation types with Stephenson valve gear and without superheaters; the original six wheel switching type to which the Walschaert valve gear has been applied; light and heavy Pacific types with Walschaert valve gear and superheaters; two classes of ten wheelers, one for oil burning with a narrow firebox and the other with a wide firebox for coal burning, the latter being built with either 63 in. or 69 in. wheels, but without other change (both of these have superheaters); a mogul which is the original design with the

Mikados; 55 Pacifics; 15 moguls; 10 ten-wheelers and 15 Mallets of the 2-8-8-2 type. The general dimensions of these locomotives, as well as the latest design of the 2-6-6-2 type, are given in the accompanying table which by the comparison with the dimensions as given on the original locomotives to be found in the *American Engineer*, as noted, will show what alterations of weights and proportions have followed the changes in the boiler and valve gear.

Possibly one of the most interesting of these locomotives is the

mogul type which is fitted with a superheater, outside steam pipes and Walschaert valve gear. These engines have a tractive effort of 33,300 lbs., 21 in. x 28 in. cylinders and 63 in. drivers. There has been no reduction in the steam pressure in connection with the application of the superheater. The 70 in. boiler has flues 12 ft. 8 in. in length and if the superheating surface is figured on each sq. ft. being equal to 1½ sq. ft. of evaporative heating surface, there is over 224 sq. ft. of equivalent heating surface to each cubic foot of cylinder volume. It is quite evident that this design of locomotive, equipped for oil burning, will be very efficient up to the limit of its drawbar pull.

The Mikado freight locomotives are coal burners and are evidently fully capable of undertaking heavy work at moderately high speeds. The boilers provide 358 sq. ft. of equivalent heating surface per cubic foot of cylinder volume, which is an unusually high ratio for a freight locomotive. They are fitted with brick arches and do not differ from the design already in service with the exception of the changes in the boiler.

In the Mallet locomotives the separable boiler with feed water heater has been retained but the smokebox reheater has been discarded and a high degree superheater has been applied. The header of the superheater is placed in the chamber between the boiler proper and the feed water heater, and the steam pipes pass out through the sides of this chamber and extend back along the boiler between the cylinders. They are fitted with expansion joints. These locomotives are arranged to run with cab ahead.

(Note.—For full description with illustrations of the different details of the common standard locomotives adopted in 1903 see *American Engineer and Railroad Journal*, 1905, pages 154-200-250-288-322-353-400-441. A photograph and brief description of the Pacific type will be found on page 104 of the 1906 volume, and of the Atlantic type on page 139 of the same volume. A balanced compound Atlantic type which is standard in all particulars with the exception of the cylinders, valve gear, axles, etc., is described on page 308 of the 1906 volume. Oil burning locomotives of the ten-wheel type for the Southern Pacific are described on page 408 of the 1907 volume. In the 1909 volume, on pages 181 and 367, is a full description of the 2-8-8-2 type Mallets designed in that year. A lignite burner of the Mikado type built for the Oregon Railroad and Navigation Company is illustrated and described on page 404 of the 1910 volume, and on page 256 of the 1911 volume will be found a description of the Pacific type for the same company, arranged for burning lignite. The 2-6-6-2 type passenger locomotive is described on page 406 of the 1911 volume.)

SLATER FRONT END

It has been found quite difficult with the present design of locomotive front ends to keep the netting and baffle plates sufficiently tight to prevent live sparks from working their way through them to the stack and thence to the ground, endangering the surrounding country with fires. To prevent this, the Chicago & North Western some time ago tried out a new arrangement of front end which was originated by William Burdett, foreman boilermaker of the Northern Wisconsin division, and perfected and patented by F. Slater, master mechanic of the Peninsular division. This has proved entirely satisfactory. With this design the joints can be made tighter and are less affected by the heat and vibration, there being less complicated and difficult connections.

The engines running in the wooded territory have been gradually equipped with this device since January, 1911, with a remarkable decrease in the number of fire claims due to sparks from the locomotive. The amount paid for these claims was \$129,250 for the fiscal year ending June 30, 1911, and \$63,787 for the year ending June 30, 1912, or a decrease of about 50 per cent. While this decrease cannot be said to have been wholly due to the application of this device, the greater part of it is.

Before adopting it as the standard front end a test was made on a ten-wheel locomotive by H. T. Bentley, principal assistant superintendent of motive power and machinery, who was accompanied by Prof. J. G. D. Mack of the University of Wisconsin and E. M. Griffith, state forester of Wisconsin. It was found that over a distance of 58 miles from Green Bay, Wis., to Oshkosh the observers counted only 22 live sparks, all of which died out before striking the ground. During the test the engine was made

to work as hard as possible so as to present the most unfavorable conditions.

In addition to the spark reducing feature, it has been found that engines equipped with this front end are freer steamers and that the coal consumption is materially reduced. While there have been no distinct tests regarding this point, the engineers claim that in most cases they can cover their runs with from 5 to 10 per cent. less coal than before. This is due perhaps to the open and less restricted construction in the smokebox which allows a freer draft through all the boiler tubes and involves less liability of the flues becoming clogged.

It was found that a larger netting area could also be obtained with this front end which also will tend toward better draft. The accompanying table shows the difference, in sq. in. of netting area per flue, between the old and the new arrangement on some of the North Western engines:

Type of Engine.	Old.	New.
Class A—4-4-0.....	8.566	9.64
Class B—4-4-0.....	7.054	8.32

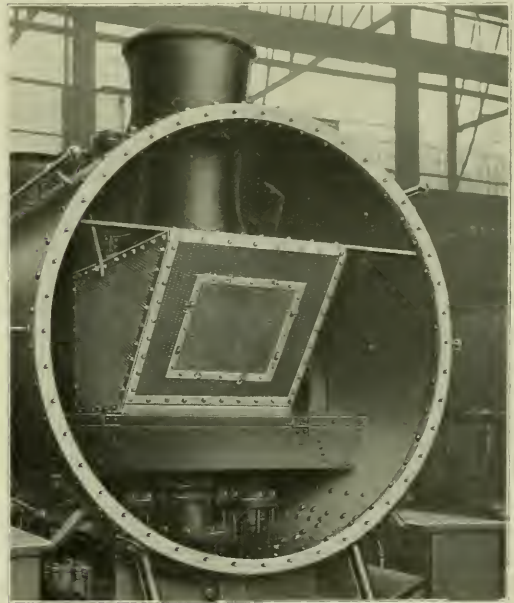

Slater Front End Which Has Proved Efficient as a Spark Arrester.

Class D—4-4-2.....	8.375	9.77
Class E—4-6-2.....	6.5	9.06
Class I—2-2-6-0.....	11.746	12.72
Class M—1-0-6-0.....	11.34	12.28
Class R—1-4-6-0.....	8.376	11.63
Class Z—2-8-0.....	6.685	9.43

The construction of this front end is simple and compact, and is as cheap to make and install, if not cheaper, than the ordinary type of front end arrangement. It is possible to inspect all its parts without having to remove various nettings, plates, etc., and any repairs are easily made. There are no difficult joints to be made around the steam pipes. Everything is straightforward work, all parts being made to a template.

The drawing shows the Slater front end applied to a consolidation locomotive (Class Z), and although the method of applying the device will vary with different types of engines, the arrangement is typical. There is a diaphragm A of 3/16 in. plate, extending across the smokebox under the steam pipe tee and down to the base of the netting box, which deflects the smoke and cinders down under the box and against the deflecting plate

B. With this arrangement of the diaphragm no holes are cut through it for the steam pipes. The sides and inclined front of the box are made of No. 14 perforated plate with the perforations running horizontally, the customary netting door being provided as shown in the photograph. A 3/16-in. table plate extends across the lower part of the smokebox on a level with the top of the exhaust nozzle. This is cut away in the center so that the nozzle may be removed; a small plate is bolted to the tip as indicated at C, giving an absolutely cinder-proof construction.

The blower connection is made in the exhaust tip at D just below the bottom plate so that it will not be necessary to run the pipe through the sides of the netting box. The petticoat pipe is fixed to the top and bottom table plates. The stack and the netting box are connected by a malleable iron collar made in halves and riveted to the angle on the top of the box. A clamp collar is placed outside of this collar and is tightened so as to cover the joints in the inside collar. This clamp collar also protects this connection from abrasion due to the action of the cinders; it is shown in position in the photograph. About 70 per cent. of the engines of the North Western and practically all of those running in the wooded sections have been equipped with this front end.

DRIVING BOX LATERAL PLATE

By H. A. HERNDON,
Chief Draftsman, Fort Worth & Denver City, Childress, Tex.

A driving box hub or lateral plate which can be renewed without dropping the wheels is being used with good results on the Fort Worth & Denver City. The plates are cast of brass and are made to standard sizes, having a rough fit in the edge of the counterbore and around the crown brass. They set in a recess

in the box and are held in place by two tap bolts at the sides. Properly shaped lugs on the plate extend over the edge of the box for this purpose. Only the face and back of the plate and the inside of the lugs are machined.

All that is necessary to remove or apply a plate is to remove

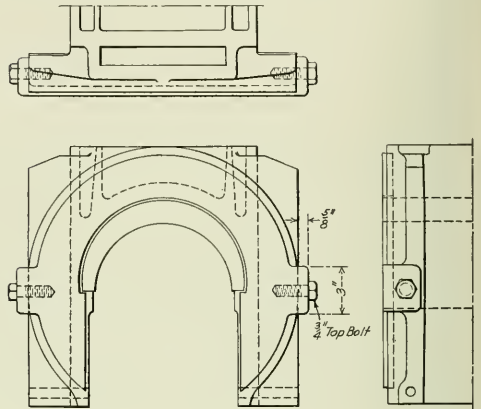

Removable Driving Box Lateral Plate.

the tap bolts, drop the shoe and wedge, move the box inward on the axle and lift out the old plate and put in a new one. The idea originated with I. L. Kelly, shop foreman of the Fort Worth & Denver City at Childress, Tex.

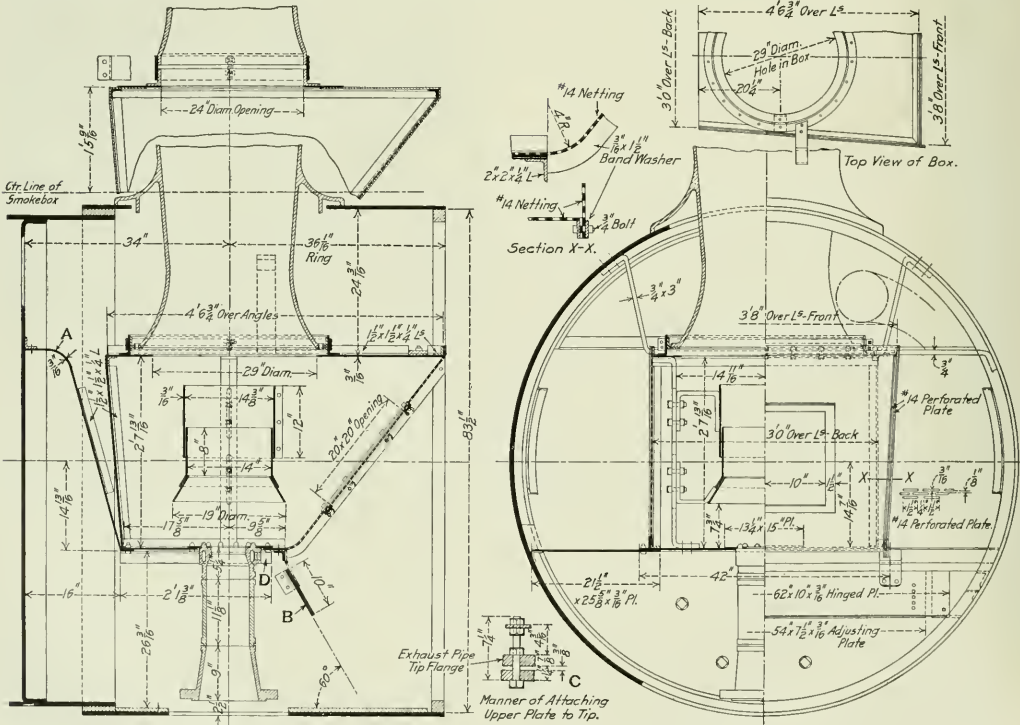

Slater Front End as Applied to a Chicago & North Western Consolidation Locomotive.

FACTORS IN THE SELECTION OF LOCOMOTIVES

Discussed From a Broad Engineering Standpoint
by the American Society of Mechanical Engineers.

Two papers were presented at the Railway Session of the American Society of Mechanical Engineers, held in New York on December 5, 1912. The first on Train Lighting by Messrs. Currie and Wood was published, in abstract, in the December issue of the *American Engineer*, page 614. The second, by O. S. Beyer, Jr., was entitled, Factors in the Selection of Locomotives in Relation to Economics of Railway Operation. An abstract of the paper and a report of the discussion follows:

MR. BEYER'S PAPER.

The problem of locomotive design is comparatively simple when it is clearly known what is desired. The possibility of effecting operating results by the introduction of improved locomotives alone, or by their use in connection with such changes as grade revision, is not as fully appreciated as it ought to be. To make an intelligent selection of motive power for a railroad, it is necessary to study the effect which various types and sizes of locomotives will have on operating expenses and fixed charges. Statistics published by the Interstate Commerce Commission covering the entire railroad field of the United States show that 55 per cent. of the operating expenses are affected more or less directly by the motive power.

The wide range of motive power now available will have to be considered in future double track and relocation work, grade reduction, elimination of rise and fall, and curvature and distance, in order to effect the greatest economy possible for the capital expended. It should no longer be necessary when relocating a division to increase its capacity and reduce operating expenses, to go to extremely heavy capital expenditures to reduce grades to the minimum of 0.2 or 0.3 per cent., as it is usually much cheaper to provide locomotives of greater power.

The main steps in the careful selection of motive power may be divided into the consideration and study of: the service; the nature of the business; the topography of the road, train speed and train resistances; the types and sizes of locomotives available; the improvements to the permanent plant; the effect of various types and sizes of locomotives on operating expenses; and the final selection of most economical type and size of locomotive.

Passenger Engines.—Grades, speeds, and train resistances must be very thoroughly considered when new passenger engines are to be purchased. The most essential quality to be provided in a passenger engine is the ability to maintain large sustained tractive efforts at high speeds, as well as high starting efforts at low speeds. This ability of a passenger engine is secured by providing ample boiler capacity and good steam engine efficiency.

Freight Engines.—Freight and pusher engines are engaged in a service which requires at the critical time very high tractive efforts at slow speeds. This depends to a large extent upon the weight placed on the drivers and the total weight of such engines must thus be so distributed that a relatively large weight falls on the drivers. Modern conditions demand an increase in fast freight service and relatively large sustained tractive efforts at high speeds over heavy grades are becoming more necessary than ever. Locomotives for fast freight service only may afford to sacrifice some initial tractive effort for the sake of having recourse to a proportionately larger heating surface when great quantities of steam are necessary at high speeds. Pusher engines and road engines, on the other hand, intended exclusively for slow service may be permitted to have a large tractive effort capacity at slow speeds with a sacrifice in high sustained tractive efforts at high speeds.

Consideration of the topography of the railroad and the hauling capacity of freight locomotives presents the problem of

permissible train lengths. If the territory over which the locomotives are to operate is, to a large extent, a succession of many sags and pitches and contains several momentum grades, the continual running in and out of the slack between the cars is a serious matter and tends to limit the length of the train and the amount of tonnage per train which can be hauled. The nature of the business, whether it is ore, coal or pig iron moving in high capacity modern steel cars, or general merchandise moving in box cars, refrigerators, small capacity gondolas or other similar cars has a further bearing on this feature. The lower the average total car weights of trains the longer the trains when large amounts of tonnage per train are hauled. Most of the extremely long trains are running over territories whose grades are low, or which have no broken profile. Furthermore the nature of the lading hauled in these exceedingly long heavy trains, is such that, should any heavy shocks occur, the lading cannot be damaged. Cars filled with automobiles, furniture, or general merchandise or flat cars loaded with agricultural machinery are different and must be handled with greater care in shorter trains. Every district for which motive power is intended presents certain little peculiarities when advisable train lengths are considered. Experience in the operation of trains hauled by the older types of locomotives must assist in determining the final answer to this question.

SIZES AND TYPES OF LOCOMOTIVES.

The Atlantic and Pacific type engines, under modern operating conditions, are, for high-speed and high-capacity passenger service, the most desirable types. Under certain special circumstances, long continuous opposing grades may justify compounding in connection with these engines. The introduction of the high temperature superheater and the sectional brick arch have helped materially to increase the capacity, fuel economy, and efficiency of passenger engines. The limitations of Atlantic and Pacific type passenger engines are principally controlled by the permissible wheel loads. When 60,000 to 63,000 lb. per pair of drivers is once reached, it is questionable, from many points of view, whether it is wise to go still higher. Hence, when greater tractive efforts are necessary than can be secured from an engine with 180,000 to 190,000 lb. on drivers it becomes a question of either reducing schedules, double heading, or introducing locomotives with an additional pair of drivers.

Recent developments have made available an exceptional field from which to select locomotives for freight service. It seems limited not so much by the extent to which it is possible to build freight engines as it is by the physical restrictions of the permanent way, the nature of the freight business hauled, length of trains, and topography of the road. These limitations are, of course, mostly very serious, and, as far as track gage is concerned, insurmountable, except perhaps in some special cases.

Many moguls (2-6-0), ten-wheel (4-6-0) and Prairie (2-6-2) type locomotives are in freight service today. Their capacities, especially the mogul and ten-wheel types, are hardly adequate for modern service conditions. The Prairie type, due to the possibility of equipping it with a liberal boiler and liberal grate area, has a few advantages over the others.

The type of locomotive which has been the standard on many of the American railroads in the past ten years is the consolidation type. It has been called on to perform in services ranging from emergency passenger to slow heavy pusher and switching service. Engines of this type are being built for heavy and exacting freight service and their possibilities have not been exhausted. They utilize nearly the total weight of the engine for adhesive purposes. A leading truck of two wheels only is

provided permitting of a slightly extended boiler and taking from the drivers only weight enough to secure good guiding qualities. The steaming capacity, firebox size and grate area are necessarily limited, since the entire boiler and firebox must be carried over the drivers. The handicap imposed by the boiler limitations has not, until recently, been very serious.

Engines of the consolidation type, having a maximum tractive power of 60,500 lb. are in service today. The diameter of their drivers is small, 54 in., and their total heating surface compared with the equivalent heating surface of a Mikado engine having the same tractive effort is but 70 per cent. The piston speeds of these large consolidation engines, compared with the Mikado engine, are considerably higher.

The perfection of the high temperature superheater, the brick arch, and the Gaines combustion chamber opens up further opportunities for the consolidation engine. The application of the superheater results in increased capacity which corresponds, roughly to a 25 per cent. larger boiler capacity than it was possible to provide in connection with saturated steam engines. The brick arches permit increased amounts of heat to be utilized from the fuel burned on restricted grate areas. It should be possible to build consolidation engines with good steaming capacities and economical fuel requirements that can develop as high as 54,000 lb. maximum tractive effort.

An offshoot from the successful consolidation freight engine is the 12-wheel or 4-8-0 type. This type has an undesirable ratio between total weight and adhesive weight. The increase in the length of boiler made possible by the four-wheel truck nets but little in the direction of increased boiler capacity. The increase in the heating surface of the boiler is at the wrong end. To improve the steaming capacity of the consolidation engine it is necessary to introduce modifications at the firebox end.

The introduction of such modifications has resulted in the Mikado (2-8-2) type. By placing a trailing truck underneath the firebox better boiler construction becomes possible; also a decided increase in effective heating surface, a deeper throat sheet and wider water legs are secured. However, as large a proportion of the total weight of the engine is not utilized for adhesive purposes as with the consolidation type. By moving the firebox behind the drivers, it also becomes possible to enlarge the boiler diameter, and to increase the relative diameter of drivers, thereby permitting of lower piston speeds. The general construction of the Mikado locomotive is such that it permits of very ample steaming capacity and thus of high sustained tractive efforts. The application of the superheater and brick arch has further increased its capacity in this direction. It is most admirably suited to haul slow maximum tonnage freight trains one day and fast freight trains the next, a condition frequently met in railroad operation.

The size of Mikado locomotives for most roads is principally limited by the allowable weights on drivers. It seems to be generally considered that an individual axle load of 60,000 lb. for the better conditions of roadbed, as they are met with today, is very nearly the largest permissible. If so the Mikado engine, as far as size is concerned, has very nearly reached its limit, and the demand for still larger engines will have to be met either by introducing another pair of drivers, making five pairs in all, or by resorting to the Mallet type.

To get still larger capacities than are provided by the consolidation and Mikado types, the decapod (2-10-0) and the Santa Fé (2-10-2) types are available. The decapod type, like the consolidation and 12-wheel types, has limitations as regards boiler capacity, in consequence of which it is practically adapted to slow service only. Its high proportion of weight on drivers, giving it a high ratio of adhesion is of advantage for this kind of service. The Santa Fé type permits of better boiler proportions than those of the decapod type, just as the Mikado is better than the consolidation. The additional pair of drivers enables a tractive effort about 20 to 25 per cent. greater than can be

secured from the Mikado engine. Allowing 60,000 lb. per pair, the maximum tractive effort possible should be about 73,000 to 75,000 lb., barring cylinder limitations. Several engines of this type now in service deliver a maximum tractive effort of 71,000 lb. It is reported that they can be handled by one fireman without unduly taxing him.

Locomotives with five pairs of coupled wheels have an exceedingly long rigid wheel base. This would introduce many complications should they be placed on territories where track curvature is frequent or severe. Furthermore, the exceptionally heavy pressures on the main pins and the heavy reciprocating parts justify expectation of maintenance difficulties. The long wheel base and the large number of heavy wheel loads in rigid order may be proportionately harder on the track than is the case with large Mikado engines.

Another type of engine which deserves consideration for freight service is the Mountain (4-8-2) type, which is similar to the Mikado in all its characteristics. Where fast freight service is abundant and high speed is frequent the additional advantages in guiding qualities secured by the four-wheel leading truck and the slightly increased boiler capacity are important.

The Pacific type engine for exclusive fast freight service, where grades are not severe and where this kind of service is heavy, is a very desirable type. A large number of these engines have been built for this service and are giving an excellent account of themselves.

The Mallet type offers quite as wide a field to choose from as the non-articulated types. They can be built to deliver a maximum tractive effort of 140,000 lb. This means an engine with ten pairs of drivers, having an average load of about 60,000 lb.

THE PERMANENT PLANT.

The permanent plant of a railway as related to the motive power is the track, bridges, passing sidings, terminal yards, engine terminals, including the roundhouses, turntables, coaling stations, watering cranes, ash plant and sanding facilities, and the locomotive repair shops. It has been shown what a wide range of motive power is available from which selections may be made for any class of service. In order that the possibilities of this large field may be fully realized it becomes necessary to study carefully the various changes in the permanent plant to be considered in connection with the introduction of different types and sizes of engines. Such a study will oftentimes show that improvements made to the permanent plant at limited costs will permit of utilizing motive power which will effect a considerable saving in operating expenses, thereby fully justifying the expenditure.

OPERATING EXPENSES.

The effect of the selection of locomotives for passenger and switching service on operating expenses does not play as important a role as it does in the selection of engines for freight service. The choice of passenger and switch engines is determined very largely by imposed conditions resulting from circumstances peculiar to the nature of these two kinds of service.

In the selection of power for freight service the effect of the various types and sizes on the operating costs should go a long way towards determining the most economical engine to choose. A study should be made to determine which type and size will effect the greatest net saving in operating expenses after deducting all overhead and additional maintenance charges resulting from the improvements necessitated by the introduction of the engine. Only by such a study as this in conjunction with considering the service conditions and the tendency of future development can the ultimate selection be made with any degree of correctness.

Fuel is the largest single item of locomotive operating expenses and therefore the most important. As locomotives grow larger their fuel consumption per unit increases, but not nearly in proportion to the increase in their size. It does not take very much more coal to fire a large locomotive than a small one. The fuel

losses of a large locomotive due to radiation while waiting or drifting are but slightly larger than those of a smaller locomotive. The increase of fuel consumption of large saturated simple steam engines when working at their full capacity is more nearly in proportion to the increase in their size. The introduction of the superheater, feedwater heater and reheater, the increase in heating surface of the boiler, the brick arch, the utilization of compounding in large engines of the Mallet type, application of improved valve gear and compound air pumps, and more careful attention to the design of steam passages and steam engine efficiency have accomplished remarkable results in keeping the fuel consumption of large locomotives down so that their consumption per train-mile is increased but slightly over that of the recent types of smaller saturated steam locomotives.

Numerous tests and service records have revealed that large superheater Mikado locomotives which have been placed in service recently haul trains of 45 and 50 per cent. greater tonnage with the same amount of coal that was formerly consumed by the consolidation locomotives they replaced. Even the coal consumption of Mallet engines with grate areas up to 100 sq. ft. has not grown in any way proportionate to the increase in their hauling capacity. Modern engines when running at shortened cut-offs over those portions of the road other than the ruling grades exhibited a still greater economy than when working on the heaviest grades. Some service tests of recently built Mikado engines on the Delaware, Lackawanna and Western clearly demonstrated these facts. Their economy in fuel consumption as compared with that of the old consolidation type, both operating over heavy grades at full load, was 20 per cent. The economy effected over easy grades while running at shortened cut-offs was 39.3 per cent., almost twice as much. The average was 29.1 per cent.

[The following features were also briefly considered: Water; lubrication of locomotives; other supplies for locomotives; engine house expenses; train supplies and expenses; wages of engine-men; wages of trainmen; locomotive repairs; freight train car repairs; maintenance of track, bridges and buildings; and overhead charges.]

FINAL DETERMINATION OF THE MOST ECONOMICAL LOCOMOTIVE.

Taking each one of the items into consideration, estimating the reduction in train mileage effected by each type, the gross savings in operating expenses effected based on the amounts of business on hand or in sight, and deducting therefrom all overhead charges arising from the additional improvements necessary to make the operation of the different types of locomotive under comparison practical, will reveal which particular locomotive is the most economical in size and type.

As far as a standard engine of any kind for an entire road is concerned the general conditions obtaining will have some bearing. A road may, for instance, be composed partly of divisions whose grades are moderate and partly of divisions whose grades are severe. If the variations are not great a compromise standard might be adopted. If on the other hand there is a large difference, it may be wiser to seek to establish two or three standards and confine them to their particular territory with a view to getting the maximum efficiency from every portion of the property. Then again there are many shorter territories such as pusher grades and divisions through mountainous country, the motive power selection for which is a distinctly local problem. In every case, whether it is the broad problem of establishing standards for the entire system, or selecting an engine for a local territory, the problem might well be reduced to an economic study, comparing several available types and sizes, the extent of the improvements necessary to make their operation practical, and the net savings which it is estimated will be effected by their introduction.

SUMMARY.

In designing new locomotives all of the conditions must first be analyzed and then the design made to suit them. The actual

design of the engine finally chosen may be approached with confidence because of accumulated knowledge and experience. Due to the great possibilities of favorably effecting operating results by building locomotives which are exactly suited to their work, a study of the conditions becomes vitally important. To show what these conditions are has been the object of this paper. The fact that the most powerful locomotives of most approved design are also the most economical should be more generally appreciated. It is to be hoped that the future will see more advantage taken of the modern locomotive in accordance with its possibilities in relation to grade revision and its ability to reduce operating expenses to a minimum. The ultimate benefits which will result will certainly be justified to the fullest extent.

DISCUSSION

COMMON STANDARD LOCOMOTIVES.

H. H. Vaughan, assistant to the vice-president of the Canadian Pacific, emphasized the importance of having standard locomotives and maintaining these standards until conditions change so much that it is possible to design another line of standard locomotives, making a distinct step in advance, rather than to modify the standard types from time to time. The time for standardization is before the equipment is built and not afterward. The Canadian Pacific now has about 865 standard locomotives out of a total of 1,800 or 1,900 on the system. It is always possible to introduce changes in the design of details on standard locomotives, bearing in mind that the new arrangement must be made so that it can completely take the place of the old part for renewals or repairs.

The advantage of standardizing the motive power may be summed up as follows: The standard locomotives can be transferred from one part of the road to another, when business becomes heavy on one section, without having to provide a new storehouse stock, or have the power crippled because of not having the proper parts in stock. It is also possible to keep the shop cost of the engines down because of fewer variations in the size and design of the parts. Where standard locomotives are used it has been found that the division officers are much more likely to offer suggestions as to improvements. Of course, the standardization has disadvantages, one of which is that it is not always possible to immediately take advantage of improvements in the permanent plant. The advantages of having common standards which can be used on any part of the system and with which the men over the entire system are familiar, greatly offset this, however.

POSSIBILITIES OF ATLANTIC TYPE.

In speaking on the possibilities of the Atlantic type W. F. Kiesel, Jr., assistant mechanical engineer of the Pennsylvania Railroad, said:

"To determine the possibilities, the limitations must first be known. The limitations of paramount importance with a locomotive are those governed by the carrying capacity of the track and roadbed. Assuming a good roadbed, having 22 in. spacing of ties and 100-lb. rail, it will be possible to use a weight of 70,000 lbs. per pair of drivers. The maintenance of way department will be inclined to say that this figure is too high, but there are possibilities of reducing the weights of reciprocating parts by the judicious use of alloy metals and by careful design, resulting in reduction of counterbalance, which in turn reduces the strain on the rail. One pound reciprocating weight per 100 lbs. of maximum piston pressure is within the bounds of possibility. For an Atlantic type locomotive this would permit using counterbalance for reciprocating parts of one-third their weight. At very high speed there would be no more strain on the rail than that induced by heavy locomotives now in service. The load on front and trailer trucks may be taken at 110,000 lbs. The total weight of this imaginary Atlantic type locomotive would then be 250,000 lbs.

"There are few possibilities of improvements in the engine it-

self. The utilization of heat-treated steel and cast-steel cylinders will reduce weight, which reduction can be used for increase in boiler. The development of the possibilities of the boiler will bring about improvements of greatest import. The superheater and brick arch have already raised the line between non-stoker and stoker locomotives 50 per cent., leaving all Atlantic type locomotives well within the non-stoker class. The indications are that great steaming capacity can best be obtained with flues of moderate length, and that the generally accepted theory that long flues increase boiler efficiency is not altogether correct.

"Before further developing this imaginary locomotive permit me to present some average figures obtained from an Atlantic type locomotive, on the Pennsylvania Railroad locomotive test plant, at Altoona, Pa., as a basis for possible boiler performance. The general characteristics of the locomotive tested are as follows:

Weight	237,000 lbs.
Boiler pressure	205 lbs.
Cylinders	22 in. x 26 in.
Drivers	80 in.
Fire heating surface	3,090 sq. ft.
Grate surface	134 sq. ft.
Flue diameter	Outside, 2 in.; inside, 1 3/4 in.
Flue length	13 ft. 9 in.

"The boiler was equipped with a long brick arch, a combustion chamber, and a superheater. Forty tests were made, eight of two hours each, nine of one and one-half hours each, seventeen of one hour each, five of one-half hour each, and one of fifteen minutes. The maximum speed was 360 revolutions per minute. In each test the speed, cut-off, pressure, and power developed were maintained as uniform as possible. In the various tests the average indicated horse power developed ranged from 756 to 2,355. Nineteen tests, with average indicated horse power ranging from 756 to 1,700, averaged 2.35 lbs. of dry fuel per indicated horse power. Thirteen tests with average indicated horse power ranging from 1,700 to 2,000, averaged 2.71 lbs. of dry fuel per indicated horse power. Eight tests, with average indicated horse power ranging from 2,000 to 2,355, averaged 3.08 lbs. of dry fuel per indicated horse power. For this last lot of eight tests the average steam per indicated horse power was 17.03 lbs., and the minimum was 16 lbs. The maximum evaporation was 38,846 lbs. per hour, or 12.6 lbs. per square foot of fire heating surface per hour, equivalent to 52,084 lbs. per hour, or 16.9 lbs. per square foot of fire heating surface per hour from and at 212 deg. Fahr. These tests indicate the possibility of one indicated horse power per 100 lbs. weight of locomotive, or for one and one-third square feet of fire heating surface, at 80 miles per hour.

"Returning now to the imaginary locomotive weighing 250,000 lbs.; the weight on drivers, 140,000 lbs., limits the drawbar pull in starting to about 31,000 lbs. The boiler can be made sufficiently larger than that of the locomotive tested to furnish steam for 2,500 indicated horse power maximum, available for short periods in emergency. For trains of the present day more than 1,800 indicated horse power would seldom be required. At 16 1/2 lbs. of steam and 2.5 lbs. of dry coal per indicated horse power, this would require 30,000 lbs. of water and 4,000 lbs. of coal per hour.

"What can be expected from such a locomotive? This question can best be answered by determining how much power is required in fair weather to pull ten cars, weighing 600 tons, assuming that the engine and tender together weigh 200 tons. The starting power is just sufficient to start this train of 800 tons on a 1 per cent. grade. The indicated horse power necessary to maintain a given speed under various grade conditions is given in table below:

40 miles per hour on 0.75 per cent. grade.....	2,030 indicated horsepower.
40 miles per hour on 0.5 per cent. grade.....	1,600 indicated horsepower.
50 miles per hour on 0.5 per cent. grade.....	2,175 indicated horsepower.
50 miles per hour on 0.2 per cent. grade.....	1,535 indicated horsepower.
60 miles per hour on 0.2 per cent. grade.....	2,085 indicated horsepower.
60 miles per hour on level tangent.....	1,575 indicated horsepower.
70 miles per hour on level tangent.....	2,160 indicated horsepower.

"From what has been determined above, based on facts, it would seem that 'the possibilities of the Atlantic type locomotive'

are equal to the requirements of present day passenger service, for the locomotive weighing 250,000 lbs., if given 3,300 square feet of *effective* fire heating surface, would be capable of developing a maximum of

2,160 indicated horsepower at 40 miles per hour.
2,280 indicated horsepower at 50 miles per hour.
2,377 indicated horsepower at 60 miles per hour.
2,452 indicated horsepower at 70 miles per hour.
2,510 indicated horsepower at 80 miles per hour.

DYNAMIC WHEEL LOADS.

A. W. Gibbs, chief mechanical engineer of the Pennsylvania Railroad, brought out the fact that too much stress is laid upon the static wheel load and too little on the dynamic load due to the unbalanced weights. The real problem is to reduce the total effect of the static plus the dynamic, and this calls for greater attention to the design of the reciprocating parts. C. D. Young, engineer of tests of the Pennsylvania, who followed Mr. Gibbs, said that the Pennsylvania Railroad had under consideration a design in which it was expected that a material saving would be made in the weight of the reciprocating parts by the use of alloy steel.

BOILER DESIGN.

F. F. Gaines, superintendent of motive power of the Central of Georgia, said in part:

"There are many items to be considered in the proper selection of motive power. I will only call attention, however, to the question of fuel economy and boiler capacity—in other words, boiler design. There have been few radical modifications in boiler design other than the general introduction of superheated steam, except in a few isolated instances. The results obtained by Dr. Goss in the Coatesville tests indicate that there should be greater firebox and heating surface, and that the ratio of firebox heating surface to tube heating surface should be materially increased. With from 40 per cent. to 48 per cent. of the evaporation from the firebox sheets, it would seem logical to increase firebox heating surface and decrease tube heating surface. The results of the Coatesville tests, while a surprise to many, were anticipated by a few. The Philadelphia & Reading has a large number of its engines in which the ratio between firebox and tube heating surface is relatively high (one to six), and with tubes from about nine feet in length on American type passenger power to only 13 feet 6 inches on the heaviest types of consolidation locomotives. These results were obtained by the use of the Wooten type boiler with large grate area for anthracite coal, and a vertical brick wall at rear of the combustion chamber. The brick wall retards the flow of gases and also gives a better opportunity for combustion, as well as changing the path of the gases and forcing them against the crown sheet. The combustion chamber furnishes additional firebox heating surface and more volume in which to complete combustion. These engines, while designed for anthracite coal, occasionally got into soft coal territory and had to use it. The grate area was too large for maximum economy, but the results were excellent, notwithstanding.

"Impressed with the above experience, a trial was made of arranging a boiler having a suitable grate area for soft coal, with a combustion chamber. The back end and one waist course were removed from the original boiler and replaced by a new back end. Carefully conducted tests showed a coal economy of 40 per cent. over a sister engine and 15 per cent. over the best design of engine of similar power, but with more liberal heating surface. In addition to the fuel economy obtained, the shielding of the tubes by the firebox wall has resulted in the engine making over four times the mileage of other engines in the same district before safe ending the flues. During this period the engine has seldom, if ever, been reported to have flues blown, while with certain fuel conditions engines in the same territory have required blowing every round trip.

"The most radical improvement that can be made in the locomotive, and one that will be rapidly developed, is the use of greater firebox volume and heating surface. This is readily ob-

tained by using a suitable grate area and combustion chamber. In fact, from past experience it would not be surprising if ultimately a flue length of 16 ft. would become a desirable maximum, and the combustion chamber be substituted for the remaining distance."

In commenting on Mr. Gaines' suggestion, C. D. Young said that a study of the relation of the length and diameter of the tubes was probably of equal importance with the relative increase in firebox volume and heating surface.

FEED WATER HEATERS.

G. R. Henderson, consulting engineer of the Baldwin Locomotive Works, in commenting on feed water heaters, said: "Recently an extension of the boiler has been converted into a multitubular feed water heater and water from the injector is passed through this section before reaching the boiler proper. As some modern types of locomotives give ample space for a very long boiler, there is no difficulty in providing such a section using the heat after it passes through the boiler tubes proper. Experience with this type of feed water heater has been somewhat peculiar; in some cases very good results were obtained both in economy and in condition of the heater; but in other cases more or less corrosion has been found in the various portions of the heater, whereas there was no evidence of such corrosion in the boiler proper; these conditions have been more aggravated when good water was used than when water carrying scale and encrusting matter was supplied to the boiler. In an attempt to overcome this corrosion, in some cases the heater has been practically coupled to the steam space with circulating pipes both to the top and bottom so that it is really an extension of the boiler and will run only partially full of water instead of entirely full, as when originally designed as a heater. The strangest part of this problem is that we find when such connections are made the apparatus does not seem to lose its economical value as a heater. There is apparently no increase in fuel required when these circulating pipes are connected with the boiler.

"Some builders place a diaphragm sheet a few feet back of the flue sheet and extended as high as the flues, injecting the feed water into this front section and letting it flow backward over the diaphragm as necessary. While we do not know of any comparative tests made to determine exactly the fuel economy of this device, it seems as if this arrangement of connecting the heater directly with the boiler, so that it practically forms a part of it, is likely to be more satisfactory in the long run than when it is used as an individual heater for heating the water in its passage to the boiler without allowing any opportunity for the gases contained in the water to escape, as can be done with the circulating pipes."

SUPERHEATERS.

S. Hoffman, vice-president of the Locomotive Superheater Company, said in part: "Superheaters are being applied to practically all engines now building and the question when selecting new power is not whether a superheater shall be specified or not, but what can reasonably be expected from the application of the superheater to the particular engine in its particular service and what consideration should be given to the design of the superheater and to the general locomotive design in order to obtain a locomotive of maximum efficiency. The principal advantage to be derived from the application of an efficient superheater is a decrease in steam and fuel consumption and indirectly an increase in the steaming capacity of the boiler, which is equal to a proportional increase in the hauling capacity of the locomotive. In speaking of superheaters as applied to locomotives, I refer only to such devices as are capable of developing and maintaining a high degree of superheat averaging from 200 to 250 deg. above the saturation point.

"The principle which has been generally adopted in the design of locomotive superheaters is that of a superheater consisting of coils or units disposed in large boiler flues, with the forward

ends of the superheater units suitably connected with a steam collector casting in the smokebox. The superheater unit pipes go within 2 ft. of the firebox tube sheets and are exposed at their extreme ends to temperatures of from 1,400 to 1,600 deg. Steam of such high degrees of superheat can be exposed to the cooling action of the steam chest and cylinder walls without condensation and at the same time has about 30 per cent. greater specific volume than saturated steam of the same pressure. A large part of this increased specific volume is again lost before the expansion of the steam in the cylinders takes place on account of the cooling action of the steam chest and cylinder walls. While the superheat of the steam leaving the superheater may be 200 to 250 deg., the average superheat of the steam in the cylinder at the moment the cut-off takes place is hardly more than 100 deg.; but the entire elimination of all losses through condensation, together with the remaining increased volume of the steam, effects under average conditions a saving of 30 per cent. and more in the steam consumption per indicated horse power, which gain corresponds to a saving in fuel consumption of from 20 to 25 per cent., compared with a saturated steam locomotive working under the same conditions.

"The real value of a locomotive from the motive power point of view must be ultimately measured by the tractive effort which it is able to exert on the drawbar at a certain speed. In order to bring out what bearing the above mentioned saving in steam and fuel consumption has on the hauling capacity of the locomotive, the following example is given: Assuming two locomotives of the same general dimensions, one being equipped with a high degree superheater. Under average working conditions, the superheater locomotive will show an economy in coal consumption of about 20 per cent., if the same indicated horse power is developed by both engines. If the superheater engine is now forced so as to burn the same amount of coal as the saturated steam engine, and assuming that this increased amount of coal can be burnt as efficiently in the superheater boiler as in the saturated steam boiler and that the increased volume of steam can be expanded in the cylinders as efficiently as in the saturated steam engine, then the indicated horse power developed would be $100 \div 80$ I. H. P. or 25 per cent. more than in the saturated engine. At the ordinary speeds of saturated steam passenger locomotives about 70 per cent. of the cylinder power is available at the drawbar, 30 per cent. being absorbed in moving the weight of the locomotive and in machine friction. As the power consumption for this purpose will not change materially in the two cases, an increase of 25 per cent. in indicated horse power represents an increase in haulage capacity of $25 \times 100 \div 70 =$ approximately 36 per cent.

"The above two assumptions bring us to two principal requirements for the maximum efficiency of superheater locomotives. The thermal efficiency of the boiler must not be reduced by the application of the superheater. With the type of superheater now generally adopted, no changes are made in the firebox, but the tube heating surface is altered by transferring part of it to the superheater. The superheating surface is not quite as efficient in heat transmission as the evaporating surface on account of the poor conductivity of superheated steam. In order to make up for this the steam must be forced to pass through the superheater pipes at high velocity even at the risk of wire drawing, and the superheating surface must be so disposed in the gas current as to offer each cubic inch of gases passing through the superheater more heating surface than the gases find in their passage through the ordinary boiler tubes which are in contact with water. Further, the total gas area through all boiler tubes must not be materially reduced by the application of the superheater and the boiler tubes and flues must be so proportioned and arranged that the stream of combustion gases emerging from the firebox is so subdivided that the necessary amount of gases is diverted through the superheater, in order to furnish the required degree of superheat. These requirements regarding the

subdivision of heating surfaces and gas areas have to my knowledge first been recognized by Dr. Wilhelm Schmidt, of Cassel, Germany, who is also prominently responsible for the introduction of highly superheated steam in stationary and marine practice.

"It is not always possible for the designer to meet exactly these requirements, but from a great many cases it can be said that under average conditions the total gas area through all boiler tubes is not reduced more than about 5 per cent, and the combined total heating surface based on the fire side of the tubes is increased by the same percentage through the application of the superheater. This makes a somewhat sharper draft necessary for the development of the maximum power. The exhaust nozzle of the superheater locomotive has at any rate to be smaller than in the saturated steam locomotive on account of the smaller volume of exhaust steam available. These considerations indicate that the superheater boiler uses the gases of combustion just as efficiently as the saturated steam boiler and therefore as far as the boiler efficiency is concerned it would be possible to make practical use of the above mentioned theoretical increase in hauling capacity.

"The second requirement assumes that the increased volume of steam be expanded as efficiently, or in other words, that the same cut-offs be used as in the saturated steam engine. This would mean a corresponding increase in cylinder dimensions which in many cases is not possible on account of limitations in adhesive weight, strength of running gear and other limitations. There will always be an increase in hauling capacity obtainable, but whether the theoretical maximum can be obtained depends on the size of cylinders, and depends also on the quality of the saturated steam engines with which the superheater engine is compared, or to which the superheater has been applied, whether the engine is correctly proportioned or over cylindered, or deficient in boiler capacity, etc. It depends also on the service in which the locomotives are used; whether the service is such as to be favorable to developments of higher degrees of superheat and more or less unfavorable to the saturated steam locomotive. In switching service superheater engines make a very favorable showing, although only a moderate degree of superheat is being developed, but the improvement in efficiency is so remarkable because the saturated steam engine is the most inefficient of all locomotives. Under all these varying service conditions the increased hauling capacity of superheater locomotives obtained in practical service varies between 20 and 30 per cent., and frequently even more.

"Obviously, any appliance which improves the combustion and raises the firebox temperature will tend to raise the degree of superheat and thus help to increase the efficiency of the superheater. The only efficient device in this respect is a long brick arch, and for this reason the application of brick arches in superheater locomotives is highly recommended. All these considerations indicate that the increased hauling capacity of the superheater locomotive is principally caused by the increased steaming capacity of the boiler.

"The opinion has been frequently advanced that the mean effective pressure in the cylinders is increased by the use of highly superheated steam and that this is the source of the increased hauling capacity of the superheater locomotive. This is not the case. If the superheater engine has the same general dimensions, the same cylinders and boiler pressure, and is worked at the same cut-off and at the same speed as the saturated steam locomotive, it will not produce an indicator diagram showing a higher mean effective pressure than the saturated steam engine. In many cases the mean effective pressure of the superheater locomotive will even be somewhat lower than in the saturated steam locomotive, on account of the expansion line of superheated steam dropping faster than the expansion line of saturated steam. If, therefore, the superheater engine and the saturated steam engine are working under identical conditions and have identical dimensions, the superheater engine cannot develop more drawbar pull than the saturated steam engine. If a large tractive effort at a cer-

tain speed is required, either the cylinders of the superheater engine must be increased or the engine has to be worked at later cut-offs, which again is made possible by the increased steaming capacity of the boiler. It is also evident that without changing the size of the cylinders or the boiler pressure, the superheater engine cannot start a heavier train load than the saturated steam engine.

"On saturated steam engines in many cases the size of cylinders is limited on account of fear of condensation. The superheater engine is not subject to such limitations and, therefore, allows in many cases a better use of the available adhesive weight. In order to increase the starting power, under average conditions, it will be advisable to increase the diameter of the cylinders of superheater engines 10 per cent. above the size of the cylinders of the saturated engine. This will not only correspondingly increase the starting power, but at the same time will make possible the use of the increased steaming capacity of the boiler, without unduly increasing the cut-off of the engine, and in many cases will allow the superheater engine to work with lower boiler pressures.

"Mr. Beyer has shown that locomotives of large capacity are more economical in operation than smaller units. He particularly cited the case of large superheater Mikado type locomotives which haul trains of 45 and 50 per cent. greater tonnage with the same amount of coal that was consumed by the consolidation locomotives they replaced. In order to develop the specified tractive effort these Mikado locomotives had to be equipped with cylinders of 27 in. diameter. What would have become of these poor engines with these big cylinders without the superheater? The cylinder condensation would have been so large as to make the operation of the engines a practical impossibility. There are no other means existing to entirely prevent cylinder condensation but superheaters, and superheating has made the most powerful locomotives with big cylinders possible.

"On Mallet engines built during the last two years superheaters have been quite generally applied, as the large surface to which the steam is exposed in the four cylinders and long steam pipes makes the application of this device even more necessary than in ordinary simple engines in order to prevent the increased amount of condensation. In most cases the superheater has been applied in front of the high pressure cylinder and the steam has been superheated sufficiently high to leave at least 30 or 50 deg. of superheat in the receiver steam. This remaining superheat makes it possible to use slide valves on the low pressure side; high pressure cylinders using steam of a high degree superheat cannot successfully be worked with slide valves.

"Repeated tests have been carried on particularly with a view of applying superheaters to old engines with slide valves, and in all cases which have come to my knowledge it has been found that slide valves cannot be worked successfully with highly superheated steam. Various means have been developed in order to improve the lubrication of the slide valves, but so far all have failed, because highly superheated steam has a tendency to warp the flat valve, which is the principal cause for the rapid wear of its bearing surfaces.

"Regarding the lubrication of piston valve superheater engines, great fear has been expressed as to the difficulties to be expected in this respect, but a great number of superheater locomotives now in satisfactory service, and causing no more wear on piston and piston valve rings and bushings than saturated steam locomotives, indicate that this question can be successfully solved. Two points, however, should be borne in mind in this connection, i. e., that superheater locomotives, working with highly superheated steam, should be lubricated with a cylinder oil having a higher flash point than the ordinary cylinder oil used in saturated steam locomotives, but without losing its lubricating qualities, and further means should be provided to protect the oil against carbonization while the engine is drifting. This protec-

tion can be obtained by the admission of small quantities of steam to the steam chest and cylinders, while the engine is drifting after the throttle is closed. This auxiliary steam can be supplied either by cracking the throttle or by providing an auxiliary steam pipe to the cylinders. The latter can be worked

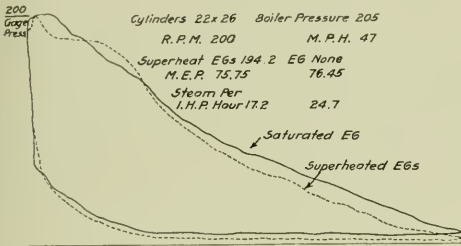

Indicator Cards for Saturated and Superheated Steam Locomotives Working Under the Same Condition as to Cut-off, etc.

by an auxiliary valve in the cab actuated either by hand or automatically.

"In addition to these means of improving the lubrication, it is essential to design all parts working under highly superheated steam so as to cause the least amount of friction and wear. This is being done by using the best quality of close grained iron for bushings and rings and by balancing the rings against inside steam pressures and by the application of piston valve rod guides,

diagrams was for an Atlantic type locomotive with 22 in. x 26 in. cylinders, 205 lbs. of steam, and operating at 47 miles an hour with 200 deg. of superheat. This was compared with the diagram of a saturated steam engine with practically the same cut-off and under the same conditions. As may be seen from the diagrams, the card for the superheater engine showed a steam consumption of 17.2 lbs. per indicated horse power per hour, as compared to 24.7 lbs. for the saturated steam engine.

The other illustrations show saturated and superheated steam indicator cards for equal weights of steam per hour when operating under the same condition. In both cases the greater indicated horse power for the superheater engine is most noticeable.

CHROME VANADIUM DRIVING WHEEL TIRES

Tires made of heat treated chrome-vanadium steel were applied to a Pacific type locomotive weighing 229,500 lbs. total, and 150,500 lbs. on drivers, which was put in service on a division having numerous curves ranging from 3 to 14 deg. The average number of brake applications per trip was nine for station stops and four for crossings and slowdowns. Although flange lubricators were used on the other locomotives on this division none were applied to this locomotive. These tires, after an engine mileage of 121,000 miles, were found to still have good contours, but because of necessary repairs to other parts the locomotive was shopped. A sister engine in identical service had a new set of carbon steel tires applied one month after the vanadium tires were put on and these tires gave a mileage of only 60,040

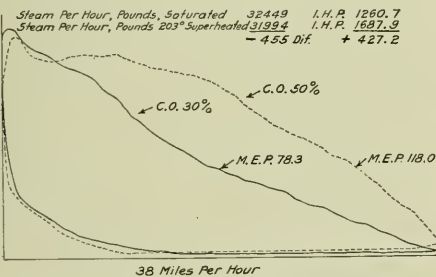

38 Miles Per Hour

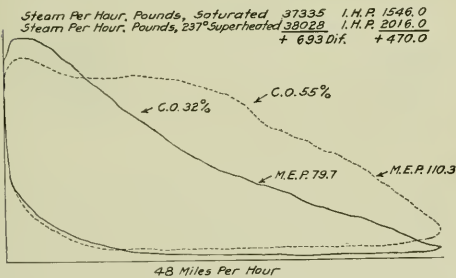

48 Miles Per Hour

Indicator Cards for Saturated and Superheated Steam Locomotives for Equal Weights of Steam Per Hour.

and piston rod guides at the front end, in order to reduce the weight pressing the rings against the bushings."

ADVANTAGES OF SUPERHEAT AS SHOWN BY INDICATOR CARDS.

C. D. Young, engineer of tests of the Pennsylvania Railroad, presented indicator diagrams for both saturated and superheated steam locomotives, which clearly show the advantages of the latter. It is believed that this is the first time that a comparison of this sort has been made. One set of indicator



Chrome-Vanadium Driving Tire After a Drop Test.

miles before having to be turned. It was necessary to reduce the diameter by 3/4 in. in order to build up the worn flange.

In switching service, chrome-vanadium tires have given fourteen months' service, double turn, with a maximum wear of only 1/4 in. It is reported that these tires, which are now on their third term of service between turnings, will probably be good for a fourth term.

Other railways in considerable numbers are now ordering tires of this material, and a specification has been prepared after exhaustive experiment and research by the tire makers and the American Vanadium Company. In developing this specification the effort was to determine the particular chemical composition of chrome-vanadium steel and the proper heat treatment which would give the highest wearing qualities. The success of the

specifications, which are given in full at the end of this article, is illustrated by some tests recently made on tires manufactured under them. Three tires, one each manufactured by the Midvale Steel Company, the Standard Steel Company and the Latrobe Works of the Railway Steel-Spring Company, were subjected to physical and chemical tests with the results given in Table 1. For comparison the properties of carbon steel tires are given in the last column.

TABLE NO. 1.—COMPARATIVE PHYSICAL PROPERTIES AND CHEMICAL COMPOSITION OF HEAT TREATED CHROME-VANADIUM AND STANDARD CARBON STEEL TIRES.

Manufacturer	Physical Properties.				Regular Carbon Tire.
	Heat Treated Chrome-Vanadium Tires.				
	Obtained.		Specified.		
	Standard	Midvale	Latrobe		
Elastic limit, lbs. per sq. in.	119,500	110,000	118,700	110,000 to 125,000	65,000
Tensile strength, lbs. per sq. in.	146,500	136,000	149,520	140,000 to 160,000	125,000
Elongation in 2 in., per cent.	15.5	17.0	15.0	Minimum, 12	12
Reduction of area, per cent.	39.0	48.6	34.4	Minimum, 30	17
	Chemical Composition				
Carbon, per cent.	0.55	0.57	0.62	0.50 to 0.65	0.68
Manganese, per cent.	0.64	0.694	0.62	0.60 to 0.80	0.70
Chromium, per cent.	0.88	0.95	0.95	0.80 to 1.10	0.00
Vanadium, per cent.	0.17	0.20	0.24	Over 0.16	0.00
Silicon, per cent.	0.30	0.289	0.27	0.20 to 0.35	0.250
Phosphorus, per cent.	0.034	0.037	0.015	Not over 0.05	Under 0.05
Sulphur, per cent.	0.04	0.023	0.028	Not over 0.05	Under 0.05

The strength and toughness of heat treated chrome-vanadium steel is clearly shown by the drop tests of each of these tires. A summary of the results secured is given in Table 2. The accompanying illustration shows the tire manufactured by the Standard Steel Works Company after being subjected to the drop test. The tire was 48½ in. internal diameter, 3¾ in. thick. A deflection of 4 3-16 in. was required by the specifications, and a total of 5 5-16 in. was obtained after a total of 37 blows from different heights up to 25 ft.

In the drop test of the Midvale Steel Company, the tire was 55½ in. internal diameter and 3¾ in. thick. All blows were from a height of 40 ft., seven blows in all were given. A total deflection of 5 7-16 in. was obtained, 4¾ in. deflection being required by the specifications. The tire manufactured by the Latrobe Works of the Railway Steel-Spring Company was 56 in. internal diameter and 4 in. thick. Under the specifications a deflection of 3 11-16 in. was required. The total deflection obtained was 5 in., after a total of 22 blows from successive heights up to 30 ft., the limit of the drop.

TABLE NO. 2.—SUMMARY OF RESULTS OF DROP TESTS OF HEAT TREATED CHROME-VANADIUM TIRES.

Maker	Standard	Midvale	Latrobe
Thickness	3¾ in.	3¾ in.	4 in.
Inside diameter before test	48½ in.	55½ in.	56 in.
Inside diameter after test	43⅞ in.	50⅞ in.	51 in.
Deflection required	4⅞ in.	4¾ in.	3⅞ in.
Deflection obtained without breaks or cracks	5⅞ in.	5⅞ in.	5 in.
Maximum drop	25 ft.	*40 ft.	30 ft.
Weight of drop	2,240 lbs.	2,240 lbs.	2,240 lbs.

* Entire test made at this height.

SPECIFICATIONS FOR HEAT TREATED CHROME-VANADIUM STEEL TIRES.

1. Steel for tires shall be made by the acid open hearth process. Sufficient discard shall be made to insure removal of piping and segregation.

2. Chemical Composition:

Carbon	0.50 to 0.65 per cent.
Manganese	0.60 to 0.80 per cent.
Chromium	0.80 to 1.10 per cent.
Silicon	0.20 to 0.35 per cent.
Vanadium	Over 0.16 per cent.
Phosphorus	Not over 0.05 per cent.
Sulphur	Not over 0.05 per cent.

The higher range in carbon to be used for switch and freight engine tires, and tender and car wheel tires; the lower range in carbon to be used for passenger engine tires.

The above limits are rejection limits for samples taken at any stage of manufacture.

3. Drillings from a small test ingot cast with the heat or turnings from a tensile specimen or turnings from a tire (where tires are machined at the works of the manufacturer) shall be used to determine whether the chemical composition of the heat is within the limits specified in Paragraph 2.

4. Physical Requirements:

TIRES OVER 56 IN. INSIDE DIAMETER.

Elastic limit	95,000 to 115,000 lbs. per sq. in.
Ultimate strength	125,000 to 140,000 lbs. per sq. in.
Elongation in 2 in.	Minimum, 15 per cent.
Reduction of area	Minimum, 35 per cent.

TIRES 56 IN. INSIDE DIAMETER AND UNDER.

Elastic limit	110,000 to 125,000 lbs. per sq. in.
Ultimate strength	140,000 to 160,000 lbs. per sq. in.
Elongation in 2 in.	Minimum, 12 per cent.
Reduction of area	Minimum, 30 per cent.

The elastic limit to be obtained by means of an approved extensometer. The ultimate strength is not to be considered as

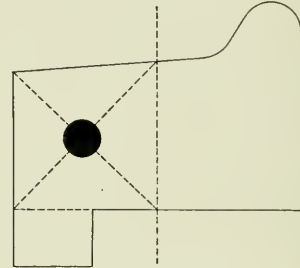

Location at Which the Test Specimen Shall Be Taken.

a requirement, but must in all cases be reported, and should approximate the above ranges.

5. The standard turned test specimen, as shown in the illustration, ½ in. in diameter and 2 in. gage length, shall be used to determine the physical properties as specified in Paragraph 4.

6. Should a falling weight test be required, one tire from each heat shall be selected and tested as described in Paragraph 10. When such a test is made, the tensile test specimen to determine if the steel meets the physical requirements of Paragraph 4 shall be cut cold from the tested steel. The location of this test specimen shall be midway between the tread and the bore and midway

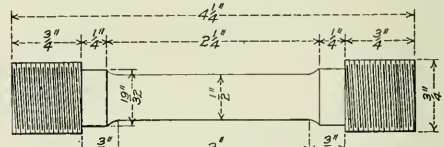

Standard Test Piece.

between the face of the tire and a line passing through the center of the tire from tread to bore, as shown below.

7. Should no falling weight test be required by the contract, the physical properties of each heat of steel shall be determined by a test specimen cut from a bar 6 in. x 4 in. x 9 in., forged from an ingot, and heat treated with the tires. The location of this test specimen to correspond to location of test piece when taken from a tire.

8. When required, the purchaser or his representative shall be furnished with copies of all chemical analyses and physical tests, and be privileged to witness all physical tests.

9. Heat-Treatment: The heat-treatment shall consist in reheating the tires after rolling, and then quenching in oil; the tires to be then reheated slowly and uniformly to a temperature sufficiently high to obtain the desired physical properties. The tire must be held at this final temperature at least two hours. The tire should then be withdrawn from the furnace and allowed

to cool in still air. The recommended temperature for quenching is about 1,600 deg. F. The final heating for obtaining the physical properties specified should be approximately 1,100 to 1,200 deg. F.

10. Should the contract call for a falling weight test, a test tire from each heat represented shall be selected by the purchaser or his representative, and furnished at his expense, provided it meets the requirements.

The test tire shall be placed vertically in a running position under the drop, on a solid foundation with an anvil weighing at least ten tons, and shall be subjected to successive blows from a tup weighing 2,240 lbs., falling from heights of 10 ft., 15 ft. and 20 ft. and upwards until the required deflection is obtained as specified below.

The test tire shall stand the drop test described in foregoing paragraph without breaking or cracking and shall show a minimum deflection equal to $D^2 \div (40T^2 + 2D)$, D being the internal diameter in inches and T the thickness of the tire at center of tread in inches. Should the test tire fail to meet the requirements in any particular, two more test tires shall be selected from the same heat, if the manufacturer so desires, and at his expense. Should these two tires fulfill the requirements, the heat shall be accepted.

11. Tires when furnished in the rough shall conform to drawings with the following tolerances:

(a) The height of flange shall not be more than 3-32 in. over or under the height called for. (b) The width of flange shall

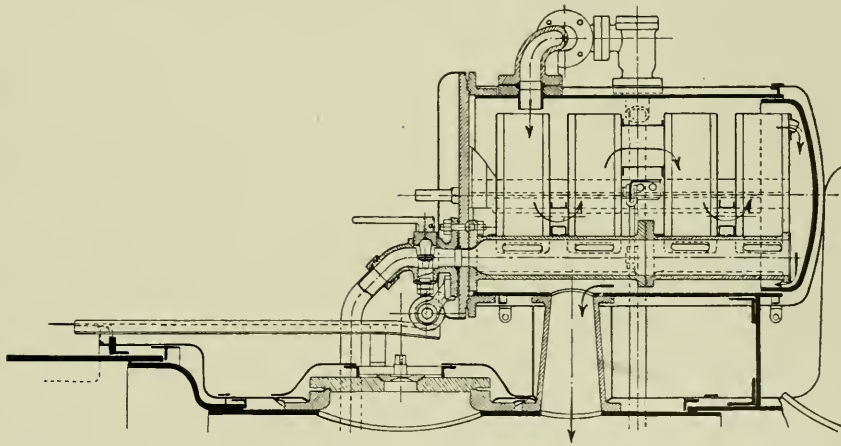
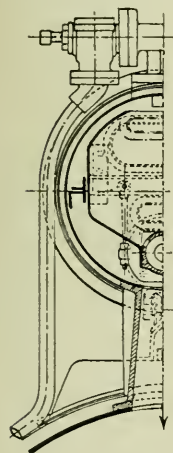

Apparatus Mounted on a Locomotive Boiler for Removing the Scale Forming Ingredients from the Feed Water.

not be more than 1-16 in. over or under the dimensions called for. (c) The throat radius shall not be more than $\frac{1}{8}$ in. greater nor more than 1-16 in. less than the radius called for. (d) The width of tire shall not be more than $\frac{1}{8}$ in. greater nor more than 1/16 in. less than the width called for. (e) The inside diameter shall not be less than the diameter of the finished tire by more than $\frac{3}{8}$ in. (f) Tires 33 in. or less in inside diameter shall be furnished in sets not varying more than 1-16 in. in outside diameters, and not out of round more than 1-16 in. Tires over 33 in. in inside diameter shall be furnished in sets not varying more than 3-32 in. in outside diameter and not out of round more than 3-32 in.

12. The manufacturer's brand and serial number shall be legibly stamped on the tire close to the inside edge where the stamping will not be cut off at the last turning. Set numbers shall be stenciled on each tire.

13. The inspector representing the purchaser shall have free entry at all times, while work on the contract of the purchaser

is being performed, to all parts of the manufacturer's works which concern the manufacture of the material ordered. The manufacturer shall afford the inspector, free of cost, all reasonable facilities to satisfy him that the tires are being furnished in accordance with these specifications. All tests and inspections shall be made at the place of manufacture prior to shipment, and shall be so conducted as not to interfere unnecessarily with the operation of the works.

14. Tires which show injurious defects while being finished by the purchaser will be rejected, and the manufacturer shall replace them at his own expense.

DEVICE FOR PREVENTING SCALE

For the past year the State Railways of Hungary have been using an apparatus to prevent scale forming in the locomotive boilers. The action of the apparatus, which was illustrated in a recent issue of the *Revue Generale des Chemins-de-fer*, is based on the well known fact that if the feed water is suddenly raised to a temperature of about 195 deg. Fahr., any carbonate of lime held in solution will be precipitated. There are a large number of arrangements of this kind in use in stationary plants where the sudden heating of the water is effected either by live or exhaust steam. On locomotives, various arrangements have also been used, notably that of Golsdorf. The Hungarian apparatus is placed on the shell of the boiler

with which it is in communication through a large connection. The feedwater enters at the top and circulates in the direction of the arrows. It is heated by the steam that fills the apparatus; the scale is precipitated and falls into the conduit below the four chambers, whence it can be removed under pressure through the valve shown at the left. The water, freed from its carbonate of lime, flows out of the last chamber and drops down to the bottom of the drum and then flows into the boiler. The apparatus possesses the very decided advantage of being independent of and separate from the boiler, so that it may be readily inspected and cleaned; to do this it is only necessary to unbolt the cover and take it off by rolling it back on the rails provided. The conduit and the circulating chambers are connected to this head. In practice it has been found necessary to clean the apparatus with every washing out of the boiler, which however are only half as frequent as formerly. The interior of the boiler is not entirely free from scale, but the scale is readily loosened by the stream from the washout pump.

TABULAR COMPARISON OF TYPICAL LOCOMOTIVES OF THE MOUNTAIN, PACIFIC AND PRAIRIE TYPES

ARRANGED IN ORDER OF TOTAL WEIGHTS IN EACH TYPE

Table with columns for Type, C. & O., P. & R., D. L. & W., P. R. R., R. & C. Co., R. R., O. R. & N., B. & O., S. L. & S. F., M. S. & P., N. C. & S. L., C. & N. W., C. of G., S. P., C. E. & C., M. A. S. P., and various other locomotive specifications including weight, dimensions, and manufacturer.

*Equivalent simple cylinders.

TABULAR COMPARISON OF RECENT LOCOMOTIVES OF THE ATLANTIC, TEN-WHEEL, MOGUL AND SWITCHING TYPES

ARRANGED IN ORDER OF TOTAL WEIGHTS IN EACH TYPE

Type	ATLANTIC (4+4-2)			TEN WHEEL (4+6-0)			MOGUL (2-6-0)			0-10-0			0-8-0			0-6-0			0-8-0			0-6-0			0-8-0			0-6-0		
	P. R. R.	E. R. Co.	Santa Fe	C.R.&P.	Sou. Pac.	Mo. Pac.	D.&H.	M.&S.C.L.	Can. Nor.	N. W.P.	Vandavia	D.L.&W.	N.Y.C.	P.O.&W.	N.Y.C.	D.L.&W.	N.Y.C.	P.O.&W.	N.Y.C.	D.L.&W.	N.Y.C.	A.C.&K.	Southern	U. P.						
	1885	1910	1910	1910	1912	1912	1912	1912	1911	1910	1909	1909	1909	1907	1907	1910	1911	1911	1911	1910	1910	1906	1910	1910						
Name of road	1885	1910	1910	1910	1912	1912	1912	1912	1911	1910	1909	1909	1909	1907	1907	1910	1911	1911	1911	1910	1910	1906	1910	1910						
Road number or class	W-28	Baldwin	Baldwin	Baldwin	Baldwin	Baldwin	Baldwin	Baldwin	Baldwin	Baldwin	Baldwin	Baldwin	Baldwin	Baldwin	Baldwin	Baldwin	Baldwin	Baldwin	Baldwin	Baldwin	Baldwin	Baldwin	Baldwin	Baldwin						
Builder	Baldwin	Baldwin	Baldwin	Baldwin	Baldwin	Baldwin	Baldwin	Baldwin	Baldwin	Baldwin	Baldwin	Baldwin	Baldwin	Baldwin	Baldwin	Baldwin	Baldwin	Baldwin	Baldwin	Baldwin	Baldwin	Baldwin	Baldwin	Baldwin						
When built	1910	1910	1910	1910	1912	1912	1912	1912	1911	1910	1909	1909	1909	1907	1907	1910	1911	1911	1911	1910	1910	1906	1910	1910						
Tractive effort, lbs.	37,470	33,800	29,600	23,500	31,500	31,000	30,200	29,480	55,360	44,100	41,200	35,000	27,475																	
Weight, total, lbs.	237,000	211,625	202,000	195,000	199,000	173,850	173,000	169,000	187,000	171,500	274,000	201,000	142,600																	
Weight on drivers, lbs.	139,500	113,125	116,000	105,000	115,000	132,900	133,000	127,000	159,000	150,500	274,000	201,000	142,600																	
Weight on tender, lbs.	49,000	62,235	49,000	45,000	42,000	40,950	40,000	42,000	27,700	21,000																				
Weight on tracter, lbs.	48,500	57,325	37,000	34,000	34,000	121,150	123,650	119,100	146,000	129,300	134,000	141,500	129,000																	
Weight of tender, loadst. lbs.	158,000	164,325	149,500	145,500	146,500	131,150	133,650	119,100	146,000	129,300	134,000	141,500	129,000																	
Wheel base, driving, ft. & in.	7-5	6-10	7-0	7-0	7-6	15-0	14-6	14-10	14-9	15-0	19-0	16-0	15-4																	
Wheel base, total engine, ft. & in.	29-7 1/2	32-8	30-10	27-7	29-8	26-11	24-10	25-11	23-0	23-0	19-0	16-0	15-4																	
Wheel base, engine and tender, ft. & in.	63-8	61-1	62-8	58-2	59-7 1/2	58-5 1/2	54-3	55-1 1/4	56-10 3/4	53-7 1/2	54-7 1/2	49-2 3/4	45-7 1/2																	
Diameter of drivers, in.	80	73	73	81	78	63	63	63	63	63	52	57	51																	
Cylinders, number	2	4	4	2	2	2	2	2	2	2	2	2	2																	
Cylinders, diameter, in.	22	15 & 25	17 1/2	20	21	23	20	21	20 1/2	24	27	24	21																	
Cylinders, stroke, in.	26	26	26	28	28	26	26	28	26	28	26	28	26																	
Valve gear, type.	Wals.	Wals.	Wals.	Steph.	Wals.	Wals.	Wals.	Steph.	Wals.	Wals.	Steph.	Steph.	Steph.																	
Steam pressure, lbs.	205	220	160	200	170	200	170	200	200	200	210	165	180																	
Boiler, type	Preheater	W. T.	E. W. T.	Str.	E. W. T.	Str.	E. W. T.	Str.	E. W. T.	Str.	E. W. T.	Str.	E. W. T.																	
Boiler, smallest diameter, in.	76 1/2	73	68 1/2	70	68	66 1/2	66	66 1/2	77	66	80 1/2	83 1/2	74 1/2																	
Tubes, number and diameter in inches.	242-2	273-2 1/4	206-2	297-2	362-2	316-2	185-2	351-2	390-2	310-2	440-2	450-2	327-2 1/4																	
Floes, number and diameter in inches.	36-5 1/2	Note	24-5 1/4	28-5 1/2	28-5 1/2	36-5 1/2	36-5 1/2	36-5 1/2	36-5 1/2	36-5 1/2	440-2	450-2	327-2 1/4																	
Length of tubes and flues, ft. & in.	13-8 1/2	14-6	18-0	16-0	16-1 1/2	15-1 1/2	13-2 1/4	14-2	13-7	13-6	19-0	13-0	14-11 3/4																	
Heating surface, tubes & flues, sq. ft.	2,433.2	2,318	2,521.0	2,475.0	3,012.0	2,120.0	2,473.0	1,746.0	2,583.3	2,176	4,416.0	3,514.7	2,832.1																	
Heating surface, firebox, sq. ft.	218.2	100	194.5	179.8	182.5	150.7	176.0	183.0	173.5	180.4	161	186.2	194.6																	
Heating surface, total, sq. ft.	2,651.2	2,508	2,715.5	2,654.8	3,194.5	2,270.7	2,649.0	1,929.0	2,761.8	2,035.0	2,337	3,709.3	2,998.0																	
Heating surface, superheater, sq. ft.	653.0	Note	479.0	Note	461.0	Note	403.2	Note	403.2	Note	Note	Note	Note																	
Grate area, sq. ft.	55	48	42.8	49.5	44.5	50.2	42.5	31.6	30.3	52	53.4	55	58.1																	
Firebox, length, in.	110 1/4	109 1/2	102 1/2	108	96.0	96	90	113 1/2	108 1/2	108	102	108 1/2	111 1/2																	
Firebox, width, in.	72	63 1/2	60 1/2	66	67.0	75 1/2	68	40 1/4	40 1/4	69	75	73 1/4	75 1/4																	
Kind of fuel	Bit coal	Bit coal	Bit coal	Bit coal	Bit coal	Bit coal	Bit coal	Bit coal	Bit coal	Bit coal	Bit coal	Bit coal	Bit coal																	
Tender, coal capacity, tons	13	3,300 g.	13	2,835 g.	14	14	10	10	2,000 g.	13	6,500	8,000	7,000																	
Tender, water capacity, gals.	7,000	9,000	7,500	9,000	7,000	6,800	6,500	6,000	6,000	7,500	8,000	8,000	7,400																	
Weight on drivers + tractive effort.	5.1	4.7	3.92	4.47	4.6	4.68	4.3	4.6	4.2	4.76	5.1	4.45	4.28																	
Weight on drivers + total weight, per cent.	58.80	48.60	57.50	53.70	60.20	73.80	76.50	78.60	75.00	85.00	88.00	85.00	84.64																	
Evap. heat, surf. + superheater heat, surf.	4.05	5.68	5.68	6.75	6.67	6.68	6.68	6.68	6.68	6.68	6.68	6.68	6.68																	
Firebox heat, surf. + total heat, surf., per ct.	8.20	7.50	7.18	8.30	8.30	8.30	8.30	8.30	8.30	8.30	8.30	8.30	8.30																	
Firebox heat, surf. + total heat, surf., per ct.	3.97	3.97	4.14	3.63	4.10	3.60	4.14	5.80	5.70	3.48	3.40	3.36	4.03																	
Total heat, surf. + grate area.	48.30	52.20	63.40	53.80	45.00	62.00	61.00	56.50	43.60	84.00	63.80	72.70	82.70																	
Tractive effort X diam. drivers + heat, surf.	828.00	692.70	798.00	717.00	609.00	875.00	698.00	945.00	717.00	795.00	625.00	825.00	625.00																	
Total weight + total heat, surf.	89.30	92.50	74.50	73.80	59.70	88.00	65.60	89.50	61.30	63.80	73.50	59.50	61.80																	
Volume of cylinders, cu. ft.	11.40	8.30*	10.15	11.20	12.45	10.40	11.40	10.15	11.20	9.95	14.66	19.90	14.66																	
Total heat, surf. + cylinder volume	233.00	302.00	188.00	262.00	285.00	182.00	255.00	169.00	273.00	262.00	234.00	314.00	186.50																	
Grate area + cylinder volume	4.82	5.70	2.97	4.92	3.98	4.03	4.09	3.77	3.62	4.65	5.38	3.75	2.81																	
Reference for photograph, elevation or de.	Am. Engr.	Am. Engr.	Loc. Dic.	Loc. Dic.	Loc. Dic.	Loc. Dic.	Loc. Dic.	Loc. Dic.	Loc. Dic.	Loc. Dic.	Loc. Dic.	Loc. Dic.	Loc. Dic.																	
1911-12-24	1911-12-24	1911-12-24	1912-12-18	1912-12-18	1912-12-18	1912-12-18	1912-12-18	1912-12-18	1912-12-18	1912-12-18	1912-12-18	1912-12-18	1912-12-18																	

Note—Equipped with reheater having 417 tubes 48 in. long giving a reheating surface of 1,147 sq. ft. *Equivalent simple cylinders. †Reference for locomotives as built without superheater.

LARGE NARROW GAGE LOCOMOTIVES

In connection with a description in the December issue of two locomotives of the Garratt type built for the Tasmanian Government Railways, it was stated that these are the largest narrow gage locomotives in the world. We have been informed that this is not correct and that the American Locomotive Company has built both freight and passenger locomotives for the Central South African Railway, a 3 ft. 6 in. gage line, which are larger

In the case of the passenger engines, the Pacific type without the tender has a weight of 155,500 lbs. compared with 211,800 lbs. for the Garratt type, but when the weight of the tender is also included this engine weighs 22 per cent. more than the Tasmanian and the tractive effort is about 10 per cent. greater.

FREIGHT LOCOMOTIVES.

	Tasmanian	So. African Govt.
Type	Garratt	Mallet
Wheel arrangement	2-6-2-2-6-2	2-6-6-2
Total weight, engine, lbs.....	201,700	230,000

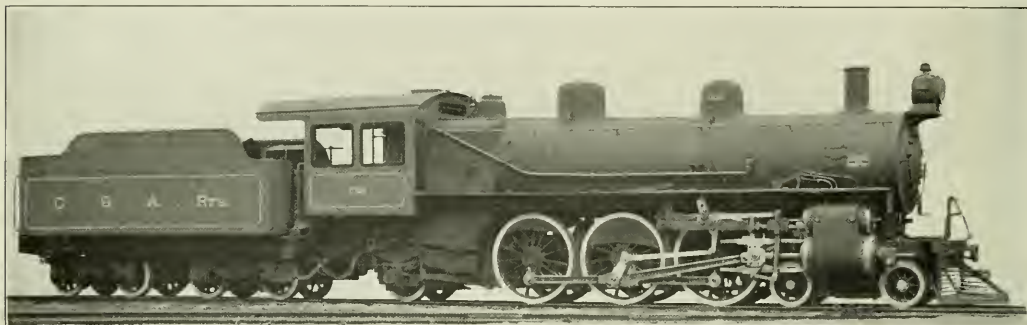

Narrow Gage Pacific Type Locomotive for the Central South African Railways.

and more powerful than those of the Garratt type. Furthermore, this company has now under construction a 2-8-8-2 type locomotive for a metre gage line which is even larger and will weigh from 230,000 lbs. to 240,000 lbs. for the engine alone and about 340,000 lbs. for the engine and tender combined, which weight should be used in comparing it with the Garratt type.

In the table below will be found the comparative weights and other dimensions of the Garratt type locomotives and both the freight and passenger locomotives of the Central South African Railways mentioned above. It will be seen that in the case of the

Total weight, engine and tender, lbs.....	201,700	334,600
Weight on drivers, lbs.....	32,100	196,000
Tractive effort, lbs.....	4	47,700
Cylinders, number	15x22	18 & 28½x26
Cylinders, diameter and stroke, in.....	42	46
Diameter of drivers, in.....	160	200
Steam pressure, lbs.....	1,686	2,621
Total heating surface, sq. ft.....	39.3	49.3
Grate area, sq. ft.....	3,000*	4,000
Tender, water capacity, gals.....	4*	9
Tender, coal capacity, tons.....		

PASSENGER LOCOMOTIVES.

	Garratt	Pacific
Type	4-4-2-2-4-4	4-6-2
Wheel arrangements	211,800	155,500
Total weight, engine, lbs.....	211,800	155,500
Total weight, engine and tender, lbs.....	211,800	259,800



Large Narrow Gage Mallet Locomotive for the South African Railways.

freight engines, the Mallet has a weight of 230,000 lbs. for the engine alone and 334,600 lbs. for the engine and tender, which, compared with the Garratt type, is an increase of 14 per cent. in the former item and 65 per cent. in the latter. The tractive effort shows a similar difference, being 48 per cent. larger than that of the Tasmanian engine. The driving wheels are slightly larger and the steam pressure is 200 lbs. as compared with 160 lbs. The heating surface and grate area are also decidedly larger.

Weight on drivers, lbs.....	26,100	106,000
Tractive effort, lbs.....	8	28,800
Cylinders, number	12x20	2
Cylinders, diameter and stroke, in.....	60	21x28
Diameter of drivers, in.....	60	62
Steam pressure, lbs.....	160	170
Total heating surface, sq. ft.....	1,686	1,981
Grate area, sq. ft.....	39.3	35
Tender, water capacity, gals.....	3,000*	4,000
Tender, coal capacity, tons.....	4*	10

*Does not have a separate tender. The tanks are carried on the locomotive frames.

SHOP PRACTICE

LOCOMOTIVE SHOP KINKS

BY LEWIS D. FREEMAN,

Special Tool Designer, Baltimore & Ohio, Baltimore, Md.

METAL PAN FOR HANDLING MATERIAL.

An improved method of handling material in large quantities is illustrated in Fig. 1, which shows a metal pan 6 ft. x 7 ft., made from steel plates $\frac{1}{4}$ in. thick; it is 15 in. high at the sides with one end open. The top edges are bound with $1\frac{1}{2}$ in. half round iron. The labor in handling material with this pan is greatly reduced over that of using a wheel-barrow or cart. Empty pans are loaded at the foundry or the smith shop with the newly made material, and are placed on a cart or truck by a crane and hauled to the machine shop. The pans may then be used to take the finished material to the erecting shop or storehouse.

The general appearance of the shops can be greatly improved

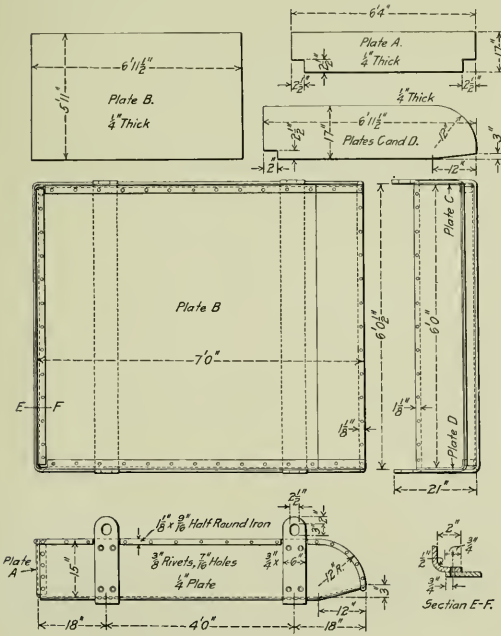

Fig. 1—Metal Pan for Carrying Loose Material.

by placing these pans about the shop where the scrap material can be gathered in them. They can also be used to good advantage when placed so that they will catch the scrap from the shears and punches, and when full can be taken directly to the scrap pile. When carried by a crane the pans should be suspended by four chains having one end attached to a ring and the other to hooks which will fit in the eyes on the pan. With this arrangement the contents of the pan may be dumped by slackening the chains, unhooking the two front chains and lifting up with the two back ones, allowing the contents to fall out at the open end. While this idea is by no means new this pan

is of simple, yet strong construction, and more satisfactory than if it were made of wood.

LOCATING BOILER GAGE COCK HOLES.

Recent state and federal laws concerning the operation of locomotive boilers make it necessary to report the exact location of gage cock holes, as well as the necessity of laying out new gage cock holes in rebuilt boilers in a certain relative position to the crown sheet. Many schemes have been developed using straight edges and plumb lines which require the services of three or more men, and they have many chances for error.

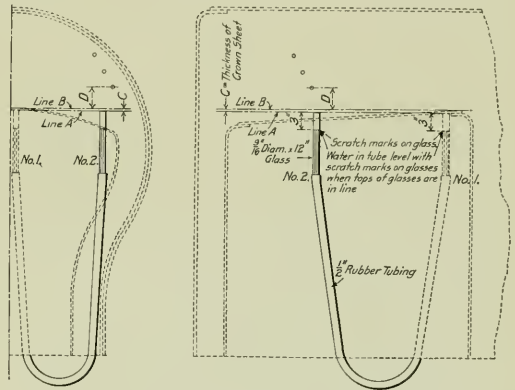

Fig. 2—Simple and Accurate Method of Locating Gage Cocks.

After some study the writer developed the plan shown in Fig. 2, which is similar to the Baldwin Locomotive Works' practice.

Take two water gage glasses about 12 in. long, square up the top ends and with a glass cutter make a scratch around the glasses about 3 in. from the top. Connect the two glasses with a piece of rubber tubing of suitable length, 12 ft. to 18 ft. is usually sufficient for the largest locomotives, and fill it with water up to the scratch marks, having the tops of both glasses in line. Two men are required to operate this device. With the boiler setting approximately level, one man takes glass No. 1 into the firebox, holding it against the highest point of the crown sheet. Glass No. 2 is taken out through the fire door hole or under the sides of the mud ring to the back head or to the side of the boiler, where it is desired to locate the gage cock holes. Raise or lower glass No. 2 until the water is level with the scratch marks in both glasses and scribe the line A on the boiler level with the top of glass No. 2. This line A represents the lower side of the crown sheet and by laying off the thickness of the crown sheet C the line B, which represents the highest point of the crown sheet inside of the boiler is obtained. Then measure off the distance D, which will be the proper height of the lowest gage cock. The other gage cocks may be easily located from this point. The same method is used to measure the height of any gage cock already in place. Objections have been made against this scheme on account of the possibility of air bubbles affecting the level of the water, but when this gage is once filled with water it should never be emptied. Cocks should be placed in the tops of the glasses to prevent evaporation, and each time the device is used, simply hold the tops of the glasses together and see that the water is level with the scratch marks and the gage will then be ready for service.

RIGHT ANGLE EXTENSION FOR AIR MOTORS.

In many places on modern heavy locomotives the reaming of holes with large air motors is practically impossible, especially under the boiler where the holes must be reamed for frame splices, crossies, firebox supports, foot plates, etc. It is neces-

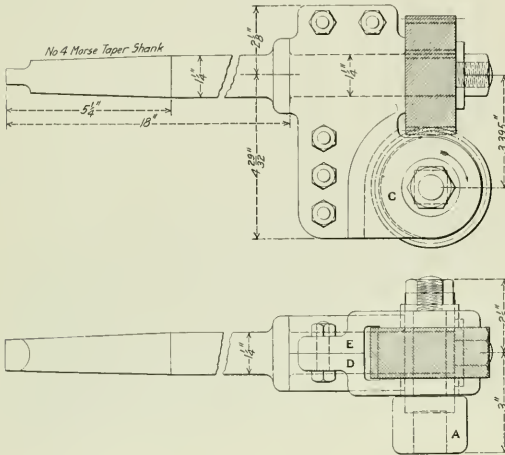

Fig. 3—Right Angle Attachment for Air Motors.

sary either to purchase special air motors which sacrifice power shown in Fig. 3 was designed to make use of the standard air for space or to ream the holes by hand. The right angle extension motors, and at the same time use the square shank hand reamers. By means of drill press extension the air motors may be several feet away from the work. The socket A

may be replaced by others having different sizes of square holes to fit the different sizes of square shanks on the hand reamers, and in this way eliminate the use of the tapered shank reamers. Gears B and C are helical gears cut to any convenient pitch depending solely on the machine at hand to do the work. All parts of the device are made from machinery steel except parts D and E, which may be made from either cast iron or brass.

COUNTERSINKING ATTACHMENT FOR DRILL PRESS.

In large railway shops where there are one or more fireboxes made each working day, the countersinking of the holes in the flanges of the back flue sheets and the furnace door sheets becomes a job of no small importance.

Most air motors are too large to line up with the holes in the flanges of these sheets, and to do the job with a hand ratchet is very expensive. Fig. 4 shows a device used to do this work on a drill press. Shaft A has a Morse taper shank to fit the spindle of the drill press. This shaft drives the shaft D through the bevel gears B and C.

The countersinking shaft D is keyed in the driving gear sleeve C, having a sliding fit therein, and is fed by the nut F, which is threaded into the feed gear sleeve G. The feed is operated by hand through the feed gears H and G. With this device it is possible to get within 1 1/2 in. from the flat surface of the plate, which is as close as the holes are usually placed. This machine works rapidly and does a better job at about one-quarter of the cost of hand work. A variation of this device can also be used to drill the holes in the pedestal jaws of locomotive frames, which are used for the purpose of securing the shoes and wedges, by removing the back stop E and adding a fixed center at the back.

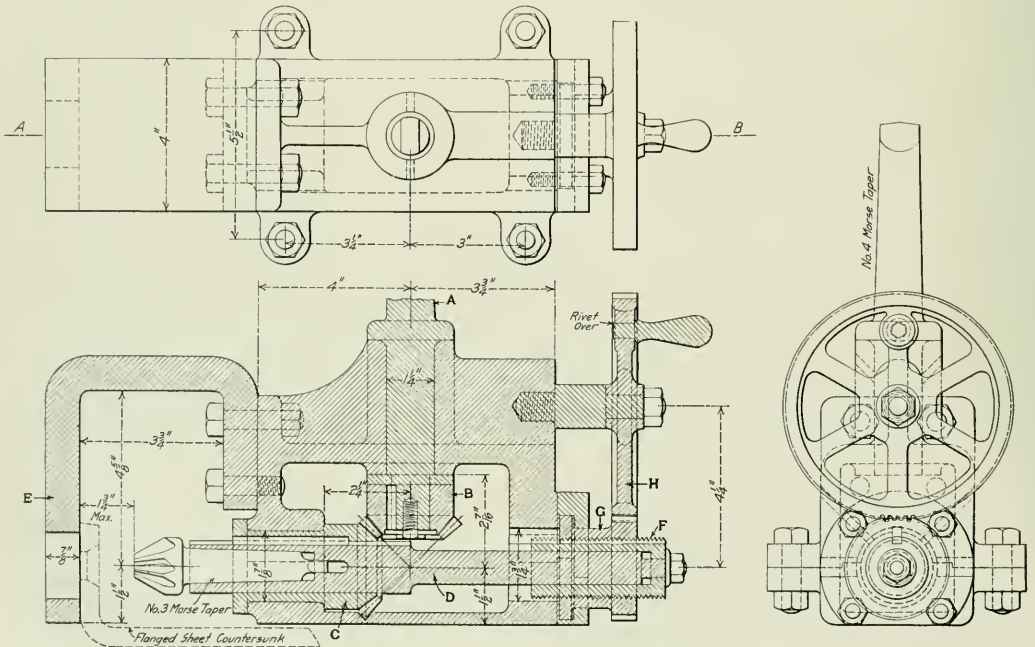

Fig. 4—Drill Press Attachment for Countersinking Holes in Flanged Boiler Sheets.

LOCOMOTIVE BOILER TUBE TOOLS

For Application and Maintenance of All Tubes, Including Those for Superheaters and Brick Arches.

BY WALTER R. HEDEMAN.*

It is not the intention to enter into a discussion of the relative merits of any of the tools or methods described, but simply to tell what tools are giving economical and efficient service in one of the largest railroad repair shops in the United States. It is, however, the writer's belief that the tools and appliances hereinafter described will stand most favorable comparison with any other devices or methods along similar lines.

In the article on "The Care of Boiler Tubes," in the August

the smokebox front in place. A No. 22 Thor reversible air machine, of the piston type motor, is used to drive it. A pinion transmits the power from the motor to a gear, which in turn is connected to the cutter proper by means of a telescopic transmission rod and universal joints.

The machine can be quickly attached and detached, reaches all flues without resetting, can be easily operated by one man, and is simple, effective and economical in its work. The working parts are of steel; the gear and pinion are completely enclosed and run in an oil bath, and destructive wear is practically eliminated. Interchangeability of parts is a strong feature of the device. The machine will cut $1\frac{3}{4}$ in., 2 in., and $2\frac{1}{4}$ in. tubes, but a different size cutter is required for each size of tube.

The cutter itself is shown in Figs. 3 and 4. It consists of four parts, and turns upon an eccentric shaft, so placed that a quarter turn of the body of the tool forces the knife out far enough

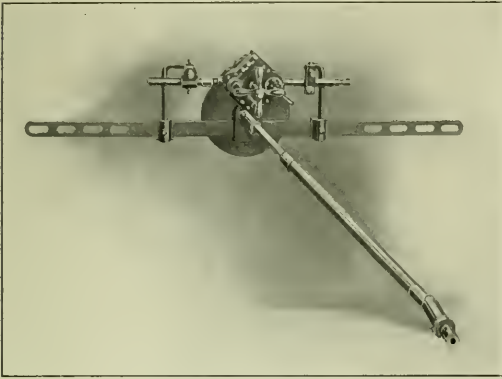

Fig. 1—The Faessler Tube-Cutting Machine with Motor.

number of the *American Engineer*, mention was made of an improved design of flue cutting off machine, to be used in removing flues from boilers. The Faessler tube cutting-off machine for locomotive boilers shown in Fig. 1 is an excellent one for this purpose, and is manufactured by the J. Faessler Manufacturing Company, Moberly, Mo. The use of this machine resulted in a saving of one cent a flue over the previous method of chipping off heads, mashing in ends and starting with a

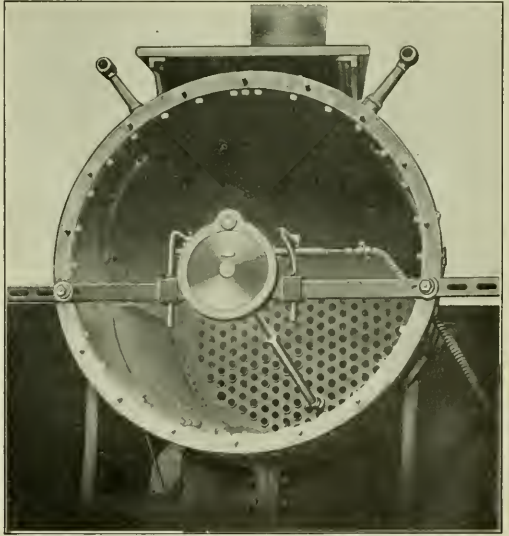

Fig. 2—Application of Faessler Tube-Cutting Machine.

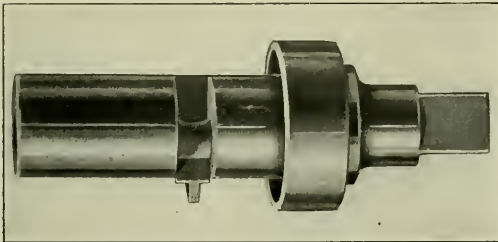

Fig. 3—Faessler Cutter, Used for Cutting Off Flues in Boiler, Preparatory to Removal.

sledge. It is the practice to cut off the flue as close to the sheet as possible without injuring the sheet in order to save as much of the flue as possible. The machine is attached by its crossbar to the front end of the smokebox of the locomotive as shown in Fig. 2, and is held in place by the bolts or studs that hold

to pierce the flue. One complete revolution cuts the flue. The cutter is then removed by reversing for a quarter turn and withdrawing. It may be operated with a wrench, if necessary.

For heating the flues preparatory to flaring and welding on the safe end a Ferguson flue welding furnace, furnished by the Railway Materials Company, Chicago, is used, and is illustrated in Figs. 5 and 6. It takes up a comparatively small amount of floor space, and maintains an ideal welding temperature, free from oxidation; the capacity is only limited by the skill of the operator. It has a combustion chamber, in which combustion is started, the resulting temperature serving to break down the oil into a gas as it passes upward in the chamber. The flame is directed into the furnace and air is admitted for complete combustion by means of a secondary blast of air introduced at the top of the combustion chamber. This arrangement sup-

*The writer begs to acknowledge the able assistance of R. C. Morton in the preparation of this article.

plies the necessary oxygen at the proper stages for the complete combustion of the gas in the furnace proper.

The furnace is just as hot where the flame enters as it is at any other point. All the breaking up of the oil is performed

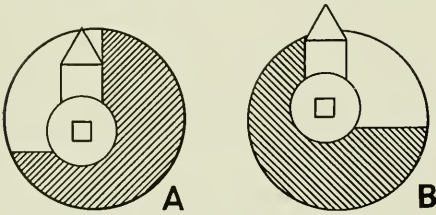

Fig. 4—Diagrammatic View, Showing Arrangement of Faessler Cutter.

outside the heating chamber proper. A fan blast of 8 oz. pressure, and an oil supply at a pressure of from 5 to 10 lbs. should be furnished. An independent regulation of air and oil is ob-

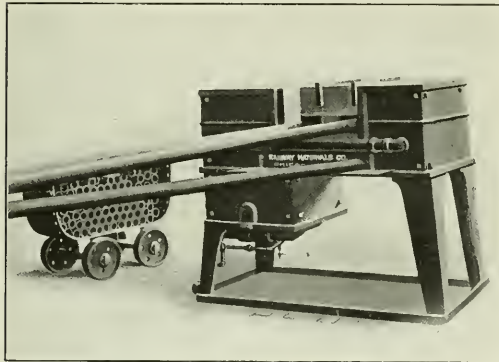

Fig. 5—Ferguson Flue Welding Furnace.

tained by means of a durable machined blast valve, and by a needle point oil valve.

The standard tapered horn for flaring the flue and also the horn for holding the safe-end are shown in Fig. 7. These horns may be fastened to a stand of any suitable construction of cast or wrought iron, and should be located alongside of the furnace.

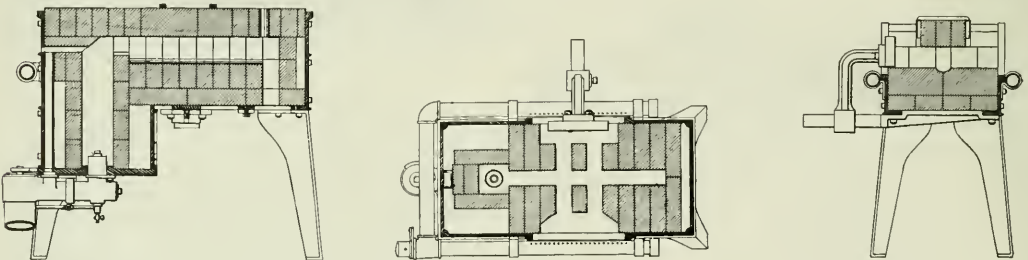

Fig. 6—General Construction of Ferguson Flue Welding Furnace.

After a flue has been heated the operator can flare it sufficiently to allow the scarfed end of the safe-end to enter by ramming it on the top horn two or three times. The scarfed safe end, having previously been placed on the lower horn, can now be picked up by the operator by pressing the flared end of

the flue against it, and then the flue with the safe-end entered is placed in the furnace for reheating preparatory to welding.

For welding and swaging flues the double cylinder welder shown in Fig. 8 made by the Draper Manufacturing Company, Port Huron, Mich., is used.

A 2 in. flue can be welded and swaged with one heat and with a smooth and even weld, inside and out, leaving the flue an even thickness all around. It is obvious that this machine should be placed as close to the furnace as possible. Any length of safe-end can be welded on by having a long mandrel and placing the machine directly behind the

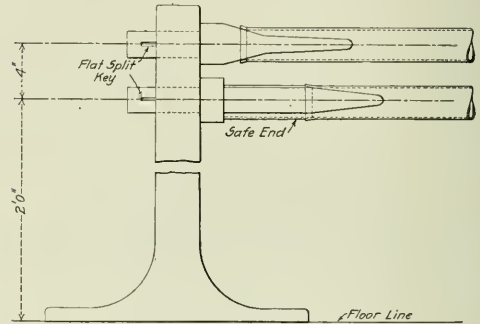

Fig. 7—Horns for Flaring Flues.

furnace, allowing the end of the flue to project through the dies while heating, and when hot shoving it forward until the weld comes under the dies. This machine takes up a floor space of less than two square feet, and strikes 2,000 or more blows per minute with 80 to 100 lbs. air pressure.

After the safe-end is welded on, the flues are cut to the proper length in a machine having revolving disc cutters similar to an ordinary pipe cutter. They are then tested in the flue testing machine which was described on page 484 of the September, 1912, number of the *American Engineer*, after which they are ready for application to the boiler.

For setting the copper ferrules in the firebox tube sheet, the tool shown in Fig. 9 may be used. The ferrules, which should neatly fit the holes, are first entered in the flue sheet and are driven home with the tool and a hand hammer. The dimension is such that the tool will center itself after being entered in the ferrule. Dimension B is made 1/32 in. less than the diameter of the hole in the sheet. By driving the tool in until the wide face

at the edge presses against face of sheet, the shoulder on the tool insures the ferrule being set 1/32 in. below the face of the sheet. The dimensions for nine sizes of tools are shown in the table, the handle being common to all.

For expanding the copper ferrules the straight sectional ex-

pander shown in Fig. 10 is used. It is made in eight segments and is expanded by means of an octagonal shaped mandrel shown in Fig. 15. The same tool is also used for expanding the firebox end of the flue. The table covers four sizes of expanders and two sizes of mandrels. A long stroke air hammer is used with this tool.

The tool shown in Fig. 11 is being experimented with and can be used for setting and expanding the copper ferrule and expanding the flues. The contour is such as to insure setting the ferrule 1/32 in. below the face of the tube sheet. If good results are obtained with it, the tools shown in Figs. 9 and 10 can be dispensed with. The same mandrel is used as with the expander shown in Fig. 10. The table covers four sizes of expanders, for flues 2 in., 2 1/4 in., and 2 1/2 in., and their corresponding ferrules. The mandrel seat in the expander is

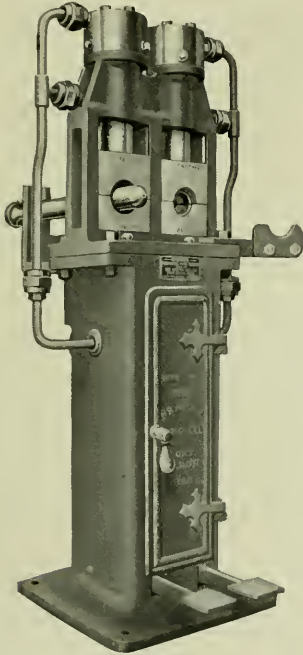

Fig. 8—Draper Pneumatic Flue Welder.

made with a double taper, to permit of the easy removal of the mandrel. The taper on the working end of the expander is the same as the taper on the mandrel, which insures the expander being seated on the mandrel when in operation. A coil spring segment keeper is preferable to one of rubber, as the oil used with these tools causes the rubber to deteriorate.

For flaring flues in the firebox sheet, preparatory to prosser-expanding, the tool shown in Fig. 12 is used, and is operated with a long stroke riveting hammer. The design makes it suitable for the standard sizes of boiler flues.

The tool shown in Fig. 13 is used for prosser-expanding the flues in the firebox sheet. A long stroke riveting hammer is used against the mandrel until the flue is set solid in the hole; then the mandrel is slacked off and the expander is turned slightly; the operation is repeated until the flue is properly set and evenly expanded all the way around. This tool is made in eight segments, and the outer contour is such as to expand a shoulder on the flue immediately inside of the flue sheet. Six different sizes of expanders are shown in the table, and two sizes of mandrels.

Beading tools 3 and 4, which operate with a short stroke air hammer, and are used for heading the flues on the firebox end, the last operation to be performed at this end of the flue, are

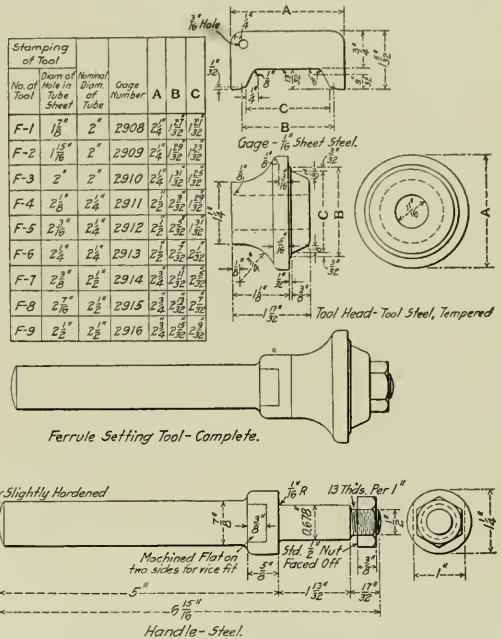

Fig. 9—Ferrule Setting Tool for Tubes 2, 2 1/4 and 2 1/2 in. in Diameter.

shown in Fig. 14. The only difference in these two tools, is that dimension Y is 1/64 in. greater on tool 4 than on tool 3.

For Stamping	Tools Used For	Number of Segments to Each Expander	A	B	C	Number of Mandrel Used
Number of Tool	Seating Copper Ferrules in Sheet Outside Diameter of Ferrules	Expanding Tubes in Ferrules Nominal Diam. of Tubes	Diam. After Cut	Diam. After Cut	Diam. After Cut	
S-1	2"	2"	1 21/64"	1 37/64"	3/8"	M-1
S-2	1 7/8", 1 15/16", 2"	2 1/4"	1 37/64"	2 3/64"	3/8"	M-1
S-3	2 1/8", 2 3/16", 2 1/4"	2 1/2"	1 53/64"	2 25/64"	9/16"	M-2
S-4	2 1/8", 2 1/16", 2 1/2"	2"	2 5/64"	2 21/64"	9/16"	M-2

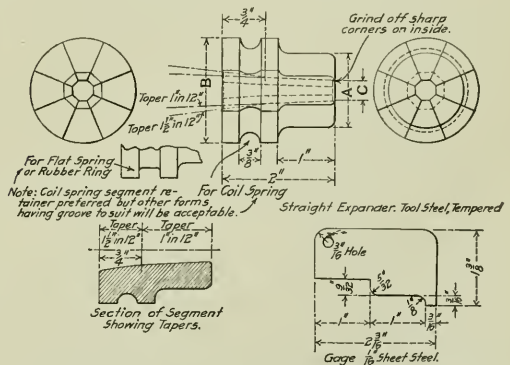

Fig. 10—Straight Sectional Expander for Copper Ferrules and Boiler Tubes.

The mandrel used with the expanders shown in Figs. 10, 11, 13 and 24 is shown in Fig. 15, only two different sizes being required to operate all these expanders. Experience has demon-

strated that it is better to make as many sides on the mandrel as the size of the tool will permit. It was found with the old style round mandrel that the segments rode together and would not keep separated, two or more butting together in service;

For Stamping Number of Tool	Tools Used For		Number of Segments of Each Expander	A Diam. After Cut	B Diam. After Cut	C Diam. After Cut	D Diam. After Cut	Number of Mandrel Used
	Expanding & Setting Copper Ferrules in Sheet Outside Diameter of Ferrules	Expanding Tubes in Ferrules in Sheet Nominal Diam. of Tubes						
S-7		2"	8	$1\frac{21}{64}$ "	$1\frac{29}{64}$ "	$1\frac{37}{64}$ "	$1\frac{45}{64}$ "	M-1
S-8	$1\frac{1}{8}$ ", $1\frac{1}{16}$ ", 2"	2 $\frac{1}{4}$ "	8	$1\frac{37}{64}$ "	$1\frac{45}{64}$ "	$1\frac{53}{64}$ "	$1\frac{61}{64}$ "	M-1
S-9	2 $\frac{1}{8}$ ", 2 $\frac{1}{16}$ ", 2 $\frac{1}{4}$ "	2 $\frac{1}{2}$ "	8	$1\frac{53}{64}$ "	$1\frac{61}{64}$ "	$1\frac{69}{64}$ "	$1\frac{77}{64}$ "	M-2
S-10	2 $\frac{3}{8}$ ", 2 $\frac{1}{2}$ ", 2 $\frac{1}{2}$ "	2 $\frac{1}{2}$ "	8	$1\frac{69}{64}$ "	$1\frac{77}{64}$ "	$1\frac{85}{64}$ "	$1\frac{93}{64}$ "	M-2

For Stamping Number of Tool	Tools Used For		Number of Segments to Each Expander	A After Cut	B After Cut	C After Cut	D After Cut	Number of Mandrel Used
	Diam. of Hole in Tube Sheet	Nominal Diam. of Tube						
P-1	$1\frac{1}{8}$ "	2"	8	$1\frac{19}{32}$ "	$1\frac{27}{32}$ "	$1\frac{35}{32}$ "	$1\frac{43}{32}$ "	M-1
P-2	$1\frac{1}{16}$ ", 2"	2"	8	$1\frac{7}{16}$ "	$1\frac{15}{16}$ "	$1\frac{23}{16}$ "	$1\frac{31}{16}$ "	M-1
P-3	2 $\frac{1}{8}$ "	2 $\frac{1}{2}$ "	8	$1\frac{19}{32}$ "	$1\frac{27}{32}$ "	$1\frac{35}{32}$ "	$1\frac{43}{32}$ "	M-1
P-4	2 $\frac{1}{16}$ ", 2 $\frac{1}{4}$ "	2 $\frac{1}{2}$ "	8	$1\frac{11}{16}$ "	$1\frac{19}{16}$ "	$1\frac{27}{16}$ "	$1\frac{35}{16}$ "	M-2
P-5	2 $\frac{3}{8}$ "	2 $\frac{1}{2}$ "	8	$1\frac{17}{32}$ "	$1\frac{25}{32}$ "	$1\frac{33}{32}$ "	$1\frac{41}{32}$ "	M-2
P-6	2 $\frac{1}{16}$ ", 2 $\frac{1}{2}$ "	2 $\frac{1}{2}$ "	8	$1\frac{7}{16}$ "	$1\frac{15}{16}$ "	$1\frac{23}{16}$ "	$1\frac{31}{16}$ "	M-2

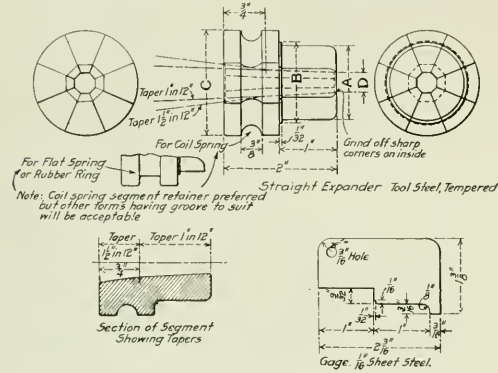

Fig. 11—An Experimental Type of Straight Sectional Steel Expander.

strated that it is better to make as many sides on the mandrel as the size of the tool will permit. It was found with the old style round mandrel that the segments rode together and would not keep separated, two or more butting together in service;

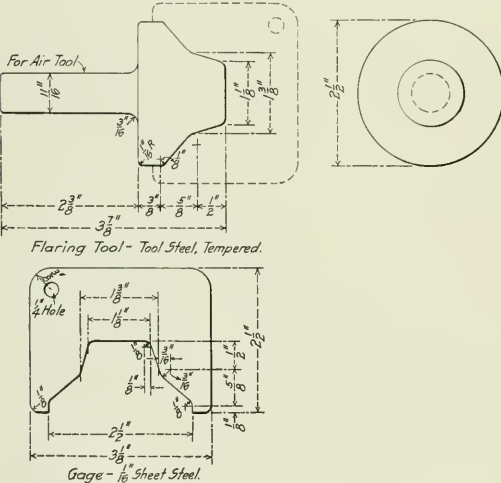

Fig. 12—Flue Flaring Tool, Used Preparatory to Prosser-Expanding.

therefore the octagonal mandrel was adopted. A long stroke riveting hammer is used with these mandrels.

A self-feed roller expander, which is used for tightening flues in the front flue sheet is shown in Fig. 16. It is self-feeding by reason of having the center lines of the rollers set at a slight

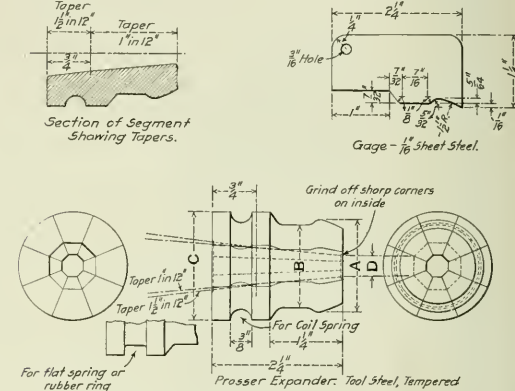

Fig. 13—Prosser Expander for Tubes 2, 2 1/4 and 2 1/2 in. in Diameter.

ers doing the duty of threads. Three different sizes of tools are shown in the table. The mandrel is turned by an air machine.

The manner of setting superheater tubes is shown in Fig. 17.

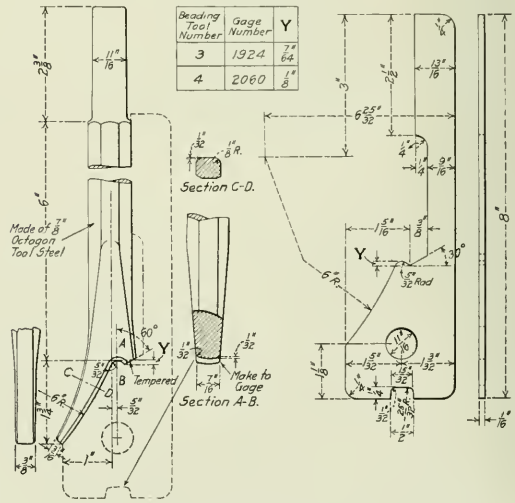

Fig. 14—Beading Tool for Boiler Tubes.

The specifications for these tubes, as well as for the tubes for brick arches, should include all the requirements called for in the article on page 414 of the August, 1912, number of the Amer-

ican Engineer. The same applies to copper ferrules. The tubes are ordered $1\frac{1}{2}$ in. longer than the distance over the outside of the tube sheets, and are then cut so as to show $\frac{1}{4}$ in projection over each tube sheet for beading. The extra $1\frac{1}{2}$ in. of length

For Stamping Number of Tool	Used With Expanders	A	B
M-1	S-1, S-2 P-1, P-2, P-3	$\frac{3}{8}$ "	$\frac{7}{8}$ "
M-2	S-3, S-4, S-5 P-4, P-5, P-6	$\frac{9}{16}$ "	$1\frac{1}{16}$ "

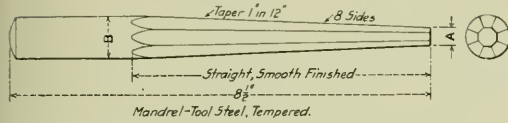

Fig. 15—Mandrel for Sectional Expanders.

will take care of any variation between the actual distance over the outside of the tube sheets and the distance shown on the drawings. The holes in the tube sheets must be carefully cleaned, and the ends of the tubes must have the scale removed

For Stamping Number of Tool	Tools used for Nominal Diam. of Hole in Tube Sheet		A
R-1	2"	$2\frac{1}{8}$ "	$1\frac{13}{16}$ "
R-2	$2\frac{1}{4}$ "	$2\frac{3}{8}$ "	$2\frac{1}{16}$ "
R-3	$2\frac{1}{2}$ "	$2\frac{5}{8}$ "	$2\frac{6}{16}$ "

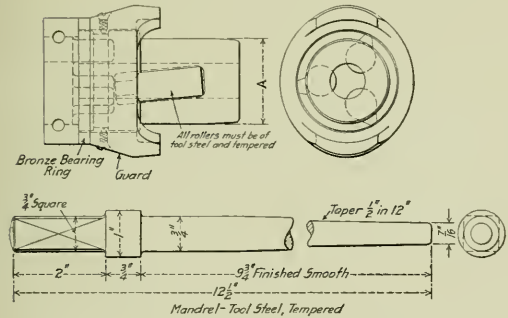

Fig. 16—Self-Feed Roller Expander for Tubes 2, $2\frac{1}{4}$ and $2\frac{1}{2}$ In. in Diameter.

by filing before applying the tube. The copper ferrule should be set in the flue hole and seated with the sectional expander, Fig. 18. The tube should then be set in place, care being taken not to injure or misplace the ferrule; then the straight sectional

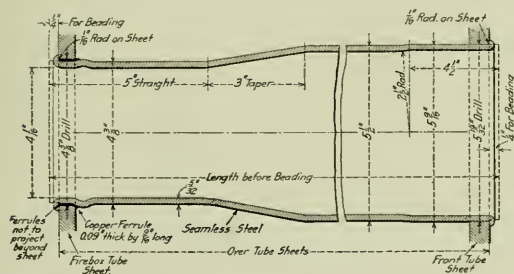

Fig. 17—Setting of $5\frac{1}{2}$ In. Superheater Flues.

expander should be used to seat the tube against the copper ferrule. After this has been done the prosser-expander shown in Fig. 19 is to be used, and then the tube should be beaded over, using the beading tool shown in Fig. 21.

The operation for setting, expanding, beading and rolling for superheater tubes is the same as for boiler tubes, except that these tubes are beaded over on the front end. In removing superheater tubes the same process is gone through as with boiler tubes. Before prosser-expanding the tube, the end should

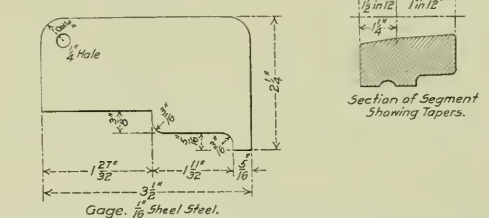
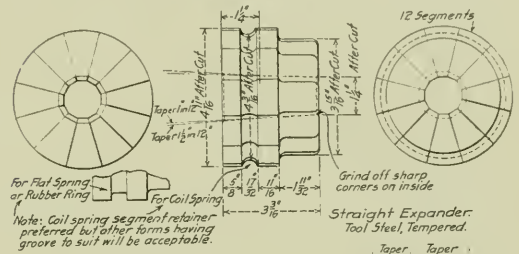

Fig. 18—Straight Sectional Expander for Copper Ferrules and Superheater Flues.

be flared to permit the prossering tool to enter to its proper depth. For hot work use the straight sectional expander for tightening the tubes in the back tube sheet; no roller expander should be used at this end. All superheater tubes in service should be re-prossered about once every 15 days, this being

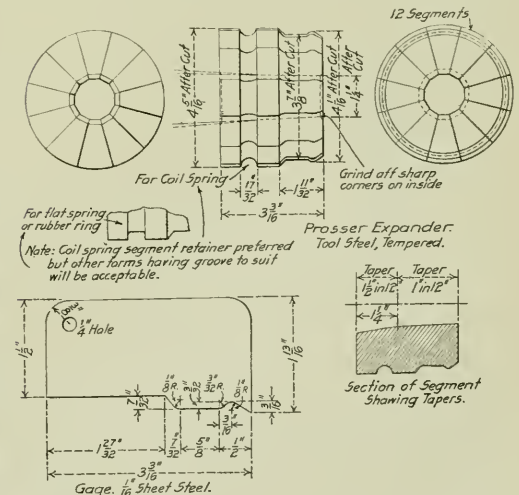

Fig. 19—Prossering Expander for Superheater Flues.

regulated by the service. The front end of the tube must be tightened with the roller expander shown in Fig. 20, after which the end must be beaded over by using the beading tool, Fig. 21. On account of the large size of the tube used it is possible to make the straight sectional expander for setting copper fer-

rollers in the back end of superheater tubes in twelve segments. This gives a better distribution of the segments in the tube and a smaller working face against the tube, making the operation

A copper ferrule .09 in. thick, is used only at the flue sheet end of the arch tube; the opposite end bears directly against the door sheet. This has proved good practice, and very little trouble is experienced from leakage. Brass plugs are used for the holes

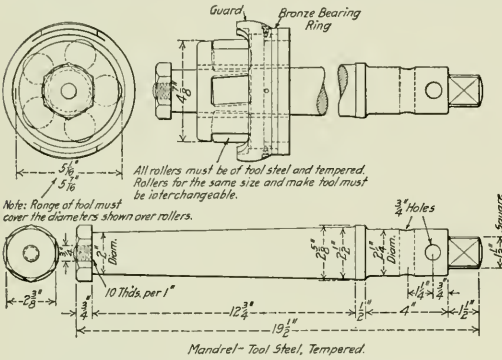

Fig. 20—Self-Feed Roller Expander for Superheater Flues.

much easier than if a large working face were provided. The prasser-expanding tool shown in Fig. 19 is also made in twelve segments. The beading tool for superheater tubes shown in

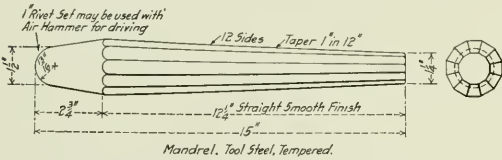

Fig. 22—Mandrel for Large Sectional Expanders.

Fig. 21 is operated with a short stroke air hammer. The roller expander and mandrel for setting the front end of the tube, Fig. 20, is operated with an air machine. This tool is of the

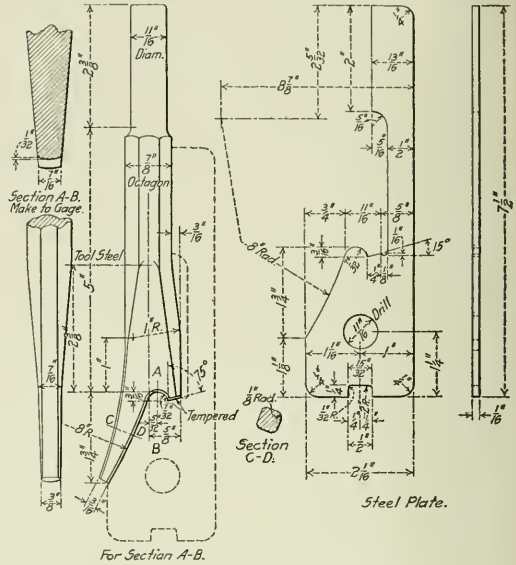

Fig. 21—Beading Tool for Tubes 5-32 in. Thick.

in the outside sheets opposite the arch tubes. These plugs are tapered 3/4 in. in 12 in., and have 11 1/2 threads per inch. Because of the thickness of this tube it is found desirable to bevel the inner edge to facilitate beading. At the throat sheet end of the tube a short radius is generally used to carry the tube

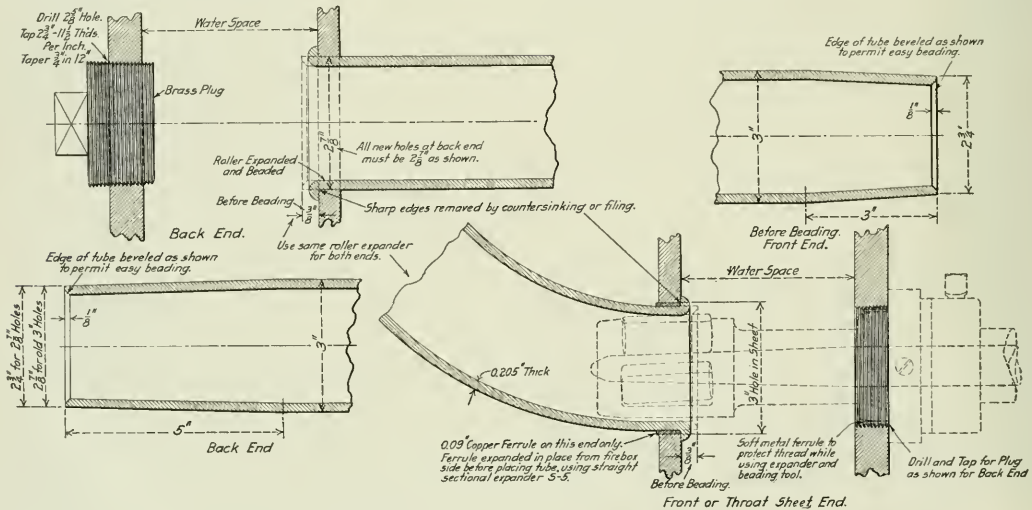

Fig. 23—Arrangement for Securing Brick Arch Tubes.

self-feed type. The mandrel used with the expanders shown in Figs. 18 and 19 is illustrated in Fig. 22, and is operated with a long stroke riveting hammer.

A proposed setting of brick arch tubes is shown in Fig. 23. away from the fire as quickly as possible. This is more desirable with a shallow depth firebox. Tubes are swaged down on both ends to permit using as small a hole as possible, and at the same time one size roller expander may be used for both

ends. In using the roller expanders a copper ferrule must be placed in the threaded plug hole in the outside sheet to prevent the threads from being injured by the expander guide.

The sectional expander for seating the copper ferrule in the flue sheet, which can be used only from the firebox side of the sheet, is shown in Fig. 24. As previously noted the mandrel shown in Fig. 15 is used with this expander.

A roller expander of the self-feed type, used for both ends

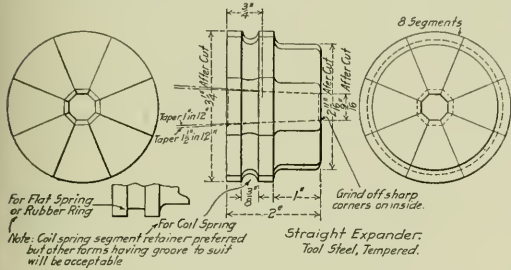

Fig. 24—Straight Sectional Expander for Brick Arch Tubes.

of arch tubes, is shown in Fig. 25. With this tool it is sometimes necessary to have a short or "donkey" mandrel with a larger diameter at the small end to prevent the end of the mandrel from extending so far through the expander as to bear against tubes having a short radius. The beading tool used on both ends of the arch tubes is shown in Fig. 26.

Gages are provided for nearly all of the tools illustrated. This is to insure the tools being uniformly made. Gages are furnished to the manufacturers on application, but in connection

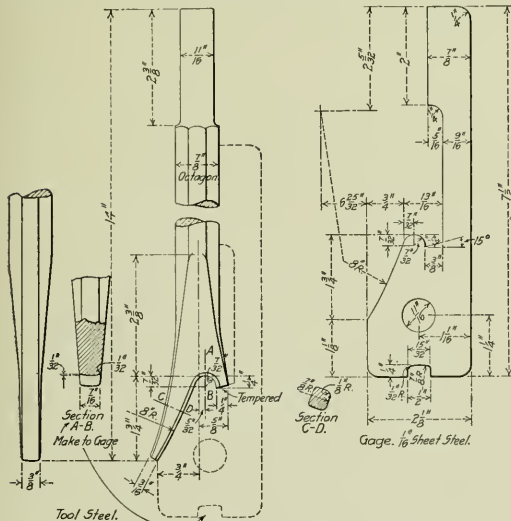

Fig. 26—Beading Tool for Brick Arch Tubes.

with this, it is absolutely necessary to have a master gage at the main shop of the railway, and all gages must be checked with this master gage before being loaned.

The tools should be kept in a general storehouse, and should not be distributed until inspected and passed upon by the engineer of tests, or some other designated inspector, as it is necessary that they be made absolutely to gage, and in accordance with the drawings.

Each tool is marked with a letter followed by a member. Thus letters F-1 to F-9 designate the ferrule setting tool; S-1 to S-10 the straight sectional expander; P-1 to P-7 the prosser-ing expander; M-1 and M-2 mandrels, and R-1 to R-5 roller

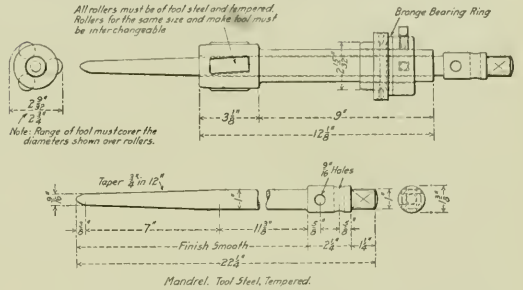

Fig. 25—Self-Feed Roller Expander for Brick Arch Tubes.

expanders. This is done so the shop men will become familiar with the different types of tools; and, when a tool is requested, the symbol given designates exactly the type desired.

REPAIRS TO MAIN RODS

By C. D. ASHMORE,
General Foreman, Chicago & North Western, Clinton, Ia.

In making repairs to the ordinary strap end main rod similar to the one shown in the illustration, it should first be completely dismantled and each part given a coat of whitewash and struck several heavy blows with a sledge to develop the presence of any cracks or flaws. If the parts are found to be in good condition and the brasses not sufficiently worn in the bore to make them useless, no new parts will be required except bolts. Most rods

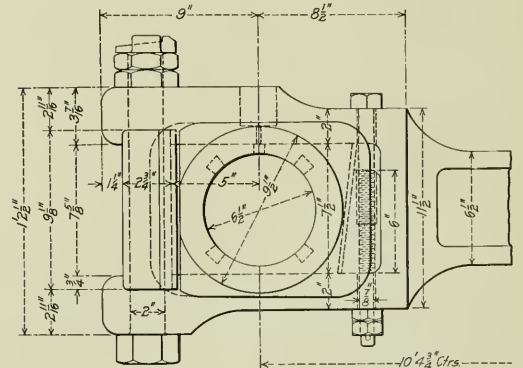

Forked End Main Rod; Chicago & North Western.

of this design will be found to have lost motion between the brass and the strap, and since the strap must have exactly parallel faces from the point of its attachment to the rod, the proper method is to bolt it in place and send it to the blacksmith shop. Here the back end is heated and closed to within the thickness of a piece of tin to the size at the point of connection with the rod. The reason for not bringing it to exact size is due to the shrinkage which will make it, when cool, almost the exact size required and it will only need a slight filing and cleaning to be ready for the brasses. When it is returned to the shop it should be removed from the rod and the ends spread

apart sufficiently to take out the spring and make an easy slip fit on the end of the rod.

The main brasses, meanwhile, should be taken to the shaper and closed to size for re-boring for the crank pin fit. They then should be babbitted for lateral motion and in the strap fit and again taken to the shaper and planed for an easy fit in the straps. After the brasses are fitted, the strap should be put on the rod and held in a vise while the bolt holes are reamed. The best practice is to use a reamer driven by an air motor, the motor being supported by a cable which passes over a pulley to a counterweight. A high speed reamer should be used and the work can be done as quickly as on the drill press without the danger of breaking the reamer. The hole should be reamed to gage size and stock bolts used. The limit in increase of diameter of these holes is generally specified, one-quarter inch being a safe amount.

After the strap bolts are fitted, the strap should be taken from the rod and the brasses applied with one thickness of Russia iron between the two halves and the key should be driven down to hold them tightly in place. The strap and brasses should then be transferred to the boring mill and bored to a size larger than the caliper size of the pin by the thickness of a strip of Russia iron. After boring, the brasses should be separated and the thin liner between them removed, which makes the bore exactly right for the pin on the front and back centers and gives

each pair of back end brasses and 53 lbs. for the front end brasses, will be \$47.56.

In this connection some data recently collected at the Clinton shop on cost of repairs to main rods will be of interest. It was found that on the sixty-four engines passing through the shop for general and heavy repairs, 240 main rod bolts, 131 middle connection bolts and 17 side rod bolts were renewed, making a total of 388 bolts, or an average of 6 per engine. The total cost of these bolts at 21 cents apiece, which includes material and labor, was \$129.68. During this time there were eight broken main rods which cost on an average of \$100.00 apiece, 10 broken back end main rod straps which cost on an average of \$14.79 apiece. Also during this time, 17 main rods were scrapped on account of the bolt holes being reamed to the limit, each of these costing on an average of \$100.00, making a total of \$2,987.58 for new bolts, main rods, broken straps and rods scrapped on account of bolt holes being too large. This is in addition to the cost for repairs.

CHART FOR FORGING MACHINE WORK

BY O. V. P. BULLEID*

The diagram on the opposite page has been found of great convenience in connection with forging work generally, and particularly in the design of the tools and the carrying out the work on forging machines. It permits a ready determination of the length of any sized round bar that will be required to give a certain length at any other diameter. It also gives the weight of the part for both wrought iron and steel. For example: It is desired to determine the increased length that should be given a 1½ in. diameter bar that is to be upset on the end to 2 in. diameter for a distance of 3 in. Using the diagram, it will be seen that a 2 in. diameter bar 3 in. in length is equivalent to a length of 5.7 in. on a 1½ in. diameter bar, showing that the stock should be cut 2 11/16 in. longer than the desired finished length of the piece after it is upset.

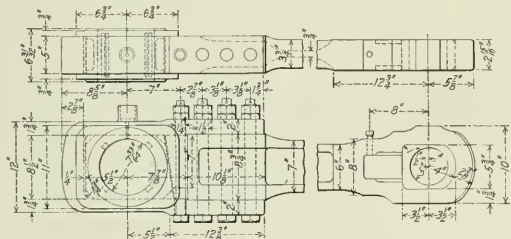

Strap End Main Rod; Chicago & North Western.

a slight clearance at the top and bottom which allows for shrinkage when the brass cools in case it gets hot, and prevents it sticking on the pin. The brasses should be bored for a slip fit on the pin and no filing or scraping should be done. While on the boring mill the brass should also be faced. A side clearance of 1/32 in. is usually allowed.

In the case of the forked end rod of the general style shown in the illustration, the proper procedure is to remove sufficient material from the ends of the block to permit the fork being drawn together so that the inside faces can be made parallel by reslotting. The procedure for the brasses is the same as in the other style of rod and the re-reaming of the bolt hole and fitting of the new bolt is generally required. New brasses will not usually be required at the front end of the rod, and a special jig arranged to take any size brass and hold it for boring should be employed.

The time required and the cost of doing this work with the strap end rod, having three bolts, will be on an average about as follows:

	Time.	Cost.
Stripping back end of rod, machinist and helper.....	32 min.	\$0.30
Closing brasses, babbitting and planing for strap fit.....	3 hrs.	1.35
Hand fitting brass to strap.....	30 min.	.19 1/2
Close strap, reaming bolt holes, etc.....	6 hrs.	2.37
Fitting three new bolts.....	1 hr.	.20
Total cost.....		\$4.61 1/2

For the front end brasses the work can be done in about three hours' time at a cost of \$1.25, or a total cost for two rods, not including cost of new bolts, of \$11.33. If new brasses are required for both the back and front ends of the rod, the cost, including the material for brasses, which will weigh 150 lbs. for

NEW RAILWAY MILEAGE IN ARGENTINA.—During 1911 254 miles of new line were opened on the Buenos Aires Great Southern Railway. In the same year 313 miles of new line were opened on the Central Argentine Railway, and 221 miles on the Buenos Aires Western Railway.

* LONG DISTANCE FLIGHT.—The prize for the longest straightway flight in France between sunrise and sunset was won by Pierre Ducourt, a French aviator, on October 6. He made a flight of 570 miles in 11 hours and 39 minutes, stopping only three times to replenish the supply of fuel.

INTERCHANGEABLE AXLES.—According to the Portuguese *Gazeta de Caminhos de Ferro*, international slow freight traffic between Paris and Lisbon is now being carried in 15-ton covered trucks fitted with double sets of bearings, and the wheels and axles are changed at the frontier. This is effected by means of a pit sunk between the rails, the wagon being run on the trolleys, on separate tracks alongside the main line, while the narrow (or 4-ft. 8½-in.) gage wheels drop by gravity into the pit, and the wagon is run forward until it engages with the broad (or 5-ft. 6-in.) gage wheels. The whole operation (which is said to resemble that in force on the German-Russian frontier) only requires about 10 minutes, and the time required for the trip from Paris to Lisbon is reduced from 15 to 8 days. Ten of the wagons, which belong to a firm in Paris, and have been constructed in Germany, are now running, and an important saving is effected in freedom from loss and damage to goods. A special through rate has been arranged by the companies concerned.—*The Railway Gazette (London)*.

* Locomotive Department, Great Northern Railway, Doncaster, England.

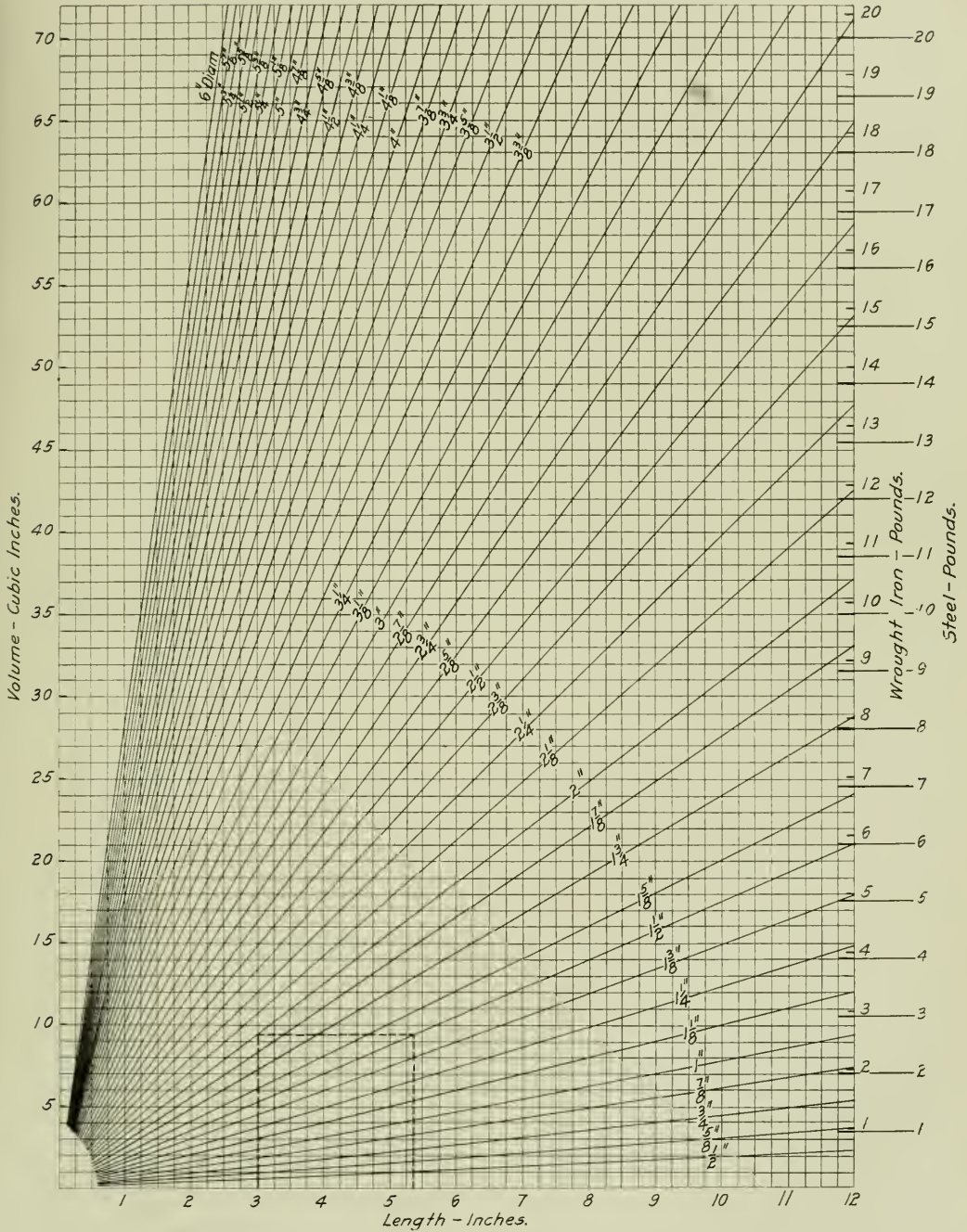

Chart for Equating the Length of Any Diameter Bar to that of Another Diameter Having the Same Volume.

PLANING SHOES AND WEDGES

Tools for planing the outside and inside of the flanges of shoes and wedges, designed by E. C. Smith at the Clifton Forge, Va., shop of the Chesapeake & Ohio, are shown in the accompanying illustrations. These tools have proved most efficient. The illustrations make the construction and arrangement clear and it will be seen that ample provision has been made for rigidity to take the maximum cut. The shoes and wedges are clamped, with the flanges up, to a long bar which has a width somewhat narrower than the shoes and is provided with slotted

A total of 173,321 defects was found on 48,768 locomotives from 74,234 inspections made on the 62,074 boilers, and 3,377 were ordered from service. The greatest number of defects was found in broken staybolts, there being 31,156 reported. The following gives the number of locomotives required to be strengthened or changed to comply with the requirements of the law or permanently removed from service for the respective reasons:

Pressure reduced to insure a proper factor of safety.....	699
Seams reinforced by welt plates to insure a proper factor of safety..	327
Permanently removed from service on account of defective condition..	698
Lowest reading of water glass ordered raised to comply with the law..	992
Lowest gage cock ordered raised to comply with the law.....	408

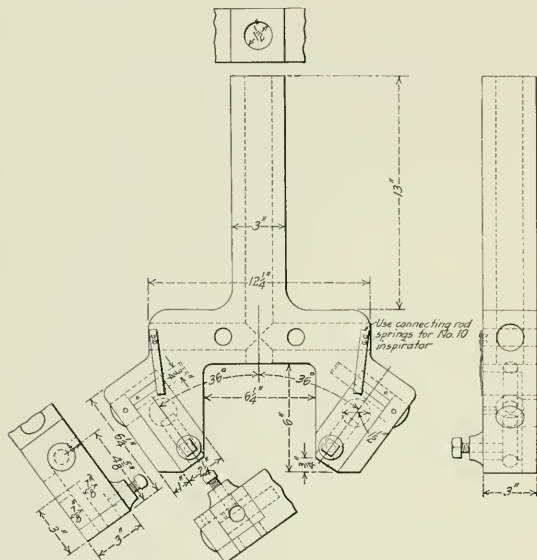

Tool for Finishing the Outside of the Flanges of Shoes and Wedges.

openings for the holding bolts. This bar is secured to the planer bed. The outside tool is then run down, finishing the outside of the flanges and the shoes or wedges are transferred to a chuck on the planer bed where the inside of the flanges are finished with the inside tool. Shoes and wedges are being machined at this shop for 14 cents apiece.

REPORT OF FEDERAL BOILER INSPECTOR

The first annual report of the chief inspector of locomotive boilers to the Interstate Commerce Commission for the fiscal year ending June 30, 1912, has just been received. A detailed report on the classified defects of 62,074 locomotives owned by 850 railroads and industrial plants and the number of accidents, together with the casualties, are included. Eight hundred and fifty-six boiler accidents are recorded, in which 91 persons were killed and 1,005 persons injured. The greatest number of accidents was reported from defective squirt hose and connections, there being 243 reported as injuring 245 persons. The next greatest number was from the breaking of water glasses, there being 165 of these accidents reported. They resulted in the killing of 1 person and the injuring of 168. The greatest number of persons killed was 35, caused by 69 crown sheet failures due to low water. These failures also injured 129 persons. There were 27 killed and 41 injured by 3 shell explosions.

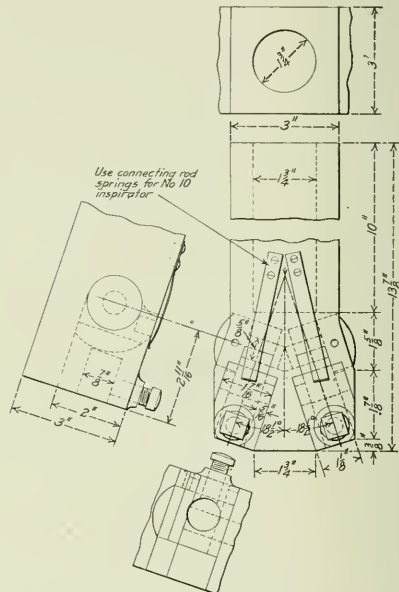

Tool for Finishing the Inside of Shoes and Wedges.

Strengthened by baving braces of greater sectional area applied.....	351
Additional support for crown sheet.....	116

The report is signed by John F. Ensign, chief inspector of locomotive boilers.

ELECTRIC RAILWAY COMPANIES.—The total number of electric railway companies in the United States January 1, 1912, was 1,209. They operate on 41,028 miles of track, have 91,457 cars, and are capitalized at \$3,267,960,542.—*Electric Railway Journal.*

ROLLING STOCK ON VICTORIAN RAILWAYS.—In view of the rapid increases which are now being made in the Victorian Government Railways' rolling stock, it is interesting to note that in the past 10 years the increases were relatively small. While the train mileage increased by 17 per cent., and the gross earnings by 46 per cent. between June, 1901, and June, 1911, the number of locomotives in use was increased by only 14, and the number of passenger and freight cars by 3,000. The rolling stock on June 30, 1912, consisted of 612 broad and 11 narrow gage locomotives, 1,331 broad and 21 narrow gage passenger coaches, 634 broad and 2 narrow gage box, 14,097 broad and 195 narrow gage other freight cars of all classes and sizes, and 18 broad-gage cars for the St. Kilda-Brighton electric line. It should be mentioned, however, that during this 10-year period 144 old locomotives were broken up, and that the total tractive power of the locomotives in use in June, 1912, was 9,250,000 lbs., against 7,250,000 in 1910.—*Consular Report.*

CAR DEPARTMENT

PORTABLE RIVET FORGE

By F. H. BABCOCK.

While portable rivet forges are common, the one in use in the shops of the Pittsburgh & Lake Erie at McKees Rocks, Pa., is an improvement over most of the arrangements generally used. Reference to the illustration will show that this forge includes a box for the fuel and that it has a drop grate operated by the movement of the drop door at the bottom of the air chamber.

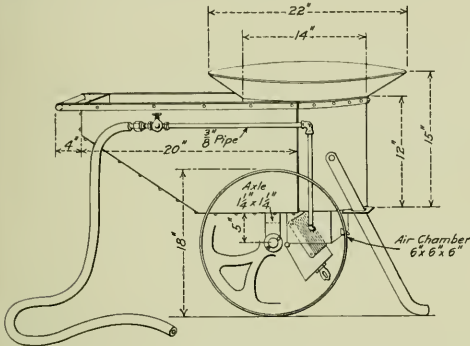

Portable Rivet Forge with Fuel Box Attached.

Both of these features assist in keeping the shop clean and make the work of the operator easier and the effectiveness of the forge greater. These forges, while cheap in construction, are substantial and will withstand hard usage. The barrel is lined with 2-in. firebrick which will last from six weeks to two months with ordinary care.

GRAIN CAR INSPECTION

By R. W. SCHULZE

General Foreman Car Department, Gulf, Colorado & Santa Fe, Cleburne, Texas.

During recent years much has been said and done towards improving conditions and lessening loss and damage claims due to grain shortage, and yet it appears as though these claims still exist and that the proper solution has not been reached. At many grain loading stations public scale weights are used, and in some cases the grain is loaded direct from the wagon into the car, while in others it passes through the elevator. Many farmers are very particular as to who they have drive their wagons on and off the scales. In a recent conversation with a retired farmer, he said that he had "sold his old darkey many a time on the end of the wagon tongue." These wagon weights are used as shipping weights and when a car reaches its destination it is not to be wondered at that the delivering weights sometimes show a shortage, which the shipper claims to be due to leaky cars.

It is possible, however, that sufficient attention is not given the selecting of cars for bulk grain loading. The agent, in many cases, has not the time and, in fact, does not inspect the cars to see what the true condition of the car is. He furnishes the shipper with a car number, which by chance is standing on his siding, and no attention is paid to the condition of the car. The shipper very often cares little as to the condition of the car he loads, and little assistance can be expected from some of them.

The inspection of grain cars has received a great deal of attention, and while it is the instruction of all railway managers to give them the very best attention possible, it is also understood that the only inspection that can be made of grain cars when loaded is an examination of the running gear, draft rigging and the general outside appearance of the car. The proper time to make an inspection is before the car is loaded. Under present conditions, as a rule, the only place where a thorough inspection can be made is at terminal points, where car inspectors are employed. Unless the railways employ car inspectors at their main grain loading stations this duty must necessarily fall to the agents, who as a rule understand very little of car construction and are not thorough and practical car men.

Even the most thorough inspectors will sometimes fail to discover a defect that will cause a small leak when the car is loaded and in motion. To overcome and repair such defects train crews should be instructed to look out for and report on their trip reports such leaks as may have developed on the line, as these cannot be located when the car is not in motion. Some of these small leaks are caused by grain working out through cracks in the siding or flooring or behind the grain strips. The lumber that is often furnished for siding and flooring is not thoroughly kiln dried, and therefore, shrinks more or less when applied to cars and the triangular grain strips do not in all cases fit up close to the siding.

The following practice should be required in grain car inspection, repairing and loading: All grain cars should be selected at terminals when possible to do so. These cars should be thoroughly inspected by a competent man, who, after making inspection, will attach to the side door of the car a grain inspection card, properly filled out and designating that car is fit for grain loading. The car must first be inspected for safety. The siding should be closely examined on the outside of the car, particularly behind the buffer block, and should be "hammer tested" for loose siding. The roof and side doors should also be closely examined from the exterior. The flooring should be carefully inspected and particular attention given to the condition over the center pins, around the draft bolt washers, and at the posts and braces. The lining and grain strips should be examined and close inspection given the grain strips to see that they are in proper place. The inside of the roof should be examined to ascertain if there are any signs of leaking. The side doors should then be closed to shut out the light and an inside inspection made, and if daylight can be seen the cracks or crevices should be repaired.

After the cars are placed for loading they should be properly coopered, using burlap strips over the joints between the door posts and the grain doors, and between the grain doors and the floor. After the coopering is done a joint inspection as to the condition of the interior of the car should be made by representatives of the shipper and of the railroad company. The record of this inspection should be made on a blank, especially prepared for this purpose and used as shippers' acceptance of the car. This would eliminate the claim of the shipper that an unfit car had been furnished, but would not bind him against a legal or just claim.

The present $2\frac{1}{2}$ in. x $2\frac{1}{2}$ in. triangular grain strip should be changed and made $2\frac{3}{4}$ in. x $3\frac{3}{4}$ in., and should be sawed with an obtuse angle of not less than 105 deg. This would keep the top of the grain strip against the siding, which would prevent the grain from working between the grain strip and siding.

All material used for flooring and siding should be thoroughly kiln dried and material partially dried should not be used.

Train crews should furnish trip reports covering all grain leaks,

the original report to be handed to inspectors on arrival at terminals.

The traveling car repairers should be located at the principal grain loading stations during grain seasons; one man to look after two or three stations or more, as conditions will permit. The car repairer must keep a careful and accurate record of all cars inspected, their condition and what repairs if any were made before the car was given to the shipper. His report must indicate the general condition of the car, the condition of the siding, particularly behind the buffer block; condition of roof and side doors, flooring around draft bolts and center pins, and must show the date and station at which inspected. All of this information is necessary on each car, not only as a record, but also so that the general managers will realize that all cars are inspected by an expert inspector before they are carred by him and set for unloading.

The writer has had an opportunity to try such a method of grain car inspection during several grain seasons. The results from the beginning were gratifying. Shippers were satisfied, and records of cars inspected were kept in such shape that unjust claims could be investigated. The grain season was completed with many less claims for leaky cars than ever before.

INCREASING AXLE LATHE OUTPUT

By C. L. DICKERT

Assistant Master Mechanic, Central of Georgia, Macon, Ga.

A short time ago it became necessary to greatly increase the output of a car axle lathe in order to keep up with the regular repair work and in addition to provide the axles for one hundred new freight cars which were being built at the Macon shops. The work of turning new axles was performed in the customary manner, on a day work basis, and the lathe turned out nine new axles in nine hours. A careful study developed that six changes of tools were required in the finishing of each axle; in each case the tool had to be carefully set square with the work and it required the assistance of a helper and a

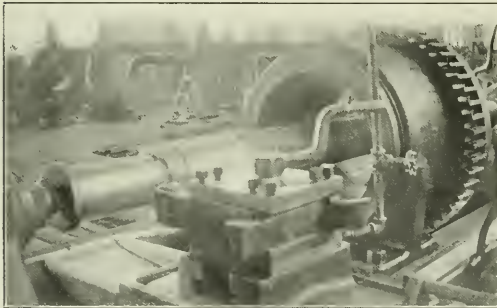

Axle Lathe Fitted with a Turret Tool Post.

long wrench to tighten it sufficiently to take the cut. Considerable time was also required in clamping the axle in the machine.

As a result of this study a turret type of tool holder which will hold four tools, three cutting tools and a roller, was designed so that the assistance of the helper was dispensed with and the output of the lathe was more than doubled. The machine is now turning out twenty new 4 1/4 in. x 8 in. axles in nine hours. The operator is still on the day work basis and it is very probable that if he was working on piece work, twenty-five new axles would be finished in nine hours, as an axle is often finished from floor to floor in twenty minutes.

The tool holder is simple in its arrangement, and consists of a base plate properly shaped to fit in the carriage and held

in place by a vertical shaft or pin which has a shoulder at the top of the base plate and screws into a block in the T slot. On top of the base plate is a ring about 3/8 in. high and 1/2 in. wide, concentric with the center pin. On one side of the base plate a lip 1/4 in. in height is so placed as to center and brace the revolving head. This head has a groove to fit over the ring on the base plate and is arranged for carrying four tools, each of

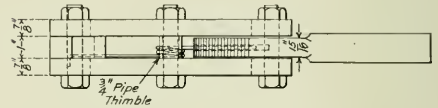
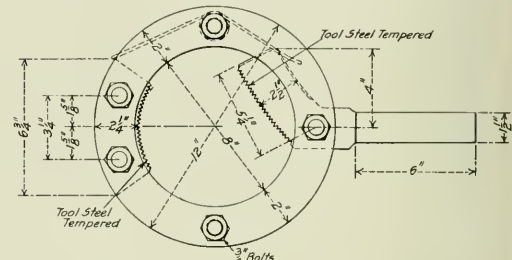

Quick Acting Driver for Car Axle Lathe.

which has two set screws. A coil spring is fitted round the center pin and raises the revolving head when the clamp is released so that it can be swung clear of the shoulder on the base plate. With this arrangement the tools can be set with considerable less overhang than is required with the ordinary tool post and a much shorter tool is used. On a test it has been found that the tools will stand feeds and cuts that will stall the motor driving the lathe.

A quick adjusting driver was also designed which has reduced the time of chucking and removing the axle from the machine

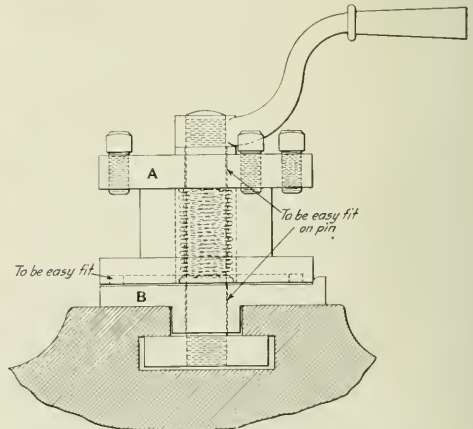

Turret Tool Holder for Axle Lathe.

by three or four minutes. It is shown in one of the illustrations and all that is necessary is to slip it over the axle to the proper position; when the lathe is started it will automatically grip the axle. When the work is finished the driver is released in one motion and is slipped back on the overhang of the spindle. A spring is provided to hold the grip when the machine is running without load. Two drivers are necessary on the larger size axles.

NINETY-TON HIGH SIDE GONDOLA CAR

Developed on the Norfolk & Western and Equipped
With Specially Designed Six-Wheel Equalized Trucks.

In view of the serious troubles that have occurred in the past with wheels and axles even under cars of 100,000 lbs. capacity when carrying the frequent large overload, it has seemed undesirable, except in a few special cases, to place cars of larger size on four-wheel trucks. A six-wheel truck must of necessity include some form of equalization, and heretofore has usually been considered to require a frame with pedestals in which the journal boxes have a free vertical movement. That type of

amounts of coal and ore that will give a considerable increase in the percentage of revenue load in a train.

These cars are of the high side gondola type and measure 9 ft. 6 in. in width, 6 ft. 6½ in. in height and 45 ft. 6¼ in. in length on the inside of the body. This gives a cubic capacity of 2,829 cu. ft. level full, and 551 cu. ft. in a 30 deg. heap, making a total of 3,380 cu. ft. Pocahontas run of mine coal is taken at 58.85 pounds to the cubic foot. The first load of coal hauled

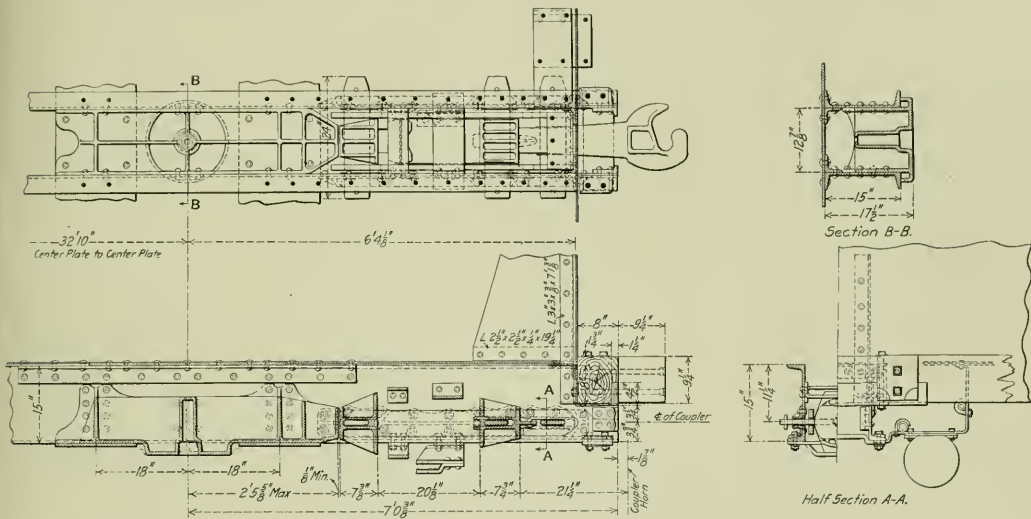

This drawing shows the construction for a Farlow-Sessions draft gear. A Miner draft gear is used on the car.

Arrangement of Draft Gear on 90-Ton Gondola Car; Norfolk & Western.

truck is not well suited for freight service, and in designing a car of 99 tons maximum capacity on the Norfolk & Western, an entirely new six-wheel truck has been developed. It permits the use of the ordinary 5½ in. x 10 in. M. C. B. journal box rigidly secured to cast steel side frames which are so arranged as to act as equalizers without the application of extra parts. If this truck proves to be all that is expected, an opportunity will be given for the operation of cars on those lines handling large

in the car was 95 tons, with some corners not quite filled out. The maximum outside dimensions are 48 ft. 4¾ in. over bumping blocks, 10 ft. 4½ in. to the top of the side of the light car, 11 ft. 1 in. to the top of the brake shaft and 10 ft. 4½ in. extreme width over the body. The cars are provided with eight small drop doors in the floor, which are operated by a simple type of winding chain and shaft mechanism. The design is of the continuous center sill type. Cross beams or diaphragms are in-

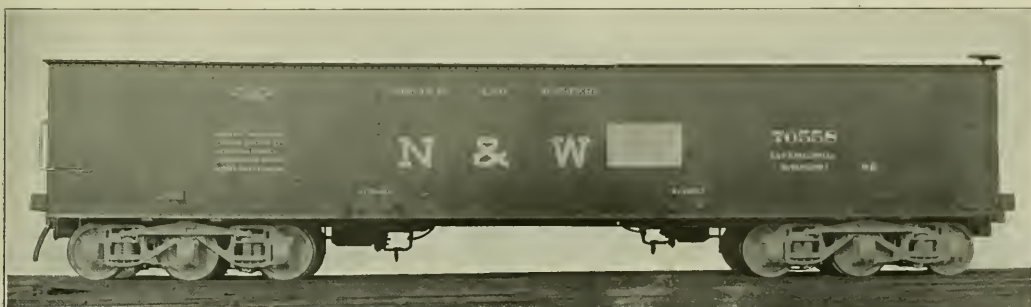

Ninety-Ton Gondola Car Mounted on a New Design of Six-Wheel Truck.

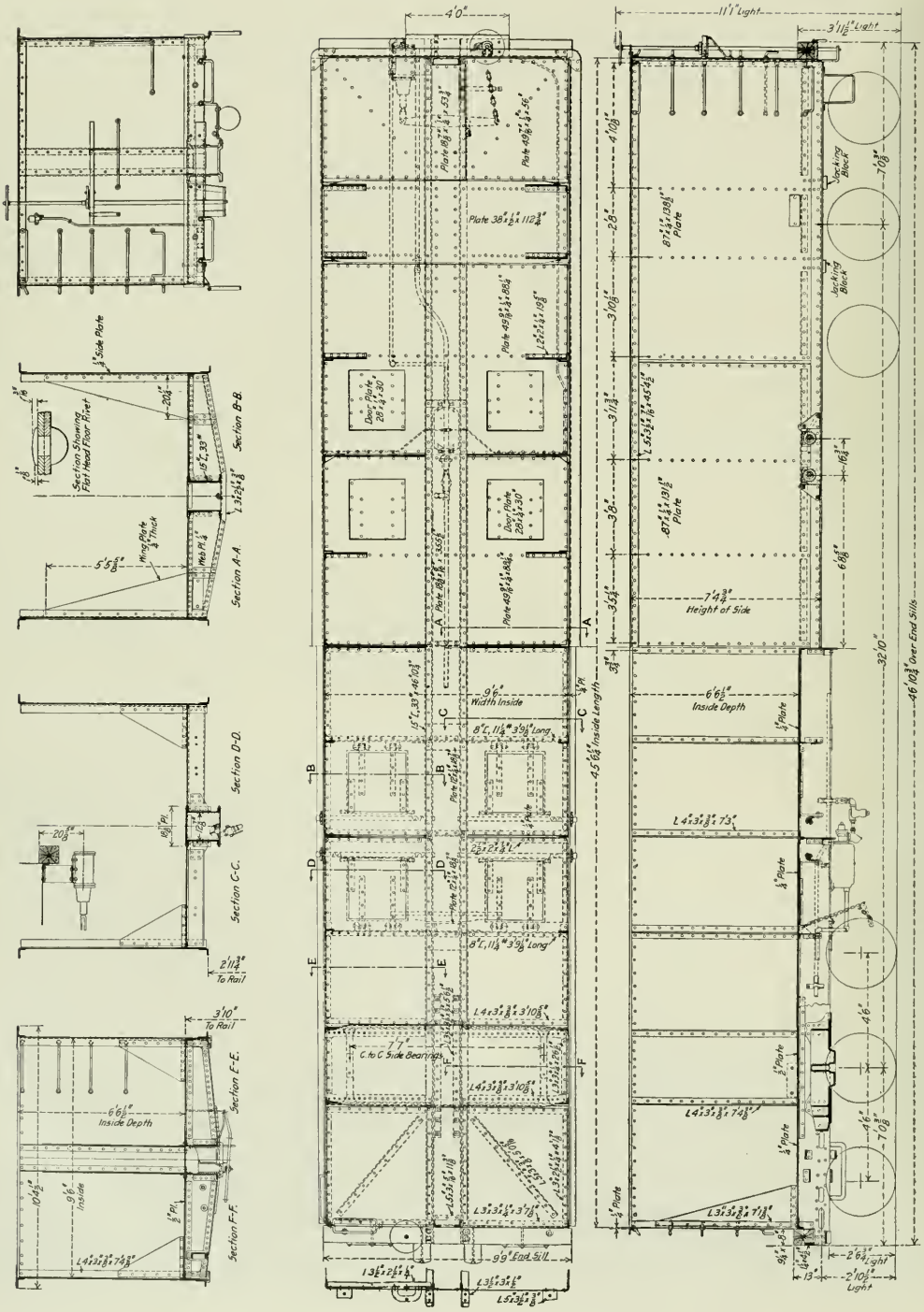

Elevations, Plan and Sections of a Ninety-Ton, High Side, Gondola Car, Norfolk & Western.

troduced to prevent deflection of the center sills, which, in a car of this length, would prove serious. This results in transmitting the load to the sides of the car which carry it, as plate girders,

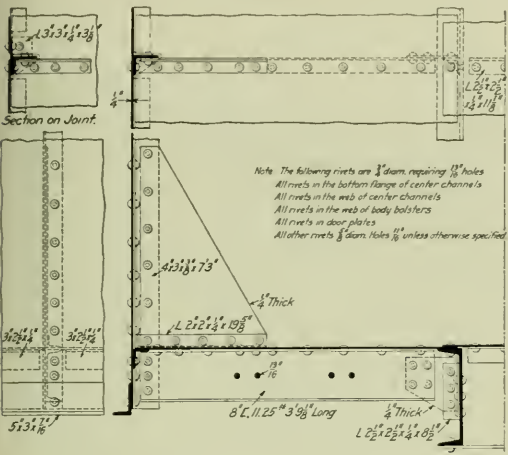

Detail Showing Arrangement of Floor Beams.

to the bolsters, whence it is transferred to the center plates. The stakes are on the inside and while interfering to a limited extent with lading other than coal, ore, or other material, has a num-

side of the member. It has also been possible, with inside stakes, to do away with body cross ties, which are undesirable and form a fertile source of repair bills. Inside stakes are of particular advantage in this case, inasmuch as they form the means of powerful side stiffeners near the top chord angle of the side plates. As this car was designed for use in a dumping machine, it will be seen that such construction is necessary.

Commercial shapes are largely used, special castings being incorporated at a few points only. The center sill consists of two 15 in. 33 lb. channels which are continuous for the full length over end sills. These are set 12 7/8 in. apart with the flanges extending outward and a 5/16 in. top cover plate extends continuous between the bolsters. The edges of the 3/4 in. floor plates extend under this cover plate and are secured to the center sills by the same rivets. At the double body bolster there is a 1/2 in. plate 38 in. in width, and extending across the car, which forms the floor at this point. Between this and the end of the car the center sill cover plate is 3/4 in. thick. At the bolster the center sill is reinforced at the top by 3 1/2 in. x 3 1/2 in. x 1/2 in. angles arranged as shown in the illustration. The three cross bearers each consist of a 3 in. x 2 1/2 in. x 3/4 in. angle continuous under the center sill and secured to the bottom of the side posts at either end. They also include a 1/4 in. web plate on either side between the center sill and side. This plate is made in two parts, the outer end for a distance of 20 1/4 in. consisting of an extension on the wing or gusset plate which is carried nearly to the top of the sides. The remainder is a properly shaped plate which extends only to the floor. The joint between the two is made with a splice plate 1/4 in. thick. The top member of the cross bearer consists of two 2 1/2 in. x 2 in. x 1/4 in. angles extending

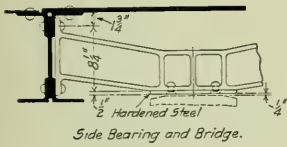

Side Bearing and Bridge.

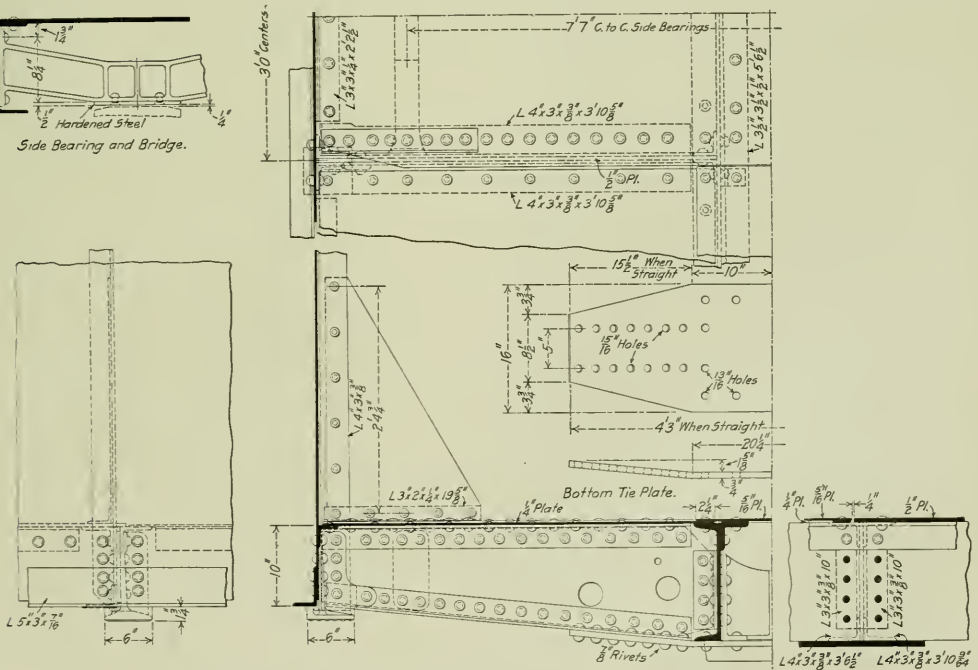

Details of Bolster Construction on the Norfolk & Western 90-Ton Gondola.

ber of advantages. With outside stakes, the punching of the upper flange of the side of the car for rivets detracts materially from the strength of the section, this portion being in tension; while with inside stakes the rivet holes are on the compression

between the center sill and the side plate. The floor plates are of such a size that the joints come at the cross bearers and the edges are riveted to the angles.

Midway between the cross bearers and also between them and

the bolsters are floor beams, consisting of 8 in. 11½ lb. channels with the outer ends riveted to the bottom of the side posts and the inner ends secured to the center sills through the medium of ¼ in. gusset plates and angles fastened on the webs of the center sill channels. The smaller wing or gusset plates are located above these floor beams and consist of triangular ¼ in. plates about 28 in. wide at the bottom and about 31 in. high riveted to the side posts and secured on top of the floor plates by angles of the proper length, the rivets holding the angles also extending through the flanges of the channels which form the floor beams. At both the floor beams and cross bearers there is a short reinforcing angle riveted to the top cover plate of the center sill, which is also the floor plate.

In view of the large weight concentrated at the center plate it was necessary to design a bolster of unusual strength and rigidity which would properly convey the load from the side girders, which carry the greater portion of it. Practically two bolsters, set 36 in. apart, have been employed and a large casting fitted between the center sill channels connects the two and includes the center plate. Each of these bolsters consists of a ½ in. web plate and a pair of 4 in. x 3 in. x ⅜ in. angles at the top. Similar angles at the bottom, which in both cases extend only from the side plate to the flange of the center sill channel, are also used. A ¾ in. plate, 16 in. in width at the center and tapering to a width of 8½ in., extends under the center sill and the center plate casting and is riveted on either side to the flanges of the bottom angles. At the junction of the side plate and each of the bolsters there is a jacking casting, formed to fit around the bottom end of the side post and strengthen the construction at this point. This gives four jacking points at each end of the car. A ½ in. top cover plate of sufficient width to include both parts of the double bolster extends across the car and is secured to the side plate by an angle. The side bearings are attached to

in length. The vertical joints between these sheets are made by ¼ in. splice plates on the inside, and the double stakes at these points are set in enough to allow for them. This plate girder, of which the side plates form the web, has a 5 in. x 3 in. x 7/16 in.

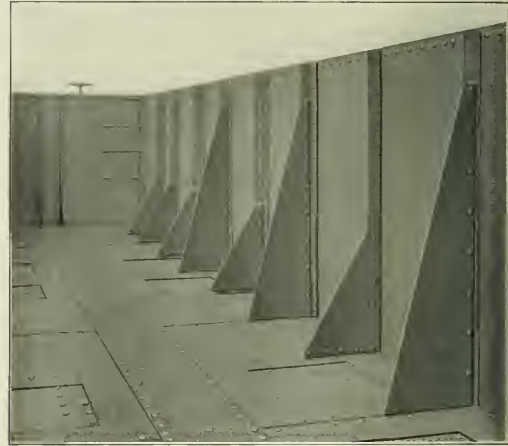

Interior of the 90-Ton Gondola Car.

angle at the bottom with the flange extending outward, and a 5 in. x 3½ in. x 7/16 in. angle at the top. Both angles are continuous for the full length of the car. There are no diagonal braces and the plate is stiffened by the 4 in. x 3 in. x ⅜ in.

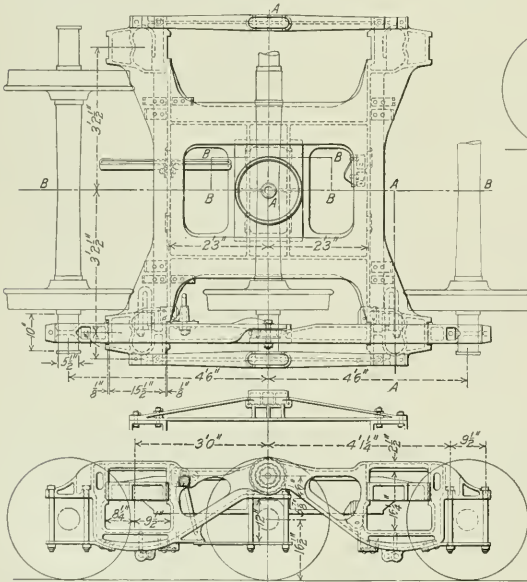

Six-Wheel Equalized Truck with Journal Boxes Secured to the Side Frames; Norfolk & Western.

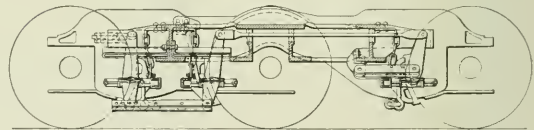

Section B-B-B-B-B

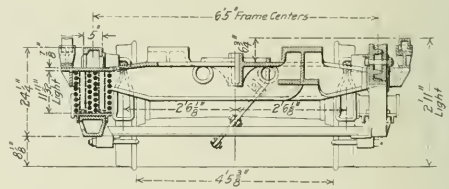

Section A-A-A-A

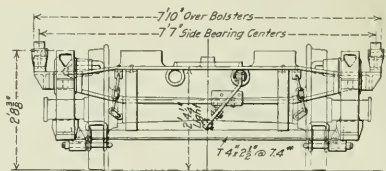

a properly shaped casting forming a bridge between the two bolsters and are located at a radius of 3 ft. 9½ in. from the truck center.

A large proportion of the load is carried by the sides of the car which consist of ¼ in. steel plates 87 in. in width and 138 in.

angles forming the stakes, which are spaced as shown on the drawings. These angles continue to the bottom of the side plate and are fastened to the cross bearers and floor beams. As before mentioned the wings or gussets of two different sizes form the principal source of stiffness for these girders.

The construction at the end is practically the same as at the sides. The corner posts, however, are $3\frac{1}{2}$ in. x $3\frac{1}{2}$ in. x $\frac{3}{8}$ in. angles. The end sill is of oak 8 in. x $9\frac{1}{4}$ in. and the center sill channels are cut out at the top sufficient to allow its introduction. The end sheet of the car extends behind the end

supported below the center sills just inside of the truck and the train line passes between the two center sill channels for the distance between the bolsters. At the bolsters and to the end of the car it runs outside of the sills. The brake cylinders are located just under the end sill, there being one at either end of



Truck with Side Bearing Bridge Removed to Show the Hinge Joint.

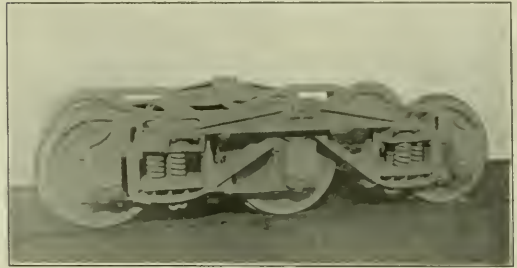

Side View of the Six-Wheel Truck Complete.

sill which is also reinforced by the end posts and the angle to which the floor plates are secured.

The car has a Miner friction draft gear with Miner attachments. It will be seen that the gear is attached directly to the center sills with the usual reinforcing castings on the webs

the car connected to the adjacent triple valve and reservoir. The hand brake is located on the opposite side of the car from this cylinder and connects to the opposite end of the same brake lever. This location of the brake cylinder is somewhat in the nature of an experiment and arrangements have been made for

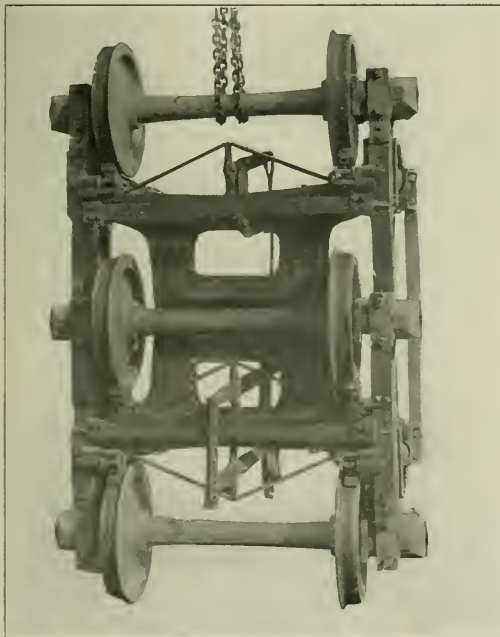

Under Side of the New Six-Wheel Freight Car Truck.

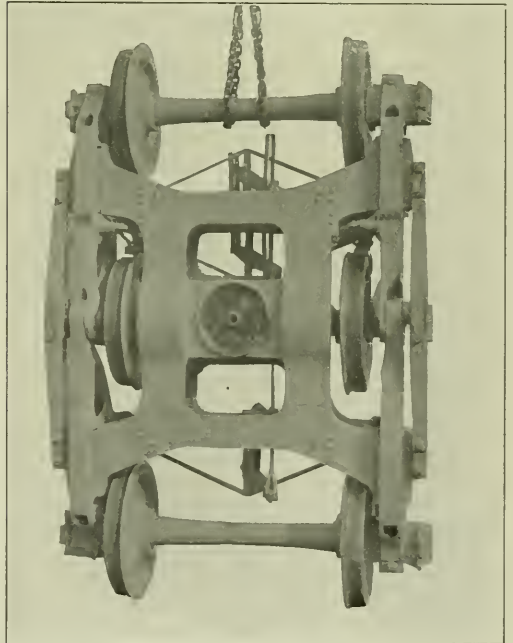

Top View of the New Six-Wheel Freight Car Truck.

and that the coupler yoke passes below the wooden end sill, the carrier iron being bolted to the bottom flanges of the center sills. The rear casting of the draft gear has a minimum clearance of $\frac{1}{8}$ in. from the extension on the center plate casting. The center of the line of draft is $3\frac{3}{4}$ in. above the bottom of the center sill channels.

Each car has two sets of brake rigging, including auxiliary reservoirs, triple valve, brake cylinder, etc. The reservoirs are

placing the cylinders between the trucks at about the usual locations if the present location should prove unsatisfactory.

A six wheel equalized truck without pedestals is a novelty and has been developed for use on this car by W. H. Lewis, superintendent of motive power and John L. Pilcher, mechanical engineer. It consists of a cast steel side frame in two parts and of peculiar shape arranged to carry three journal boxes at 4 ft. 6 in. centers. Directly above one of the journal boxes the cast-

ings are arranged for a swivel connection. In these two castings the openings for the ends of the bolster and for the group of coil springs are spaced at 3 ft. centers from the center axle, bringing them 18 in. from the outer axles. One of the illustrations clearly shows the form and arrangement of the double cast steel bolster which carries the center plate. This rests on four nests of three double coiled springs each and has an extension beyond the side frame to allow the attachment of a bridge which carries the side bearing at the center of the truck. This bridge is bolted to the bolster extensions. Each group of springs consists of three nests of an outside coil of $1\frac{1}{4}$ in. diameter wire, 5 in. outside diameter, with an inside coil of $\frac{9}{16}$ in. wire, $2\frac{1}{4}$ in. outside diameter. The springs work at 40,000 lbs. stress in the bar when the car is loaded to a 10 per cent. overload. The free height is $11\frac{1}{2}$ in. with a total deflection, free to solid, of $1\frac{3}{4}$ in. The swivel joint in the side frame is so formed as not to give any shearing action on the bolt. This arrangement is shown in the sectional view through the center of the truck. This view also shows that the bolster is not as heavy as it might appear in the photograph. There are two 4 in. x $2\frac{1}{2}$ in. tees bolted to suitably formed lugs on the bottom of the side frames and located midway between each of the pairs of wheels. These take the place of sand planks which are not feasible when the bolsters are arranged in respect to the wheels as they are in this case. It is possible that these cross ties may be omitted altogether. Tests will be made to determine this.

The brake rigging on each truck is comparatively simple and arranged in a manner similar to a six-wheel passenger truck. Designs for carrying the brake beams from either the side frame or the bolsters have been prepared. The one given here shows the former. This truck has been patented by Messrs. Lewis and Pilcher.

The weight of the two trucks alone is 29,800 lbs., and of the car complete with trucks is 65,200 lbs., giving a total weight with lading, including a 10 per cent. overload, of 263,600 lbs., or an average weight per axle at the rail of slightly less than 44,000 lbs. With a 10 per cent. overload the proportion of revenue lading to total weight will be about 75 per cent., and it will be over 73 per cent. without the overload. It is expected that it will be possible to reduce the weight slightly, especially that of the trucks in later cars.

The entire car has been carefully designed with a view to ease of manufacture. To this end all plates and shapes are laid out for multiple punches, and care has been taken that if the plates, etc., come within the customary variations in shearing, no reshaping will be necessary. Duplication of parts has been carefully considered with good results.

A STRONG BOX CAR END

The New York Central & Hudson River is applying a steel end to many of its old box cars and expects to specify it on new equipment. Ordinary box car construction develops marked weaknesses at two points—the draft sills and the ends of the car. In repairing and increasing the capacity of some of its older box cars the New York Central has found it advisable to apply steel underframes. This remedied the difficulty with the draft sills and it then became desirable to overcome the next most important weakness—the ends. This was accomplished by the development of a steel end, as shown in the illustrations, and several hundred cars are now equipped with it. The New York Central Lines west of Buffalo have also applied it in considerable numbers.

The most important advantages are that the greater strength of the steel end prevents damage due to the shifting of the lading and thus reduces the cost of repairs and of damage to the lading, and of the time out of service because of such damage. The steel construction is lighter than that of wood;

the old style wooden end on a certain class of New York Central cars weighed 1,863 lbs.; a better design of reinforced wooden end weighed 1,790 lbs.; and the steel end for the same class of car weighs 1,607 lbs. No end posts are used with the steel end

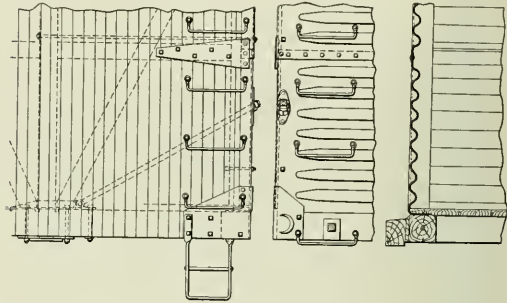

Details of Application of Steel End to New York Central Box Cars.

and the inside length of the car is thus increased by about one foot, with a corresponding increase in the cubical contents of the car. There is no possibility of the ends becoming loose and thus allowing grain or similar lading to leak out, as is so often the case with the wooden construction. If the end is seriously

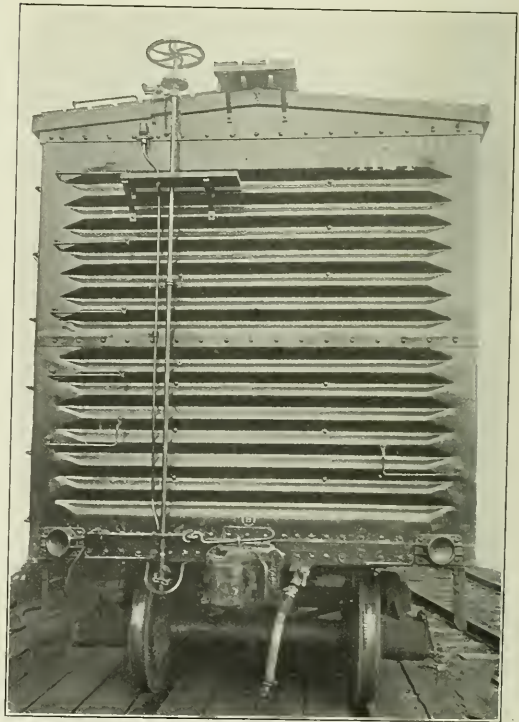

Steel End As Applied to New York Central Box Cars.

damaged it has a considerable value as scrap, while the wooden end is valueless.

The end is made in two parts to facilitate erection on the rip tracks or where an overhead crane is not available. If desirable

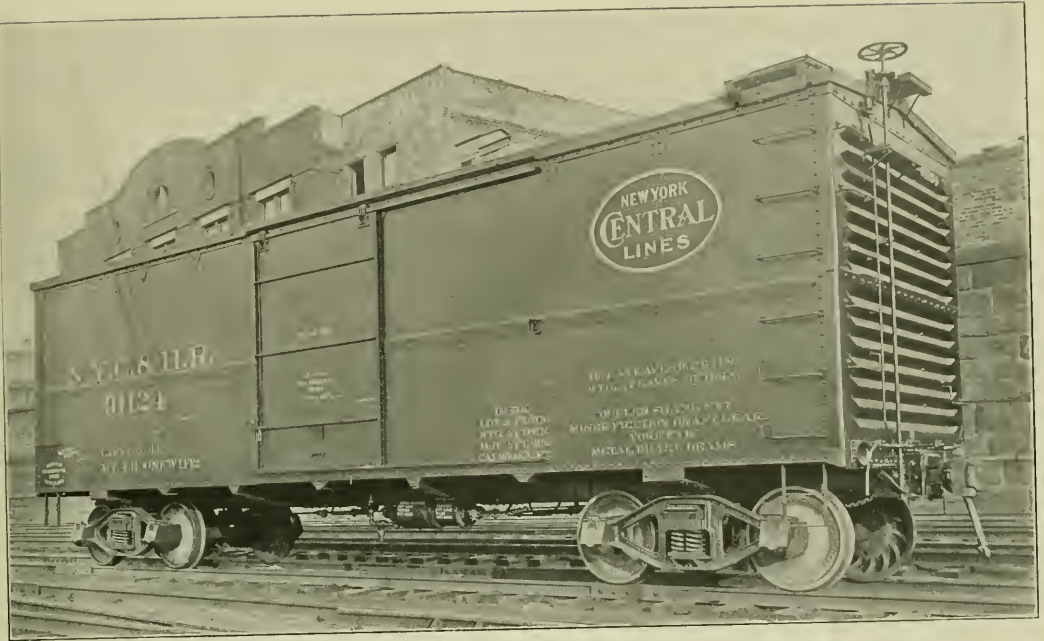

Steel End Applied to Experimental Steel Box Car; New York Central & Hudson River.



Steel End Applied to 40-Ton Wooden Box Car; New York Central & Hudson River.

the two parts may be riveted together in advance if it is desired to apply them at shops where there is a good crane service. The two-part end has the additional advantage of reduced expense for replacement if one-half should be seriously damaged and need renewal. Since the lower half of the end is usually subjected to the greater punishment due to shifting loads it is made slightly heavier than the upper half, being $\frac{1}{4}$ in. thick, as compared to $\frac{3}{16}$ in. for the upper half. The reduction in thickness of the upper half is estimated to save about 300 lbs. in the weight of the car. The lower half of the end is said to be equivalent in strength to a flat steel plate $\frac{7}{8}$ in. in thickness.

One of the illustrations shows the application of the end to a wooden box car, while another shows it applied to the all-steel box car which is being experimented with on the New York Central. When applied to a wooden car, the lower edge of the end is flanged and fits under the floor plank, effectually preventing any possibility of leakage of grain at the end. The manner in which the end is tied by a $1\frac{1}{2}$ in. rod to the combination casting which forms a pocket for the foot of the post and braces is also shown on the drawing. The door is manufactured by the Imperial Appliance Company, Chicago.

FREIGHT CAR TRUCK EXPERIMENTS*

About the middle of the year 1910 the American Steel Foundries reported the results of a series of tests on square and loose freight car trucks made by Professor Endsley of Purdue University at the company's plant at Granite City, Ill. These tests were described in the *American Engineer and Railroad Journal* of May, 1911, page 192, and while they presented interesting data it was shown that further tests on tracks of different characteristics would add greatly to its value. The first set of tests was made on a special track consisting of a sharp incline, having a drop of about 36 ft., followed by a short tangent of 30 ft., then by a 22 deg. curve 303.3 ft. in length, the outer rail being raised $4\frac{1}{2}$ in., followed by another tangent of 257 ft. and ending in an incline with a vertical rise of 20 ft. The curve had a rise of 3 ft. $10\frac{3}{4}$ in. in its length and the tangent following of 11.73 feet.

The second set of tests was conducted during the summer and fall of 1911 at the Granite City plant by Professor Endsley. Six tracks were used in the tests as follows:

A tangent 591 ft. long, running out from the incline having a drop of 36 ft. At the outer end of this track there was another incline.

Two tracks of 3 deg. curvature and 450 ft. long with a tangent of 28 ft. at both ends of each track. One track was laid with new 75 lb. rails and had a radius of 1,910 ft.; the other with badly worn old 75 lb. rails having a radius of 1,910 ft. $5\frac{1}{2}$ in.

Two tracks of 6 deg. curvature and 420 ft. long with a tangent of 25 ft. at one end of each track and 178 ft. at the other. These were laid as above with new and old 75 lb. rails; the new rails had a radius of 954 ft. $9\frac{5}{8}$ in. and the old ones a radius of 955 ft. 3 in.

A track of 12 deg. curvature, 250 ft. long, with a tangent of 25 ft. at the outer end and 330 ft. at the inner end. This track was laid with 75 lb. new rails and had a radius of 478 ft.

The gage of the tangent, the 3 deg., and the 6 deg. tracks was 4 ft. $8\frac{1}{2}$ in. and that of the 12 deg. track was 4 ft. 9 in.

TRUCKS TESTED.

The tests were conducted on an arch bar truck and an Andrews side frame truck. The arch bar truck conformed closely to standard practice in its design and details of construction, and was the same as truck B used in the previous tests, weighing 22,886 lbs.

The Andrews side frame truck was of standard design with the exception of a heavier cast-steel bolster which brought the

weight of the truck, with 650 lbs. wheels, up to 12,034 lbs., which, with the cast-steel block gave a total weight of 22,400 lbs. A 13-in. channel was used as a spring plank and was fastened to each side frame by eight tapered bolts instead of being riveted, as is customary. The truck was tested both with and without these bolts. When the bolts were removed, the side frames were spaced apart the proper transverse distance by a boss on each end of the spring plank, which fitted into recesses drilled in the center of the spring seat of each side frame. These two conditions are called the square and loose trucks.

TRUCK WHEELS.

Thirty-two different wheels were used in such combinations as to make ten sets. In seven sets cast iron wheels were used while the Davis cast-steel wheels were used in the other three. New, medium new and old wheels were used so as to obtain as wide

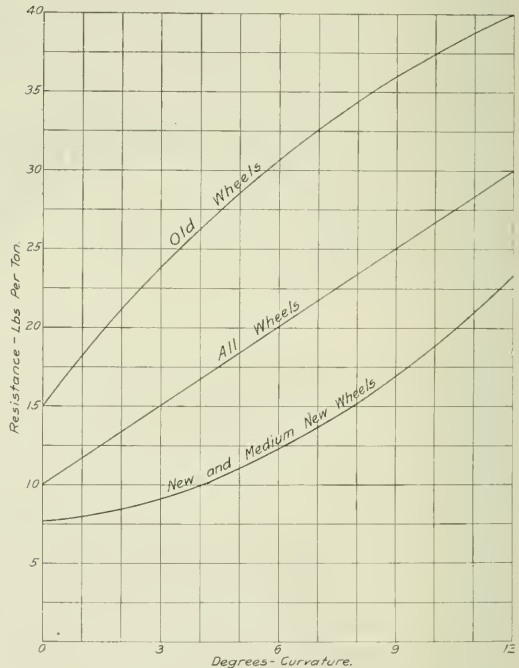

Fig. 1—Resistance Curves With Different Conditions of Wheels and on Various Curves.

a variation in wheel conditions as is met with in practice. The wheel sets were made up as follows:

Set A:—New cast iron wheels ground to M. C. B. standard contour and of the same diameter.

Set B:—Non-mated new cast iron wheels, one pair measured $\frac{1}{8}$ in. difference in circumference and the other pair $\frac{1}{4}$ in.

Set C:—Davis cast steel wheels, M. C. B. contour, exactly mated.

Set D:—Medium new cast iron mated wheels.

Set E:—Same as Set D except that one diagonal pair of wheels were interchanged making the wheels unmated and the circumference of the wheel on one side $\frac{1}{8}$ in. greater than on the other.

Set F:—Old cast iron mated wheels.

Set G:—Old cast iron non-mated wheels. There was a difference of $\frac{9}{16}$ in. in the circumference of one pair and $\frac{1}{2}$ in. in the other. The large wheels were on the same side of the truck.

Set H:—Medium old cast iron non-mated wheels. One pair was mated and the other had a difference of $\frac{1}{2}$ in. in circumference.

Set I:—Special mated Davis cast steel wheels, made with height of flange $\frac{3}{4}$ in. and with no coning on the treads.

Set J:—Same as Set I except for a very slight non-mating.

*Abstracted from Professor Endsley's report to the American Steel Foundries.

RESULTS OF TESTS.

The method of testing was the same as in the first tests; also the determination of velocity and resistance in pounds per ton.

Tests to the number of 184 were made with the Andrews side frame truck and 146 with the arch bar truck. One of the principal objects of the tests was to obtain sufficient data on which to establish a conclusion as to the effect of different degrees of curvature on frictional resistance. The curves in Fig. 1 were obtained by finding the average resistance in pounds per ton for all truck and wheel conditions for new, medium new and old wheels, as recorded on the Andrews side frame truck. The straight line for all wheels which was established from the results from ten different sets of wheels, conforms to the generally accepted theory that the frictional resistance, for average operating conditions, increases in direct proportion to the degree of curvature. The only exception to this was the position of the point on the 3 deg. curve which was lower than that shown in the diagram. This may be due to the fact that the coning on the wheels keeps the flange out of contact with the rail, thus reducing the friction due to curvature up to about the 3 deg. curve, but at some point between the 3 deg. curve and the 6 deg. curve, the difference in length of the two rails is so great that the effect of coning is overcome.

with the corner of the new rail at a point farther in advance of the point of contact of the tread of the wheel and the top of the rail than it would on a rail which has the corner worn away. In this way a greater flange friction would result, due to this increased leverage.

INFLUENCE OF WHEEL CONDITIONS ON TRUCK RESISTANCE.

The condition of the flanges and the tread of a set of wheels has quite an influence on the frictional resistance of a truck, regardless of its type. Table I shows to what extent the frictional resistance was affected by wheel contours. The sets of wheels are divided in five groups, as follows: Mated wheels (Sets A, C and D); non-mated new and medium new (Sets B and E); non-mated old (Sets F and G); non-mated medium old (Set H); and special, no coning (Sets I and J).

TABLE I.—AVERAGE RESISTANCES FOR DIFFERENT GROUPS OF WHEELS.

Track.	Wheel Set.				
	A,C,D	B & E	F & G	H	I & J
Tangent	6.90	7.53	12.82	9.96	14.35
3 deg. curve.....	8.43	7.99	19.50	14.08	21.27
6 deg. curve.....	10.40	11.43	30.03	20.22	33.79
12 deg. curve.....	20.10	25.20	37.70	28.16	45.97

From these values it is obvious that the condition of the mating and of the contours of the wheels has a very important bearing on the friction resistance of a truck. The flanges and treads of the first two groups of wheels were in good condition. The

The new and medium new wheel curve was obtained from tests

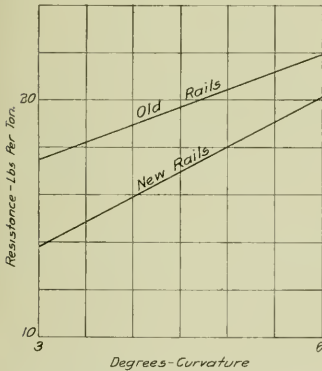

Fig. 2—Resistance Curves of All Wheels on Old and New Rails.

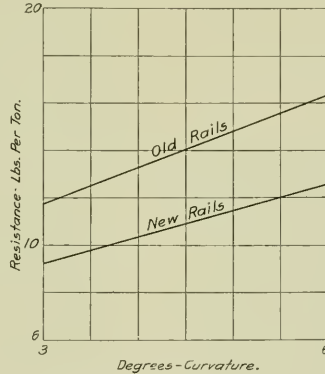

Fig. 3—Resistance Curves of New and Medium New Wheels on Old and New Rails.

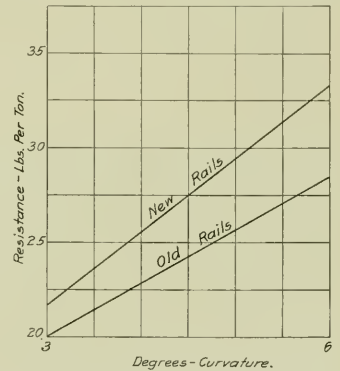

Fig. 4—Resistance Curves With Old Wheels on New and Old Rails.

made with sets A, B, C, D, E and H. Thus it is seen that when only good wheels are used the line is curved downward.

The curve shown for old wheels represents the relation that existed between the frictional resistance and degrees of curvature when the worst set of wheels were used, namely, Set F. This line curves in the opposite direction from that for new and medium new wheels.

three remaining groups produced considerably more friction, due to the high and sharp flanges and to the absences of coning. From these results it is entirely obvious that the wheels should have as nearly perfect contours of flanges and treads as is practicable and that the wheels should be mated.

COMPARISON OF SQUARE AND LOOSE TRUCKS.

The Andrews side frame truck was tested in both the loose and the square condition and the following diagrams were plotted from these tests. All of the ten sets of wheels were used. Fig. 5 shows resistance for all wheels tested on the new rails. The resistance curve for new and medium new wheels (sets A, B, C, D, E and H) are shown in Fig. 6. From Fig. 5 it will be seen that the saving in favor of the square truck varies from 3.54 per cent. on a straight track to 30.47 per cent. on a 12 deg. curve, and, taking 4 deg. as the average main line curve, the saving is 20.72 per cent. in favor of the squared truck, which checks very closely with the 1911 report.

EFFECT OF HOLDING TRUCK OUT OF SQUARE.

The arch bar truck, as already mentioned, was so constructed that it could be held out of square any desired amount. The average resistance for all wheels used in these tests, which were

INFLUENCE OF OLD RAILS.

The method of testing the old rails was the same as the new, so that the results are comparable. The curves shown in Fig. 2 were plotted from an average of all runs for all wheels used on the Andrews side frame truck and only on the 3 deg. and 6 deg. tracks. The per cent. increase of friction of the old rails over the new on the 3 deg. curve was 21.7 and on the 6 deg. curve 7.9.

Fig. 3 shows resistance for wheel sets A, B, C, D, E and H. The increase of friction of the old over the new rails on the 3 deg. curve was 20.8 per cent. and on the 6 deg. was 25.6 per cent.

Fig. 4 was plotted the same as Figs. 2 and 3, but the worst set of wheels was used. This difference between the resistance due to curvature on old and new rails when old wheels are used may be caused by the high flange of the old wheel coming in contact

sets A, D, E and F, and for all runs made on each track and for each amount the truck was held out of square was plotted and certain points in the curves are compared in Table II. It will be noted that on the tangent and on the 6 deg. and 12 deg. curves there was a decided change at 0.8 in. and that on the 3 deg. track this break occurs between 0.4 in. and 0.8 in.

TABLE II.—AVERAGE RESISTANCE FOR ALL WHEELS AND RUNS FOR ARCH BAR TRUCK.

Track.	Amount Truck Was Held Out of Square (Inches).					
	0	0.4	0.8	1.2	1.6	2.0
Tangent	11.25	13.25	14.75	20.00	25.50	31.25
3 deg. curve.....	15.75	16.00	19.60	23.25	28.06	34.40
6 deg. curve.....	21.75	22.50	23.40	27.25	31.00	34.75
12 deg. curve.....	24.00	25.80	27.75	30.75	33.75	36.75
					40.00	

USE OF WINTER AND SUMMER OILS.

Tests were also made to determine the frictional resistance due to the use of winter and summer oils. They were made in the first week in November. The Andrews side frame truck with mated Davis cast steel wheels was used; the truck was square and was run on a tangent track. The analysis of the oil was as follows:

	Summer Oil.	Winter Oil.
Flashing point (degs. F.).....	386	340
Burning point (degs. F.).....	420	317
Specific gravity (Baume).....	21.5	24.5
Loss at 100 deg. F. for 3 hours.....	0.001	0.017
Ash (per cent.).....	0.05	0.03
Cold test (degrees at which it flows).....	55	32
Viscosity at 350 deg. F. (time in seconds for 100 c. c. to flow from Dudley pipette).....	39	34

One hundred and forty-six tests were made and the average

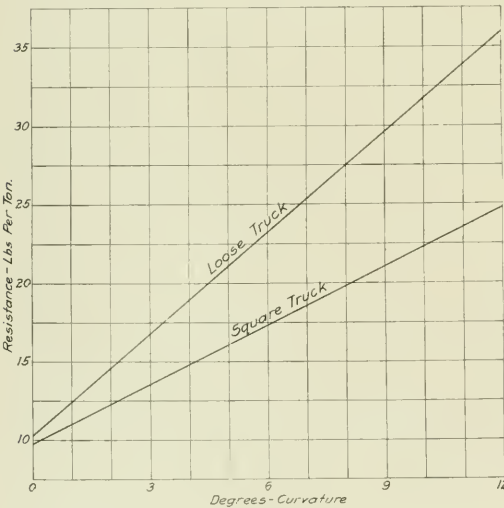

Fig. 5—Resistance Curves of Loose and Square Trucks for All Classes of Wheels.

resistance for the summer oil was taken at 14.77 lbs. per ton and 8.41 lbs. per ton for the winter oil, the average temperature for the former being 41 deg. F., and for the latter 48 deg. F.

CONCLUSIONS.

From the experiments made the following conclusions seem to be justified:

First. The curve friction of a freight car truck is almost directly proportional to the degree of curvature. If the wheels under the truck are new and in good condition, the increase of frictional resistance due to curvature is not so great on the flat degrees of curvature as it is on the sharp degrees. If the wheels under the truck are old and have flange heights approaching M. C. B. limits, just the reverse is true; that is, with old wheels

the increase of frictional resistance due to curvature is greater for flat degrees than for sharp degrees of curvature.

Second. The frictional resistance of a truck equipped with wheels of average contour on new rails is from 10 to 25 per cent. less than for the same wheels on old rails. In the case of high flanges, on old wheels, however, this statement does not hold true.

Third. A truck equipped with old wheels and high flanges gives a frictional resistance of approximately 100 per cent. higher than that given when the truck is equipped with new wheels. The wheels should be exactly mated in order to give least resistance. The coming on the wheels is of great value in reducing the flange friction on low degrees of curvature.

Fourth. A truck constructed so that it will not get out of

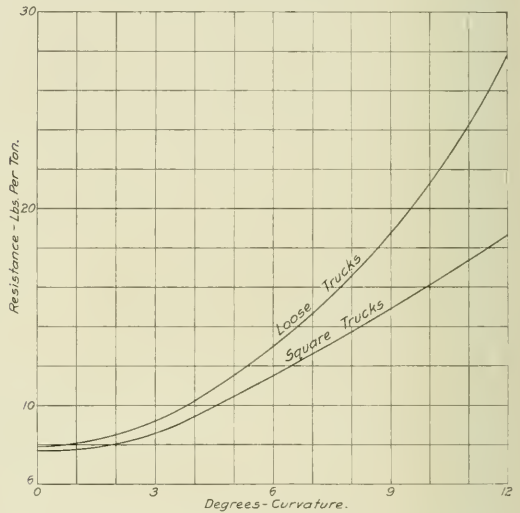

Fig. 6—Resistance Curves of Square and Loose Trucks With New and Medium New Wheels.

square will have less friction both on a tangent and on any degree of curvature than a truck that does not remain square.

Fifth. While the experiments with the winter and summer oils were not carried as far as they could have been, the results show that when the atmospheric temperature is from 40 to 50 deg. F. a truck lubricated with winter oil had about 43 per cent. less friction than one lubricated with summer oil, all other conditions being equal.

The Illinois Central furnished the wheels and axles and the Missouri Pacific the old rails used on the 3 deg. and 6 deg. tracks. L. W. Wallace, assistant professor of car and locomotive design at Purdue University, and L. C. Farquhar assisted Professor Endsley. A more detailed report of the tests will shortly be published by the American Steel Foundries.

VALUE OF RAILWAYS.—According to the estimates of the national wealth of the United States by the Bureau of the Census, the capital value of the railways (cost of road and equipment) increased but little more than half as fast as the capital value of all property from 1890 to 1904.

SOUTHERN COTTON MANUFACTURERS.—Statistics of the Census Bureau issued August 31, 1912, indicate that the cotton-growing states used 2,712,622 bales for manufacturing purposes as against 2,655,049 in all the other states of the union. The number of spindles increased by about 500,000 over that operated the previous year.

NEW DEVICES

SEMI-AUTOMATIC NUT TAPPER

A new, ten-spindle 1½ in. semi-automatic nut tapping machine has been perfected by the National Machinery Company, Tiffin, Ohio. While somewhat similar to the 1 in. six-spindle machine designed by the same company, it embodies certain improvements, notably the gear box, which permits a rapid change of the spindle speeds at the operator's will and while the machine is running. This gear box takes the place of the removal and substitution of gears which was previously necessary. It is believed that the ease with which changes can be effected will prompt the operator to reduce the spindle revolutions as the taps are ground and the cutting teeth reduced

The nut holders are of simple design. The nut guides are chilled plates of wedge shape, held in position by toe clamps. The guides are backed by stationary lugs of corresponding angle on the feed table, thus making the guides rigid and insuring the parallel position of the guide faces. The guides have no tendency to shift or spring, and there is, therefore, freedom from binding of the nuts when feeding.

Openings are provided in the nut pans through which the operator can empty the taps in boxes or kegs set beneath the tapper. This machine will handle either rough hot pressed, or cold punched nuts.

NEW DESIGN OF JOURNAL JACK

A 15-ton, ball bearing jack, especially designed for use in connection with the inspection, removal, or replacement of journal brasses in freight and passenger cars, or for any service where a short, light, powerful jack is required, has been perfected by the Duff Manufacturing Company, Pittsburgh, Pa.

These jacks are said to be very easy operating, because of the large ball bearings which carry the load, and the fact that all parts are machine finished. The steel gears have machine cut teeth and are heat treated. They are self-lubricating, the interiors being packed with semi-fluid grease in which all mov-

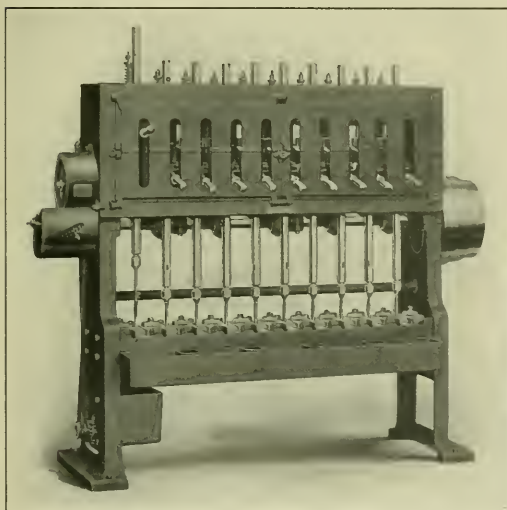

Ten-Spindle Semi-Automatic Nut Tapping Machine.

in number, so that there will be little or no idle tapping time—taps running free in the nut after it is tapped—which tends to reduce maximum output.

The spindles are raised and lowered by cams. Through this automatic spindle movement, the machine sets the pace of the operation, and the operator can devote his entire energy to feeding. Trials have demonstrated that operators have no trouble in meeting the uniform pace set by the machine throughout a working day. This method of raising and lowering the spindles also tends to prolong the life of the taps, as the spindle descends gradually, and the tap is not subjected to sudden and excessive torsional strains. The cams have three steps, and by shifting the cam shaft, the resting time of the spindles when raised can be altered to meet the needs of the operator for feeding.

The spindles are close together—the ten spindles being within a space of 69 in.—which facilitates feeding, and enables the operator to successfully handle ten spindles without covering much floor space. The machine has sufficient range and power to tap two nuts of the smaller sizes on all spindles simultaneously.

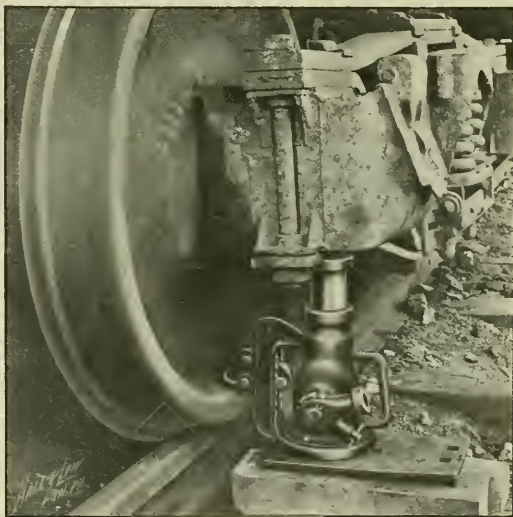

New Ball Bearing Journal Jack in Operation.

ing parts revolve. A new positive stop is used, which prevents the lifting bar from running too far out of the jack, and accidents from this cause are impossible. The load is raised on the downward movement of the lever.

An adjustable wheel-holding device holds the wheel firmly on the track while the journal box is being raised, and does away with the necessity of wedging down the wheel, or of using a plate or strap, can be furnished if desired.

These jacks are light for their capacities, weighing only 28 lbs. without the wheel-holding device, and 33 lbs. with it.

LOCOMOTIVE LINK MILLING MACHINE REVERSING MOTOR DRIVE FOR PLANERS

The Newton Machine Tool Works, Philadelphia, Pa., has recently arranged its standard No. 2 vertical milling machine to make it suitable for milling the valve gear links of locomotives, or other work on arcs of similar radii. This type of milling machine has been in successful use on heavy work for a number of years, and the attachment for links is so arranged as to not materially interfere with its use on straight work. The spindle has a double taper bearing, the large end of which is approximately 4 in. in diameter. It revolves in bronze bushed cap bearings in the saddle, which has square locked bearings on the upright. The vertical adjustment of the spindle is controlled by a hand wheel and the drive is through a sleeve bevel gear direct from a three-step cone pulley or through the back gears. The feed is operated from a small cone on the end of the main driving shaft which is belted to a similar cone on the back of the machine and the motion is transmitted to the worm shown in the illustration. A set of tumbler gears control the direction of the traverse of the table. The bed is moved in and out by a hand-operated ratchet lever. The distance from the center of the spindle to the upright is 16½ in. and the clearance from the end of the spindle to the top of the work table is 14 in. The upper table, as equipped for link milling, is 22 in. x 31 in. in size. It has a 24 in. travel by hand and sufficient cross travel to permit of machining links of from 18 in. to 60 in. radius.

A substantial, rigid knee has been attached to the bed of the original machine which supports an extension from the table. This extension carries the adjustable radius block. It is not fastened to the knee and moves with the table. The clamping plate to which the links are secured is held to the saddle by a dovetailed swivel clamp which has a pin bearing in the saddle, thus permitting the swivel motion; the in-and-out movement is provided by the broad dovetail. A taper shoe is arranged for clamping this plate to the saddle when desired.

The idea of applying direct connected reversing motors to planers has been in practice for some eight or ten years, although it has been more or less of an experiment up to a year or so ago. The use of this form of drive, even in the first stages of its development, showed that it possessed many advantages over the usual methods of reversing through clutches or belt shifters. Not only is an economy effected in the consumption of power through the application of the principle of direct connected individual operation, but the maximum cutting speeds are sustained

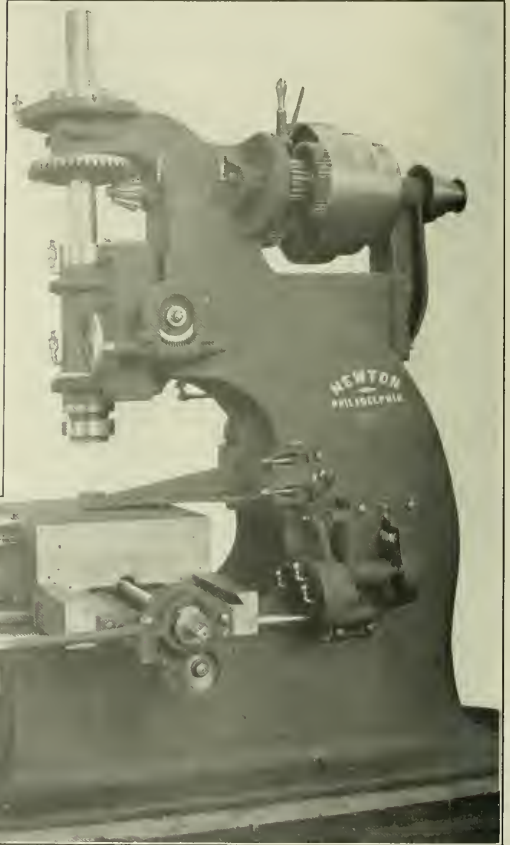

Vertical Milling Machine with Attachment for Machining Locomotive Links.

A lower cutter arbor support has been provided on the machine and is hinged on one side, so that it may be swung out of the way if desired. The device customarily used for holding links is so arranged as to clear this arbor support. The machine weighs about 13,000 lbs. and occupies an actual floor area of 6 ft. x 3 ft.

SMOKE CONSUMERS.—The report of the building inspector of Louisville, Ky., shows that during the fiscal year 1912, which terminated August 31, 100 boilers with smoke consumers were installed. The inspector states that practically all of the permits issued were for high-pressure boilers suitably equipped with approved smoke consumers.

uniformly, the acceleration is more rapid on the return travel, and an increased production is possible.

The effective performance of this drive has created a demand that has warranted exhaustive study and tests by manufacturers in developing it for commercial purposes, and the General Electric Company, Schenectady, N. Y., has recently placed on the market a reversing, adjustable speed, direct connected motor drive that has been carefully tested and tried out in service.

Probably the most interesting application of this drive to machine tools is to planers, but the application to other types of machine tools has proved practical, and it is now used to drive, screw, worm and rack driven slotters, turret lathes, wire and tube drawing machinery and other classes of machine tools usually

reversed through clutches or shifting belts. The motors are mounted any place on the machine or floor convenient for mechanical connection. They are of the standard commutating pole type up to and including 100 h. p. planer rating. The combinations of speeds obtainable allow the motor, in the majority of cases, to be coupled direct to the driving shaft of the machine.

The control consists of a contactor panel and master switch. The former is usually mounted on the side of the planer housing,

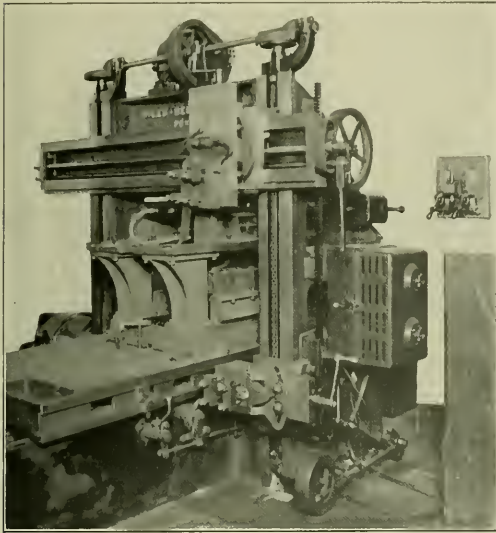

Reversing Motor Drive on a Large Planer.

or in any convenient place on other machine tools to which the drive may be applied. It is made up of eight contactors, similar in appearance to a series contactor, but actuated by shunt, series or differential coils in such a manner as to eliminate electrical disk interlocks. An additional precaution is taken by using mechanical interlocks to prevent the possibility of short circuits. The panel, field rheostats and all accessories are enclosed in a cast iron box, the cover of which is hinged, so that, when swung open, the contactors are easily accessible. The box itself is pivoted in order that the rear of the panel may be swung into view for inspection when required. The field rheostat handles are brought out through the cover of the enclosing case and are plainly marked "cut" and "return." The pointers of these handles traverse a blank ring, which can be marked or graduated for cutting and return speeds in feet per minute.

The master switch is usually mounted on the side of the planer bed, or in other convenient place. This switch is of simple design, containing only four contact fingers, two forward and two reverse, one being used in common for both directions, and three segments

The master switch is operated by dogs on the planer table in much the same way as is now employed for shifting the belts. A special double pole circuit breaker is also supplied, which provides for minimum voltage and overload protection. In case the breaker opens or current fails, it automatically stops the motor, preventing the platen from coasting off the ways.

By virtue of the commutating pole design of the motor, starting, stopping and reversing are accomplished with sparkless commutation. In order not to brake dynamically from high speed in one violent step, means have been taken to accomplish this in three distinct steps, braking down slowly from high speeds and then quickening the brake action at lower speeds. This feature, in addition to quickening the brake, will be recognized as a decided advantage in the maintenance of the machine. A noteworthy point in connection with the operation of this drive is that the planer table reverses extremely close to a line at the end of the cut.

The cutting and return speeds are entirely independent of each other, so that it is possible to use the slowest cutting speed and the highest return speed, or vice versa, in any combination not exceeding four to one, with 35 to 70 cutting speeds and the same number of return speeds.

The saving obtainable by applying power direct to machine

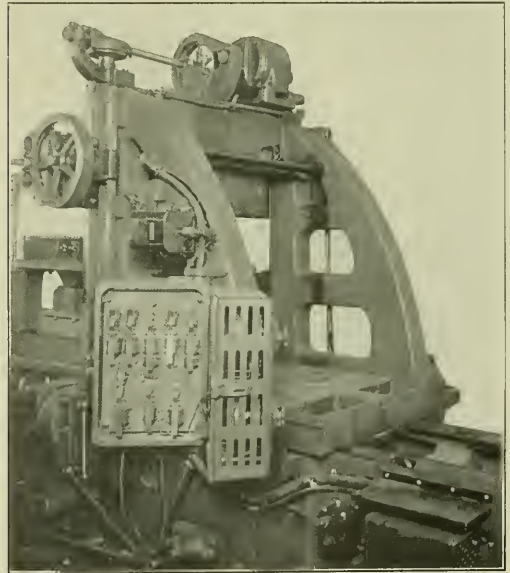

Arrangement of Contactor Panel for Reversing Motor Drive.

tools is considered as the amount of friction load that has thus been eliminated. This often reaches as much as 50 per cent.,

Machine.		Type Drive.	Size Motor. H. P.	Input. Amp.	Cut. In.	Not Cutting.		Cutting.		Return.		Cut. Total Cycle. Sec.	
Type.	Size.					Stroke.	Ft. per Min.	Time. Sec.	Ft. per Min.	Time. Sec.	Ft. per Min.		Time. Sec.
Planer	36 in. x 10 ft.	Belt	10	33	$\frac{3}{8}$ x $\frac{1}{8}$	8 ft. 6 in.	31.9	16	28.3	18	72.8	7	25
Planer	36 in. x 10 ft.	Reversing	10	51	$\frac{3}{8}$ x $\frac{1}{8}$	8 ft. 6 in.	53.2	9.6	52.7	9.8	91	5.6	15.4
Planer	36 in. x 10 ft.	Belt	10	38.5	$\frac{1}{2}$ x $\frac{1}{8}$	8 ft. 6 in.	33.3	15.4	28	18.2	72.8	7	25.2
Planer	36 in. x 10 ft.	Reversing	10	56	$\frac{1}{2}$ x $\frac{1}{8}$	8 ft. 6 in.	53.7	9.5	53.2	9.7	91	5.6	15.3
Planer	72 in. x 22 ft.	Belt	40	95	$\frac{1}{2}$ x $\frac{1}{8}$	10 ft. 1 in.	22.9	26.4	17.1	35.4	59.3	10.2	45.6
Planer	72 in. x 22 ft.	Reversing	35	120	$\frac{1}{2}$ x $\frac{1}{8}$ $\frac{1}{4}$ x $\frac{1}{8}$	10 ft. 1 in.	34.8	17.4	34.4	17.6	75.7	8.2	25.8

on the drum, all of liberal proportions. Its sole function is to close the shunt coil circuits of the forward and return line contactors. The motor field is entirely external to the master switch.

yet it is in reality only a small part of what may be realized, as proved by numerous tests. A belt driven planer, or other machine, of approximately 10 horsepower capacity, running at

a cutting speed of 25 ft. per minute, will drop in speed $2\frac{1}{2}$ to 5 ft. per minute, or 10 to 20 per cent, while cutting to a value of 10 horsepower, if this approaches the carrying capacity of the belt, due to size, speed or slackness. If the cutting speed be increased by 50 per cent, with the same depth of cut and feed, the speed will fall while cutting to nearly what it was originally, the power input increasing only slightly or to the limit of the belt capacity. The maximum slip will be reached when the machine is stalled, the power input remaining approximately constant and the loss being entirely due to friction from belt slippage. This slippage loss is demonstrated in the tabulation of tests made with a recording ammeter and given on page 47. The motors used were all 230 volt. The speeds noted are average feet per minute for complete cutting and return strokes.

HYDRO-PNEUMATIC ACCUMULATOR

Accumulators are a necessary adjunct to hydraulic riveters, presses, punches, etc. While the heavily weighted type are the simplest and are generally used, it occasionally happens that their size and weight are a serious consideration. This is especially true when the tools are to be located on the upper floors of a building.

For use under any conditions that make a weighted accumulator undesirable, the Watson-Stillman Company, New York, has designed and perfected a hydro-pneumatic accumulator which, it

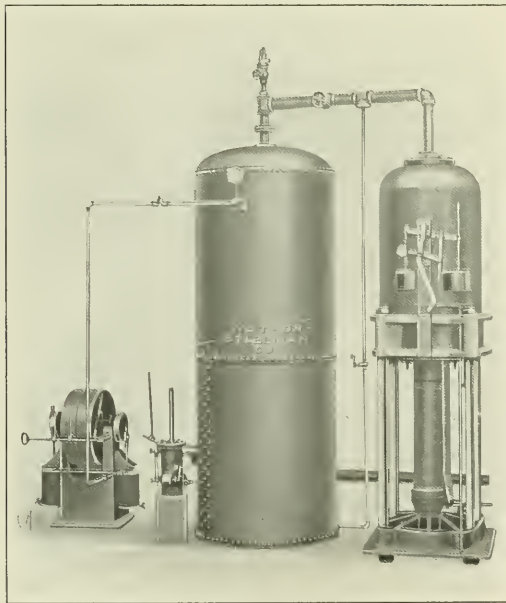

Arrangement of High and Low Pressure Accumulator.

is claimed, will satisfactorily perform all the functions of the weighted type and in addition will provide two pressures, a high pressure of from 300 to 6,000 lbs., as desired, and a low pressure for effecting that part of the stroke which is made against no resistance. The operating valve used in connection with this system requires no more wheels or levers than the ordinary valve and the change from low to high pressure is made automatically at the instant the ram encounters a resistance which the low pressure cannot overcome.

This type of accumulator is shown in the illustration. In the center is a large steel tank kept partially filled with water by the

low pressure pump, the operation of which is controlled by the hydraulic governor shown at the left of the tank. By its action, when the water reaches a predetermined level in the tank, the pump is stopped and when it falls below this level the pump is started. Above the water an air pressure of 180 to 200 lbs. is maintained by the compressor shown at the extreme left. The low pressure feed main is tapped into the bottom of this tank and the water is forced through it by the pressure of the air.

The air pressure is also piped to the accumulator proper and by the force it exerts on a piston in the large cylinder at the top, it balances the higher pressure from the hydraulic pump acting on the piston in the small cylinder at the bottom. The areas of these pistons are inversely proportional to the pressures on them. The operation of the regular high pressure hydraulic pump is controlled by the governor shown on the front of the accumulator, in the same manner as the low pressure pump is controlled. The pumps are operated only when their supply is required and there is no waste of power as high pressure is not used when low pressure suffices. This type of accumulator can be used for high pressures only by omitting the low pressure pump and its connection to the air tank.

HORIZONTAL MILLING MACHINE TESTS

For the past 11 years Alfred Herbert, Limited, machine tool builders, of Coventry, England, have maintained a special shop for the purpose of trying out new forms of machine tools. One of these tests on a horizontal milling machine was described by P. V. Vernon in a paper read before the Manchester Association of Engineers, November 23. The machine had the following general characteristics:

Longitudinal feed.....	42 in.	Number of speeds.....	16
Transverse feed.....	13½ in.	Range of speeds.....	16.4 to 427
Vertical feed.....	21 in.	Number of feeds.....	18
Diameter of single pulley.....	16 in.	Range of feeds (inches per minute).....	5% to 22½
Speed of pulley.....	400 r. p. m.	Weight of machine.....	8,652 lbs.
Belt speed.....	1,675 ft. per min.		
Maximum gear ratio.....	24.4 to 1		

The machine was driven by a 30 horsepower d. c. motor, which would stand 20 per cent. overload for two hours. In a test with a $3\frac{1}{2}$ -in. high speed, 8-tooth cutter, milling an 8-in. cast iron block at 70 ft. per minute (cutting speed), the largest amount of metal removed per horsepower minute was 1.78 cu. in. and the least was 1.04 cu. in. On a test with a $4\frac{1}{2}$ -in. high speed, 10-tooth cutter on a cast iron block 8 in. wide at a cutting speed of 70 ft. per minute, the greatest amount of metal removed per horsepower minute was 1.84 cu. in. and the least was 0.86. In another test on an 8-in. mild steel block with a $4\frac{1}{2}$ -in. high speed, 10-tooth motor running at 70 ft. per minute, the maximum net horsepower obtained was 42.1 and the least 24.9. The greatest amount of metal per horsepower minute removed was 0.74 cu. in. and the least 0.57. The machine failed while operating a $4\frac{1}{2}$ -in. cutter 9 in. long and the defects were noted. After correcting these defects a final test was successfully made with a $4\frac{1}{2}$ -in. high speed steel cutter 9 in. long carried on a 2-in. arbor. The cutter had 10 teeth and the angle of the spiral was $26\frac{3}{4}$ deg., the cutter being run at 70 ft. per minute. In the conclusion, Mr. Vernon made the following generalizations:

A 5-in. double belt driving a 16-in. pulley at a speed of 400 r. p. m. (100,531 sq. in. of belt per minute), geared to drive a $4\frac{1}{2}$ -in. cutter at 70 ft. per minute, is able to remove as much as 48.1 cu. in. of cast iron, and 24.31 cu. in. of mild steel in a minute, 2,090 sq. in. of double belt passing over a pulley in a minute will remove 1 cu. in. of cast iron on a milling-machine.

4,135 sq. in. of double belt passing over a pulley in a minute will remove 1 cu. in. of mild steel on a milling-machine.

A $4\frac{1}{2}$ -in. cutter on a 2-in. arbor, running at 70 ft. per minute, is capable of removing at least 3.63 cu. in., and possibly as much as 6.01 cu. in. of cast iron, and at least 2.125 cu. in., and possibly as much as 3.03 cu. in. of mild steel per minute for each inch of width up to 8 in., and at any depth of cut from 0.24 in. to 1.1 in.

NEWS DEPARTMENT

The Chicago, Milwaukee & Puget Sound hereafter will be operated as the Puget Sound Lines of the Chicago, Milwaukee & St. Paul.

A \$5 gold piece was given, as a Christmas present, to each employee of the Interborough Rapid Transit Company, New York City, who received less than \$110 a month.

Schools of telegraphy have been established by the Western Union Telegraph Company at its offices in a large number of cities, so that all employees may have the opportunity of learning the art.

A competition for the best letter of not over 250 words on "Safety First" has been announced by the St. Louis & San Francisco. It is open to all women in the families of Frisco employees. Prizes of \$10, \$5 and \$2.50 will be awarded.

The San Pedro, Los Angeles & Salt Lake announces that a small open gasoline motor car, with accommodations for about eight passengers and a small quantity of light baggage, has been put in service on the St. Thomas Branch from Moapa (Nevada) to St. Thomas, about 20 miles.

From a statement of casualties issued by the Central Safety Committee of the St. Louis & San Francisco for the month of November, 1912, as compared with the same month in 1911, it was shown that the casualties decreased from 464 to 334, or 28 per cent., and the casualties to employees from 399 to 257, or 36 per cent.

To remove temptation as far as possible from the employees of the Chicago, Burlington & Quincy, that road has issued an order prohibiting the men from cashing their pay checks in saloons. Arrangements have been made with the local banks to keep open the evenings of pay days to accommodate the men. One saloonkeeper in Aurora is said to have cashed over \$15,000 worth of checks in a single night.

A bill has been introduced in the lower house by Representative Raker, requiring the interstate roads to equip locomotives with headlights of not less than 1,500 c. p. measured without the aid of a reflector. The law does not apply if the headlight equipment shall fail on a trip provided it can be shown that it was in good order when the trip was begun. The penalty is from \$100 to \$1,000, and every day will be considered a separate offense.

A good illustration of the type of men holding responsible positions on our railways and the training that they have received was shown by an event that occurred on the Denver & Rio Grande recently. The engineman and fireman of a special train on which A. P. Anderson, the general superintendent, and N. A. Williams, superintendent, were proceeding to Salt Lake City, had been on duty 16 hours. Rather than delay the trip Mr. Anderson and Mr. Williams donned the engineer's and fireman's overalls and carried the train through without any mishap, allowing the engine crew to rest in the superintendent's car.

A conference is being held in New York City between a committee representing the eastern railways and the leaders of the locomotive firemen concerning the increase in firemen's wages. At one of the recent meetings the firemen withdrew their demand for time and a half for overtime and modified their demand for extra firemen on all engines. It has been stated that to meet the original demand of the firemen would cost the roads interested \$20,800,000 a year, and under the changed terms of the demand it would still be large, about \$15,134,000, which would be 56 per cent. of the firemen's present wages.

A settlement has been reached between the striking western machinists of the Grand Trunk Pacific and President E. J. Chamberlin, which will clear the way for the opening of the Transcona shops. The company agrees to reinstate all strikers who apply within 30 days. For the present the existing rate of pay and rules will prevail, 45 cents an hour for Rivers and east of Rivers, and 47½ cents west of Rivers. The company agrees that next spring, if the men so desire, the western management will meet a committee of the men to decide upon a new agreement and a new schedule, and failing to arrive at terms the differences will be submitted to a conciliation board appointed under the Industrial Disputes Act.

A circular has been issued by President B. L. Winchell, of the St. Louis & San Francisco, announcing a pension plan for the St. Louis & San Francisco, the Ft. Worth & Rio Grande, the St. Louis, San Francisco & Texas and the Paris & Great Northern, as follows:

"It has been determined that a plan for granting pensions to employees of these companies, for superannuation or disability, following long service on these lines, shall be made effective from July 1, 1913. Details of the plan will be announced before that date. In the meantime, it is thought that this advance notice may bring encouragement to the employees as a whole, as well as comfort and holiday cheer to some of those who are approaching years of retirement." The circular is also "Heartily Approved" by B. F. Yoakum.

Several commissions have been appointed in Switzerland to investigate the practicability of electrifying the Swiss state railways. The fact that Switzerland produces no coal makes the cost of fuel for operating steam railways an important item, and the fact that the state controls the vast amount of available water power for the generation of electricity makes the proposition more feasible. One commission has reported in favor of the single-phase alternating current system, operating at 15,000 volts. The first work to be undertaken in the application of electricity on state railways will be on the St. Gotthard route, where there are many steep grades and numerous tunnels, the longest of which is over 9 miles. The estimated cost of the conversion of the entire government system, aggregating 1,700 miles, will be about \$14,000,000, including the water power for electrical operation, and the cost of operation will be reduced 10 per cent.

Captain Robert W. Hunt, senior member of the firm of R. W. Hunt & Co., Chicago, was, on December 5, presented with the John Fritz medal for 1912 in recognition of his achievements in the application of the Bessemer process to steel manufacture. Mr. Hunt was born at Fallstown, Pa., in 1838, and received his education at Covington, Ky. In 1860 he established the first chemical laboratory in America to be operated as a department of an iron and steel manufacturing plant, at the works of the Cambria Iron Co., Johnstown, Pa. He left this company to serve through the Civil War, returning to the firm in 1865. He was then sent to Wyandotte, Mich., to assist in establishing a Bessemer plant at that place. He returned to Johnstown in 1866 and assisted in the design and construction of the Cambria Iron Co.'s Bessemer plant, of which he had charge from 1871 to 1873. He later became superintendent of the Bessemer works of John A. Griswold & Co., at Troy, N. Y., and upon the formation of the Troy Steel & Iron Co., in 1875, was appointed manager, which position he retained until 1888. He then established the testing and inspection bureau in Chicago, which bears his name and of which he is still the head. Capt. Hunt is a past president of the American Institute of Mining Engineers, having served two

terms, in 1883-4 and 1906-7. He was president of the American Society of Mechanical Engineers in 1890 and 1891 and was elected president of the Western Society of Engineers in 1893. He is the inventor of numerous steel and iron metallurgical processes and collaborated in the design of the Hunt-Jones-Stuppes rail mill feed table. In recent years he has devoted much time to a study of steel rails.

A CORRECTION

In the article on "The Manufacture of Brake Beam Hangers" in the December, 1912, issue of the *American Engineer*, the brake cylinders used in connection with the bending machine shown in Fig. 5 should have been given as 14 in. x 12 in. in size, instead of 12 in. x 12 in. The last sentence of the article should read: "The hourly wages of the three men aggregate 56 cents, and their piece work earnings, at 5 cents per hanger, amount to from 65 to 70 cents per hour." A typographical error caused the last part of the sentence to read "55 to 70 cents per hour."

DEATH AND INJURY BENEFITS FOR GOVERNMENT EMPLOYEES

The solicitor for the Department of Commerce and Labor, in a report summarizing his decisions under the law of May 30, 1908, providing for compensation to certain government employees in cases of injuries, fatal or non-fatal, received in the course of their employment, presents a statement showing that in about three years more than \$800,000 has been thus paid out. The report says:

"The act has been in operation since August 1, 1908. Between that date and December 1, 1911, compensation was paid in 5,564 cases of injury, in 165 of which the injury resulted in death. On account of these fatal injuries \$112,879 has been paid to surviving dependents. On account of the non-fatal injuries \$704,815 has been paid to the injured persons themselves. (The figures given do not refer to claims arising on the Isthmian Canal since March 3, 1911, when the Isthmian Canal Commission was authorized to handle such claims directly.) These payments have been made, not out of any special appropriation, but from the ordinary current appropriations for salaries. The salary has simply been paid as if the injured man continued at his work, until his incapacity ceased or until the year had run. Owing to the limited scope of the act there have been naturally more accidents reported than claims filed, and there have been also a number of claims filed which could not be allowed either because they were not within the act or were not properly established. In the first year, the number of injuries reported was 4,862, and the number of fatalities 233, while the number of claims submitted was but 1,805, of which 1,689 were allowed. During the second year 6,984 accidents were reported and 226 fatalities; 2,624 claims were submitted and 2,499 allowed. Legislation to extend the benefits of the act has been recommended by the Secretary of Commerce and Labor, and measures designed to enlarge the scope of the act are now pending in Congress."

MEETINGS AND CONVENTIONS

Northern Railway Club.—A. G. Johnson, chief draftsman, Duluth & Iron Range, presented a paper on locomotive counterbalancing at the November meeting. This paper was largely

made up of quotations from different books, being principally taken from "Locomotive Operation," by G. R. Henderson.

New York Railroad Club.—The December meeting was given up to the annual Christmas entertainment and smoker which, in recent years has become so popular as to tax the capacity of the auditorium. The usual high character of entertainment was provided. A large silver loving cup was presented to Frank Hedley, the retiring president.

Western Railway Club.—A paper was presented by O. S. Beyer, Jr., of the Rock Island Lines, before the club, December 17, on Railway Specifications. The following committee was also appointed to report on the proposed changes in the M. C. B. Rules of Interchange: George Thompson, New York Central Lines, chairman; G. F. Laughlin, Armour Car Lines; H. H. Harvey, Chicago, Burlington & Quincy; J. M. Borrowdale, Illinois Central, and C. J. Wymer, Chicago & Western Indiana.

General Foremen's Association.—At a joint meeting of the executive committees of the International Railway General Foremen's Association, the American Railway Tool Foremen's Association and the Supplymen's Associations, held at the Hotel Sherman, Chicago, December 18, 1912, it was decided to hold the next convention of the International Railway General Foremen's Association, in Chicago, July 15-18, 1913, at the Hotel Sherman. This is one week earlier than usual; the Tool Foremen's Association will meet the following week, at the same place, and the exhibitors will thus find it possible to use the same exhibit for both associations.

Railway Business Association.—The annual business meeting of this association was held on December 19; the report of President George A. Post indicated very satisfactory developments from the efforts of the association in favor of a policy permitting adequate railway revenue. Mr. Post was re-elected president. Approximately a thousand members and guests were present at the annual dinner in the evening. The speakers of the evening were James J. Hill and the Hon. W. L. MacKenzie King. The former spoke on the need of greater railway facilities for the proper commercial development of the country and presented striking statistics in connection with the capitalization of the railways in this country and abroad. Mr. King, formerly Minister of Labor of Canada, explained the origin and results of the Canadian industrial disputes investigation act which has now been in operation for practically six years.

American Society of Mechanical Engineers.—At the annual meeting in New York, December 3-6, the following officers were elected for the ensuing year: President, W. F. M. Goss, dean of the Engineering School, University of Illinois; vice-presidents, James Hartness, J. E. Moulthrop and H. G. Stott; managers, W. B. Jackson, H. M. Leland and Alfred Noble; treasurer, W. H. Wiley. The members of the society at the University of Illinois, with the heads of the engineering departments, gave a dinner to Dr. Goss on December 13, at the University Club in Urbana, Ill., as an expression of their appreciation of his election to the presidency. On December 18, a special engineering convocation was held to permit the general faculty and the students in the college of engineering to

RAILROAD CLUB MEETINGS

Club.	Next Meeting.	Title of Paper.	Author.	Secretary.	Address.
Canadian	Jan. 14	Terminals	C. L. Fritch	Jas. Powell	Room 13, Windsor Hotel, Montreal.
Central	Jan. 9	Freight Car Tactics	Arthur Hale	H. D. Vought,	95 Liberty St., New York.
New England	Jan. 17	Steel Freight Cars	Chas. Lindstrom	Wm. E. Cade, Jr.	683 Atlantic Ave., Boston, Mass.
New York	Jan. 17	Pneumatic-Electric Brake	N. A. Camel	H. D. Vought	95 Liberty St., New York.
Pittsburgh	Jan. 24	Terminal Car Service	W. M. Prall	J. B. Anderson	Union Station, Pittsburgh, Pa.
Richmond	Jan. 13	Lecture on Bermuda	S. H. Bowman	F. O. Robinson	C. & O. Ry., Richmond, Va.
St. Louis	Jan. 10	W. W. Finley	B. W. Frauenthal	Union Station, St. Louis, Mo.
Western	Jan. 20	Increased Locomotive Capacity Resulting from the Use of Superheated Steam	Gilbert E. Ryder	Jos. W. Taylor	390 Old Colony Bldg., Chicago.

express their appreciation of the honor paid Dean Goss. After several brief addresses, Prof. Ira O. Baker presented to Dean Goss an engrossed testimonial signed by representatives of the faculty and the various engineering organizations at the university.

Canadian Railway Club.—Prof. V. I. Smart, of McGill University, presented a paper at the November meeting on the subject of prevention of accidents. He tabulated a large amount of information on casualties in connection with train operation and discussed the greater safety to passengers on foreign railways as compared with those in this country. He briefly investigated the reasons for this difference in conditions, concluding that the form of block system for train operation used in Europe is principally responsible for the greater safety. He also considered briefly the cost of block signal systems and depreciated the relative value of the manual control block system. The discussion was confined principally to the methods of despatching and forms of signaling. At the December meeting the paper presented by S. P. Brown was on the subject of tunneling. It included an extensive discussion of the latest development in building railroad tunnels and all of the more important factors to be considered in the engineering and construction work.

Railway Storekeepers' Association.—The tenth annual meeting of this association will be held at the Auditorium Hotel, Chicago, May 19-21, 1913. The regular subjects which will be considered are as follows: Reducing of inactive and disposing of obsolete stock; economy effected by the use of rolling mills at railroad scrap docks; marking of M. C. B. couplers and parts by manufacturers for identification. What effect, if any, has a well organized store department on the operating cost of a railroad? Among the topical subjects to be discussed are the following: Standard storehouse, standard storehouse casting platform, standard oil house and waste storage, standard dry lumber sheds, standard stationary storehouse, standard supply car, and standard scrap dock and reclaiming machinery. These will be exemplified by the necessary drawings arranged on a unit basis, so that any road may draw on such standards according to its requirements. The following subjects will also be considered: Specifications for and the testing of material and effect on the storekeepers' stock; the proper method of storing, disbursing and handling of ice on railroads; and the standard book of rules governing store department practices.

The following list gives names of secretaries, dates of next or regular meetings, and places of meeting of mechanical associations.

- AIR BRAKE ASSOCIATION.—F. M. Nellis, 53 State St., Boston, Mass. Convention, May 6-9, 1913, St. Louis, Mo.
- AMERICAN RAILWAY MASTER MECHANICS' ASSOC.—J. W. Taylor, Old Colony building, Chicago. Convention, June 11-13, 1913, Atlantic City, N. J.
- AMERICAN RAILWAY TOOL FOREMEN'S ASSOCIATION.—A. R. Davis, Central of Georgia, Macon, Ga.
- AMERICAN SOCIETY FOR TESTING MATERIALS.—Prof. E. M. Burg, University of Pennsylvania, Philadelphia, Pa. Annual convention, June, 1913.
- AMERICAN SOCIETY OF MECHANICAL ENGINEERS.—Calvin W. Rice, 29 W. Thirty-ninth St., New York. Annual meeting, December 3-6, Engineering Societies' Building. Railroad session, Thursday morning, December 5.
- CAR FOREMEN'S ASSOCIATION OF CHICAGO.—Aaron K'ine, 841 North Fifthth Court, Chicago; 2d Monday in month, Chicago.
- INTERNATIONAL RAILWAY FUEL ASSOCIATION.—C. G. Hall, McCormick building, Chicago. Convention, May, 1913, Chicago.
- INTERNATIONAL RAILWAY GENERAL FOREMEN'S ASSOCIATION.—William Hall, Chicago & North Western, Escanaba, Mich.
- INTERNATIONAL RAILROAD MASTER BLACKSMITH'S ASSOCIATION.—A. L. Woodworth, Lima, Ohio. Convention, August 18, 1913, Richmond, Va.
- MASTER BOILER MAKERS' ASSOCIATION.—Harry D. Vought, 95 Liberty St., New York. Convention, May 26-29, 1913, Chicago.
- MASTER CAR BUILDERS' ASSOCIATION.—J. W. Taylor, Old Colony building, Chicago. Convention, June 16-18, 1913, Atlantic City, N. J.
- MASTER CAR AND LOCOMOTIVE PAINTERS' ASSOC. OF U. S. AND CANADA.—A. P. Dane, B. & M., Reading, Mass. Convention, Sept 9-12, 1913, Ottawa, Can.
- RAILWAY STOREKEEPERS' ASSOCIATION.—J. P. Murphy, Box C, Collinwood, Ohio. Convention, May 19-21, 1913, Auditorium Hotel, Chicago, Ill.

PERSONALS

It is our desire to make these columns cover as completely as possible all the changes that take place in the mechanical departments of the railways of this country, and we shall greatly appreciate any assistance that our readers may give us in helping to bring this about.

GENERAL

FREDERICK S. BROWN has been appointed mechanical engineer of the Erie, with headquarters at Meadville, Pa.

H. E. DALZELL has been appointed chief of motive power and machinery of the Southern Railways of Peru and dependencies, with headquarters at Arequipa, Peru.

LEWIS D. FREEMAN has been appointed chief draftsman of the Kansas City Southern, with headquarters at Pittsburg, Kan. Mr. Freeman was born at Gettysburg, Pa., on July 11, 1888, and attended the common schools and high school at that place. He served an apprenticeship at the Baldwin Locomotive Works, Philadelphia, Pa., studied three years at night school, and took correspondence school courses in mechanical engineering and the air brake. From November, 1909, to March, 1910, he was employed as a locomotive inspector by Alfred Lovell, consulting engineer. For a short time he was employed as track foreman in the Philadelphia erecting shop of the Baldwin Locomotive Works, and in June, 1910, he became a draftsman in the office of the mechanical engineer of the Baltimore & Ohio, and was placed in charge of the design of shop tools and special appliances for shop improvements, which position he occupied until his recent appointment on the Kansas City Southern.

W. J. TOLLERTON, mechanical superintendent of the Rock Island Lines, with office at Chicago, has been appointed general mechanical superintendent of the Rock Island Lines in full charge

of the mechanical department. T. Rumney, assistant second vice-president in charge of the mechanical department having resigned, his former position has been abolished. Mr. Tollerton was born in 1870, at St. Paul, Minn., and was educated in the public schools, and in high school. He began railway work as a machinist apprentice on the St. Paul & Duluth, now a part of the Northern Pacific, and after a short time became a fireman on the Omaha Railway. He went to the Union Pacific in 1890 as foreman, and afterwards was general

foreman. In 1896 he was appointed master mechanic of the Utah division of the Oregon Short Line, and in 1903 was made master mechanic of the Idaho, Utah and Montana divisions of the same road, with office at Pocatello, Idaho. He went to the Rock Island in July, 1906, as superintendent of motive power in charge of lines west of the Mississippi river, with office at Topeka, Kan., and was promoted in April, 1907, to assistant general superintendent of motive power of the Rock Island Lines, with headquarters at Chicago. In May, 1912, his title was changed to mechanical superintendent.

W. L. KELLOGG, superintendent of motive power of the Pere



W. J. Tollerton.

Marquette, at Grand Rapids, Mich., has been appointed superintendent of machinery and equipment of the Missouri, Kansas & Texas, with headquarters at Parsons, Kans., succeeding William O'Herin.

W. E. LADLEY, master mechanic of the Chicago & Alton, with headquarters at Bloomington, Ill., has been appointed superintendent of motive power of the Reid Newfoundland Company, with headquarters at St. John's, Newfoundland, effective January 1. He will have charge of locomotive, marine building and repairs, traveling engineers, engineers, firemen and all mechanical matters.

FRED. MERTSHEIMER, superintendent of motive power and car department of the Kansas City, Mexico & Orient, with office at Wichita, Kan., has resigned.

G. E. PERRY, master mechanic of the Missouri, Oklahoma & Gulf, has been appointed superintendent of motive power, with headquarters at Muskogee, Okla., and the former position is abolished.

W. E. SYMONS has been appointed superintendent of motive power of the San Antonio & Arkansas Pass, with headquarters at San Antonio, Tex., succeeding G. W. Taylor.

J. J. WATERS has been appointed superintendent of motive power of the Pere Marquette, with headquarters at Grand Rapids, Mich., to succeed W. L. Kellogg, resigned.

MASTER MECHANICS AND ROAD FOREMEN OF ENGINES

F. CONNOLLY has been appointed supervisor of locomotive operation of the Kansas City Terminal and Kansas divisions of the Rock Island Lines, with headquarters at Herington, Kan., reporting to the master mechanic at Horton, Kan. His duties will include the divisional work of locomotive operation under the direction of H. Clewer, general superintendent of locomotive operation, as mentioned in the *American Engineer* for December.

D. W. CROSS has been appointed master mechanic of the Toledo, St. Louis & Western, with headquarters at Frankfort, Ind., effective January 1.

C. C. HAYMAN has been appointed road foreman of engines on the Middle division of the Atchison, Topeka & Santa Fe, with headquarters at Newton, Kan.

DAVID HOPKINS has been appointed road foreman of engines on the Valley division of the Atchison, Topeka & Santa Fe with jurisdiction east of Fresno and including the Sunset Railway. His headquarters will be at Fresno, Cal.

H. O. ENGLISH has been appointed master mechanic of the Texas City Terminal, at Texas City, Tex., succeeding F. A. Scott.

W. E. MAXFIELD has been appointed master mechanic of the Texas & Pacific, with office at Big Springs, Tex., succeeding C. E. Boss.

C. C. MCCAULEY has been appointed road foreman of engines on the first district Albuquerque division of the Atchison, Topeka & Santa Fe Coast Lines, with headquarters at Albuquerque, N. M., vice C. M. Byrd, assigned to other duties.

MICHAEL MCGRAW has been appointed master mechanic of the Chicago & Alton, with headquarters at Bloomington, Ill., succeeding W. E. Ladley, resigned.

F. J. MOFFATT has been appointed road foreman of the Grand Trunk Pacific, with territory from Watrous, Sask., to Wainwright, Alta., including branches, succeeding C. D. Smith. He will report to J. R. Mooney, road foreman at Wainwright.

N. J. O'CONNOR has been appointed master mechanic of the Florence & Cripple Creek, with office at Colorado Springs, Colo.

S. T. PATTERSON has been appointed supervisor of locomotive operation of the Arkansas division of the Chicago, Rock Island & Pacific, with headquarters at Little Rock, Ark. He will report to the local master mechanic and will carry on the divisional work of locomotive operation under the direction of H. Clewer, as mentioned in the December issue of the *American Engineer*.

RALPH RAMSEY has been appointed traveling engineer of the Texas & Pacific, with office at Marshall, Tex.

J. B. RANDALL has been appointed master mechanic of the Louisville, Henderson & St. Louis, and the position of assistant master mechanic has been abolished.

E. SCHULTZ, formerly roundhouse foreman of the Chicago & Northwestern, at Milwaukee, Wis., has been appointed master mechanic of the Northern Wisconsin and Lake Shore divisions at Green Bay, Wis.

CHRISTIAN F. SCHRAAG, road foreman of equipment for the Danville district of the Chicago & Eastern Illinois, will have his jurisdiction extended over the entire Evansville division.

WILLIAM C. SEALY, whose appointment as assistant master mechanic of the Middle and Southern divisions of the Grand Trunk, with headquarters at Toronto, Ont., was announced in the December, 1912, issue of the *American Engineer*, was born November 29, 1886, at Stratford, Ont., and was educated in the public schools of his native town and at the Collegiate Institute. He began railway work in September, 1902, on the Grand Trunk, and until 1907 was an apprentice. He was then for one year chargeman, and from 1908 to 1909 was erecting shop foreman. He was promoted to general foreman of the Toronto shops in 1910, which position he held at the time of his recent appointment as assistant master mechanic.

JOHN L. SMITH, acting master mechanic of the Pittsburgh, Shawmut & Northern, at St. Marys, Pa., has been appointed master mechanic, effective January 1.

J. B. STEWART has been appointed master mechanic of the Texas, Oklahoma & Gulf, with office at Bismarck, Okla.

S. G. TRUSSELL has been appointed assistant road foreman of equipment of the Evansville division of the Chicago & Eastern Illinois.

R. E. WALLACE has been appointed supervisor of locomotive operation of the Chicago Terminal and Illinois divisions of the Rock Island Lines, with office at Chicago. He will report to the master mechanic at Chicago, and will have charge of the mechanical operation of all engines on those divisions, under the direction of H. Clewer, as outlined in our December issue.

B. L. WHEATLEY, road foreman of equipment of the Rock Island Lines, at Valley Junction, Ia., has been appointed master mechanic of the Southern division, with office at Fort Worth, Tex., succeeding H. Clewer, promoted.

CHARLES WILKIE has been appointed road foreman of engines of the Pere Marquette, with office at Port Huron, Mich.

C. S. YEATON has been appointed supervisor of locomotive operation of the Oklahoma division of the Rock Island Lines, with headquarters at El Reno, Okla., and will report to the master mechanic at Chickasha, Okla. He will be in charge of the mechanical operation of all engines in service on that division, as outlined in the *American Engineer* for December, in the announcement of the appointment of H. Clewer as superintendent of locomotive operation.

CAR DEPARTMENT

W. M. ELLIS, chief car inspector of the Alabama Great Southern, at Birmingham, Ala., has been appointed general foreman car repairers at that point.

VAN R. LEWIS has been appointed foreman in the freight car

shops of the Texas & Pacific, at Marshall, Tex., vice G. W. Horton, resigned.

C. W. MADDOX has been appointed chief car inspector and piece work supervisor of the Chesapeake & Ohio, with office at Richmond, Va.

JOHN McMULLEN, shop superintendent of the Erie at Buffalo, N. Y., has been appointed mechanical superintendent of the Erie and subsidiary companies in charge of the car department, with headquarters at Meadville, Pa., succeeding E. A. Wescott, assigned to other duties.

WILLIAM MILLER has been appointed superintendent of the Kent car shop of the Erie, succeeding Adam Trautman transferred.

C. S. SIMPSON has been appointed foreman of the car department of the Missouri, Kansas & Texas, at Smithville, Tex., vice S. J. Stephenson, resigned.

ADAM TRAUTMAN has been appointed superintendent of the Buffalo car shop of the Erie, succeeding John McMullen, promoted.

SHOP AND ENGINE HOUSE

J. ALEXANDER has been appointed locomotive foreman of the Canadian Pacific at Hardisty, Alta., succeeding E. B. Patterson, resigned.

A. E. BENNETT has been appointed locomotive foreman of the Canadian Pacific at Eholt, B. C.

A. W. CLARK has been appointed locomotive foreman of the Canadian Pacific at Kamloops, B. C.

B. CONLEY has been appointed night engine house foreman of the Marshall & East Texas, at Marshall, Tex., vice W. Mayes, resigned.

CARL N. FREY, piece work inspector for the Wheeling & Lake Erie, has been appointed to a similar position on the Michigan Central.

F. H. HARDESTY has been appointed foreman boilermaker of the Trinity & Brazos Valley at Teague, Tex.

G. HILFRINK, general foreman of the Pere Marquette, at Saginaw, Mich., has been promoted to the position of shop superintendent, with headquarters at the same place, succeeding W. W. Scott.

E. KENNEDY has been appointed assistant general foreman of the New York Central & Hudson River shops at West Albany, succeeding E. V. Williams, promoted.

DANIEL G. LAKING has been appointed assistant foreman of the Chicago & Eastern Illinois, at Evansville, Ind.

S. H. LEE has been appointed foreman of locomotive repairs of the Chicago, St. Paul, Minneapolis & Omaha, at East St. Paul, Minn.

W. H. LEE has been appointed locomotive foreman of the Canadian Pacific at Weyburn, Sask., succeeding P. Walz, resigned.

JOHN McDOWELL has been appointed foreman painter of the Rock Island Lines at Cedar Rapids, Ia., succeeding B. D. Mason, resigned.

M. J. MCGRAW has resigned his position as superintendent of the Missouri Pacific shops at Sedalia, Mo., to accept a similar position with the Texas & New Orleans, at Houston, Tex.

W. F. MEADWAY, erecting foreman of the Delaware, Lackawanna & Western, at Buffalo, N. Y., has been appointed tool foreman at that point.

C. MURPHY has been appointed erecting shop foreman of the Trinity & Brazos Valley, at Teague, Tex.

T. H. NANNEY has been appointed general foreman of the Buffalo & Susquehanna, at Galeton, Pa.

M. A. O'LEARY, gang foreman for the Southern Pacific at Roseburg, has been appointed roundhouse foreman on the same road at Grant's Pass, Oregon.

S. J. PENKETH, machine foreman of the Pere Marquette at Saginaw, Mich., has been appointed erecting foreman of the Delaware, Lackawanna & Western, at Buffalo, N. Y., succeeding W. F. Meadway.

D. L. RINGLER, foreman of the erecting shop of the Trinity & Brazos Valley at Teague, Tex., has been appointed night roundhouse foreman.

W. W. SCOTT, shop superintendent of the Pere Marquette, at Saginaw, Mich., has been appointed general foreman of the Delaware, Lackawanna & Western, at Buffalo, N. Y. A sketch of Mr. Scott's career was given in the January, 1912, issue of the *American Engineer*.

E. V. WILLIAMS has been appointed general foreman of the New York Central & Hudson River shops at West Albany, succeeding T. H. Leonard, resigned.

HARRY WORKING has been appointed assistant engine house foreman of the Atchison, Topeka & Santa Fe, at Cleburne, Tex.

PURCHASING AND STOREKEEPING

F. A. BUSHNELL, purchasing agent of the Spokane, Portland & Seattle, at Portland, Ore., has been appointed assistant purchasing agent of the Great Northern, with headquarters at St. Paul, Minn.

W. G. PHELPS, chief clerk to the second vice-president of the Pennsylvania Lines West of Pittsburgh, has been appointed assistant purchasing agent, with headquarters at Pittsburgh, Pa.

The office of H. W. Davies, purchasing agent of the Norfolk Southern, at Norfolk, Va., has been abolished, and Mr. Davies has been assigned to other duties.

BOSTON EMPLOYMENT BUREAU.—The National Metal Trades Association of Boston shows that in the three months ending with September there were 1,070 applications and 509 new registrations. The number of men sent out was 455, out of which 225 were hired.

PURE DRINKING WATER.—The Chicago, Burlington & Quincy has arranged to send Dr. D. J. Evans, medical examiner for the company, over the lines of the system for the purpose of inspecting water and ice used in the passenger coaches, dining cars and station restaurants. He will also investigate the sanitary conditions along the line.

MOTOR CAR SERVICE IN BAVARIA.—In Bavaria the administration which operates the railways maintains also an automobile service on 53 routes permanently, and on eight more during the summer, carrying passengers and mail and parcels. The service has been profitable, the expenses per motor car mile being 15 cents and the earnings nearly 20 cents, and the net for all the lines amounting to \$88,000.

TRESPASSERS IN TEXAS.—From a report of H. G. Askew, statistician for the Texas railways, it is shown for the year ending June 30, 1912, a total of 159 trespassers were killed and 232 were injured on 32 roads representing 90 per cent. of the total railway mileage in the state. This is an increase of 31 trespassers killed and 58 injured. The claims paid for 1912 were \$2,871,496 as against \$1,847,701 for the fiscal year 1908.

NEW SHOPS

ANN ARBOR.—New shops and an engine house will be erected at Owosso, Mich., at an estimated cost of \$300,000.

ATLANTON, TOPEKA & SANTA FE.—New shops and terminals, including car shops, engine house, boiler, machine and blacksmith shops and other buildings, will be built at Albuquerque, N. M., at an approximate cost of \$1,500,000. A 36-stall engine house with shops and passenger station will be built at Gallup, N. M. A wheel shop will be added to the shop at San Bernardino, Cal., at an approximate cost of \$11,000.

BOSTON & MAINE.—The list of tools for the Billerica, Mass., shops has been published. The list requires an early delivery, so that the shop may be in operation by next July.

CANADIAN NORTHERN.—New shops will be built in the vicinity of Toronto, Ont., which will employ about 300 men. It is reported that \$2,000,000 will be spent for shops in the middle West, probably in Saskatoon, Sask. New terminals will be built at Port Mann, B. C., which will consist of 60 miles of freight yard tracks, extensive repair shops, a 20-stall engine house, freight sheds, and several auxiliary buildings.

CANADIAN PACIFIC.—Additions to the West Toronto, Ont., shops are under construction.

CAROLINA, CLINCHFIELD & OHIO.—Large machine and car shops will be erected at Elkhorn, Ky.

CENTRAL OF NEW JERSEY.—An engine house will be built at Cranford, N. J., and plans are being considered for the construction of an engine house in Jersey City.

CHICAGO, MILWAUKEE & PUGET SOUND.—The plans for the improvement of the shops at Tacoma, Wash., have been completed.

CHICAGO, MILWAUKEE & ST. PAUL.—It is reported that the blacksmith and tank shops at Deer Lodge, Mont., will be improved and enlarged.

CHICAGO, ROCK ISLAND & PACIFIC.—A boiler house and engine house will be erected in Chicago. Bids are being received.

CLEVELAND, CINCINNATI, CHICAGO & ST. LOUIS.—Contract for a six-stall roundhouse at Cairo, Ill., has been awarded.

CLEVELAND, CINCINNATI, CHICAGO & ST. LOUIS.—It is reported that car shops will be erected at Bellefontaine, Ohio.

ELGIN, JOLIET & EASTERN.—Work has been started on the locomotive shops at East Joliet, Ill.

ILLINOIS CENTRAL.—It is reported that the shops at East St. Louis, Ill., will be enlarged.

MICHIGAN CENTRAL.—Large additions to the shops at Detroit, Mich., will soon be made.

OREGON SHORT LINE.—The car shops at Pocatello, Idaho, which were destroyed by fire a few weeks ago are being rebuilt. The shops will also be enlarged in the spring. A four-stall engine house will be built at Flatfoot, Idaho.

PITTSBURGH & LAKE ERIE.—Bids have been received for the erection of the new shop at McKees Rocks, Pa.

PITTSBURGH, FT. WAYNE & CHICAGO.—The machine shop at Ft. Wayne, Ind., is being remodeled and enlarged.

SOUTHERN PACIFIC.—It is reported that new shops will be erected at Newark, Cal.

ST. LOUIS, BROWNSVILLE & MEXICO.—A repair shop is being built at Kingsville, Tex.

TEXAS & PACIFIC.—A site has been purchased in New Orleans, La., for terminal facilities.

SUPPLY TRADE NOTES

Marvin F. Wood, general sales manager of the Van Nest Company, New York, has resigned.

The name of the Dearborn Drug & Chemical Works has been changed to Dearborn Chemical Company.

The offices of Clement F. Street, Schenectady, N. Y., have been moved to 30 Church street, New York.

H. T. Armstrong has been placed in charge of a branch office of the Davenport Locomotive Works in the First National Bank building, Cincinnati, Ohio.

The Pullman Company will raise the salaries of its clerical force January 1 by amounts ranging from two to 12 per cent. The increase will amount to \$300,000 per year.

The Oxweld Acetylene Company removed its general office in Chicago on December 16, from the Peoples Gas building, to its new works at Thirty-sixth street and Jasper place.

A. B. Chadwick, superintendent of the Armour car shops, Meridian, Miss., has resigned to become manager of the shops of the Grip Nut Company, Chicago, effective January 1.

L. H. Mesker, manager of the St. Louis branch of Manning, Maxwell & Moore, Inc., has resigned to take a similar position with the Ferro Machine & Foundry Co., Cleveland, Ohio.

A. E. Crone, formerly storekeeper of the New York Central & Hudson River, at Depew, N. Y., has been made supply agent of the Buffalo Brake Beam Company, Buffalo, N. Y., with office in that city.

The Western Electric Company, Chicago, has declared an extra dividend of \$2 on its common stock in addition to the regular quarterly dividend of \$2 per share, payable December 31 to stock of record December 24.

H. E. Lavelle, formerly with the Standard Paint Company, has been made selling and mechanical representative of the Automatic Ventilator Company, New York, for the middle western states, with office in Indianapolis, Ind.

John J. Swan, formerly manager of the New York office of the Chicago Pneumatic Tool Company, and later mechanical engineer in the compressor department of that company, has resigned to go to the Oil Power Engineering Corporation, New York.

The Baldwin Locomotive Works, Philadelphia, Pa., report that they have a greater working force in their various plants than ever before, 19,250 employees being enrolled at the Eddystone, Lewistown and Philadelphia works. The new erecting shop at Eddystone is now in full operation.

The H. W. Johns-Manville Company, New York, has opened a branch office at 31½ South Broad street, Atlanta, Ga., in charge of C. S. Berry as manager. To facilitate delivery in the South a stock of roofings, pipe coverings and other J.-M. asbestos, magnesia and electrical products is carried at that point.

F. M. Whyte has been elected vice-president of the Hutchins Car Roofing Company, with offices in New York. Mr. Whyte for many years was general mechanical engineer of the New York Central Lines, and for the past two years has been general manager of the New York Air Brake Company.

Fred Coe Taylor, chief engineer of the Conley Frog & Switch Company, Memphis, Tenn., has resigned to go to the H. W. Johns-Manville Company, New York, as manager of its insulation department, with office in St. Louis, Mo. J. W. Buzick, assistant engineer of the Conley company, succeeds Mr. Taylor.

Henry Hess has sold his stock holdings in the Hess-Bright Manufacturing Company, Philadelphia, Pa., makers of ball bearings, to the Deutsche Waffen & Munitionsfabriken, Berlin, Ger-

many, and has resigned his position to devote himself to his other interests. The controlling ownership of the company remains in America in the hands of F. B. Bright, president.

Charles W. Beaver has been made manager of the chain block department of the Yale & Towne Manufacturing Company, New York, succeeding R. P. Hodgkins, resigned. Mr. Beaver has been connected with the chain block department of this company for a number of years, first as salesman and later as assistant manager. For the past two years he has represented the company in Europe.

The Lehon Company, Chicago, manufacturers of protective products, has just completed a large addition to its roofing and insulating mill at Forty-fifth street and Western avenue, Chicago. The output of the concern has been practically doubled by recent improvements. The company is now furnishing its Per-Bona insulating paper for the 3,000 Harriman Lines refrigerator cars recently ordered.

The Pullman Company now has approximately 12,000 men on its payroll in the manufacturing department, as compared with an average of 7,645 in the last fiscal year, of which 3,000 are working overtime. The freight car department is running at about 75 per cent. of its capacity, with orders for about 14,000 cars on the books. The passenger car department is running at nearly full capacity.

The Vandorn & Dutton Company, Cleveland, Ohio, has increased its space and facilities for the manufacture of its Hard Service portable electrically operated drills and reamers by disposing of its electric department in which armature, field and induction motor coils for motors for railway and mill service were produced. The facilities pertaining to motor repairs, armature, field and induction motor coils have been taken over by the Cleveland Coil & Manufacturing Company.

For a quarter of a century the general office and Chicago laboratories of Robert W. Hunt & Co. have been in the Rookery. Owing to inability to secure in that building the necessary space in which to conduct their very largely increased business, the offices and laboratories were moved on December 1 to the twenty-second floor of the Insurance Exchange building, Jackson boulevard, between Sherman street and Fifth avenue.

Joseph M. Brown, who has been engaged in the railway supply business under the name of Joseph M. Brown Company, has taken a partner and incorporated under the name of Brown-Lewis Railway Supply Company. The new company will continue the representation of the several companies previously handled by Mr. Brown, in addition to the high-speed tool steel of the Newman-Andrew Company, of New York, importers of the "Toledo brand" of tool steel. The latter will be handled by Mr. Brown's partner, James S. Lewis, who has been connected with the Charles G. Stevens Company, and has had many years of experience in tool steel business.

The reorganization committee of the Allis-Chalmers Company, Milwaukee, Wis., has called a third assessment of \$3 on the common stock and \$6 on the preferred stock. The assessment is payable January 15. There still remains to be paid \$4 on the common and \$8 on the preferred. The court has ordered that the foreclosure sale of the Allis-Chalmers properties take place February 3. Up to December 13 there had been deposited under the plan of reorganization \$10,458,000 first mortgage 5 per cent. bonds, or 93 per cent. of the outstanding issue, \$14,146,500—7 per cent. cumulative preferred stock, or 88 per cent. of the outstanding issue, and \$17,215,000 of the common stock, or 86 per cent. of the outstanding issue.

W. P. Steele has been appointed assistant to the president of the American Locomotive Company and will perform the duties heretofore assigned to him in addition to such other duties as the president may direct. Mr. Steele entered the service of the Boston & Lowell, now a part of the Boston & Maine, in 1880. He

occupied various positions in the shop, and in firing, running and other classes of locomotive service until 1901. For the next six years he was associated with railway supply concerns which were interested in locomotive development and in 1907 entered the engineering department of the American Locomotive Company as an assistant to the vice-president in charge of design. This position he held until the time of his appointment as noted above.

J. B. Ennis has been appointed chief mechanical engineer of the American Locomotive Company, with headquarters at New York. He will perform the duties formerly assigned to the vice-president in charge of engineering with the exception that the chief engineer will report directly to the president on construction and shop engineering matters. Mr. Ennis became identified with the engineering department of the Rogers Locomotive Works, at Paterson, N. J., in 1895. Later he was connected in a similar capacity with both the Cooke Locomotive Works, of Paterson, N. J., and the Schenectady Locomotive Works, Schenectady, N. Y. He has been connected with the engineering department of the American Locomotive Company at the New York office ever since its organization.

William Miller, president of the Monarch Pneumatic Tool Company, has resigned, effective December 31, and has accepted the vice-presidency of the Pyle-National Electric Headlight Company, with offices in the Karpen building, Chicago. Mr. Miller began his apprenticeship in the Hannibal & St. Joseph shops at Hannibal, Mo., in 1881, and in 1885 was journeyman with the Missouri, Kansas & Texas at Hannibal. He was with the Wabash at Moberly, Mo., in 1886, and the following year was employed by the Denver & Rio Grande at Denver, Colo. He became shop foreman of the St. Louis & San Francisco at Springfield, Mo., in 1889; general foreman of shops of the Colorado Midland at Colorado City, Colo., in 1900; master mechanic of the Terminal Railroad Association of St. Louis in 1904, and was appointed assistant superintendent of motive power of the Denver & Rio Grande in 1905. He went to the Western Maryland as superintendent of motive power and car department at Union Bridge, Md., in 1907, and in 1908 entered the commercial field as vice-president of the Adreon Manufacturing Company, with offices at Chicago. Mr. Miller became president of the Monarch Pneumatic Tool Company and vice-president of the Standard Railway Equipment Company in 1911.

H. F. Ball has opened an office in the Hudson Terminal building, 30 Church street, New York, as a special consulting engineer. Mr. Ball entered the service of the Pennsylvania Railroad as an apprentice at Altoona, Pa., in 1884. Four years later he entered the drafting room at Altoona, and in 1890 was appointed chief draftsman of the car department of the Lake Shore & Michigan Southern. Two years later he was placed in charge of the car shops at Cleveland, as general foreman, and in 1894 was appointed general car inspector. Five years later he was made mechanical engineer of the Lake Shore, which position he held until his promotion to the position of superintendent of motive power in February, 1902. In 1906 he left the Lake Shore to accept the vice-presidency of the American Locomotive Automobile Company; a few months later his jurisdiction was extended over the American Locomotive Company as vice-president of engineering. This position he resigned a short time ago, as announced in our issue of December, 1912. Mr. Ball's tenure of office, as vice-president of engineering of the American Locomotive Company has been coincident with some of the most important improvements made in locomotive construction, as well as the great increase in power and weight which characterize the present day locomotive. It covered such radical changes in design, as a substitution of the Walschaert for the Stephenson valve gear, the use of superheated for saturated steam, and the successful development of the Mallet locomotive. Mr. Ball was president of the Central Railway Club in 1900 and of the American Railway Master Mechanics' Association in 1905-6.

CATALOGS

PIPE UNIONS.—A leaflet being sent out by the Jefferson Union Company, Lexington, Mass., briefly draws attention to the fact that this company is a specialist on unions and makes nothing else. The Jefferson union is illustrated in several styles.

POWER PLANT EQUIPMENT.—Schutte & Koerting Company, Philadelphia, Pa., is issuing a twenty-page catalog in which various pieces of apparatus used in the power house are illustrated and briefly described. This includes injectors, condensers, various types of valves, furnace blowers, automatic ejectors, oil firing system and chimney ventilators.

COAL CONVEYORS AND INDUSTRIAL RAILWAYS.—Two pamphlets have been issued on the Hunt noiseless coal conveyor and the Hunt industrial railways, by the C. W. Hunt Company, New York. They contain illustrations of the various types of coal conveyors and automatic dumpers, with a description as to their applications and a very complete description of industrial railways.

ELECTRIC TESTING LABORATORIES.—A leaflet issued by the Electric Testing Laboratories, Eightieth street and East End avenue, New York, briefly outlines the work that this company is prepared to undertake. This includes the preparation of specifications and the inspection and testing of all kinds of electric apparatus. The tests are made either in the laboratory or at the manufacturer's works. Tests of equipment in use in any part of the country will also be undertaken.

MOTORS AND GENERATORS.—Adjustable speed, small sized, direct current motors in sizes from 1/3 to 32 horsepower, form the subject of bulletin No. 158 from the Crocker-Wheeler Company, Amper, N. J. These are fully illustrated and described and several applications to machine tools are shown. Bulletin No. 159 from the same company is devoted to the subject of alternating current generators of 50 k. v. a., or larger, capacity. These are designed for both two and three phase circuits and are fully illustrated.

CHUCKS.—The Skinner Chuck Company, New Britain, Conn., has issued a new catalog and price list which supersedes all previous publications from this company. In it is illustrated and described a complete line of independent, universal and combination lathe chucks, as well as drill chucks, planer chucks, face plate jaws, drill press vises and reamer stands. With the illustration of each style there appears a table of dimensions giving complete information on the dimensions of details for each size of chuck. A telegraphic code with a word for each size of each type of chuck is included.

HOSE COUPLING.—Bulletin No. 303 from the Thomas H. Dallett Company, York and Twenty-third streets, Philadelphia, Pa., is devoted to a complete illustrated description of the Dallett quick action hose coupling. This coupling is made of hard bronze with no projecting pieces to catch when the hose is trailed on the ground. It is not only designed for rapid connecting and disconnecting, but is intended especially to give a positive air tight joint under all conditions and to remain coupled in any position of the hose. Other accessories for air hose are briefly mentioned in the same catalog.

STEAM TURBINES.—A 48-page booklet recently issued by the De Laval Steam Turbine Company, Trenton, N. J., fully illustrates and describes the velocity stage type of turbine which is built in sizes up to 600 horse power, and is suitable for direct connection to centrifugal pumps, blowers or small generators. This booklet outlines the factors effecting the suitability of different types of turbines for different services, the methods of velocity staging for small turbines and the practical con-

siderations of material and design. The velocity stage type turbine as built by this company has several distinguishing features. The catalog is fully illustrated.

ACETYLENE GENERATORS.—A small leaflet issued by the Alexander K. Milburn Company, Baltimore, Md., briefly describes various types of acetylene gas generators to be used in connection with lighting or welding outfits. These are shown both in portable and stationary forms with lights of practically any desired candle power attached. The portable machines are entirely automatic and one type of 500 candle power size is shown as arranged for a hand light. A portable oxy-acetylene welding outfit is shown, as is also a new oxy-acetylene generator which utilizes waste steam to generate the gas. This company has manufactured over 70,000 acetylene generators.

WELDING, CUTTING AND BRAZING.—The Northwestern Blau-Gas Company, St. Paul, Minn., has issued a 40-page pamphlet illustrating and describing the ways in which Blau gas may be used for welding, cutting and brazing. Blau gas is a new gas invented by Hermann Blau, a German, and is exceptionally well adapted for welding, cutting and brazing purposes. It is a compressed liquefied distillation gas produced from mineral oils. In the process of manufacture it is reduced to 1/400 of its volume and all poisons and impurities are removed. One cubic foot of expanded gas will produce 1,800 B. t. u. Among the illustrations are shown repairs to heavy gear wheels, automobile chassis, propeller blades, crank shafts and the cutting of steel girders.

ELECTRIC DRILLS.—Three bulletins issued by the Chicago Pneumatic Tool Company, Fisher building, Chicago, describe the latest development in portable electric drills. One is devoted to heavy duty electric drills for alternating current, which are built in sizes ranging from 3/8 in. to 2 in. capacity. The construction and equipment of each of these is fully illustrated and described. Another bulletin is devoted to similar information on heavy duty electric drills for direct current which are furnished in sizes covering the same range. The third bulletin is devoted to drills which will operate on either direct current or single phase alternating current. These are furnished in sizes suitable for holes of from 3/16 in. to 1 1/4 in. diameter in metal. General specifications are given for each size.

PASSENGER TRAFFIC IN JAPAN.—The gross earnings of the Japanese railways are 55 per cent. from passengers and 45 per cent. from freight, as compared with 25 per cent. from passengers and 75 per cent. from freight in the United States.—*Erie Railroad Employees' Magazine.*

SWISS RAILWAY EARNINGS.—The receipts of the Swiss state railways for 1911 were as follows: Passenger traffic, \$15,001,890; freight traffic, \$21,263,988; other receipts, \$1,458,926, a total of \$37,724,804. Expenditures were \$22,664,762, making a balance in favor of the government of \$15,060,042.

PHYSICAL VALUATION OF THE LEHIGH VALLEY.—As a result of the physical valuation on the Lehigh Valley it is shown that the company's property used for transportation is worth \$300,000,000, which amounts to \$159,300,000 surplus for the stockholders, or a percentage value of 236 for the shares.

MAINTENANCE COSTS ON NEBRASKA RAILWAYS.—Engineering and superintendence on Nebraska railways cost \$1,034.67 per roadway mile and \$810.15 per track mile, or 2.16 per cent. of the total value of roadway, equipment, etc. These figures are from the report of the Nebraska State Railway Commission.

ENGINEER IMPRISONED FOR NEGLIGENCE.—In Germany, last June, an engineman overran a signal set against him and caused a collision by which three persons were killed and 28 injured, some of them severely. The criminal court at Leipzig tried him for criminal negligence and sentenced him to 15 months' imprisonment.

AMERICAN ENGINEER

"THE RAILWAY MECHANICAL MONTHLY"

(Including the Railway Age Gazette "Shop Edition.")

PUBLISHED ON THE FIRST THURSDAY OF EVERY MONTH, BY THE
SIMMONS-BORDMAN PUBLISHING COMPANY,
83 FULTON STREET, NEW YORK, N. Y.

CHICAGO: Transportation Bldg. CLEVELAND: Citizen's Bldg.
LONDON: Queen Anne's Chambers, Westminster.

EDWARD A. SIMMONS, *President.* HENRY LEE, *Secretary.*
L. B. SHERMAN, *Vice-President.* A. E. HOOVEN, *Business Manager.*
The address of the company is the address of the officers.

ROY V. WRIGHT, *Editor.* R. E. TRAVER, *Associate Editor.*
E. A. AVERILL, *Managing Editor.* A. C. LOUDON, *Associate Editor.*
GEORGE L. FOWLER, *Associate Editor.*

Subscriptions, including the eight daily editions of the *Railway Age Gazette* published in June in connection with the annual conventions of the Master Car Builders' and American Railway Master Mechanics' associations, payable in advance and postage free:

United States, Canada and Mexico.....\$2.00 a year
Foreign Countries (excepting daily editions).....3.00 a year
Single Copy 20 cents

Entered at the Post Office at New York, N. Y., as mail matter of the second class.

WE GUARANTEE, that of this issue 4,125 copies were printed; that of those 4,125 copies, 3,760 were mailed to regular paid subscribers and 125 were provided for counter and news companies' sales; that the total copies printed this year to date were 10,276 copies—an average of 5,138 copies a month.

VOLUME 87. FEBRUARY 1913. NUMBER 2.

CONTENTS

EDITORIALS:	
Car Department Competition.....	57
Exhibits Open During the Evening.....	57
Moving Pictures and Fuel Economy.....	57
The Finishing Shop.....	58
New York Central Steel Coaches.....	58
Air Brake Hose.....	58
Jacobs-Shupert Boiler Tests.....	59
New Books.....	60
COMMUNICATIONS:	
The Advertising Pages.....	62
Defective Box Cars.....	62
Equivalent Heating Surface.....	62
Tire Turning Record.....	62
GENERAL:	
Tests of Jacobs-Shupert Boiler.....	63
Moving Pictures in Railway Educational Work.....	67
Curves of Locomotive Operation.....	68
Tests of Spring Steel.....	70
The Division Master Mechanic.....	70
Superheater and Feed Water Heater.....	71
Tabular Comparison of Recent Locomotives.....	72
New Design of Trailer Truck.....	74
Taking Up Lateral Play.....	74
SHOP PRACTICE:	
Machine Shop Kinks.....	75
Driving Box Kinks.....	75
Iron Rack for Short Lengths.....	76
Replacing a Driver Spring on a Mallet.....	76
Shop Hospital Room.....	79
Apprentice Schools on the Erie.....	80
Shop Kinks.....	81
Milling Attachment for Lathes.....	84
Miscellaneous Shop Kinks.....	87
CAR DEPARTMENT:	
Caboose Laws.....	87
A Collapsible End Construction for Passenger Equipment.....	87
New York Central Lines Steel Coaches.....	89
Mirror for Inspecting Arch Bars.....	95
Truck Equalizer Design.....	96
Specifications for Postal Car Lighting.....	97
NEW DEVICES:	
Horizontal Drilling and Boring Machine.....	99
Shaper for Driving Boxes.....	100
A New Design of Car Coupler.....	101
Automatic Cylinder Cock.....	101
Shap Outside Metal Car Roof.....	101
Improved Rod Brass.....	102
Pneumatic Drill Press Clamps.....	103
Device for Securing Hand Holds.....	103
Compound Locomotive Air Pump.....	104
Car and Truck Locking Device.....	104
NEWS DEPARTMENT:	
Notes.....	105
Meetings and Conventions.....	106
Personals.....	107
Supply Trade Notes.....	108
Catalogs.....	109

Car Department Competition

Exhibits Open During the Evening

Moving Pictures and Fuel Economy

Remember that the car department competition, which was announced in our issue of December, 1912, and January, 1913, will close on February 15, and that all manuscripts must be received by that time. A prize of \$50 will be given for the best article on a car department subject of special interest to our readers. Papers, not awarded the prize, but accepted for publication, will be paid for at our regular space rates. Mail your contribution at once.

Among the reasons in favor of keeping the exhibits at the Atlantic City conventions open during the evening are: the opportunity for an exhibitor to obtain a greater benefit from his exhibit and a better return on the money invested in it; a chance for the members of the association to more fully inspect the exhibits, to do so with less haste and with an opportunity of talking with the manufacturer or his representative without constant interruption; a source of attraction which will bring everyone connected with the conventions to the pier during the evening, a result which is greatly to be desired from every standpoint; an increase in the number of railway men in other departments who will visit the exhibits for but one or two days, and a bigger, better and more worth while exhibit in every way. What are the objections to a trial of the idea?

Prominent among the problems which confront motive power officers is that of fuel economy, and various plans are in force or have been tried out on different roads in the effort to reduce fuel consumption and eliminate waste. In some cases a special branch of the motive power department has been inaugurated to deal with economy in fuel and supplies in general, the most recent road to adopt this system being the Rock Island. It can scarcely be questioned that the most satisfactory method of instructing firemen in the proper methods of performing their work is by individual instruction, but as a rule conditions will not permit this to be done. The question of proper instruction along these lines seems to have been simplified to a very material extent on the Union Pacific by the use of moving pictures, as described elsewhere in this issue, and the results obtained should be encouraging, not only to those directly connected with the work, but also to motive power officers in general.

Choosing at random from the numerous important points which might be considered, the condition of the fire when a locomotive is brought into a terminal is worthy of attention. It is astonishing how many firemen, considered to be experienced, will bring in fires banked high with fresh coal, by far the greater part of which must go into the cinder pit as waste. This leads directly to the waste of steam by popping, a point brought out by the moving pictures in a most impressive way. It is difficult at any time to impress on hostlers and others having to do with the handling of locomotives at terminals, that there is no need of keeping the steam pressure of locomotives, while they are in or about the engine house, constantly at the blowing off point. When a locomotive comes in with a bright, hot fire and requires only enough steam pressure to work it into the engine house, either the surplus steam must escape through the pops, or the boiler must be cooled. In an effort to cool the boiler, the blower is turned on hard with the fire door open and probably an injector is started. In nine such cases out of ten, whether or not the tubes were dry on arrival, they will be leaking badly when the locomotive reaches the engine house. There are cases of leaky boiler tubes without number that can be directly traced to the ash pit handling, and the only way to improve such conditions is to instruct the men in the proper methods. To obtain satisfactory results the in-

struction should not stop after one lesson, but be continued periodically, and moving pictures seem to offer an easy and effective means of doing this.

The Finishing Shop

When a locomotive leaves the shop after heavy repairs it is not, in most cases, immediately ready for service, and often the work that is to be done on defects developed during the breaking in runs will hold it for two or three days longer before it can be safely delivered for the use of the transportation department. If the shop is working efficiently and on a schedule, the return of these locomotives that are being broken in, for some minor work, interferes with the routine and may result in an aggravating delay in finishing other locomotives. Again, there is much work required just before the engine goes out, such as the re-application of piping, putting in cab fittings, painting, attaching the tender, filling the boiler and firing up, which does not require the facilities of the main shop and during busy times it should not be occupying room in the erecting shop. When the roundhouse is adjacent to the shop it has been the practice to make these repairs there, but a large shop requires the constant use of several pits for this purpose with the necessity of the men going back and forth, to the main shop, as the roundhouse forces could not be expected to do this finishing work, and the result, while an improvement, is not altogether satisfactory, especially where a roundhouse foreman needs all of the pits that he has. The best solution is the building of a separate small shop adjacent to the erecting shop where the pits are provided and used entirely for this finishing work, and several of the larger shops are finding this arrangement most satisfactory.

The most recent instance of this kind, is the erection of such a building at the Scranton shops of the Delaware, Lackawanna & Western. In this case, it is located directly across the transfer table from the main erecting shop and has four pits. It is of a structure in keeping with the remainder of the plant, has 50 ft. concrete pits and a floor of creosoted wooden blocks. Smoke jacks are installed at both ends of each pit and all finishing work and repairs reported by the engineer after the breaking in trip, as well as the attaching of the tenders, etc., is performed here. It is heated with steam, piped throughout for hot water and compressed air, and lighted with electricity.

New York Central Steel Coaches

A design of steel passenger cars prepared by the mechanical department of the New York Central Lines working in conjunction with the builders, is especially noticeable in two particulars. One is the exceptional thoroughness of the insulation and the other, the very strong end construction. Great difficulty has been experienced in keeping steel passenger cars at a comfortable temperature in severe winter weather and the drain on the locomotive for heating the cars has been greatly increased at just the time that more steam is needed for propulsion. While it is possible to properly heat these cars by putting in a large radiation surface and supplying it with sufficient steam, the better way is to prevent, as far as possible, the transmission of the cold air to the interior of the car or the loss of heat to the outside. Where there is a continuous metal connection between the inside and the outside of the car body, the transfer of the heat and its dissipation on the outside sheathing is very rapid, but where the continuity of such a metal path is broken with even a thin sheet of non-conductor the loss will be greatly decreased. In the New York Central cars an effort has been made to avoid all continuous metallic connection between the inside and the outside, and practically without exception, the effort has been successful. Furthermore, a sheet of insulation is secured to the back of the outside sheathing and another heavier one on the back of the inside sheathing or finish. As a further preventive the circulation of air be-

tween the parts of the framing or under the floor has been prevented.

Experience with steel cars in wrecks has shown them to be practically invulnerable except when an adjoining car or a locomotive pierces the body end framing. With an end construction sufficiently strong and properly designed, the chance for loss of life in a steel car, under any condition, is very slight. On the cars under discussion the diaphragm posts of the vestibule are very heavy and securely supported, but are considered only as the advance guard, the greater resistance being encountered at the end of the body. This consists of two 6 in., 15.6 lb. Z bars at the corners, set in a pocket in the underframe casting at the bottom and securely supported at the top. These are reinforced by large cast steel knees extending up as high as the belt rail. The door posts are 6 in., 12 $\frac{1}{4}$ lb. I beams, also set in pockets in the underframes and most securely fastened at the top to an end plate arranged to give an exceptional resistance in the horizontal plane. These main members taken in connection with the intermediate 4 in. Z bar posts and the steel sheathing present a structure which appears to be able to arrest the movement of any body, especially after it has crushed the vestibule framing.

Air Brake Hose

In considering the subject of improved air brake hose the question arises as to how great an increase in cost is justified by the conditions of service. Without doubt much of the present trouble with the hose is caused by difficulties not directly associated with the material, and if these are the basis for any considerable proportion of the removals, the amount of increased cost that will be justified for better material is reduced in the same proportion. Unless there is a time limit provision compelling the removal of air brake hose after a certain length of service, the use of a better hose, in the final analysis, is not going to reduce troubles caused by poor hose, and the argument in favor of its use is entirely economic. If, for instance, a car has at one end a high-priced hose which has been in service for two years and at the other end a low-priced hose which has been in service for eight months, the chances of failure at either end of the car will be equal and the better quality of material has resulted only in a longer life. Considering the matter entirely from the standpoint of freight cars, no road is justified in using a better quality of air brake hose than is required by the rules of interchange, and it is not to be expected that any road will do so. Therefore the revision of the M. C. B. specifications should be designed to insure the maximum quality which it is believed the service justifies. It can be concluded that no road will provide a better hose than the specifications require, and some may apply a poorer one. While the conditions of service may not justify the use of a very high-priced hose on freight cars, there is no one who has had the temerity to argue that the present hose is good enough.

The effect of most of the so called "users defects" will in some particulars increase in the same ratio as the length of life of the hose and an increase in the quality will increase the percentage of hose removed on this account, and it would thus seem advisable to require the use of a material which will have a normal life equal to the probable length of service before having to be removed for these causes. The first problem to be solved is the determination of the exact conditions in this regard. Next, it will be necessary to know what effect the improvement in the quality of the material will have in reducing these defects. With these questions settled the desired length of life would be known approximately and a material could be specified which, while possibly not the best obtainable, would be good enough to give efficient service. If that is done, however, and the expectant life of the hose is fifteen or eighteen months, or possibly two years, the rules should provide for its removal at the expiration of that time, independent of all other causes. If such a time limit does not seem feasible, the hose should be of a quality to insure the maximum practical length of service and

thus make users defects responsible for nearly all the removals.

Probably the principal difficulty with the present hose is rapid deterioration after being put in service. This is very largely due to the use of shoddy and rubber substitutes. In either of the suggested plans, the use of such materials should be prevented, and it seems probable that a rigid tension test would accomplish this. It has also been suggested that a harder composition be required for both the inner tube and the outer cover, and that less attention be given to the stretching test. Furthermore, that the outer cover should be of a better weather resisting quality than the inner tube. Both of these requirements would tend to reduce the troubles from users defects.

After a satisfactory quality of material is obtained, however, but part of the problem has been solved and attention should be given to compelling the use of properly designed fittings, proper methods of applying them and greater care in the application of the hose to the car. While the present design of coupler, when the hose is properly put up, will separate with no material damage to the hose, it so frequently occurs that either the couplers are not in line, or they have been in service so long as to be out of shape, and the strain imposed on the hose when uncoupling automatically is very severe and causes serious damage. The nipples used and the methods employed in applying them in some shops would indicate that efforts were being made to destroy the hose as quickly as possible, and the fact that any hose, after such treatment, is capable of service at all, is surprising.

Jacobs-Shupert Boiler Tests

While it has always been realized that the heating surface in the firebox of a locomotive is much more valuable in producing evaporation than that in the flues, the exact relation could only be conjectured. Through the enterprise of the Jacobs-Shupert United States Firebox Company, however, data is now available which permits the designer of a locomotive boiler to approach the subject with much more confidence. It has been shown that with a typical locomotive boiler having tubes 18 ft. 2 in. in length in which about 7 per cent. of the total heating surface is in the firebox and when burning a long flame bituminous coal at normal rates of combustion the firebox evaporates 40 per cent. of the total steam from the boiler and the ratio of the heat absorbed per square foot by the firebox to that absorbed by a square foot in the tubes is as 6.15 to 1. This is without a brick arch in the firebox.

Before the results of these tests, valuable as they are, are used in practical design the conditions which held during the making of the tests and the possible effect on the results as well as the methods of competition should be thoroughly understood. Primarily, the tests were intended entirely as a comparison between two different types of fireboxes applied to otherwise exactly similar boilers and all conditions during the same tests on both boilers were alike. In neither case, however, were these conditions exactly normal. The tests proved conclusively that, as steam makers, the two boilers were practically equal. The low water tests which were made later, however, proved that the Jacobs-Shupert sectional firebox was very much the superior under the conditions of the trials.

In the first series of evaporation tests it was necessary, since the evaporation of the two parts of the boiler was to be determined by the amount of feed water injected into each, to separate the firebox from the barrel with a water tight partition which consisted of an extension on the back tube sheet. This prevented all circulation between the two parts and necessitated the injection of feed water into the firebox section as well as through a check valve in the usual position. The feed water in the firebox section was discharged through a perforated pipe extending for practically the full length of the box and located over the center of the crown sheet. Since the rate of heat transferred through a sheet depends on the difference in temperature in the two sides of the sheet, it is probable that the

entrance of the cold water at practically the hottest part of the firebox resulted in a considerable increase in the rate of heat transfer at that point. On the other hand, it required the cold water to gradually find its way down along the outer sheet in the water legs and probably decreased the normal amount of circulation and increased the average temperature of the water in the water legs, thus decreasing the heat transfer through the side sheets. Again, the injection of the cold water directly to the firebox section, which under normal conditions is supplied with water that has already been heated in the barrel, required it to do more work in delivering the same amount of steam. With the front end temperatures and the efficiency of combustion the same, the distribution of heat between the firebox and the tubes will depend on how much the firebox can absorb, since the tubes will only be supplied with the remainder. If then, the conditions of the test were such as to permit the firebox to take up a larger portion of the heat than would be the case if it had received water from the barrel of the boiler, the tubes would be somewhat handicapped and the fact that the boiler in its normal condition and receiving feed water only through the usual check valve, gave practically the same efficiency that it did when it was tested with the partition between the firebox and the barrel, would not be conclusive proof that the distribution between the firebox and the tubes was exact. While the tests on circulation, which were all confined to the movement of the water in the water legs, proved that the currents were not as strong, nor as direct as had been supposed, and also indicated that the movement from the barrel to the firebox is very gradual, it must be remembered that when the circulation tests were made, the firebox was fitted with two large arch tubes which was not the case when the separate firebox tests were made. While we have no exact knowledge of the rapidity of the movement of the mixture through the arch tubes, there is no doubt but what it is very rapid and would decidedly affect the character of the circulation in the side water legs.

It is to be regretted that the facilities for the tests and the time allowed did not permit a more complete investigation to check the effect of these various features, but it would hardly be just to expect a manufacturing company to stand the expense of a series of tests which would probably extend over two years and develop facts, which, while of great value to the engineering world in general, would be of no particular importance in its own field and the Jacobs-Shupert United States Firebox Company is entitled, and should receive the hearty commendation of all engineers for the work it has done.

In connection with the results, as published in Dr. Goss' report, attention should be drawn to a few features which, if not understood, might lead to some error in the use of the data. The firebox heating surface of the Jacobs-Shupert firebox is the developed area of the sheet, which-gives this box 21.4 sq. ft. greater heating surface than the radial stay firebox. This is an increase of over 14 per cent., and the unit figures of evaporation from the Jacobs-Shupert firebox are smaller by that amount than would be the case if the projected area had been used. The evaporation from the back tube sheet is credited to the firebox by being pro-rated on the basis of each square foot being equivalent to the average square foot of the rest of the firebox, and this amount is deducted from the evaporation of the barrel. This area amounted to 27.5 sq. ft. for the radial stay boiler and 28.9 sq. ft. for the Jacobs-Shupert. The heating surface of the tubes is figured on the inside surface, while the published heating surface of other boilers is given for the outside of the tubes. The difference in this case is to reduce the amount of tube heating surface by 10.8 per cent. The area of the front tube sheet which amounts to 18.6 sq. ft. in both boilers, is included in the heating surface. This area is not included in the published heating surface of locomotive boilers. The area of the arch tubes is not included in the heating surface in connection with the results of evaporation

after the arch was installed. The report does not state whether the arch tubes were in place during the tests without a brick arch, and without this information it is impossible to determine whether the increased evaporation as given by the arch is due entirely to the improved combustion or whether part of it should be credited to the heating surface of the arch tubes.

NEW BOOKS

Shop Notes. Edited by H. H. Winsor. 208 pages. 6½ in. x 9½ in. Illustrated. Bound in paper. Published by *Popular Mechanics*, Chicago. Price, 50 cents.

This is the ninth annual year book of the *Popular Mechanics Shop Notes* and is a collection of the articles published during the past under that head in the monthly edition of the magazine. It includes 595 easy ways of doing things in the several trades. The items are all original and are simple in construction, making it possible for a handy amateur to duplicate them. A complete index is given in the back of the book.

Density and Thermal Expansion of Linseed Oil and Turpentine. By H. W. Bearce, Assistant Physicist, Bureau of Standards, Technological Paper No. 9. Published by the Bureau of Standards, Washington, D. C.

This pamphlet has been prepared in response to a demand for a more complete knowledge concerning the physical properties of linseed oil and turpentine. Samples were taken from various manufacturers in different localities throughout the country. The apparatus and method of procedure used is thoroughly described, together with the results obtained and comparisons with previous tests. A good deal of the information is given in the form of tables of density, weight and volume as determined from the tests.

Coal. B. E. E. Somermeier, Professor of Metallurgy, Ohio State University. Bound in cloth. 167 pages. 6½ in. x 9½ in. Published by the McGraw-Hill Book Company, 239 West Thirty-ninth street, New York. Price, \$2.00.

The information is largely based on private notes, scattered general information, technical bulletins, and original papers in technical journals. The author has endeavored to keep in mind throughout the work the mechanical and power plant engineer, the chemical engineer and chemist, and the non-technical business man who has to do with the buying and selling of coal. The work is divided into 10 chapters, the first dealing with the composition and heating value; the second with the chemical analysis; the third, fourth, fifth and sixth with the testing of fuel; the seventh and eighth with the improvement by washing and the general purchase of coal under specifications; the ninth thoroughly discusses the method and theory together with the results obtained through gas analysis by the Orsat apparatus; the tenth chapter is given over to analytical tables, giving the composition of various kinds of coal found throughout the United States. The book contains a few diagrams, clearly illustrating the various methods used in the testing of coals.

The Elements of Heating and Ventilation. By Arthur M. Greene, Jr. Cloth, 5½ in. x 9 in., 315 pages, 223 illustrations. John Wiley & Sons, New York. Price, \$2.50.

The aim of this book has been to bring together in logical order and in a small volume the necessary data from which to design the heating and ventilating systems of buildings. There are twelve chapters dealing with methods of heating and of calculating the heat required; amount and condition of air for ventilation; loss and gain of heat; radiators, valves and heat transmission, etc. Direct steam, indirect and hot water heating are all dealt with, as well as furnaces and boilers, district heating, temperature control and drying by air. Numerous tables and charts are used throughout the book.

International Railroad Master Blacksmiths' Association. Proceedings of the 1912 Convention. Bound in cloth. 334 pages, 5½ in. x 8¼ in. Published by the International Railroad Master Blacksmiths' Association, A. L. Woodworth, Secretary, Lima, Ohio.

The twentieth annual convention of this association was held in Chicago, Ill., August 20-23, 1912. Among the subjects considered were Drop Forging, Frog and Track Work, Forging Machines and Dies, Springs and Spring Making, Frame Making and Repairing, Heat Treatment of Metals and Piece Work.

A Treatise on Cement Specifications. By Jerome Cochran. Cloth bound, 6 in. x 9 in., 101 pages, 7 illustrations. D. Van Nostrand Co., New York. Price \$1.00.

While the author recognizes in his preface the impossibility of drawing specifications for cement which will be applicable to all classes of work and under all conditions, he has tried to make the presentation of the subject more complete than has ever before been attempted. The specifications proper cover 76 pages and include clauses on general conditions governing the use of cement, furnishing it to the contractor, purchasing it from manufacturers, delivering and storing it, inspecting and testing, testing requirements, methods of testing, and significance of tests. In addition to the specifications there are chapters on methods of mechanical analyses of Portland cement, bibliography of specifications for cement and bibliography of foreign cement specifications. The work is intended as a guide to students and young engineers in the preparation of specifications, and the aim has been to make this set consistent and in conformity with modern practice.

An Extension of the Dewey Decimal System of Classification Applied to the Engineering Industries. By L. P. Breckenridge and G. A. Goodenough. Bulletin No. 9 (revised edition). University of Illinois Engineering Experiment Station. Size 6 in. x 9 in., 117 pages. Price, 50 cents.

The filing and classification of engineering data has become a matter of much importance, and this bulletin was prepared for use as a guide in carrying out such work. Bulletin No. 9 was originally issued in 1906, and the demand was so great that a second edition was printed and distributed, 20,000 copies in all having been sent out. The demand for the bulletin having continued, the revised bulletin has been prepared with a number of changes and extensions presenting subdivisions of subjects in such detail as to constitute a complete classification for most industries, even though they are highly specialized. This revision has been made in accordance with the 1911 edition of "Decimal Classification," by Melvil Dewey. The experiment station is unable to make this revised bulletin subject to gratuitous distribution and a charge of 50 cents is made for copies postpaid.

Locomotive Dictionary. 1912 (Third) Edition. Compiled and edited for the American Railway Master Mechanics' Association by Roy V. Wright, managing editor of the *Railway Age Gazette* and editor of the *American Engineer*, assisted by Porter L. Swift. Illustrated. 901 pages. 9 in. x 12 in. Published by the Simmons-Boardman Publishing Company, New York, and distributed by the McGraw-Hill Book Company, 239 West 39th street, New York. Price, leather bound, \$6; cloth bound, \$4.

The progress made in the design of locomotives, both steam and electric, during the past three years is well illustrated by the contents of this edition of the *Locomotive Dictionary* when compared with the 1909 edition. It has been necessary to go beyond a mere revision of the previous edition, and so far as the illustrated section is concerned, it is a practically new book. The definition section also has been thoroughly revised and considerably expanded. While the Mallet, Mikado and Pacific type locomotives have been given special attention, the lighter types are by no means overlooked. This is especially true in connection with the switching and Atlantic type locomotives. In connection with each locomotive elevation a complete list of dimensions, weights and ratios is given, an improvement which, no doubt, will be

much appreciated. It is evident that considerable study has been given to the selection of the typical parts and details that are presented and only approved designs that have been successful in service are illustrated. Cross references between the general and detail drawings are included wherever possible. Among the new sections that have been added are one on mechanical stokers and one on locomotive tool equipment; the sections on oil burning locomotives, electric locomotives, air brakes, and frames and frame bracing have been materially enlarged. The illustrations showing the Master Mechanics' standards have been entirely redrawn, making them more legible and greatly improving their appearance. The section on machine tools occupies 60 pages and gives photographic reproductions of practically all kinds of metal working machinery used in the repair of locomotives. The study of machine tool operations by L. R. Pomeroy, which first appeared in the April, 1909, edition of the *American Engineer & Railroad Journal*, and was included in the 1909 edition of the *Locomotive Dictionary*, is again presented.

Car Builders' Dictionary. 1912 (Seventh) Edition. Compiled and edited for the Master Car Builders' Association by Roy V. Wright, managing editor of the *Railway Age Gazette* and editor of the *American Engineer*, assisted by Andrew C. Loudon. Illustrated. 953 pages, 9 in. x 12 in. Published by the Simmons-Boardman Publishing Company, New York, and distributed by the McGraw-Hill Book Company, 239 West 39th street, New York. Price, leather bound, \$6; cloth bound, \$4.

The *Car Builders' Dictionary* is too well known to require any description, and this, the seventh edition, does not differ materially in plan and scope from its predecessors. However, it cannot be properly designated as a revision of the last edition, since it is to all intents and purposes an entirely new book. The progress in car design and construction has been so great during the past three years that a large part of the illustrated section of the 1909 edition was found to be obsolete. The designs illustrated in the present edition have been most carefully selected and represent approved modern practice in every particular. The smaller and lighter equipment has by no means been overlooked, but recent improved designs have been chosen as examples. It is evident that the utmost care has been used to make the book complete and to cover the full range of rolling stock. This has resulted in a material increase in the size of the volume, in spite of the fact that the machine tool section given in the previous edition has been eliminated. The drawings are fully dimensioned, and all of the more important details are shown separately. A cross reference giving the location of the drawings of associated parts accompany many of the captions and are one of the new features which will be fully appreciated. One of the most valuable parts of the book is that containing the standards of the Master Car Builders' Association, which are given complete, and in each case have been redrawn on a larger scale, making them much more legible than those furnished by the association. In the definition section, all of the new terms that have come in general use during the past few years have been included, and their meaning made clear. Definitions of other terms have been completely revised, and in many cases entirely reworded. Among the new features are the complete details and specifications for postal cars as required by the United States government. The section on electric motor cars has been greatly extended, and an entirely new section on wrecking equipment and tools has been added. Typographically the book presents a much more pleasing appearance than former editions, and the reproduction of the photographs is particularly well executed, permitting a study of many of the details which are commonly lost in the final impress of half tones.

Die Beleuchtung von Eisenbahn-Personenwagen (The Lighting of Passenger Cars). By Dr. Max Büttner, Berlin. 235 pages, 6 in. x 9 in., 108 illustrations. Cloth. Julius Springer. Price 7 marks (\$1.75).

The title of this book would be more descriptively accurate if it were to be called the *Lighting of Passenger Cars by Electricity*, for though lighting by candles, oil and gas is discussed,

it occupies but 25 pages of the book. The balance is entirely devoted to a description and discussion of the different methods of electric lighting in use. In the brief reference to the earlier forms of lighting, the Pintsch and Frost systems are described, as well as a few lamps for burning oil and for holding candles. The methods of electric lighting are divided into three classes: Those in which the current is supplied by an accumulator; by a dynamo in the baggage car or other compartment of the train and driven by its own steam engine; and a dynamo driven from the axle of the moving car. The list of the several types of each of the three classes is quite complete, so far as European practice is concerned, but does not quite cover everything that has been done in the United States. This statement applies more particularly to the work of the steam driven dynamo rather than to the axle system; for, among the descriptions of the latter class we find many that have been developed in the United States, so that as a book of reference for the engineer who is engaged, or is interested in this class of work, the book will fill an important role.

In the fourth chapter of the second part, the author gives descriptions of many attachments that are used, such as couplers and the like, and summarizes the situation and requirements for car lighting. According to Dr. Büttner, the same principles should be applied and the same requirements exist as for house or room lighting. The lighting should be of sufficient brilliancy so that passengers can see to read without straining the eyes. The light should be soft and uniform without flicker or variation, and the sources of the light must be so disposed that the eye will not be blinded or dazzled thereby, and the system should be so designed that the maximum amount of illumination will be obtained with a minimum of complication in the mechanism and consumption of power. The arrangement of the lamps should be so planned that, as far as possible, there should be the same amount of illumination at each point throughout the car. To accomplish this, it is not advisable to use a single lamp of high power at any one place, but rather a number of lamps of lower intensity scattered throughout the interior.

As a general thing, deck or ceiling lamps are preferred, though very many side lamps are in use. Referring to the construction of German cars, he states that where deck or ceiling lamps are used they must not be placed too high, and yet they should be high enough so that the shadows cast by the parcel racks will not interfere with the illumination. A height of from 6 ft. to 6½ ft. is recommended, which would hardly be sufficient for the American type of car. While the use of a glass shade to protect the incandescent bulbs from breakage is recommended, the author does not approve of a shade that will absorb any of the light, but urges the use of reflectors above the lamps in order to throw the rays of light down, and commends the practice of using special reading lamps back of the seats.

One paragraph in this discussion is of special interest, wherein there is given a summary of the amount of light furnished to different classes of German cars. The author says that the brilliancy of the illumination supplied varies widely on different systems of railways. The most brilliantly lighted cars in Europe are those of the Prussian State Railways that are fitted with reading lamps. In the first class compartments there are two lamps of 20 candle power each and four reading lamps of 6 candle power each. In the second class compartments, instead of the two of 20 candle power, there are two of 16 candle power. It is calculated that, with this equipment, the illumination is 16.8 candle meters on the floor of the first class car, and 14.8 on that of the second class, with the reading lamps in use. In the new cars the reading lamps have been abolished and the first and second class compartments are lighted with two lamps of 20 candle power each, while the third class are lighted with two of 16 candle power. These lamps are set about 6 ft. 6 in. above the floor and the illumination on the latter is from 10 to 10.5 candle meters. The illumination of the cars on other European roads is, for the most part, less than that just given.

COMMUNICATIONS

THE ADVERTISING PAGES

MINNEAPOLIS, Minn., January 15, 1913.

TO THE EDITOR OF THE AMERICAN ENGINEER:

I wish to congratulate you on the appearance of the advertising pages in the recent issues. Several of your advertisers are taking advantage of their opportunities and furnishing us with real information, often of decided value and always interesting. I wish they would all follow the example of the leaders in this regard and break away from the hackneyed, stereotyped claims of superiority. If their machines are so much superior there must be good reasons for it. Why don't they give us practical examples of results and sound argument and allow us to judge the value of their product on this basis? We have to do it in the end, anyway.

READER.

DEFECTIVE BOX CARS

ALBANY, N. Y., January 15, 1913.

TO THE EDITOR OF THE AMERICAN ENGINEER:

The article in your January issue, by R. W. Schulze, on Grain Car Inspection, deals with a number of important points connected with proper repairs to grain carrying cars. In a great many cases, however, much of the trouble and expense incidental to preparing cars for the transportation of grain and similar commodities would be unnecessary if the cars were better put together when built. The poor workmanship on many box cars makes them unfit for carrying any perishable product, even when they are new, and after they have been used a few months in general service their condition is almost hopeless so far as grain carrying is concerned. This helps greatly to increase the damage and short weight claims and can be bettered only by getting after the design and construction of new cars.

INSPECTOR.

EQUIVALENT HEATING SURFACE

PHILADELPHIA, Pa., January 24, 1913.

TO THE EDITOR OF THE AMERICAN ENGINEER:

It has been your custom for several years to use a quantity which you term "equivalent heating surface" in connection with superheater locomotives. You explain this to be the evaporative heating surface plus 1.5 times the superheater heating surface. I do not understand how you arrive at the conclusion that superheater heating surface is $1\frac{1}{2}$ times as valuable as evaporative heating surface. I understood Mr. Young to state at the December meeting of the A. S. M. E. that his tests indicated the superheater heating surface to be about one-half as valuable as heat absorbing surface as was the water evaporative surface. I believe that Mr. Hoffman also stated that the superheater heating surface was somewhat less efficient. If these are the facts I do not see what justification you have in using $1\frac{1}{2}$ times the superheater heating surface.

PACIFIC.

[EDITOR'S NOTE: Our practice of using 1.5 times the superheater heating surface and adding it to the evaporative heating surface on superheater locomotives started shortly after the first locomotives having a high degree superheater was put in use in this country, and resulted from a desire to obtain a figure for heating surface of superheater locomotives which would permit their ratios to be compared directly with saturated steam locomotives. At that time the Canadian Pacific had more experience with this type of superheater than any other company, and Mr. Vaughan stated that his observations indicated that a locomotive having a high degree superheater with a surface equal to about $\frac{2}{3}$ the water heating surface which its introduction required to be eliminated, would give practically the same power as the

saturated steam locomotive. No elaborate tests had been made to check the figure and it was based largely on practical experience. Since that time there have been no data available that seemed to indicate this figure to be incorrect, although it is believed that it is exactly applicable only to certain particular conditions.

It must be understood in this connection that the locomotive is being considered as a whole and not the boiler alone. Mr. Young's statement applied only to the boiler and was based on the heat absorbing capacities of the different surfaces. The factor as we use it, however, also includes the action of the steam in the cylinders. Tests have shown that the superheater saves on an average of 25 per cent. of the water when delivering the same power. If we assume a case of a saturated steam locomotive where the steam consumption per indicated horsepower per hour is 26 lbs., the steam consumption for a high degree superheater locomotive of the same size, under the same conditions, would be 19.5 lbs. of water per indicated horsepower. At 1,500 horsepower this would require the boiler of the saturated steam locomotive to deliver 39,000 lbs. of water per hour and the boiler of the superheater locomotive to deliver 29,250 lbs. of water. If the saturated steam boiler had an actual evaporation of 10 lbs. of water per sq. ft. of heating surface per hour it would have 3,900 sq. ft. total heating surface. While it is probably not exactly accurate to assume that the evaporative heating surface of the superheater locomotive would have the same average rate per sq. ft., owing to the fact that a considerably larger portion of the surface is in the firebox which will give the same total evaporation in both cases and will thus require less to come from the tubes, the fact that most of the tube heating surface in a superheater locomotive is at the bottom of the boiler, which is probably less efficient than that at the top, there will be no great error introduced by assuming that the average rate per sq. ft. in the assumed case is also 10 lbs., which will give 2,925 sq. ft. of total evaporative heating surface in the superheater boiler. As a general average it is found that the ratio of the evaporative heating surface to superheater heating surface in modern boilers is about as 4.5 to 1, which in the assumed case would give a superheater having 650 sq. ft. of surface. If we then take 1.5 times this and add it to the 2,925 sq. ft. of evaporative heating surface we have a total of 3,900 sq. ft., or exactly the same as is in the saturated boiler.]

TIRE TURNING RECORD

CLIFTON FORGE, Va., January 25, 1913.

TO THE EDITOR OF THE AMERICAN ENGINEER:

I am enclosing a report of a driving wheel tire turning test which in my opinion is very good, and is hard to beat. The depth of cut was from $\frac{1}{4}$ in. to $5/16$ in., and the feed was $9/16$ in.

	No. 1	No. 2	No. 3	No. 4	No. 5	No. 6	No. 7
Diameter wheel, finished, in.	55 $\frac{3}{4}$	55 $\frac{3}{4}$	55 $\frac{3}{4}$	55 $\frac{3}{4}$	55 $\frac{3}{4}$	55 $\frac{3}{4}$	55 $\frac{3}{4}$
Diameter wheel, rough, in.	56	56	56	56	56	56	56
Floor to chuck, minutes.	10	10	5	5	5	7	8
Turning, minutes.	32	27	22	25	18	33	31
Machine to floor, minutes.	7	5	3	4	3	6	4
Total time, minutes.	49	42	30	34	26	46	43
Cutting speed, ft. per minute.	{ 10 to 10	{ 10 to 10	{ 10 to 10	{ 10 to 10	{ 10 to 10	{ 10 to 10	{ 10 to 10
	{ 17	{ 17	{ 17	{ 17	{ 17	{ 17	{ 17

The test was made on a 90-in. heavy duty Niles-Bement-Pond machine, which is driven by a 50 h. p. d. c., Westinghouse motor. I would be glad to know of any one beating the time of 26 in. from floor to floor.

E. A. MURRAY.

Master Mechanic, Chesapeake & Ohio.

DRAFT TIMBER BOLTS.—An ample supply of draft timber bolts should always be kept on hand at car repair points. The time required to straighten and rethread old bolts may cause serious delay to important lading. If new bolts are always available the old ones can be fixed up at a more convenient time.

TESTS OF JACOBS-SHUPERT BOILER

Under Normal Conditions a Locomotive Firebox Without an Arch Evaporates 40 Per Cent. of the Water

The report of Dr. W. F. M. Goss on the comparative tests of a Jacobs-Shupert and a radial-stay boiler of identical size, which were made under his supervision, states that the evaporative efficiencies of the two boilers were found to be practically the same, but that the Jacobs-Shupert boiler demonstrated some advantages in the matter of capacity over the radial-stay boiler and was forced without the least sign of distress to an unprecedented rate of power. When fired at a rate of 6,553 lbs. of dry gas coal per hour and a rate of combustion equal to 115.35 lbs. of dry coal per square foot of grate area, it gave an equivalent evaporation per hour of 19.13 lbs. of water per square foot of heating surface and developed 1,669 boiler horse power, or an equivalent of one boiler horse power for each 1.8 sq. ft. of heating surface. The equivalent evaporation per pound of dry coal was 8.78 lbs. of water, or the evaporation of 7.35 lbs. of water from 68 deg. feed water. The over-all boiler efficiency under these conditions was 65.34 per cent., and of the boiler exclusive of the grate, 67 per cent.

This report shows that when a long flamed bituminous or gas coal was used the fireboxes of both boilers absorbed from practically 49 to 31 per cent. of the heat in the range of combustion from 1,600 lbs. to 4,400 lbs. of dry coal per hour. When using this kind of coal between these rates the percentage of the total heat absorbed by the firebox can be found by dividing the pounds of coal fired per hour by 190 and subtracting the quotient from 56. This applies to a firebox not fitted with a brick arch. In none of the tests of the firebox, as separated from the barrel, was the brick arch used. Tests were made to ascertain the effect of the brick arch on the boilers in their normal condition and this developed that with long flamed fuel the arch showed an increased evaporation per pound of coal of 12 per cent., and when using the short flamed bituminous coal the increased evaporation, due to the presence of the arch, was 8 per cent.

An investigation was made to determine some facts in connection with the circulation of the water around the firebox. These showed the rate of flow to be considerably less than had been anticipated and indicated that the opening in the stay plates of the Jacobs-Shupert firebox was sufficient to admit the water in ample quantities to all parts of the water leg. The tests were not extensive enough to develop accurately the presence of any definite currents.

The general results of the low water tests, which completed the series, have been published in these columns.* These resulted in the failure of the crown sheet of the radial-stay boiler at a time when the water level was 14½ in. below the top of the crown sheet, which occurred 17¾ min. after the water level had reached the crown sheet. The Jacobs-Shupert firebox, however, did not fail in any particular, although the water reached a point 25½ in. below the level of the crown sheet, 34 minutes after it had reached that level. The water level finally fell to nearly 40 in. below the crown sheet and the test was forced to a conclusion by the lack of sufficient steam to maintain the draft. An inspection of the boiler after the tests showed all the usual effects of overheating except that the firebox was intact. Three-quarters of the tubes were out of water and had sagged from the effects of the heat. Several had collapsed. There was some change in the curvature of the sections, but there were no local pocketing and no leaks between the sections. In preparing for this test the tubes of both boilers were welded to the back tube sheet. This test is believed to be a conclusive demonstration of the superior strength and safety of the Jacobs-Shupert firebox under low water conditions.

OUTLINE OF TESTS.

For testing purposes the firebox end of a Jacobs-Shupert boiler was taken at random from a lot which were under construction for a railroad company. No effort was made to have the particular one chosen stronger or better than the others which were going through the shop. It was found impossible to obtain a radial-stay boiler of the same general dimensions as the Jacobs-Shupert boiler and therefore one was built especially for these tests by the Baldwin Locomotive Works. The construction was subject to the specifications and standards of the same railroad to which the Jacobs-Shupert fireboxes were being supplied. Both boilers were built in the presence of a personal representative of Dr. Goss. They were both of the extended wagon top type and had the dimensions shown in the following table.

	Jacobs-Shupert.	Radial stay.
Diameter at front end, in.....	70	70
Diameter at throat, in.....	83¾	83¾
TUBES.		
Number	290	290
Length, ft. and in.....	18-2	18-2
Diameter, in.	2¼	2¼
FIREBOX.		
Length, inside, ft. and in.....	9-1½	9-1¼
Width, inside, ft. and in.....	6-4¾	6-4¼
Depth, inside, ft. and in.....	6-1½	6-2¼
Grate area, sq. ft.....	58.14	58.07
HEATING SURFACE.		
Side and crown sheets, projected area, sq. ft.....	146.2	146.6
Side and crown sheets, developed area, used in all computations, sq. ft.....	168.0	146.6
Total firebox, sq. ft.....	230.8	206.7
Tubes, sq. ft.....	2,759.0	2,759.0
Total barrel, sq. ft.....	2,777.6	2,777.6
Total boiler, sq. ft.....	3,008.4	2,984.3

In the first series of tests, which are designated as Series A, each boiler was divided into two distinct compartments by the introduction of a partition between the firebox and the barrel. This partition was simply the back tube-sheet extended as a single flat plate to the wrapper sheet and the mud ring, and riveted in place between the firebox and the barrel. For the second series of tests, known as Series B, this partition was removed and the boilers were both in the normal condition. In re-tubing the boilers, after the reconstruction of their fireboxes, all tubes were welded in the tube sheets in anticipation of the low water tests. This was done since the tests were for the purpose of subjecting the crown of the firebox to conditions so severe as to bring about its failure and it was thought best to take every precaution to prevent a premature failure of the tube sheet.

The two boilers were mounted side by side in a special building on the grounds of the Lukens Iron & Steel Company at Coatesville, Pa. They were both equipped with the ordinary front end arrangement and stack, except that the usual netting was omitted. A standard exhaust pipe and tip was fixed to the bottom of the smokebox and suitable outside piping was provided to convey the steam generated by the boiler to the lower end of the exhaust pipe. This arrangement provided for a delivery of most of the steam generated through the exhaust tip, and the steam thus discharged provided the usual draft action on the boiler. The control of the draft was through the medium of a valve and a 7 in. pipe line which served the purpose of the usual locomotive throttle valve. The steam passing through it was reduced from the pressure of the boiler to that usually found in the exhaust pipe. Steam in excess of that required to produce the necessary draft was discharged through a 3 in. blow-off pipe, or through the safety valves.

In all tests the feed water first entered a large calibrated tank and the exact amount was recorded, after which it was discharged

*See *American Engineer*, July, 1912, page 366.

to vats from which the injectors took their supply, there being a separate vat for each injector. In the Series A tests two injectors were employed, one feeding the barrel of the boiler through the usual check valve and the other feeding the firebox section through a check valve at the center of the back head above the crown sheet and an internal 2 in. pipe, perforated with $\frac{3}{4}$ in. holes, which continued over the top of the crown sheet nearly to the diaphragm between the two sections of the boiler. Water glasses were provided on both sections and the level in the two parts was kept as nearly as possible at the same height. All fuel, both oil and coal, was carefully weighed on calibrated scales. Other readings included records of the boiler pressure, the temperature and humidity of the laboratory and the outside air, temperature in the smokebox, draft both in front and back of the diaphragm, amount of steam used by the oil burner, and the quality of the steam in both the barrel and the firebox. The smokebox gases, the fuel and the ashes were all analyzed. No temperatures of the firebox are recorded.

Nine tests were made in Series A with oil as fuel, five on the Jacobs-Shupert and four on the radial-stay boiler, and twelve tests were made with coal, six on each of the boilers. Two kinds of coal were used, one known as Scalp Level coal which burns with a short flame and the other as Dundon coal which is a long flame gas coal. In Series A two tests were made on each boiler with Scalp Level coal and four with Dundon coal. Analyses of these coals are as follows:

	Scalp Level.	Dundon.
Fixed carbon, per cent.	75.90	49.54
Volatile matter, per cent.	16.45	34.34
Moisture, per cent.	2.15	3.38
Ash, per cent.	3.50	12.74

In the tests with oil the boilers were operated to give an equivalent evaporation of water in pounds per hour from 20,000 lbs. to 29,000 lbs. and over. It was shown by these tests that each pound of oil resulted in the evaporation of 15.9 to 13.2 lbs. of water per hour, the amount diminishing as the rate of power increased. The tests showed that when the Jacobs-Shupert boiler was made to give an equivalent evaporation of 20,000 lbs. of water an hour, it gave an equivalent of 14.14 lbs. of steam for each pound of oil burned. The later tests with coal showed that at the same rate of power it generated 8.3 lbs. of steam for each pound of Dundon coal burned. This indicates that 1 lb. of oil in locomotive service is equal to 1.7 lbs. of high grade bituminous coal. The tests showed that when 800 lbs. of oil were being fired per hour, 54 per cent. of the total evaporation was from the firebox surface, but when 2,200 lbs. of oil were fired per hour 40 per cent. of the total heat transmission was through the firebox. When giving an equivalent evaporation of 40,000 lbs. of water per hour for the whole boiler the evaporation per square foot of heating surface per hour for the firebox was 49.59 lbs. and for the barrel 6.47 lbs. The ratio of the heat absorbed per square foot by the firebox to that by the tubes when using oil fuel was as 7.6 to 1.

The deduced values covering the firebox performance were obtained by multiplying the evaporation actually obtained by the ratio of the total firebox surface to the firebox surface effective in producing vaporization in the firebox-end of the boiler. The small increment, which by this correction is added to the observed evaporation of the firebox, is in the deduced results, subtracted from the observed evaporation of the barrel. The effect of this correction is merely to credit to the firebox and debit to the barrel the heat transmitted by the back tube-sheet.

Considerable difficulty was encountered in so maintaining the fire as to prevent deposits of soot on the heating surface, and Dr. Goss states: "The results cannot be accepted as constituting a basis of comparison which admits of a high degree of refinement and for this reason no attempt was made to elaborate through a complete heat balance, the computations of the oil-fired tests."

In the Series A tests with coal, either boiler gave an equivalent evaporation of more than 10 lbs. of water per pound of coal at

low rates of power. For the whole series of tests, the evaporation was normally above 8 lbs. of water per pound of coal. This indicates that the thermal efficiency is from 8 to 10 per cent. less when coal is fired than when oil is used as fuel. In this connection, however, it should be noted that these fireboxes were not fitted with brick arches which later tests showed will increase the boiler efficiency from 8 to 12 per cent. when using coal.

The percentage of the total heat absorbed by the boiler, which is taken up by the firebox when burning coal, is shown in the accompanying diagram. The difference of the two kinds of coal is clearly evident in these curves and amounts to about 8 per cent. On the basis of an equivalent evaporation of 20,000 lbs. of water, the percentage of total heat absorbed by the boiler, which is taken up by the firebox of the Jacobs-Shupert design, is 42 per cent. with oil, 42 per cent. with Dundon coal and 35 per cent. with Scalp Level coal. This suggests a possibility of some relation between the character of the fuel and the amount of heat absorbed by the firebox. For example, it may be that the substitution of anthracite coal for bituminous coal would reduce the work done by the firebox below 35 per cent. On the other hand, it may be that the freer burning coal deposits less soot in the tubes and permits them to absorb a larger proportion of the total heat delivered.

When Dundon coal was being fired at a rate of 4,341 lbs. an hour, the Jacobs-Shupert boiler gave an equivalent evaporation

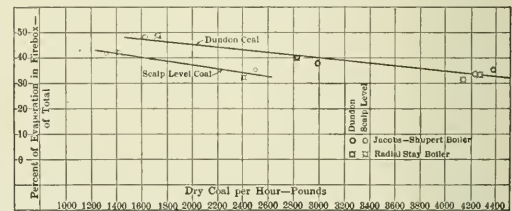

Ratio of Evaporation in Fireboxes at Different Rates of Combustion.

of 35,405 lbs. of water per hour, of which 11,982 lbs. was evaporated from the firebox and 23,423 lbs. from the tubes. The whole boiler developed 1,026 horsepower, of which 304 horsepower was developed by the firebox. The average rate of equivalent evaporation per square foot of heating surface per hour for the whole boiler was 11.77 lbs., and the firebox alone had 51.92 and the barrel 8.43 lbs. The ratio of heat absorbed by the firebox to that absorbed by the tubes was as 6.15 to 1.

In figuring the evaporation for the Jacobs-Shupert firebox, the developed area of the surfaces is used, which makes it about 11 per cent. more than the radial-stay firebox, although the projected area of the two are the same. Dr. Goss concludes from the results of twenty tests that the difference in absorbing capacity of the two types of fireboxes tested is not sufficient to be established by carefully conducted boiler tests.

In Series B there were eleven tests run on the two boilers without a brick arch and eight with the brick arch. There were five tests of the Jacobs-Shupert and four of the radial-stay without the arch fired with Scalp Level coal and one test of each boiler under the same conditions fired with Dundon coal. The tests with the arch installed were all with Scalp Level coal with the exception of one test on the Jacobs-Shupert firebox when Dundon coal was used. The accompanying diagram shows the rates of equivalent evaporation both with and without the arch.

In all tests the efficiency of the boiler was highest when the power developed was the least. For instance, with the Jacobs-Shupert boiler burning 1,389 lbs. of dry coal an hour, the efficiency was 71.86 per cent., or 79.75 per cent. excluding the grate. When the same boiler was burning 6,314 lbs. of dry coal an hour the efficiency was 50.41 per cent., or 55.36 per cent. excluding the

grate. The boiler horsepower was 443 and 1,393 respectively, and the equivalent evaporation per square foot of heating surface per hour was 5.08 and 15.98. The precise effect produced by increasing the load on a boiler is well shown by the values of the heat balance for the several tests run with Scalp Level coal, as shown in the following table. These are all for the Jacobs-Shupert boiler.

Pounds of coal fired per hour.....	1,389	3,419	5,930	6,314
Thermal units for each pound of coal:				
Absorbed by water in boiler.....	10,687	9,327	7,532	7,388
Lost by moisture in coal.....	48	34	37	33
Lost by moisture in air.....	49	33	114	64
Lost by hydrogen in coal.....	486	497	500	514
Lost by smokebox gases.....	1,979	2,731	3,992	4,675
Lost by incomplete combustion.....	78
Lost by cinders passing up stack.....	153	851	1,078	1,012
Lost by combustible in ash.....	1,187	679	291	185
Lost by radiation and unaccounted for.....	205	547	881	783

Total B. t. u. per pound of coal..... 14,872 14,719 14,425 14,654

The tests with the arch in place gave an efficiency above the others in about the proportion indicated in the diagram. When

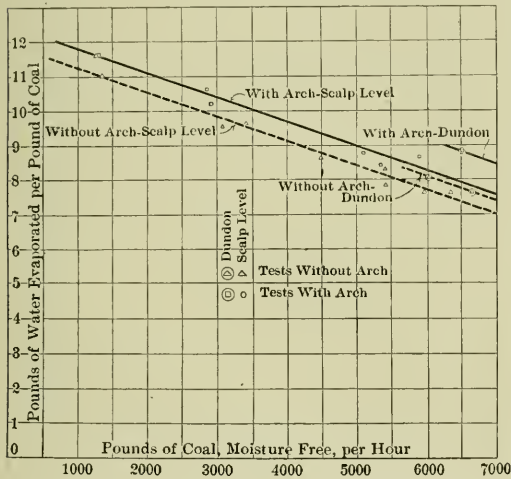

The Effect of the Brick Arch on Evaporative Efficiency.

burning 1,367 lbs. of dry coal an hour and giving an equivalent evaporation of 5.21 lbs. of water and a boiler horsepower of 455 the over-all efficiency was 74.82 and the efficiency excluding the grate was 78.85. When burning 5,887 lbs. of dry coal an hour with an equivalent evaporation of 17.21 lbs. per square foot and a boiler horsepower of 1,500, the over-all efficiency was 57.90 and an efficiency excluding the grate 61.27. The report states that the results of the Series B tests show that the Jacobs-Shupert boiler and the radial-stay boiler under all the various conditions of the test operated at practically the same efficiency. The conclusions regarding the application of the arch are given in the opening paragraphs.

CIRCULATION TESTS.

For the tests to determine the rate and direction of the circulation of the water around the Jacobs-Shupert firebox, George L. Fowler devised the apparatus which is shown in outline in one of the illustrations. A Pitot tube was inserted through a 1 in. hole in the side water leg, being arranged so that its nozzle could be turned in any direction and located at any desired distance from the firebox sheet. Through suitable connections this was connected to a manometer formed of two water glasses, as shown, which was filled with tetrachloride of carbon, colored red, whose specific gravity was exactly 1.6. Thus by turning the tube and observing the effect on the manometer level, the direction of the circulation at that particular point could be ascer-

tained. After this reading was taken, the valve connecting to the manometer was closed and another valve was opened, which allowed the mixture of steam and water entering the tube to flow into the water, partially filling the barrel calorimeter. Having a record of the temperature ranges before and after the admission of the liquid from the boiler to the calorimeter and the pressure existing at the time as registered from the steam gage, it was possible to determine the percentage of steam and water in the mixture as it existed at the mouth of the Pitot tube. From this the specific gravity of the mass could be calculated. Having then the head produced by the difference in the levels of the tetrachloride of carbon in the manometer and the specific gravity of the liquid whose impact caused that difference of level, the velocity of the liquid can be calculated.

Fifteen holes were drilled in the outside sheets of the fireboxes in preparation for this test. The Jacobs-Shupert firebox had eleven sections and the holes were located in three rows; the bottom row being 21 in. above the bottom of the mud ring, the next row 24 in. above the first and the third row 24 in. higher still, which brought it at the turn where the side sheet joins the crown. These holes were located in sections 1, 3, 6, 8, and 10, section 1 being at the front end of the firebox. They were numbered consecutively beginning at the front end of the top row and continuing toward the back of the firebox in each row. Thus holes Nos. 1, 6, 11 were the top, center and bottom holes of the front section and Nos. 5, 10 and 15 were in the tenth section or the second one from the back head. The holes in the radial-stay firebox were at the same relative location.

Unfortunately the time allowed for this work only permitted observations to be taken at holes 3, 7, 8, and 12 of the Jacobs-Shupert boiler and holes 3, 8, and 12 of the radial-stay boiler. Records were taken at 1 in. and 2 in. from the inside sheet for all of the holes and at 3 in. and 4 in. for part of them in each boiler. The results as to direction are shown graphically and as to velocity both graphically and numerically in the illustration. The figures for velocity are in feet per second. Mr. Fowler states in the report that, "the record of the angle of flow must not be taken as positive or fixed." The observations for the

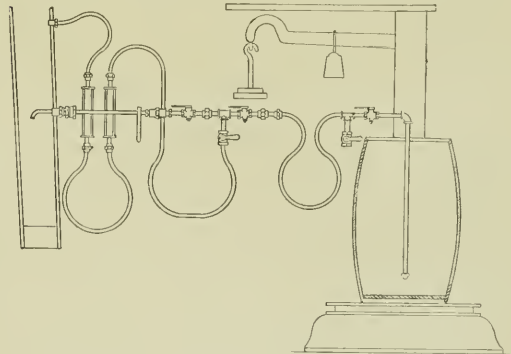

Arrangement of Apparatus for Measuring Boiler Circulation.

direction of the flow were not taken simultaneously with those for velocity; in fact, he makes it clear that the work done in this connection is to be accepted only as the beginning of the solution of a very complicated problem. Dr. Goss' report states in this connection that notwithstanding the limitations that must be placed about them, these results constitute a distinct contribution to the sum of knowledge and are of tremendous significance. They show almost the complete absence of any fore and aft movement of the water. There is no evidence to show that the water in the bottom of the boiler is pushing backward and in the upper part forward, and the observations seem to prove that

enough water passes back from the barrel to the water legs of the boiler to make good that which the firebox evaporates, and no more.

This conclusion was confirmed by the experience gained in running the evaporative tests of Series A. In this case, whatever circulation there was in the barrel could only involve the water in that section and there was absolutely no chance for the longitudinal movement of the water, and yet, under this condition, not the least difficulty was experienced in working the rate of evaporation up to more than 10 lbs. of water per square foot of heating surface per hour; that is, to a rate of power which on the road would be recorded as normal. Dr. Goss concludes from this that the ports in the stay sheets of the Jacobs-Shupert boiler have a very minor function to perform, and as they are now designed they not only are entirely sufficient, but the thermo dynamic performance of the boiler could not suffer in any way even if they were reduced to a small percentage of their present area.

In discussing the results, Mr. Fowler says that he believes that there is a regular slow movement from front to back, broken throughout its whole course by violent agitation and innumerable cross currents, but that in no place are these currents torrential, nor is the stream movement itself very rapid, but that in some places there is a true circulation, the water following a definite

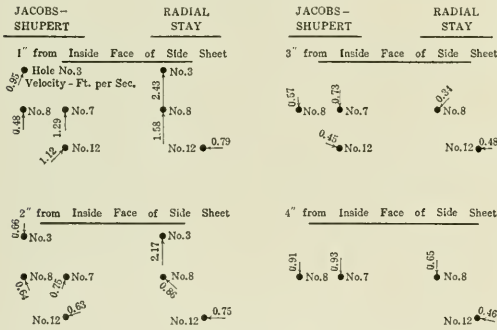

Diagram Showing Direction of the Circulation and Velocity in Feet Per Second.

path returning to a previous position. An example of this is found in one of the tests at hole 8. At 1 in. from the inside sheet there was an upward flow of 1.71 ft per second; at 2 in. the flow was still nearly vertical; at 3 in. there was a neutral point at which no movement could be detected, while at 4 in., or near the outer sheet, there was a vertical movement downward. The same thing is seen in the Jacobs-Shupert firebox at holes 7 and 8, but without the indication of the neutral zone devoid of flow.

So far as the tests showed there was no indication of eddy or reverse currents in the radial-stay boiler. The movement is either vertical or back from the front to the rear, while in the Jacobs-Shupert firebox there was one hole where the movement was from the back to the front, evidently due to eddies set up by the stay plates.

In order to ascertain the likelihood of there being a straight flow of cold water from the front to the rear over the top of the foundation ring, a thermometer was placed at the back lower corner of the Jacobs-Shupert firebox. Feed water at a temperature of about 70 degrees was being used at the time and while the boiler was working at 215 lbs. steam pressure the observed temperature at that point was 380 deg. or only 13 deg. below the boiling point at that pressure. In connection with these circulation tests it should be remembered that both boilers at the time of making the tests were fitted with two arch tubes.

LOW WATER TESTS.

A general account of the low water tests with photographic illustrations was given on page 366 of the July, 1912, issue of the *American Engineer*. The boilers mounted on a fill some distance from the works of the Lukens Iron & Steel Company were arranged for firing with oil. The control of the fuel, the draft pressure and the feed water was centered in a bomb proof about 200 ft. from the nearest boiler. Water glasses were arranged for reading to a point 2½ in. below the crown sheet and records of the water level and steam pressure were obtained by means of telescopes on the top of the bomb proof.

The Jacobs-Shupert boiler was tested first and 53 minutes after the water had reached the level of the crown sheet the test was discontinued for the lack of sufficient steam to maintain

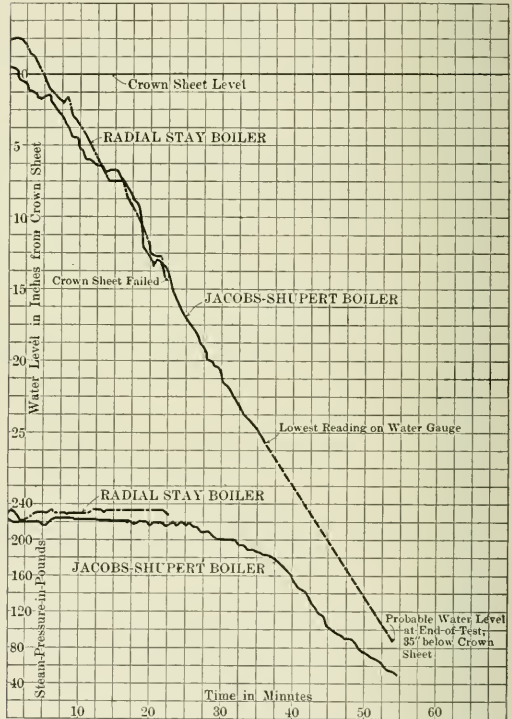

Water Levels and Steam Pressures in Boilers During Low Water Tests.

the draft. At this time 78 per cent. of the water in the boiler had been evaporated and the level was estimated to be about 35 in. below the crown sheet. Since the gages were arranged only for reading at 25½ in. below the crown sheet, its exact level could not be obtained. At the beginning of the test the conditions were arranged so as to provide for the evaporation of 10 lbs. of water per square foot of heating surface per hour, an equivalent of 30,000 lbs. of water an hour. This amount naturally continued to decrease as the test progressed. The steam pressure at the end of the test was 50 lbs. Graphical records of the water level and steam pressure for both boilers are shown in one of the illustrations.

At the completion of the test of the Jacobs-Shupert boiler the radial-stay boiler was put in operation and tested under exactly similar conditions. This boiler continued to operate for about 18 minutes after the water had reached the level of the crown

sheet and finally failed with the water $14\frac{1}{2}$ in. below the crown sheet. The failure was due to the pocketing of a considerable section of the crown of the boiler. The sheet itself, however, was not ruptured and the contents of the boiler escaped through the staybolt holes, the aggregate area of which was found to be approximately 186 sq. in. The explosion blew the brick arch in all directions, forced down one of the arch tubes and displaced the whole boiler for a distance of about 8 in.

A detailed inspection of the Jacobs-Shupert boiler after the tests were completed showed a well defined line running around the firebox approximately 34 in. below the crown sheet. Portions below this section were soot covered and normal in appearance. Higher up and in more exposed sections of the firebox the sections had the appearance of freshly heated steel. Between these two sections was a belt 5 in. in width which was generally reddish brown in color. The hottest sections in the whole boiler were found to be at the center of sections 5 and 6, while sections 9, 10 and 11 did not appear to be as highly heated as the remainder of the upper section of the box. The sections most affected disclosed a curvature which dropped $\frac{1}{2}$ in. more than that which was originally given them. The change in contour, while not entirely regular, disclosed no evidence of a disposition to develop pockets or to local failure by blowing out. It was noted that notwithstanding the temperature to which the firebox was subjected the color of newly heated metal nowhere extended to the stay sheet, nor was there any point on the calking edge of the stay sheet which had been heated beyond that temperature which results in the reddish brown color. There was no evidence of any leaking in the crown sheet.

The tube sheet was found to retain very nearly its original shape with the exception of a small area on either side of the center, near the middle of the heated zone, which was unsupported by tubes and the plate here was bulged to the extent of $\frac{1}{4}$ in. A small leak was discovered at the top of the tube sheet where it joins the first section. The joint here was made with a copper calking strip. Four of the tubes were found to have collapsed just inside of the tube sheet; 14 others were pulled apart inside of the sheet. The welds between the tubes and the sheet were not disturbed in any case. It is probable that the actual rupture occurred in the process of cooling off after the test had finished. All tubes within the heated zone were found deflected downward, the deflection varying from a comparatively small amount to an amount equal to the diameter of the tubes. Tubes below the final water line remained in their original straight condition. There was no distortion or evidence of leaky staybolts on the door sheet and the arch tubes and arch were in perfect condition. It is reported that at the conclusion of this test the boiler, so far as the firebox construction was concerned, was in condition for operation.

On the radial-stay boiler, the section of the crown sheet that failed comprised 188 crown stays and staybolts. The button headed stays failed by the stays breaking inside of the sheet and the flat headed stays pulled through the sheet. Both side sheets with their stays were in perfect condition, no evidence of leaky staybolts appearing. The same is true of the door sheet and side sheets and the tubes appeared to be as secure as when originally welded in place. No tube was found to have been sufficiently heated to sag.

As a result of this test Dr. Goss concludes that the superior strength of the Jacobs-Shupert boiler permits it to be unduly overheated without failure for long periods of time, where the normal radial-stay boiler quickly fails and that where the overheating is so severe that it cannot be resisted, the result will be a blowout and not a disastrous explosion.

COAL.—The total amount of bituminous coal produced by American mines from the beginning of the industry to the end of 1911 is 6,468,773,660 short tons, and the total production of both anthracite and bituminous coal is 8,739,572,427.

MOVING PICTURES IN RAILWAY EDUCATIONAL WORK

Several years ago the Union Pacific established an Educational Bureau for the purpose of giving its employees an opportunity to increase their knowledge of railroad work through the medium of correspondence courses. This same system has also been adopted by the Illinois Central and the Central of Georgia, and in each case has been taken advantage of by about 10 per cent. of all the men employed by these roads. While this proportion may seem small it should be understood that the work is wholly optional with the men, and that at its best it can only be given in an abstract form which lacks the personal element of instruction so necessary to most students. The Educational Bureau, not feeling satisfied with this small percentage, has been endeavoring to work out a supplementary system of education that would interest the other nine-tenths.

Experiments were begun with moving pictures about a year and a half ago by D. C. Buell, chief of the Educational Bureau, to ascertain if they could not be adapted to railroad educational requirements successfully. The prohibitive cost of having moving pictures taken by professional operators pointed out the necessity of developing the moving picture work as a part of the Educational Bureau work, and consequently a moving picture camera was purchased and experiments were started which resulted satisfactorily. About 2,200 ft. of film was exposed, showing the story of fuel economy and the proper and improper method of firing locomotives. These films were first exhibited in connection with a paper by Mr. Buell at the annual meeting of the International Railway Fuel Association at Chicago in May, 1912. Since that time additional pictures have been taken to round out the story and the film has been considerably shortened and in its present state consists of about 1,500 ft.—enough to occupy about 30 minutes if run through the projection machine without stopping.

Stereopticon lantern slides, colored to represent the different conditions of fires, tabular matter, and other data have been added, and about the first of October the Board of Examiners' car on the Union Pacific, which was idle at the time, was fitted with the moving picture projection machine and started over the road in charge of a lecturer who was accompanied by the fuel supervisor of each division. Lectures were given three times a day, and from the start a great deal of interest was manifested in this method of instruction, not only by the firemen and engineers, but by men in other classes of service as well. The car has been crowded almost from the first day it was started out over the road. There have been a number of times where eight or ten of the engineers or firemen brought their wives down to the lecture with them.

As an indication of the impression this work makes, the managements of several of the electric light companies who have furnished the current for the operation of the projection machine at different towns have asked permission to send the engineers and firemen of their plants to attend the lectures, and in each case they have refused to charge for the electric current used on account of the economy they felt their own men would manifest from attending the lecture.

There has been a noticeable decrease in the amount of smoke made around terminals and on the road, as well as the amount of time that the engines pop off. This is so noticeable that it is commonly remarked by conductors, trainmen, yardmen and others. One engine watchman who was tending a locomotive which was used to heat a passenger train nights at an intermediate point, reported that he had burned 5 tons of coal a night until he attended the lecture, and that he never burned over 3 tons a night thereafter.

Officers state that no work of an educational nature that has ever been done has created the discussion or caused the interest being manifested in this moving picture work; the road fore-

men of engines and fuel supervisors report a noticeable reduction in the amount of fuel used in getting trains over the roads; engineers report a saving of over half on some runs. It is too early as yet to give out any comparative statistics of fuel performance on the divisions that have been covered by the car, although the results of the work will be reflected in the fuel statements.

The original moving pictures were taken with a dummy firebox, consisting of a door sheet, flue sheet, arch tubes, arch and grates of a boiler, and a man then demonstrated the proper and improper use of the scoop shovel by firing into this dummy firebox, showing the extra labor caused by stiff-backed, or jerky firing; the ease of firing with a swing; the bad effects of holding the scoop at the wrong angle, throwing the coal over the arch, striking the arch and forming a bank, failing to get coal up under the flue sheet, firing unevenly, thus causing banks, etc.

This series of pictures is followed by a picture taken looking down on to the deck of an engine and showing the fireman actually at work firing. The pictures were taken with the fireman on the helper engine pushing a tonnage train up a hill. The first series of pictures shows a good fireman firing according to the correct principles, and the second pictures a poor fireman firing improperly and uneconomically. This second picture includes haling in the coal, not closing the door between fires, throwing off the lumps instead of breaking them up, shoveling off the slack coal instead of burning it, shaking the grates excessively, hooking the fire repeatedly, and making volumes of black smoke and very little steam. The saving in labor due to proper firing is plainly noticeable.

The next picture shows the waste of coal due to an engine popping off, a man standing on the ground transferring a scoop of coal from one platform to another each fifteen seconds while the engine is popping off, indicating a waste of coal of 60 lbs. or more a minute due to the engine popping.

Other pictures show an engine just in off the road having the fire cleaned. It was cleaned on the ground instead of into the cinder pit, so that as the engine pulled away the great mass of burning fire which was dumped out could be plainly seen, indicating the enormous waste due to firemen not being careful to burn down the fire properly in approaching a terminal. One shows the waste of coal due to filling the tank of an engine too full when coaling it, some of the coal falling off the tank as the engine moved away from the chute. Another picture shows the work of a good fireman and a poor fireman, the camera being set up on the rear of the observation car of a passenger train, showing the graduations in smoke from the clear landscape to one so thoroughly obscured by black smoke as to blot out all the scenery.

The closing picture of the series is a view of a double header handling a tonnage freight train up grade, the fireman on the first engine firing correctly, making practically no black smoke and keeping the engine hot; the fireman on the second engine firing incorrectly, fogging up the whole country and having an uncertain steam supply. This picture was taken by hauling a car, on which the moving picture camera was mounted, up the hill ahead of the double header. The picture is so realistic that one cannot doubt that the man firing the second engine wasted as much coal going up the hill as the first man burned. Very little lecturing is required to tell the story, and it leaves an impression on a man's mind that makes him go out and try the recommended methods of correct firing and demonstrate to himself the labor saved and the economy effected thereby. A complete account of these moving pictures can be obtained from the secretary of the International Railway Fuel Association.

The work done so far has demonstrated plainly that practically every employee of the railroad is interested in instruction work of this kind. It is a certain way to reach "the other nine-tenths," with instructive and interesting information. There is one feature, however, that must be watched, and that is, the

pictures must be absolutely practical. The slightest variation from good practice is picked out and criticized by the men who attend the car. It has been the experience of those on the car that the men come back to as many lectures as they can spare time to attend.

The problem of taking moving pictures is an intricate one, and should not be attempted by an amateur. The cost where the outfit is owned and operated directly, as in the case of the Union Pacific, is very reasonable; in fact, the Union Pacific is equipped to take any class of moving pictures for educational work, and has already had requests from a number of outside concerns and other roads for assistance in this line. The cost of a projection machine to show the films after they are taken runs from \$150 to \$225. A common passenger coach can be made ready for the instruction work at a cost of not over \$25.

Fuel moving pictures are now being shown by the Educational Bureau on the Illinois Central and Central of Georgia as well as on the Union Pacific. Other films are being planned for as soon as the fuel lectures are completed. The proposition of loss and damage to freight is being prepared in story form, the safe transportation of explosives being touched on in the same film. A "safety first" film is being worked out; a film showing proper maintenance of signals is being planned, and quite an elaborate picture story of the cost of waste of time will also be worked up at an early date. There is no doubt but that moving pictures staged and taken by practical railroad men will create and hold interest, more than any other kind of railroad educational work.

CURVES OF LOCOMOTIVE OPERATION

By L. R. POMEROY

On the opposite page is given a diagram showing the relation between heating surface, evaporation per sq. ft., maximum tractive effort, speed in miles an hour, and fuel consumption per hour at different rates of evaporation per pound of coal. These are shown for both saturated and superheated steam locomotives.

The highest speed at which a locomotive will maintain its maximum tractive effort is readily found from this diagram if the probable rate of evaporation is known. In the example shown by the heavy dotted lines, a saturated steam locomotive having 4,000 sq. ft. of heating surface and a maximum tractive effort of 50,000 lbs. can maintain it at 10 miles an hour if a rate of actual evaporation of 10 lbs. per sq. ft. of heating surface is obtained. At this rate the fuel consumption will be about 6,700 lbs. an hour if the boiler gives 6 lbs. of steam for each pound of coal, or 5,000 lbs., if it gives 8 lbs. of steam per pound of coal. If the same locomotive has a superheater giving 200 deg. superheat and still has an evaporation of 10 lbs. of water per sq. ft. of evaporating heating surface, it will maintain its maximum tractive effort up to nearly 13½ miles an hour. The fuel consumption will, of course, be the same in both cases.

The curves may be used also for finding the rate of evaporation, from any known heating surface for any speed at full tractive effort, or the required amount of heating surface at any assumed rate of evaporation. The fuel consumption at any speed and tractive effort will be found by following horizontally from their intersection to the scale at the right for a saturated steam locomotive and to the one on the left for locomotives having superheaters.

These curves are based on a mean effective pressure equal to 85 per cent. of the boiler pressure and are governed by formulas derived as follows:

Let D = diameter of drivers in inches.

d = diameter of cylinders in inches.

s = stroke in inches.

w = weight of a cubic foot of steam at the assumed mean effective pressure.

P = steam pressure in the boiler.

$H. S.$ = total heating surface in square feet.

$r. p. m.$ = revolutions per minute of the drivers.

The total pounds of steam per revolution of the drivers equals

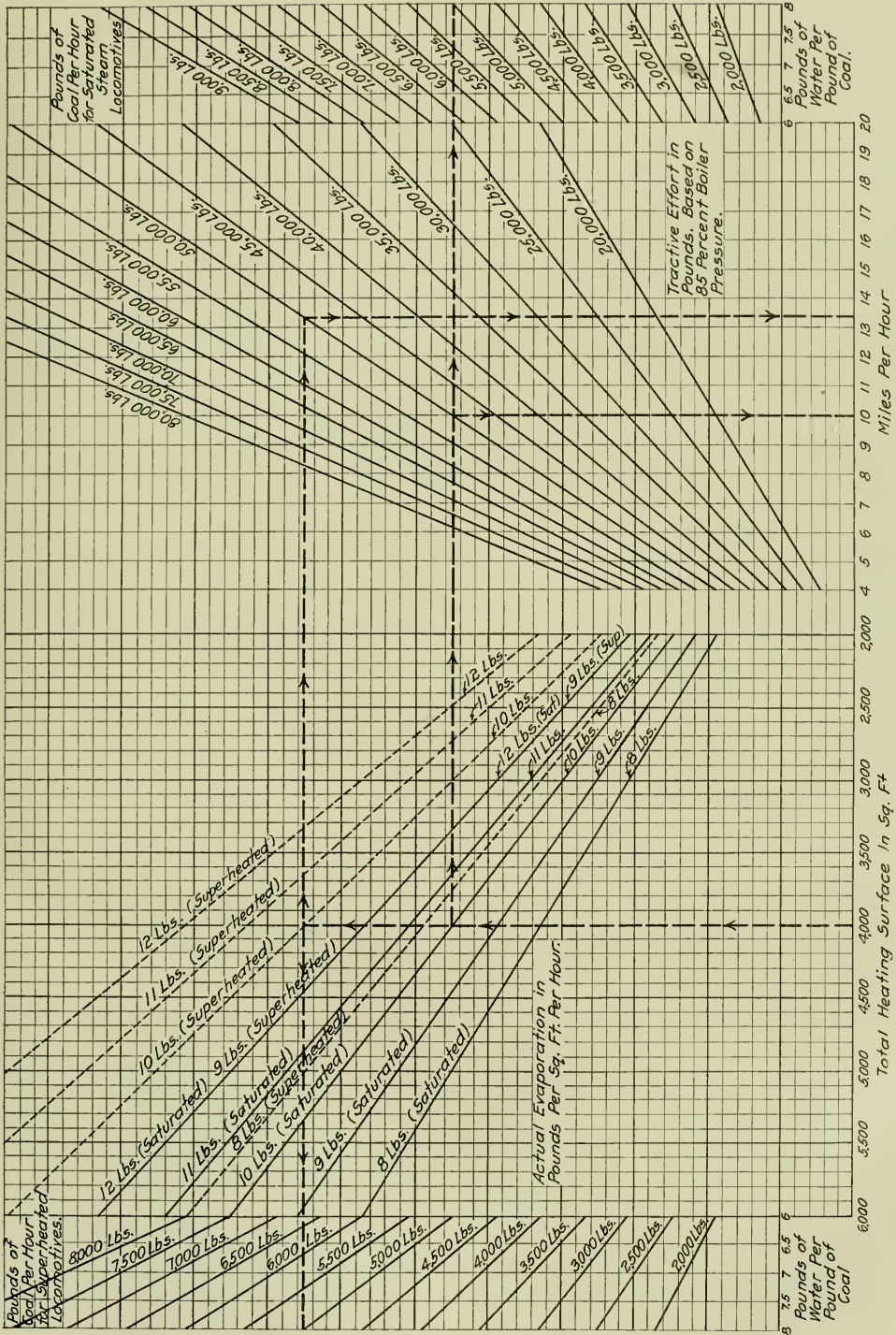

Diagram for Determining the Relation Between Maximum Tractive Effort, Speed, Heating Surface, Evaporation and Fuel Consumption of Saturated and Superheated Steam Locomotives.

four times the cylinder volume in cubic feet times the weight of steam per cubic foot at the mean effective pressure or

$$\begin{aligned} \text{Total steam per revolution} &= \frac{.00182 d^2 s w}{D \times r. p. m.} \\ \text{Miles per hour} &= \frac{.85 P \times d^2 \times s \times r. p. m.}{336 \times T. E.} \\ &= \frac{.85 P \times d^2 \times s}{m. p. h. \times 336 \times T. E.} \\ r. p. m. &= \frac{.85 P \times d^2 \times s}{36.65 \times m. p. h. \times T. E. \times w} \\ \text{Total pounds of steam an hour} &= \frac{.85 P}{.85 P} \end{aligned}$$

The total pounds of steam an hour equals the square feet of total heating surface multiplied by the rate of evaporation and by equating, the formula will be reduced to

$$m. p. h. = \frac{x \times H. S.}{T. E.}$$

For saturated steam locomotives at the different rates of actual evaporation:

For 8 lbs., $x = 99.4$
9 lbs., $x = 112$
10 lbs., $x = 124$
11 lbs., $x = 137$
12 lbs., $x = 149$

For superheated steam locomotives, taking w as the weight of a cubic foot of steam at the mean effective pressure and having 200 deg. superheat:

For 8 lbs., $x = 130$
9 lbs., $x = 149$
10 lbs., $x = 166$
11 lbs., $x = 184$
12 lbs., $x = 198$

The curves for coal consumption are based directly on the total amount of steam per hour.

$$\text{Pounds of coal per hour} = T. E. \times m. p. h. \times Z$$

For saturated steam locomotives at

7 lbs. of water to a pound of coal, $Z = .0115$
8 lbs. of water to a pound of coal, $Z = .01006$
9 lbs. of water to a pound of coal, $Z = .00894$

For superheated steam locomotives

At 7 lbs., $Z = .00866$
8 lbs., $Z = .00758$
9 lbs., $Z = .00673$

These formulas give a water rate of 25.1 lbs. of steam per indicated horse power for saturated steam locomotives and 20.6 lbs. for superheated steam locomotives.

TESTS OF SPRING STEEL

A fibre stress of 256,000 lbs. per sq. in. at the elastic limit was obtained in some recent tests on spring steel made at the McKees Rocks, Pa., works of the Crucible Steel Company of America. This result was given by chrome-vanadium steel, the pieces tested being taken from a pile of spring leaves shaped and tempered ready for the application of the bands. The springs were being manufactured for one of the large railways for service on unusually heavy locomotives.

The pieces selected measured 6 in. x $\frac{3}{8}$ in. in section and the length between centers in the testing machine was 18 in. Successive loads, increasing by increments of 1,000 lbs. were applied to the center of each of the leaves selected. On the first test the leaf had a free height of $2\frac{3}{4}$ in. and at a load of 3,500 lbs. the elastic limit was reached. The corresponding fibre stress was 223,500 lbs. per sq. in. The second leaf tested had a free height of 1 11/16 in. and the elastic limit was reached with load of about 4,000 lbs., the fibre stress being 256,000 lbs. per sq. in. In the third test the leaf developed a fibre stress of 191,750 lbs. at the elastic limit.

In each case the tests were continued until the leaves cracked, which took place with a load of from 11,000 lbs. to 12,000 lbs. At this time all of the leaves were bent to angles of more than 90 deg. and in one case the test piece was bent to an angle of 117 deg. before it cracked.

THE DIVISION MASTER MECHANIC

Most engine house foremen look on a visit from the master mechanic with dread, as something to be gotten over with as quickly as possible. If they can get knowledge of his coming beforehand there is a scramble to get things cleaned up before he arrives. If he drops in unexpectedly they make the best of it, and have a sigh of relief when he is gone.

This is a feeling that could be largely overcome by more frequent visits of the master mechanic. Instead of being tied down to his desk, doing office work that could just as well be done by an assistant, and depending largely for his knowledge of road conditions on his traveling engineer, he should himself get out over the road and study conditions at first hand. There is on many roads a lack of sympathy between the master mechanic and his foremen, largely due to the relations between them being carried on mainly by correspondence. A letter is, at best, a poor means of getting in close touch with a man, and many cases of foremen not making good can be directly laid to their not receiving personal encouragement from their superiors.

A man selected for a position as foreman is called to the master mechanic's office, given a rough idea of the conditions existing at the shop or engine house of which he is to have charge, and is told what is expected of him. A circular is issued announcing his appointment and he starts in with the idea that it is all up to him and that he must go it alone. He may have all the other qualities requisite in a good foreman and lack diplomacy, in which case he will probably get into an altercation with the transportation officials. Reports begin to reach the master mechanic's office and are passed on to the foreman with a request to "please explain." The master mechanic is busy; he has many demands on his time and when he finally has to get around to giving personal and close attention to the case of this particular foreman, it has got to a point where a change is the only remedy.

There are a number of points from which the division master mechanic's duties may be considered and improvements suggested. First, he needs a competent office assistant. This does not mean a chief clerk, but a man who has practical mechanical knowledge and is fitted to have the title of assistant master mechanic. His duties need not be confined to the office, but he should be available as head of the master mechanics' office when that official is away. A chief clerk is very necessary in a railroad office, but signing the name of his chief to letters should not be among his duties, nor should he, if he is not a man with a mechanical training, be allowed to deal directly with correspondence concerning strictly mechanical matters.

With such an assistant to depend on, the master mechanic is at liberty to get out over the road much more frequently. He can ride on engines with his traveling engineer and see for himself just what the latter's troubles are, and what he is doing to overcome them. Frequent visits to the various engine houses are possible, and he can get in close touch with his foremen, hear from their own lips what their difficulties are, make suggestions as to remedies and as to changes in methods and organization. If he finds that one man has a particularly good way of handling a certain piece of work he can tell the others about it, so that they can try it out. In short, he can cultivate a family feeling amongst all the foremen on his division and encourage them to work in harmony. This feeling can be materially increased by periodical meetings at which all the foremen are present. If one man has an idea that his neighbor at the next station is shirking work on engines and throwing it back on him, he has an opportunity then to air his grievance and hear the other fellow's side.

The trouble between the mechanical and operating departments is one that is as old as railroading itself. Engine house foremen get the idea that superintendents and trainmasters are sitting up nights thinking out ways to make it hard for the mechanical department men; and trainmasters think that if they only had a

mechanical department that knew a little about railroading they could handle the traffic pretty smoothly. Coming right down to the base of the difficulty, it is probable that both are to blame to some extent for the reason that one side does not try to understand and co-operate with the other. Instead of trying to work in harmony, one side giving a little here, the other side a little there, it is "my engines" on the mechanical side, and "my trains" on the other side. The division master mechanic has it in his power, to a great extent, to overcome this feeling. He is as much an operating as he is a mechanical officer, and can do a great deal to bring the two sides together and smooth out the rough places. If the trainmaster can be persuaded to attend the meetings of the mechanical men, they can then discuss all the matters at issue, with the master mechanic there as a mediator to explain and suggest; in most cases they will find the foremen ready to meet them considerably more than half way. If the operating officials will visit the foremen themselves frequently, keep them in touch with the traffic conditions and with what their plans are for moving the business, get in touch with the condi-

SUPERHEATER AND FEED WATER HEATER

Arthur T. Lanz, Winterthur, Switzerland, has designed a new type of high degree superheater and in conjunction with it has arranged a feed water heater which employs the same design of elements. In the superheater are three sets of two elements each on each side of the boiler, connected to vertical headers as shown in the illustration. Each of the elements consists of a hollow casting shaped like a horseshoe, in which the ends of three single loop heater pipes that extend back in the large boiler flues are expanded. The elements are arranged with the open space at the bottom, thus allowing brushes and tools to be inserted for cleaning the flues and the outside of the superheater pipes. The inventor states that since superheater surface is more efficient where the direction of flow of the steam and the hot gases is opposed, he has inserted thin twisted strips of metal in the return section of each of the loops to improve the efficiency

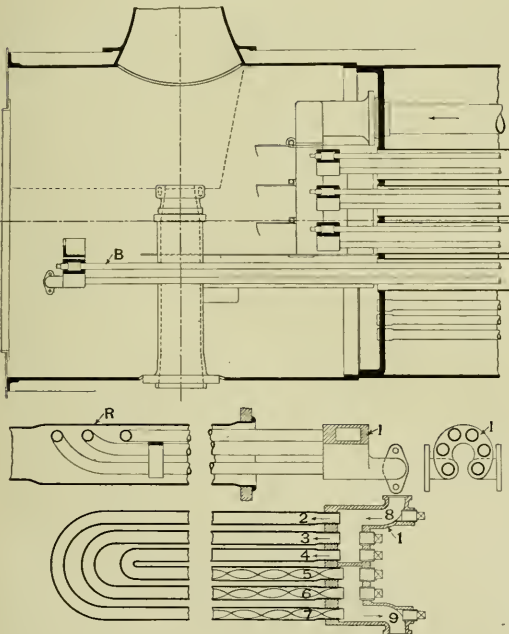

General Arrangement and Details of Lanz Superheater.

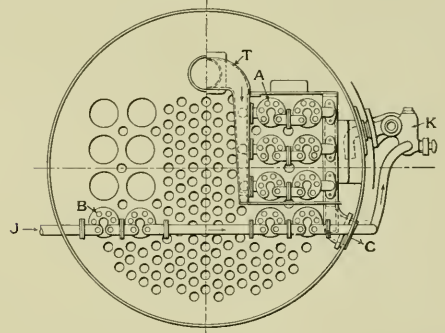

of this part of the element and make all of its surface of equal value.

The feed water heater has four of the same design of elements connected in series in the feed pipe which enters at one side of the smokebox and continues to the check valve on the opposite side. The headers of these elements are located near the front end of the smokebox so as to employ the heat of the gases in the front end to some extent. There are no spiral strips of metal inserted in the return tubes of these elements. With the arrangement shown in the illustration it is necessary to provide a continuous feed from an injector or a pump. If the continuous feed is not possible a combination check valve having a connection to the lower part of the boiler and entering the feed pipe ahead of the first element, would have to be provided. This check valve would be arranged so that when the injector or pump was in operation it would be closed, but when there was no fresh feed water entering, the check would open and provide a circulation from the boiler through the elements, thus preventing them from being overheated. Dampers are provided for the superheater, but not for the feedwater heater. It will be noted that plugs are provided opposite both ends of each of the pipes in the elements allowing the interior of these pipes to be easily and thoroughly cleaned.

tions which surround the foremen and instruct their dispatchers to use a little more judgment and tact in ordering power and asking for information, they will find that there will be much less friction and much more satisfactory relations all around. The master mechanic should be in a position to realize just what his foremen are up against and also the conditions under which the operating force is working. By the use of a little tact he can bring home to both sides the fact that they are working to the same end, and that if they work in harmony that end will be much easier to attain.

ITALIAN RAILWAY EARNINGS.—The Italian state railways (pretty nearly the whole system of the kingdom) earned gross in the fiscal year ended June 30, 1912, an average of \$7,667 per mile, which is \$474, or more than 6½ per cent., more than in the previous year. The aggregate increase was \$6,428,000.

AVIATION RECORD.—An aviator, Faller, at Berlin, Germany, on January 4, remained in the air for more than an hour, with five passengers; and on January 5, he ascended with seven passengers and remained up seven minutes. The seven passengers, with the aviator, weighed 1,242 lbs.

A TABULAR COMPARISON OF RECENT SIMPLE FREIGHT LOCOMOTIVES

ARRANGED IN ORDER OF TOTAL WEIGHTS IN EACH TYPE

Table with columns for Type, SANTA FE (2-10-2), CONSOLIDATION (2-8-0), and various locomotive specifications including weight, dimensions, and performance metrics.

*Includes surface of arch tubes and of combustion chamber where used.

TABULAR COMPARISON OF TYPICAL LOCOMOTIVES OF THE MALLET ARTICULATED TYPE

ARRANGED IN ORDER OF TOTAL WEIGHTS IN EACH TYPE

Type	2-10-10-2	2-8-8-2	0-8-8-0	2-8-8-2	2-8-8-2	2-8-8-2	2-6-6-2	2-6-6-2	2-6-6-2	0-6-6-0
Name of road	Staats Fe	B. & O.	D. & H.	G. N.	D. M. K. N.	Iron M.	So. Pac.	St. L. S. S. F.	C. & O. C. M. S. P. S.	N. Y. C.
Read number or class	3000	3396	2401	2009	206	4000	4022	2007	763	710
Builder	R. R. Co.	Amer.	Amer.	Baldwin	Baldwin	Baldwin	Amer.	Amer.	Baldwin	Amer.
When built	1911	1912	1911	1912	1912	1912	1912	1911	1910	1911
Tractive effort, lbs.	111,600	99,200	105,500	106,000	91,000	94,500	85,400	83,300	72,800	61,200
Weight, total, lbs.	616,000	483,000	457,000	450,000	448,100	435,000	432,600	418,000	396,000	378,650
Weight on drivers, lbs.	550,000	479,200	483,500	420,000	406,600	395,000	398,500	360,000	337,500	317,300
Weight on tender, lbs.	212,000	24,000	23,500	30,000	193,100	20,600	16,100	25,500	23,500	24,000
Weight of tender, loaded	234,000	186,400	181,500	168,800	150,000	171,900	179,400	149,600	163,200	166,900
Wheel base, driving, ft. & in.	19-9	15-6	14-9	16-6	15-0	15-6	10-0	10-0	37-10	40-3
Wheel base, total engine, ft. & in.	66-5	57-4	40-8	52-6	58-2	56-7	56-8	48-10	48-0	55-6
Wheel base, engine and tender, ft. & in.	108-1 1/2	88-1/2	75-7 1/2	83-1	87-6	85-2 1/2	85-6	80-5 1/2	79-8 1/2	83-3
Diameter of drivers, in.	37	56	51	57	55	57	57	57	69	56
Cylinders, number	4	4	4	4	4	4	4	4	4	4
Cylinders, diameter, in.	28 & 34	26 & 41	28 & 41	28 & 42	26 & 40	26 & 40	24 & 38	24 & 34	24 & 38	24 & 35
Cylinders, stroke, in.	32	28	32	32	32	32	30	32	30	32
Valve gear, type	Wals.	Wals.	Wals.	Wals.	Wals.	Wals.	Wals.	Wals.	Wals.	Wals.
Steam pressure, lbs.	225	160	210	210	200	200	200	200	200	200
Boiler, type	E. W. T.	W. T.	Conical	Conical	Belphare	Conical	Conical	Conical	Conical	Conical
Boiler, smallest diameter, in.	377-2 1/2	334 1/2	282-2 1/2	277-2 1/2	401-2 1/2	260-2 1/2	401-2 1/2	342-2 1/2	244-2 1/2	228-2 1/2
Tubes, number and diameter	16-5	24-0	24-0	24-0	21-0	36-5 1/2	21-0	21-0	24-0	24-0
Flues, number and diameter	81-9	99-2	96-5	99-9	78-4	84	84	68-4	75-4	72-2
Length of tubes and flues, ft. & in.	3,635-0	5,701	5,205-5	6,120	4,939	4,381	4,941	4,817-1	4,674	4,898
Heating surface, tubes & flues, sq. ft.	1495 1/2	174	1441	126 1/2	136	126	136	120 1/2	108 1/2	119 1/2
Heating surface, firebox, sq. ft.	6,579*	6,125	5,526-9	5,908	6,446	6,833*	5,763*	6,193*	5,064	5,240
Heating surface, total, sq. ft.	2,328†	1,310	1,257	1,002-0	1,168	1,60†	890	6,233	911	1,068
Heating surface, superheater, sq. ft.	81-9	99-2	96-5	99-9	78-4	84	84	68-4	75-4	72-2
Grate area, sq. ft.	78 3/4	109	96 1/2	114	96 1/2	96	96	78 3/4	90 1/2	96 1/2
Firebox length, in.	40-0	35-0	35-0	35-0	35-0	35-0	35-0	35-0	35-0	35-0
Firebox width, in.	40-0	35-0	35-0	35-0	35-0	35-0	35-0	35-0	35-0	35-0
Kind of fuel	Bit. coal	Bit. coal	Bit. coal	Bit. coal	Bit. coal	Bit. coal	Bit. coal	Bit. coal	Bit. coal	Bit. coal
Tender, coal capacity, tons	4,000	15	15	16	14	13	16	14	12	15
Tender, water capacity, gals.	12,000	12,000	9,500	9,000	8,000	8,000	10,000	8,000	9,000	9,000
Weight on drivers + tractive effort	4-95	4-16	4-39	4-68	4-33	4-20	4-46	4-67	4-32	4-72
Weight on drivers + total weight, per cent	89-50	88-50	92-00	100-00	93-50	90-30	91-00	92-50	86-00	84-25
Evap. heat, surf. + superheater heat, surf.	2-82	5-16	4-87	5-52	5-00	4-70	5-00	5-00	5-55	4-91
Firebox heat, surf. + total heat, surf., per ct.	4-47	6-07	6-80	5-80	6-32	5-07	3-70	3-63	6-69	7-70
Firebox heat, surf. + grate area	3-38	4-10	4-45	5-22	3-53	3-14	3-00	3-38	4-56	4-74
Total heat, surf. + grate area	80-50	68-20	64-50	53-10	56-98	82-50	81-80	93-30	68-45	70-00
Tractive effort X diam, drivers + heat, surf.	970-00	984-00	907-00	1,065-00	961-00	975-00	975-00	962-00	919-85	804-00
Total weight + total heat, surf.	93-90	80-00	78-60	81-60	81-70	69-80	65-00	75-70	72-50	75-50
Volume equivalent simple cylinders, cu. ft.	30-10	34-44	37-08	28-95	26-00	32-20	29-30	28-64	25-50	21-80
Total heat, surf. + cylinder volume	218-00	195-6	165-0	183-39	215-00	200-00	234-00	202-42	232-00	229-00
Grate area + cylinder volume	2-72	2-68	3-35	3-85	2-44	2-86	2-87	2-95	3-31	3-17
Reference for photograph, drawings or de.	Am. Engr. Am. Engr.	Am. Engr.	Am. Engr.	Am. Engr.	Am. Engr.	Am. Engr.	Am. Engr.	Am. Engr.	Am. Engr.	Am. Engr.
1911-p171	1912-p257	1912-p150	1911-p182	1912-p188	1912-p187	1912-p191	1912-p191	1912-p189	1911-p102	1912-p189
1912-p189	1912-p189	1912-p189	1912-p189	1912-p189	1912-p189	1912-p189	1912-p189	1912-p189	1912-p189	1912-p189

*The feed water heater surface is included. †Buck-Jacobs low degree superheater. ‡Reheater surface. §Also has a reheater of 719 sq. ft. surface.

NEW DESIGN OF TRAILER TRUCK

A new design of Hodges trailing truck has been applied to 20 Pacific type locomotives built for the Seaboard Air Line by the Baldwin Locomotive Works. Five of these locomotives have 71 in. drivers and are intended for passenger service, while 15 have 63 in. drivers and are to be used in freight service. They have 23 in. x 28 in. cylinders, carry 185 lbs. steam pressure and are equipped with superheaters, outside steam pipes and Baker valve gear. The boilers are of the wagon top type, 71 in. in diameter at the front end and have 199 two-inch tubes, 19 ft. long, and twenty-four 5 $\frac{3}{4}$ in. flues. The firebox has a heating surface of 208 sq. ft., and is provided with a brick arch. The total heating surface is 2,818 sq. ft., and the grate area is 53.1 sq. ft. The passenger locomotives have a weight of 133,900 lbs. on drivers and a total weight of 211,600 lbs. The weight on the trailer is 37,600 lbs. The freight locomotives weigh 139,150 lbs. on drivers and 218,350 lbs. total. The weight on the trailer is 36,200 lbs.

The Hodges trailing truck, as heretofore built, has jointed spring hangers arranged to swing in a plane perpendicular to the center line of the locomotive and connected at their lower ends to the ends of two cross beams, the one at the rear being secured to the frames. The main equalizers from the rear driving springs extend backward parallel with the frames and rest on the forward cross beam. In the new design the cross beams have been dispensed with and the main equalizer is placed in a diagonal position connecting directly to the bottom of the front spring hanger of the trailer truck. At its forward end it rests on a hanger supported by a cross beam connecting the rear spring hangers of the driving springs. The rear spring hanger of the trailer truck is carried from a bracket bolted to the frame. Both trailer truck spring hangers are made up of links arranged

to come any tendency for the trailer truck springs to get out of alignment with the truck frame when the locomotive is curving. It will be noticed that a guide is provided to insure the correct position of the front spring hanger. This is hinged to the frame and allows free vertical movement.

TAKING UP LATERAL PLAY

BY JAMES STEVENSON.

Gang Foreman, Pennsylvania Railroad, Olean, N. Y.

The method shown in the drawing, of taking up side play in driving boxes, requires the use of a cast steel collar which is

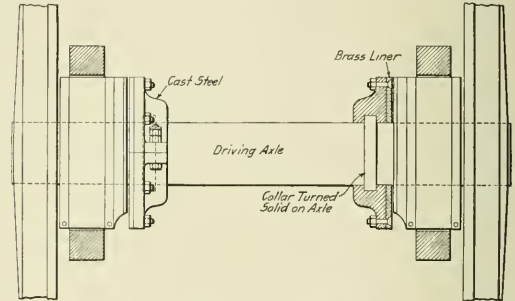

A Method of Taking Up Driving Box Side Play.

clamped over a collar forged on the axle. The wear is taken by a brass liner which is attached to the face of the cast steel

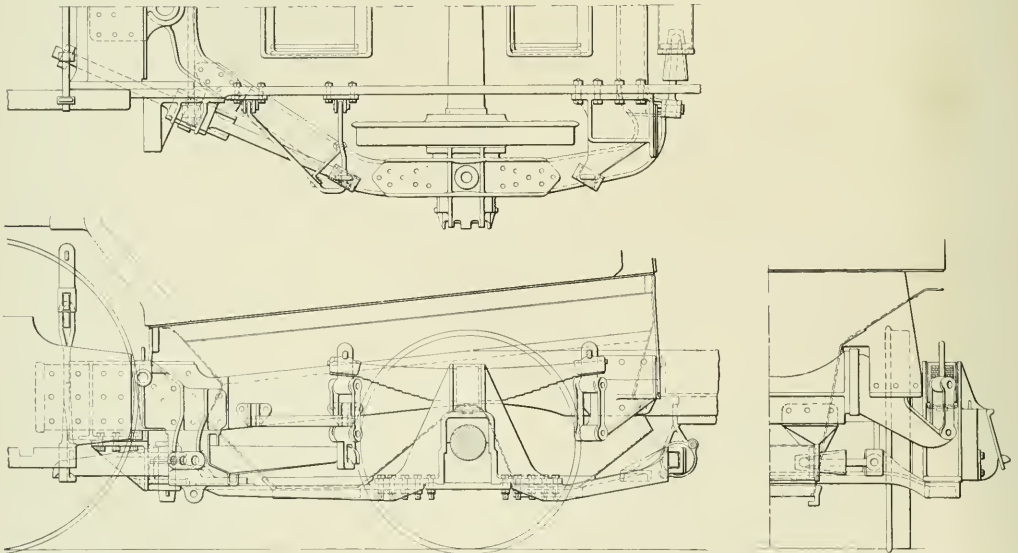

Hodges Trailing Truck; Seaboard Air Line.

to swing in a plane tangential to arcs struck from the radius bar pin as a center. The trailer truck frame has a spring centering device arranged as shown in the illustration, which does not differ materially from the previous arrangement. With this new design of truck it will be seen that the absence of the cross beams permits the better arrangement of the ash pan and its operating gear, reduces the weight somewhat and also will probably over-

collar by bolts with countersunk heads. This device has not as yet been tried out in practice.

ORE SHIPMENTS ON THE GREAT LAKES.—The total movement of ore on the Great Lakes for 1912 was 47,435,777 tons, which is an increase of 15,305,366 tons over 1911.—*Iron Trade Review*.

SHOP PRACTICE

MACHINE SHOP KINKS

BY C. L. DICKERT,

Assistant Master Mechanic, Central of Georgia, Macon, Ga.

TURNING AND THREADING RADIAL STAYS.

A convenient and economical method of turning and threading radial stays is shown herewith. An ordinary turning tool is used for finishing under the head but the ends are turned by a special tool. This is made from a set of worn out dies. Three of them are ground flat and serve as guides while the fourth is ground for cutting. They are held in an automatic die head and perform the work satisfactory. Two sets of threading dies, located on opposite tool holders of a turret lathe, turn the thread on both ends of the stay at the same time.

The arrangement for holding the die chuck for the rear end of the stay is adjustable and slides freely on ways fastened to the turret. This die is started first, as it has the longer thread

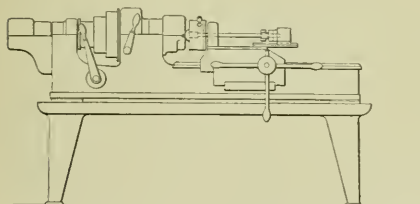
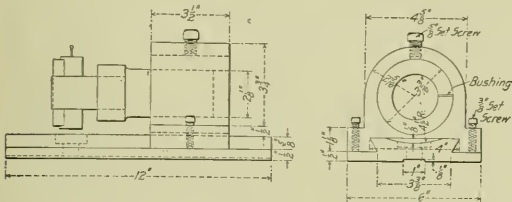

Arrangement for Turning and Threading Radial Stays.

to cut and the forward die is started so as to make them both finish at the same time. The forward die cuts up under the head, making a good fit in the boiler. Both dies are tripped automatically. The dies are adjusted so that the threads will carefully match with the boiler tap and the threads at the top and bottom of the bolt will also be sure to match with each other as the rear dies, being started first serves as a lead screw for the forward die. This device has materially increased the output and decreased the cost.

GANG TOOL FOR CUTTING PACKING RINGS.

The tool shown in the drawing is used for cutting cylinder packing rings. The holder is equipped with six cutting-off tools of tool steel, such as are used in the Armstrong cutting-off tool holders. Between these tools are filling blocks, machined to suit the taper of the tools and made to a thickness suitable for spacing the cutters to the width of the packing ring that is to be cut. On this road two width packing rings (3/4 in. wide for light power and 1 in. for heavy power) are used, which require two sets of filling blocks. The filling blocks are made slightly narrower than the width of the tools to allow the steel plate to firmly clamp the cutting tools when the

set screws are set up. A blind set screw is placed in the end of the tool holder merely to take up the slack in the tools and filling blocks, in order to maintain a uniform thickness of the rings. Each tool is set in the holder 1/16 in. in advance of the other, the top tool being the longer, so as to cause the first ring to be cut through first. This tool is fitted to a 52-in. Bull-

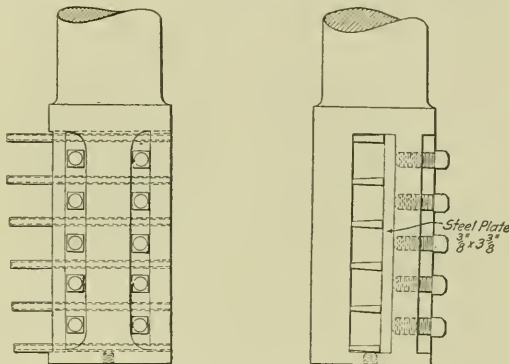

Gang Tool for Cutting Piston Rings.

ard boring mill. Similar gang tools have been described in these columns, but they are somewhat different in detail.

DRIVING BOX KINKS

BY ALDEN B. LAWSON,

Draftsman, Baltimore & Ohio, Baltimore, Md.

BRASS LINERS FOR DRIVING BOX SHOE AND WEDGE FIT.

The illustration shows a method of applying brass liners to the shoe and wedge fits of driving boxes. In the case of old boxes, 3/8 in. is machined off each side, which reduces the dimen-

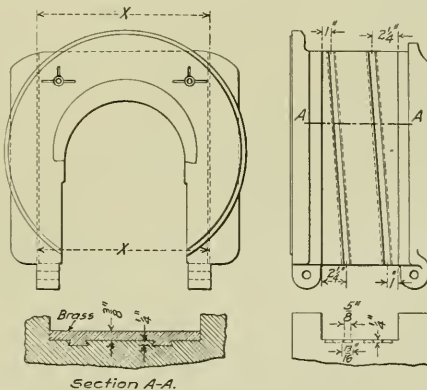

Brass Liner for Shoe and Wedge Fit of Driving Box.

sion X, the standard distance over the faces, by 3/4 in. The dove-tailed slots are planed at an angle to the flanges, as shown. For new boxes the width of the pattern is made 3/4 in. less than the

standard dimension X , and the dovetailed slots are cast in. In both cases the brass is cast on the box and is finished to the standard dimension X . The slots at an angle with the flanges prevent the brass from falling off in case it becomes loose while being machined. When the liner has worn down to about $\frac{1}{8}$ in. thick the brass is machined off, the slots are cleaned out and a new liner is cast on, which saves the driving box from being scrapped.

APPLYING OIL PIPE FOR DRIVING BOX HUB.

A method of applying a hub lubricating pipe to driving boxes which have brass hub liners cast on is shown in the drawing. A No. 20D. wire nail is inserted in a piece of $\frac{3}{8}$ in. copper pipe, about 2 in. long, and the end is allowed to extend into the oil

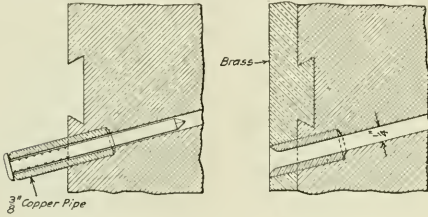

A Method of Applying a Driving Box Hub Oil Pipe.

hole, as shown. The pipe is then held in the proper position while the liner is being poured. After the hub liner is applied the nail is removed and the end of the pipe is cut off and chamfered, as shown in the illustration.

IRON RACK FOR SHORT LENGTHS

BY W. H. WOLFGANG,
Draftsman, Wheeling & Lake Erie, Toledo, Ohio.

The rack shown in the drawings was designed for storing material of less than 10 ft. in length. Concrete slabs are used for the footing and they being only 10 ft. wide will permit of the rack being moved from place to place, if necessary. Where this is done, however, proper eyebolts should be anchored in the con-

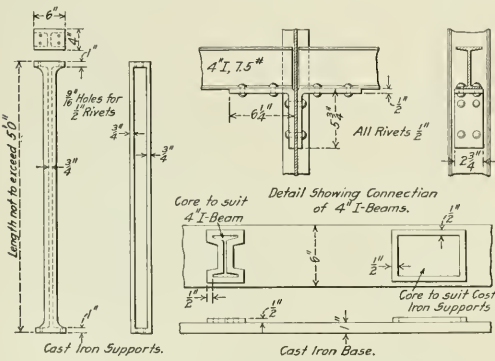

Details of Iron Rack.

crete slabs for the crane chain hooks. Cast iron plates, 1 in. thick, are made in convenient lengths and bolted to the concrete slabs to prevent the abrasion of the concrete. They are cored out as illustrated for the cast iron supports and for the 4 in. I-beams so that they cannot move out of place. The cast iron supports can be either bolted or riveted to the I-beams, and the length of the support can be made to suit conditions. A $2\frac{1}{2}$ in.

oak floor is laid on top of the rack for the storage of all material too short to be placed in the bins. Iron ladders are secured to each end so that a man can easily climb to the top of the rack. The rack would be more convenient if located under a

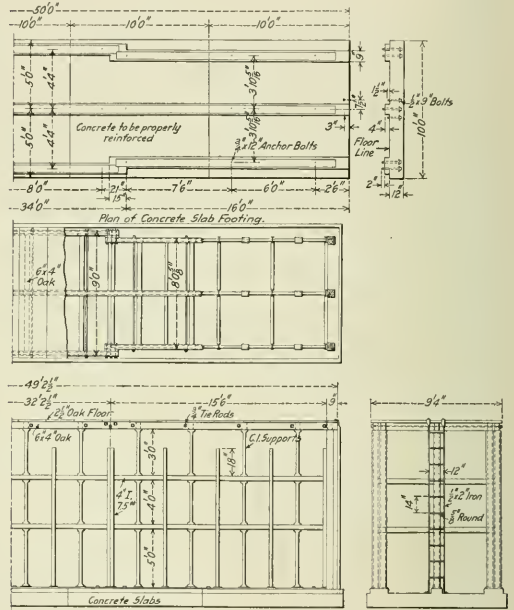

Iron Rack for Storing Material of Less Than Ten Feet in Length.

traveling crane so the material could be more easily handled. The reason one end of the rack is narrower than the other is because the narrow part was an old rack which has been bolted to the new part.

REPLACING A DRIVER SPRING ON A MALLET

BY J. D. ROGERS,
Inspector, Virginian Railway

While the writer was in charge of some heavy Mallets at a pusher grade on the Virginian, it became necessary to change an intermediate driving spring on the front engine of one of them. The spring had 14 leaves $\frac{3}{8}$ in. thick, and was 36 in. long. No jacks or spring pullers were available, and to have sent the engine to the nearest roundhouse would have held it out of service probably 48 hours or more. A 33 ft. rail on the spark track was removed and a 30 ft. rail substituted, filling out with a 3 ft. section held with fish plates. The spring rigging was blocked as high as possible by running the engine on a wedge; the 3 ft. section was removed between the main and intermediate wheels, and the intermediate wheel was run over the opening, allowing the box to drop down to the binder. The gibbs were easily removed and the spring replaced. A wedge was then placed in the opening and the driver was returned to the rail. The total time occupied, including that of removing the rail, was about three hours.

RAILWAY EMPLOYEES IN SWITZERLAND.—The Swiss railways employ a total of 42,000 men, 35,200 of whom work on the state lines and 6,800 on private roads.

THE BULLDOZER IN RAILWAY SHOPS

Typical Examples of Two-Piece Dies Which Have Been Used Successfully on This Type of Machine.

BY LEWIS D. FREEMAN,
Chief Draftsman, Kansas City Southern, Pittsburg, Kan.

The bulldozer has contributed very greatly toward the present high efficiency of the railway blacksmith shop and is now used in nearly every large shop of this kind and in many steel car plants. While it was primarily designed for the hot bending and shaping of heavy bar iron, it is also suitable for hot and cold punching and cold hanging up to the capacity of the tools used.

It is desired in this article to set forth some experiments recently made with this machine to determine just what can be accomplished with two-piece dies, which have to be used on the bulldozer, as will be explained later. Fig. 1 shows a No. 9 bulldozer built by Williams, White & Co., Moline, Ill., the originators of this type of machine. This is one of the largest types and is driven by a 50 h. p., d. c. motor, mounted on a bracket on the side of the machine and geared direct to a reversing clutch shaft so that the machine can be run in either direction and reversed at will. On the clutch shaft is a heavy fly wheel which runs in the same direction as the motor; the energy stored in this fly wheel is sufficient to avoid any undesirable reduction

toggle joint. The nearer the crank pin approaches the forward dead center, the greater is the power exerted; but at the moment of approaching the dead center it is impossible to calculate the pressure exerted with any degree of accuracy. For this reason it is not desirable to place dies on the machine that are much higher than the rear lugs, even though the dies are tapered down to meet the top of the lugs. The center of gravity of the shape being formed determines the point of application of the reaction of these lugs; therefore the higher the shape in the dies the greater the stresses in the frame of the machine, which, while massive in construction, is not meant to resist excessive overloading. Many well designed formers are broken by carelessness,

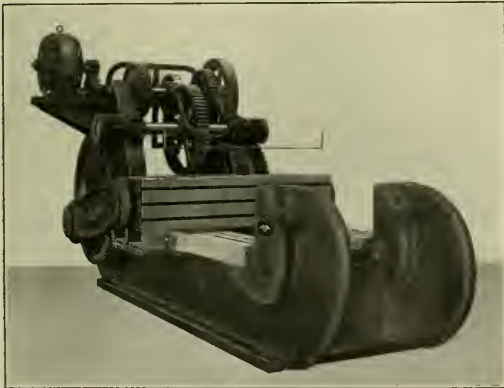

Fig. 1—Large Type of Bulldozer.

in the speed of the motor as the power required by the work fluctuates. The stroke of the machine is 24 in. and the die space is 49 in. from the forward position of the moving crosshead to the back stops or lugs.

When using small or medium size dies it is desirable to have a suitable surface plate or table across the ways of the machine, on which to set them. Such a table is shown in Fig. 2. It has a crosstie at the back to rest against the lugs and is provided with T-slots so that any die can be set on the surface plate, and squared up and bolted down in the most convenient position, saving the labor of placing odd packing back of the dies to bring them up to the moving crosshead. In this way the dies can be so designed that they will take up the entire die space and when they come together with the thickness of the metal between them, the proper pressure will be put on the shape under formation. The heavy set screws in the rear lugs are provided for the purpose of bringing the stationary die up to the moving one and to allow for variation in the material as well as for wear in the machine itself.

The power exerted by this machine is similar to that of the

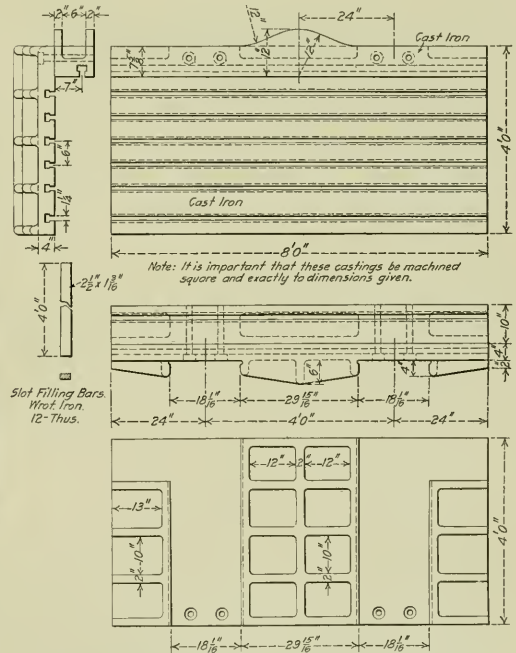

Fig. 2—Surface Plate for Holding Small Dies on a Bulldozer.

such as packing them too close to the moving crosshead, thus throwing great stresses on both the dies and the machine.

Since the force exerted by the crosshead at the moment the crank pin passes the dead center cannot be depended on, it is apparent that considerable skill and good judgment must be used in order to successfully design bulldozer dies. The question of strength in the design is largely a matter of experience, and once knowing how the machine acts with one set, it is safe to assume that all similar ones for the same machine may be built along the same lines. It is necessary to have the dies strong enough to withstand the total power of the machine, regardless of the power necessary to form the shape, as it is more convenient to let the crank make a full stroke so as to release the

work as quickly as possible. The backward motion of the machine is not available for power, and as parts attached to the

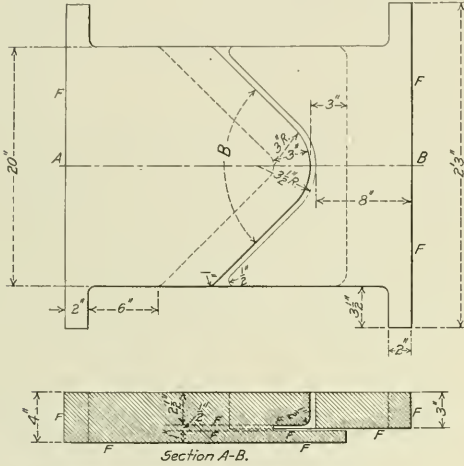

Fig. 3—Dies for Bending Angle Iron.

crosshead have to depend on the bolts for strength, only two piece dies can be used.

The illustrations show some examples of die practice now in successful use on this type of machine. Fig. 3 represents a simple

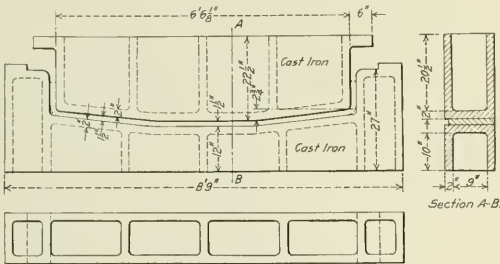

Fig. 4—Dies for Bending Heavy Bar Iron.

form for bending angle iron. It will be noted that there is a slot in the male die into which the lower flange of the angle is pressed. This slot is just wide enough to permit the flange to

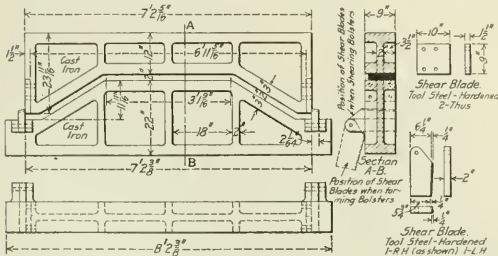

Fig. 5—Combination Forming and Shearing Dies.

enter, and keeps it free from buckling, while the vertical flange is forced to take the shape determined by the angle B.

The dies shown in Fig. 4 are a heavy type suitable for bending

heavy bar iron, such as tender body bolster plates of 1 1/2 in. x 12 in. section. The lugs on the face of the female die are for centering the plate before pressing, the shape of the die being exactly the same as that of the piece to be pressed, with the proper allowance for shrinkage. The coefficient of shrinkage for open hearth steel and boiler plate is .0078 and for merchant bar iron is .0156.

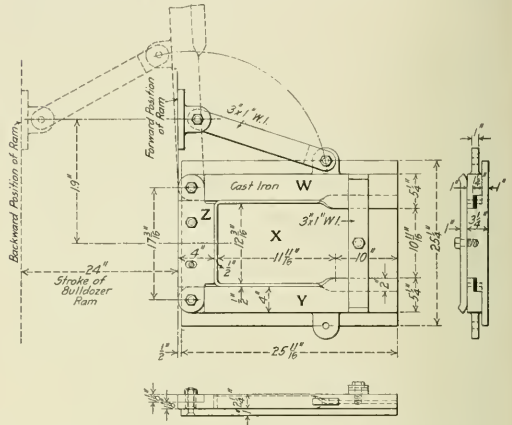

Fig. 6—Dies for Forming Freight Car Sill Steps.

In order to facilitate calculations, 1 plus the coefficient of shrinkage is used. Thus, for a 12 in. piece of thin open hearth steel plate, the calculation is 12 in. x 1.0078 equals 12.0836 in. or 12 3/32 in. nearly. Care should be taken to see that the proper coefficient is used.

Combination forming and shearing dies are shown in Fig. 5.

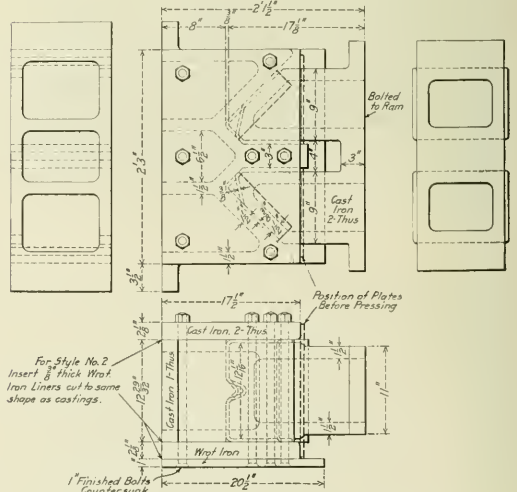

Fig. 7—Dies for Making Coupler Horn Braces.

These may be used for heavy bar iron and also truck arch bars which have not gib ends. By means of hinge joints on the top of the male die, the shear blades are thrown back out of the way while the forming is being done, and on the next stroke of the machine they are let down and the ends of the stock are cut off to the exact length required. The blades are made of tool steel and there are also tool steel faces on the female die. This

operation is one which makes a good showing for the bulldozer. The work was at one time done under a steam hammer and took five or six hours to complete, while it is now done on a bulldozer with two strokes of the machine, the actual time being less than one minute. In addition to the work being done quicker, there is the advantage of having all of the parts exact duplicates.

The safety appliance law makes it necessary to apply many

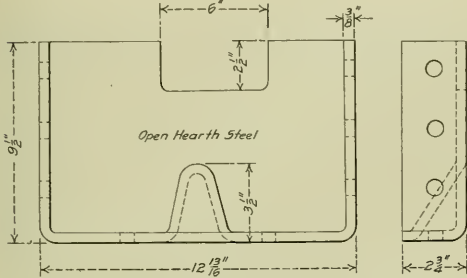

Fig. 8—Coupler Horn Brace Made on a Bulldozer.

new steps on old freight cars and Fig. 6 shows a wing type of die suitable for making them. These dies form the U shape of the step and also twist the ends at right angles for application to the car. The wings *H'* and *Y* are operated by links attached to the crosshead of the machine in such a way that the crosshead can strike the slotted casting *Z* to prevent wrinkles forming on the tread of the step. The wrought iron tie bar across the ends of the wings is to overcome the reaction while the twisting

the bolts. Wherever possible it is better to make the dies solid, but in this case it was necessary to finish the inside to make the width of the braces the exact width to fit accurately between the center sills of the cars.

In making dies for heavy machinery, the castings should, if possible, be machined on their forming surfaces as well as on the faces resting against the machine, to insure an even distribution of the load when a part is being forged. This prevents damage to the dies, as well as to the machine. A great many good dies are broken by either improper fitting up or not being machined at all. It is essential that care be taken to properly design and finish the dies.

The two-piece dies shown in Fig. 9 are used for pressing diaphragms for steel car underframes. Several years ago a number of attempts were made to manufacture these on a bulldozer, but little success attended them. The design shown here was developed after a careful analysis of the other methods. To obtain a perfectly formed diaphragm it was formerly thought necessary to use a three-piece former, which can only be used on a hydraulic press of suitable size. The operation of this type has, however, been so successful that quite a number of similar ones are now under construction. In the operation of these dies, a blank sheet, properly sheared and heated to a bright red heat, is placed in front of the female die. The male die forces the sheet through the sizing section of the female die, the shape emerging into the recess shown by the dotted lines. At the end of the forward stroke, the sheet is forced against the back of the female die, which straightens out the back or web of the diaphragm. The flanges spread slightly and on the return stroke refuse to go through the sizing section of the die through which they previously came. The male die is then drawn back

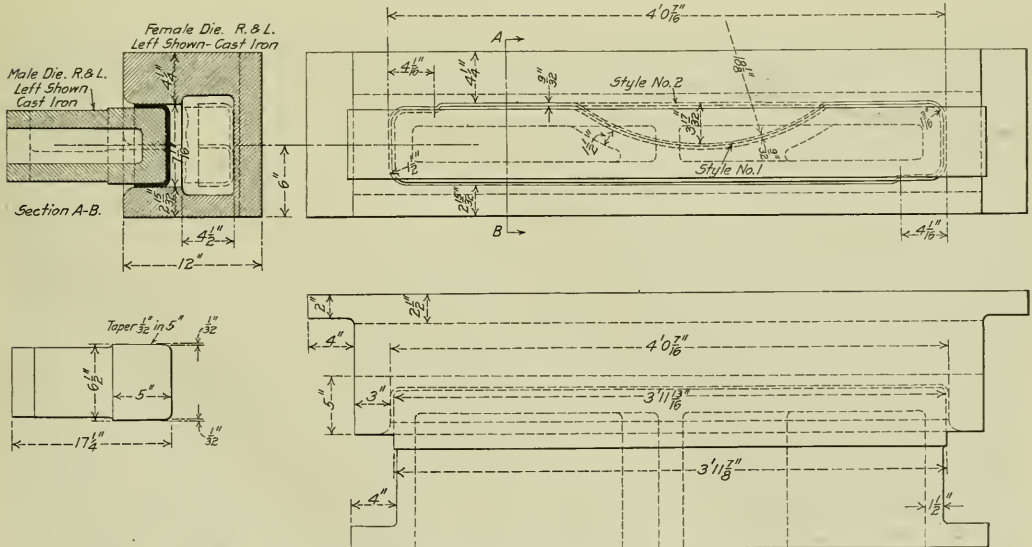

Fig. 9—Dies for Forming Diaphragms for Steel Car Underframes.

is being done and may be quickly displaced to remove the finished step.

Fig. 7 illustrates dies for making two coupler horn braces at one operation of the machine, the idea being to make one side take the reaction of the other. The completed forging is shown in Fig. 8. These dies are so constructed that two widths of the forging can be made by them. In general it is not good practice to make a built-up die for large work, as all the strain comes on

by the crosshead, while the pressed shape is stripped off and remains in the recess of the female die, whence it may be pushed out completed through the opening in the end.

FUEL OIL IN AUSTRIA.—The increased price of fuel oil has affected the Austrian government, who will change their oil-burning locomotives back to coal burning.

APPRENTICE SCHOOLS ON THE ERIE

BY H. E. BLACKBURN,
Technical Instructor, Erie Railroad, Dunmore, Pa.

A system of apprentice schools was started on the Erie in 1908 and the road now has five schools on its lines. The boys

school as practical as possible. The instructor spends an average of about five hours daily in the shop with the boys.

No special efforts are made to turn out draftsmen or foremen, but if a boy shows an aptitude for any particular line of work he is sent to the main shop of the road and is given every opportunity to advance to the position towards which his ambition points. After a boy completes his apprenticeship, it is of course

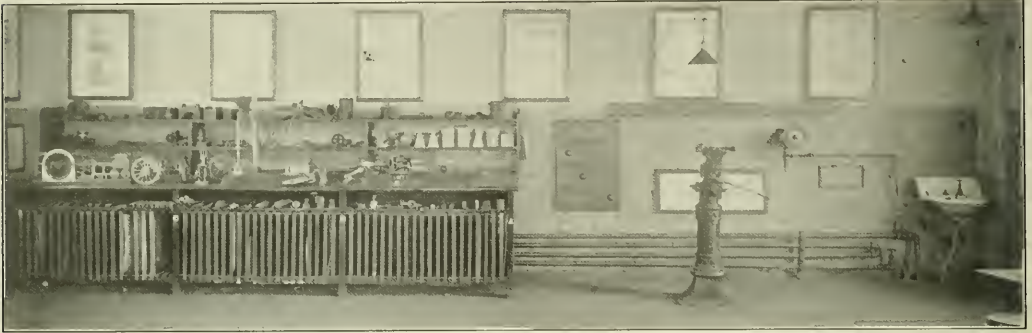

Interior of the Erie Railroad Apprentice School at Dunmore, Pa.

chosen as apprentices are preferably employees' sons and must be over 17 and under 21 years of age. When they are selected they are given mental and physical examinations, and if acceptable are required to serve a three months' probationary period in the shop before they are finally accepted.

Each school is in session 40 weeks a year and the apprentices

the aim to retain him in the company's employ, and every effort is made to do so.

PATENT APPLICATIONS.—According to the report of the secretary of the interior for the year ended June 30, 1912, the U. S.

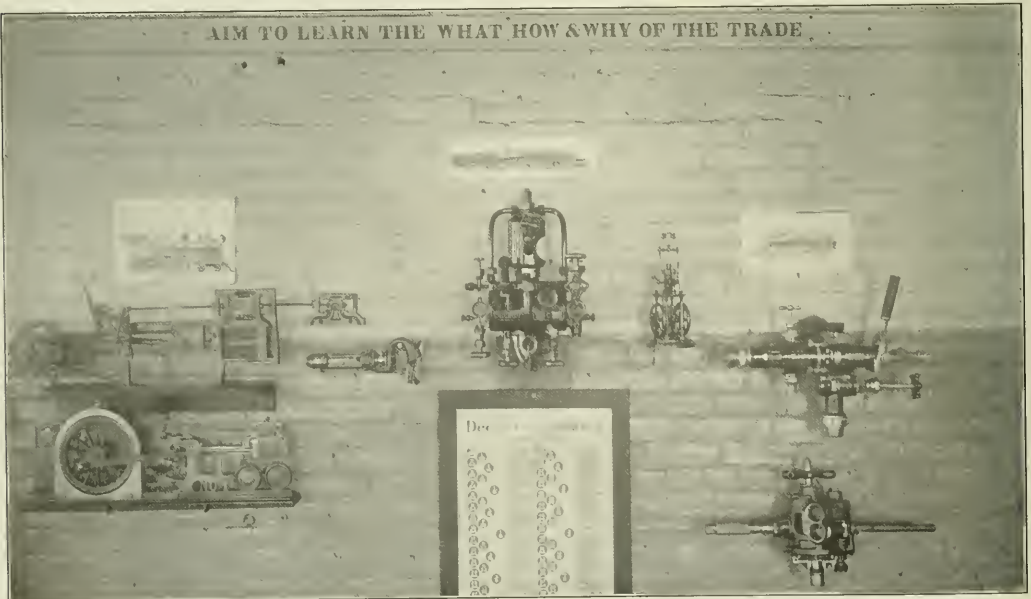

Arrangement of Some of the Models in an Erie Railroad Apprentice School.

are required to attend two two-hour periods each week during the three years of their apprenticeship. The time is given to mechanical drawing, shop mathematics, and instruction in standard shop practice and it is the aim of the instructor to make the

patent office received during the year, 69,236 applications for mechanical patents, 1,775 for designs, 195 for reissues, 7,238 for trade marks, 941 for labels and 362 for prints. There were 35,539 patents granted, including reissues and designs.

SHOP KINKS

BY W. F. CANAVAN,

General Foreman, Missouri, Kansas & Texas, Parsons, Kansas.

TABLE FOR SLOTTING DRIVING BOX BRASSES.

A convenient method for clamping a driving box brass to a slotting machine so that it may be machined for the driving box

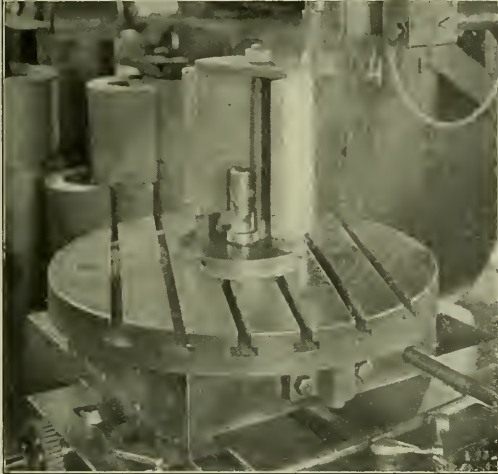

Fig. 1—Attachment for Slotting Driving Box Brasses.

fit is shown in Fig. 1. The brass is placed on three plugs in an auxiliary table fitted to the center of the slotter table and is held in place by a clamp nut fitted in the auxiliary plate as shown.

TOOL FOR TURNING ROCKER ARM BOSSES.

Fig. 2 shows a special tool for turning the bosses on rocker arms. A forked head is made on a tapered shank with a hole in the base of the fork for a centering pin. The tools are placed on the inside of the fork and are held in position by set screws.

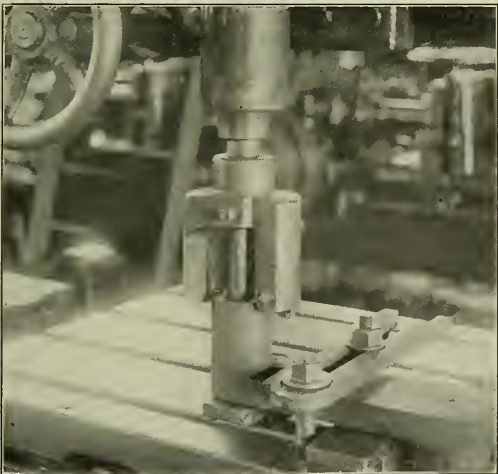

Fig. 2—Tool for Turning Rocker Arm Bosses.

AIR CLAMP FOR DRILL PRESS.

A pneumatic clamp for holding the work on a drill press is shown in Fig. 3. It consists of a 6 in. x 8 in. air cylinder, which

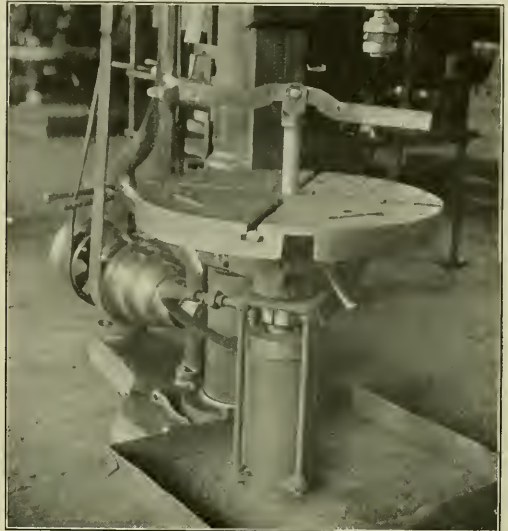

Fig. 3—Pneumatic Clamp for Drill Press.

is located directly beneath the table with the piston rod extending through it. The clamping rod is held in the upper end of the piston rod as shown; one end is placed on the work and the other on a block. A spring in the cylinder under the piston returns the rod to its original position when the air is released.

GRINDING THROTTLE VALVES.

A convenient method of grinding throttle valves is shown in Fig. 4. An air motor is carried on an old man fastened to a



Fig. 4—A Method of Grinding Throttle Valves by Power.

bench and turns the valve through an expansion shaft with two universal joints. The valve may be lifted from the seat while the machine is running, thus eliminating the possibility of grooving the seat.

PRESSING OFF SPRING BANDS.

A discarded wheel press fitted up and used for pressing off spring bands is shown in Fig. 6. After the band has been heated

the spring is placed on a table with one end resting against a notched block as shown in the illustration. The plunger is equipped with a forked ram which forces the spring band from its position.

CYLINDER BORING BAR.

By using the bar shown in Fig. 5, any cylinder may be bored without removing the pilot beam or truck. It was built so as to

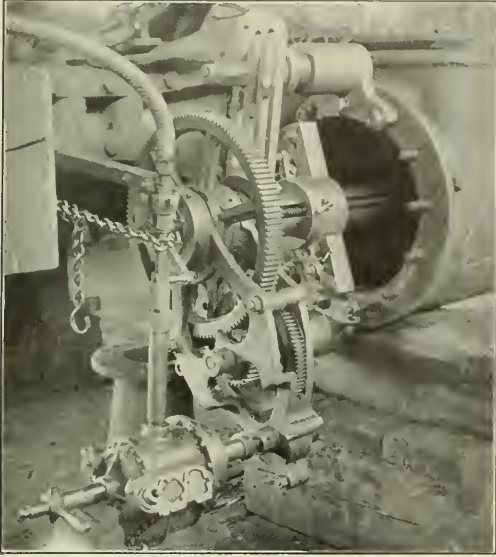

Fig. 5—Boring Bar for Cylinders.

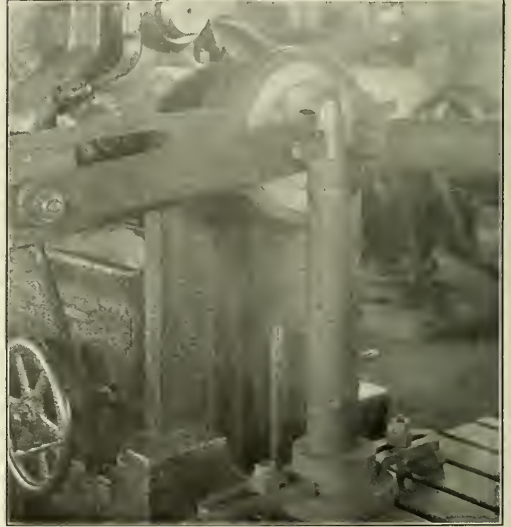

Fig. 7—Tool Post Used on Horizontal Boring Mill for Turning Tumbling Shafts.

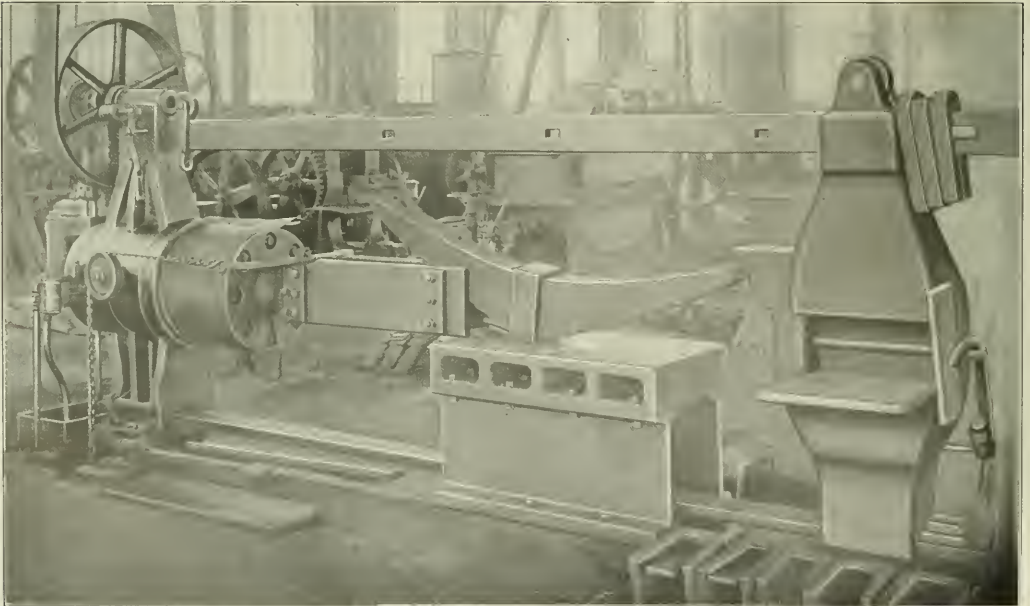

Fig. 6—Wheel Press Arranged for Pressing Off Spring Bands.

obviate the necessity of using offset tools to machine the back head and with it only straight tools are required. The bar is short, running in a taper gland adjusted by a center in the stuf-

TOOL FOR TURNING TUMBLING SHAFTS.

The turning of the bearings on tumbling shafts is an awkward operation where some such tool as that shown in Fig. 7 is not

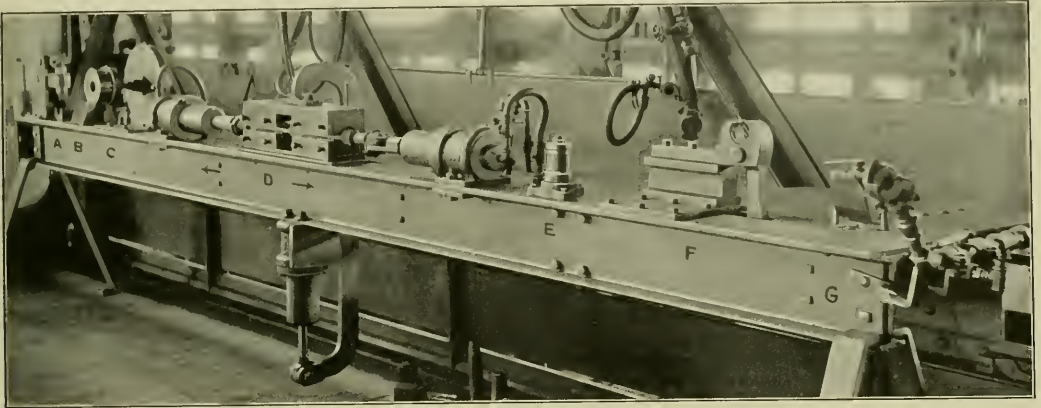

Fig. 8—Apparatus for Mounting Air and Steam Hose.

ing box. The construction and arrangement are clearly shown in the illustration.

used. This is simply a bar sufficiently long to allow the arms to clear the table, and sufficiently stiff to prevent chattering. It

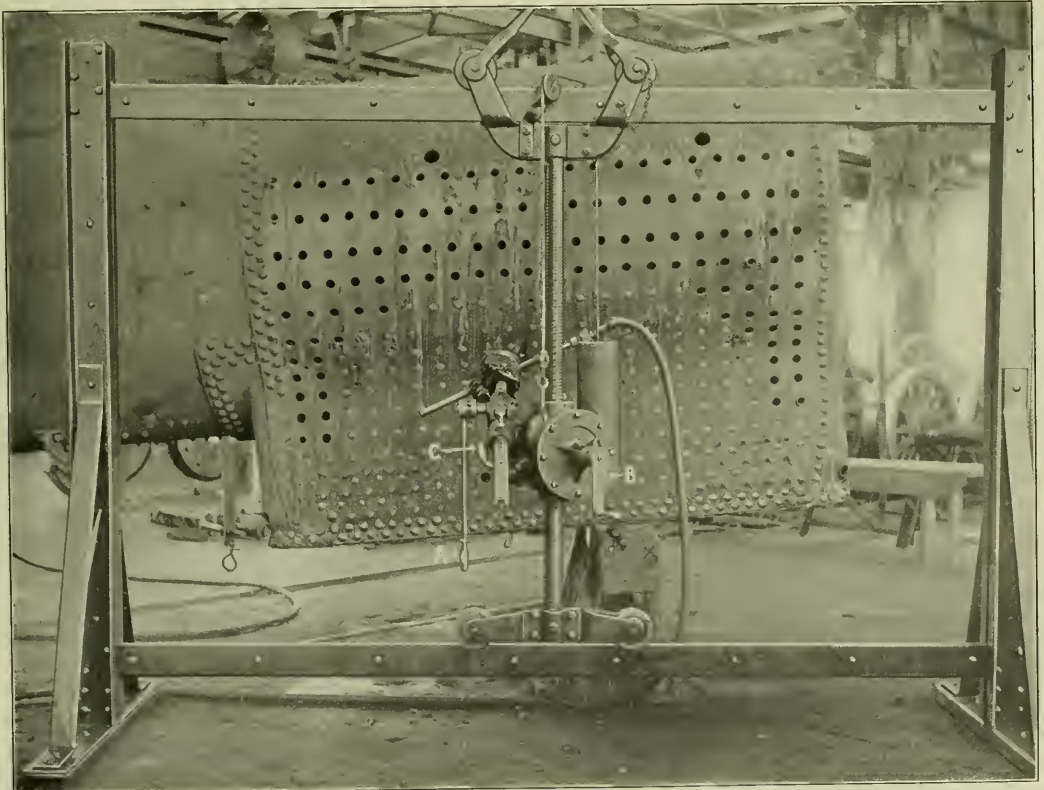

Fig. 9—Arrangement of Drilling Apparatus for Use on Boilers.

is used on a horizontal boring mill, the table being lowered, and operated by the longitudinal and transverse feed.

MACHINE FOR MOUNTING AIR AND STEAM HOSE.

The machine shown in Fig. 8 is a collection of devices for removing and replacing nipples and connections in air and steam hose. At the extreme left the machine *A* is used for breaking the clamp bolt; *B* is a tool for spreading the clamps open; *C* is an annular brush for cleaning the fittings; *D* is a vise for holding the new hose while the fittings are being forced in; *E* is a tool for cleaning the gasket grooves in the couplings; *F* is for tightening the clamp on the hose, and *G* is an air connection for giving the hose its final test. The outfit is neatly arranged on an I-beam and has given good service.

DRILLING HOLES IN BOILER SHELLS.

The boiler repair man knows what a difficult job it is to rig up an "old man" on the side of a boiler to drill out a staybolt, and the time lost in doing the work is considerable. The arrangement shown in Fig. 9 is intended to simplify this work. A frame made of structural shapes and bar iron is made as shown in the illustration, and carries a large vertical lead screw fixed in two two-wheel carriages running on the upper and lower bars. An air motor is fixed on the end of a shaft that is carried on a device operating on the vertical lead screw. The motor is adjusted in and out by the lever *A*, is raised or lowered by the lever *B* and it may be swung up or down, and held rigidly in position by the clamp *C*. In this way it is universal in its action and can be used in any position throughout the range of the frame for drilling out staybolts, drilling and tapping for studs, and for drilling holes.

MILLING ATTACHMENT FOR LATHES

BY E. L. SIEMANTEL,

Apprentice Instructor, Atchison, Topeka & Santa Fe, Amarillo, Tex.

A simple and useful appliance answering the purpose of a milling machine in small shops is shown in the illustration. It is made of a $2\frac{1}{2}$ in. square rough iron rod, one end being turned to fit in the tailstock of the lathe; the other is centered to fit the lathe spindle.

The tool spindle *A* runs in a 2 in. brass bushing and has a

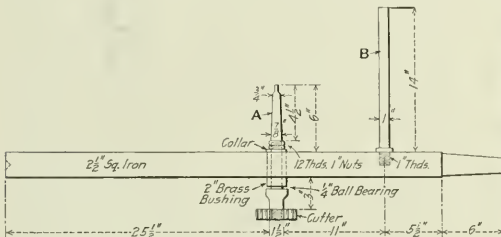

Milling Attachment for Use on Lathes.

thrust ball bearing. It is held in position by two 1 in. nuts. One end is threaded to receive cutters of various sizes. It may be driven by either a belt or a motor, the post *B* being used as a brace for the motor handle when it is used. The work to be milled is attached to the carriage of the lathe and the various feeds are used as desired.

ALTITUDE RECORD.—R. G. GATOS, a French aviator, attained a height of 19,032 ft., exceeding the previous record by 1,151 ft.

DEAD WEIGHT OF VEHICLES.—The dead weight per passenger of a horse-drawn vehicle is between 300 and 500 lbs.; of a motor car, about 1,428 lbs., and of a steel railway coach, from 1,200 to 1,700 lbs.

SHOP HOSPITAL ROOM

Along the lines of the "safety first" movement there is a certain feature that should not be overlooked, and that is a hospital or emergency room at the shops where the injuries of the employees may be carefully and antiseptically dressed. The illustrations show the emergency room of the Chicago, Rock Island & Pacific shops at Silvis, Ill. This plant employs about 1,400 men, and during the three years the room has been in service there has been

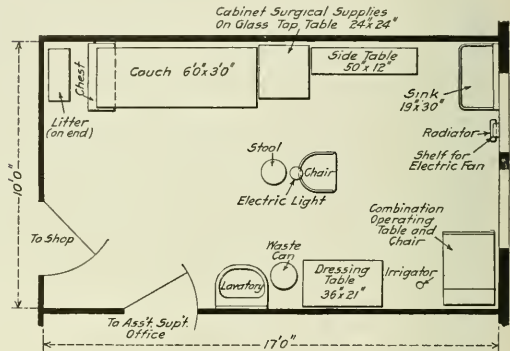

Plan of Hospital Room at the Rock Island Shops, Silvis, Ill.

no case where any man treated has been troubled with blood poisoning afterwards. All employees are required to report the slightest injury received and to have it dressed by the attendant in charge. In case of a serious injury the patient is given emergency treatment and is immediately carried to a hospital. There is a special man in charge of the room who is thoroughly familiar with the "first aid to the injured" rules, and is ready at a moment's notice to give aid. When he is not so occupied he assists in the assistant shop superintendent's office on clerical work.

The room is located just off the office of the assistant shop superintendent, and in the central part of the main shop. It is



General Arrangement of Hospital Room at the Silvis, Ill., Shops of the Rock Island Lines.

completely walled in and is kept in a clean, sanitary condition. All the fixtures are of enameled iron and glass. The walls and ceiling are painted with an enameled white so that they may be easily washed. The floor is completely covered with a single piece of linoleum, making it impossible for dust and dirt to collect in the cracks of the floor. A complete report of each accident

is made and placed on file. We are indebted to G. W. Seidel, superintendent of shops at Silvis, for the illustrations and the information.

MISCELLANEOUS SHOP KINKS

BY W. A. McGEE.
SMOKE STACK CRANE.

A simple crane arm to fit on locomotive stacks is shown in Fig. 1. It is made from a 2 in. round iron bar, which is looped over and welded at the end as indicated in the illustration. It

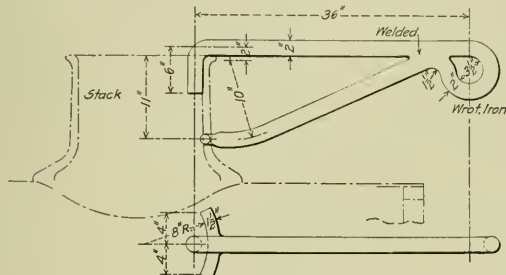

Fig. 1—Smoke Stack Crane.

is handy for applying smokebox fronts or doors, a chain hoist being attached to the end of the arm.

PNEUMATIC LOADING HOIST.

A convenient arrangement for loading or unloading cars is shown in Fig. 2. It consists of a trolley runway built up almost entirely of wood, and a 4-wheel trolley which carries the air hoist. The runway extends over three tracks, having a span of 38 ft., and in this way allows for loading from one car to

another, or in case of unloading car trucks or mounted wheels, unloading from the car directly to the track over which they may be wheeled to the shops. The base of the trestle has a

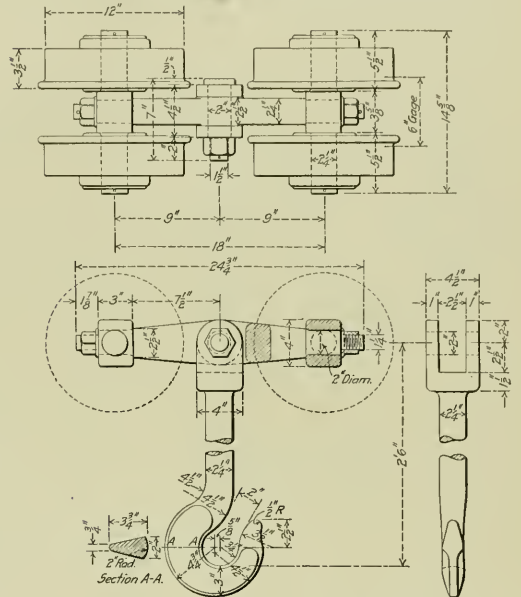

Fig. 3—Trolley for 7-Ton Loading Hoist.

spread of 16 ft., which provides the necessary stability, and the columns are made up of two 5 in. x 12 in. beams bolted

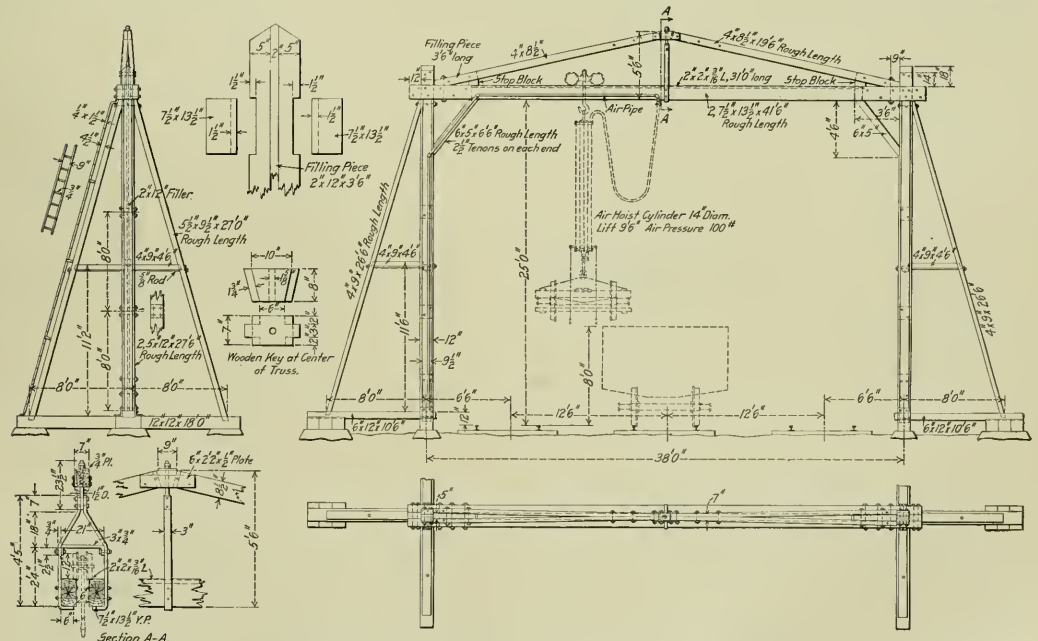

Fig. 2—Pneumatic Loading Hoist Operating Over Three Tracks.

together. The legs or braces are made of 4 in. x 9 in. stock, and are tied together 11½ ft. above the ground by a 4 in. x 9 in. beam with a ½ in. iron tie rod. The runway consists of two 7½ x 13½ in. beams, which are supported at the center by a yoke suspended from two diagonal braces of 4 in. x 8½ in. stock, extending over the runway and footing in the up-

shown in Fig. 6. It is made of a galvanized iron tank with ½ in. copper heads and 1 in. pipe with the necessary fittings. Air is admitted the top of the tank through a tee, the upper end of which is used for filling the tank with sand. The air pressure in the tank is throttled down to about 10 lbs. per sq. in. by a valve, as indicated, and the air pressure for the blast is

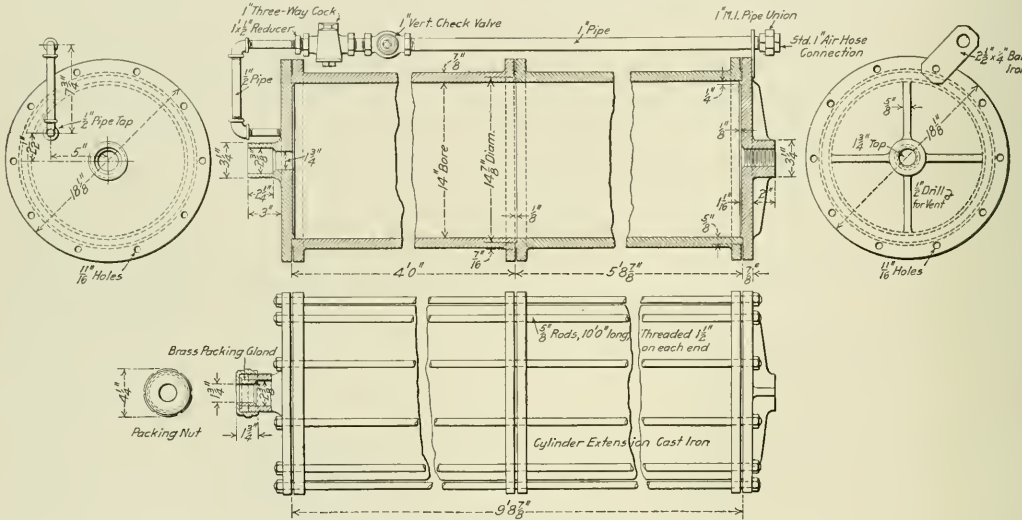

Fig. 4—Air Cylinder for Loading Hoist.

rights. The edges of the runway on which the trolley rolls are protected by a 2 in. x 2 in. x 3/16 in. angles. The trolley, as shown in Fig. 3, has four 12 in. wheels spaced 18 in. on centers, which support the carriage with the hook to which the hoist is attached. The air cylinder is shown in Fig. 4, and is 14 in. in diameter inside, and has a stroke of 9½ ft. It is made in two sections, one 4 ft. long and the other 5 ft. 8 7/8 in. long; these are tied together by ten 5/8 in. rods. The details of the pis-

regulated by the globe valve below the shop line connection. Two hooks are riveted to the sides of the tank so that it may

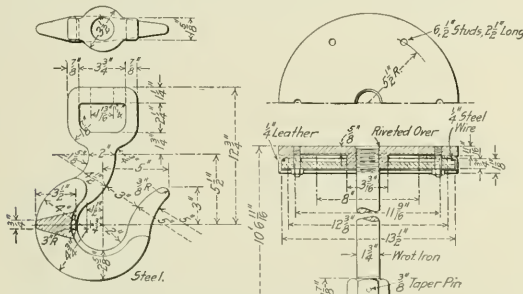

Fig. 5—Piston and Hook for Pneumatic Hoist.

ton, piston rod, and swivel hook which fits on the end of the piston rod are shown in Fig. 5. It will be noticed that the piston is packed with a leather cup washer which is held out against the cylinder walls by a ¼ in. steel wire spring. With an air pressure of 100 lbs. the hoist should easily handle 6 or 7 tons. It is operated from the ground, two chains extending down from the operating valve.

PORTABLE SAND BLAST.

A portable sand blast apparatus used for removing paint is

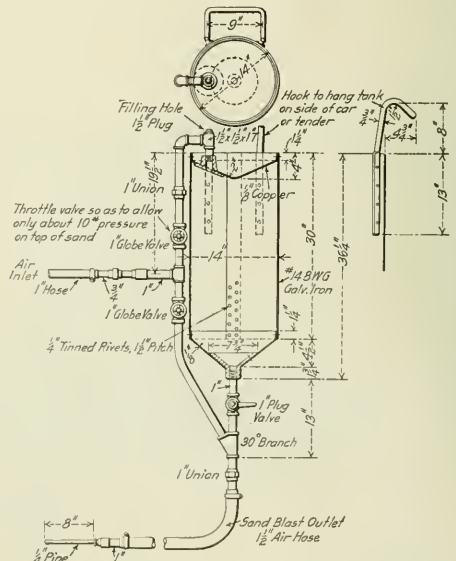

Fig. 6—Portable Sand Blast Apparatus.

be hung on the side of the tender or at any place convenient to the work. The whole outfit can be easily carried by two men.

CAR DEPARTMENT

CABOOSE LAWS

The Special Committee on Relations of Railway Operation to Legislation, W. J. Jackson, chairman, has issued under date of December 10, 1912, bulletin No. 43, on legislation prescribing the construction of caboose cars as enacted in sixteen states. The accompanying table gives an analysis of these laws.

These laws do not apply to narrow gage lines in South Dakota; to logging roads in Washington; to roads of less than 15 miles in length with grades more than 200 ft. to the mile in New York; to passenger equipment used as a caboose in Nebraska, South Dakota and Virginia; to cabooses used in yard or transfer service in Illinois, Indiana and Iowa; to cabooses used on logging or lumber trains in Virginia and Wisconsin; to cabooses on work trains in Iowa; to cabooses used in original construction work in South Dakota; to unusual and unforeseen demands of traffic in Illinois and Indiana; to emergencies not exceeding 36 hours in Iowa; to cabooses used on account of accidents or casualty in South Dakota; to cabooses in service March 30, 1911, complying with the act except as to end doors and platforms in Missouri; and to cabooses in service April 25, 1910, complying

developed, and applied for letters patent on, a construction of this type. In this device the platform and vestibule are so constructed and attached to the car that they will collapse in case of a collision. This gives a shock absorbing distance between

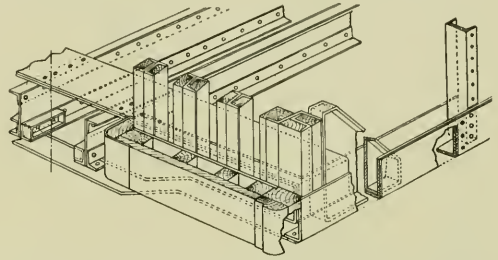

End Construction of Steel Car Equipped with a Wooden Vestibule.

two cars equal to the combined depth of the platforms. To accomplish this, the center sills are run only to the end of the car body, and the connection between them and the platform

ANALYSIS OF CABOOSE LAWS IN THE SEVERAL STATES.

	Arkansas.	Illinois.	Indiana.	Iowa.	Michigan.	Minnesota.	Missouri.	Montana.	Nebraska.	New York.	North Dakota.	Ohio.	South Dakota.	Virginia.	Washington.	Wisconsin.
Height in feet.....	7	24	State Com. 24	24	24	28	24	24	24	24	24
Length in feet.....	24*	24	24	24	24	28	24	24	24	24	24
Strength (A means equal to 30-ton freight car constructed to M. C. B. standards).....	2-4	2-4	2-4	2-4	2-4	2-4	2-4	2-4	2-4	2-4	2-4	2-4
Number of trucks and wheels.....	2-4	2-4	2-4	2-4	2-4	2-4	2-4	2-4	2-4	2-4	2-4	2-4
Platforms, inches wide (S means not specified).....	24	30	24	18	State Com.	S	30	S	20	S	24	24	24	S	S
Doors (B means each end).....	B	B	B	B	B	B	B	B	B	B	B	B	B	B
Guard rails (R means required).....	R	R	R	R	R	R	R	R	R	R	R	R	R	R
Grab irons (C means required).....	C	C	C	C	C	C	C	C	C	C	C	C	C	C
Steps (R means required; E means required with rod, board or guard).....	E	R	E	E	R	R	R	E	E	E	E	R	R	R
Hand brakes.....	One	Each end
Air valve.....	Inside
Capola (R means required).....	R	R	R	R	R	R	R	R	R	R	R
Windows (R means required).....
Closets (F means water; G, type not specified).....	G	G	G	F	F	F	G	G	F
Penalties (dollars).....	100 to 500	100 to 500	100 to 500	100 to 500	50	500 to 1,000	500 to 1,000	500 to 1,000	100 to 500	100 to 500	10 to 50	500 to 1,000	500 to 1,000
Existing equipment to be corrected (H means at general repairs).....	H	H	H	H	H
Time extensions to be allowed by State Commission.....	1 yr.	1 yr.	1 yr.	1 yr.	1 yr.	1 yr.
Enforcement of act (J means at discretion of State Commission).....	J	J
Date effective.....	Jan. 1, 1913	1909	June 1, 1914	1912	1910	1909	1911	1907	June 1, 1914	1909	June 1, 1914	1910	1911	1910	1910	1910

*Including platform.

with the act, except as to platforms if they are 20 in. wide, in Ohio. There are no exceptions made in the other six states.

A COLLAPSIBLE END CONSTRUCTION FOR PASSENGER EQUIPMENT

The advisability of attempting to make a collision-proof end for passenger cars has been held in question by many designers, who claim that such a construction cannot be produced without making the weight of the car excessive. An alternative which has been sometimes suggested is a construction that will absorb the shock of a collision by crushing, before serious damage can be done to the car body.

The Barney & Smith Car Company, Dayton, O., has recently

developed a construction of this type. In this device the platform and vestibule are so constructed and attached to the car that they will collapse in case of a collision. This gives a shock absorbing distance between two cars equal to the combined depth of the platforms. To accomplish this, the center sills are run only to the end of the car body, and the connection between them and the platform is made of such strength that it will give way when anything greater than the maximum service shock is received on the other end of the vestibule. The steps, vestibule door and hood will of course collapse when the rivets shear on the sill extensions, and these will assist in absorbing the energy of the shock. The end of the car body is designed for great strength, heavy sections being used for the end posts. It is generally claimed that in the case of cars attempting to telescope, the point of greatest shock is never over 20 in. above the floor line, and with this in view the intermediate posts are reinforced for a distance of about 4 ft. above the floor by angles riveted to the inside. The end of the car is further protected by pressed steel triangular shapes about 30 in. high, placed at the sides, as shown in the illustration. In order to hold the end posts in position, and also to prevent parts of the vestibule piercing the end of the car, it

is covered entirely by a heavy steel plate, which is attached to the roof and extends to the bottom of the end sills. It is claimed that this plate, in case the entire shock of a collision is not absorbed by the collapsible vestibule, will tend to pull the roof of the car down and throw the next car up instead of allowing the two cars to telescope. Pressed steel shapes are also placed below the platform end sill, forming a part of the collapsible

steel. A collapsible construction of wood has also been designed, which may be applied to car bodies of either steel or wood construction. As shown in one of the illustrations, in applying this type to a car of steel construction an auxiliary end of wood is used. This makes two walls at the end of the car, one the regular car end reinforced with wood, and the other the vestibule wall which rests directly against the end of the car. The entire

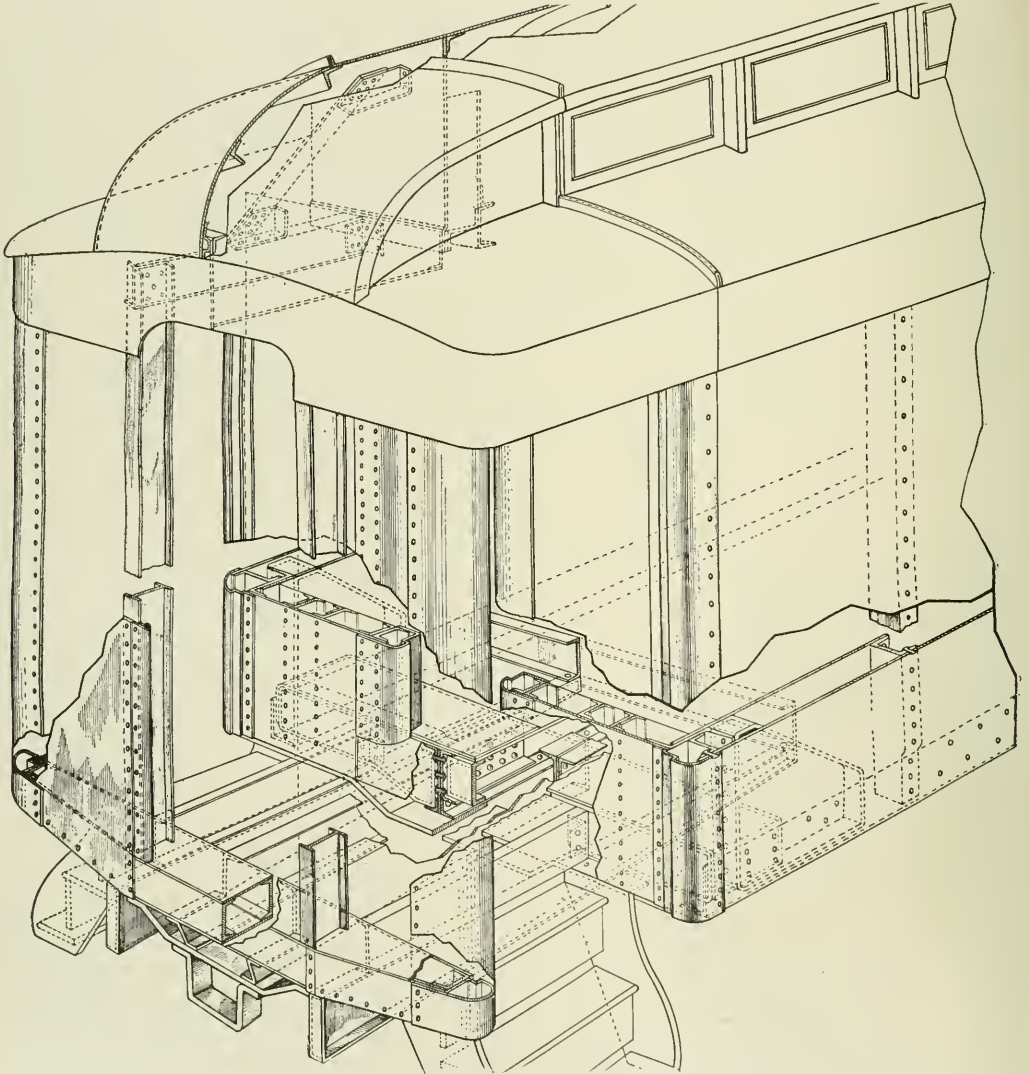

Collapsible Platform and Vestibule on an All-Steel Car.

vestibule, and are designed to act as an anti-climbing device. Heavy I-beams are used as vestibule center posts. These are securely riveted above and below and it is believed that in case of one car attempting to ride over the other, these beams would be of sufficient strength to cause the rivets connecting them to the sill extensions to shear off.

One of the illustrations shows a car constructed entirely of

platform, vestibule, hood and sill extensions are constructed as a unit, detachable and separate from the car body proper and can be applied, if necessary, after the car is built. It is presumed that in case of a collision these would be the only parts seriously damaged, and the car could therefore be repaired and replaced in service with a minimum of expense and delay. The object of the entire device is to protect the car body from damage.

NEW YORK CENTRAL LINES STEEL COACHES

Strong End Construction and Thorough Insulation Distinguish the New Passenger Equipment.

The new all-steel passenger train cars recently put in service on the New York Central Lines are 70 ft. in length over the end sills and 77 ft. 9 $\frac{3}{4}$ in. over the buffers. The coaches have a seating capacity for 84 passengers. These cars can be considered as representing the latest development of steel passenger equipment for heavy trunk line service along conservative lines. Two features of the design are particularly noticeable, viz.—the exceptionally complete arrangement of insulation and the substantial end construction, both of the car body and of the vestibule. There are very few places anywhere in the car where

the two designs. The posts terminate at the plate and the lower deck carlines are in separate pieces. The posts, which are all practically of the same section, are equally spaced throughout the length of the car except at the point where the saloons are installed. The interior finish is of steel except below the window sills and on the ceiling where agasote is employed. The steel is finished to imitate mahogany and the window sills and window sash are of Cuban mahogany. The passenger coaches are equipped with the axle light system and, including the batteries and battery boxes, have a total weight of 142,000

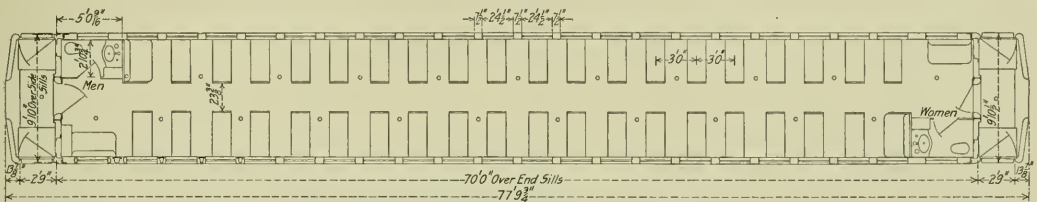

Plan of 70-Ft. Steel Coach; New York Central Lines.

there is a continuous metal contact between the exterior and interior, and careful provision has been made to prevent the entrance of cold air between the outside and inside sheathing or finish. A 2 $\frac{3}{4}$ in. air space has been provided under the floor which is sealed at the bottom by three-ply insulation secured to $\frac{1}{8}$ in. steel plates arranged in comparatively small removable sections.

Six inch I-beams, set in pockets in a cast steel underframe and securely held at the top, are employed for both the door posts and the vestibule diaphragm posts. In addition the 6 in.

lbs., giving a weight per sq. ft. of interior floor area of 22.9 lbs. and per seated passenger of 1,690 lbs. Cars of the design shown herewith have been built by the American Car & Foundry Company and the Barney & Smith Car Company, the design being prepared jointly by the engineers of the railway and of the builders.

The center sills connecting the two large steel castings at either end consist of two plate girders set 18 in. apart, each having a $\frac{3}{4}$ in. web plate and two 3 $\frac{1}{2}$ in. x 3 $\frac{1}{2}$ in. x $\frac{1}{2}$ in. angles at the bottom and one 3 $\frac{1}{2}$ in. x 3 $\frac{1}{2}$ in. x $\frac{1}{2}$ in. angle at



70-Ft. Steel Passenger Coach for the New York Central Lines.

Z-beams forming the corner posts are braced by a substantial cast steel knee resting in a machined pocket in the underframe. This construction is such as will evidently offer the most determined resistance to telescoping of the car body. An underframe somewhat similar to that employed by the Pullman Company for steel sleeping and parlor cars is used. It consists of a Commonwealth combination cast steel double body bolster, end sill and platform connected by fish belly type center sills and side sills of steel angles.

In other respects, however, there is little similarity between

the top. These girders are 31 in. in depth at the middle for a length of 22 ft. 8 $\frac{3}{4}$ in. They taper at each end for a distance of 12 ft. 10 $\frac{1}{8}$ in. to a depth of 13 in. A top cover plate, $\frac{1}{2}$ in. in thickness and 26 in. wide, is secured to both sills and overlaps for the full length of the splice at the steel castings. There is also a splice plate on the under side of each sill at this point which is $\frac{5}{8}$ in. in thickness by 7 $\frac{3}{4}$ in. wide and 3 ft. in length. All the angles on the center sills are continuous for the full length of the web plate with the exception of the inner angle on the lower edge which does not form part of the splice

6 ft. The outside floor stringer consists of an angle, pressed from $\frac{1}{4}$ in. plate, extending for the full length of the car and riveted to the side posts with four $\frac{1}{2}$ in. rivets at each post. The lower edge of this angle acts as a support for the false floor. Intermediate stringers of Z shape, pressed from $\frac{1}{8}$ in.

resting on the center sill cover plate and located midway between the floor supports.

The side sill, formed of a 6 in. x 4 in. x $\frac{3}{8}$ in. angle; side

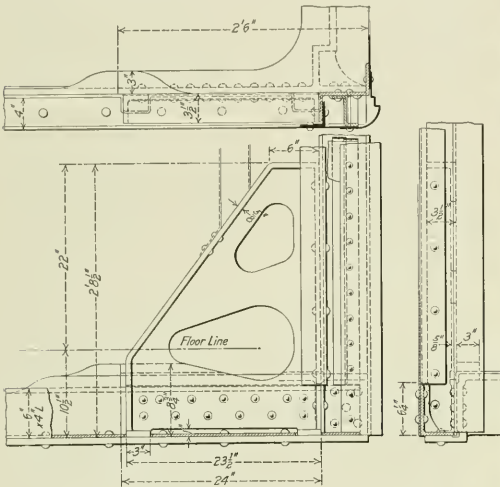

Cast Steel Knee Back of Each Corner Post at the Bottom.



Interior of 70-Ft. Steel Coach; New York Central Lines.

plate, extend for the entire length of the car. They are in five parts with proper shaped connection pieces at the cross bearers and bolsters and are riveted to the floor support with two $\frac{3}{8}$ in. rivets at each connection. A $\frac{1}{8}$ in. extension plate is riveted to each of these stringers and extends downward for

posts pressed in channel section, with flanges, from $\frac{1}{8}$ in. plate; a 5 in. 6.5 lb., channel, continuous for the full length of the car, forming the plate; and a $\frac{3}{8}$ in. x $4\frac{1}{2}$ in. belt rail form the principal members of the side framing. The posts are shaped

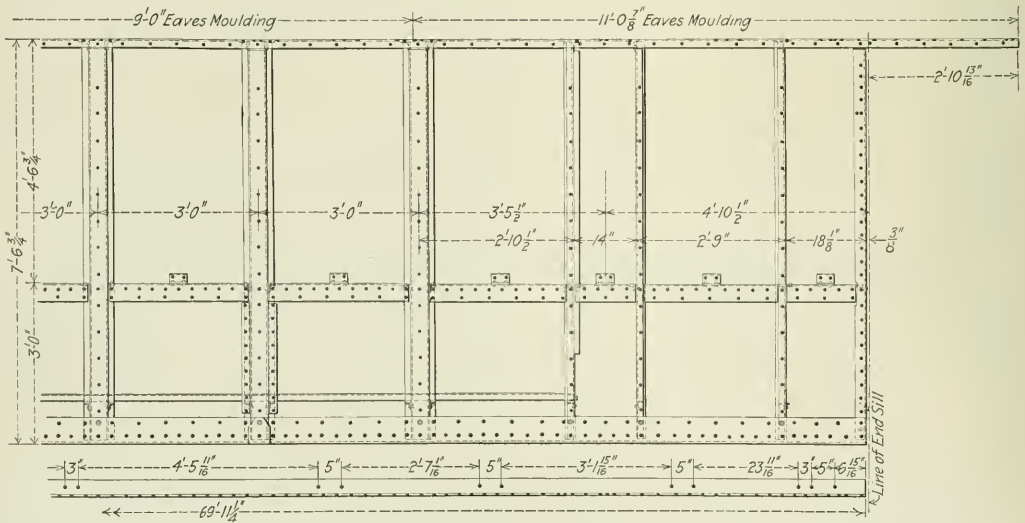

Elevation of Body Side Framing at End of Car; New York Central Lines Steel Coach.

securing the false floor. The middle floor stringers are also Z shape and of $\frac{1}{8}$ in. plate. At each seat pedestal a $3\frac{1}{2}$ in. x $2\frac{1}{2}$ in. x $\frac{1}{4}$ in. angle, 13 in. long, is riveted to the stringer which has an extra support in the shape of a pressed steel gusset

at the bottom to fit inside the leg of the angle and are cut away at the top to clear the flanges of the channel plate which is placed with its web horizontal and flanges extending downward. The posts have a $\frac{1}{16}$ in. cover plate riveted to the outwardly

side plate. It is continuous on both sides and ends of the car.

The vestibule diaphragm posts are also 6 in., 12½ lb. I-beams, set in pockets in the steel casting in the same manner as the door posts. They are supported at the top by a 5 in. channel extending straight back to the end frame and secured to the gusset which reinforces the end plate. It also abuts the flange of the end plate. There is also a similar channel secured to the opposite side of the post, which extends upward and outward to a connection at the junction of the deck end plate and side plate. The former is a 5 in. straight channel with the flanges cut away at the end and the web turned inward for riveting to the deck side plate. There is also a diagonal brace from the top of the door post at this same point and large gusset plates make the joint rigid and strong. Furthermore there is a diagonal brace from the top of the vestibule diaphragm post to the side plate near its junction with the corner post. The vestibule corner post is ¾ in. thick, pressed to the proper contour and secured to the buffer beam extensions at the bottom, and to the side plate and vestibule end plate at the top. The vestibule end plate is a 3½ in. x 3½ in. x ¼ in. angle formed to proper contour and is riveted to the vestibule diaphragm posts above their connection to the diagonal braces.

It will be seen that this vestibule construction is designed to offer great resistance to end shocks and that no provision has been necessary for carrying the weight of the platform or the vestibule from any of the roof members since the steel casting in the underframe is amply sufficient to carry this weight. The end framing of the body, however, is even more massive and should the vestibule collapse, it would be practically impossible for another car to enter the car body proper.

Patent leveled plate, ⅜ in. thick below the belt rail and 3/32 in. thick above, is used for the outside sheathing. The end sheathing part is also 3/32 in. thick of the same plate, and the vestibule has ⅜ in. sheathing. On the interior the finish is of steel except as noted above. It was furnished by Hale & Kilburn. The floor is of Flexolith, 1½ in. thick, laid on ⅝ in. galvanized Chanarch of No. 22 gage. The latter was furnished by the Acme Supply Company. It will be noted that the Chanarch is carried through to the side sheathing between the posts and that the flooring is also continued, a joint being made, however, at the floor cove molding on the inside of the post. This arrangement prevents the entrance of cold air in the space between the posts and back of the inside finish.

One of the most interesting features of the car is the arrangement of the insulation, and in the cross sections it will be seen that adjacent to the inside finish at all points there is a ½ in. sheet of Resisto, or H. W. Johns-Manville Company "Nycinsul" insulation, and on the inner face of the outer sheets there is a ¼ in. Resisto sheet. The latter is brought inward around the posts and other members, and joins either the inner insulation or the wooden fastening strip applied for securing the inside finish. This insulation is secured to the plates by fasteners spot welded in place. At no point is there a continuous metallic connection between the inside and outside of the car. All open spaces between the framing, where there might be a possibility of circulation of cold air, are carefully filled with wood blocks or otherwise.

The cars are mounted on the standard six-wheel trucks of the New York Central Lines, set at 54 ft. centers. They have an 11 ft. wheel base. Some of the specialties employed are as follows: Steel doors, Hale & Kilburn. The body end doors close against a piece of solid rubber ½ in. square, and are also fitted with metallic weather strips. Trap doors and window fixtures, Tuco and Edwards; vestibule curtain, Acme Supply Company; draft gear and buffer, Miner Draft Gear Company; couplers, Tower; brakes, Westinghouse PC equipment with 16 in. service and 16 in. emergency cylinders; heating system, Ward Equipment Company; lighting, Gould axle system; seats, Hale & Kilburn walk-over type; lock nuts, Columbia.

THE ELECTRO-PNEUMATIC BRAKE

At the January meeting of the New York Railroad Club, N. A. Campbell read a paper on the electro-pneumatic brake, stating that this type of brake is so arranged that under usual conditions the pneumatic apparatus is operated electrically, but if the electrical apparatus should become inoperative for any cause, that part of the equipment controlled by air pressure is not affected and the pneumatic operation will take place as usual.

There are several systems of operating air brakes electrically, some of which have been in successful operation for a number of years, principally on electric railroads operating multiple unit trains. In the system described magnet valves are employed to make local brake pipe reductions. It is believed that this system is the most applicable to steam railroad service, as it can be used in connection with the standard car and locomotive equipments now in use, and will not interfere with interchange. It is also applicable to multiple unit electric train service with substantially the same apparatus.

The standard automatic brake valve is used and the positions for electric operation are the same as those for pneumatic operation. Each of the various positions of the brake valve for controlling the air pressure throughout the air brake system has a corresponding position on the electric controller. The controller is connected to a series of wires passing throughout the length of the train.

There are three magnet valves on each car, viz.: the application, release and emergency magnet valves. They are attached to one bracket to which the pipe connections are also attached, so that a magnet valve can be removed without disconnecting any pipes. In the normal position the application and emergency magnet valves are closed and when energized, are opened. The normal position of the release magnet valve is open and it is closed when energized.

To make a service application of the brakes, the brake valve is placed in the service application position. In this position the application magnet valves are energized, which causes them to open and reduce the brake pipe pressure simultaneously on each car. The triple valves now operate in the usual manner, actuated by the differential in the auxiliary reservoir and brake pipe pressures, and permit auxiliary reservoir air to pass to the brake cylinders and apply the brakes. As the brake pipe reductions are made simultaneously on each car, and the action of the magnet valves is instantaneous, there is no interval between the application of the first and last brake. When a sufficient brake pipe reduction has been made, the brake valve should be returned to lap position. The application magnet valves are now de-energized and are closed by the air pressure, assisted by a spring, and the release magnet valves are energized. When the brake pipe reduction ceases, the triple valves move to lap position and prevent further flow of air from the auxiliary reservoirs to the brake cylinders, as though operated without the use of any electrical apparatus. The brakes can be applied with as many graduations as may be desired, and more uniformly than is possible without the use of the electrical apparatus, until full service braking pressure has been obtained.

As the application magnet valves reduce the brake pipe pressure at the same rate that the equalizing reservoir pressure is being reduced by the brake valve, the brake pipe reduction is made more rapidly than is possible with the automatic air brake, and the brakes are applied more promptly, resulting in a shorter service stop. For the same reason, the brakes are applied on a train of any length as rapidly as on a single car, also no electrical apparatus other than the generator and controller need be applied to the locomotive, because the brake pipe reduction made by the application magnet valves on the cars is sufficient to actuate the locomotive equipment.

As the equalizing reservoir of the brake valve is always charged, as when the brakes are operated pneumatically, and its pressure reduced as usual when the valve is in service position, should

the current be interrupted and the application magnet valves fail to reduce the brake pipe pressure, the brake pipe exhaust will at once open and the ordinary pneumatic application will be obtained. Should one or more application magnet valves in any part of the train become defective and the brake pipe pressure be reduced slower than that in the equalizing reservoir, the equalizing piston will be raised by the higher pressure in the brake pipe and promptly assist in making the proper rate of brake pipe reduction. As this operation is entirely automatic and insures at all times a positive action of the brakes either electrically or pneumatically, on all cars in the train, it will cause no confusion on the part of the operator and he need not know whether the electric current is available or not. When the application has been made as heavy as the circumstances require, the brake valve handle can be placed in holding position; when this is done the release magnet valves are energized and are closed. Air is now being admitted to the brake pipe from the main reservoir at the same rate as in running position. The triple valves will move to release and charging position and the auxiliary reservoirs will be recharged so that the maximum braking pressure will be quickly available for either a service or emergency application. The brake cylinder pressure will be retained until the brake valve handle is moved to running position, when the release magnet valves will be de-energized and will open, allowing the brake cylinder pressure to escape to the atmosphere.

If it is not desirable to allow all the brake cylinder pressure to escape and entirely release the brakes, the brake valve handle can be returned to holding position, when the release magnet valves will again be energized and closed. The brakes can be graduated off to any extent desired and the brake cylinder pressure on each car will be uniformly reduced, thus avoiding any shocks that would be produced by unequal reduction of brake cylinder pressure and braking power. When an emergency application is necessary the brake valve handle is placed in the emergency position. The emergency magnet valves will be energized and will open, causing an instantaneous and heavy brake pipe reduction on each car sufficient to cause all triple valves to move to the emergency position. The maximum brake cylinder pressure is obtained on all cars in approximately the same time.

MIRROR FOR INSPECTING ARCH BARS

Defects are as liable to develop on the inside of the arch bars of freight car and tender trucks as on the outside, and it is practically impossible to discover them by the ordinary

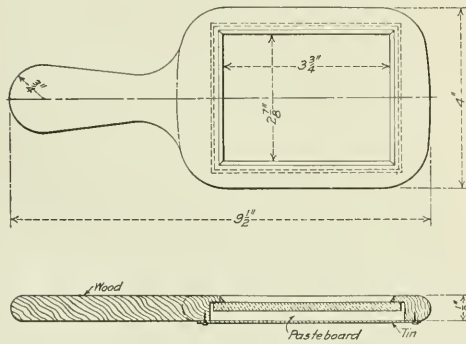

Mirror Used on the Louisville & Nashville for Inspecting Arch Bars.

method of inspection. On the Louisville & Nashville the car inspectors have been provided with a small hand mirror of a shape and size shown in the illustration; by holding it on the

inside of the bar any crack or other defect can be readily discovered.

Astonishing results have followed the introduction of these mirrors. They were put in use at one or two terminals on July 1, 1912, and all other inspection points on September 24. From July 1 to November 30, 1912, a total of 1,488 defective arch bars were detected in this manner. It is reasonable to assume that most, if not all, of these defects would have been overlooked without the aid of the mirror. Thirty-four broken bars were discovered in this way in two months at one terminal; forty-two at another in one month, and seventy-six at another in ten days.

TRUCK EQUALIZER DESIGN

BY L. V. CURRAN

In designing equalizers, forces other than those caused by the car weight alone should be considered, although it is believed that this is not commonly done. The part that the air brakes play in the equalizer load distribution is by no means negligible, and causes a very unequal distribution of the load, the magnitude of which depends on several quantities. The most important of these are the train velocity, the braking force, the angle of the shoe hanger, the location of the hanger connection to the frame, the equalizer proportions, and the car weight. While a large factor of safety often prevents the consequences of faulty design, a true conception of all conditions affecting the load capacity of the equalizer should be sought for.

Referring to Fig. 1, a brake load delivered to the wheel horizontally through the shoe will exert a component force through

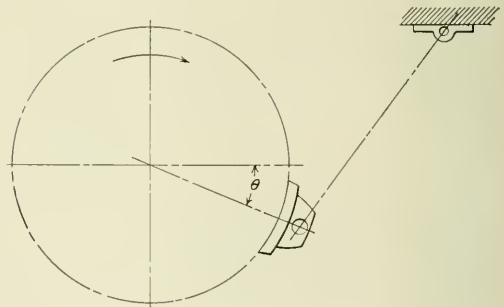

Fig. 1—Diagram of Brake Shoe and Wheel.

the center equal to $L \cos. \theta$, in which L is the brake load on the wheels.

If f is the coefficient of friction at the train velocity investigated, the tangential wheel load at the brake shoe will be $= f L \cos. \theta$.

The vertical component of this transmitted through the brake hanger to the truck frame, and finally to the equalizers, will therefore be equal to: $f L \cos.^2 \theta = P$.

Take first the case of a four-wheel truck, and assume the usual braking load, 80 per cent. of the light weight of the car and 1.7 times this amount for an emergency application of the brakes. Also assume .25 for f at 60 miles an hour. For an emergency application of the brakes:

$$P = .0425 w \cos.^2 \theta$$

in which w is the light weight of the car.

From the direction of wheel rotation it is evident that the force P will act down with the car weight on one equalizer spring cap, and up against the car weight at the other spring cap. If the brake hanger connections to the frame are practically the same distance from the center as the spring caps, as is usually the case

with inside hung brakes, the loads on the two springs will be: $\frac{W'}{8} + P$ and $\frac{W'}{8} - P$ respectively, W' being the loaded weight of the car less the weights of the truck parts below the coil springs.

If the brake hanger connections are some distance from the spring cap horizontally on the length of the truck frame the effect of this lever arm will have to be considered. By taking the sum of the moments around each spring cap separately the correct spring load will be easily obtained.

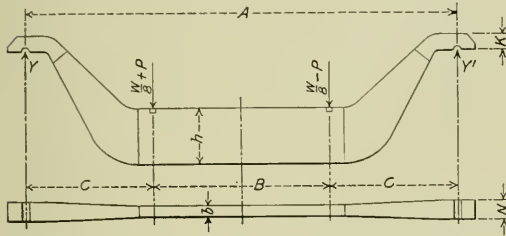

Fig. 2—Equalizer for Four-Wheel Truck.

Reference to Fig. 2 will show that the greater reaction or pressure is at Y' and that it has the following value:

$$Y = \left(\frac{W'}{8} + P\right) \left(\frac{B+C}{A}\right) + \left(\frac{W'}{8} - P\right) \left(\frac{C}{A}\right)$$

$$= \frac{B W' + 8 B P + 2 C W'}{8 A} = \frac{A W' + 8 B P}{8 A}$$

The maximum bending moment, M , is then

$$M = Y C = \frac{C (A W' + 8 B P)}{8 A}$$

Assuming that b is determined and that a fibre stress of 16,000 pounds per square inch is permitted for safe loading, the required depth of the equalizer, h , is obtained as follows:

$$\frac{16,000 \times I}{e} = \frac{C (A W' + 8 B P)}{8 A}$$

$$I = \frac{1}{12} b h^3 \text{ and } e = \frac{h}{2}$$

Therefore $h = \sqrt[3]{\frac{C (A W' + 8 B P)}{21,336 A b}}$

In the case of six-wheel trucks, there are twelve brake shoes instead of eight, and P becomes:

$$\frac{8}{12} \times .0425 w \cos^2 \theta = .028 w \cos^2 \theta$$

The brake hangers are usually hung in the proportions shown



Fig. 3—Equalizer Spacing on a Six-Wheel Truck.

in Fig. 3, and when the truck travels in the direction indicated the spring loads on one equalizer are: $\frac{W'}{8} - 1\frac{3}{4} P$, and on the

other $\frac{W'}{8} + 2\frac{3}{4} P$. The latter will govern the design.

The reactions at the ends of the equalizer when loaded, as shown in Fig. 4, are:

$$Y = \frac{2}{3} \left(\frac{W'}{8} + \frac{11}{4} P\right) \text{ and } Y' = \frac{1}{3} \left(\frac{W'}{8} + \frac{11}{4} P\right)$$

The maximum bending moment at the spring seat is:

$$M = \frac{Y A}{3} = \frac{A (W' + 22 P)}{36}$$

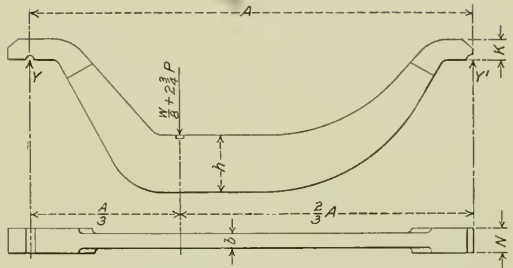

Fig. 4—Equalizer for a Six-Wheel Truck.

Then the required depth obtained as above and with the same fibre stress becomes

$$h = \sqrt[3]{\frac{A (W' + 22 P)}{96,000 b}}$$

For use in stress investigation the following transpositions are useful:

Maximum fibre stress = $\frac{C (A W' + 8 B P)}{1,33 h^2 A b}$ for four wheel trucks
 and = $\frac{A (W' + 22 P)}{6 h^2 b}$ for six wheel trucks.

SPECIFICATIONS FOR POSTAL CAR LIGHTING

The post office department has issued revised specifications, dated December 28, 1912, for full postal cars, including the requirements for lighting. The lighting is to be done by either gas or electricity, wherever feasible. Mantles are to be used on gas lights where practicable, and fixtures, wiring, etc., are to conform to the railroad company's standards. Electrically lighted cars must have storage battery capacity sufficient to furnish for 12 hours, without any charging during that period, the intensity of illumination specified; while cars lighted by gas must have storage capacity sufficient for 36 hours. The details of the lighting specifications are as follows:

Location of Light Units.—The light units for illuminating the bag rack and storage portions of the car shall be located on the center line of the postal apartment. Direct lighting units shall be located at such uniform height that the shadow of the paper boxes is not cast on any bag rack label, nor higher than approximately 3 in. above the back rod of rack. In no case shall any light unit (except oil lamps, the lowest point of which may be 6 ft. 9 in. from the floor) be mounted at a height of less than 7 ft., measured from the floor to the lowest point of the light unit (spacing between adjacent units in the bag rack portion of the car shall not exceed 8 ft. 6 in. in case of any direct system of lighting, nor 14 ft. in case of any indirect system).

Light units for illumination of the letter cases shall be mounted at the same height from the floor as the units in the body of the car, and as far from the front of the face of the letter case as possible, without the body of the distributor throwing any shadow on his work. In standard construction, where the letter case table is 17 in. wide, the above distance is 20 in. Where the car construction does not permit the above distance to be employed, a lesser distance, but not less than 16 in. may be employed. Separation between adjacent letter case units shall be such as to provide an illumination intensity at all points within the requirements hereinafter specified.

If an indirect lighting system be employed, the provisions of

the above paragraph will be waived. In such case, the only requirements imposed for location of units of letter cases are those involved in providing for sufficient vertical and horizontal illumination intensities to meet the provisions of these specifications as hereinafter stated, all units in the car burning. For the purpose of these specifications an indirect system is here defined as any system in which at least 85 per cent. of the horizontal illumination on the 46-in. plane of utilization is received, either directly or indirectly, by reflection of the light from the deck of the car.

In the case of incandescent electric or mantle gas lamps, the design of light unit, except letter case units, shall be such that no portion of the bare lamp filament or the bare mantle is visible to the eye when the unit is observed at an angle of 70 deg. or greater from the nadir. (In general, light units are preferred which emit no light or only a small amount of light between the angles of 50 deg. and 100 deg. from the nadir.) The control of the lights in the postal apartment shall be independent of any other lights in the car, and the letter case units shall be controlled independently of any other light units in the postal apartment.

Initial Illumination Values.—All horizontal illumination values shall be taken on a plane 46 in. above the floor line. Vertical illumination values shall be taken on the vertical plane on the face of letter case as specified below. New lighting installations shall be such as to give initial illumination values in foot candles within the following limits:

Location.	Minimum.	Maximum.
Bag-rack portion:		
Center of car, horizontal.....	4.70	10.00
Mouth of bags, illumination measured 18 in. from side of car, horizontal.....	2.50	10.00
Letter cases:		
Over table, horizontal.....	4.70	16.00
Face of case, vertical.....	2.08	16.00
Storage portion, not behind obstruction, horizontal, measured not less than 18 in. from side or end of car.....	2.50	10.00

Illumination requirements at letter cases as above specified shall be entirely fulfilled by letter case units, other units in the car not burning; but letter case units may be considered as contributing to the specified illumination values for the body of the car.

If globes or reflectors of opal glass, rough crystal glass, prismatic glass, or aluminized metal, and those giving similar results (excluding heavy density opal with glazed reflecting surface, mirror glass, porcelain enameled metal and those giving similar results) be employed, the minimum values specified in the above table may be reduced 20 per cent. and the maximum values increased 20 per cent.

Above illumination values are based on an allowance of 40 per cent. for depreciation in service. Less efficient maintenance must be compensated for by increased initial installation.

If an indirect lighting system be employed, the minimum and maximum values in the above table may be respectively decreased and increased 40 per cent. in the bag rack and storage portions of the car, and 25 per cent. at the letter case locations specified in the above table.

Service Illumination Values.—While the car is in active service the lighting installation shall be maintained at all times to give illumination values (in foot-candles) not less than the following minimum values:

Location.	Minimum.
Bag-rack portion:	
Center of car, horizontal.....	2.80
Mouth of bags, illumination measured 18 in. from side of car, horizontal.....	1.50
Letter cases:	
Over table, horizontal.....	2.80
Face of case, vertical.....	1.25
Storage portion, not behind obstructions, horizontal, measured not less than 18 in. from sides or ends of car.....	1.50

Illumination requirements at letter cases as above specified shall be entirely fulfilled by letter case units, other units in the car not burning; but letter case units may be considered

as contributing to the specified illumination values for the body of the car.

If globes or reflectors of opal glass, rough crystal glass, prismatic glass, aluminized metal, and those giving similar results (excluding heavy density opal with glazed reflecting surface, mirrored glass, porcelain enameled metal, and those giving similar results) be employed, the minimum values specified in the above table may be reduced 20 per cent.

If an indirect lighting system be employed the minimum values in the above table may be decreased 40 per cent. in the bag rack and storage portions of the car, and 25 per cent. at the letter case locations specified in the above table.

A light failure is defined as the condition where for a period exceeding 30 minutes the primary lighting system fails to give sufficient illumination to permit distribution of mail matter to be continued. It will be considered that whenever the lamp voltage falls below 80 per cent. of the normal operating lamp voltage such a condition of light failure has been reached.

A car movement is defined as the use of a postal car by a crew of postal clerks over the length of their run in one direction. Where a car covers more than the run of one crew, each separate run shall be considered a car movement.

The percentage of failure of the lighting system is defined as the ratio of the total number of failures to the total number of car movements of each primary system of lighting (gas and electrically lighted cars to be considered separately) on each railway system. The determination of percentage of failure shall be based on the operating performance of each car for the preceding twelve months period. Only such failures as are promptly reported by the railway mail service to the operating railroad shall be considered in computing the percentage of failure.

Emergency Lighting.—If the percentage of failure of the primary system of electric or gas lighting does not exceed 1 per cent., candle lamps will be accepted as a suitable emergency light. If the percentage of failure of the primary system of gas or electric lighting exceeds 1 per cent. and is not greater than 4 per cent., an emergency system of suitable oil lamps, gas or electric lights, maintained by independent storage capacity, may be required. Such emergency system must provide illumination values not less than 50 per cent. of the minimum operating illumination values specified above for the primary system, with the exception of letter cases and center line of car through bag rack portion where the illumination shall not be less than 60 per cent. If the percentage of failure of the primary system of electric or gas lighting exceeds 4 per cent., a new installation or a second complete primary system of lighting will be required on cars so failing.

MOTOR SLEEPING CARS FOR AUSTRALIA.—It is reported that two motor cars will be used on the Transcontinental Line in Australia so arranged that the back of the front seat and the cushions in each car may be used for sleeping accommodation.

COACH CLEANING ON THE PENNSYLVANIA.—In the Pennsylvania's yard at Sunnyside, Long Island, over eleven thousand cars are cleaned every month, and only the cars on long distance trains, and dining cars are handled here. Before the completion of the tunnel system connecting Long Island with Manhattan and New Jersey, all trains went to the yard in Jersey City, where over 18,000 cars a month were cleaned. The problem of exterior cleaning is being studied very carefully by the Pennsylvania. Experiments are being made with different solutions for this work, the principal ingredients of all being oil and soap. Every solution is tried out for a period of three years and each time a car is cleaned it is recorded. When the car goes to the shops at Altoona to be overhauled data is compiled from these records to be used in determining which solution is the most effective and economical.

NEW DEVICES

HORIZONTAL DRILLING AND BORING MACHINE

A new type of horizontal drilling and boring machine has been developed by the Pawling & Harnischfeger Company, Milwaukee, Wis., that has found extensive application in railway shops. It is designated as No. 8, and is a development of the No. 3 type. The machine consists of a fixed vertical head on which the tool head may be raised or lowered over a range of 6 ft. 10 in., and a table mounted on four small wheels running on short rails imbedded in concrete. The machine will operate over a surface area of 60 sq. ft., and will drill and tap holes up to 3 in. in diameter. It will also operate boring bars over the same area.

Special attention has been given to a wide range of spindle speeds and for this purpose a $7\frac{1}{2}$ h. p. variable speed motor of 750 to 1,700 r. p. m. is provided with four mechanical speed changes, which, with 20 speed changes in the controller, gives a total of 80 different speeds graduated from 10 r. p. m. to 475 r. p. m. There are eight feeds for each spindle speed ranging from 0.008 in. to 0.148 in. per revolution of the spindle. The diameter of the spindle is $3\frac{1}{4}$ in., it is provided with a No. 6 Morse taper and has a range of horizontal feed of 30 in.

The motor is located on top of the column and drives a vertical shaft through a pair of bevel gears. From this vertical shaft the motion is transmitted to a horizontal shaft upon which the reversing clutch is located. From this point the motion is transmitted to the first speed clutch, which is of the same design as the reversing clutch, and thence to the second speed change which is provided with a simple jaw clutch. The feed is taken from the spindle through four feed change gears and a pair of

carbon steel, horizontal thrust being taken up by a ball bearing. The carriage weighs 3,500 lbs., and may be moved up and down either by hand or by power. It is balanced by a counterweight, sliding on the back of the column, which also weighs 3,500 lbs.

The controller is attached to the top of the column and is

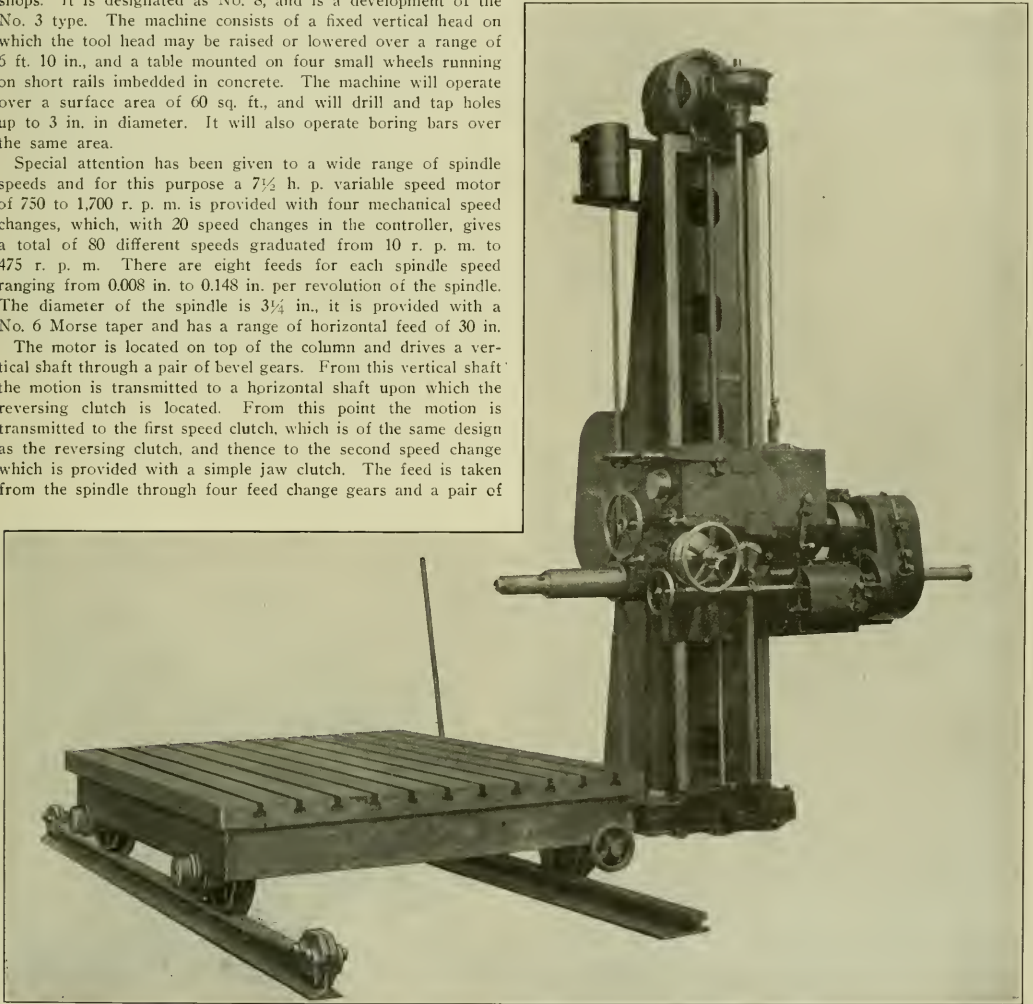

Horizontal Drilling and Boring Machine for Heavy Work.

back gears. The spindle can also be fed by hand. All the friction clutches and high speed gears are enclosed in an oil and dust tight casing, and are lubricated by the splash oil system. All the gears are cut from cast steel blanks and the pinions are of high carbon steel. The spindle also is of high

provided with a vertical shaft extending down to the carriage and a hand wheel traveling with the carriage. All levers and hand wheels are located so that the operator may reach them without leaving his work. Upon completion of a tapping operation, the operator may reverse the spindle, throw in the high speed

gear by means of the friction clutch, and thus withdraw the tap. The table is 8 ft. long, 6 ft. wide, 18¾ in. high, and weighs 8,200 lbs. It is moved on the rails by a lever engaging in a notched wheel. After locating the work it is securely clamped to the rails. The following are tests with 3 in. and 1 in. drills:

	Medium Steel—		
	Cast Iron, .15 to .20 per cent. carbon.	3 in.	1 in.
Size of drill.....	3 in.	3 in.	1 in.
Make of drill.....	Celfor	Celfor
Revolutions per minute.....	124	88	290
Peripheral speed (in feet)....	98	69	75.8
Feed per revolution of spindle..	2.23	1.56	3.48
Time to drill hole 4 in. deep... 1 min. 45 sec.	0.018	0.018	0.012
Total amperes.....	40	44 to 56	28
Amperes to run machine.....	5	5	5
Net amperes to drill.....	35	39 to 51	23
Drill lubrication.....	None	None	None

The No. 3 type of this machine has been in use in the Milwaukee shops of the Chicago, Milwaukee & St. Paul for seven years, and the parts noted below are drilled or bored on it. Cylinders are drilled or tapped, the holes being faced, where necessary. The steam pipe ring joints and relief valve ring joint are also faced. The hole in the spring lug on the reverse shaft is drilled easily and quickly, the shaft being clamped on the table with V blocks; the time required to do this job is about one-half that required on a vertical drill.

Steam chests for slide valve locomotives have the stuffing box and relief valve holes bored and faced; also the stud holes for glands are drilled. The steam chest is clamped on the table and the only movement necessary is to move the table to bring the holes in line with the bar. This chest formerly was bored with a horizontal boring bar and was then taken to a drill press to have the stud holes drilled. It has also been bored on a vertical boring mill, but requires an angle plate to bolt the chest to, all of which is eliminated on this machine.

It is necessary when a driver wheel spoke is cracked to drill it before it can be thernited. The wheel is taken to this machine without removing the axle, and the holes are drilled quickly and easily. Formerly it was necessary to drill the holes with an air motor, which required about three times the time it now takes. Steam pipes are drilled and the joints faced, the pipes being clamped on the table. When this job is done on a vertical drill a pit is required and it is a difficult job to clamp the pipes and level them up. Tee heads and collector castings for superheaters are easily drilled, as they will lie flat on the table where the work is directly in front of the operator.

Air pump brackets and link supports are drilled, it being a simple job to clamp such work on the table of the machine. When done on a vertical drill it is difficult to set up these castings. Cast steel bumper beams are also drilled quicker and with less handling on this machine than on vertical drills.

The main features of this drill that make it specially adapted to locomotive work are the horizontal drilling arrangement, which allows of the work being placed in a vertical position directly in front of the operator, and the movable table.

INDIAN RAILWAY POLICY.—The present policy of improving existing lines prior to making new extensions is justified by past experience. Opening a settled and thickly populated country, such as India by railways, is a very different enterprise to opening new countries. In the latter, population and cultivation follow the railway, and traffic grows slowly with the development of the country, so that the resources of the line are not suddenly taxed, but grow gradually with the traffic requirements. It is different in India, where the country pierced is often rich and railway facilities are taken advantage of fully from the opening of the line. Much of the complaints about insufficient arrangements for traffic are due to this feature. The call on the new lines is so great that the older lines even become congested with the rapidly increased traffic. In new countries this would not happen; growth of traffic would be more gradual.

SHAPER FOR DRIVING BOXES

A powerful machine designed principally for rapid work in connection with heavy cuts on the crown brass fit of steel driving boxes is shown in the illustrations. It is a push stroke shaper having a circular feed and is designed for cutting to a diameter of 15 in. with a 15 in. stroke. The boxes are clamped to the face of a substantial angle plate on the front of the machine,

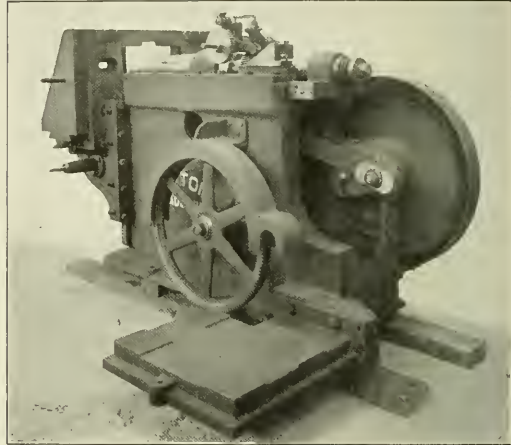

View Showing Circular Feeding Mechanism.

which is provided with adjustable screw stops on either side for steadying. The angle plate in connection with the piece below has adjustments in both directions and the box can be quickly centered on the cutter bar. The machine is driven by a 10 h. p. motor which carries a pinion that engages a large driving spur gear which in turn transmits the motion to a large plate gear which operates the ram through a Whitworth drive, giving a

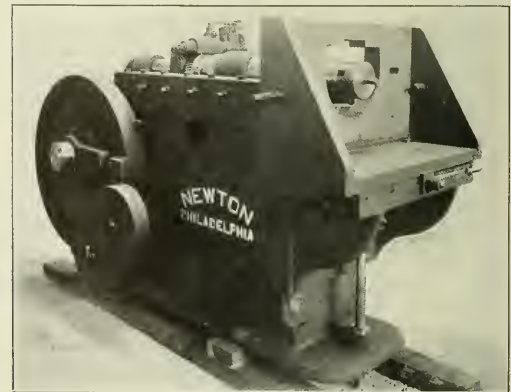

Heavy Duty Shaper for Driving Boxes.

quick return stroke. The machine has a positive 15 in. stroke with clearance to permit the feeding mechanism to operate. The cutter bar is a solid forging having double tapered bearings in the front of the ram and is provided with a spring tool relief at the rear. The circular feeding mechanism is simple and operates through the medium of a ratchet wheel, the amount of

the movement being controlled by the location of an adjustable incline which the end of the bell crank, carrying the dog, strikes at the completion of the return stroke. This shaper is of exceptionally heavy construction throughout and is simple in its arrangement and operation. It is designed and built by the Newton Machine Tool Works of Philadelphia, Pa.

A NEW DESIGN OF CAR COUPLER

The principal feature of the Stark coupler is the plunger which is shown in the sectional view of the illustration. This plunger slides in a socket which is cast in the coupler shank, and is cushioned by a spring at the bottom. A dowell in a slot at the side of the coupler shank prevents the plunger from moving out too far. In coupling, the knuckle of the opposing coupler forces this plunger against the spring, slides by it and engages with the other knuckle. The plunger is then forced out by the action of the spring and prevents the knuckle disengaging until released

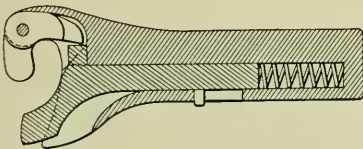
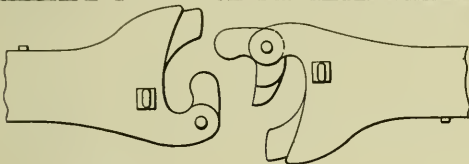

New Design of Automatic Car Coupler.

by the movement of the locking pin. The knuckle locking pin has a corrugated surface on the side next the plunger, which has corresponding corrugations at this point. In pulling, the tongue of the knuckle forces the locking pin against the plunger and the corrugations prevent the latter from moving and thus allowing the couplers to disengage.

It is claimed for this coupler that it is automatic under any coupling conditions, with knuckles either open or closed and on either straight or curved track. It is patented by C. H. Stark, Strasburg, Virginia.

AUTOMATIC CYLINDER COCK

Cylinder cocks require frequent attention to keep them tight and in operating order. The failure or inability of the engine-man to open the cocks before starting has been the cause of many broken cylinders and cylinder heads. Even more serious are the possibilities of the unexpected starting of a locomotive having a leaky or but partially closed throttle, which, unless the cylinder cocks are left open, is almost sure to occur.

To correct these troubles so far as it is possible to do so by design and construction, the Watertown Specialty Company, Watertown, N. Y., has developed an automatic cylinder cock for locomotives which operates in a manner similar to certain designs of gage glass fittings, and employs a bronze ball which is held against its seat by the pressure of the steam inside the cylinder, but falls to the bottom of a cavity and opens a passage to the atmosphere when the pressure is released. This type of cock opens as soon as the throttle is closed and remains open until steam is again admitted to the cylinder, and will allow no collection of water in the cylinder previous to the admission of steam. It is remarkably simple and should require the minimum

attention to maintain in operating condition. Arrangements are made for unseating the valve when there is pressure in the cylinders through the medium of the usual gear. The arrangement of the plunger for forcing the ball back is clearly shown in the illustration.

This valve has a gray iron body which fits close to the cylinder and gives an increased clearance as compared with the usual design. The valve seat is bushed with a bronze bearing and the

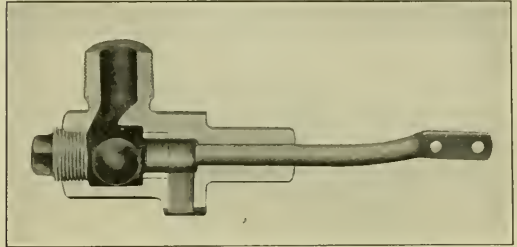

Watertown Automatic Cylinder Cock.

ball is also of bronze accurately ground to shape. The screw plug at the end of the ball chamber allows the valve to be inspected or cleaned. It is said that cocks taken from switch engines that have been in use for three years show practically no wear on the ball or its seat. This cylinder cock is distributed by the Diamond Specialty Company, Harrison building, Philadelphia, Pa.

PRIES OUTSIDE METAL CAR ROOF

The qualities most desired in a car roof are that it should be leakage proof, durable, simple in construction, cheap to maintain and that it will not add excessively to the weight of the car. These features have been considered in the Pries corrugated steel

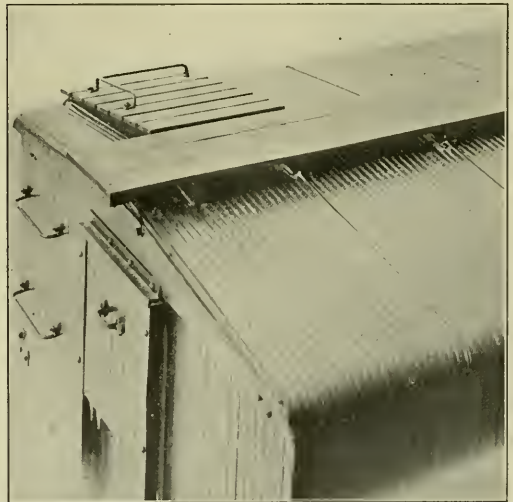

Pries Corrugated Roof for Freight Cars.

freight car roof, illustrated herewith, which is manufactured and sold by the Union Railway Equipment Company, McCormick building, Chicago. The roof is composed of three parts, viz., the sheets, tie rods and malleable iron running board saddles. The sheets, of No. 24 gage corrugated, galvanized steel, 30 in.

wide, are continuous over the full width of the car and are laid over a wooden roofing. They are lapped two and one-half corrugations in application and are held in position by 1/2-in. tie rods which are secured to the side plate at one end and to the metal running board saddle at the other. The rods follow the groove at each lap of the sheets and hold them securely, making the joint water tight. There are no perforations of any sort in the sheets except at the edges of the end sheets, which are tacked to the end plates for a finish. The sheets are manufactured with a steel roll to prevent any fracture in the metal and are then galvanized, being supplied to the railroad with the radius

be easily renewed by releasing the tie rods over that particular sheet, as there is sufficient space underneath the running board to slide the sheets through.

IMPROVED ROD BRASS

BY J. E. OSMER,
Master Mechanic, Chicago & North Western, Boone, Ia.

Several improvements have been made in the rod brass which was illustrated and described on page 26 of the January, 1912,

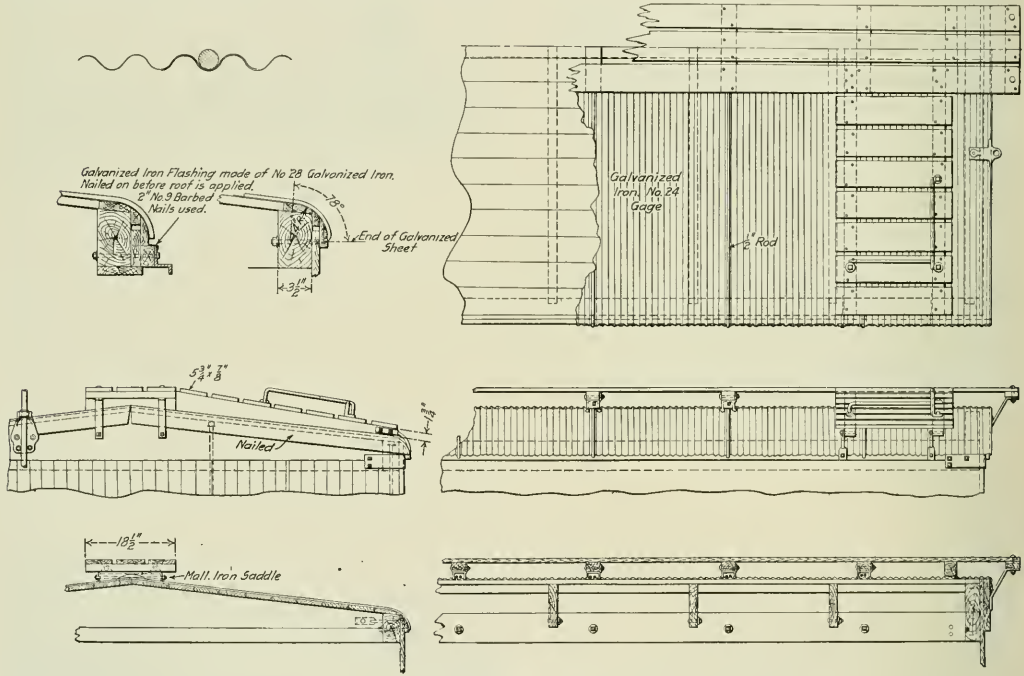

Application of Pries Corrugated Freight Car Roof.

at the eaves, and formed at the peak of the roof, as illustrated, ready for application.

The desired flexibility is obtained by the manner of lapping the sheets and by the corrugations. This simple construction eliminates the necessity of a multiplicity of small parts, such as caps or clips, which provide pockets for rust. All the sheets are made to a uniform standard width of 30 in. and are suitable for any length of car, as the end sheets may be lapped over the adjacent sheets a sufficient amount to overcome any variation without cutting the sheets. This roof is also claimed to be well adapted to use on old cars by trimming the roof boards flush with the side plates, applying a bevel edged fascia, removing the old running board and laying the metal sheets over the old roof, securing them with the rods as shown in the drawing.

The running board is applied to wooden blocks with screws, the blocks being bolted to the metal saddles, which in turn are held firmly in position by the tie rods. The transverse running boards on the ends of the car are fastened with screws to wooden stringers, which are fastened to the running board saddles with bolts and at the eaves of the car with curved anchor bolts secured by 5/8-in. carriage bolts through the side plate below the edge of the sheets. The simple construction of the roof makes an easy application, requiring no expert mechanics, and any sheet may

issue of the *American Engineer*, and it is now so arranged that the brass may be reduced, the rod lengthened or shortened, or

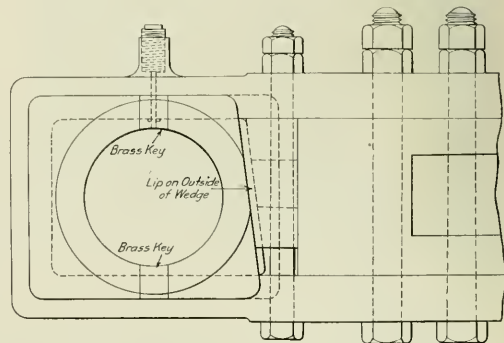

Arrangement of Improved Main Rod Brass.

the wedge key lined down without removing any of the rod bolts. As shown in the illustration, this has been accomplished

by the elimination of the flange at the front of the brass on the outside of the rod. In this way the wedge can be adjusted or removed, the liners can be inserted, etc., without removing the brass. This, taken in connection with the use of a brass key at the top and bottom between the two halves of the brass, which on removal of the nut and washer and return crank, if the Walschaert valve gear is used, can be taken out and planed off sufficient to permit the brass to be closed the desired amount, allows all usual adjustments to be made without removing the rod bolts. This construction has demonstrated its usefulness in service and has resulted in a decided reduction in the time and cost of maintaining main rod brasses.

PNEUMATIC DRILL PRESS CLAMPS

The illustration shows an application of the Thomson pneumatic clamps to a 3-spindle Foote-Burt drilling machine. The capacity of the machine has been greatly increased by their use. The application of the work is greatly facilitated and it is thus possible for the workman to keep the three spindles working most of the time. They clamp the work under the drill instantly, and are of simple construction, consisting of a small cylinder, located at the rear of the machine, which is connected to the shop air line. When the air is admitted by the valves shown

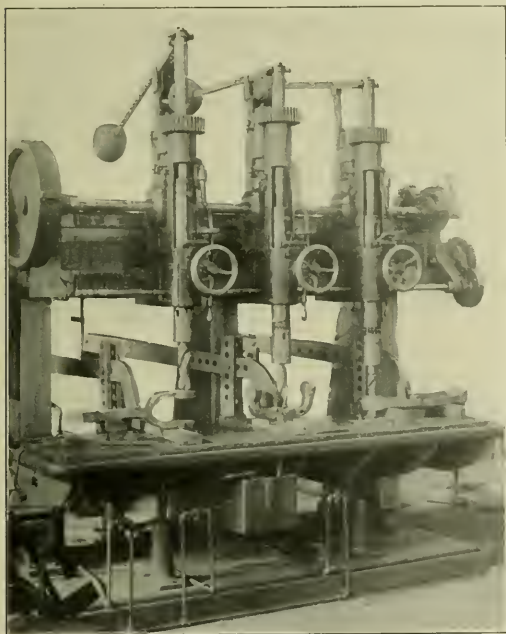

Thomson Pneumatic Clamps Applied to a 3-Spindle Foote-Burt Drill.

in front of the machine, which are placed in a convenient position for the operator, it forces a plunger against the clamping lever. This lever fulcrums in a yoke, easily fastened to any part of the table by T-bolts, and may be applied in almost any position.

The clamps are also adapted to other makes of drill press and are in use on all such machines in the Beech Grove (Ind.) shops of the Cleveland, Cincinnati, Chicago & St. Louis, where the cost of drilling has been materially reduced by their use. They are made by the Thomson Pneumatic Tool Company, Indianapolis, Indiana.

DEVICE FOR SECURING HAND HOLDS

BY NICHOLAS C. THALHEIMER

To meet the requirements of the Interstate Commerce Commission regarding safety appliances, without incurring any great expense, a device for securing hand holds and ladder rounds has been adopted on the Baltimore & Ohio for refrigerator cars and steel passenger train cars.

The device as applied to freight equipment cars consists of

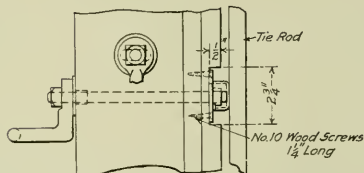
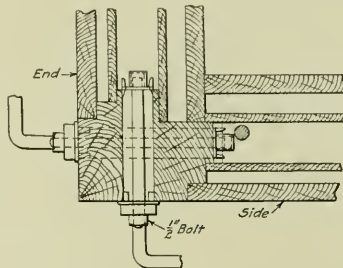

A Method of Securing Hand Holds to Wooden Cars.

a malleable iron pocket secured to the back of a timber at the end of an elongated hole which passes through the timber. This pocket is so designed as to seat a T-head bolt when it is passed through the elongated hole and given a quarter turn. A malleable iron washer is applied at the outer end of the hole in such a way as to keep the bolt from moving out of center.

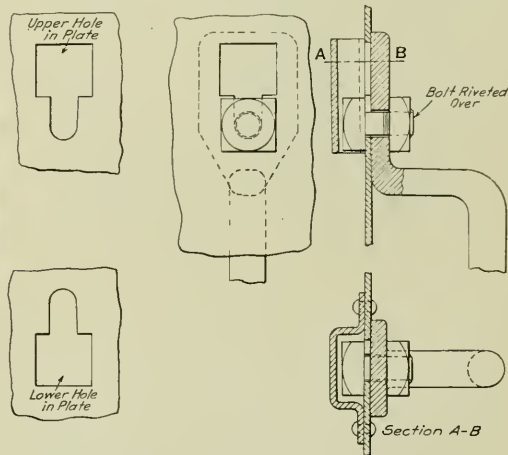

Securing Device for Hand Holds on Steel Cars.

The ladder round or hand hold is then applied to the bolt and held in place by nuts. Its use on refrigerator cars avoids the necessity of removing the ice-boxes when applying ladders.

In the application of hand holes to steel passenger equipment

cars, a pressed steel plate or pocket is secured by rivets to the back of the corner post or side sheet, covering a slotted hole which is so shaped as to permit the entrance of a square headed bolt. This bolt when passed through the slotted hole, drops down a short distance and seats itself. The pocket prevents the bolt from turning when the nut is applied, and also avoids piercing the inside lining of the car. When applying a hand hold with this device, one of the holes for the bolt head is inverted, thus avoiding any possible chance of the hand hold disengaging. This device is patented.

COMPOUND LOCOMOTIVE AIR PUMP

Patents on a new design of locomotive air pump have been granted to F. Tuma, master mechanic of the Erie at East Buffalo, N. Y. This design has been prepared for the purpose of reducing the liability of failure and decreasing the steam consumption. The use of hollow pistons and tappet rods has been dispensed with and the design is such that if one side of the pump becomes disabled the other will continue to operate. The inventor claims that the pump will give 14.03 per cent. thermal efficiency and 95.06 machine efficiency with 200 lbs. steam pres-

sure, and correspondingly lower efficiencies with the lower pressures. All four pistons move in the same direction at the same time. The steam valve is connected at its upper end to a V shaped casting, which in turn is secured to two rods passing through stuffing boxes into the different cylinders. These rods are of such a length that they will be struck by the pistons when near the end of their strokes and the valve will be reversed. It will be seen that if either half of the pump is inoperative the other pistons will continue to move the valve in the proper manner. The steam chest with its valve is located at the centre and between the two steam cylinders which are on the lower end of the pump. The arrangement of the passages and the method of operation will be clear by an inspection of the illustration. The

two steam cylinders operate on the normal, full stroke compound principle, the steam admission being on the left hand side and the exhaust at the right of the valve chamber. At the air end of the pump provision is made for an atmospheric intake to both cylinders, and the only moving parts, outside of the pistons themselves, are a series of check valves which are entirely automatic in their operation and are held on their seats by gravity when there is no pressure in the system. The arrangement of the passages and check valves is such that the discharge from the low pressure cylinder enters the space at the opposite end of the high pressure cylinder, and when the pressure is low it also partially discharges to the main reservoir. When the reservoir pressure becomes greater than the pressure between the high and low pressure cylinders, this outlet directly from the low pressure cylinder to the reservoir is closed and the air discharged from the low pressure cylinder passes directly to the high pressure and assists in compressing the air on the opposite side of the high pressure piston. The inlet to the high pressure cylinder from the atmosphere is ready for operation and does operate whenever the differential pressures will permit it to open. It is expected that this pump will be able to maintain a pressure of 140 lbs. in the main reservoir with a steam pressure of 125 lbs.

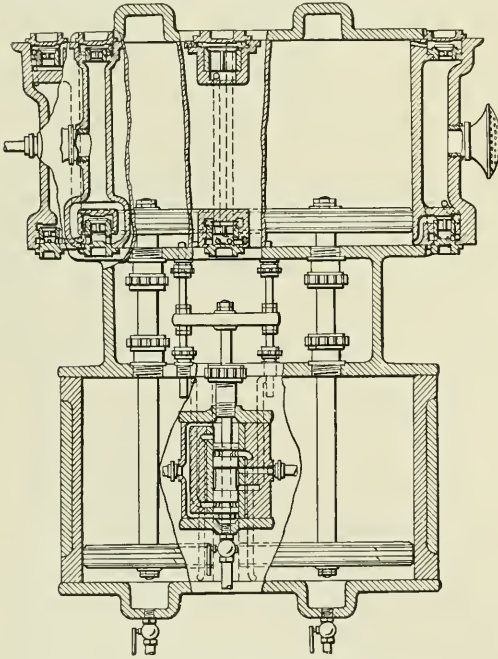

New Locomotive Air Pump.

sure, and correspondingly lower efficiencies with the lower pressures. All four pistons move in the same direction at the same time. The steam valve is connected at its upper end to a V shaped casting, which in turn is secured to two rods passing through stuffing boxes into the different cylinders. These rods are of such a length that they will be struck by the pistons when near the end of their strokes and the valve will be reversed. It will be seen that if either half of the pump is inoperative the other pistons will continue to move the valve in the proper manner. The steam chest with its valve is located at the centre and between the two steam cylinders which are on the lower end of the pump. The arrangement of the passages and the method of operation will be clear by an inspection of the illustration. The

CAR AND TRUCK LOCKING DEVICE

When the underframe of a passenger car rises above that of the next car in a collision, it generally results in the two cars telescoping. If the two underframes could be kept in line, they will absorb the shock and telescoping will be prevented.

A device has been developed on the Grand Trunk which locks

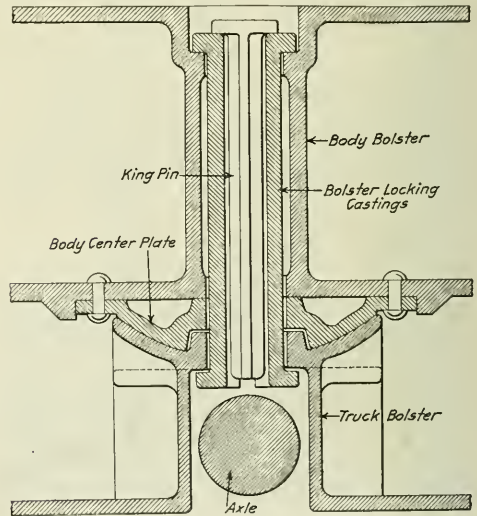

Device for Locking Car Trucks to the Underframe.

the trucks and the body of the car together, thus adding the weight of the trucks to that of the car body. It is believed that this additional weight will help to keep the underframe from rising in case of a heavy buffing shock or collision.

Reference to the illustration will show the form and application of the lock. It consists of two steel keys, with flanges at the top and bottom, which pass through the body and truck bolsters. The king pin is inserted between the keys, spreading them out and the flanges prevent the body and truck bolsters from becoming separated. This arrangement has been made standard on both the Grand Trunk and Grand Trunk Pacific.

NEWS DEPARTMENT

Preliminary plans are being made for the electrification of the Chicago, Milwaukee & Puget Sound for a distance of 450 miles, from Harlowtown, Mont., to Avery, Idaho.

The Pennsylvania Railroad is to have first aid outfits carried in all baggage cars, so that each passenger train will carry two separate outfits, one in the baggage car and one on the locomotive.

The "Banner Limited," of the Wabash, running between Chicago and St. Louis, is now made up wholly of steel cars. This is the first of ten new solid steel trains to be put in service by the Wabash.

The New York, New Haven & Hartford has announced that the line between Stamford, Conn., and New Haven, 40 miles, will be ready for electric propulsion by July 1, next. With this extension trains can be hauled by electric locomotives from New Haven to New York, 74 miles.

The state of Texas has begun suit in court against the Gulf, Colorado & Santa Fe, and the Galveston, Harrisburg & San Antonio, to collect penalties aggregating \$700,000 for running trains behind time, in violation of the law of that state under which a penalty is imposed if a passenger train is more than thirty minutes late.

The Pennsylvania Lines have issued a booklet for circulation among their employees, calling attention to the fact that the injuries to employees for the first nine months of 1912 show an increase over the same period of 1911, and exhorting everyone to increased care in order to prevent injuries. Special suggestions are made for employees in the different departments.

The first-aid-to-the-injured car of the American Red Cross Society is being run over the Lehigh Valley, stopping at all division and terminal points, and employees are invited to attend lectures and demonstrations by first-aid experts. Two physicians who were pioneers in this form of relief are in charge of the car. Men on other railroads and in nearby manufactories are invited.

The new governor of Indiana, Samuel M. Ralston, in his inaugural address calls for stricter regulation of the railroads and recommends the passage of a public utilities law. A bill has been introduced in the legislature providing for the abolition of the present state railroad commission and creating instead a public utilities commission, to have extensive powers like those exercised by the commissions of New York and certain other states.

At Sacramento, Cal., January 8, there was unveiled a bronze tablet, at Front and K streets, commemorating the fiftieth anniversary of the beginning of work on the Central Pacific. The monument stands on the spot where Governor Leland Stanford turned the first shovelful of earth. Dr. David Starr Jordan, president of Stanford University, delivered an address in the presence of a large number of veteran railroad men. Trains on the Southern Pacific everywhere were stopped for five minutes at the time of the unveiling.

SAFETY ON THE NEW YORK CENTRAL LINES

The months of September, October and November, 1912, as compared with June, July and August of the same year, showed considerable decreases in the number of employees injured in the shops of the New York Central lines. The decrease in injuries on the Cleveland, Cincinnati, Chicago & St. Louis ranged from 11.9 per cent. at the Mt. Carmel shops to 168.4 per cent. at the Bellefontaine shops. On the Lake Shore & Michigan Southern and subsidiary lines the percentage decreases ranged from

3.4 at the Kankakee shops to 87.7 at Root street, Chicago. During the six months, June to November, 1911, there were killed in all departments and branches 72 employees, and in the same months of 1912, 58 employees, a decrease of 19.4 per cent. It is claimed that credit for these decreases is largely due to the safety movement.

LOCOMOTIVES IN NEW YORK STATE

The annual report of the Public Service Commission for the Second district of New York shows that the number of locomotives owned by the railroads which operate wholly, or in part, in the state of New York, increased 4.6 per cent. in the five years from 1907 to 1912. The average tractive effort increased 17.1 per cent., and in 1912 was 30,200 lbs. In the same report an analysis is given of the causes of engine failures, and it is shown that hot bearings are responsible for 12.5 per cent., low steam for 15 per cent., steam leaks for 19.9 per cent., broken machinery for 19.5 per cent., miscellaneous, such as loose nuts, bolts, tires, wheels, burst air hose, etc., for 33.1 per cent. The New York Central & Hudson River had a locomotive mileage of 6,928 miles per engine failure during 1912. This includes all types of locomotives. The Delaware & Hudson had a mileage of 6,250 miles per engine failure. The report states that there have been no boiler explosions proper within the state in the five years during which the commission has supervised this work, notwithstanding the fact that there are over 6,000 locomotives constantly in use within the state and a large number additional in service a portion of the time. It is shown that the average age of boilers on the 9,201 locomotives recorded is 10.15 years.

FIREMEN'S WAGE DISPUTE

The committee representing the eastern railroads some days ago submitted to the representatives of the firemen a proposal that the questions of wages and other conditions now at issue between the companies and the men be settled mainly on the lines of the award recently made by the arbitration board in the matter of enginemen. The main feature of this offer is a minimum rate, but with modifications for locomotives weighing over 70 tons on the drivers. As in the case of the enginemen, the proposed schedule would increase the pay of firemen on many smaller roads, but not much on the larger systems. The principal rates are: passenger engines, \$2.40 per 100 miles; over 70 tons and up to 87½ tons, 10 cents additional; 87½ tons and over, 15 cents additional, but with a maximum of \$2.70. Through freight, \$2.75; engines weighing over 70 tons, 10 cents additional, with a maximum of \$3; engines weighing over 87½ tons, 15 cents additional with a maximum of \$3.25; switching engines \$2.45. Mr. Carter, president of the firemen, rejected the offer of the companies and suggested that no more time be lost in "useless conferences," but that matters be at once submitted to arbitration under the Erdman act. He said that the firemen would waive the clause in that act requiring a settlement in thirty days and would be willing to make the time limit sixty days. He submitted a tentative draft of an agreement to arbitrate. The roads replied that they wanted seven arbitrators, not three, which is the number provided for by the Erdman act. The efforts of Messrs. Knapp and Neill to find a ground for arbitration failed after a week of conference, and Mr. Carter announced that they would at once vote on empowering the officers of the brotherhood to order a strike. The result of the vote now being taken is not to be made known until February 10, but the railroads are confident that the vote will order a strike. They also concede that there should be adjustments in the pay of the firemen, but they desire arbitration by a

board sufficiently large to look at the controversy from all viewpoints, and appointed by some disinterested body.

MEETINGS AND CONVENTIONS

Railway Supply Manufacturers' Association.—The assignment of space for the exhibits which will be held in connection with the Master Mechanics' and Master Car Builders' conventions at Atlantic City next June, will take place on February 14.

New York Railroad Club.—The paper on the electro-pneumatic brake, by N. A. Camel, presented at the January meeting, is given in extract elsewhere in this issue. The discussion was confined exclusively to the use of the electro-pneumatic brake on passenger equipment, and it was shown that it has been in successful service on elevated and subway lines, and particularly on the New York, Westchester & Boston, where the braking requirements are unusually severe.

New England Railroad Club.—At the December meeting the subject of fire protection was brought up for discussion, being introduced by a paper from J. Albert Robinson, superintendent of fire records, National Fire Protection Association. The paper consisted largely of statistics on fire losses, both as to their cost in material and loss of life. The general causes of fires were briefly outlined and it was shown that carelessness caused the greatest number. Fire protection committees are doing excellent work in reducing fire hazards in some of the larger cities, and the methods employed and results obtained were mentioned by the author. The paper was discussed by a number of experts on fire protection, and the proceedings containing the account of the meeting forms an excellent treatise on the subject.

Central Railway Club.—The annual meeting was held in Buffalo on Thursday, January 9. Arthur Hale read a paper on Freight Car Tactics at the afternoon session. At the election which followed W. F. Jones, general storekeeper of the New York Central & Hudson River, was elected president; W. Elmer, Jr., superintendent motive power of the Pennsylvania, first vice-president; H. C. Manchester, superintendent motive power of the Delaware, Lackawanna & Western, second vice-president; E. J. Devans, superintendent of the Buffalo, Rochester & Pittsburgh, third vice-president; and Harry D. Vought, secretary. The annual banquet, held at the Hotel Statler during the evening, was largely attended. H. H. Vreeland, of New York, acted as toastmaster, and A. J. Grymes, manager marine department of the Erie; Arthur Hale and William McClellan, electrical engineer of the New York Public Service Commission, Second district, responded to toasts.

Canadian Railway Club.—L. C. Fritch, chief engineer of the Chicago Great Western, presented a paper on railway terminals at the January meeting. Impressive statistics were presented in connection with the cost of recent passenger terminals, showing that in several cases the fixed charges and maintenance of these terminals practically equaled the gross passenger earnings centering at these points. As an example, it was shown that the combined value of the passenger terminals in which the Pennsylvania Railroad is interested in the cities of Washington, Baltimore, Philadelphia and New York aggregate \$178,000,000, or an average of nearly \$800,000 per mile of road for the 223 miles from Washington to New York. The fixed charges alone

on this investment average nearly \$40,000 per mile on this part of the system. The subject of freight terminals was then considered in some detail, and the plan proposed by Jarvis Hunt for the terminals in Chicago was briefly explained. The subject of electrification of railway terminals was mentioned and, in the author's opinion, it is a matter that merits thorough investigation. Extracts from the address delivered by James J. Hill at the recent dinner of the Railway Business Association closed the paper.

Railway Club of Pittsburgh.—"Practical Methods of Abating Smoke," was the subject of the paper presented by J. M. Searle, chief of the division of smoke inspection of the city of Pittsburgh, at the November meeting. This paper drew attention to the enormous damage resulting from the smoky atmosphere and illustrated, by means of lantern slides, some of the methods and apparatus that are proving successful in eliminating it in connection with stationary boilers in the plants around Pittsburgh. The author complimented the railways on the work they have been doing in the reduction of smoke, and expressed a belief that the more extensive use of the locomotive stoker would continue to decrease the trouble. Conditions which the locomotive stoker must meet were outlined. The subject of smoke from round-houses was mentioned as one of the greatest nuisances, but no suggestions were offered as to the best method of reducing it. In the discussion D. F. Crawford stated that the records of 21,000 trips of stoker locomotives show that on about 75 per cent of the trips all of the coal was handled by the stoker, and on the remainder it ran from 99 per cent. to zero. The experience has been such as to lead the Pennsylvania to continue the application of the device. D. J. Redding explained the method by which the Pittsburgh and Lake Erie brought its passenger trains in the city without smoke.

The following list gives names of secretaries, dates of next or regular meetings, and places of meeting of mechanical associations.

- AIR BRAKE ASSOCIATION.—F. M. Nellis, 53 State St., Boston, Mass. Convention, May 6-9, 1913, St. Louis, Mo.
- AMERICAN RAILWAY MASTER MECHANICS' ASSOC.—J. W. Taylor, Old Colony building, Chicago. Convention, June 11-13, 1913, Atlantic City, N. J.
- AMERICAN RAILWAY TOOL FOREMEN'S ASSOCIATION.—A. R. Ivie, Central of Georgia, Macon, Ga.
- AMERICAN SOCIETY FOR TESTING MATERIALS.—Prof. E. Masburg, University of Pennsylvania, Philadelphia, Pa. Annual convention, June, 1913.
- AMERICAN SOCIETY OF MECHANICAL ENGINEERS.—Calvin W. Rice, 29 W. Thirty-ninth St., New York. Annual meeting, December 3-6, Engineering Societies' Building, New York. Railroad session, Thursday morning, December 5.
- CAR FOREMEN'S ASSOCIATION OF CHICAGO.—Aaron K'ine, 841 North Fiftheth Court, Chicago; 2d Monday in month, Chicago.
- INTERNATIONAL RAILWAY FUEL ASSOCIATION.—C. G. Hall, McCormick building, Chicago. Convention, May, 1913, Chicago.
- INTERNATIONAL RAILWAY GENERAL FOREMEN'S ASSOCIATION.—William Hall, Chicago & North Western, Escanaba, Mich.
- INTERNATIONAL RAILROAD MASTER BLACKSMITH'S ASSOCIATION.—A. L. Woodworth, Lima, Ohio. Convention, August 18, 1913, Richmond, Va.
- MASTER BOILER MAKERS' ASSOCIATION.—Harry D. Vought, 95 Liberty St., New York. Convention, May 26-29, 1913, Chicago.
- MASTER CAR BUILDERS' ASSOCIATION.—J. W. Taylor, Old Colony building, Chicago. Convention, June 16-18, 1913, Atlantic City, N. J.
- MASTER CAR AND LOCOMOTIVE PAINTERS' ASSOC. OF U. S. AND CANADA.—A. P. Danc, B. & M., Reading, Mass. Convention, Sept 9-12, 1913, Ottawa, Can.
- RAILWAY STOREKEEPERS' ASSOCIATION.—J. P. Murphy, Box C, Collinwood, Ohio. Convention, May 19-21, 1913, Auditorium Hotel, Chicago, Ill.

RAILROAD CLUB MEETINGS

Club.	Next Meeting.	Title of Paper.	Author.	Secretary.	Address.
Canadian	Feb. 11	Street Railway Construction	R. M. Hannaford	Jas. Powell	Room 13, Windsor Hotel, Montreal.
Central	Mar. 14	Rules of Interchange	Report of Committee	H. D. Vought	95 Liberty St., New York.
New England	Feb. 11	Charcoal Iron Boiler Tubes	J. A. Kinkead	Wm. E. Cade, Jr.	683 Atlantic Ave., Boston, Mass.
New York	Feb. 17	Safety First	J. W. Coon	H. D. Vought	95 Liberty St., New York.
Pittsburgh	Feb. 28	Locomotive Superheaters	G. E. Ryder	J. B. Anderson	Union Station, Pittsburgh, Pa.
Richmond	Feb. 10	Electric Shop Equipment	Chas. Fair and W. O. Kellogg	F. O. Robinson	C. & O. Ry., Richmond, Va.
St. Louis	Feb. 14	Railway Economics Simplified	W. W. Wheatley	B. W. Frauenthal	Union Station, St. Louis, Mo.
Western	Feb. 18	Prevention of Railway Accidents	George Bradshaw	Jos. W. Taylor	390 Old Colony Bldg., Chicago.

PERSONALS

It is our desire to make these columns cover as completely as possible all the changes that take place in the mechanical departments of the railways of this country, and we shall greatly appreciate any assistance that our readers may give us in helping to bring this about.

GENERAL

J. H. CARPENTER has been appointed chief motive power clerk of the Chesapeake & Ohio Railway of Indiana, with headquarters at Peru, Ind.

GEORGE O. HAMMOND has been appointed assistant to the mechanical superintendent of the New York, New Haven & Hartford, with headquarters at New Haven, Conn.

LOYD B. JONES has been appointed assistant engineer of motive power of the Pennsylvania lines west of Pittsburgh, with office at Toledo, Ohio.

M. J. MCCARTHY, assistant superintendent of motive power of the Cleveland, Cincinnati, Chicago & St. Louis, has been appointed superintendent of motive power of the Baltimore & Ohio Southwestern and the Cincinnati, Hamilton & Dayton, with headquarters at Cincinnati, Ohio. Mr. McCarthy was born at Susquehanna, Pa., in 1868. He served an apprenticeship with the Erie Railroad at Susquehanna, leaving that road in 1889. Subsequently he worked in various railroad shops in the West and Southwest as a machinist and foreman. He was with the Chicago, Burlington & Quincy at Burlington, Ia., for ten years as machinist, inspector and general foreman; four years as division master mechanic of the Michigan Central at St. Thomas, Ont.; two years as division master mechanic of the Lake Shore & Michigan Southern at Elkhart, Ind.; three and one-half years as superintendent of shops of the Cleveland, Cincinnati, Chicago & St. Louis at Beech Grove, Ind., and assistant superintendent of motive power of the latter road at Indianapolis, Ind., for 18 months.

J. E. OSMER has been appointed superintendent of motive power and machinery, and master car builder of the Manistique & Lake Superior, with office at Owosso, Mich.

BENJAMIN T. PAYNE has been appointed general bonus supervisor of the Atchison, Topeka & Santa Fe, with office at Topeka, Kan., succeeding John Epler.

A. P. PRENDERGAST, superintendent of motive power of the Baltimore & Ohio at Cincinnati, Ohio, has been transferred to Baltimore, Md., with the same title.

J. H. TINKER, master mechanic of the Chicago & Eastern Illinois, at Danville, Ill., has been appointed acting superintendent of motive power, succeeding S. T. Park.

H. C. VAN BUSKIRK has resigned as superintendent of motive power and car department of the Colorado & Southern, owing to ill health.

MASTER MECHANICS AND ROAD FOREMEN OF ENGINES

J. A. BARKER, road foreman of engines of the Chesapeake & Ohio Railway of Indiana, has been appointed trainmaster, with headquarters at Boston, Ind.

JOHN BENZIES has been appointed supervisor of locomotive operation of the Chicago terminal and Illinois divisions of the Rock Island Lines, with headquarters at Chicago, Ill., and will report to the master mechanic. He will have charge of the mechanical operation of all engines in service for the purpose of improving economies in the use of fuel, lubricating material, tools and other supplies, and in the operation of the locomotive. His efforts will also be directed toward reducing the cost of

maintenance of locomotives and other operating costs, through improvements that may be brought about by better supervision and instruction of engine-men.

F. T. CHASE has been appointed master mechanic of the Smithville district of the Missouri, Kansas & Texas Railway of Texas, with headquarters at Smithville, Tex.

J. H. DOUGHERTY has been appointed acting master mechanic of the Waco district of the Missouri, Kansas & Texas Railway of Texas and the Texas Central, with headquarters at Waco, Texas.

GEORGE E. FULLER has been appointed road foreman of engines of the Chesapeake & Ohio Railway of Indiana, with headquarters at Peru, Ind.

D. HARTEL has been appointed assistant road foreman of engines of the Chicago division of the Baltimore & Ohio, succeeding George Novinger, promoted.

O. A. HOFFMAN has been appointed assistant to the road foreman of engines of the Chicago division of the Baltimore & Ohio, in charge of the instruction of firemen.

FRED JUDY has been appointed road foreman of engines and air brake inspector of the Morgantown & Kinwood.

J. C. LOVE has been appointed road foreman of engines of the Los Angeles division of the Atchison, Topeka & Santa Fe, with headquarters at San Bernardino, Cal. The headquarters of A. L. Crew will be at Los Angeles and the territory of the division will be divided between the road foremen in accordance with the jurisdiction of the trainmasters.

J. P. MCANANY has been transferred as district master mechanic of the Canadian Pacific from Revelstoke, B. C., to Moose Jaw, Sask.

A. MALLINSON, general foreman of the Canadian Pacific at Revelstoke, B. C., has been appointed district master mechanic of the same road at Nelson, B. C.

GEORGE NOVINGER has been appointed road foreman of engines of the Chicago division of the Baltimore & Ohio.

D. PATTERSON, master mechanic of the Kansas City, Mexico & Orient at Wichita, Kan., will hereafter handle all matters pertaining to the motive power and car departments, and the office of superintendent of motive power and car departments heretofore held by F. Mertsheimer is abolished.

G. W. ROBB, master mechanic of the Grand Trunk Pacific, has transferred his office and staff from Rivers, Man., to Transcona, Man.

M. SCOTT has been transferred as district master mechanic of the Canadian Pacific from Nelson, B. C., to Revelstoke, B. C.

J. R. TIERNEY has been appointed road foreman of engines of the Parsons district of the Missouri, Kansas & Texas, vice C. I. Evans, promoted.

CAR DEPARTMENT

N. A. ALQUIST has been appointed general car inspector of the Missouri, Kansas & Texas, with office at Parsons, Kan.

SHOP AND ENGINE HOUSE

W. B. CHENOWETH has been appointed erecting shop foreman of the Trinity & Brazos Valley, at Teague, Tex., vice C. Murphy.

W. L. COOKE has been appointed erecting foreman of the Southern Pacific at Houston, Tex., succeeding W. T. Berger, assigned to other duties.

OSCAR C. DIBBLE has been appointed machine foreman of the Rock Island at Cedar Rapids, Ia., succeeding W. A. Yonda, resigned.

JOHN DUMPHY has been appointed foreman boiler maker of

the Rock Island at Argenta, Ark., succeeding J. H. Cotter, resigned.

J. C. DOUVAL has been appointed apprentice instructor of the Southern Pacific at Houston, Tex.

W. R. EARL, machine shop foreman of the Baltimore & Ohio at Philadelphia, Pa., has been transferred in a similar capacity to Cumberland, Md.

G. W. GILLELAND has been transferred as general foreman of the Seaboard Air Line from Monroe, N. C., to Hamlet, N. C.

HUGH GRANT has been appointed assistant boiler foreman of the Southern Pacific at Houston, Tex.

A. H. LITTLE has been appointed general foreman of the Seaboard Air Line at Raleigh, N. C.

A. McARTHUR, locomotive foreman of the Canadian Pacific at Sutherland, Sask., has been appointed general foreman of that road at Revelstoke, B. C.

E. J. McMAHON, general foreman of the Southern Pacific, at Houston, Tex., has been appointed shop superintendent at Houston, vice M. J. McGraw, resigned, to go with the Chicago & Alton at Bloomington, Ill.

R. McPHERSON has been transferred as shop foreman of the Canadian Pacific from Brandon, Man., to Moose Jaw, Sask.

A. L. MONROE has been appointed general foreman of the Seaboard Air Line at Monroe, N. C.

C. PERRY has been appointed shop foreman of the Canadian Pacific at Brandon, Man.

HARRY S. RAUCH has been made apprentice instructor at the Avis, Pa., shops of the New York Central & Hudson River. Mr. Rauch held a similar position at the Oswego, N. Y., shops of the same road until a couple of years ago, when he resigned to go into other business. He was awarded the first prize in the *Railway Age Gazette* Shop Section competition on the Instruction of Workmen and Apprentices in April, 1911.

W. RENIX has been transferred as locomotive foreman of the Canadian Pacific from Moose Jaw, Sask., to Sutherland, Sask.

E. S. SHEPPARD has been appointed machine shop foreman of the Baltimore & Ohio at Philadelphia, Pa.

WM. URBAN, gang foreman, has been appointed general boiler foreman of the Atchison, Topeka & Santa Fe at Newton, Kans.

A. G. WALTHER has been appointed piece work inspector of the Baltimore & Ohio at the Mount Clare shops, Baltimore, Md.

PURCHASING AND STOREKEEPING

U. K. HALL has been appointed general storekeeper of the Oregon-Washington Railroad & Navigation Company, with headquarters at Portland, Oregon, succeeding J. E. Mahaney, resigned.

J. E. MAHANEY, general storekeeper of the Oregon-Washington Railroad & Navigation Company, with office at Albion, Oregon, has been appointed purchasing agent of the Spokane, Portland & Seattle, the Oregon Trunk, the Oregon Electric and the United Railways, with headquarters at Portland, Oregon, to succeed F. A. Bushnell, resigned to accept service with another company.

J. R. MUELLER has been appointed purchasing agent of the Hocking Valley, with office at Columbus, O., succeeding C. B. Duffy, deceased.

L. B. WOOD has been appointed general storekeeper of the Sunset Central Lines of the Southern Pacific, with headquarters at Houston, Tex., succeeding R. L. Pries, who at his own request, on account of ill health, has been made storekeeper at Houston.

NEW SHOPS

BOSTON & MAINE.—The work on the classification yard and engine terminal at Mechanicville, N. Y., has been started. The engine house, machine shop, coaling plant, etc., will be improved.

CANADIAN PACIFIC.—It is reported that this company will move the headquarters of the Dominion Atlantic division, together with the car shops, from Kentville, N. S., to Middleton.

CENTRAL NEW ENGLAND.—The improvements at Maybrook, N. Y., consisting of an engine house, power house, machine shop and coaling plant, are about completed, and the engine house is in operation.

CHICAGO & NORTH WESTERN.—This company has purchased 260 acres between Kenosha, Wis., and Racine, for yards, engine houses and shops.

DETROIT, BAY CITY & WESTERN.—The engine house at Bay City, Mich., was destroyed by fire January 8. It is estimated the loss will amount to \$20,000.

GRAND TRUNK PACIFIC.—It has been reported that during the present year new shops will be erected at Edmonton, Alberta. The expense will be defrayed from a \$2,000,000 appropriation.

GULF, COLORADO & SANTA FE.—Work on the 8-stall engine house at San Angelo, Tex., will be started in the near future.

HOUSTON & TEXAS CENTRAL.—It is reported that the machine shops at Hearne, Tex., will be enlarged to about double their capacity. There will be additions made to the yard as well.

INTERNATIONAL & GREAT NORTHERN.—Plans are being prepared for an engine house and machine shop at San Antonio, Tex., which will cost approximately \$35,000.

LOUISVILLE & NASHVILLE.—It is reported that this company will spend about \$200,000 in enlarging its shops at Howell, Ind.

MISSOURI, KANSAS & TEXAS.—The shops at Denison, Tex., will be enlarged.

MISSOURI, OKLAHOMA & GULF.—The engine house and shops at Muskogee, Okla., were recently burned, causing a loss of about \$40,000. They will be rebuilt on a larger scale.

NORTHERN PACIFIC.—This road will build a large addition to its car shops at Tacoma, Wash. It is reported that a new engine house will be built at Toppenish, Wash.

PENNSYLVANIA.—The work on the addition to the engine house at Morrisville, Pa., has begun. Nine new stalls, a blacksmith shop, and a new machine shop will be built. The old machine shop is to be converted into a power house.

PITTSBURGH & LAKE ERIE.—New shops will be built by the company at Dickerson Run, Pa. The power house will be 60 ft. x 70 ft., the engine house 100 ft. x 60 ft., and the machine shops 60 ft. x 130 ft. The plans are now being made by the road, and it is expected that the details will be ready in the spring.

ST. LOUIS, BROWNSVILLE & MEXICO.—A coach repair shop will be installed at Kingsville, Tex.

SAN ANTONIO & ARANSAS PASS.—This company is erecting three additional buildings at its shops at Yoakum, Tex., 50 x 150 ft., 28 x 100 ft., and 50 x 80 ft.

SCOTT CITY NORTHERN.—A two-stall engine house, store house, and a blacksmith shop has been built at Scott City, Kan. This work was started last September.

SOUTHERN PACIFIC.—The plans for the re-location of the repair shops at Sacramento, Cal., are nearly finished. Improvements will cost approximately \$100,000.

SUPPLY TRADE NOTES

J. B. Rider, general manager of the Pressed Steel Car Co., has been elected a director of that company.

The Carbon Steel Company, New York, has moved its offices from 30 Church street to the Cameron building.

G. E. Fuller, Aroa, Puerto Cabello, Venezuela, would like to receive catalogs of railway machine tools, locomotives, cars and appliances.

Harry Lowman, formerly in the mechanical department of the Southern Railway at Washington, D. C., has entered the sales department of the Chicago Car Heating Co., Chicago.

J. L. Stark, general inspector of the car department of the Hocking Valley, at Columbus, Ohio, has resigned to become a representative of the Chicago-Cleveland Car Roofing Company, with office at Chicago.

Gilbert H. Pearsall, secretary of Joseph T. Ryerson & Son, in charge of railroad sales, with headquarters in New York, has resigned to engage in business for himself. Edward T. Hendee, assistant to the president, has assumed the duties formerly devolving on Mr. Pearsall.

J. E. Chisholm has been made a representative of the Universal Flexible Packing Company, Pittsburgh, Pa., with offices in the Old Colony building, Chicago; and George R. Argo has been made representative of the same company, with office in the Third National Bank building, Atlanta, Ga.

Fred Gardner, for several years railroad representative for J. T. Ryerson & Son, Chicago, resigned on January 1, and is now representing the Jacobs-Shupert Firebox Company, Oxweld Railroad Service Company, Burden Iron Company, Boss Nut Company, and other railroad specialties, with office at 339 Railway Exchange building, Chicago.

The General Pipe, Bending & Erecting Company, with headquarters at 3020 Liberty street, Pittsburgh, Pa., has been incorporated under the laws of the state of Pennsylvania. The incorporators are James W. Prenter, W. L. James and Walter C. McMinn, all of whom were formerly connected with the Best Manufacturing Company. The new company will manufacture and fabricate piping materials of every description.

William B. Hall has resigned as vice-president and general manager of the Illinois Car & Manufacturing Company, to promote the interests of the Union Railway Equipment Company, of Chicago, which has taken over the patented devices invented by Herman Pries, superintendent of the Haskell & Barker Car Company. Mr. Hall was formerly superintendent of equipment of the Mather Horse & Stock Car Company.

The annual convention of the sales and factory organizations of the Chicago Pneumatic Tool Company, was held at the show rooms of the company, 1337 South Michigan avenue, Chicago, on January 9, 10 and 11, concluding with a banquet on Saturday evening, January 11, at the Chicago Automobile Club. Nearly 100 of the company's representatives were present. The meeting was opened on Thursday morning with an address by President W. O. Duntley, and the succeeding meetings were divided into sessions devoted respectively to the air compressor department, railroad department, Cleveland plant, general sales department, Detroit plant, electrical department and commercial automobile department.

The Burden Sales Company, with general offices at 30 Church street, New York, and sales offices in Chicago, Atlanta and St. Paul, has been organized by Gilbert H. Pearsall, president; H. H. Linton, vice-president, and Craig Graves, secretary and treasurer, to be a distributor of the products of the Burden Iron Company of Troy, N. Y., makers of staybolt iron, "Burden

best" high grade refined iron for car work, engine bolt iron and Burden iron rivets. In connection with the general offices of the Burden Sales Company will be the eastern sales office of the Jacobs-Shupert United States Firebox Company and the Oxweld Railroad Service Company. Notice of Mr. Pearsall's election to the vice-presidency of these companies appeared in the August and September, 1912, issues of the *American Engineer*.

The Standard Heat & Ventilation Company, Inc., 141 Cedar street, New York, has recently been incorporated and has bought the rights of the Ward Equipment Company, New York, and the Safety Car Heating & Lighting Company, New York, relating to car heating and ventilating, and will make and sell the devices in these special lines hitherto furnished by the two latter companies. The Safety Car Heating & Lighting Company will also act as its agent. The company has now at its disposal a new plant especially equipped for the manufacture of railway car heating and ventilating appliances. The directors of the company are as follows: C. B. Adams, Wm. Barbour, R. M. Dixon, A. W. Kiddle, W. B. Albright, J. F. Deems, W. L. Garland, A. C. Moore and John E. Ward. The officers of the company are as follows: President, J. F. Deems; vice-presidents, A. W. Kiddle and A. L. Whipple; treasurer, A. C. Moore, and secretary and assistant treasurer, John J. Clapp.

George Myrick Sargent, of Evanston, Ill., the founder of the first plant in the United States for the exclusive manufacture of brake shoes, and at the time of his death a director of the

American Brake Shoe & Foundry Company, died at Atlantic City, N. J., on January 16, at the age of 83. Mr. Sargent patented in 1878 an improvement in brake shoe manufacture which led to the development of the American Brake Shoe & Foundry Company. He was born in Sedgwick, Maine, March 29, 1830, and after being engaged for several years in various lines of business in the east entered the iron industry at Moline, Ill., in 1870 as part owner of the Moline Malleable Iron Works. In 1876 he removed to Chicago and



George M. Sargent.

invented and designed an improved brake shoe, subsequently known as the Congdon, and organized a company for its production under the name of George M. Sargent & Co. In 1878 it was incorporated as a stock company under the name of the Congdon Brake Shoe Company, and in 1893 a new corporation was organized to carry on the business under the name of the Sargent Company, with Mr. Sargent as president. The company operated two plants, one for the exclusive manufacture of cast iron brake shoes, and another, which after 1896, was devoted almost entirely to the production of couplers, knuckles and steel brake shoes. This business was successfully carried on until 1901, when the American Brake Shoe & Foundry Company, promoted by W. D. Sargent and others, was organized and when it purchased the Chicago Heights plant. Shortly afterward the original plant of the company at Fifty-ninth street, was acquired by the American Steel Foundries. Mr. Sargent was a director of the American Brake Shoe & Foundry Company, and was a past president of the Live Poultry Transportation Company. In 1901 he was elected vice-president for Illinois of the National Association of Manufacturers.

CATALOGS

COLD METAL SAWS.—The Vulcan Engineering Sales Company, Fisher Building, Chicago, has issued a catalog illustrating various types of cold metal saws. It also deals with rotary planers and power driven hack saws.

HEADING MACHINES.—The National Machinery Co., Tiffin, Ohio, has issued a three page pamphlet describing the die box construction of the National wedge grip header. This is number six in a series of talks on this machine.

POWER HAMMERS.—Beadry & Company, Incorporated, Boston, Mass., have issued a six-page pamphlet illustrating and describing their belt-driven hammers. These are made in two types, one being intended for heavy forging and the other for plating, drawing, etc.

AIR COMPRESSORS.—Bulletin No. 34-F from the Chicago Pneumatic Tool Company, Chicago, Ill., comprises 26 pages devoted exclusively to a mechanical description of the design and construction of the Class G Chicago air compressors. This description applies to belt, steam and motor driven compressors, and is fully illustrated, both with photographic reproductions of various parts and sectional drawings showing the interior arrangement.

ELECTRIC FORGE BLOWERS.—Forge blowers direct connected to either alternating or direct current motors and providing any desired quantity of air up to 400 cu. ft. per minute and at pressures up to 2 oz., form the subject of bulletin 3313 from the Emerson Electric Manufacturing Company, St. Louis, Mo. The bulletin gives a very full description of these machines and includes tables of capacities, dimensions, weights, etc., for each type and size.

METAL PAINT.—A 12-page pamphlet has been issued by the Formstat Mining Company, St. Louis, Mo., describing their paint pigment particularly adapted to the preservation of iron, steel, metals, woodwork, or any artificial surface exposed to the elements and influence of destructive gases. The pigment Formstat is described and its various characteristics mentioned. Various formulas are contained in the pamphlet for its different uses.

CURRENT'S SCOPE.—Fairbanks, Morse & Company, Chicago, Ill., have distributed a device made of celluloid, which shows by means of the standard vector diagram, the relation of the instantaneous values of an alternating current in a three-phase circuit. By a simple mechanical arrangement this shows how these currents combine in the windings of a three-phase motor to produce the phenomenon of the revolving field. The device is very ingenious, and illustrates very clearly just the manner in which these currents act. Instructions for use accompany the Current's Scope.

GATE VALVES.—A small catalog devoted exclusively to gate valves made with either brass or iron bodies for steam pressures from 125 lbs. to 250 lbs., or for water pressures from 175 lbs. to 400 lbs. per sq. in., is being issued by Jenkins Bros., 80 White street, New York. These valves are of the solid wedge, double faced type and have an improved body and bonnet, designed to secure an increased strength and rigidity, and enabling the valve to resist the severe stresses of poorly supported piping, temperature changes, etc., without distortion. The stuffing boxes can be repacked when the valves are open and under pressure. Many sizes and designs are illustrated in the catalog and each is accompanied by a complete price list.

PIPE MACHINES.—The Bignall and Keeler Manufacturing Company, Edwardsville, Ill., has had thirty years' experience in the designing and building of improved pipe machines, and is among the best known specialists in this line. The three styles

that it manufactures, which differ from each other principally in the design of the chuck, are all of the stationary die type. The die head is bolted to a carriage which slides forward toward the chuck as the thread is cut. These are very fully illustrated and described in a recent catalog issued by this company. Each of the three styles is built in several sizes, and each size has a capacity of from eight to ten sizes of pipe. Machines are generally shown as belt driven, although an example with a motor drive is included. Several of those shown are provided with a gear box which gives eight changes of spindle speed.

ELECTRIC APPLIANCES.—Among the recent bulletins from the General Electric Company, Schenectady, New York, is one on electric hardening furnaces which supersedes the previous bulletin on this subject. It gives a full description of the construction and the method of operation of the electric furnace for hardening tool steel. Another bulletin from the same company describes and illustrates portable and stationary air compressor sets having a piston displacement of from 15 cu. ft. to 100 cu. ft. per minute. These are motor driven and are automatic in their operation. Polyphase induction motors is the subject of bulletin A-4063, which supersedes a former publication on this subject. This type of motor is being widely used and has many advantages where the ability to carry large overloads for considerable periods and without serious overheating is desired. The bulletin thoroughly covers the subject and is fully illustrated. Electric fans in practically all sizes and arrangements are shown in bulletin A-4065 from the same company, and Mazda lamps for standard lighting service are illustrated in bulletin 4850-C.

TRANSPORTING PERISHABLE PRODUCTS.—The Moore system, which combines refrigeration, heating and ventilation of cars intended for transporting perishable products, is illustrated and fully described in a catalog issued by the Moore Patent Car Company, St. Paul, Minn. With this system it is not necessary to break the seal or enter the car to change to or from refrigeration, heat or ventilation. The arrangement provides ice tanks just below the ceiling in the center of the car and a heater box enclosing a coal stove is under the floor and has an outside door. The heater is entirely automatic in its operation and draws fresh air from the outside which, after being heated, is discharged to the interior of the car. For ventilation there are six openings in the roof at the center of the car, three on either side so arranged that the covers on one side open toward one end of the car while those on the other open in the opposite direction. In this manner air is forced in at one side and discharged from the other and a positive circulation in the car is insured independent of the direction in which it is moving. The illustrations make the construction and operation clear.

ACETYLENE WELDING AND CUTTING APPARATUS.—Catalog Q of the Alexander Milburn Company, Baltimore, Md., consists of 32 pages principally devoted to illustrations and description of the oxy-acetylene welding and cutting apparatus manufactured by this company. This includes an acetylene generator, in which the feed is rotary, and of the indirect carbide-into-water type which makes it impossible to get an excessive charge of carbide or to feed in any way except through the normal working of the generator. The apparatus and operation are simple and the generator is readily adapted to any pressure desired from 2 lbs. to 15 lbs. Oxygen is provided in cylinders which are usually loaned and refilled or exchanged at various depots throughout the United States and Canada. Portable sets, both those having an acetylene generator and the other apparatus mounted on a truck, and those where both the oxygen and acetylene are stored in tanks are illustrated. For use in places where oxygen supply stations are not convenient an oxygen generator is furnished, and is fully illustrated and described in the catalog. Torches, regulator valves, gages and other welding supplies are also shown.

AMERICAN ENGINEER

"THE RAILWAY MECHANICAL MONTHLY"

(Including the Railway Age Gazette "Shop Edition.")

PUBLISHED ON THE FIRST THURSDAY OF EVERY MONTH, BY THE SIMMONS-BOARDMAN PUBLISHING COMPANY, 83 FULTON STREET, NEW YORK, N. Y.

CHICAGO: Transportation Bldg. CLEVELAND: Citizen's Bldg. LONDON: Queen Anne's Chambers, Westminster.

EDWARD A. SIMMONS, President. HENRY LEE, Secretary. L. B. SHERMAN, Vice-President. A. E. HOOVEN, Business Manager. The address of the company is the address of the officers.

ROY V. WRIGHT, Editor. R. E. THAYER, Associate Editor. E. A. AVERILL, Managing Editor. A. C. LOUDON, Associate Editor. GEORGE L. FOWLER, Associate Editor.

Subscriptions, including the eight daily editions of the Railway Age Gazette published in June in connection with the annual conventions of the Master Car Builders' and American Railway Master Mechanics' associations, payable in advance and postage free:

United States, Canada and Mexico.....\$2.00 a year Foreign Countries (excepting daily editions)..... 3.00 a year Single Copy 20 cents

Entered at the Post Office at New York, N. Y., as mail matter of the second class.

WE GUARANTEE, that of this issue 4,150 copies were printed; that of those 4,150 copies, 3,800 were mailed to regular paid subscribers and 130 were provided for counter and news companies' sales; that the total copies printed this year to date were 14,926 copies—an average of 4,869 copies a month.

VOLUME 87. MARCH, 1913. NUMBER 3.

CONTENTS

EDITORIALS:

Car Department Competition.....	111
Answer Circulars from Committees.....	111
The Gee Locomotive Stoker.....	111
Mechanical Department Appointments.....	111
Car Men and Interchange Rules.....	112
Electric Locomotives.....	112
Making Improvements in Operation.....	112
Vestibule Locomotive Cabs.....	112
Water Tube Fireboxes.....	113
Standard Freight Cars.....	113
Basis for Comparing Machine Tools.....	114
New Books.....	114

COMMUNICATIONS:

Guide Bar Blocks.....	115
Handling Scrap Material.....	115
Exhibits Open in the Evening.....	116
Air Brake Hose.....	116

GENERAL:

Canadian Pacific 4-6-2 Type Locomotive.....	117
Locomotive Deck Shields.....	122
Forms for Locomotive Operation and Costs.....	124
Service of the Protan Boiler.....	128
Experimental Electric Locomotives in France.....	129

SHOP PRACTICE:

Cracked Cylinder Repaired with Concrete.....	131
Punching Spring Planks.....	131
Protecting Slide Valve Feed Valves in Shipment.....	132
Grimling Piston Rings in Air Brake Apparatus.....	132
A Basis for Measuring Lath Capacity.....	133
Motion Work Kinks.....	136
Safety on the Chicago & North Western.....	137
Boiler Shop Kinks.....	142
Tool for Removing Driving Box Cellars.....	142

CAR DEPARTMENT:

Car Design from the Repairman's Standpoint.....	143
Pittsburgh & Lake Erie Two Car Gas-Electric Train.....	143
Shop Arrangements and Facilities.....	144
Equipment for Clearing Wrecks.....	145
Application of Safety Appliances to Cars.....	149
Express Refrigerator Cars.....	152
Locating Defective Car Wheels.....	152
The Instruction of Car Men in Interchange Rules.....	154

NEW DEVICES:

The Gee Locomotive Stoker.....	155
Improved Force Feed Lubricator.....	157
Anti-Friction Side Bearings.....	158
The Kling Bolt.....	158
Motor for Shop Service.....	159
Testing Equipment for the Pennsylvania.....	159
Grapho-Metal Packing.....	160
Blow-Valve.....	160

NEWS DEPARTMENT:

Notes.....	161
Meetings and Conventions.....	161
Personals.....	163
New Shops.....	165
Supply Trade Notes.....	166
Catalogs.....	168

Car Department Competition

The car department competition, which closed on February 15, brought in a number of splendid articles on different phases of the car department work. These have been prepared for publication and will be submitted to the judges within the next week or two. We hope that we will be able to announce the prize winners in the April issue. A survey of the various articles indicates that this competition has been one of the most successful which have ever been held in either the Railway Age Gazette Shop Section or the American Engineer, and we take this opportunity of thanking those who participated for their assistance and co-operation.

Answer Circulars From Committees

Criticism is heard each year because of the delay of printing and putting the reports of the various committees in the hands of the members of the Master Mechanics' and Master Car Builders' Associations. It is naturally impossible for a member to present a satisfactory discussion on a committee report which he has had no opportunity to digest, but such a member has no right to criticize either the secretary or the committee, if he permits the circular requesting information to lay unanswered on his desk or on the desk of some of his subordinates for weeks and in some cases, months. It is as much your duty to answer these circulars as it is to pay your dues to these associations, and if more members would appreciate this fact the criticism of late reports and of incomplete discussions would cease. The Master Car Builders' Association has already issued twenty-five circular letters this year, more than half of which require an answer. How many of these or of the five or six circulars from the Master Mechanics' Association still remain unanswered by you or your office?

The Gee Locomotive Stoker

The latest design of locomotive stoker, which was developed on the Pennsylvania Railroad at Altoona, is now undergoing severe service tests which, so far, indicate that it will be a success. It has already successfully fired at least fifty trips of a large locomotive, doing 100 per cent. of the firing. This stoker was designed by N. E. Gee, of the mechanical engineer's office at Altoona, is of the overfeed, scatter type, and distributes the coal by means of intermittent steam blast used in connection with movable wings for controlling the direction inside the firebox. This stoker fulfills all of the conditions laid down by the committee of the Master Mechanics' Association and does not in any way interfere with the ordinary firedoor. The arrangement is simple and the moving parts are very few in number. The construction includes features which have proved successful on other designs while differing essentially from any previous arrangement. The crusher, conveyor and source of power are the same as have been successful on the Crawford stoker, and the distributing system is a simplification of the arrangement successfully used on the Hanna stoker. While, as built at present, no arrangement is made for an automatic distribution, such as can be obtained with the Hanna design, it is evident that this can be easily included in later stokers if it seems desirable.

Mechanical Department Appointments

Judging from the number of minor mechanical officers who resign or are "assigned to other duties," on some railroads, it would almost seem that there is a precedent against keeping a man in one position for more than a few months. This is a phase of the organization question which in many cases should receive more attention. It is frequently difficult to make a suitable selection in filling a vacancy, but when the same position has to be filled several times in a

single year because the men selected do not give satisfaction, it is time the officer who makes the choice, or some one above him, began investigating his capability of making such selections. Very few men can take a position as foreman or master mechanic and become familiar in a few days or weeks with the conditions obtaining, and in no case should it be required. It is unreasonable to expect that a paragon can be obtained to fill every position, and the appointing of average men and expecting them to do supernatural things is responsible for a great many "resignations." The superintendent of motive power in selecting master mechanics, and the master mechanic in selecting foremen, can get excellent results from the carefully selected average man if, instead of leaving him, after the appointment is made, to sink or swim by himself, they keep in personal touch with him, encouraging him to ask for help in solving his problems and letting him see that he is an important part of the railroad's machinery. No organization can be perfected while the members are being continually changed, and this changing works very decidedly against general efficiency.

Car Men and Interchange Rules

It would be difficult to estimate the proportion of M. C. B. repair cards that are improperly made out and the time lost in making the necessary corrections, but every car department officer will agree that it is much too large. This is largely the fault of the men who have to make the repairs and make out the cards, but it can scarcely be doubted that by adopting some educational method the greater part of the errors could be overcome. The rules of interchange are not easily grasped by a beginner, and if they are not carefully and thoroughly studied till a good working knowledge of them is obtained, there is little likelihood of their being mastered later, as the changes made from time to time require much study, even from the experienced car man. Sending a copy of the rules to each man concerned, whether a letter calling attention to the changes made accompanies it or not, is no help to the average man in solving the difficult problems that arise, and some method of instruction should be developed which will be commensurate with the importance of the subject. Elsewhere in this issue a solution of this problem is suggested in an article on The Instruction of Car Men on Interchange Rules. The establishing of a system of written examinations may not be the required remedy, but there is food for much thought in the suggestion.

Electric Locomotives

As might be expected in a field which is as new and is developing as rapidly as the design of electric locomotives, there is far from a general agreement on even the more essential principles. Service records are the final court of appeal for any design of railway equipment and naturally the decision is long delayed. Not for many years and possibly never will a conclusive decision be obtained on the comparative merits of direct current or alternating current operation and other features, such as driving through gearing or through rods, the type of control apparatus or the proper voltage, will probably be subjects of active discussion for years to come. One of the French railways, the Chemin de Fer du Midi (Southern), has completed plans for the electrification of a large part of its lines and in undertaking this work has naturally desired to determine on the most satisfactory design of locomotive. It therefore presented to the various builders a specification which included only such requirements as weight limits, draw bar pull and temperature rise, together with clearance and curvature information. In response to this, it received six proposed designs from as many builders and has extended to them

the privilege of building a machine from the designs suggested, with the understanding that if it satisfactorily fulfills the conditions on an actual trial it will be accepted. So far three distinct designs have successfully passed the trials and are now in operation on the short sections already electrified. Of at least one of these, duplicates have been ordered. The other locomotives are to be given trials as rapidly as possible. Of the three accepted, each is distinctly different from the others in its principle of operation as well as in minor details. The fact that each fulfills the conditions indicates the wide possibilities and the active state of the art as it now exists. One of the locomotives was built by the French Westinghouse Company and has two 600 horse power motors geared to jack shafts which in turn drive the locomotive through a yoke and side rods. Another, from the Thomson-Houston Company, has two slow speed 600 horse power motors and drives through main rods to jack shafts which in turn are connected to the drivers by side rods. The third, from Jeumont, has three 500 horse power motors each geared directly to one of the drivers which in this case are not connected by side rods. In the latter case the electric control arrangement is such as to form an anti-slipping device which insures that each of the drivers will be revolved at the same speed as the others. The features of the design of the other three locomotives have not yet been made public.

Making Improvements in Operation

An improvement toward economy can seldom be made without a knowledge of the conditions, and this knowledge is usually dependent on accurately maintained records. Criticism is often heard of the large increase in clerical force required in connection with the introduction of any of the successful methods of production improvement that are grouped under the term, "scientific management." The fact is that the benefits of any of these systems and the decision as to the changes that shall be made are always dependent on a knowledge of details which are only procurable through elaborate records. This multiplicity of systematized information, combined with a knowledge of how to use it, is the fountain head in which the benefits have their source. In most railway shops as few records are maintained as possible, and the consequence is that a method, design or organization has to be glaringly inefficient before a correction can be made. In cases where systematic records have been maintained on a few features, the results, almost without exception, are beneficial, and there is little doubt but that a saving in the clerical pay roll is, in many cases, very costly. Any master mechanic or other motive power official reading Mr. Heckman's article in this issue cannot help but realize in how much better a position he would be to make recommendations or changes if he had the information available that is given by the forms presented. It must be admitted that it is easily possible to expend considerable money for records which are not worth while, and care must be used in deciding which information should be tabulated. It is better, however, to keep too many records than too few, provided the knowledge is at hand as how to use them to advantage.

Vestibule Locomotive Cabs

A locomotive cab as ordinarily arranged is anything but a comfortable place when the locomotive is in operation during cold weather, which, in the northern part of the country, exists for a greater part of the time during five months of the year. That the locomotive crew is entitled to as comfortable surroundings as conditions will permit is undeniable and the Canadian Pacific proposes to have the engine crews on their passenger trains, at least, protected from cold and wind. While this line traverses a country where the winter weather is more severe and prolonged than most others,

there are sections in this country, particularly on some of the western lines, where something better than the inefficient canvas cab curtains would seem to be justified. The vestibule cab of the Canadian Pacific is entirely enclosed and will evidently be as comfortable during very cold weather as the ordinary cab in the month of May. By the application of a coal pusher on the tender there is no necessity for the fireman to go back into the coal space, nor will the coal gates have to be opened. The arrangement of the scaled connection between the engine and the tender has been very ingeniously worked out with but little complication. While designing the tender for use in connection with the vestibule cab, a distinct advance was made by arranging the tank and underframe as one unit, practically doing away with the latter. The interior of the tank is so braced and stiffened as to be self-supporting and is carried by a single box-girder type center sill. In addition to the reduction of weight, this has proved to be a safety arrangement for the crew, since in the case of a severe collision the tank cannot move on the underframe, and thus is not forced into the cab. One of the photographs given by Mr. Winterrowd in his discussion of this design, shows a tender which had been in a severe collision, and it is evident that, in addition to the greater safety to the crew, there could not be a better place, from the standpoint of cost of repairs, for the shock to be absorbed.

Water Tube Fireboxes

So far as the records show there is not a locomotive boiler with a water tube firebox of any description in operation in this country, although both in England and on the continent boilers, having fireboxes either partially or wholly constructed of water tubes, have been in successful service for several years. At a meeting of the Western Railway Club in November, 1895, William Forsyth, then mechanical engineer of the Chicago, Burlington & Quincy, suggested such an arrangement and presented a sketch to illustrate his ideas, which consisted of practically a Yarrow type water tube boiler arranged to take the place of the firebox of an ordinary locomotive boiler. Since that time a number of arrangements incorporating this idea have been suggested, although apparently none of them have appealed with sufficient force to get a trial in actual service. In these times when boiler capacity is the thing most desired on locomotives, it would seem that some type of a water tube firebox would be worthy of at least a trial. With the example of what can be accomplished in the shape of capacity per unit of weight by water tube boilers in stationary practice and in marine service it would appear to be a field well worth developing. It will probably be admitted that the most valuable heating surface in a locomotive is in the arch tubes and suggestions have been made that an increase in the number of arch tubes would be advisable. While there is a limit to the number of arch tubes, as at present located, that can be applied in a firebox, there is no reason why a similar effect cannot be obtained by tubes arranged in a somewhat different location, and such a firebox has been suggested by S. S. Regal, and drawings were published on page 136 of the 1906 volume of this journal. On the London and South Western Railway a number of locomotives with water tubes extending diagonally upward and across between the side sheets have been in successful operation for a number of years. Both of these constructions, however, can be considered as fireboxes with water tubes as distinguished from a water tube firebox, the essential difference being that there is practically no reduction in the number of staybolts in the former case, while in the latter the staybolts are almost entirely eliminated. Of the latter type the Jacobs-Shupert firebox can be considered as a compromise between the true water tube design and the usual arrangement. The next step is illustrated by the McClellan boiler, which was shown in the January, 1911, issue of this journal. This design forms the water legs of a series of

flattened tubes and does not require the use of staybolts, except in the throat sheet and back head, but still retains the mud ring, having a large size opening which gives communication between the bottom of the different tubes. The complete water tube firebox, however, is found in the Brotan type, and it is this design that has proved so successful on several of the continental railways. This boiler completely eliminates the staybolts. It was fully illustrated in the December, 1910, issue of this journal. Experiments made with the utmost care on a Russian railway showed a fuel economy of over 14 per cent. for these boilers and the report of three years' service, which is given in this issue, indicates that the maintenance troubles have not proved at all serious. In fact, the Brotan firebox has been made standard on some of the Russian railways and is rapidly coming in favor in other countries. The superheater has shown us how a coal saving device can be effectively used as a capacity increaser. The water tube firebox would appear to offer a similar opportunity.

Standard Freight Cars

One of the ways in which the cost of repairs to freight cars could be very materially reduced would be the adoption of a standard design for each of the more generally used types of car. Efforts leading to the adoption of standard general dimensions are being made by the American Railway Association. The standardization of various parts subject to wear or frequent renewal has been the work of the Master Car Builders' Association for many years. While there have also been spasmodic efforts to arouse interest in complete standard cars at various times practically nothing tangible has been accomplished. Some of the larger roads have more or less standardized their own cars and, in some instances, have succeeded in having the same designs adopted by controlled or leased lines. If it is a paying proposition for a large road which transports practically every conceivable commodity and operates under all the different conditions as to grades, curvature, sidings, etc., to do this, why would it not be even more profitable for all of the roads to agree on the standard design so far as the essential parts of the car are concerned? In a paper before the New England Railroad Club, Chas. A. Lindstrom, chief engineer of the Pressed Steel Car Company, states that at the present time every railway seems to be a law within itself, no matter what the size of the road, and apparently very little if any notice is taken of designs of cars already in successful operation by other roads which could be duplicated at less cost than new designs. He states that it seems to be the main object to get out something new regardless of its intrinsic value. Sometimes the designs may be as good as those in existence, sometimes they may contain some minor improvements of more or less value, but they frequently contain defects which give trouble in operation and on the whole there was no necessity for their creation. He points out the fact that new designs of cars cost a great deal in the way of drawings, dies, templates, etc., which must be paid for by someone, generally the customer. The creation of a new design for the mere purpose of getting up something different should be discouraged. For railways owning comparatively few cars the original cost and the cost of repairs would be greatly reduced if they would adopt as their own, the standards used by the larger roads with which they have traffic connections. As Mr. Lindstrom truly states, it is difficult to understand the necessity for different designs of cars for roads having the same class of freight to carry. Cars belonging to two different roads are frequently loaded at the same mines, hauled by the same locomotives and unloaded at the same wharf or factory, and yet an examination of the cars will show that while they are of the same carrying capacity and have the

same general dimensions they differ radically in general construction and details. Both may be equally good and serviceable and if so there is no difference between them and one would answer the purpose. On the other hand if both designs possess meritorious features over each other, they could readily be joined together in one design with a result that would be greatly to the common good. It is suggested that an engineering board should be created to prepare the designs for all cars used in interstate commerce and that no new designs of cars or details should be allowed to be used until approved by it. Such a board could be created by the roads now forming the Master Car Builders' Association or the American Railway Association. Although the efforts toward standard cars which were made in 1896 and the few following years, by the Master Car Builders' Association met with no success, it would seem as if the conditions were now more propitious and another effort might be successful. The cost of car maintenance is enormous and if it is merely personal prejudice which is standing in the way of a movement which is sure to greatly reduce this cost, prompt action should be taken.

Basis for Comparing Machine Tools

There has never been a logical basis on which the ability of two lathes to do the work for which they were designed could be determined and compared from a knowledge of their general features. When two machines of the same size which have the same number of speeds and feeds, the same convenient arrangement and appeared to be equally well built, are available, it has generally been a matter of price or some similar consideration that has determined the selection. It may be, and frequently is, possible that one of these machines will do 25 per cent. more work of the kind on which it is to be used than the other, and is worth decidedly more to the purchaser. This, of course, is well known to the men whose duty it is to select machine tools, but they have never had an opportunity of proving which is the better except by actually making a practical trial or test. These men will undoubtedly be grateful to Mr. Pomeroy for the methods he has developed which will permit an accurate knowledge to be obtained of the ability of the different machines to do the work desired with simply a knowledge of two or three of the main characteristics. This method is fully explained, and examples of its use are given on page 133 of this issue. The number of pounds torque at a one-foot radius that can be obtained at each spindle speed provided in the machine is the basis adopted. This, taken in connection with formulas developed by Dr. Nicolson in his extensive research, will show just how large a cut can be taken at any radius at each of the spindle speeds provided in the machine. This, of course, determines the amount of metal to be removed per minute which, in many cases, is the controlling feature. Two actual 24 in. lathes that are now on the market, and which are generally considered as being equally good, are used as examples of the value of the method, and one is shown to be very decidedly better than the other. Although the examples selected are lathes, the same procedure will apply to either horizontal or vertical boring mills.

NEW BOOKS

Economics of Railroad Construction, Second Edition. By Walter Loring Webb, C. E. Bound in cloth. Illustrated, 332 pages, 5 in. x 8 in. Published by John Wiley & Sons, 43 E. 19 street, New York. Price \$2.50.

The scope of this book, which was first brought out six years ago, is well explained by its title. It includes seventeen chapters covering such matters as organization, capitalization, valuation, and volume of traffic in the first part, operating expenses, motive power, car construction, track economics, train resistance in part two, and physical elements of a railway in

part three. The book is written from the standpoint of the constructing or operating engineer and deals briefly with principles and their practical application. The present edition has been thoroughly revised and the chapters on operating expenses, distance, curvature and grade have been practically rewritten.

Diary of a Roundhouse Foreman. By T. S. Reilly. Bound in cloth. 158 pages, 5 in. x 7 in. Published by the Norman W. Henley Company, 132 Nassau street, New York. Price, \$1.00.

The book is published in the form of a diary and gives in colloquial form the experiences and trials of the engine house foreman. The hero of the story is a young college graduate who is serving his apprenticeship and has endeavored to push his way to the top. Many suggestions are given for the diplomatic handling of men.

The Electron Theory of Magnetism. By E. H. Williams. Bulletin No. 62, from the Engineering Experiment Station of the University of Illinois. Bound in paper. Illustrated, 66 pages, 6 in. x 9 in. Published by the University of Illinois, W. F. M. Goss, Director of the Engineering Experiment Station, Urbana, Ill. Copies free.

In the study of physical phenomena, various theories have been advanced from time to time as to the nature of magnetism. The most interesting and important of these is the electron theory and in this bulletin the experimental evidence leading to the development of the theory is traced, its present status defined and certain phenomena which it fails satisfactorily to explain in its present form are pointed out.

Machine Design—Hoists, Derricks, Cranes. By W. D. Hess, M.E. Bound in cloth, 364 pages, 6 in. x 9 in., 336 illustrations. Published by J. B. Lippincott Company, Philadelphia. Price \$5.00.

While this book is intended principally as an aid in the work of machine design instruction in technical schools and colleges, it will also prove useful in drawing rooms where a general field of machine design is covered. The problems presented by the author have been selected with this in view, rather than that of appealing to the specialist in crane design. As may be judged from its size the work is most complete. There are eighteen chapters and each of the various types of cranes is discussed separately. The book is profusely illustrated and gives photographs or drawings of the latest developments in this field. Many of the formulas are also shown in diagrammatic form, and tables for constants are numerous. In discussing the theory, practical examples are given in each case and the complete evolution of the formulas make it possible for the designer to accurately judge their application to his problem.

Master Car Builders' Association. Proceedings of the 1912 Convention. Illustrated. Bound in cloth, 983 pages, 6 in. x 9 in. Published by the Master Car Builders' Association, Jos. W. Taylor, secretary, 390 Old Colony building, Chicago. Price \$7.50.

Each year the progress in the design and operation of freight and passenger cars is focused by the activities of the Master Car Builders' Association at its annual convention. While the same length of time is devoted to this work as in years past the better organization, the improved quality of the committee reports and the enforcement of sensible rules for the discussions at the meetings has made it possible to decidedly increase the amount of work accomplished at each succeeding convention. At the 1912 convention there were twenty-three committee reports presented, discussed and acted on. Some of these, of course, were perfunctory, but others were subject to the closest scrutiny and extended discussion. The fact that the printed volume of proceedings contains nearly one thousand pages in addition to ninety-one double page plates of standards and recommended practice, is an index of the work accomplished last year. The volume contains the complete verbatim account of the dis-

discussion which followed the report of each committee, and in addition there is given a list of the membership with the dates on which they joined and the number of cars represented by each. A copy of the constitution and by-laws, a list giving the names of the members of the committees to report at the 1913 convention, together with the results of the voting by letter ballot on the various subjects ordered to be so submitted at the previous convention, are also included.

Hand Book of Railroad Expenses. By J. Shirley Eaton. McGraw-Hill Book Company, New York. Flexible leather binding. 555 pages. 7 1/2 in. x 5 in. Price, \$3.

Mr. Eaton's book on Railroad Operations—How to Know Them was for a good many years a standard book on railroad operating expenses as given in the annual reports made by the companies to their stockholders. Since the Interstate Commerce Commission has put into effect its uniform classification for operating expenses and for other accounts of railroads, a good many changes have been made by some roads in their system of accounts, and Mr. Eaton's earlier book became to a certain extent obsolete. In the present book is included Mr. Eaton's exposition of the various items under operating expenses, and also the text of the Interstate Commerce Commission's classification of operating expenses, income account, balance sheet, etc. Under operating expenses the full text of the commission's classification and instructions is given, and there are incorporated in this text revisions which the commission has issued as supplements to its original orders. One hundred and fifty-two pages of the book are devoted to an index which is very complete. Mr. Eaton says that all existing indexes of expenses have been freely drawn on and acknowledges especially his indebtedness to the index in use on the New York Central & Hudson River.

The greatest importance of this book lies in this index. There has been a very distinct need, ever since the Interstate Commerce Commission promulgated its classification of expenses, for a field book of operating expenses. This book of Mr. Eaton's appears to supply this want admirably. The Interstate Commerce Commission itself may well find the index of great use.

Traveling Engineers' Association. Proceedings of the twentieth annual convention. Illustrated. Bound in leather, 410 pages, 6 in. x 9 in. Published by the Traveling Engineers' Association, W. O. Thompson, Secretary, Buffalo, N. Y. Price \$1.50.

At the last convention of the Traveling Engineers' Association, held in Chicago, August 27-30, 1912, a number of the more important and interesting problems in connection with locomotive and train operation were presented for discussion. In each case the author of the paper, and especially the members discussing it, approached the subject with the evident intention of obtaining the greatest benefit possible in the time at their disposal. In consequence both the papers and the discussions were most valuable. They are given complete in the proceedings. The committee on subjects wisely provided but six topics, as follows: Benefits to be derived from chemically treated waters in connection with the increased efficiency of locomotives; Fuel economy and the relation of mechanical appliances, such as superheaters, mechanical stokers, brick arches and the handling of trains; Handling of long passenger and freight trains with modern air brake equipment; Inspection of locomotives and form of work reports that should be required of engineers on arrival at terminals; How to interest engineers in the economical use of fuel and lubricants, and the advantages and disadvantages of lead on modern locomotives. The volume includes a copy of the constitution and by-laws, a list of members with their addresses, and a list of the subjects presented for discussion at each of the previous conventions. The subjects which will be presented for discussion at the next convention to be again held at Chicago in August, 1913, are also given.

COMMUNICATIONS

GUIDE BAR BLOCKS

BATLE CREEK, Mich., January 27, 1913.

TO THE EDITOR OF THE AMERICAN ENGINEER:

In making guide bar blocks our usual process has been to have them forged to approximately the required size, and afterwards shape off the four sides to the exact dimensions. A new method has been developed which, considering both the forge shop labor and the work done in the machine shop, is a considerable improvement. As most guide bar blocks are of standard size, it is easy to procure cold rolled steel bars conforming to the dimensions of the finished blocks and the rolling is quite accurate enough for all practical purposes. The

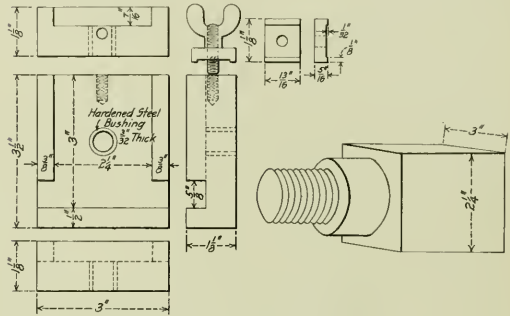

Guide Bar Block and Centering Jig.

bars are sawed to the proper length in a high speed power hack saw, at practically no other cost than the price of the saws. They are then centered in a drill press with a standard countersink and drill combined, using the jig shown in the illustration for this purpose. The bushing is made the proper diameter for the countersink drill. All that is then required is the lathe work, which can be done in less time than the forgings can be machined on the end and turned up, leaving out the question of shaping the sides afterwards. I was afraid at first that these blocks would not last as long as the forged ones, but after two years' observation I believe they last quite as long or even longer.

M. H. WESTBROOK.

HANDLING SCRAP MATERIAL

WEST ALBANY, N. Y., February 8, 1913.

TO THE EDITOR OF THE AMERICAN ENGINEER:

In an article which received first prize in the *Railway Age Gazette* Shop Section competition on Reclaiming Scrap Material which closed July 15, 1911, A. A. Burkhard described the methods then in use at the West Albany scrap platform of the New York Central & Hudson River. We are now operating at this point 25 heavy iron crane buckets, 50 in. x 50 in., each having four wheels and a trip attachment. The wheels are very important, as at times when we are unable to get crane service promptly the buckets can be moved easily by hand. We use a 15-ton self-propelling magnet crane with a 40 ft. boom, and with it the buckets effect a great saving in the cost of handling scrap.

In unloading scrap to the pile at our sorting bins in the center of the platform, we use the magnet crane for about 80 per cent. of the cars. We operate a row of buckets on both sides of the pile, so that when the crane is handling buckets on one side we have the men work on the other side, thus avoiding accidents.

While at times the filling of buckets may seem slow, scrap is being sorted all the time. The practice at a great many scrap

platforms is to have men sorting and loading trucks, and when scrap is handled in this way, either the truckman waits for the sorter to load his truck, or the sorter waits for the man with the truck to return. This is not only expensive, but is also the cause of holding commercial cars at the platform when they should be in road service.

We use the crane buckets over the entire length of our 790 ft. platform for carrying material of all kinds, including the transfer of rubbish to the rubbish cars. We also place them in front of the shop cars when there is a good run of straight scrap, the crane carrying all the buckets to cars under load, or to bins assigned to the different classes of scrap.

Some scrap foremen will no doubt question my claims for the crane bucket, but I believe that where once used it will never be dispensed with.

B. J. FROELICH,
Foreman, West Albany Scrap Platform.

EXHIBITS OPEN IN THE EVENING

CHICAGO, February 17, 1913.

TO THE EDITOR OF THE AMERICAN ENGINEER:

I most heartily concur in the suggestion made in your February issue, of having the exhibits at the Atlantic City Conventions open during the evening, and trust that it can at least be given a trial. I believe that the exhibitors would find it so greatly to their advantage that, after a short trial, they would insist on a continuance of the practice. In attending the conventions I feel that it is my duty, both to myself and my company, to obtain the greatest amount of benefit from the meetings of the associations and I attempt to be present during the full sessions each day. The result is that I have but from two to three hours a day to examine the exhibits and when the amount of time consumed in greeting old acquaintances is deducted, the remainder, even including Saturday and some early morning visits, does not permit me to see hardly one-quarter of the apparatus shown that I would like to examine. If they will hold the exhibits open in the evening my time for this purpose will be practically doubled and in view of the smaller crowds that would be present at that time, I could probably cover the whole exhibit to my satisfaction.

RAILROADER.

AIR BRAKE HOSE

CHICAGO, February 15, 1913.

TO THE EDITOR OF THE AMERICAN ENGINEER:

The interest now being manifested in the question of air brake hose is probably brought about by the quite general impression that the manufacturers of rubber hose are furnishing the poorest product possible. Some manufacturers are making a better hose than others. Some are inclined to put in too much of the shoddy materials, which mean larger profits and less life. Has the general railroad world come to a realization that damage to life and property results from poor and cheap hose bursting? There are two ways of looking at this: First, the best hose must eventually cause a failure, perhaps a serious one. Second, failures from poor hose will be greater in number, because if the poor hose gives an average service of 8 months and the good serves 24 months, for the moment neglecting failure from outside causes, then three cheap hose must play out, or fail, to one good hose. It may be expected, therefore, that the total number of failures will be less with good hose. By failures is meant the bursting of a hose on a freight car when in motion.

Hose that are removed because the cover is cracked or deteriorated, or because of "kinks" or other defects readily apparent might, perchance, last months before failure. It is, however, wise to remove hose which appear to be about ready to fail. If better, or rather the best quality of air brake hose is used economy follows. That the best is the most economical cannot be refuted. Reducing this to a percentage basis—assume

that air hose will last an average of 16 months, and that these hose at 34 cents per foot (cheapest price) cost 62.3 cents each. Such a hose is worth 9 cents as scrap. The net cost to a railroad is, therefore, approximately 53 cents each, or about $3\frac{1}{2}$ cents per month. The better hose, costing 77 cents each, or about 68 cents net, would cost $4\frac{1}{4}$ cents per month (at 16 months). For economy the more expensive hose should last 77×16

$\frac{77 \times 16}{53} = 23\frac{1}{4}$ months, or have 45 per cent. increased life.

53
This, of course, disregards the cost resulting from increased failures due to poor hose, cost of stripping and fitting up, applying to and removing from cars, handling, shipping, etc.; nor does it take into consideration the matter of mechanical abrasion or injury or other causes of failure other than natural deterioration.

When it is considered that railroads purchase air hose to the extent of from 1,000 to 6,000 per month at a cost of \$620 to \$3,700 for the cheaper hose and \$770 to \$4,600 for the more expensive, it becomes quite evident that positive economy should be practiced in the treatment of this easily damaged material. An increase in cost for hose from 62 cents to 77 cents each would not be warranted unless at least a corresponding increase in service would be received. It is generally known that very few hose remain in service during their expected life; they are removed for causes which should be eliminated. The highest percentage of hose are removed on account of mechanical abrasion, most of which takes place at the nipple end. This is caused by traimmen using some instrument for hammering the angle cock handle open or closed as they find it necessary. A brickbat, piece of iron, or even the heel of a boot will invariably cut the hose when it misses the handle. The effects of such blows are increased by the nipple being rigidly held in the angle cock which acts as a base in receiving the blow. Probably more attention to the easy working of the angle cock would eliminate some of these failures; also the use of suitable protectors at the nipple end will prevent any injurious blows being delivered to the hose. The time limit provision will, of course, be impracticable, as in the present rush of traffic every car man knows that he will be unable to get together car inspectors who will follow this matter closely enough to do any good.

The increased cost of such practice in loss of serviceable hose to the railroad can be reckoned on an average of at least three months. It would appear better for the rubber manufacturers to labor for the production of an air hose which will have more time resisting qualities than for the production of a hose which permits a high amount of stretch. There is no conclusive evidence that rubber which will stretch well will last well. In compounding, they should perhaps be excused from producing an air hose which will never be subjected to the stretch required by the M. C. B. specifications. The manufacturers claim that the tensile strength requirement in rubber will insure long life, which sounds reasonable, and will, perhaps, be either proved or disproved within the next few months.

If railroads, and particularly the purchasing departments, realize that service is of more importance than price, and if a good hose is obtained and protected from injury as much as possible, the troubles resulting from defective hose will naturally cease, and the present situation be improved to a marked degree.

There are many angles from which to view the whole train line subject, and in some cases this important part of train operation has been overlooked. A locomotive coupled to a train is rarely seen standing with the air pump at rest; it is continually working to supply the air lost through leaks. Among the contributory items are injured tubes resulting from machine mounting, clamping, burrs on the shanks of couplings and nipples, gaskets of poor quality, rusted couplings and in some cases hose which are very apparently worn out and which leak, being left on cars.

J. S. SHEAFE,
Engineer of Tests, Illinois Central.

CANADIAN PACIFIC 4-6-2 TYPE LOCOMOTIVE

Equipped with an Enclosed Vestibule Cab and
a Combined Tender Tank and Underframe

BY W. H. WINTERROWD,
Mechanical Engineer, Canadian Pacific Railway, Montreal, Que.

A little over a year ago the Canadian Pacific built and put in service a number of Pacific type locomotives that had several experimental features. These locomotives, constructed at Angus shops in Montreal, were in service but a short time before the merit of some of the new arrangements was so conclusively established that they were adopted on the locomotives of following orders.

The Pacific type locomotive illustrated is practically the standard type of passenger locomotive in use on the Canadian Pacific, and while it is not so heavy as some of the locomotives of the same type on some other railway, it is marked by a refinement in design that has been brought about by the necessity of obtaining the maximum amount of power with the least possible weight, a necessity imposed by bridge and right of way restrictions. It is different in a number of ways from any of its predecessors, some of the minor differences being the increase from 21 to 22½

similar to that used around the windows, is riveted on the outside. The doors are made of wood, the lower portion being panelled, and the top part filled with an 18 in. x 30 in. fixed window. These doors swing inward and are hinged on the side toward the front of the cab. A sliding bolt is used to hold them closed. Long handrails are provided on each side of the doors, and below each door is a set of steps making access to the cab as easy as, if not easier than, with the usual style. It will be noted from the illustrations that one of these door handrails is longer than the other and is curved and carried over the windows parallel to the running board. The arrangement is the same on both sides of the cab and is used in conjunction with the running boards, which extend 3 in. beyond the side of the cab, thereby providing easy access to the front of the engine. The ordinary front door is provided on the left side of the cab, but on the right side the door is reduced to 14 in. x 32¾ in.,

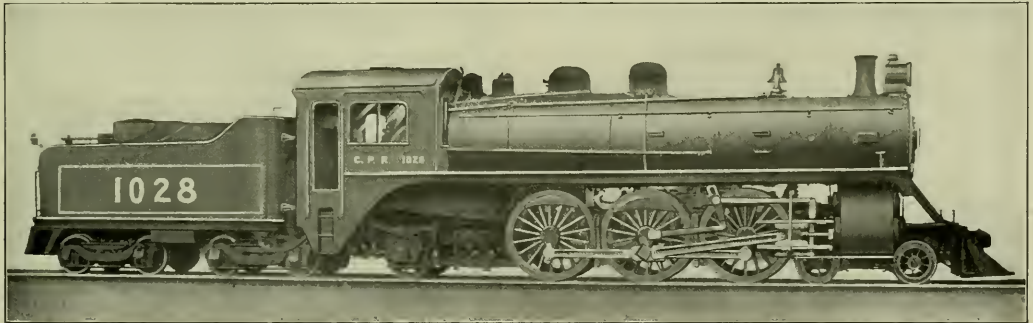

Standard Pacific Type Locomotive with Vestibule Cab; Canadian Pacific.

in. in the diameter of the cylinders, and the use of various vanadium steel parts in order to obtain the necessary strength without increasing the weight. The chief and most evident differences are the use of a vestibule cab and a tender with an integral tank and frame.

On account of the intense and prolonged cold often encountered in the territory traversed by this railway, the problem of protecting the enginemen has always been one of considerable moment. Various experiments were made from time to time until finally a cab was developed that afforded the crew the desired protection. This cab, aptly called the vestibule cab, is so constructed that the space between the engine and tender is completely closed in by a simple, flexible arrangement that affords constant protection regardless of the relative movement between them.

The cab is built of steel throughout, the top and sides being No. 10 I. G. W. steel plates, while the back and front are made of 3/16 in. plate. A noticeable feature is the use of round corners on the front of the cab. These are not only very strong and stiff, but are pleasing to the eye and are in keeping with the symmetrical lines of the cab. On account of the elimination of the open gangway, access to each side of the cab is provided by means of hinged doors located just back of each seat box. The door openings are 22 in. x 75 in., and are reinforced with 1½ in. x 1½ in. angles riveted inside of the cab, while beading,

to permit the screw reverse gear reach rod to pass below it.

In the cab corners, just back of the side doors, are metal lockers which take the place of those ordinarily found on the tender, but which have the advantage of being located where no water can reach them when the tank leaks or overflows. As the space known as the shoveling deck is entirely enclosed, passage from the cab to the tender is possible only through the coal gates or through the sliding window provided for that purpose in the back of the cab. These windows are made large enough for a man to go through them and are located slightly above the top level of the tender. The back window on the right side of the cab is reached by two metal steps, which are hinged to the locker on that side, and can be turned up and held out of the way by small catches. Two handholds are provided, one inside the cab, fastened to the top of the locker, and the other just outside and fastened over the window.

Around the edge of the opening in the back of the cab is riveted a 5/16 in. diaphragm ring, or rubbing plate, similar in appearance to the diaphragm ring on vestibule coaches, except that it is much wider and heavier. Another ring of the same contour is held against the one riveted to the cab by means of four plungers. These plungers are enclosed in pipe cylinders screwed in cast steel guides, which in turn are riveted to the front plates of the tank. Around each plunger is a coil spring to force them forward and keep the two diaphragm

rings in contact. A 3/16 in. plate with an opening cut out to correspond to the opening in the tender coal space is riveted to the tender diaphragm ring. To this plate are hinged, at right angles, two 3/16 in. vertical plates, which are held by means of springs, four to each plate, against the walls of the tender that form the entrance to the coal space. These plates are supported by a specially designed hinge that permits a certain amount of lateral movement when the engine is rounding a curve.

The entire arrangement allows of any regular movement between the engine and the tender, and yet keeps the diaphragm rings against each other and the space in the vestibule enclosed. The top is closed and made weather proof by means of a cover plate riveted to the tender diaphragm plate. This cover plate slides over another plate which forms the top of the entrance to the tender coal space. With the tender full of coal, the open-

butt jointed, is riveted to and made integral with the top cover plate and center sills. To the bottom of the center sills another 1/2 in. plate is riveted. In this manner the foundation of the tank is an exceedingly stiff and strong box girder. The sides and back are constructed of 1/4 in. plate, in the ordinary manner, the front walls being made of 5/16 in. plate. The sides are supported and held together by 1/4 in. plate stays, some of which are the full height of the tank for its full width, passage for the water being provided either by holes or by the top and



Vestibule Cab and Front End of Tender.

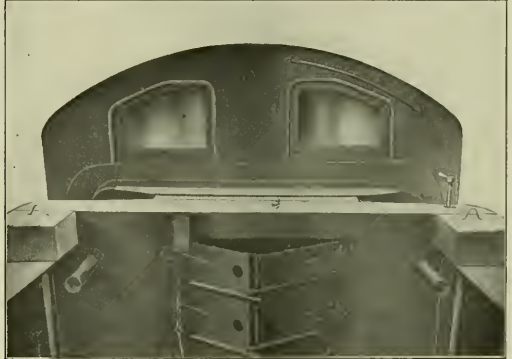

Rear of Cab and Arrangement of Coal Gates; Canadian Pacific.

bottom corners of the plates being cut away. These lateral stay plates are also riveted to angles or tees, which are in turn riveted to the bottom of the tank. Between some of these lateral stays and supporting plates are 1/4 in. plate gussets. Their size and method of fastening to the tank side and bottom is clearly shown in the illustration. Vertical 1/4 in. tie plates form a dividing wall along the center line of the tank. These plates are cut so that the water can pass through or around them and are riveted to angles on the lateral plates. All these

ing through the coal gates is closed and can be kept so by means of the coal pushers with which the tenders are equipped.

That these vestibule cabs are fulfilling all expectations is evinced by the fact that at the present time 9 of them are in service, and others are under construction or have been specified for new locomotives.

The tenders of these locomotives have a coal capacity of 12 tons and a water capacity of 5,000 imperial gallons (equivalent to slightly more than 6,000 U. S. gallons) and are constructed in such a way that the necessity of the ordinary tender underframe is eliminated, the bottom of the tank itself taking the place of the usual underframe. In this design even the use of side sills is unnecessary as the tank is entirely self supporting.

The whole tank is built up with the center sills as its foundation. These sills consist of two 13 in. 37 lb. channels, placed back to back and spaced 26 in. apart, with a 1/2 in. top cover plate 42 in. wide. This cover plate extends the full length of the sills. The bottom of the tank, consisting of three 3/8 in. plates,

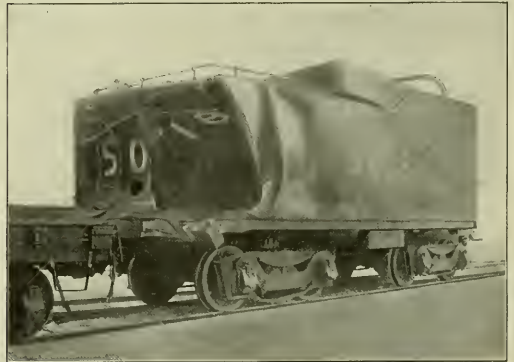

Effect of a Collision on the New Design of Canadian Pacific Tender.

plates and gussets serve the double purpose of supports and swash plates.

The tender male center castings are fastened directly to the box girder center sills and have cast steel side bearer brackets on each side. These brackets are riveted to the center sills and to the tank bottom, and are so located in each case that they are directly beneath one of the lateral stays and supporting plates in order to get the benefit of its resistance when the side bearings come into action. The advantages of this design of tank

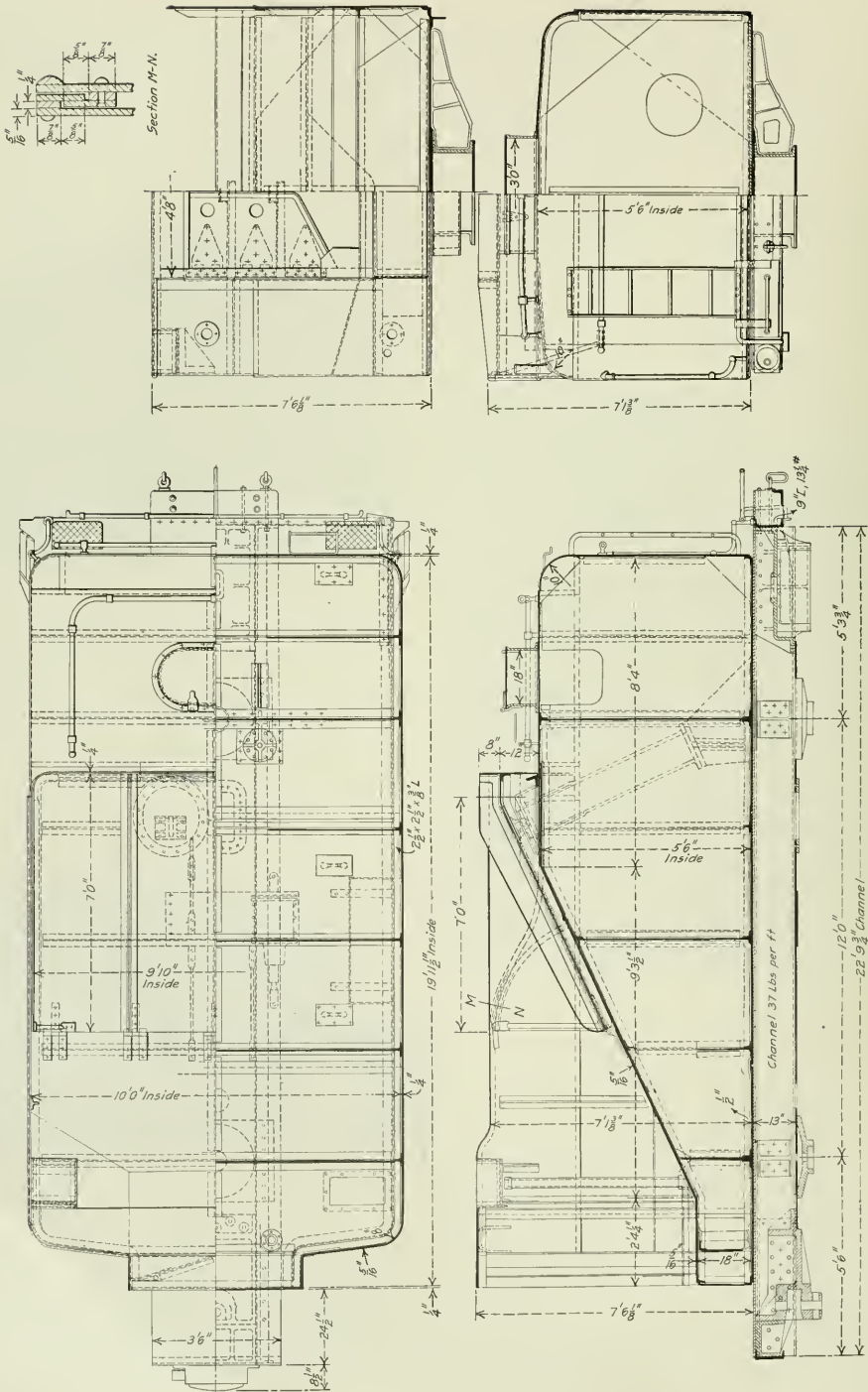

Locomotive Tender with Integral Tank and Underframe Used in Connection with a Vestibule Cab.

are in the fact that it is easy to construct, is stiff and strong, and is a guarantee against any trouble that might be experienced due to the cistern moving on its frame.

These assertions are borne out by one of the illustrations which shows the rear of a tender of this type that was in service behind a large and heavy freight engine in a butting collision. In this case the speed of the trains was very close to 30 miles an hour. It is reasonable to believe that had the usual style of tender, with the tank placed on top of the underframe, been in use, the tank would have slid forward into the engine cab doing great damage. In this instance the cab was injured but little, a few of the plates being slightly bent, the entire shock being absorbed by the front of the engine and the rear of the tender.

The tenders are equipped with air operated coal pushers having two air cylinders, one on each side, with centers 29 in. apart.

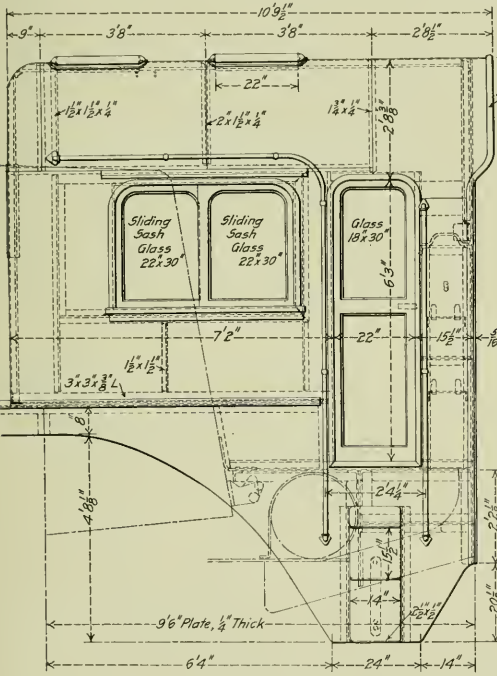

Vestibule Cab for Pacific Type Locomotives on the Canadian Pacific.

The back corners of the tank are curved, which improves the appearance and prevents coal and dirt from accumulating on the top of the tank. The trucks in use are the standard tender pedestal type which give excellent service under the most exacting conditions.

The general appearance of these locomotives is striking. All piping clamped below the running board is concealed by a scarfing that extends back under the cab and is broadened out to make a support for the cab steps. The motion work is compact and the most noticeable feature is the location of the crosshead arm, union link and combination lever. These are all placed inside the guides. The appearance of these locomotives is in direct keeping with their excellent performance. The main driving axle, main crank pin, piston rod and front frame rails are of vanadium steel.

The general dimensions and weights are as follows:

Gage	4 ft. 8 1/2 in.
Service	Passenger
Fuel	Bituminous coal
Tractive effort	32,100 lbs.

Weight in working order	24,500 lbs.
Weight on drivers	147,000 lbs.
Weight on leading truck	41,000 lbs.
Weight on trailing truck	36,500 lbs.
Weight of engine and tender in working order	361,000 lbs.
Wheel base, driving	13 ft. 0 in.
Wheel base, total, engine	33 ft. 7 in.
Wheel base, engine and tender	59 ft. 10 in.

Cylinders.

Cylinders, kind	Simple
Cylinders, diameter and stroke	22 1/2 in. x 28 in.
Valve, kind	Piston
Valve, diameter	1 1/2 in.
Valve, greatest travel	15/16 in.
Valve, outside lap	1/16 in.
Valve, inside clearance	1/16 in.
Valve, lead	5/16 in.
Type of valve gear	Walschaert

Wheels.

Wheels, driving, diameter over tires	37 1/2 in.
Wheels, driving, thickness of tires	3 1/2 in.
Driving wheel journal, diam. diameter and length	9 3/4 in. x 12 in.
Driving wheel journal, others, diameter and length	9 in. x 12 in.
Engine truck wheels, diameter	34 in.

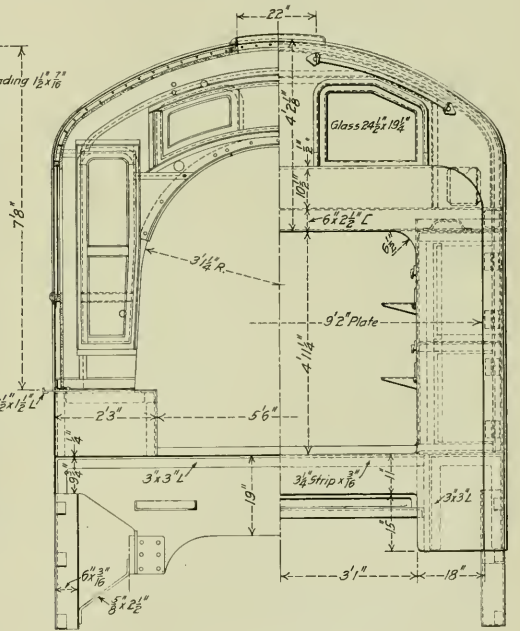

Engine truck journals	6 in. x 11 in.
Trailing truck wheels, diameter	34 in.
Trailing truck journals	7 in. x 14 in.

Boiler.

Boiler, style	Extended wagon top
Boiler, working pressure	200 lbs.
Boiler, outside diameter of first ring	67 3/8 in.
Boiler, outside diameter dome course	75 1/2 in.
Firebox, length and width, inside	7 ft. 10 1/8 in. x 5 ft. 9 7/8 in.
Firebox, plates, thickness	3/8 in. and 1/2 in.
Firebox, water space	5 1/2 in. front, 3 1/2 in. back, 4 1/2 in. side
Tubes, number and outside diameter	18-2 in.; 17 1/2-2 1/4 in.
Flues, number and outside diameter	2-5 1/4 in.
Tubes, thickness and material	No. 11 L. W. G. iron
Flues, thickness and material	No. 8 B. W. G. steel
Length over tube sheets	19 ft. 6 in.
Heating surface, tubes	2,770 sq. ft.
Heating surface, firebox	175 sq. ft.
Total heating surface	2,945 sq. ft.
Superheating surface	539 sq. ft.
Grate area	45.6 sq. ft.
Superheater, kind	Vaughan-Horsley
Center of boiler above rail	9 ft. 4 in.

Tender.

Tender wheels, diameter	36 1/4 in.
Tender journals, diameter and length	5 1/2 in. x 10 in.
Water capacity	5,000 imp. gals.
Coal capacity	12 tons

LOCOMOTIVE DECK SHIELDS

BY WALTER R. HEDEMAN.

The shields described are designed to prevent the loss of coal through the large openings in the firing decks of locomotives, and through the openings between the engine and tender. While these openings are necessary for grate shaker brackets, levers, injector feed and overflow pipes, ash-pan blower pipe, etc., the loss of coal through them is considerable and amounts to as

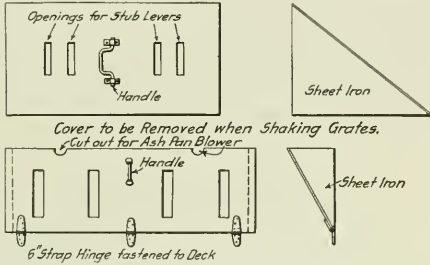

Fig. 1—Early Types of Deck Shields.

much as one and one-half to two bushels of coal each trip on large locomotives in through freight and passenger service. This coal lodges on the foot plate casting, and when this is full it falls to the right of way. When the engine arrives at the ash pit the wasted coal on top of the casting is raked off into the pit and lost. A bushel of soft coal weighs 76 lbs. and if only 50 lbs. a

back head of the boiler. The chief objection to it is that the fireman may feel that it is in the way and throw it off the engine. Another objection is that it does not extend far enough across the deck to cover the openings for pipes on each side of the grate shaker brackets. Both the types shown in Fig. 2 are suitable for locomotives which have the firing deck inside the cab. The lower one is an improvement over the first one described, in that it extends the full width of the firing deck, and is fastened to it by hinges. When the fireman wishes to shake the grates, he throws the shield back and stands on it while using the shaker lever. It is not easy for the fireman to throw this shield away unless he deliberately breaks it from its fastenings.

From the foregoing it would seem that the best shield would be one which could be fastened rigidly in position and would not have to be moved when it is necessary to shake the grates. The shield shown in Fig. 2 meets these conditions admirably, and, in the writer's opinion, is the best type of shield yet devised. With it there can be no accumulation of coal around the grate shaker stub levers, and this in itself will induce the firemen to shake the grates more frequently than he would if there were a mass of coal clogging the levers, making them practically immovable. This shield is made of $\frac{1}{4}$ in. iron and is fitted close to the back head of the boiler. Two separate pieces form the sides, each being fastened to the shield proper with two $\frac{1}{2}$ in. bolts. Three pieces of $\frac{1}{4}$ in. x $1\frac{1}{2}$ in. x $1\frac{1}{2}$ in. angle, 14 in. long, are attached to the bottom of the shield, and the lower flanges are attached to the large angle supporting the deck, with three $\frac{1}{2}$ in. bolts. Slots are cut in the shield for the shaker stub levers to extend through. These slots are male $\frac{1}{8}$ in. wider than the thickness of the stub levers, and of such a length as to

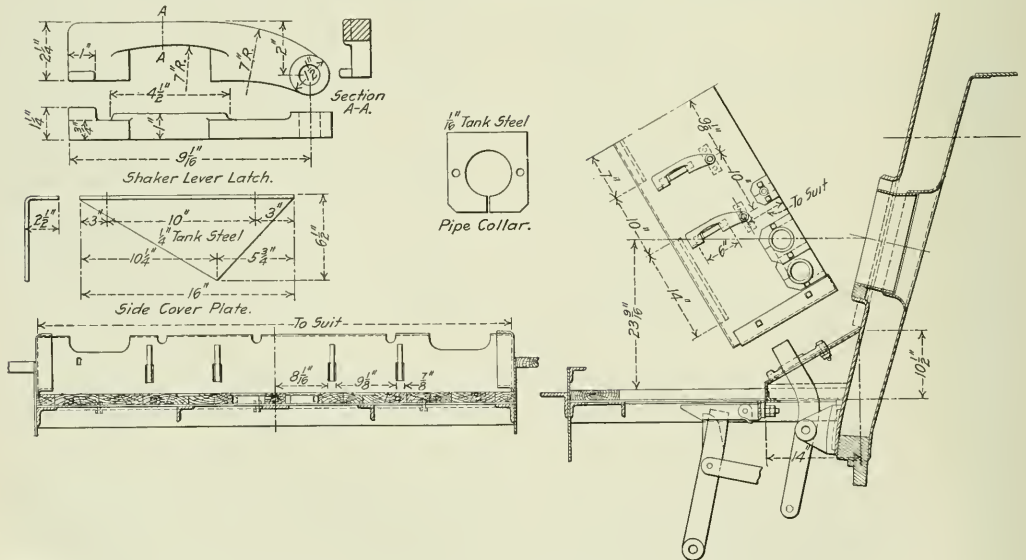

Fig. 2—Deck Shield for Locomotive with Firing Deck Inside of Cab.

day are saved on each of 1,000 locomotives it will amount to 25 tons of coal a day. There is no doubt that without the firing deck shield the loss of coal on locomotives of our large trunk lines is from 25 to 50 tons a day.

The first shield which came to the writer's attention is the upper one shown in Fig. 1. It is nothing more than a simple triangular shaped box, with slots for the grate shaker stub levers, and is placed over the grate shaker brackets against the

permit full movement of the stub when the fireman shakes the grates. The cast steel or malleable iron latch covers this slot when the grates are stationary. The latch pivots on a pin, and the center of the pivot hole is $\frac{5}{8}$ in. off the center line of the stub lever. This is done to keep the latch against the stub lever and prevent it from moving. The top of the shield must be inclined at a sufficient angle to insure the coal rolling off. All the coal will then accumulate at back of shield on the clear floor, and it is

comparatively easy for the fireman to shovel it up. The cab deck can be cut away from the edge of the shield to the back head of the boiler; and the grate shaker brackets do not need any stub lever latches, as the stubs are held by the latches on top of the shield. If any washout plugs are covered up, it is easy to move the shield by taking out the three 1/2 in. bolts securing it to the cab deck. Openings sufficiently large to permit all piping to pass through the shield are cut in it, and pipe collars like those shown in the illustration are made to fit neatly around each pipe. These shields will also help to keep the cabs warm in the winter.

The latch used with the shield has the jaws cut at a right angle with the bottom of the latch. This is because the stub levers come through the top of the shield at this angle. Another arrangement of latch has the jaws cut at a sharp angle to accommodate stubs which do not come through the shield at a right angle. In this case if the shield had been set at a right angle to the stub levers, the top would have been so flat that the coal would not roll off. The stub levers must extend far enough through the shield to permit of the application of the shaking lever without moving the latch. The stub lever latches do not all move in the same direction, like those shown in Fig. 2, because of the closeness of the stub levers; and in such cases it is necessary to make right and left hand patterns for the latches. The shields are made to extend from the back head of the boiler to

The lug on the hinge end of the latch is to prevent its falling down out of the fireman's reach.

For deckless locomotives, or those where the fireman stands on the tender when firing, another type of shield is necessary. An arrangement for engines with the Wootten type of firebox is shown in Fig. 4. This shield extends the full width of the back head, and is fastened to it with five wrought iron brackets. The apron is fastened to the lower part of the shield by hinges. It will be noted that the apron extends under the shield 1 in. and has the inner edge flared up. With this arrangement it is practically impossible for any loss of coal between the engine and tender, as all coal dropped by the fireman in firing will find

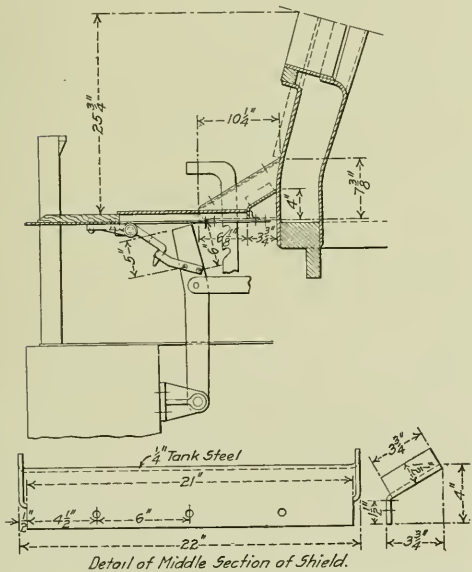

Fig. 3—Deck Shield for Locomotive with Lever Stubs Below the Deck.

the edge of the door opening in the deck for accession to the drop grate lever.

On engines which have shaker levers below the cab deck, a shield such as the one shown in Fig. 3 can be used with excellent results. This shield is made in three sections, as the deck openings extend so close to the back head that it is necessary to make the middle section of the shield more shallow than the side sections, in order not to cover up the doors in the deck. It will be noted that a different arrangement of latching is used in this case. This is because the stub levers are entirely below the deck flooring. The latch is hinged to the under side of the deck, and a catch is fastened to the stub lever in which the latch engages.

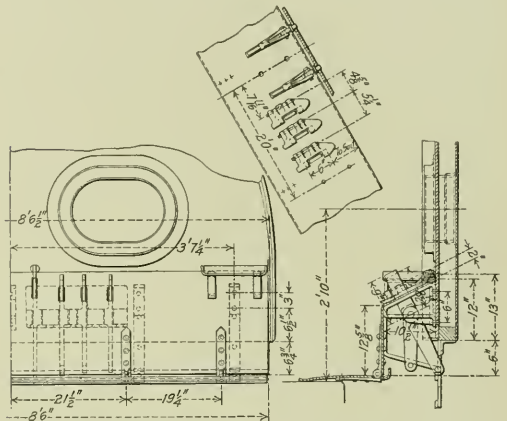

Fig. 4—Deck Shield for Locomotive with Wootten Type Boiler.

its way back to the apron, and can very easily be shoveled into the firebox from there. The latches used with this shield are entirely different from those previously described, in that they are hinged to the shield instead of being pivoted to it. This style of latch is necessary on account of there being so many stub levers close together, so that there is not room to use the pivoted latch. The fireman's step from the tender to the running board is fastened to the shield, but must be located so as to clear the fire door operating mechanism.

That these shields effect a considerable saving is evidenced by the fact that they are being put on one thousand locomotives on the Baltimore & Ohio system and will eventually be applied to all of them.

COAL SAVING ON THE LEHIGH VALLEY.—The effect of the educational campaign among the firemen on the Lehigh Valley is bearing concrete results, and the records for the last six months of the year 1912 showed a net decrease of 5 per cent. in the amount of coal used per ton-mile as compared with the same period of the previous year.

NEW LINE FOR INDIA.—The Indian railway board has accorded its sanction to a survey being carried out by the Bombay, Baroda & Central India Railway for a line on the 5 ft. 6 in. gage from Gangapur, on the Nagda-Wertha section of the Bombay, Baroda & Central India Railway, to Luni, on the Jodhpur-Bikaner Railway, a distance of about 260 miles.

SOUTH AUSTRALIAN RAILWAYS.—Railways were early in starting in South Australia, the first one, between Adelaide and Port Adelaide, being opened in 1856, with the Victorian gage of 5 ft. 3 in., which was continued on the main lines connecting with Victoria, and extending northwards from Adelaide as far as Terowie. The state later adopted the 3 ft. 6 in. gage.

FORMS FOR LOCOMOTIVE OPERATION AND COST

Comprehensive Office Records That Give a True Index of Shop and Roundhouse Conditions

BY A. V. HECKMAN

The value of a locomotive from the standpoint of service or efficiency has been very fully worked out, and it is further definitely known what the average design is capable of producing after the designers have been furnished with data as to the grades, alinement, allowable weights, service, etc. There are some roads on which it would seem economical to consider larger units and larger and more powerful designs, while on others the density of traffic suggests the adherence to accepted types and capacities. On the latter roads efforts might be directed to the consideration of refinements of operation for further economies. In either event, though possibly more definite in the latter case, there becomes necessary an analysis of details of the cost of maintenance which a systematic record will greatly simplify.

The primary object of the compilation of any such data would necessarily be to show concisely the sources of expense, and in such a way that the officer in charge might be able, in the least amount of time, to secure a comprehensive idea of the entire situation and obtain a fair knowledge of comparisons of costs of operation in a sufficiently tangible shape to allow him to readily make his deductions and incidentally direct any further research in a general way, or along any particular lines he might desire. In other words, it is the measure of what is transpiring that must be definitely known before intelligent and effective steps towards future improvement may be most profitably conducted. It is obvious that when an officer has data before him in complete form enabling him to place his finger on leakages or on certain avenues of expenses which are apparently getting out of line, not only is a great deal of time saved, but deductions must necessarily be more accurate and, if the further work is effective, economy must follow.

In considering locomotive maintenance we find in the final cost not only the actual labor and material expended, but credits for scrap and other accounts, besides further adjustments which are usually made after the accounts reach the comptroller. There is nothing more confusing than reviewing such data when large uncontrollable adjustments are known to exist. The exclusion of such charges is manifestly the first requirement in any analysis in order to reduce the data to amounts more readily explainable from the shop records.

Take the material account for locomotive repairs alone, with the idea of following it through before the adjustments are made. It is obvious this can best be done by getting a report from the shops at the end of the month showing the total cost of material used on locomotives. Posting this information by shops it can be readily seen how the items are running and it will make possible a comparison for similar items for other periods. By the transmission of this data to the foreman and sub-foreman, showing them in detail the total amounts they are actually spending per month, they are enabled to check their daily issues which are furnished them currently.

Interest in the use of material can be stimulated by the daily issue of memoranda statements showing each individual foreman what his department has drawn. Closely checking the daily expenditures in turn stimulates the checking of reports and encourages suggestions for alterations in the design of parts failing in service, adding still further to economy in the aggregate cost of maintenance. A tabulation

of such parts failing in service can be kept in such a way that it, like the expense figures, will quickly suggest what remedies might be speedily and profitably applied.

In the same way records posted monthly showing the total number flues renewed, the amount of metallic packing consumed, water gage glasses used, and several other items, enables those directly responsible to easily see how the consumption is running, which might or might not also suggest remedies or controlment of leakages. Comprehensive statements showing the parts failing in service, total material used, and the separation of the details, as well as a monthly record of the service of flues, tires, broken frames, cylinders, firebox sheets, etc., as will be hereafter referred to, enables the office force to show, and in a concise way, the exact items influencing the net cost.

The cost of labor entering into locomotive maintenance must, of course, be closely checked and while this can be done in a general way, it is necessary to separate or to keep a record as much in detail as possible to better illustrate what might be done to bring about improved results. By keeping a separate monthly statement showing the expense chargeable to boiler work, and at the same time running records showing the labor expense in other directions, such as boiler washing, etc., as well as information showing the number and per cent. of engines leaking on arrival at terminals, a complete record is at hand to show the main items entering in the final cost. In addition it helps to furnish a better idea of the physical condition of the power.

There are other accounts, aside from locomotive maintenance, of equal interest and none the less important, a principal one being the item of handling engines. This is an expenditure for which the railroads get practically no return. The labor spent in turning an engine can properly be termed non-producing, since the time so expended, outside of actual repair work does not put the engine in any better physical condition. Still it must be done. It is not, however, the intention to refer to this particular phase of the subject. On the contrary an attempt is only being made to analyze special records of some of the important items of cost and operation expressed under the head of performance of engines, as will be hereafter explained.

The number of flues renewed in engines is a prominent item contributing to the cost of locomotive repairs, and a record of this posted by shops, with a similar record showing the number of lineal feet of such material purchased gives exact knowledge of the conditions in this particular. Being able to also see from the records, either monthly or weekly, the number of sets of tires turned or renewed, also assists in following another important amount entering the maintenance figures.

In the absence of records to show running as well as classified repairs chargeable to individual locomotives, a close analysis can be made of the classified repairs, which figure in the total is subtracted from the net figure, which will represent the running repairs as a total for all engines. The cost of running repairs is not calculated for individual engines principally on account of the difficulty of getting accurate information. Besides it has been claimed that to a great extent the character of running repairs is much the same and that no real information of value is obtained from the records showing the cost of turning engines.

Leaving for the moment the cost of labor and material the desire would be to show concisely what work is being done on engines in the way of classified repairs, the service obtained from various items on a mileage basis, or however it is desired to show the figures for comparison. To be able to analyze the service of such parts of an engine as the flues, tires, frames, cylinders, firebox sheets, etc., it is obviously necessary that the records be arranged on that basis. On account of the volume of such work on a large road the records covering the data have to be carried out in a systematic way. This can be readily accomplished by the use of certain symbols or nomenclature, and to cover this particular phase of the office record a classification of repairs is used of such a character as to give a fairly complete idea of the magnitude of the work.

Some critics have pointed out the futility of keeping even such important records, the theory being that it is more economical to work up such data when necessary, or when wanted, rather than to keep it currently. In most cases, however, the author believes such data is of the greatest value when it is kept currently. Often times a classification, unless it is very simple in its form, impresses the average shop man and sometimes the officer, as unnecessary. In the absence of fairly complete symbols to indicate the character of repairs the object of brevity is often defeated by the unnecessary use of written explanations, sometimes covering several lines to illustrate what might quite as well be covered by symbols.

A classification of repairs may be built up without digressing far from the old conventional symbols; *viz.* 1, 2 and 3, which have been generally used to represent heavy repairs, firebox work and general overhauling. By going a step further, however, and employing certain suggestive prefixes and suffixes to represent the renewal or repairs of most of the important parts, those of interest in the analysis of the records can be taken care of. Such a classification is as follows:

What is known as No. 1 repairs covers rebuilding of the engine. No. 2, which under the former classification refers to firebox renewals, is used as the initial figure indicating that class of repairs, but in order to show the number of firebox sheets renewed, be it one, two, three or four, the letter and figure S-1, S-2, S-3 and S-4 are attached to the initial figure 2, representing respectively the number of sheets renewed. When the entire firebox is renewed it naturally brings it back to the initial figure 2. No. 3 is used to represent a general overhauling, carrying with it a full set of flues, tires, heavy repairs to machinery and firebox patch work, the same as the old classification, and much the same as is generally used throughout the country. No. 4 covers medium heavy repairs or renewals to machinery, boiler, etc., and No. 5 refers to light repairs to machinery, etc., or work too heavy to be classed as ordinary roundhouse or 24-hour repairs.

Around these five original figures are built up a series of prefixes and suffixes which materially assist in showing the repairs or renewals of certain parts. For instance, the prefix 1 is used with class 4 and 5 repairs to represent the renewal of an entire set of flues, and this prefix is only used with these two classes of repairs, because when classes 1, 2 and 3 are used, they carry with them the renewal of a set of flues. Prefix A is added to represent any accident to the engine, comprising the failure of any part of the machinery including damage on account of low water. This prefix is used with all classes of repairs. Prefix B is added to any of the classifications to represent the welding or repairing of one or more broken frames and prefix W to represent repairs on account of wrecks, collisions and derailments.

Suffix F represents the renewal of a front flue sheet and this is added to any class of repairs, except No. 1. Suffix T represents the renewal or turning of an entire set of tires,

but this is used only with class 4 and 5 repairs, since repairs under classifications 1, 2 and 3, carry with them a set of tires. Suffix C is added to any of the classifications, except No. 1, to cover the renewal of one cylinder and suffix E is used in the same way to represent the renewal of two cylinders. This latter letter may be termed the evolution of two C's, still remaining a rather suggestive symbol for the repairs it indicates. Where cylinders on Mallet engines are renewed, and there are more than two applied, the symbols CE are used to represent three cylinders and EE to cover four cylinders renewed.

In addition to the prefixes and suffixes mentioned, the total number of flues renewed, where it is less than a full set, are shown with the class of repairs given the engine. Full sets are taken care of by prefix 1 as above referred to and under class 1, 2 and 3 repairs. The strict adherence to the classification symbols to describe the amount of work done, makes the use of any monetary basis unnecessary, besides the symbols will show very closely the items entering the class of repairs, which is the information desired, whereas the monetary plan or any such limit to indicate the class of repairs vitiates the principal reason for the classification of the work.

By the use of this classification the shop can send in a weekly schedule of engines undergoing repairs, as well as those to be turned out during the succeeding week, showing briefly opposite each engine number the class of repairs it is receiving. A schedule thus prepared gives the officer in charge an opportunity to readily see, from week to week, or for any period desired, not only the number of fireboxes under repairs or completed, but the number of sheets as well, in addition to the number of flues applied during the week the number of engines in shop for broken frames, sets of tires, cylinders, wreck and accident repairs, front flue sheets, etc.

The traveling engineer, after checking with the roundhouse foreman, is also able by the use of this classification to show on his monthly report of condition of power the engines he regards as candidates for the shop, as well as the probable service those soon to be shopped might give. In order to have this information prepared in such a way as to be of the most benefit the report from the traveling engineer is gone over after it reaches the division office and all engines shown thereon as candidates for the shop are posted on a separate sheet with the repairs required and the mileage they have made since the last repairs. The sheet known as an "Abstract of the traveling engineer's report," is immediately returned to him, also to the roundhouse foreman so that they can readily see what engines have been marked as candidates for the shop and the mileage they have made, either as a whole, or the mileage for tires, flues, fireboxes, etc. This gives all concerned a very good idea of the probable work ahead for the next month and at the same time indicates the engines requiring the closest attention, as well as those which for some reason have made comparatively low mileage.

Going back again to the office records. As the usual reports are sent in by the shops monthly showing the engines turned out after receiving classified repairs, with the repairs shown under the symbols in use, the next step is the posting of such data on a card record in the office, which card carries the headings shown in Fig. 1.

There is one of these cards for each individual engine and the information under the various headings is posted monthly, or as the engine receives classified repairs. In the first column is shown the month and year beginning with the time the engine is received new from the builders and in the next column the monthly mileage. These two columns and the third in which the monthly mileage is accumulated are posted each month. When an engine receives classified repairs, all the necessary data called for on the card under this heading is posted.

The mileage in the third column is accumulated until the engine is credited with a class 4 or heavier repairs. When such repairs are entered on the card the mileage in the third column is stopped and started new, accumulating until the next class 4 or heavier repairs is recorded, when it is again closed, and so on. In this way the card will show at a glance

in the preceding column are always included. Under flue mileage is posted the number of flues renewed and this added to the previous total is shown in the next column, giving the total number of flues renewed to date. This total is then divided into the total mileage made by the engine to date, which gives the miles run per flue renewed, or in other words

PERIOD	MONTHLY MILEAGE	TOTAL MILEAGE	COST OF CLASSIFIED REPAIRS							
			SHOP	DATE IN SHOP	DATE OUT SHOP	CLASS	LABOR	MATERIAL	TOTAL	

Fig. 1—Record of Cost of Repairs for Individual Locomotives.

the mileage each individual engine is making between general overhauling or between class 4 repairs. From this card the roundhouse sheet, or abstract of the traveling engineer's report, above referred to, or the mileage information for each engine can be very readily posted. From this card also the mileage between the renewal of any of the parts covered by the prefixes and suffixes can be quickly figured out by simply taking the mileage between the desired dates or periods.

the number of miles made by each flue repieced or reset. In the next column is shown the number of flues previously renewed. If a part set, the total number is shown and if a full set the word, all, is used. In the next column is shown the number of flues renewed for the particular class of repairs being carried through. Next is shown the mileage between the two figures representing flues, just referred to. If the engine has received a full set of flues the mileage under that heading is computed from the card and entered. After

After the card record is posted for one month, the record

MONTH AND YEAR	CLASSIFIED REPAIR MILEAGE		FLUE		MILEAGE				MILEAGE BETWEEN FULL SETS OF TIRES RENEWED OR TURNED	DIV.	SERVICE	REMARKS
	REPAIRS	COST	INTER-MEDIATE MILEAGE	MILEAGE BETWEEN CLASS 4 REPAIRS OR BETTER INCLUDES INTERM. MILEAGE	NO. FLUES RENEWED	TOTAL NO. FLUES RENEWED	MILES RUN PER FLUE RENEWED	FLUE RENEWALS				

Fig. 2—Detailed Record of Mileage for Individual Locomotives.

is partly transferred to a tracing which gives the information almost the same as on the card except that it more clearly shows the mileage made between flues, tires, etc., without figuring it from the card record. The tracing, of which there is one for each engine is made up of the headings given in Fig. 2, and is ruled to last approximately ten years.

this the column calling for tire mileage is posted. If tires were renewed or turned the record is posted to show the mileage made since the last time tires were turned or renewed. The last two columns show the division on which the engine has been running, record of transfers, also the class of service in which the engine has been used prior to coming to the shop.

This tracing, which is posted only as classified repairs are entered on the card record, is made by transferring to the

It will be seen that by glancing down the various columns,

MONTH AND YEAR	NO. OF ENGS. IN STOCK	MONTHLY MILEAGE	TOTAL MILEAGE	RECORD OF CLASSIFIED REPAIRS											FRAME MILEAGE		
				NO. OF CLASS REPAIRS MONTHLY					TOTAL COST OF CLASSIFIED REPAIRS	AVERAGE MILEAGE BETWEEN CLASS 4 OR HEAVIER REPAIRS	NUMBER ACCIDENT AND WRECK REPAIRS	NO. OF BROKEN FRAMES	AVERAGE MILEAGE BETWEEN BROKEN FRAMES				
				1	2	2-5	2-52	2-53						2-54	3	4	1-4

CYLINDER MILEAGE			FLUE MILEAGE					TIRE MILEAGE		FIREBOX SHEET MILEAGE					REMARKS
NO. OF ENGS. REC.	NO. OF ENGS. REC.	AVERAGE MILEAGE BETWEEN RENEWALS	NO. OF FULL SETS RENEWED	NO. OF PART SETS RENEWED	TOTAL NO. OF FLUES RENEWED	MILES RUN PER FLUE RENEWED	AVERAGE MILEAGE BETWEEN FULL SETS OF FLUES	NO. OF FULL SETS REN. OR TURN.	AVERAGE MILEAGE BETWEEN FULL SETS	NO. OF RENEWALS	NO. OF RENEWALS	TOTAL NO. OF ENGS. BETWEEN RENEWALS	AVERAGE MILEAGE BETWEEN RENEWALS		
1	2	CYL. CYL. CYLINDER													

Fig. 3—Record for All Locomotives in Each Class.

first three columns on the tracing, the month and year, class of repairs and total cost. The column headed, intermediate mileage, is used only to show the mileage between class 5 repairs, since the next column covers the mileage made between class 4 or heavier repairs. In this the mileage figures

the mileage made by the several items mentioned can be very easily ascertained, and if any one item shows a poor performance, or the engine generally is making low mileage on tires or flues, blue prints are sent out to the traveling engineer and the roundhouse foremen for their information.

circulation, that the water will be driven away from the inner side of the tubes, as at *c c c* of Fig. 2, by the rising bubbles of steam." The practice of this road is, therefore, to be sure that the proper water level is maintained, and also to use care to see that no scale collects on the inside of the tubes.

The difficulty of leaky foundation rings is apparently due to the design, which originally was as shown in Fig. 3, the leaking taking place at the two side flanges. The change of structure to that shown in Fig. 4 entirely corrected the trouble.

Mr. Noltein states that it must further be recognized that the Brotan boiler has another weak point, which in spite of its economical operation, does not permit it to appear as quite the equal of the old boiler construction, and that is the difficulty of removing the water tubes. This feature causes much delay in service. He states further that there is no doubt that the boiler tubes and superheater flues show a greater inclination to leak in the Brotan boiler than is the case in the ordinary construction. This seems to be due largely to the fact that both tube sheets are riveted to the shell and it has been the practice to make the back sheet very thick for the purpose of insuring a longer life. In some cases, this sheet has been made of plate 1 in. in thickness. On the latest boilers a $\frac{3}{8}$ in. sheet has been specified, and it is expected that this will greatly reduce the trouble from leaky tubes. In addition to the thinner tube sheets in the latest boilers, the fire tubes are fitted with the Pogony-Lahmann corrugated ends and the superheater flues are bent about 2 in. out of line before being put in the boiler so as to give an increased flexibility. Mr. Noltein says that the greatest amount of difficulty from leaky flues has been in the oil burning locomotives. This is ascribed to the presence of the brick wall which stores up a large amount of heat and remains hot for a much longer time than the other parts of the boiler, causing an unequal expansion. This, taken in connection with the fact that the superheater dampers are closed, shutting off the circulation of hot air through these flues while it is permitted in the tubes is believed to account for part of the difficulty. It was found many years ago on this road that when the orders to close the stack dampers as soon as the engines were put in the engine house, were in effect, the trouble with leaky tubes greatly increased, but later when the dampers were left open, the trouble largely disappeared. It is felt that the superheater damper occupies a similar status and the practice now is to keep these dampers open while the engines are in the engine house.

It is not felt that any of these difficulties are serious enough to offset the increased efficiency of this type of boiler and there appears to be no inclination on the part of the technical staff to discontinue its use.

EXPERIMENTAL ELECTRIC LOCOMOTIVES IN FRANCE

Plans have been completed for the electrification of a large portion of the Chemin de Fer du Midi, and one section of about 24 miles having very steep grades has been worked with electricity for the past two years. In electrifying another section of about 28½ miles where the grades do not exceed 2.2 per cent., the average grade being 1.7 per cent., it was decided to prepare broad specifications for electric locomotives and submit them to the various builders who would be requested to prepare their own designs. In response to this, six locomotives from as many builders have been submitted for trial and three have been accepted. Fully illustrated descriptions of this motive power have appeared in recent issues of the *Engineer* of London, and the following information is taken from that source.

This company has adopted the single phase system and the current at the trolley has a pressure of 13,000 volts. The specifications require that the locomotive shall be capable of starting and hauling a train weighing about 450 tons behind the

tender on a 2.4 per cent. grade. With a train weighing about 310 tons behind the tender the locomotive shall be able to attain a speed of 25 miles an hour, and with a load of about 112 tons it shall attain a speed of 37 miles an hour on this grade. It is furthermore required that the motors shall be capable of sending current back into the line and of being regulated at will, so that half the normal speed can be obtained on $\frac{1}{2}$ down grade if desired. It is further specified that when operating at the normal voltage each of the motors shall give 600 horse power without the temperature rising above 75 deg. C. (167 deg. F.) after a period of six hours. They are also to give a 25 per cent. overload for one hour without the temperature rise exceeding this limit. The motors are to be capable of carrying the current corresponding to the following tractive efforts, 27,500 lbs. at the start, 17,600 lbs. at a speed of 28 miles per hour, and 9,200 lbs. at a speed of 37 miles per hour. Rigid restrictions are also imposed with regard to commutation.

Of the three locomotives accepted after trial one was built by the Thomson-Houston Company of France, another by the French Westinghouse Company, and the third by the Jeumont Electric Construction Company. Each of these is designed on entirely different lines and indicates the present successful arrangement for single phase electric locomotives.

The locomotive furnished by the Westinghouse Company employs two motors of 600 horse power each. Each motor is connected on both sides by a reduction gearing to an intermediate shaft located directly below the motor. Crank pins on the large gear wheels are connected to a yoke which also engages the crank pin on the center of the three driving wheels. Side rods connect the yoke with the other two drivers. The locomotives are of the 2-6-2 type and have driving wheels about 47 in. in diameter. The ratio of the gearing between the motors and the intermediate shafts is 45 to 74. A separate transformer is employed for each motor. Both the motors and transformers are of the forced ventilated type and the Westinghouse electro-pneumatic system of control is used. The motors are of the series compensated type. The transformers are arranged so that the maximum pressure at the terminals of the motors is 420 volts. These locomotives have a total weight of about 91 tons, of which the electric equipment weighs 48 tons.

It will be noted that the specifications required that the motors return current to the line when coasting down grade and these locomotives were at first designed in accordance with that requirement, and the braking action was obtained by separately exciting one of the motors and obtaining exciting current for the other from the first. The armature of the second motor was then connected to its transformer, and in this way current was sent back into the line. This scheme, however, introduced much complication and another system of electric braking is now being used. This consists of inserting resistances in the transformer circuits and has proved very satisfactory, so far as braking is concerned, although of course no current is returned to the line. Experience has shown that the regenerating arrangement is liable to prove a source of trouble at the generating station unless at least two locomotives are on the line, and one of them is using power. The present system with resistances, however, is without serious objection. Tests of this locomotive on a 1.7 per cent. grade, with a train of 310 tons requiring a tractive effort of 13,400 lbs. showed them to be capable of attaining a speed of 26 miles an hour. The draw bar horse power was 950, the voltage 11,000, amperage 100, and the kilowatts 970 on this run. The efficiency of the machine was 72.4 per cent. With a train of 112 tons a speed of 38½ miles an hour was obtained, the drawbar horse power being 540.

The locomotive built by the French Thomson-Houston Company also employs two 600 horse power motors which, however, are of the slow speed type and drive the wheels through the

medium of side rods without gearing. They are in this respect similar to the Pennsylvania locomotives, except that both motors are mounted on one locomotive unit. The side rods from the armature shaft connect to jack shafts located on a line with, and outside of the driving axles. These carry the counter balance weights and are connected to the three pairs of drivers by the side rods. This locomotive is also of the 2-6-2 type. The main rods are inclined at the greatest possible angle, the motors being placed close together at the center of the locomotive, and it is stated that the center of gravity of the machine is about the same as on a steam locomotive. But one transformer is employed.

The motors in this case are started as repulsion machines, and when starting, the brushes are short circuited and the current is supplied to the stator terminals. After the motor has attained synchronous speed the armature is connected in series with the field winding. In order to secure satisfactory commutation the motors are provided with twenty poles and the synchronous speed as a repulsion machine is 100 r. p. m., which corresponds to 15½ miles per hour. When the armatures are connected in series with the field windings the maximum speed of the locomotive is 48½ miles per hour.

The transformer is of the air cooled type, and its secondary has seven taps giving voltages ranging from 260 to 720. There is also a 100 volt circuit which supplies current to the motor driving the blower and a 320 volt circuit for the compressor motor.

This locomotive is arranged to return current to the line when running down grade and using the motors as brakes. The greatest difficulty in design for this purpose was to prevent the motors generating direct current. This was overcome by interposing a series transformer in the braking circuit, the primary of which is connected to the main excitation fields, and the secondary to a circuit including the armature and commutation windings. It has been found by experience that the regenerating energy on a given grade may be as much as 40 to 45 per cent. of the power absorbed in ascending the grade.

The locomotives built by the *Ateliers de Constructions Electriques du Nord et de l'Est* (Jeumont) is possibly the most interesting of the three. It is also of the 2-6-2 type, but has three independent 500 horse power single phase motors mounted directly above each of the driving axles. There are no connecting rods between the drivers and the frames are outside of the wheels. Each motor is connected to its driver by means of a reduction gearing with a ratio of 1 to 2.72. The large gear is part of a quill surrounding the axle and connected to the wheel centers by means of elastic universal couplings. The locomotive is 41 ft. 4 in. in length over the body and 46 ft. 11 in. long over the buffers. It has a weight of 86 metric tons, the weight on each driving axle being 18 tons. The driving wheels are 4 ft. 7 in. in diameter. The motors are 230 volt series-connected self-cooling type, and give 500 horse power at 450 r. p. m. It is stated that the efficiency, including the gearing losses is 87 per cent. under full load conditions, with a 93 per cent. power factor. When developing 400 horse power per motor the efficiency is 88 per cent., and the power factor 95 per cent. The center of gravity of the machine is 5 ft. 11 in. above the rail.

There are two 750 kilowatt air cooled transformers with primaries connected in parallel and the secondaries in series. An induction regulator is mounted on the upper yoke of each transformer and serves to change the pressure at the terminals of the three motors. This constitutes one of the novel arrangements of this design. The regulators are of the single phase type and are connected in series with the transformers. The voltage they produce is either added to or subtracted from the pressure of the transformers, and by this means a pressure ranging between 200 volts and 760 volts can be obtained, the change taking place in a uniform manner. With this

system the large number of contactors are not required, and there is no necessity of using taps on the secondary side of the transformer.

The fields or stators of the induction regulators are magnetized by the windings of the transformer, and there is a short circuit connection on two points of the rotating element at 90 deg. from the feeding point for the purpose of annulling the inductive drop. The rotor of each induction regulator is moved by means of a small motor mounted on top of the regulator and driving through two reduction gears.

Although the main driving motors are of the compensated series type they are used as repulsion machines when starting. The stator carries three windings consisting of a main series winding, a compensating winding and another winding for assisting commutation. The two latter are placed in the same slots and for series running are connected in parallel. They, however, have a different number of turns and a different cross section of copper. These windings are displaced 90 electrical degrees from the main winding, but the compensating current is proportional to the working current. One object of working the motors as repulsion machines at low speeds is that the commutation is more satisfactory and an excellent starting torque can be secured when operating in this way. The commutation windings are not connected in parallel when the motors are operating in this way, but one winding is disconnected from the other and these three windings, one on each of the motors, are then connected in parallel. The result of this is that all the motors are compelled to run at equal speeds. If one has a tendency to run faster than the others a higher pressure is produced in the winding which is connected in parallel with the field windings of the other motors, consequently a current is set up in these windings which tends to increase the speed of the other motors and to reduce the speed of the machine which is running too fast. It is this arrangement which has obviated the necessity of using side rods. When the motors are working at higher speeds they are all connected in series.

These locomotives are arranged for returning current to the line when running down hill, although at the expense of a considerable complication of electrical equipment.

All of the controlling operations are effected by means of small auxiliary motors which are in turn governed by a low tension circuit from a small two cylinder controller at either end of the locomotive. Signal lamps in each operator's compartment indicate the positions of the various controlling devices. There is also a foot operated switch which is used, in connection with the positions of the controller handle, to effect the repulsion connection of the motors. This switch is used only during starting and should it be held too long there is a centrifugal switch which will throw the motors to the series connection on reaching a speed of 13.6 m. p. h. When the locomotive is regenerating, this switch also serves to break the circuit when the speed drops below 13.6. Eight other locomotives of this design have been ordered.

HOLDING POWER OF SPIKES.—Tests made by the United States Forest Service, by several universities and by a number of railroads show that common square spikes have increased holding power when driven into previously bored holes.

SAFETY APPLIANCES IN PORTO RICO.—The Supreme Court of the United States in a suit for damages against the American Railroad Company of Porto Rico, because of the death of an engineer, holds that the federal safety appliance act applies in Porto Rico.

ELECTRIC RAILROAD ACCIDENTS.—In the Second Public Service District for the State of New York, which does not include New York City, there were 80 persons killed and 2,206 injured by the operation of the electric railways during the calendar year up to December 18, 1912.

SHOP PRACTICE

CRACKED CYLINDER REPAIRED WITH CONCRETE

BY W. P. HUNTLEY,
General Foreman, Chesapeake & Ohio, Ashland, Ky.

In March, 1912, a locomotive came into the shop with a bad crack in the wall of the steam passage in the right cylinder. This crack was high up on the contour of the wall, and in such a

impossible. As an experiment it was decided to fill the cored cavity in the cylinder around the cracked wall with concrete and a 2 1/2 in. hole was drilled in the front wall at the extreme top of the cavity. A wooden cover was fitted across the bottom of the cavity as high up as it could be inserted. A mixture of Portland cement and sand in the proportion of 1 to 1 was made and thoroughly worked to a liquid state, so that it would run easily. About two wheelbarrow loads of this was inserted through the hole, nearly filling the cavity. It was allowed to stand for five days and the engine was again put in service.

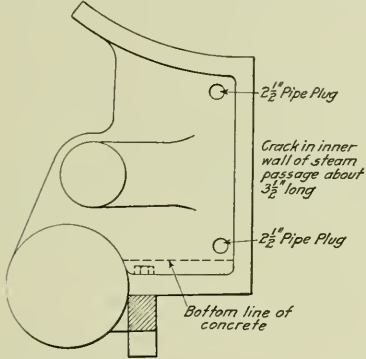

From March 18 to December 5, the locomotive was in regular use with no evidence of leakage. On the latter date it came into the shop for a general overhauling, and a careful inspection showed that the cement was intact and there was no evidence of leaking, and it was decided that it would be unnecessary to renew the cylinder. From January 1 to date the engine has been in through freight service, handling full tonnage, and it appears that by this method, which cost \$2.75 for concrete, sand and labor, results as satisfactory as would have been obtained with a new cylinder are gained. The same method has also been applied to repairs of a similar crack on another locomotive, and appears to be equally satisfactory.

Method of Repairing a Cracked Cylinder with Concrete.

position that it was impossible to weld or patch it, and was of sufficient size to practically make the operation of the locomotive

PUNCHING SPRING PLANKS

BY C. L. DICKERT,
Assistant Master Mechanic, Central of Georgia, Macon, Ga.

Where there are a large number of truck spring planks to be made it has been found best to punch out both the holes and the slot on a hydraulic press. One of the drawings shows a press

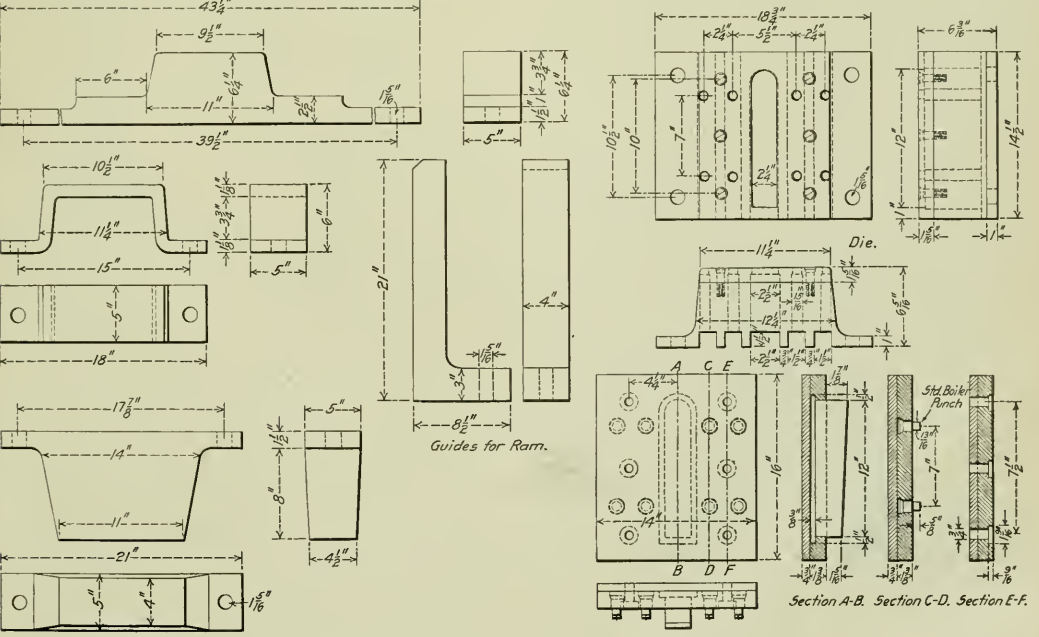

Details of Dies and Supports Used for Punching Spring Planks on a Hydraulic Press.

fitted for that purpose and the other shows the punch and dies. Only one plunger is necessary and as shown in the drawing the front plunger is held down by a bracket or strap. The punch cuts out a slot 2 1/4 in. x 12 in. and punches 8 holes 27-32 in. in diameter at one stroke. The details clearly show the construction of the dies. The guides for the channels are made of

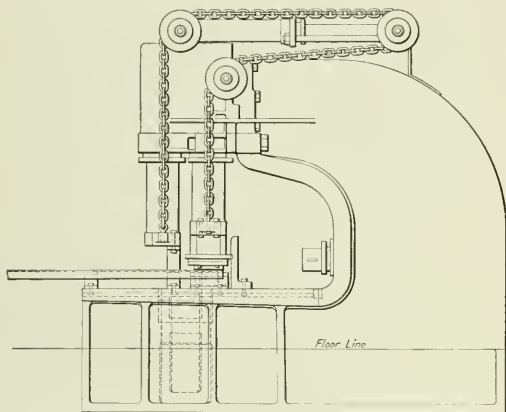

Hydraulic Press Equipped for Punching Spring Planks.

wrought iron and are bolted to the bed of the press as illustrated above. One press operator and two helpers will punch from 60 to 90 spring planks in 9 hours, which is an average of 1,200 holes and 150 slots through 7-16 in. material. No trouble has been experienced in erecting these punched planks as they are interchangeable and match with the holes in the truck sides.

PROTECTING SLIDE VALVE FEED VALVES IN SHIPMENT

BY F. W. BENTLEY, JR.,
Machinist, Chicago & North Western, Haron, S. D.

The slide valve feed valve is a delicate piece of mechanism, and the smallest particle of dust or foreign matter coming in

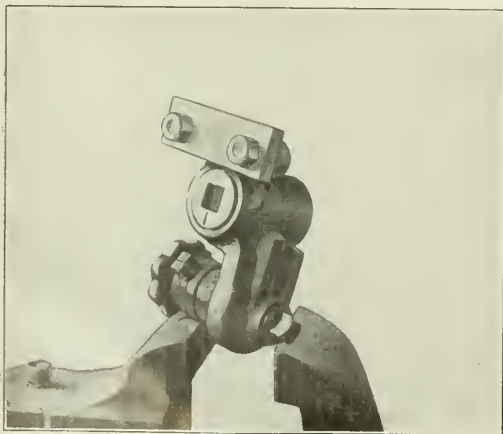

Method of Protecting Slide Valve Feed Valves During Shipment.

contact with any of its sensitive working parts may be sufficient to disorder the valve and cause an engine failure.

The valves are often shipped from a general repair shop to outlying roundhouse points, where such repair work is not usually performed. While being transferred they are in charge of baggagemen and others who know little about their construction, and who take no special precaution to protect them from damage. The illustration shows a method of safeguarding these valves during shipment by means of a strip of 1/2 in. pine, 4 1/2 in. x 1 1/2 in., bolted over the gasket face. A supply of these strips can be kept on hand in the air brake department ready for application to the valve as soon as it comes from the test rack. Only a few seconds are required to remove the block, and it prevents the entrance of any foreign matter through the large air ports.

GRINDING PISTON RINGS IN AIR BRAKE APPARATUS

BY J. A. JESSON,
Louisville & Nashville, Corbin, Ky.

When grinding piston rings in triple valves, air pump governors, etc., it is found that better results may be obtained both in time and workmanship by using a jig that is flexible enough to allow the piston to slide freely and true in its guide. Such a jig is shown in the illustration. Fig. 1 shows the application to a triple valve. One end of the body *A* is split in four sections and has a collar *B*, with four set screws, one for each section. These set screws close the four sections in on the knoh on the end of the piston, holding the jig firmly in posi-

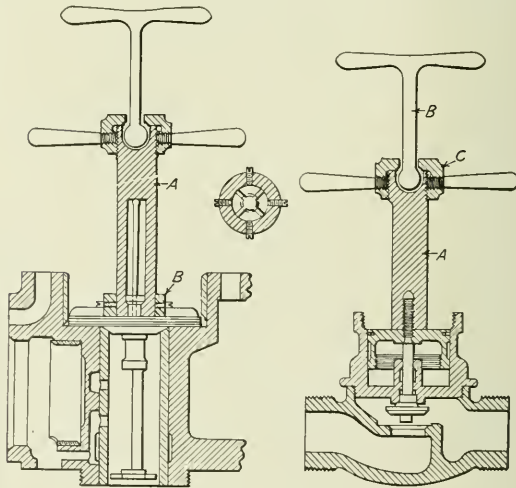

Fig. 1.

Fig. 2.

Jigs Used for Grinding Air Brake Piston Rings.

tion. The other end of the body is cupped out as shown to receive the ball end of the lifting handle. This ball is held in the socket by a nut which screws down over the body *A* and holds two handles for turning the jig. Enough lost motion is provided in the socket to permit of a hammer like blow at the beginning of each stroke which renders the movement easier and more rapid. Fig. 2 shows the application of the jig to a pump governor. In cases such as this, where there is a valve seat to be ground, it can be done in the same operation as the piston rings.

VANADIUM PRODUCTION.—The production of metallic vanadium during 1912 is estimated to be about 300 tons.

A BASIS FOR MEASURING LATHE CAPACITY

The Value of Torque at One Foot Radius Gives a Correct Estimate of the Metal Removing Capacity

BY L. R. POMEROY

In most cases the best lathe of any selected size is the one which will remove the largest amount of metal, or take the heaviest cut on all diameters of work up to its maximum swing. To make a fair comparison it is necessary to select some particular material, such as mild steel, and to assume a certain quality of tool steel which it is known will stand a certain pressure per square inch on the tool point. Further, it is necessary to select a desirable cutting speed and to assume a certain pull or tension per inch width of the driving belt. Having selected these conditions, which will be equal for the two machines, it is possible to get exact knowledge of the capacities of the headstock by means of a comparison of the spindle speeds and torques actually obtainable in each.

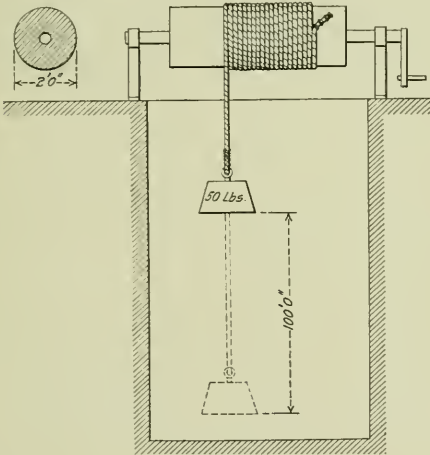

Fig. 1.

As a basis for comparison the methods devised by Dr. J. T. Nicolson, of Manchester, England, will be found very satisfactory. The scope and magnitude of Dr. Nicolson's research, which was undertaken with the utmost care, together with the standing of the men participating in the tests, established beyond all question the authoritative value of the results. The pressure on the tool point is shown to be approximately proportional to the area of the cut, and therefore the torque required to take any size cut is equal to the force on the tool times the radius of the work. For uniformity, the torque at one foot radius is adopted. The speed at which the cut can be taken on any diameter is dependent on the spindle speed that can be obtained with the machine. These facts, together with the relations which were established by the maximum cutting speed and the area of the cut show that in any machine a definite relation exists between the spindle speed and the accompanying torque obtainable.

Experiments made by the Manchester Association of Engineers and the Berlin Section of the Verein Deutscher Ingenieure have been used by Dr. Nicolson to derive equations expressing approximately these relations. In the experiments the duration of the cut was not less than twenty minutes, and it was taken without injury to the tool. For mild steel, these

equations, modified to suit American practice, are given below. The swing in each case is taken as the face plate diameter:

$$\begin{aligned} \text{Area of cut in sq. in.} &= \text{Swing}^2 \div 25,600 \\ \text{Cutting speed in ft. per minute} &= (25,600 \div \text{Swing}^2) + 15 \\ \text{Maximum spindle speed} &= 7,200 \div \text{Swing} \\ \text{Minimum spindle speed} &= (102,400 \div \text{Swing}^2) + (60 \div \text{Swing}) \\ \text{Torque at 1 ft. radius} &= (100 \text{ tons} \times \text{area of cut} \times \text{diam. of work}) \div 24 \end{aligned}$$

For a geared-head lathe the corresponding torque to be able to produce the required torque at the tool point, neglecting the friction of the gears and bearings, equals:

$$(50 \text{ lbs.} \times \text{width of pulley} \times \text{diam. of pulley} \times \text{gear ratio}) \div 24$$

This is derived as follows:

$$\begin{aligned} \text{Torque at 1 ft. radius} &= (H. P. \times 33,000) \div (2\pi \times R. P. M.) \\ \text{Horse power} &= (\text{lbs. pull} \times \text{width of belt} \times \text{diam. of pulley} \times \\ &\quad R. P. M. \times \pi) \div (33,000 \times 12) \end{aligned}$$

Combining and using 50 lbs. pull we have

$$\text{Torque at 1 ft. radius} = (50 \text{ lbs.} \times \text{width} \times \text{diam.}) \div 24$$

For a cone-head lathe the corresponding torque equals:

$$(50 \text{ lbs.} \times \text{width of pulley} \times \text{diam. of cone} \times \text{gear ratio}) \div 24$$

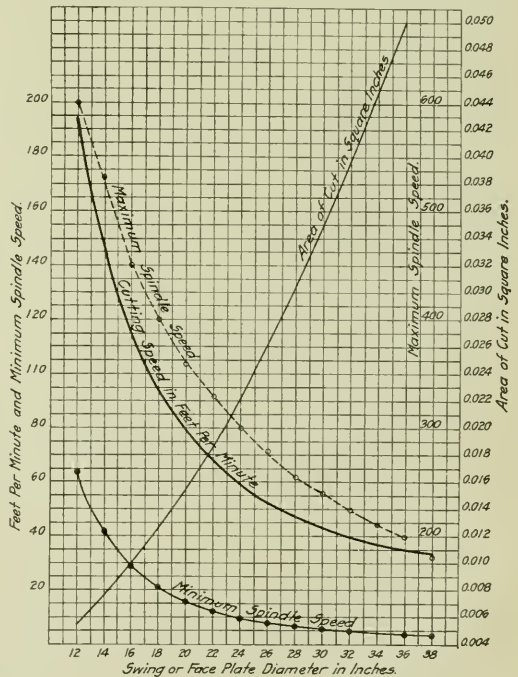

Fig. 2.

In each of the above equations the widths and diameters are expressed in inches and the 50 lbs. pull per inch width of belt is selected as being a safe average figure for normal working conditions. Any other pull per inch width may be inserted in this formula so long as the same conditions apply for all the different machines being compared. It should be noted, however, that the use of a figure other than that given will not

permit a direct comparison being made with Dr. Nicolson's formula.

As there seems to be some misapprehension as to just what is meant by torque in this connection, the following is offered in explanation. Many writers and engineers erroneously express units of both work and torque in foot pounds which causes a confusion regarding the distinction between the two. Work is properly expressed in foot pounds, while torque should be expressed in pounds feet, or preferably in pounds at a given radius. Work is the overcoming of resistance through a certain distance and is measured by the product of the resistance and the distance through which it is overcome. It is also measured by the force into the distance through which the force acts in overcoming the resistance; or, referring to Fig. 1, when the weight of 50 lbs. is raised through a distance of 100 ft. the work done is 5,000 ft. lbs. Torque, however, is the measure of the tendency of a body to rotate and may exist even if there be no motion. In Fig. 1 the torque at the circumference of the drum is 50 lbs. ft., whether the drum is moving or standing still. This is best expressed as the torque

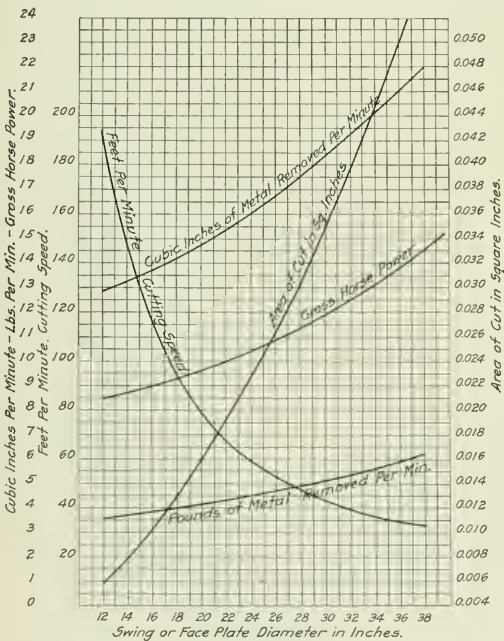

Fig. 3.

of 50 lbs. at 1 ft. radius. It is assumed in this case that the hoisting rope has no weight.

In order to make them more readily available as a basis for comparison, Dr. Nicolson's formulas are shown in graphic form in the accompanying illustrations. These have been transposed to suit American dimensions. In Fig. 2 are shown the maximum and minimum spindle speeds, together with the area of the cut and the cutting speed for various lathes having a swing or face plate diameter from 12 in. to 38 in. From this it will be seen that the standard 24 in. lathe should be able to take a cut in mild steel having an area of .0225 sq. in. at a speed of 59.4 ft. per minute. Such a lathe should have spindle speeds varying from 10 to 300 r. p. m. In Fig. 3 further curves are shown for the cubic inches and pounds of metal removed per minute, together with the gross horse power. This is the amount required at the tool point and

does not include the friction of the machine. This indicates that a 24 in. lathe should remove 4½ lbs., or 16 cu. in. of mild steel per minute, which would require 10.4 gross horse power. In this connection it should be understood that these formulas are all based on the fact proved in the experiments that the tool point can safely withstand a pressure of 200,000 lbs. or 100 tons per sq. in.

In Fig. 4 are shown curves for obtaining the allowable pull per inch of width for single and double belts with different

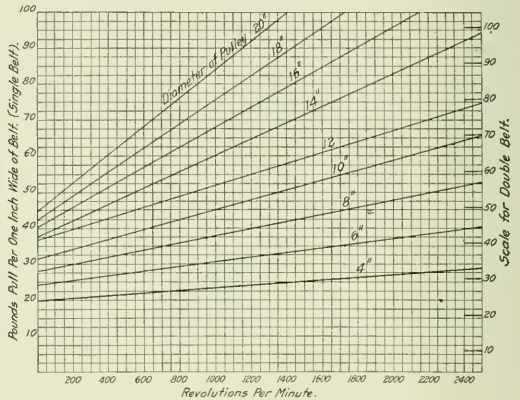

Fig. 4.

diameters of pulleys and at different speeds. This curve is based on the formula derived from the tests of Gehrckens & Kammerer, which is expressed as follows:

$$\text{Pounds pull per inch width} = \left(10 + \frac{d \times r. p. m.}{2292} \right) \times \sqrt{d}$$

Fig. 5 shows the relation of revolutions per minute and feet per minute for various diameters of pulleys between 5 in. and 36 in.

It will be understood that the various curves shown, with

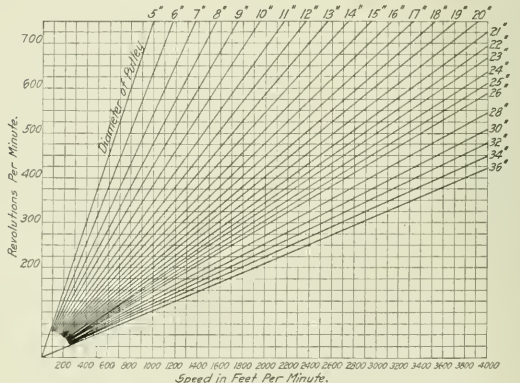

Fig. 5.

the exception of Fig. 4, have no direct association with the torque, which is entirely independent of the speed.

As is shown above the torque in pounds at 1 ft. radius equals (Belt pull × width of belt × diam. of pulley × gear ratio) ÷ 24 and Fig. 6 will give the value of the torque for various diameters of pulleys from 15 in. to 35 in., and from 1 in. to 8 in. width of belt under a tension per inch width of belt from 30 lbs. to 80 lbs., and with gear ratios between 1 to 1 and 1 to 11.

The example shown by the dotted line indicates that a 6 in. belt and a 20 in. pulley having 50 lbs. tension will give a torque of 250 lbs. at 1 ft. radius, with an open belt, and of 2,000 lbs., with gear ratio of 1 to 8.

With the information obtainable from these various curves and formulas it is possible to establish a curve between spindle speeds and torque at a one foot radius for Dr. Nicolson's ideal

belt or motor drive would give a torque shown on the curves in Fig. 7, if the gears were so arranged as to provide that spindle speed.

As an example of the procedure in using this method let us select three 24 in. lathes. One is an ordinary cone-head machine which has a three-step cone, 3 1/2 in. in width and 15 in., 12 1/2 in., and 10 in., diameters, and a back gear arranged to give a 1 to 3 reduction. With a countershaft speed of 250 r. p. m. this will give spindle speeds as shown in the table below. The two geared-head machines are lathes now on the market, both of them being arranged to give eight spindle speeds by changes of gears in the lathe headstock. Geared-head lathe No. 1 has a 16 in. driving pulley, a 5 in. belt, and gear reductions in the headstock to provide spindle speeds of 300—200—160—107—61—40—32—21. Geared-head lathe No. 2 has a 16 in. driving pulley, a belt 6 in. in width, and is arranged to provide spindle speeds of 260—160—92.2—56.6—33.7—20.8—12.1—7.4. The driving pulley has a constant speed of 268 r. p. m. in the latter lathe and 400 r. p. m. in the former.

In the following table are given the spindle speeds and the corresponding torques for each of these machines, including the base lathe, for a range of selected speeds. These are also shown in curve form in Fig. 7.

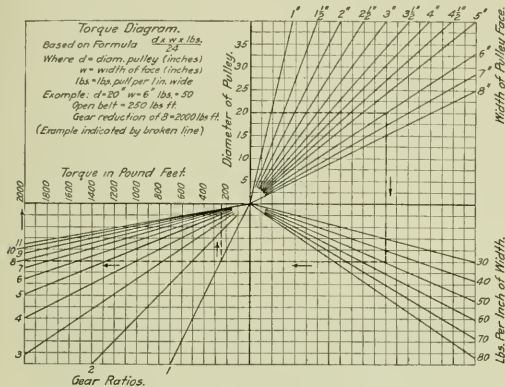

Fig. 6.

machine, which can be used as a base, and any other lathes can be compared either with the base or with each other.

This curve will take the form of a rectangular hyperbola and becomes a straight line when plotted on logarithmic cross section paper. The base line representing an ideal machine assumes that there is a change of gear for every spindle speed, so that each reduction in speed is accompanied by the increased torque or, in other words, that the maximum cut at the maximum cutting speed can be obtained on any diameter of work.

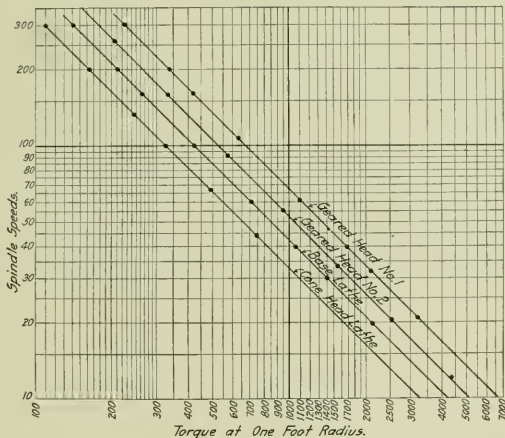

Fig. 7.

When an actual machine is plotted, however, the curve will consist of a jagged line with vertical sections of equal torque between each of the spindle speeds that are obtainable by the gear reduction in the head-stock. Since for the purpose of comparison it will be desirable to obtain the results at the same speeds in all cases, these curves are shown as drawn through the points of maximum torque at each spindle speed. At any selected speed, the geared head machine with constant speed

Base Lathe		Cone Head		Geared Head No. 1		Geared Head No. 2	
Speed	Torque	Speed	Torque	Speed	Torque	Speed	Torque
300	141.65	300	110	300	225	260	206
200	212.5	200	165	200	337	160	336
160	260	133	248	160	420	92.2	580
100	425	100	330	107	635	56.6	945
60	708.2	67	493	61	1,100	33.7	1,560
40	1,062	44	750	40	1,700	20.8	2,570
30	1,416	32	2,100	12.1	4,440
20	2,124.8	21	3,200	7.4	7,250

We can now select any range of speeds desired for comparison and obtain the corresponding torque for each machine from the curves in Fig. 7. Selecting a cutting speed of 60 ft. per minute as satisfactory for mild steel, the diameter of work to provide this cutting speed at the spindle speed selected can be easily obtained. Having then the torque at one foot radius and the diameter of work, the area of the cut which it is possible to take at that diameter and cutting speed with a constant pressure on the tool point of 200,000 lbs. per sq. in. is found by transposing Nicolson's torque formula, which shows that the area of the cut is equal to

$$(\text{Torque} \times 24) \div (200,000 \times \text{diam. of work})$$

For the base and the selected machines the area of cut at the different speeds is shown in the following table:

Spindle speed, r. p. m.	Diam. of work for cutting speed of 60 f. p. m.	Area of Cut in Sq. In.			
		Base Lathe	Cone Head	Geared Head No. 1	Geared Head No. 2
300	7.64	.0223	.0173	.0354	.0283
200	1.145	.0223	.0173	.0353	.028
160	1.43	.0223	.0173	.0353	.0282
100	2.29	.0223	.0173	.0356	.028
60	3.82	.0223	.0173	.0353	.0278
40	5.73	.0223	.0173	.0356	.0274
30	7.64	.0223	.0173	.0354	.0275
20	11.45	.0223	.0173	.0353	.0274
10	22.92	.0223	.0173	.0356	.0273
Average0223	.0173	.0354	.0278

This proves that of the machines selected, the geared-head lathe No. 1 is by far the best lathe and that it has a metal removing capacity 27 per cent. greater than geared-head lathe No. 2, and practically 100 per cent. greater than the cone-head machine. Furthermore it is 59 per cent. greater in capacity than the base machine.

As a further example of the value of this method of investigating lathe headstocks, it will be noted that geared-head lathe No. 2 provides a spindle of speed of 7.4 r. p. m. At this speed the lathe has a torque of 7,250 lbs. at a one foot radius, and this torque will permit the maximum cut which the tool can take at 60 ft. per minute cutting speed to be made on a diam-

eter of 31 in., which of course is impossible for a 24 in. lathe, and it is immediately seen that this speed is practically useless for capacity work on this machine. With a diameter of work equal to the face plate, and with a spindle speed of 7.4 r. p. m., the maximum cut could only be taken with a cutting speed of 46.5 ft. per minute, or 77 per cent. of the desired speed.

When this method is used in connection with lathes which obtain changes of spindle speed by means of a variable speed countershaft connected to the headstock by a belt, the torque for the various speeds which are obtained by a change of gears in the counter-shaft will only be equal to the torque that can be provided by the belt connecting to the headstock and should be figured with a 50 lbs. pull per inch width of that belt, i. e., only one torque for all the speeds provided by the countershaft. Investigation should also be made to discover if, under these conditions, the belt connecting the counter-shaft to the line shaft is being over-strained, and in such cases the torque as given by that belt should be used. In an arrangement of this kind it will be impossible to draw the continuous curves through the torque as given for each speed, as can be done for the gear-head or cone-head machines, and the curves between torque and spindle speed in that case will become a series of vertical and horizontal lines.

While the application of this method is here shown for lathes it can also be applied with equal facility to both the horizontal and vertical boring machines.

MOTION WORK KINKS

BY WILLIAM H. FOWLER,

Motion Work Foreman, Great Northern, St. Paul, Minn.

FLAT ROD BENDER.

Eccentric blades, Walschaert valve gear rods, etc., can be readily offset with this tool. At the Great Northern shops, St. Paul, it is used in three sizes; the 3 in. size is for light

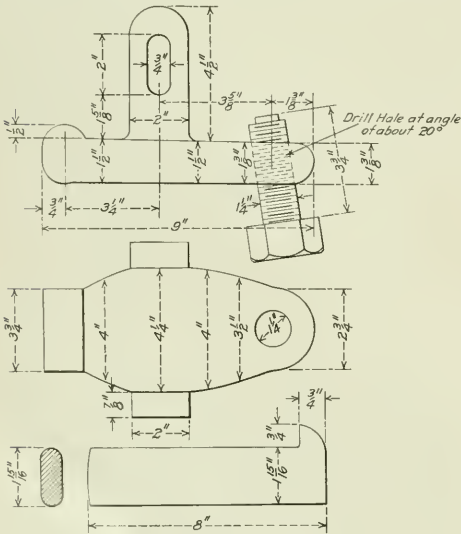

Fig. 1—Flat Rod Bender.

eccentric blades, rods of Walschaert valve gear and all small work; the 4 in. size, shown in Fig. 1, is for general motion work; and the 5 in. size is for eccentric rods, tumbling shaft arms, brake levers, etc. The great advantage of this bender is that there are no loose parts to drop on the floor or in the

pit. The head on the key keeps it from dropping when in use. It will be noticed that the set-screw hole is drilled and tapped at an angle. This puts the strain on the center of the screw when it is being used and adds greatly to the life of the screw. The parts are all forged from soft steel.

ROD TWISTER.

A useful tool for twisting eccentric blades, etc., is shown in Fig. 2. It is operated by four set screws set opposite each other in two pairs. The upper and lower set screws on the opposite sides are used at the same time to twist the rod, there

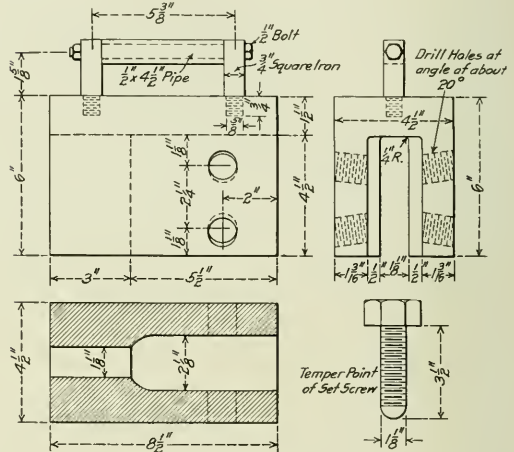

Fig. 2—Flat Rod Twister.

being two for one direction and two for the other. This tool will twist iron up to 1 1/8 in. thick, and is essentially a one-man tool, no helper being required by the machinist while using it. The handle on top adds to ease in carrying.

ROUND ROD BENDER.

A bender for round iron and valve rods, up to 2 1/2 in. in diameter is shown in Fig. 3, and is operated the same as the flat rod bender in Fig. 1. The heel of this tool is circular and the key has a curved face where it comes in contact with

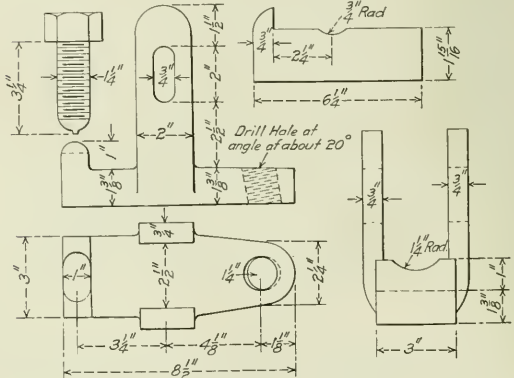

Fig. 3—Bender for Round Rods.

the rod. A small tempered point on the set-screw helps to hold the tool in position when in use. The set-screws for all three tools are made with a standard thread. The above tools were all devised by the writer.

SAFETY ON THE CHICAGO & NORTH WESTERN

First Prize Article in Competition Which Closed June 1, 1912, Includes a Rough Outline of Organization for This Work and Illustrations of Shop Safeguards

BY W. T. GALE,
Shop Demonstrator, Chicago & North Western, Chicago.

It has been said that dangerous machinery, public conveyances, and places of amusement have been responsible for more killed and injured persons during the past few years than have some of the most disastrous wars of modern times, and it is high time that the matter be given the serious consideration and action that it demands. Prominent life and accident insurance companies are giving the matter serious thought and are interesting themselves to the point of having their representatives visit various shops and factories with the object of securing the best ideas of safety devices. They have gathered a large number of photo-

brakemen, stationmen, bridgemen and shop men. Second, the shop committees, composed of the various classes of labor employed in the shops. Third, terminal committees, composed of the trainmaster of freight terminals, yardmaster from each yard, switchmen, firemen, engineers, carmen, trackmen and agent. Fourth, the central committee, composed of the assistant general manager, one general superintendent, two division superintendents, two representatives from the motive power department, one from the car department, engineer of maintenance, fire inspector, trainmaster of freight terminals and R. C. Richards as the chair-



Fig. 1—An Educational Talk to the Shop Men on Safety Appliances.

graphs of these and placed them in book form with suitable descriptions explaining their uses; any employer of labor interested can secure a copy upon request.

Among the first railways to take up and put into practice the idea of "safety first" was the Chicago & North Western, and the credit is due to R. C. Richards, chief claim agent of that road, he having originated and organized a complete and efficient system of safety committees on every division and branch of the road. The organization was completed and the plan put into operation January 1, 1911.

The safety committee organization is as follows: First, the division committees, composed of the division superintendent, division engineer, division master mechanic, and one or more representatives from each class of labor employed on the division, such as trainmen, firemen, conductors, trackmen, switchmen,

man. The local committees hold meetings twice a month, and the members report all dangerous and unsafe conditions, and make recommendations covering them. The chairman of the committee has the secretary, usually a stenographer, make a record of all reports, and sees that proper action is taken pertaining to the reports. Sometimes it is necessary for a large expenditure to cover some of these suggestions. These are referred to the central committee for action. Mr. Richards and the members of the central committee make trips over the road occasionally and address mass meetings of employees, advising them in matters pertaining to safety precautions. These are called safety educational campaign trips.

The local committees have accomplished most excellent results, among which are the placing of efficient guards around all dangerous machinery, such as pulleys, line couplings, belts, hoisting

cranes, etc., and around lye vats, heating furnaces, elevators and electric motors; also the efficient guarding of dangerous moving parts of machines such as lathes, boring mills, planers, drill presses,

dangerous implement in his hands or on his shoulders. By reference to the accompanying photographs and sketches, the particular style of guard employed may be seen. All these guards, with

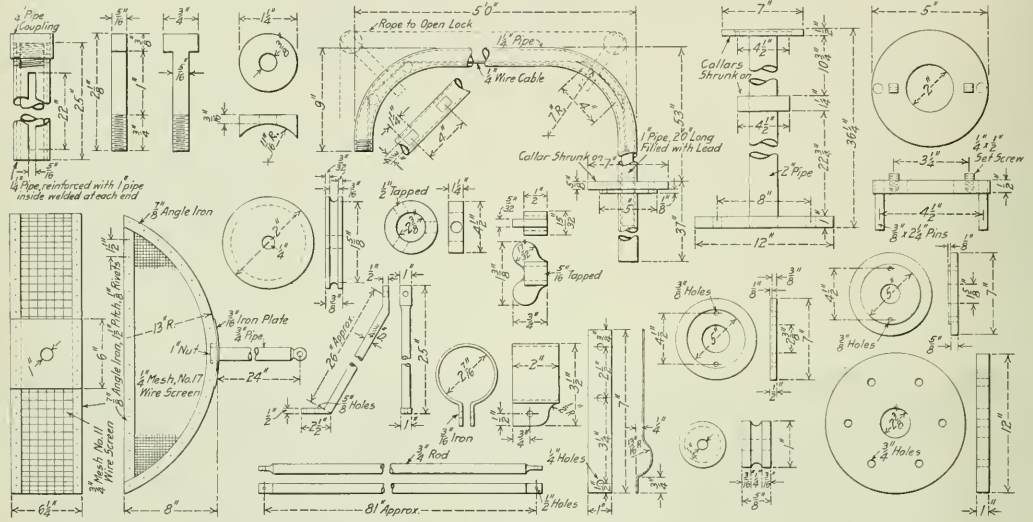

Fig. 2—Details of Adjustable Safety Guard for a Rip Saw.

automatic machines, metal shears, punches, emery wheels, rip saws, joining machines and band saws. Automatic warning bells have been placed on the transfer tables, and windows in the

a few exceptions, originated with the committees. There is an elaborate system of fire signals in the yards and shops, and a local fire company is furnished by the railway with the proper

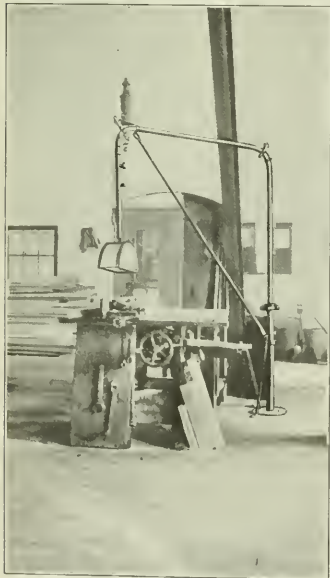

Fig. 3—Adjustable Swing Guard on Rip Saw.

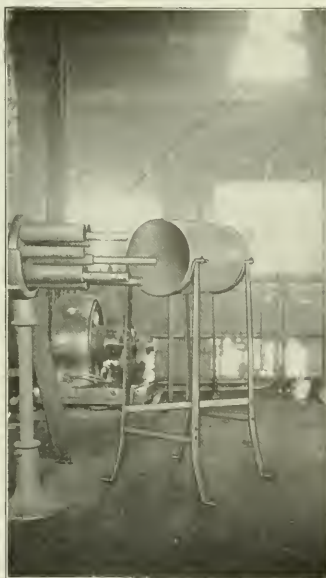

Fig. 4—Guard for Ends of Rods in Automatic Machine.

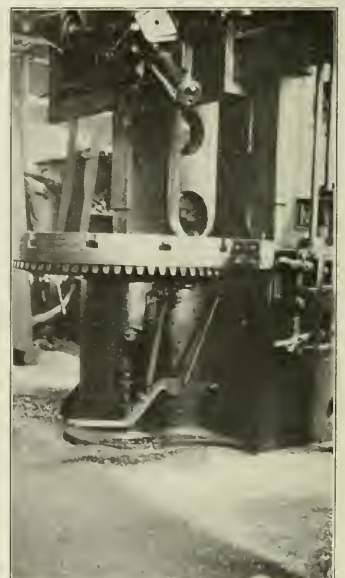

Fig. 5—Friction Brake on Boring Mill.

panels of doors through which employees pass in going from one shop to another, so that a man using the door can see anyone coming in the opposite direction, possibly with some

apparatus for emergencies. Like precautions are adopted in all places where the committees are stationed. Special committees are detailed to see that employees do not get on or off moving

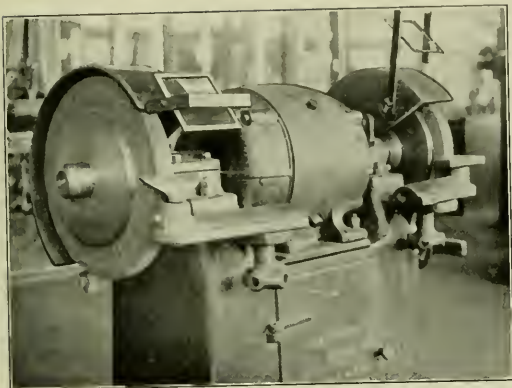

Fig. 6—Glass Guard for Grinding Wheel.

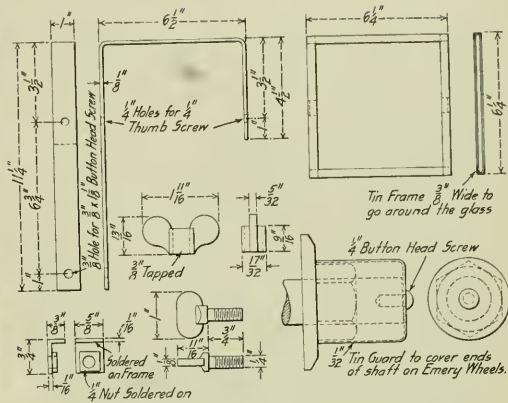

Fig. 7—Adjustable Glass Guard for an Emery Wheel.

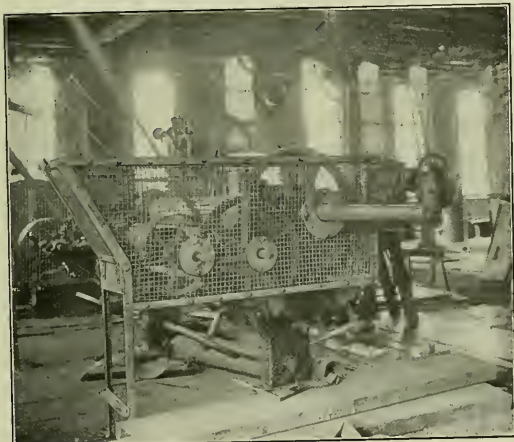

Fig. 8—Bending Rolls in Tank Shop.

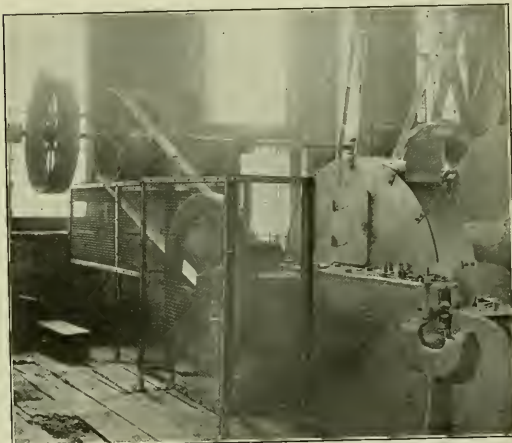

Fig. 9—Punching or Stamping Mill.

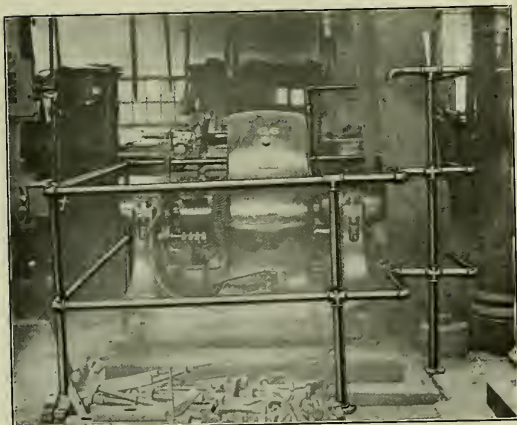

Fig. 10—Guard for Electrical Machine.

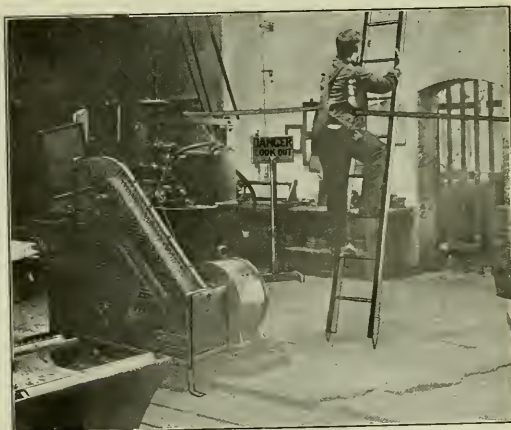

Fig. 11—Danger Sign for Overhead Repair Work.

shop trains, and every committeeman has jurisdiction over any part of the road or shops that he may be in, with the privilege of reporting dangerous conditions to the local chief committeeman, or to the central committee. A statement is shown giving

10 fewer switchmen killed, a decrease of..... 41.7 per cent.
 146 fewer switchmen injured, a decrease of..... 17.1 per cent.
 3 fewer stationmen killed, a decrease of..... 50.0 per cent.
 148 fewer stationmen injured, a decrease of..... 16.8 per cent.
 1,044 fewer trackmen injured, a decrease of..... 43.8 per cent.

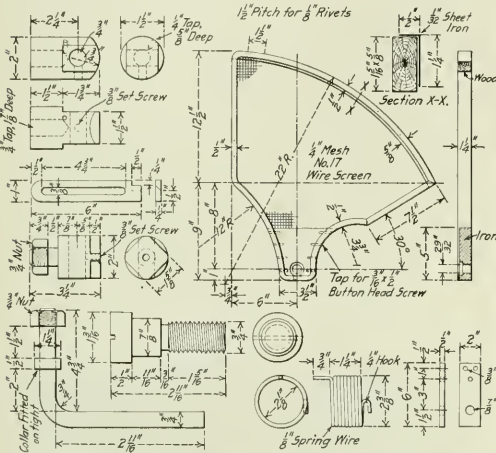

Fig. 12—Details of Automatic Safety Guard for Wood Jointer.

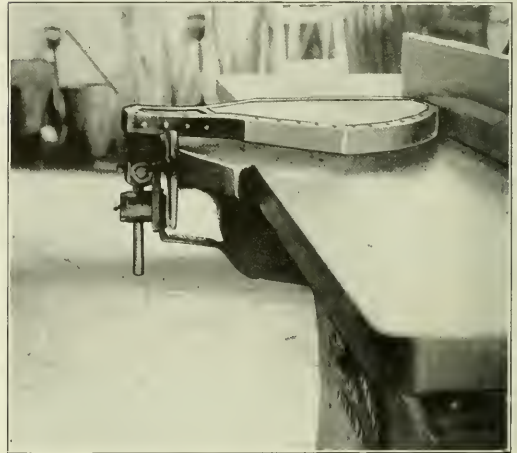

Fig. 13—Application of Guard to Wood Jointer.



Fig. 14—Guard on Swing Rip Saw in Open Position.

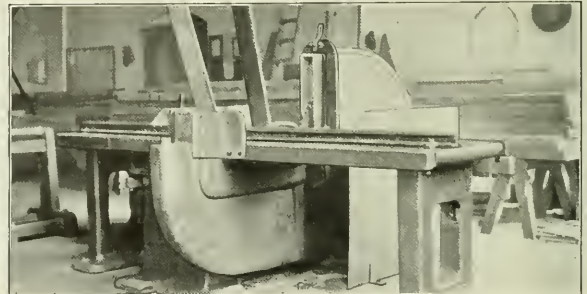

Fig. 15—Guard on Swing Rip Saw.

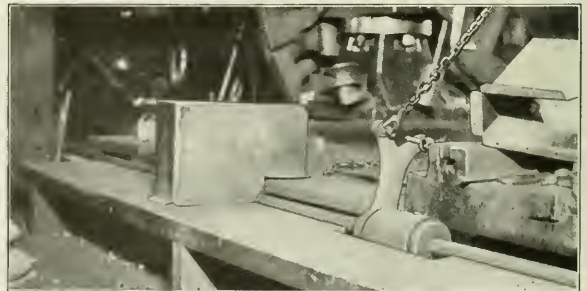

Fig. 16—Foot Guard on Wheel Lathe.

results from all over the system from the inception of the organization to date.

STATEMENT SHOWING REDUCTION IN NUMBER OF ACCIDENTS ON THE CHICAGO & NORTH WESTERN FOR SIXTEEN MONTHS ENDING MAY 1, 1912, AS COMPARED WITH SIXTEEN MONTHS ENDING DECEMBER 31, 1910.

27 fewer trainmen killed, a decrease of..... 53.0 per cent.
 1,940 fewer trainmen injured, a decrease of..... 44.0 per cent.

134 fewer bridgemen injured, a decrease of..... 31.4 per cent.
 5 fewer car repairers killed, a decrease of..... 71.4 per cent.
 34 fewer car repairers injured, a decrease of..... 8.4 per cent.
 1 fewer shop and roundhouseman killed, a decrease of..... 14.3 per cent.
 261 fewer shop and roundhousemen injured, a decrease of..... 15.0 per cent.
 1 fewer other employee killed, a decrease of..... 7.7 per cent.
 3 fewer other employee injured, a decrease of..... .3 per cent.
 3 bridgemen killed in 1911-1912, same as in 1909-10.

But an increase of 2 trackmen killed in 1911-1912.

TOTAL REDUCTION OF					
45 fewer employees killed, a decrease of.....		31.5	per cent.		
3,708 fewer employees injured, a decrease of.....		32.2	per cent.		
9 fewer passengers killed, a decrease of.....		42.9	per cent.		
201 fewer passengers injured, a decrease of.....		17.5	per cent.		
53 fewer other persons killed, a decrease of.....		18.4	per cent.		
87 fewer other persons injured, a decrease of.....		11.2	per cent.		
TOTAL.					
107 fewer persons killed, a decrease of.....		23.7	per cent.		
3,996 fewer persons injured, a decrease of.....		29.8	per cent.		
		1911-12.		1909-10.	
		Killed.	Injured.	Killed.	Injured.
Employees		98	7,788	143	11,496
Passengers		12	945	21	1,146
Other persons		235	691	288	778
Total		345	9,424	452	13,420

A view in one of the shops while an education talk by one of the members of our central committee was being given to shop men on safety precautions is shown in Fig. 1.

An adjustable swing guard for a rip saw is shown in Figs. 2 and 3. The hasket may be adjusted for height by the operator, who has only to grasp a small wooden handle hanging alongside of the pipe above the basket. One light pull removes the tumbler pins in the collar at the back of the hanger and it can be swung out of the way. In pulling it back into position the



Fig. 17—Guard for Lathe Feed Gears.



Fig. 18—Guard Removed from Feed Gears on Lathe.

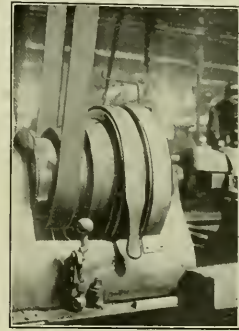

Fig. 19—Friction Brake for Stopping a Lathe.

tumbler pins fall into the holes in the collar and it is again locked in proper position.

Fig. 4 shows a floor stand cylinder guard for the ragged ends of steel rods passing through automatic machines. Employees passing close by cannot get their clothes caught when this guard is placed over the ends of rods.

A foot and friction brake on a boring mill to quickly stop the machine in case of accident or to facilitate handling the work, is shown in Fig. 5. Pressure of the foot on the treadle forces the wooden block 1 by means of a system of levers, against the edge of the revolving table and brings it to a stop.

An adjustable glass guard to protect the eyes from material that rebounds from the tool rest when men are grinding is shown in Figs. 6 and 7; it may be placed in any position to accommodate the material to be ground, or the light reflection, or may be moved out of the way entirely to suit the work. Note also the cup guard on the end of the shaft screw, covering both screw and nut so that the operator's work jacket cannot be caught on them.

A metal rolling machine in the tank shop which is well guarded is shown in Fig. 8, and a punching or stamping mill whose flywheel and pulleys are carefully guarded is shown in Fig. 9. A typical guard for electric motors is shown in Fig. 10.

Fig. 11 shows a man doing some repair work overhead and danger sign stands placed so that employees will see them and not pass underneath, thereby inviting an injury from a falling tool. On the same view is shown a guard for a switchbox.

pulleys and belt on a wet automatic tool grinding machine. You will also note in rear of this guard the end bed of a planer with a sheet iron plate covering the inside part of the bed. This is to prevent the men from putting any kind of material in that part of the beds, a practice of which is considered dangerous.

A very good guard for the knives of a jointing machine is shown in Figs. 12 and 13. It works automatically, that is, it returns into position when the material passes over the knives. It may be removed instantly when necessary and is just the thing for a locomotive repair carpenter shop where one machine has to do all kinds of work.

A swing rip saw guard in position over the saw and a guard in front of the saw to keep the workman's hand out of the way is shown in Fig. 15. Another view of the guard in an open position, in order that the saw may be taken off, is shown in Fig. 14.

Fig. 16 shows a foot guard around a cam, which regulates the feed of the tool on a large driving wheel lathe. This cam when in motion comes within 1 in. of platform that operator stands on and would crush his foot if he left it under the cam when in motion.

A handy and quickly applied gear guard for lathes, made large

enough to cover the gears in any position, is shown in Fig. 17. It slips over two brackets which hold it in place. The same guard disengaged, while the gears are being changed, is shown in Fig. 18. Its removal and re-application is a matter of a few seconds only. A friction belt for stopping a lathe in a hurry, when necessary, is shown in Fig. 19. It is very handy in case of an accident.

GAGE OF AFRICAN RAILWAYS.—The first railway in South Africa was a short line, constructed by a company, from Cape Town to Wellington, with a branch to Wynberg, amounting in all to about 63 miles in length. It was begun in 1859, and opened in 1863, and was taken over by the government in 1873. This line was on a gage of 4 ft. 8½ in. When, however, the Cape Colony decided to embark on a policy of railway extension, the question arose whether a narrower gage would not be more suitable to the requirements of the country. The decision in 1869 to construct many extensions in India on the 3 ft. 1 in. gage no doubt influenced the Cape government in the adoption of a somewhat similar gage. This decision practically settled the question for nearly the whole of Africa. Thus, when the political union of South Africa was accomplished, the physical union, through uniformity of railway gage, had been already attained. The gage fixed on was 3 ft. 6 in., and the Cape Town to Wellington line having been converted, construction was pushed forward from three ports—Cape Town, Port Elizabeth and East London.

BOILER SHOP KINKS

BY R. W. CLARK.

Foreman Boiler Maker, Nashville, Chattanooga & St. Louis, Nashville, Tenn.

DIES FOR SWAGING TUBE ENDS.

The set of spring dies illustrated is used for swaging the ends of boiler tubes, and is made in two sections, which are held apart by two coil springs *A* which fit in holes in the dies. The dies are held true by four guides *B* which are riveted

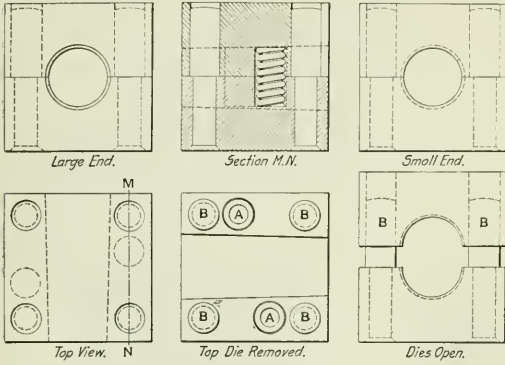

in the bottom die and are free to slide in the upper one. The hole through the dies is bored with a taper, and in the case of the dies shown the flues are swaged from 2½ in. down to 2 in., in a length of 5 in. These dies are used under a punching

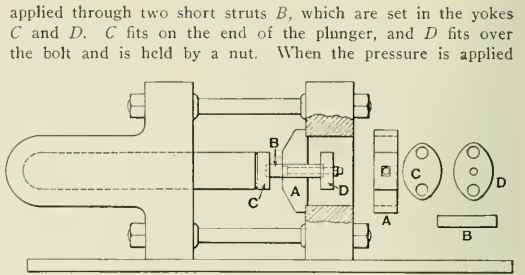

A Method of Testing Staybolts.

to the press, the tensile strength of the bolt may be calculated from the reading of the gage on the cylinder.

TOOL FOR REMOVING DRIVING BOX CELLARS

James Clark, a machinist at the Clinton, Iowa, shops of the Chicago & North Western, has designed a tool for removing driving box cellars which fit tightly in the box. It consists of a yoke made of 3 in. square steel and of sufficient length to more than span the width of the box. This rests across the upturned bottom of the box, and over its downwardly extending ends two forged steel pieces are slipped, one being held in place by a wedge and the other by a small hydraulic piston jack. These forgings fit between the flanges of the box and are provided with steel toothed sections, set eccentrically, which grip in the flanges. As the small piston jack

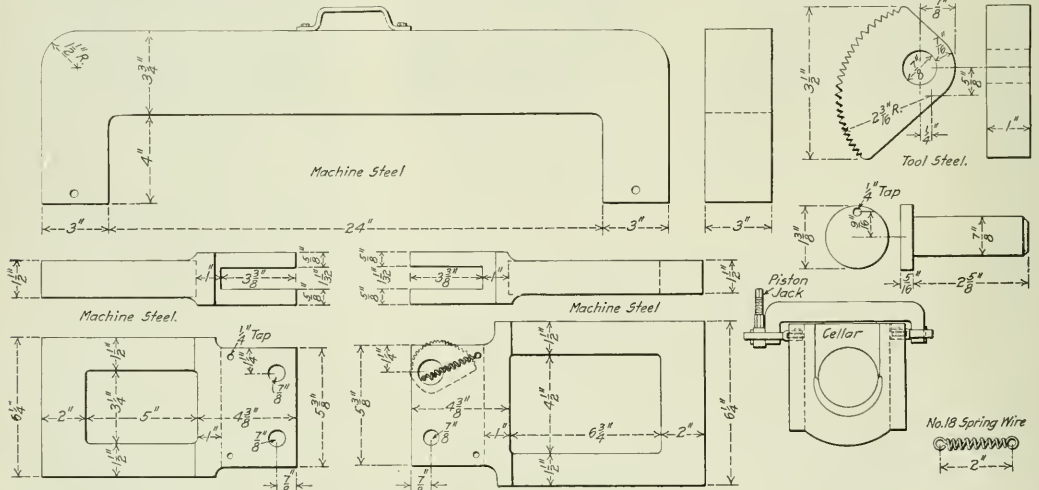

Tool for Spreading a Driving Box to Loosen the Cellar.

machine, which will turn out the work in a very satisfactory manner and as fast as two men can handle it.

TESTING STAYBOLTS.

The novel arrangement shown in one of the illustrations for making tensile tests of staybolts has been found quite satisfactory where there is no regular testing machine at hand. The testing is done on a driving box press. The staybolt is held in the block *A*, which fits over the hole in the table. The load is

applied through two short struts *B*, which are set in the yokes *C* and *D*. *C* fits on the end of the plunger, and *D* fits over the bolt and is held by a nut. When the pressure is applied

TRAFFIC IN GUATEMALA.—In 1911 the 421 miles of railways of Guatemala carried 1,187,433 passengers, 252,882 tons of freight. In addition to this freight, the Guatemala Railway hauled during the year 1,240,511 bunches of bananas.

CAR DEPARTMENT

CAR DESIGN FROM THE REPAIRMAN'S STANDPOINT

BY BUZZER

Drastic legislation is making economy in railroad operation more imperative than ever before, and will without doubt, cause managers to look more closely into the details of expenditure for cars and car maintenance, which represents no small item in the cost of operation. From many years of experience in car department matters, including design, construction and maintenance, the writer has been greatly impressed with the possibilities of more careful car construction in reducing the cost of repairs, increasing the life of equipment, eliminating the cost of trans-shipping freight from damaged cars, and reducing damage claims. Too little thought is given to how repairs can be made in case of damage, and it is very often the case that the renewal of a part costs two or three times what it would had a little more thought been given the matter when the car was constructed.

Almost every car man has seen, times without number, a new lot of cars come out, which were no sooner put in service than on opening his mail some morning he found a circular letter requiring a number of changes to be made. They may not look very large, probably averaging from two to ten dollars a car, but when there are several thousand cars affected it means a considerable amount of money, which, in the majority of cases, could just as well have been saved to the company by having two or three good practical car men supervise the drawings and specifications, or carefully check a sample car. Most of the defects would then have been detected before the drawings finally went to the builders, and without adding any to the cost of the cars.

The question of minimizing the number of repair parts, by making them interchangeable as far as possible, on all classes of equipment, is an important one, and its proper consideration is conducive to considerable saving. Reducing the number of parts not only reduces the amount of money tied up in store-house stock, but the fewer parts make the probability greater that when one is wanted it will be on hand, thus obviating the necessity of keeping cars on the repair track awaiting material. In checking up the material on one road it was found that there were over 60 different patterns of coupler rod brackets, and an examination of the cars showed that 12 patterns would have taken care of all of the equipment.

After long and careful observation, the writer considers steel underframes of the fish belly type, built up of standard steel sections, the most durable and economical to maintain. Truss rods should always be avoided, as it is impossible to keep the roofs and bodies of house cars in good condition where they are employed, owing to the varied amount of camber and deflection. This strains the roofs and makes it almost impossible to keep them from leaking for any length of time. Patrons of a road are frequently very observing, and shippers often remark that they do not want to load certain commodities, in car load lots, in cars equipped with truss rods, as they do not carry the load nearly as well as cars constructed without them. To the close observer of transportation facilities, it is plain that steel underframe cars, built sufficiently strong and without truss rods, will save no small amount in a year in claims as well as in maintenance charges.

Several large systems are, however, building new equipment with the steel construction so light and poorly braced that it is impossible for a helper engine to be used behind the cars without causing them to buckle. This has been noticed and commented upon by a great many practical car men, but cars are still being built in this manner, which shows that the designer and the practical man are not working together. The designer in this case seems to have in mind only the pulling strain, with the result that the cars are very much like a switch cable—good to pull with, but very poor to push on, and another instance where pull wins over push. Cars constructed in this manner are a continual source of needless expense for repairs and a frequent cause of accident and damage to lading, delaying traffic and keeping wrecking crews busy. The number of such cars in existence is surprising and the pity of it all is that the mistakes in design could so easily have been avoided by a little consultation with the practical car men.

PITTSBURGH & LAKE ERIE TWO CAR GAS-ELECTRIC TRAIN

The Pittsburgh & Lake Erie has in service between Pittsburgh and College, Pa., a two car train consisting of a General Electric gas-electric motor car and a trailer.

The motor car is 42 ft. 6 in. long, 10 ft 5 in. wide and weighs 72,000 lbs. It seats 42 people and is divided into three compartments; one 20 ft. 5 in. long for smokers; a section 6 ft. long for baggage; and a cab 12 ft. long containing the power plant.



Gas-Electric Motor Car and Trailer Used on the Pittsburgh & Lake Erie.

It is provided with a rear platform entrance. The trailer is 38 ft. long over the body, weighs 44,000 lbs., and seats 80 people, making a total seating capacity for the train of 122 passengers. Front and rear platform entrances are provided in the trailer. The interior finish of both cars is mahogany, with composite board on the decks.

This train operates over a section of four track road, where the traffic is very heavy. On the trial trip a distance of 31 miles was covered in 49 minutes, including three stops, and returning, the same distance was covered in 42 minutes, with two stops. The motors used have a total capacity of 200 horse power.

SHOP ARRANGEMENTS AND FACILITIES*

BY I. S. DOWNING.

Master Car Builder, Lake Shore & Michigan Southern.

There are a great many things to consider in building car shops to meet the present conditions; the class of equipment is changing very rapidly; not only are the wood cars being replaced by steel, but the different parts of cars are being strengthened, and even cars built within the last five years are being changed. The capacity and location is important. The centralization of repairs in one large shop cannot be done, as the law will not permit the handling of cars with safety appliance defects beyond repair points, except they be run in non-revenue trains, and the running of non-revenue trains to move bad order cars to large shops is not economical or good practice.

Under these conditions it is necessary to build shops at practically every terminal on the line; however, it is possible to centralize to a great extent. Heavy steel car work need not be done at all terminal shops, but such cars can be moved to one central shop. Shops should be located at or near the point where cars are made empty. The unloading point for self-clearing hopper and gondola cars is principally at the harbors. This class of shops should not be located in congested districts; however, they should be so located that yard engines can promptly handle cars to and from the shop and delivery tracks. Bad order storage tracks should be a part of the shop yard and of a capacity equal to the shop and repair tracks. By providing sufficient storage, the switching yard is relieved and the shop is always supplied with bad orders, and conveniently located so the shop engine can handle them without waiting on yard engines, which, in my opinion, never have any time for switching shop tracks.

While conditions will not permit the complete centralization, I do believe on roads having mixed equipment of wood and steel cars, that where more than one shop is built, it is not necessary to fully equip each shop for repairs to either class of cars. One shop should be provided with a crane and furnaces for heavy repair work to steel cars and only a limited amount of machinery for repairs to wood cars; the other shop should be fully equipped for making repairs to wood cars and only a limited number of tools for steel car work, no crane being required in the wood car shop. However, the building should be constructed for the future installation of a crane.

The number of cars, class of cars, and the age of equipment, must be considered in arriving at the capacity of the shop. Below is a statement showing the average time between shopings for general repairs of various classes of cars, also a statement showing the number of hours for repairs to the different classes of cars—general and medium:

	Average time between shopings.	Average number of hours to repair.	
		General.	Medium.
Steel cars	10 to 12 years	609	85
Steel underframe cars.....	8 years	232	42
Wood cars	6½ years	149	54

*Extracted from a paper read before the Car Foremen's Association of Chicago.

I believe these figures are reliable, as most of them are actual. With this data it can be easily determined what size shop would be required to take care of the general repairs to equipment. Light running repairs should be considered separate.

The track capacity of light repair shops, when built, should be about double their present requirements, as there is nothing lost in building a yard larger than the present requirements; if half the yard is not used for repair work it can be used to store bad order cars placed for repairs. This would keep the switching yards clean of bad order cars. It is not necessary to go into details regarding tools used for this class of shop, but we do know that it is a paying investment to have plenty of good tools, such as jacks, bars, etc., for the men to work with. Plenty of good tools means a better output and a good natured lot of repairmen. The time is past for setting off a couple of box cars with bolts, brasses, etc., and calling it a repair yard. Equipment today, with the heavy draft gears, ends, trucks, roofs, etc., requires shops and shop tools and machinery to make repairs, and the maintenance of equipment will be with us always and we will have to provide facilities to take care of it.

The following general considerations should be pointed out:

1. Exercise care in buying machinery for repairs to wood cars, as it will not be required many years.
2. The use of steel wheels under freight cars makes it necessary to have steel tire lathes at all repair yards to avoid shipping wheels and to keep the stock down to a minimum.
3. Very little heat, if any, is required in freight repair shops.
4. All new cars to be purchased should be built entirely of flat plates, commercial rolled shapes and castings.
5. All cars in existence to have parts which fail replaced, when possible, by parts made of flat plates, commercial shapes and castings.
6. Shops should be provided with facilities for duplicating simple parts of present cars in cases where it is not possible, desirable or permissible to change their design.
7. In territory where weather conditions are such that men cannot work outside, shop buildings should be provided for doing the work under cover.

PRIZES OFFERED IN GERMANY.—The German Society of Mechanical Engineers offers a prize of \$375 for the best treatise on annoying noises caused by city and street railways, their causes, and the best means of avoiding them; also similar prizes for a work on the heating of cars by steam, for one on cranes used in locomotive shops, and one of \$500 for an investigation of car springs, with designs and formulae. The formulae heretofore used are believed to be inadequate.

IMPORTANT CHINESE RAILWAY COMPLETED.—The railway from Tientsin, the port of Peking, south by east 674 miles to Pukow, on the Yang-tse-Kiang opposite Nanking, was completed in December when the great bridge over the Hoang-ho was finished. The northern 425 miles were built by Germans, the southern 249 by English. The Chinese government purposes to work the road on its own account. This completes rail connection from Peking to Shanghai, except for the crossing of the Yang-tse-Kiang.

CONSTRUCTION IN ASIA MINOR.—December 21 a section some 30 miles long of the Bagdad Railway was opened in the Taurus mountains, and not long before a longer section of the same line was completed east of these mountains. There is some very heavy work to be completed in the mountains before the two sections can be connected. This work is near the northeast corner of the Mediterranean sea, which will be reached by a branch line to Alexandretta. It may be supposed that the Turks have other work than railway building to occupy them at the present time; but the enterprise is in the hands of Germans and others, while of course there has been profound peace in Asia Minor.

EQUIPMENT FOR CLEARING WRECKS

Examples of Conveniently Arranged Cars and Tools Designed for Quick Work in Emergencies

Any equipment which is not in frequent use is likely to be considered of secondary importance and be entirely overlooked for considerable periods in the bustle of modern railroad work. The wrecking outfit, which ordinarily stands in an out-of-the-

sideration. Any car that is not fit for use in any other capacity is considered good enough for wrecking train purposes, and it is common to see old box cars in which a man of average height cannot stand erect without striking the carlines, and which, if given a severe shock, would be likely to break in two, used as tool and living cars. Little or no attention is given to the selection of equipment and its arrangement in the cars, and many

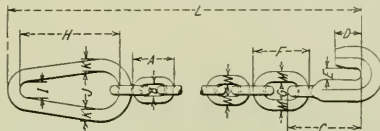
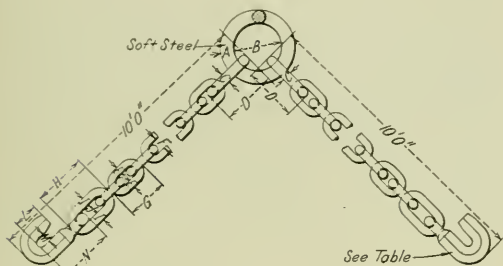

Ring	Hook	A	B	C	D	E	F	G	H	I	J	K	L	M	N
OSD	13	2 1/2	3	2 1/2	8	1 1/2	9 1/2	4	1 1/2	6 1/2	8	1 1/2	2	1 1/2	11
..	15	2 1/2	3	2 1/2	10	1 1/2	10 1/2	4	1 1/2	7 1/2	10	1 1/2	2 1/2	1 1/2	11
..	16	2 1/2	3	2 1/2	10	1 1/2	11	4	1 1/2	8 1/2	10 1/2	2	2 1/2	1 1/2	11

No. of Chains In Service	Kind of Chains	Wrecking Chains														Size	Size	Hook Size
		A	B	C	D	E	F	G	H	I	J	K	L	M	N			
10	Common	4 1/2	1 1/2	8	3 1/2	1 1/2	6	1	10 1/2	2	4	1 1/2	16	0	1	1 1/2	2 1/2	Iron
4	Special	5 1/2	1 1/2	10	4 1/2	1 1/2	6	1	11	2 1/2	4	1 1/2	22	0	1 1/2	1	2	Iron
6	"	5 1/2	1 1/2	10	5	1 1/2	8 1/2	2 1/2	11	2 1/2	4	1 1/2	22	0	1 1/2	1 1/2	2 1/2	Iron
8	"	6	1 1/2	10 1/2	5	1 1/2	8 1/2	2 1/2	11	3	4 1/2	1 1/2	24	0	1 1/2	1 1/2	2 1/2	Iron
	"	7	2	11 1/2	6	1 1/2	9	2 1/2	12	3 1/2	5 1/2	2	20	0	1 1/2	1 1/2	2 1/2	Iron

Wrecking Chains Used on the Southern Railway.

way place and may not be used for days or weeks, is an example, and the condition of many of them is eloquent testimony as to the amount of attention they receive.

times there are ropes and tackle, ordered without regard to size or suitability, which lie in a pile in the tool car, taking up valuable space, and are never put in use. Chains are commonly



Chains in a New York Central and Hudson River Tool Car.



A Neatly Arranged Tool Car on the Erie.

There are few items in railroad equipment where a high standard of efficiency is more desirable, and yet, because of its being comparatively seldom in use, it is about the last to be given con-

thrown in indiscriminately, making it a long job to pick one out when it is needed in a hurry. Car replacers, jacks and other tools, if not provided with proper space and supports, often be-

come hopelessly mixed up, due to shocks when switching. Sleeping and dining cars are often chosen with no regard to their suitability for the purpose and are fitted up without much attention to heating and sanitation.

The first consideration when a wreck occurs, aside from the provision of prompt medical service in case of serious personal injuries, is to clear the main line. Even a small accident has great possibilities of delay, with its resulting demoralization of traffic; and the time and money spent in providing a good wrecking outfit may easily be offset by the saving in time due to the prompt and efficient clearing of a single bad wreck. It is seldom, if ever, necessary to build special cars for this purpose. A little care in selecting and refitting some of the older cars will produce an adequate wrecking train, the main point to be kept in mind being that any broken-down, antiquated car that happens to be available is not what is wanted. Ideas as to just what cars are necessary vary on different roads, but most wrecking trains



Kitchen and Dining Car Used in Wrecking Trains on the Erie.

contain one or more tool cars, a flat car for spare trucks, a sleeping car, a dining car, and a tender for the steam crane, which is frequently used as well for carrying blocking, ties and rails.

In fitting up a tool car special care should be given to provide a place for everything, where it is readily accessible at any time. If, when a car is partly removed or retailed, it is found that another cable or jack or pair of replacers is needed, it should not be necessary, as it often is, to hold up the work while two or three men make a search through the tool car for what is wanted. Any tool should be available without any delay whatever beyond that necessary to carry it to the point where the work is going on. The illustrations show cars that are neatly and conveniently arranged. The suspending of the chains from hooks makes any particular one easily available and they take up very little space.

A convenient way to fit up the dining car is to partition off one end as a kitchen, which should be provided with a good range and an ample supply of dishes. There should be provision for seating a large gang of men, as it is often necessary to feed several train crews, as well as section men. Every precaution should be taken to make the car sanitary. This should also be

carefully considered in fitting up a sleeping car. One of the illustrations shows a car arranged somewhat like a standard sleeper and as may be readily seen, the bedding can easily be removed and the car thoroughly cleaned. The sleeping car is important, as men may be out for several days and have to work in shifts; in such cases it becomes absolutely necessary that they have a comfortable place to rest and change their clothing, in case of their having to work in the rain.

Most roads have a standard list of tools which is provided

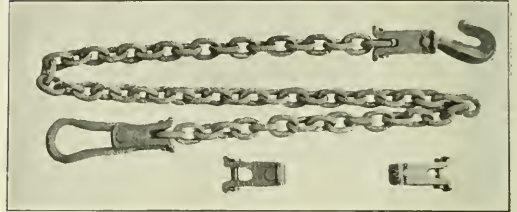

Buckley Repair Link Applied to a Broken Chain.

for all wrecking trains, but there is a great opportunity for the development of special tools. The Chicago, Burlington & Quincy has produced a number of tools for special purposes in clearing wrecks, some of which are illustrated. Among the standard tools of which there should be an ample number of all types, are jacks and car replacers. There should especially be a wide range of sizes and types of jacks, as there is almost no



Sleeping Car for Use in Wrecking Trains.

limit to their use. A handy device for quickly repairing broken chains is shown in one of the illustrations. This is used on the Illinois Central and is the invention of J. H. Buckley, foreman blacksmith at the Burnside shops of that road. Chains are an important item of wrecking equipment and the Southern Railway has given them particular attention, as shown in one of the drawings. Special provision has sometimes to be made for local conditions, an instance being the carrying in tool cars.

ment, are of great assistance in determining just what course to pursue, and it may be interesting to point out briefly the methods followed.

The rules governing the application of safety appliances to locomotives and cars were issued by the Interstate Commerce Commission on October 12, 1911, and the time allowed for making equipment comply with the law was as follows:

- Switching locomotivesOne year from July 1, 1911
- Road locomotivesTwo years from July 1, 1911
- Passenger carsThree years from July 1, 1911
- Freight carsFive years from July 1, 1911

The work of equipping locomotives is now completed, and in order to indicate the relation of the curves over the entire period the diagram for road locomotives is shown. As long as the dotted line, representing the number of locomotives or cars equipped, remains below the full line, it is evident that the required average is being maintained. Considerable work was done in equipping road locomotives at engine houses until it was found that the work was considerably ahead of schedule, after which it was confined to the main shops. This accounts for the abrupt decrease in the rate of progress after February 1, 1912.

The curve representing work on passenger cars is peculiar, in that it shows very little progress prior to May 1, 1912. The reason for this is that before going ahead with the work, we wished to make certain that the new type of "harmony" brake rigging which we designed would work out satisfactorily, and we also wished to experiment with a certain type of ratchet hand brake lever for use on blind end passenger cars. Our experiments proved entirely satisfactory, and since May 1, 1912,

The curve for freight equipment cars is similar to the others, and shows the work done at each shop, as well as the total

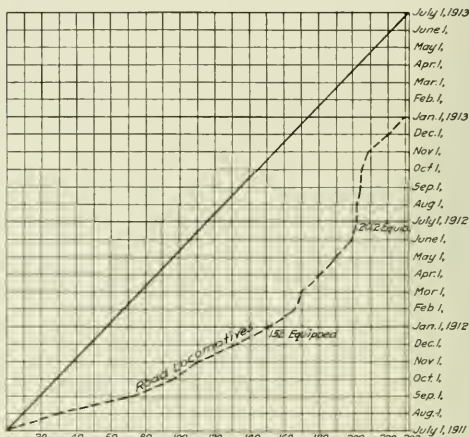
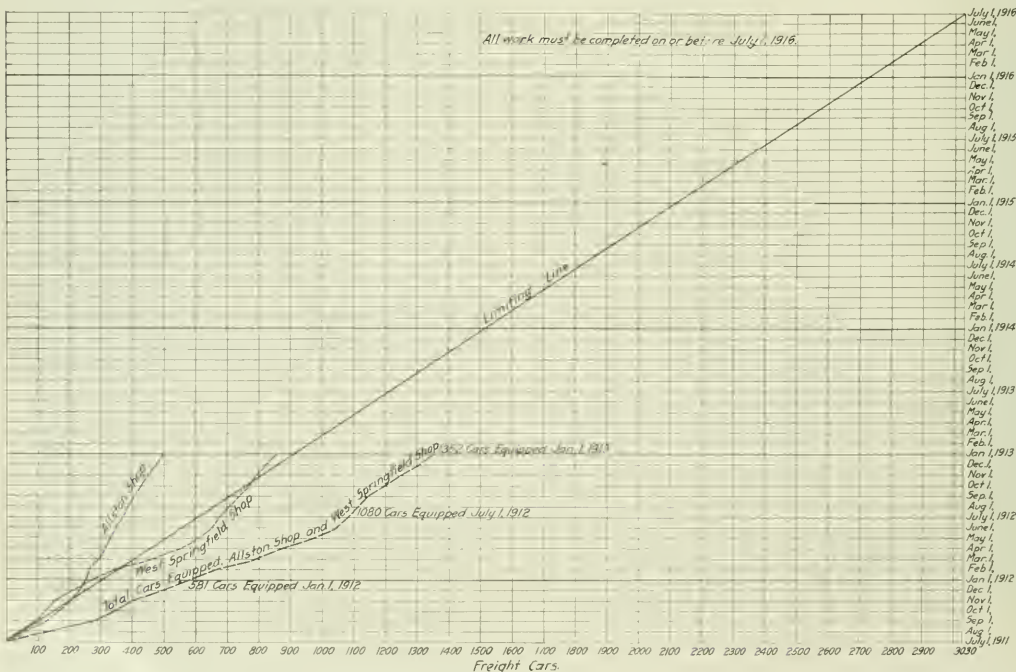

Diagram Showing Progress in Equipping Locomotives with Safety Appliances.

number of cars equipped with safety appliances. All safety appliance work on freight cars is done at our two principal



Progress in Equipment of Freight Cars with Safety Appliances at Allston and West Springfield and the Two Shops Combined.

a uniform rate of progress has been maintained, so that on January 1, 1913, we caught up to the schedule and the curve indicates that if the same rate of progress is maintained we will have all our passenger cars completely equipped about six months ahead of time.

shops, as, on account of the importance of complying strictly with the law, we decided to have the work done under the constant supervision of the safety appliance inspectors. This cannot be done at minor repair points without prohibitive expense.

The curve shows that, to date, we are well ahead of the schedule, but should the curve representing the work done at either shop show a tendency to slope upward too rapidly, it would show that safety appliance work was being neglected and we would at once apply a remedy. On the other hand, we do not want shops to neglect regular repair work in order to make a record on safety appliances, as this might result

any road to equip all of its own cars, and it will probably be necessary for roads to arrange, through the Master Car Builders' Association, to equip one another's cars. This agreement ought not to be delayed too long, as undoubtedly the time allowed by the Interstate Commerce Commission for completing the safety appliance work on freight equipment will not be extended.

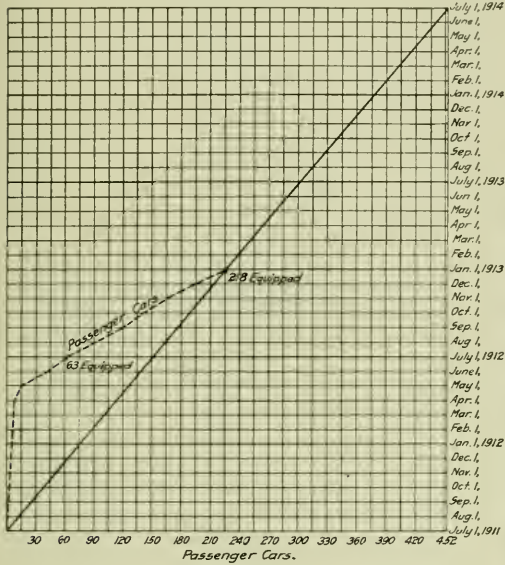

Passenger Cars Equipped with Safety Appliances up to January 1, 1913.

in a substantial increase in per diem charges. The diagram shows whether or not each shop is doing its share of safety appliance work and enables us to maintain a proper balance between safety appliance work and regular repairs. We expect that it will be more and more difficult to get the cars not yet equipped into the shop, and it is probable that the safety appliance curve will gradually approach the limiting line.

As a large percentage of freight cars are continually in operation on foreign lines, it will be almost impossible for

EXPRESS REFRIGERATOR CARS

The car shown in the illustrations is one of 35 steel under-frame refrigerator cars for express service which are being built for Wells, Fargo & Company by the American Car & Foundry Company. These cars are the result of a careful study of the most approved types of refrigerator cars now in

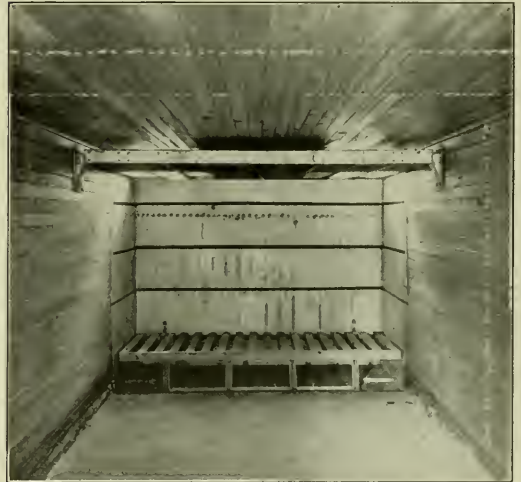

Interior of Express Refrigerator Car.

service, and as they are intended for use in passenger trains they have been constructed to conform to passenger equipment requirements. The cars are 50 ft. long over the end sills and are equipped with four-wheel trucks, spaced 34 ft. between centers and having journals 5½ in. x 10 in. They have a carry-



Wells, Fargo & Company Refrigerator Car for Express Service.

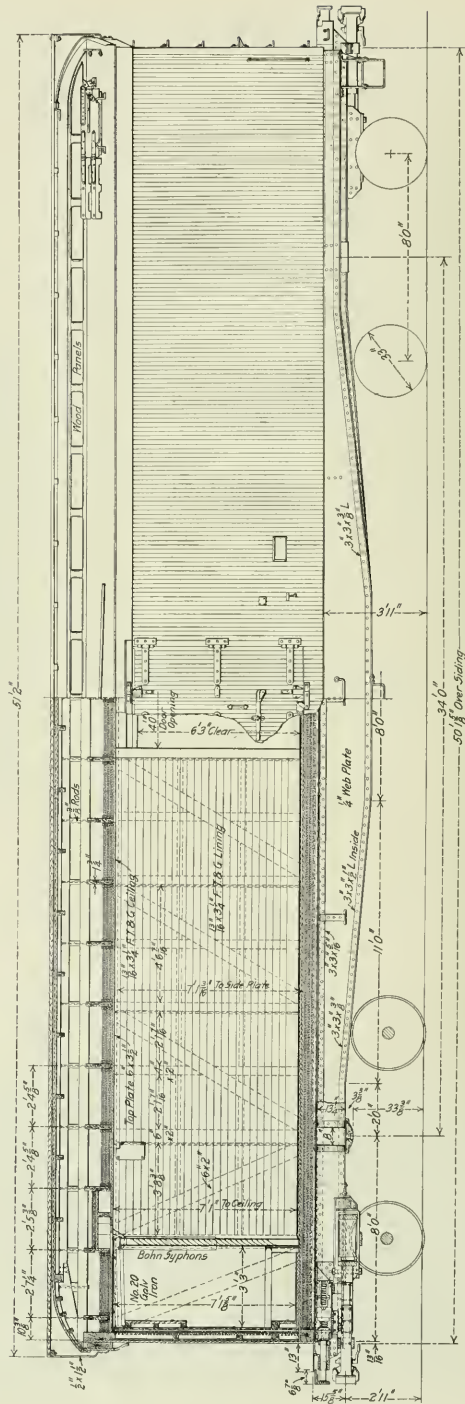
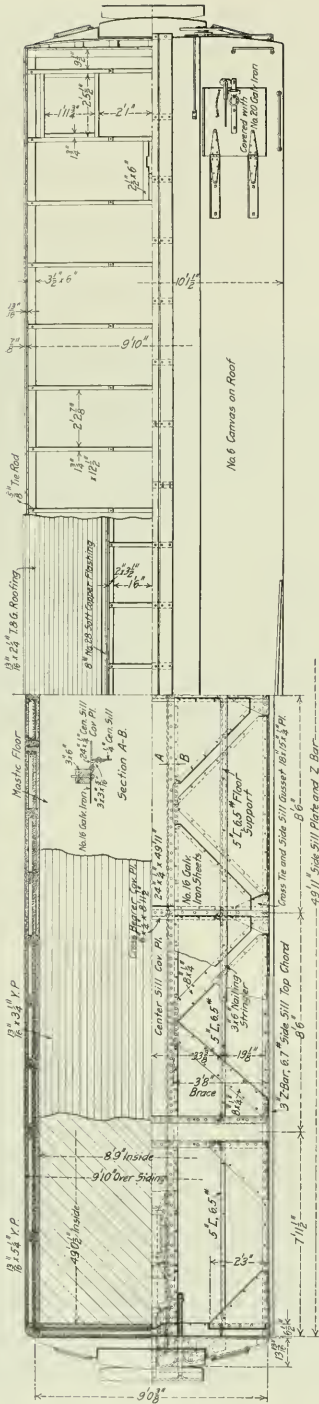

General Arrangement of Wells Fargo & Company Express Refrigerator Car.

ing capacity of 60,000 lbs. of lading and 14,000 lbs. of ice; the total weight is 86,000 lbs.

Special care has been taken to have the cars well insulated. Three courses of $\frac{1}{2}$ in. Keystone hair felt insulation are used, in addition to a layer of Neponset red paper under the sheathing on the sides and ends, and over the roof boards. Three distinct air spaces are provided at all points. In the insulation of the floor there is used, next to the underframe and riveted to it, a layer of No. 16 galvanized iron, over which is laid a

cated below the main floor line, between the four 3 in. x 6 in. yellow pine nailing sills. There are also two 4 in. x $8\frac{3}{4}$ in. side sill fillers, on top of which is laid a $\frac{13}{16}$ in. x $5\frac{1}{4}$ in. yellow pine sub-floor. Neponset red paper is then applied, over which the $\frac{13}{16}$ in. x $3\frac{1}{4}$ in. yellow pine main floor is laid. A protection is provided for the main floor in the nature of H. W. Johns-Manville Company's waterproofing and Mastic flooring, which is laid in layers, and completely covers the floor, except at the ice bunkers, and which also laps 6 in. up each side of the car. As this composition is air and water tight, the car can be kept clean by flushing the floor with water. The ice bunkers are fitted with the Bohn all-steel collapsible bulkhead and syphons. The sides and ends of the ice-bunkers are covered with No. 20 galvanized iron, lapping over the flanges of the floor pan, which is made of No. 12 galvanized steel. The ice grates are made of 3 in. x 3 in. white oak bars.

The center sills, which are of the fish-belly type, are spaced 14 in. apart and are built up of $\frac{1}{4}$ in. web plates with outside angles at the top and inside angles at the bottom, cover plates 24 in. wide being used at the top, forming a box girder. The side sills are also of the built-up, fish-belly type, extending the full length of the car, and are composed of $\frac{1}{4}$ in. web plates, 24 in. deep at the center for a distance of 8 ft., and tapering towards the body bolster to a depth of $10\frac{1}{4}$ in. The top chord members are 3 in. Z-bars, the outside flanges of which form a

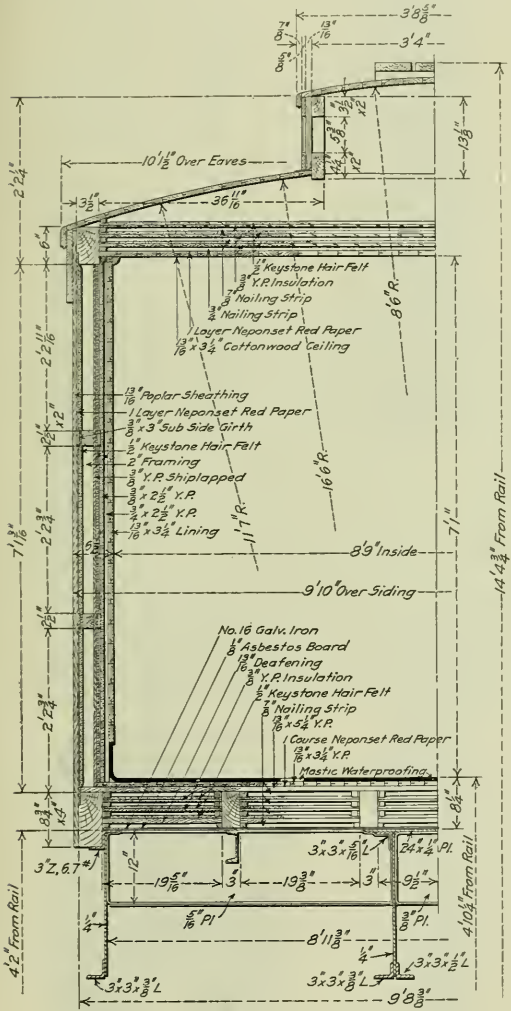

Half Cross Section Through Express Refrigerator Car.

course of $\frac{1}{8}$ in. asbestos paper. There is an air space between this and the $\frac{13}{16}$ in. deafening floor above, on top of which is a layer of $\frac{1}{2}$ in. Keystone hair felt, held in position by $\frac{3}{8}$ in. wood nailing strips. To this is nailed a single course of $\frac{3}{8}$ in. yellow pine insulation, supporting the second course of $\frac{1}{2}$ in. Keystone hair felt, the latter also being held in position by $\frac{3}{8}$ in. nailing strips, which in turn support another course of $\frac{3}{8}$ in. yellow pine insulation; on top of this is laid the third course of $\frac{1}{2}$ in. Keystone hair felt. This insulation is all lo-

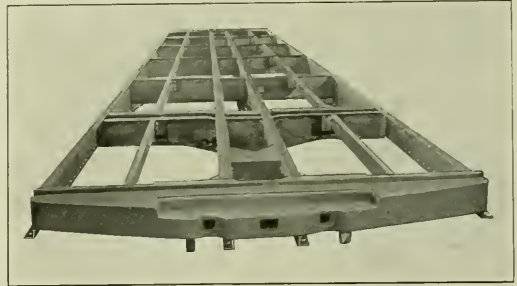

Partially Completed Underframe for Express Refrigerator Car.

support for the wooden superstructure, while the lower chord members are angles.

A combination cast steel end sill and buffer beam is provided, to which connections are cast for the purpose of securing it directly to the side and center sills. A flange is cast on the upper side of the end sill and enters a recess in the oak sub-end sill to prevent the superstructure from shifting on the underframe. The body bolster consists of double $\frac{3}{8}$ in. box shaped pressed members, placed back to back, with an 8 in. space between, the flange ends abutting the side and center sills, while between the center sills a box form pressed shape is used as a filler. Top and bottom cover plates, 14 in. x $5\frac{1}{8}$ in. are used, and extend between the side sills. There are three cross ties used between the holsters built up of box-shaped pressed members, with top and bottom cover plates. Between the side and center sills, 5 in. channels extend the full length of the car, while the underframe is braced by means of 8 in. steel plates extending diagonally between the side and center sills. These are secured to gussets at the side sill ends and are riveted to the center sill top cover plate, while additional gusset plates, $\frac{1}{4}$ in. thick, are used to secure the side sills to the bolsters and end sills.

The roof is of the monitor or clerestory type and is covered with No. 6 roofing canvas. The Miner friction buffing device is used, and the cars are equipped with dummy vestibule mechanism. The air brakes are Westinghouse high speed, with the American Brake Company's automatic slack adjuster.

LOCATING DEFECTIVE CAR WHEELS*

A pamphlet on How to Locate Defective Wheels has been prepared under the direction of D. C. Buell, chief of the Educational Bureau, and printed as a lesson in the course on Car Building and Repairing, given free by the Educational

inspection, how defects may be found in the railroad shop and on the road. An abstract follows:

In spite of the efforts of the railroads to obtain the best product that can be made, wheel failures will occur. In nearly all cases the failures are preceded by certain symptoms. All wheels are numbered and dated when cast, and some



Fig. 1—Brake Burns.



Fig. 4—Shelled Out Wheels.

Bureau to the employees of the Illinois Central. Its chief aim is to assist in promoting safety in the operation of the road by placing a copy of the pamphlet in the hands of every employee, who may, in the performance of his work, be likely

roads have adopted the system of placing a maltese cross, or other similar mark, before the wheel number, which is to be mutilated when the wheel has been rejected or condemned, indicating that the wheel is unfit for service. The

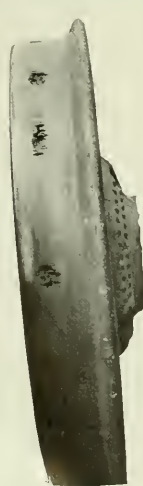

Fig. 2—Comby Formation Caused by Brake Burns.

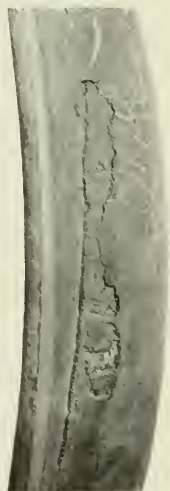

Fig. 3—Seamy Tread.

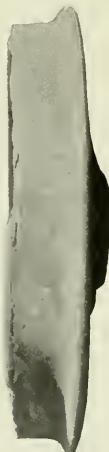

Fig. 5—Chipped Rim.

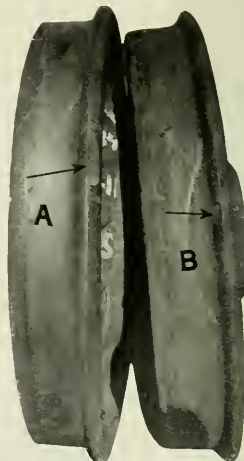

Fig. 6—Chipped Flange.

to discover defects that have otherwise been overlooked. It deals briefly with the manufacture of the wheels, foundry

weight is also shown and the tape measure is stenciled on the outside of the wheel according to the M. C. B. standards. This is done so that wheels of the same tape may be mated together. This is important and should not be overlooked.

DEFECTS DISCOVERABLE IN THE SHOP.

Although the wheels may pass the inspectors at the foundry, there is always a possibility of finding some defects in the

*Copyright, 1913, by the Illinois Central Railroad Company. Abstracted by permission.

shop such as, hollow hubs, hard wheel centers, the core of the wheel in bad condition, warped wheels, flaws, cracks in the brackets and plates and the maltese cross mutilated. These and other obvious items may be sufficient for rejection, and their detection by the shop employees may prevent them from getting into service.

If the hub is too hard to machine, the metal may be chipped away to start the tool, otherwise the wheel may be rejected. If the hub is found hollow, experience will have to be the guide for rejection. Special gages are recommended for turning axles and boring wheels, as a very slight variation in the dimensions will be noticed when pressing the wheels on the axles and may lead to considerable extra work, for the pressure to be applied is limited for the different sizes of wheels. Every wheel should be carefully inspected for a cracked hub immediately after being placed on the axle. The wheels should be mounted at exactly the same distance each side of the center of the axle, for wheels mounted too closely together produce a stepped tread and when too far apart the flanges will be unduly cut in service.

DEFECTS ON THE ROAD.

One of the most common causes requiring renewals of wheels in road service is due to wheels being slid flat. This

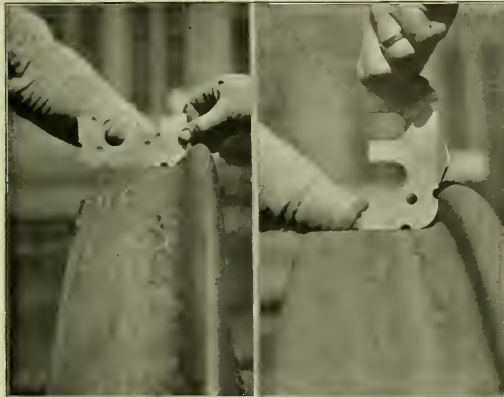

Fig. 7—Chipped Rim.

must be relied on where the shell out is less than 2½ in.

A chipped rim is shown in Figs. 5 and 7. This is generally caused when wheels are passing over frogs and switch points that are defective. Whether or not the wheel should be removed can be determined by the M. C. B. gage as shown in Fig. 7. If the defect extends within the limit mark (the inside edge of the outer notch when the gage is placed as shown in the illustration) the wheel should be condemned.

A chipped flange may occur on the inside or on the throat side as shown in Fig. 6. This is usually caused by trucks being loose or the wheels being improperly mounted or the flange striking guard rails or parts of frogs, including crossings, that are out of line or to the striking of some foreign object lodged in the throat of a frog. If the chipped place is on the inside of the flange; that is, away from the gage side, there is no necessity for condemning the wheel, but if it is on the throat side the standard M. C. B. gage should be used and if the chipping is beyond the gage line, the wheel is unsafe for service and should be removed.

Mismatched wheels, wheels not mounted equidistant from the middle of the axle, or wheels mounted on trucks that are out of square will have excessive flange wear. A sharp flange will not necessarily cause a derailment of itself, but in con-



Figs. 8 and 9—A Sharp Flange and the Way It Is Measured with an M. C. B. Gage.

is due to several reasons, both in the handling of the brakes and in the design of the brake rigging. A slid flat wheel will ruin the iron in the wheel at the point of contact and if the flat spot is 2½ in. long in freight service or 2 in. long in passenger service, or if there is a succession of flat spots around the tread the wheel should be removed. Another defect is that of brake burns. This is caused by overheating the tread of the wheel by continued pressure of the brake-shoe against the wheel. An illustration of this defect is shown in Fig. 1. It will be seen that the cracks are at right angles to the tread of the wheel which causes it to become comby, as shown in Fig. 2. When the wheel has become defective from excessive deterioration due to this cause it should be removed.

A seamy tread such as is shown in Fig. 3 may show up after the wheel has been in service and if it is one inch long, or over, at a distance of ½ in. or less from the throat of the flange, or if a seam 3 in. or more long is found on any other part of the tread the wheel should be removed.

A shelled out wheel is shown in Fig. 4 and the same general rule applies to this class of defect as to the slid flat wheels; that is, if the length of the shell out is 2½ in. or more the wheel should be removed. The judgment of the inspector

in connection with some other defect, such as a faulty switch point or a defective frog, may cause serious results. Also, there is the danger of the flange breaking when it becomes too thin. Figs. 8 and 9 show a sharp flange and the way it is measured with the M. C. B. gage. The wheels shown in the illustration are worn beyond the prescribed limit. A crack of any kind in a wheel with the exception of small cracks in the tread on a spot where brake burning has occurred, or where small slid flat places appear, is sufficient cause to warrant removal of the wheel from service. This includes cracks in the tread, plate, bracket, flange, throat, hub or anywhere else on the wheel. The discovery of a wheel that is loose on the axle naturally calls for its immediate removal. Wheels may also require removal for unusual causes, such as being damaged in a wreck or being in a fire, becoming warped, cracked or blistered on the tread. Care must be taken to remove those that have served their allotted time and where there is evidence of deterioration.

WATER UNACCOUNTED FOR.—According to the report of the department of Public Works, the water unaccounted for in Chicago during 1911 amounted to about 30 per cent. of the quantity delivered to the mains.

THE INSTRUCTION OF CAR MEN ON INTERCHANGE RULES

BY R. W. SCHULZE,

General Foreman, Car Department, Gulf, Colorado & Santa Fe, Cleburne, Texas

Every railroad is anxious that its freight car maintenance charges be as low as possible, and many roads are doing their utmost to strengthen cars in order to reduce the possibility of their needing repairs and to keep them in a serviceable condition, but how many roads are actually checking up their car repairmen to ascertain whether they are studying the M. C. B. code of interchange rules carefully so that items are not being overlooked?

The Master Car Builders' Association, in compiling the code of rules governing the condition of, and repairs to freight cars used in the interchange of traffic, has endeavored in every way to facilitate joint car movement and repairs. The members have realized the necessity of freight car improvements, and also the necessity of proper reimbursement to the progressive roads that care for the equipment of those which are backward and are inclined to keep cars on the rails as long as they will hold together. The rules have been made so broad that all lines must receive a loaded car, no matter what its condition is, as long as it will pass the safety appliance inspection. This has naturally placed the non-progressive railroads very much on the defensive in regard to the increased number of foreign car repair bills which they must pay, and has also placed the progressive roads on the defensive when receiving loaded foreign cars that are badly worn and racked. As a result, car men must be more alert, more thoroughly versed in the interchange rules, and more careful in inspecting and accepting cars; they should, if possible, be thoroughly familiar with all the points, possibilities and technicalities of every rule.

Foremen and inspectors wonder, at times, why they should be required to account for every piece of material and every hour used in repairing cars. The more thoroughly they are versed in the rules the more easily they understand the reasons; but the car repairmen, inspectors and foremen cannot understand and properly carry out the rules without some assistance or instruction. On some roads copies of the revised code are mailed to only the large shops, while on others they are mailed to everybody, with little or no instructions, and often with no comments or reference to changes and alterations. On a few roads, even the arbitration decisions are furnished to the sub-foremen and inspectors.

If the carman is progressive he tries to study the changes made; if not he keeps on in his old path until suddenly reprimanded on some special point from the central office. He corrects this error and keeps on until another one is found, and so on, year after year; the part he understands he handles correctly and what he cannot interpret he passes over. However, he should not be held responsible for slight misinterpretations, when we consider that master car builders, general car foremen and general car inspectors often disagree when discussing the rules; and further that even the code errs on page 13 in omitting "end of car" when specifying the information that must be shown on repair cards when renewing couplers.

Much of the trouble can be eliminated if the men are given proper instructions and the time for this is when the rules are changed. The attention of the men should be called to changes in each rule and to any eliminations or additions, and where a rule is changed it should be interpreted as clearly and explicitly as possible. This should be done by letter, and after the men have their copies of the rules a sufficient length of time to study and understand them, a set of questions in the form of a written examination, bearing particularly on all changes, should be sent to each man. The following four questions, with their answers, will give an idea of how the examination should be conducted:

Question 1.—An A B C car was delivered to the X Y Z, by the D E F, bearing an A B C defect card covering one brake beam, two brake heads and two brake shoes missing from the A end. Necessary repairs were made by the X Y Z on authority of the defect card. Who should be charged with the cost of the repairs and how should the repair card be made out?

Answer.—Two repair cards should be made out. The delivering line should be billed on the defect card for the cost of the material and the owners should be billed for the labor.

Question 2.—Correct a repair card made out as follows: "One coupler applied account broken."

Answer.—The following information must be shown:

Number of couplers applied.

New or second hand.

Kind of material in couplers applied.

Name of couplers applied.

Size of shank.

Size of butt.

Kind of attachment.

Name of couplers removed.

Specify the part of couplers broken.

Kind of knuckle removed and applied (open or solid).

Condition of other parts.

End of car.

Cause of renewal.

Question 3.—By whom, where and how should a card be applied to a car?

Answer.—By the delivering inspector. On wooden cars, on the outside face of the intermediate sill between cross tie timbers; with four tacks. On steel cars, either on the cross tie under the car, or inside at the end of the car.

Question 4.—A B C car 2604 was damaged as follows: Two draft timbers broken, one end sill broken, one coupler rivet broken, one knuckle pin broken; all at A end of car. Can bill be rendered against the owners? If not, what items denote combination?

Answer.—All the repairs are properly chargeable to the car owners; no combination of defects exists.

The central idea should be to make the questions so that the man must read all of the rules and thoroughly understand them in order to answer the questions properly. After the questions are answered and returned, they should be graded and, with the answers corrected, returned to the man examined for his future guidance. By the use of such methods the officer in charge will become familiar with the ability and knowledge of all his subordinates, and will be enabled to assist and instruct men of low standing and to correct the small irregularities and misinterpretations of the man who has a better knowledge of the rules and their requirements.

AGE OF LOCOMOTIVES.—According to a report of the Public Service Commission of New York for the Second District, the average age of the 8,616 locomotives in service in the state, was 9.85 years, on December 31, 1911.

TASMANIAN RAILWAYS.—Tasmania possesses 477 miles of railway on the 3 ft. 6 in. and 2 ft. gage, there being 25 miles of the latter. The main line from Hobart to Launceston, which was the first railway to be constructed, was opened in 1876 by the Tasmanian Main Line Railway Company, and was operated by that company until 1890, when it was purchased by the government. This line is 113 miles long.

LATE TRAINS.—During the year ending October 31, 1912, 81 per cent. of the trains on the New York Central and Hudson River were on time and the average minutes late per train reported was 6.9. During the same period 86 per cent. of the trains on the Long Island were on time and the average minutes late for late trains was 1.9. On the Erie 80 per cent. of the trains were on time and the average minutes late was 6.6.

NEW DEVICES

THE GEE LOCOMOTIVE STOKER

The Gee stoker in its present form is the result of several years' experimenting with different arrangements of the over-feed type of locomotive stoker on the Pennsylvania Lines east of Pittsburgh. It was designed and has been patented by N. E. Gee, of the mechanical engineer's office at Altoona, Pa., and has already successfully fired a large locomotive for over fifty trips, doing 100 per cent. of the firing.

This stoker is of the over-feed or scatter type, employing steam jets for distributing the coal over the fuel bed. It consists essen-

head of the boiler just below the fire door. This opening is the lower part of an enlarged fire door opening of the ordinary construction. The conveyor is of the reciprocating type with swinging fingers and the trough of the inclined section is of cast steel, the bottom having notches or steps which prevent the coal sliding backward.

The coal distributor is simple in its arrangement and consists of a flat cast iron plate or apron extending inside the firebox; two cast iron vertical wings, one on either side, which are hinged at the rear, and two stationary steam jets which discharge, from a point just back of the wings, diagonally across the apron. The

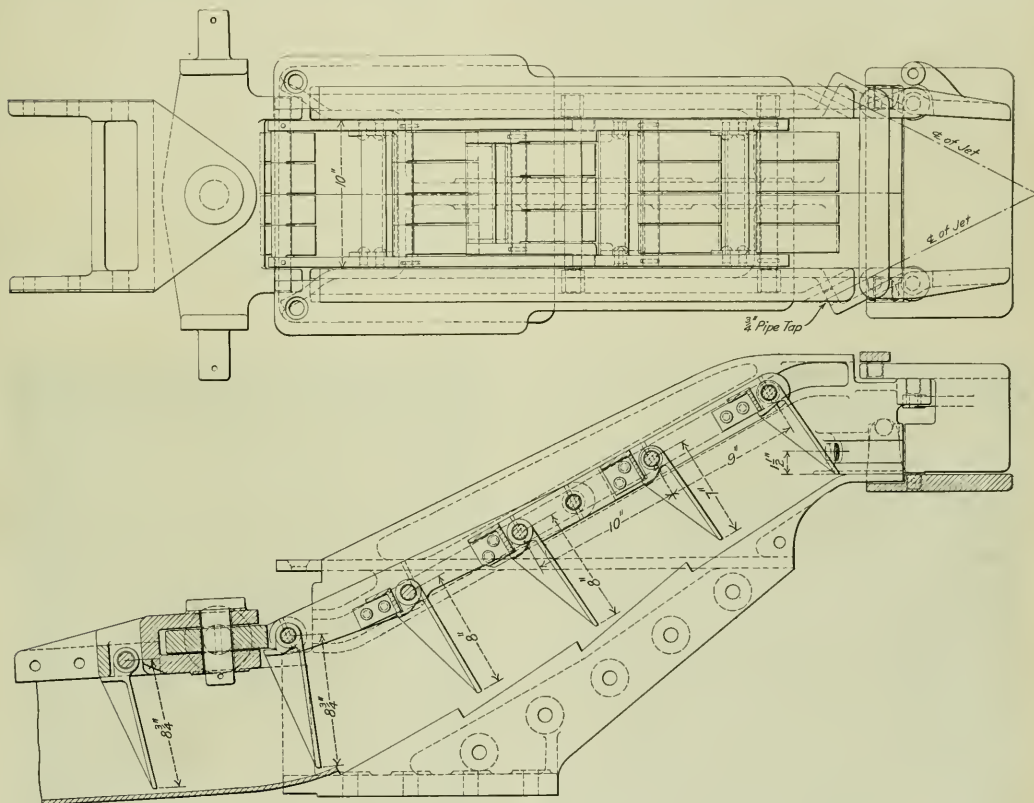

Forward End of the Conveyor and Arrangement of Jets and Deflecting Wings on the Gee Stoker.

tially of four parts, *viz.*, the source of power, the coal crusher, the coal conveyor and the coal distributor. The first three are of the same general style used on the Crawford stoker. The source of power is a cylinder 18 in. diameter and $11\frac{1}{2}$ in. stroke secured to the locomotive frame below the cab, which transmits reciprocating motion through a jack shaft to the coal crusher and the conveyor. The crusher is located beneath the rear end of the coal pocket in the tender and the conveyor is in a trough below the tender floor and transfers the coal from the crusher to the distributor. It is horizontal to the end of the tender and is then inclined upward, terminating at an opening in the back

angle of discharge is such that the center of the two jets meet at a point a few inches in front of the center of the plate. The two wings are connected by a cross bar, giving them simultaneous movement, and are operated by a connection to the fireman's control lever.

The steam jets are intermittent in their action, and are open only at the extreme forward end of the stroke of the conveyor. This is accomplished by means of a nozzle control valve which embodies two separate and independent piston valves, one regulating the amount of the steam discharged through either of the two jets, and the other the intermittent action of the blast.

The latter is operated through a yoke connected to the conveyor driving arm and consists of a differential piston held in a closed position by the steam pressure, except as it is opened by the yoke. The other valve is connected to the fireman's control lever and reduces or entirely closes the passage to one or the other of the nozzles as desired. When the control lever is in the center, the deflecting wings stand parallel to the sides of the conveyor and steam is admitted to both of the blast pipes or jets. In this position the coal is distributed evenly across the grate except in the back corners. When the control lever is pulled to its extreme backward position the deflecting wings are swung to the left and the left nozzle or jet is shut off while the one on the right is wide open. In this position the coal is discharged to the left back corner of the firebox. When the control lever is thrown forward it supplies the right back corner. Intermediate positions between these extremes will place the coal at any desired location on the grate.

Reference to the photographs will show that the stoker occupies but little room in the engine cab and that it in no way interferes with hand firing. The apron and the distributing wings are arranged to be easily removed from the outside of the firebox

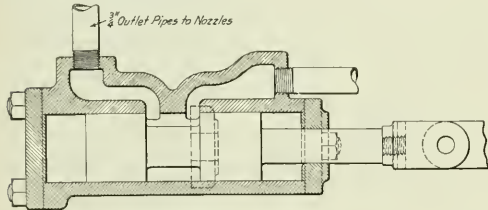
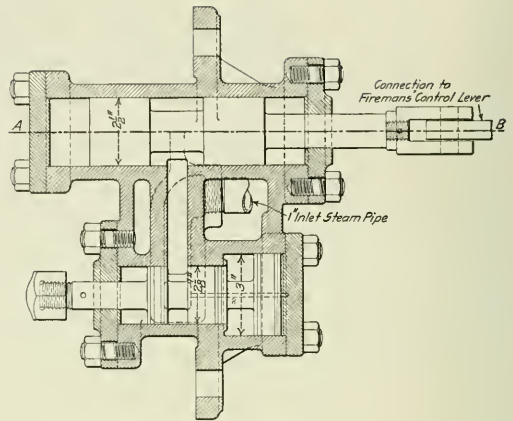

Section A-B

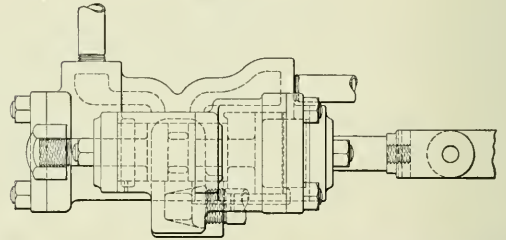

Details of the Nozzle Control Valve Used on the Gee Stoker.



Arrangement of the Coal Conveyor on the Gee Stoker.

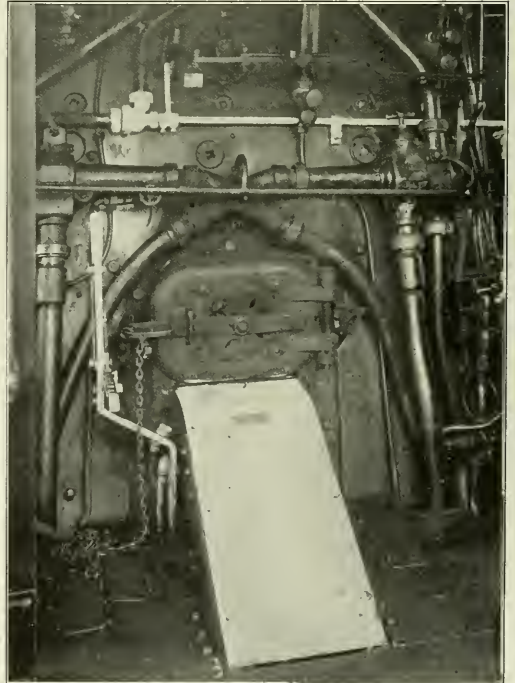

View of the Stoker Showing the Fireman's Control Lever.

for adjustment on the part of the engineman and the opportunity of forcing an additional supply of oil to the various bearings should it be deemed necessary. This latter operation is performed by a crank fixed on the end of the pump shaft within easy reach of the engineman. This system has also been used to a considerable extent for driving journals and it is claimed that a pressure may be maintained in the oil cavity sufficiently high to raise the brass from the journal and thus insure a comparatively perfect film of oil throughout the length of the journal. There are now about 200 of these lubricators in service.

ANTI-FRICTION SIDE BEARINGS

Two types of anti-friction side bearings, intended for heavy loads and short travel, have recently been developed by Edwin S. Woods & Company, Chicago. The illustrations show one with flat sides, which is used for tender trucks, and one with corrugated sides, for freight car trucks. The rollers

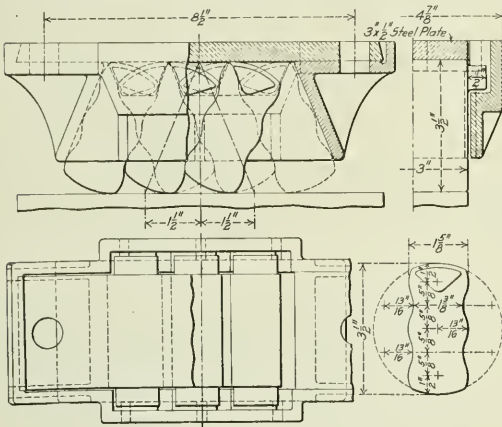

Three-Roller Side Bearing for Freight Cars.

work between oil-tempered steel spring bars, and are made of malleable iron or cast steel. The design is based on the fact that the capacity of rollers varies directly as their diameter and length; that is to say, a roller 1 in. in diameter and 2 in. in length, or 2 in. in diameter and 1 in. in length, will have twice the capacity of a roller 1 in. in diameter and 1 in. in length. In

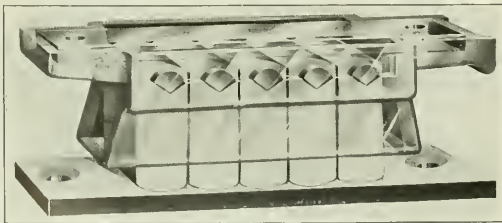

Anti-Friction Side Bearing for Tenders.

the case of the tender roller bearing, there are five rollers 4 in. in diameter and 3 in. long, which are equivalent to one large roller 10 in. in diameter and 6 in. long. These rollers have a side clearance of 1/8 in., and the friction is restricted to the rolling on the two bearing plates.

The drawing shows a three roller bearing for freight cars.

These rollers are corrugated, which allows them to be in contact in all positions and still have a greater length of travel than in the case of the flat-sided roller. In the normal position the corrugations will be in contact at their apices. As the rollers move to one side or the other the apex of one corrugation will slide into the hollow of the other until there is a positive bearing, as shown in the illustration. Of course, it is necessary that these corrugations be carefully made to the correct radius, which is one-half the width of the roller. In this case, the travel is 1 1/2 in. on each side of the center line, making a total of 3 in., which is probably more than will be required in this class of service, although by slight changes in the design of the roller this movement can be increased. The claims of the makers include simplicity of construction, no small parts, little attention required, and large carrying capacity.

THE KLING BOLT

It is claimed that the Kling bolt is the only one that will allow the head to pass through a hole of the same diameter as the stem and still give a firm anchorage for the head on the opposite side of the material through which it passes. To accomplish this the bolt is split, as shown by the illustration, but as the area of the metal at the head is greater than that at the root of the thread the tensile strength is not affected. It is also claimed

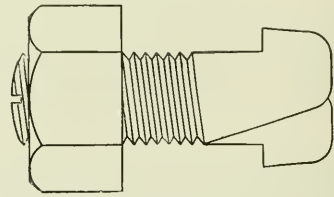

The Kling Bolt.

that the process of heading the bolt does not destroy the fiber of the metal. The bolt is made either with plain head or braced head, the latter being designed for use where heavy strains occur.

This type of bolt is adapted for hollow construction work. One of the illustrations shows the use in attaching brackets, etc., to piping used for a railing, and it is similarly adaptable for swivels, loops, attachments for guy wires, etc. Where gates are

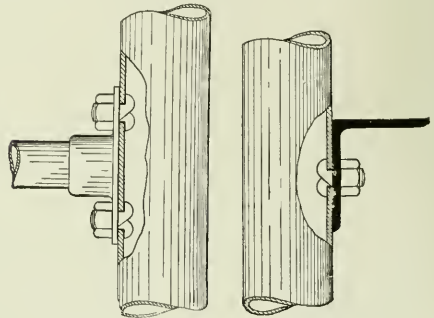

Method of Use in Tubular Construction.

required, hinges may be securely attached to the piping by means of this device, and it is possible to attach fittings of various designs to both round and square columns. A broad field for its use is that of steel passenger car construction. One of the illustrations shows sash and curtain guides bolted to the tubular post of a steel car; where space is limited, a single cur-

tain guide can be used as shown. Composition wood or steel lining can also be readily attached to posts and carlines, and lining fastened with this bolt may be easily removed for repairs and painting.

The bolt is the invention of Peter M. Kling, of the Brooklyn

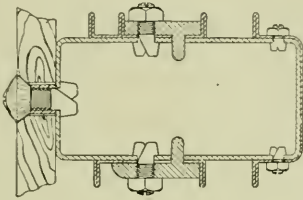

Side Post Construction in Steel Car.

Rapid Transit Company, and is being placed on the market by the U. S. Metal & Manufacturing Company, New York.

MOTOR FOR SHOP SERVICE

A new Westinghouse direct current motor has been placed on the market and is designed for driving bending rolls, raising the crossrails of planers and boring mills, moving the tail-stocks of large lathes and similar service requiring motors with special torque characteristics. The special feature of this motor is a heavily wound compound field, most of the excitation being due to the series coils; and as a result the torque increases rapidly as the current input increases, this being the principal requirement in starting a crossrail, or taking a plate through bending



Westinghouse Direct Current Motor with Special Features.

rolls. The shunt field winding limits the no-load speed to approximately twice the full load speed so that racing is impossible. The commutation is practically sparkless, due to the use of commutating poles and carefully designed commutator and brushes. It is claimed that these motors require very little attention, as the lubrication is automatic and the brushes rarely require renewal. The frame is made of rolled steel, the shaft of axle steel, and the bearings are very large and are dust and oil proof.

The motors are made by the Westinghouse Electric & Manufacturing Company, East Pittsburgh, Pa., and are of capacities from 3 to 40 horse power, for 230 volt direct current circuits.

TESTING EQUIPMENT FOR THE PENNSYLVANIA

During the past year the Pennsylvania Railroad has added a number of new machines to the equipment of its physical testing laboratory. These include the largest universal screw power testing machine ever built which has a capacity of 1,000,000 lbs.; a large vibrating spring testing machine for testing full size locomotive springs to destruction; a hardness tester for tires, wheels, etc., and an endurance tester for subjecting the specimens to alternating stresses under load. These machines were all designed and built by Timius Olsen & Company, 500 North Twelfth street, Philadelphia, Pa.

The 1,000,000 lb. universal testing machine is of the Olsen standard four screw type and is adapted for full size tensile tests on bolsters, truck frames, car couplers, or other similar locomotive or car parts. The table is 10 ft. in length and the crosshead

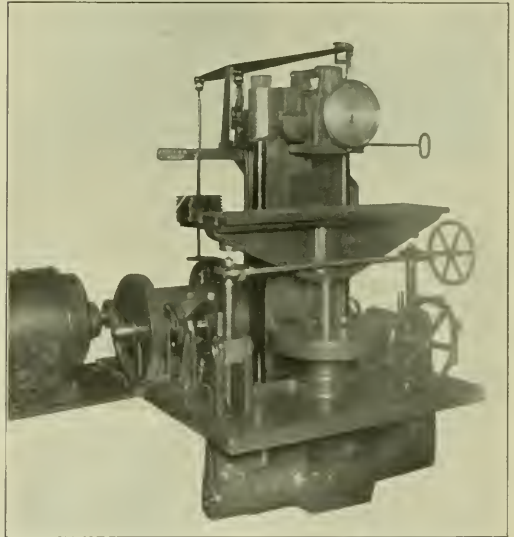

75,000 Lb. Locomotive Spring Tester.

has a movement of 8 ft. The straining system consists of four screws set at 48 in. centers which operate the crosshead through long manganese bronze nuts, each 25 in. in length. The operation is through a system of gearing from a variable speed 25 h. p. motor. The weighing system is of the Olsen standard type terminating in a dial vernier screw beam having three poises. Extremely accurate readings are possible even under the heaviest loads. The weight of the machine is over 100,000 lbs.

The large spring tester is of 75,000 lbs. capacity and of special design. It is shown in the illustration. This is arranged to vibrate the locomotive spring to destruction under load and any static load up to the capacity of the machine can be weighed. The eccentricity for vibration can be varied from 0 to 4 in. This machine is also operated by a 25 horsepower motor.

In the hardness tester provision has been made to accommodate a full size car wheel. This machine makes the test by the penetration of a steel ball into the material and the apparatus

is so designed as to automatically measure this penetration to .0001 in.

A new model White-Southern endurance tester has been installed. This has a direct connected motor drive and is arranged to test three lengths of samples. It is especially adapted for testing heat treated steels. The tests with this machine consist of rotating a standard shape specimen at high speed while under any desired load. The independent speed counters are automatically cut off when the specimen breaks giving a record of the total number of revolutions made.

GRAPHO-METAL PACKING

A new packing has recently been placed on the market by the American Piston Company, Indianapolis, Ind. It is known as the Grapho-Metal packing and is a combination of a special soft babbitt metal and graphite. It is made up of half rings, as shown in the illustrations, and is especially adapted to air pumps, valve stems, throttle rods, etc. It is easily compressed by screwing the gland nut down hard after it has been applied, which forces it against the rod, adapting it to the position or



Nut Lock and Piston Rod Shields for Westinghouse Cross Compound Pump.

shape of the rod, in this way allowing for any imperfections in alinement. The end surfaces of the upper and lower rings contain a lower percentage of graphite, thus forming a support for the packing in cases where the stuffing box clearance is too great; also sealing the packing into the stuffing box, and in this way restricting the loss to service wear only. This is found to be slight, owing to the lubricating qualities of the graphite which is always in contact with the rods.

The air pump packing is divided into rings and is applied

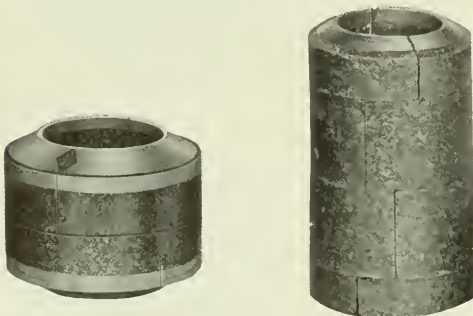

Air Pump Packing.

Throttle Rod Packing.

in the ordinary manner, care being taken to see that the gland nuts are firmly screwed into place. The special advantage of the packing in this service is that no swabs or oil cups are required, as the graphite will give the necessary lubrication. After the pump has been in operation a short time the packing becomes polished, which reduces the friction and wear. Reports from roads using this packing state that it has been in service during the last 18 or 20 months and is still in good

condition. The pumps may be taken out of service and repaired without necessarily destroying the packing, as the lye or acid baths usually given the pumps at such times have no effect on it.

The throttle packing is made up of a number of rings, depending upon the depth of the stuffing box, and is applied in the same manner as on the pump, being screwed hard up into place so that there will be a positive bearing on the rod. The packing for cab fittings is made in one piece. This packing has also been used successfully on injector steam rams and water valve stems, and is being developed for use on steam pistons for superheater as well as for saturated engines.

A combination piston rod shield and nut lock has been devised by the same company for use on air pumps, which, together with the air pump packing described, comprise the air pump packing set. The illustrations show the shields for a Westinghouse cross compound pump. The large shield is shown open ready to be placed around the rod. It is closed and held in position by the bolt and nut shown. The inner sleeve is then raised by pressing down on the adjusting lever until it bears firmly on the upper and lower gland nut. The cam on the head of the bolt is then thrown over, firmly clamping the shield to the gland nuts. The necessary adjustments for making the locking lever effective are made with the knurled nut on the clamping bolt.

BLOWER VALVE

As a means of reducing smoke from engines in and about Chicago, the Chicago & North Western has adopted the use of the blower valve shown in the drawing. It was designed by L. Loedige, engine house foreman on the North Western, and is made on the principle of the rotary valve, such as is used in engineers' air brake valves. An arm $6\frac{1}{4}$ in. long is attached to the stem of the valve and has several holes through it for making a proper connection. The valve is located on the fireman's side and by connecting a rod to the handle and extending it across the boiler head it may be operated by the engineer. A very slight turning of the valve stem will place

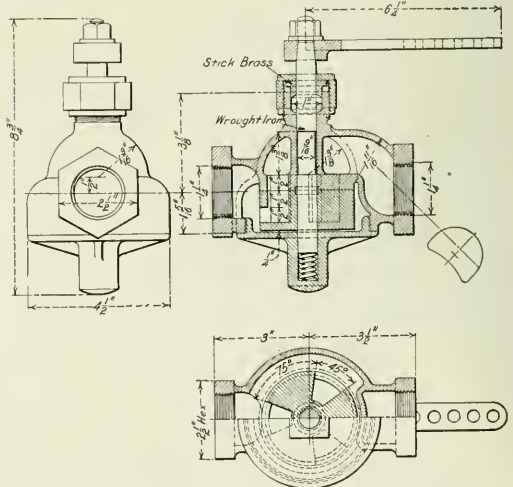

Blower Valve Used on the Chicago & North Western.

the valve in full operation. This valve replaces the ordinary globe valve and has been applied to all engines on the North Western in and about Chicago. It has been patented by Mr. Loedige, but as yet is not on the market for general sale.

NEWS DEPARTMENT

The Canadian Pacific has ordered the establishment of safety committees throughout the company's lines.

The new Grand Central Terminal, New York, was opened for business at midnight, Saturday, February 1, 1913.

Both houses of the Oklahoma legislature have passed a full crew bill. It requires all freight trains to be manned with a fireman, engineer and three brakemen.

The Post Office Department reports that the number of parcels carried in the mails in the month of January was about 40 millions; and over one-tenth of these parcels were mailed in Chicago.

A bill has been introduced in the Iowa legislature requiring that all railway locomotives be equipped with headlights of not less than 1,500 candle power, measured without the aid of a reflector.

A bill has been introduced in the Texas legislature which designates the State railroad commission as a board of arbitration, with power to settle disputes between the railways and their employes regarding wages or conditions of service.

A bill to require all cabooses to be 24 ft. long has been introduced in the New York legislature. The bill goes into minute particulars, specifying the number and length of the berths to be provided for the men to sleep in. After July, 1920, it will be unlawful to use a caboose not complying with the statute.

The Chicago & Alton has refused the demand of unions representing its employes at the Bloomington shops, that the working time in the shops be placed on a basis of eight hours a day, and five days a week instead of six days a week, in order that the full force may have an opportunity to obtain employment.

The new "Overland Limited" express of the Chicago & North Western, announced last year, will be put in service April 1. The train will run between Chicago and San Francisco in 64 hours, and the extra fare will be \$10. On the same date the new train of the Chicago, Milwaukee & St. Paul will be put on, running through in 72 hours.

FIREMEN'S WAGE CONTROVERSY

The eastern railroads and the committee of their firemen have agreed to arbitrate the firemen's demands under the Erdman act. This decision followed the sending of a letter by the railroad's committee, on Tuesday, February 18, to the government conciliators, from which we quote the following paragraph: "At the urgent request of you as representatives of the government, and under the strongest protest we are able to voice, the managers' committee agree to arbitrate the firemen's controversy under the Erdman act. The managers also desire to give notice at this time that they shall earnestly request that the hearings in this arbitration be open to the public."

Following the announcement that an agreement had been reached, Judge Knapp said that the firemen's committee had voted to join the other classes of employes and the officers of the railroads in asking Congress to modify the Erdman act. The railroads have selected W. W. Atterbury, vice-president of the Pennsylvania Railroad, as their member on the board of three arbitrators, and the firemen's committee has named Albert Phillips, third vice-president of the firemen's brotherhood. Mr. Phillips was born in California and began his railway service as a fireman on the Sacramento division of the Southern Pacific fifteen years ago. He was made an engineman in 1903. For the last three years he has devoted his time entirely to his position as an officer of the brotherhood. The third arbitrator has not yet been decided upon.

FATAL ACCIDENTS IN NEW YORK CITY

Not all of the dangerous places in the world are to be found on the railroads, although, at times, one reading American newspapers might get the impression that such was the fact. No less than 2,712 violent deaths occurred in New York City during the calendar year 1912, as reported by the Board of Coroners; and railroad men will be interested in some of the details of this statement, showing the causes of the deaths. Railroads seem to be much more careful of people's lives than are the people themselves. Four hundred and seventy-four of these deaths were suicides; and of the other causes in the list, some of the most prominent are the following:

Accidental falls and falling articles	726	Overlying	32
Accidental burns	267	Choked by food	15
Submersion	229	In subways (none in train accidents)	14
Accidentally overcome by gas	183	Explosions	14
Homicides by shooting	114	Machinery accidents	11
Automobiles	146	Kicked by horse	10
Horse drawn vehicles	108	Electric shocks	5
Surface street cars, electric	62	Accidental cutting	4
Surface street cars, horse drawn 10		On N. Y. C. & H. R. R. R.	3
Elevators	53	Accidental shooting	3
Accidental poison	52		

The number of persons killed in automobile accidents, 146, is 55 more than in the preceding year. Of the accidental falls, 97 were falls from windows, and of the 97 victims 36 were under 14 years of age. Of the 5,697 deaths reported to the coroner's office during the year, 149 were of persons never identified, and of these unidentified 64 were children.

MEETINGS AND CONVENTIONS

General Foremen's Association.—William Hall, secretary and treasurer of the International Railway General Foremen's Association, has changed his address from Escanaba, Mich., to 829 W. Broadway, Winona, Minn. Present indications are that the 1913 convention of this association, which is to be held July 22-25, will be by far the most successful one in the history of the organization. Among the more important reports which are being prepared are those on the maintenance of superheater locomotives, engine house efficiency, shop schedules, and driving box work.

International Railway Fuel Association.—The fifth annual convention will be held at the Hotel Sherman, Chicago, May 21 to 24, 1913. Papers will be presented on the following subjects: Standard Form of Contract, Covering Purchase of Railroad Fuel Coal; Location, Construction, Development and Operation of a Bituminous Coal Mine; Sub-bituminous and Lignite Coal as Locomotive Fuel; The Internal Combustion Engine as applied to Railroad Service; Scaling of Locomotive Boilers and Resultant Fuel Loss; History of the Brick Arch in Its Relation to Locomotive Operation and Fuel Economy; Modern Locomotive Coaling Station: Its Design, Construction, Operation and Maintenance; A Uniform Method of Computing Locomotive Fuel Consumption.

New York Railroad Club.—Safety on Railroads was the title of the paper presented by J. W. Coon, assistant to the general manager, Baltimore & Ohio Railroad, at the February meeting. Mr. Coon explained in detail how the various safety committees are formed on the Baltimore & Ohio, their manner of working and the problems presented to them. This was the first eastern road to undertake a serious study of the safety problem and results have been most satisfactory. This work was started on November 1, 1911, with the appointment of a general safety committee of six officers selected from the different departments and divisional committees of eight which included a shopman,

an engineer or fireman, a conductor or brakeman, a yardman, a station agent, a supervisor or assistant division engineer, a medical examiner and a division claim agent. Half of each division committee is changed every six months. They make weekly reports, a copy of which is sent to the general committee. The ways in which suggestions made are followed up and the problems the committees have had to solve were explained by the author. Evening meetings of the employees and their families are held and lecturers explain how to avoid accidents. Observation tests assist in alertness in avoiding accidents.

Railroad Meeting of A. S. M. E.—The Railway Committee of the American Society of Mechanical Engineers has arranged for the discussion of the subject of steel passenger car design in its various phases at a meeting to be held in the Engineering Societies building, New York City, on the evening of April 8. The first session under the direction of this committee was held at the annual meeting of the society in December, and considered the Factors Involved in the Selection of Locomotives and Train Lighting. It proved so successful that it was decided to hold a second session, as announced above. The following parties have already accepted an invitation to discuss the various phases of the subject: Problem of Steel Car Design, W. F. Kiesel, Jr., assistant mechanical engineer, Pennsylvania Railroad; Suspension of Steel Cars, E. W. Summers, president, Summers Steel Car Company; Truck for Steel Passenger Cars, J. A. Pilcher, mechanical engineer, Norfolk & Western; Provision for Electric Lighting in Steel cars, H. A. Currie, assistant electrical engineer, New York Central & Hudson River; Provision for Electrical Equipment on Steel Motor Cars, F. W. Butt, assistant engineer, New York Central & Hudson River; Special Ends for Steel Passenger Cars, H. M. Estabrook, president, Barney & Smith Car Company; Draft Gears for Steel Passenger Cars, S. P. Bush, Buckeye Steel Castings Company; Cast Steel Double Body Bolster and End Frames for Steel Cars, C. T. Westlake, chief mechanical engineer, Commonwealth Steel Company. Other subjects which will be discussed are as follows—the names of those to whom they have been assigned will be announced later: Introduction to General Discussion of Steel Passenger Cars; Superstructure of Steel Cars; Roof Structure for Steel Cars; Interior Steel Finish for Steel Passenger Cars; Corrosion and Protection of Steel Passenger Cars; Air Brakes for Heavy Steel Passenger Cars; and Special Pressed Steel Shapes for Steel Cars. This is the first time that there has ever been a general meeting of engineers for the discussion of this problem, and it is the intention to bring out the very latest developments in the various features of steel passenger car design. The chairman of the committee is E. B. Katte, chief engineer electric traction, New York Central & Hudson River.

New England Railroad Club.—“Steel Freight Cars” was the subject of the paper presented by Charles A. Lindstrom, chief engineer of the Pressed Steel Car Company at the January meeting of this club. The author briefly discussed the advantages of the steel car and the problems it had introduced. He outlined the more difficult features of design covering the center sills, body bolsters and the connection between the two, pointing out the most desirable arrangement. Illustrations were given of a number of cars to demonstrate the best practice. The author advised

specifications prepared on broad lines and a high grade of inspection, also that repair parts should be ordered in large quantities which would not only decidedly reduce their cost but would also be a saving in time to the railway company ordering them. In connection with specialties, he stated that it would be to the best interests of the railroads to adopt no new designs of the ordinary type freight cars which contain constructions of the vital parts on which they could not obtain competing bids from all manufacturers. He strongly urged a greater uniformity of designs with the ultimate prospect of a common standard car. An engineering board created by the Master Car Builders' Association and the American Railway Association which would prepare the designs for all cars used in interstate commerce was suggested as an ultimate possibility. In the discussion Frank M. Brinkerhoff spoke on the subject of steel passenger cars and urged designers to arrange all cars now being used in steam service so that they could, in the future, be converted for electric service; and in that connection the matter of weights should be carefully considered. F. M. Whyte, vice-president of the Hutchins Car Roofing Company, spoke on the subject of box cars and predicted that within four or five years a wooden upper framing would seldom be used and that probably metal sheathing would also be common. He recommended the use of a flexible all-metal roof. Mr. Steicher, superintendent Keith Car & Manufacturing Company, stated that while structural shapes could be largely used to great advantage, pressed steel frames were absolutely necessary in some places if the minimum weight was to be obtained. This is especially so in connection with steel passenger cars. In closing the paper, Mr. Lindstrom stated that the repair men used in the car yards for working on wooden cars made the best workmen for steel car repairs. He believes that ultimately the joints of steel cars will be made by welding and there will be neither bolts nor rivets required.

The following list gives names of secretaries, dates of next or regular meetings, and places of meeting of mechanical associations.

- AIR BRAKE ASSOCIATION.—F. M. Nellis, 53 State St., Boston, Mass. Convention, May 6-9, 1913, St. Louis, Mo.
- AMERICAN RAILWAY MASTER MECHANICS' ASSOC.—J. W. Taylor, Old Colony building, Chicago. Convention, June 11-13, 1913, Atlantic City, N. J.
- AMERICAN RAILWAY TOOL FOREMEN'S ASSOCIATION.—A. R. Lewis, Central of Georgia, Macon, Ga.
- AMERICAN SOCIETY FOR TESTING MATERIALS.—Prof. E. M. Burgess, University of Pennsylvania, Philadelphia, Pa. Annual convention, June, 1913.
- AMERICAN SOCIETY OF MECHANICAL ENGINEERS.—Calvin W. Rice, 29 W. Thirty-ninth St., New York. Annual meeting, December 3-6, Engineering Societies' Building, New York. Railroad session, Thursday morning, December 5.
- CAR FOREMEN'S ASSOCIATION OF CHICAGO.—Aaron K'ine, 841 North Fifthth Court, Chicago; 2d Monday in month, Chicago.
- INTERNATIONAL RAILWAY FUEL ASSOCIATION.—C. G. Hall, McCormick building, Chicago. Convention, May, 1913, Chicago.
- INTERNATIONAL RAILWAY GENERAL FOREMEN'S ASSOCIATION.—William Hall, Chicago & North Western, Escanaba, Mich.
- INTERNATIONAL RAILROAD MASTER BLACKSMITHS' ASSOCIATION.—A. L. Woodworth, Lima, Ohio. Convention, August 18, 1913, Richmond, Va.
- MASTER BOILER MAKERS' ASSOCIATION.—Harry D. Vought, 95 Liberty St., New York. Convention, May 26-29, 1913, Chicago.
- MASTER CAR BUILDERS' ASSOCIATION.—J. W. Taylor, Old Colony building, Chicago. Convention, June 16-18, 1913, Atlantic City, N. J.
- MASTER CAR AND LOCOMOTIVE PAINTERS' ASSOC. OF U. S. AND CANADA.—A. P. Dane, B. & M., Reading, Mass. Convention, Sept 9-12, 1913, Ottawa, Can.
- RAILWAY STOREKEEPERS' ASSOCIATION.—J. P. Murphy, Box C, Collinwood, Ohio. Convention, May 19-21, 1913, Auditorium Hotel, Chicago, Ill.

RAILROAD CLUB MEETINGS

Club.	Next Meeting.	Title of Paper.	Author.	Secretary.	Address.
Canadian	Mar. 11	Safety First	N. S. Dunlap	Jas. Powell	Room 13, Windsor Hotel, Montreal.
Central	Mar. 14	Rules of Interchange	Committee report	H. D. Vought	95 Liberty St., New York.
New England	Mar. 11	Rules of Interchange	Committee report	Wm. E. Cade, Jr.	683 Atlantic Ave., Boston, Mass.
New York	Mar. 21	Annual Electrical Night	R. Graham	F. O. Robinson	95 Liberty St., New York.
Richmond	Mar. 10	Baker Valve Gear	Hon. Orville F. Berry	B. W. Frauenthal	C. & O. Ry., Richmond, Va.
St. Louis	Mar. 14	Railroads and Railroadng	Prof. E. C. Schmidt	Jos. W. Taylor	Union Station, St. Louis, Mo.
Western	Mar. 18	Locomotive Testing Plant at University of Illinois			390 Old Colony Bldg., Chicago.

PERSONALS

It is our desire to make these columns cover as completely as possible all the changes that take place in the mechanical departments of the railways of this country, and we shall greatly appreciate any assistance that our readers may give us in helping to bring this about.

GENERAL

JOS. CHIDLEY, master mechanic of the Lake Shore & Michigan Southern at Collinwood, Ohio, has been appointed assistant superintendent of motive power of the Lake Shore & Michigan Southern, the Chicago, Indiana & Southern and the Indiana Harbor Belt, with headquarters at Cleveland, Ohio, succeeding S. K. Dickerson. Mr. Chidley entered the service of the Lake Shore & Michigan Southern March 28, 1860, as a machinist at Elkhart, Ind., and in February 1892, was transferred in the same capacity to the Root street engine house, Chicago. In February, 1900, he was appointed foreman machinist at Englewood, Ill., and in December of the same year was appointed acting foreman at the same point. In January, 1901, he went to Elkhart as night foreman and in May, 1901, was appointed foreman at Air Line Junction, Ohio. In November, 1904, he returned to Elkhart as assistant master mechanic and in July, 1906, was appointed master mechanic at Collinwood, Ohio, the position he now leaves.

WILLIAM GARSTANG, superintendent of motive power of the Cleveland, Cincinnati, Chicago & St. Louis, the Peoria & Eastern and the Cincinnati Northern, having requested to be relieved of a portion of his duties, has been appointed general master car builder and S. K. Dickerson, formerly assistant superintendent of motive power of the Lake Shore & Michigan Southern, has been appointed superintendent of motive power, both with headquarters at Indianapolis, Ind. Mr. Garstang was born February 28, 1851, in England, and was educated in the public schools. He began railway work in 1863 as a machinist apprentice with the Cleveland & Erie, now the Lake Shore & Michigan Southern, at Cleveland, Ohio, where he remained six years. He was then for 11 years machinist and general foreman for the Atlantic & Great Western and the New York, Pennsylvania & Ohio; three years general foreman of the Cleveland & Pittsburgh division of the Pennsylvania Company, and five years master mechanic of the Cleveland, Columbus, Cincinnati & Indianapol. now the Cleveland, Cincinnati, Chicago & St. Louis. From 1888 to April, 1893, Mr. Garstang was superintendent of motive power of the Chesapeake & Ohio, and in the latter year became superintendent of motive power of the Cleveland, Cincinnati, Chicago & St. Louis.

S. K. DICKERSON, assistant superintendent of motive power of the Lake Shore & Michigan Southern, has been appointed superintendent of motive power of the Cleveland, Cincinnati, Chicago & St. Louis, with headquarters at Indianapolis, Ind. Mr. Dickerson was born January 16, 1859, at Prescott, Wis., and entered railway service in 1880. He was a machinist with the Missouri, Kansas & Texas, at Parsons, Kan., to 1881 and

with the Pennsylvania from 1881 to 1883 as machinist at Tyrone and Altoona, Pa. From 1883 to 1894 he was machinist, gang foreman and shop foreman of the Norfolk & Western, at Roanoke, Va., and from 1894 to January, 1900, was master mechanic of the Radford division of that road at East Radford, Va., and general foreman at Roanoke, Va. From January to May, 1900, he was master mechanic of the Toledo division of the Lake Shore & Michigan Southern and from May, 1900, to August, 1902, was, in addition, master mechanic of the Eastern and Franklin divisions. In August, 1902, he was appointed master mechanic of the same road at Collinwood, Ohio, and in 1906, was appointed assistant superintendent of motive power, the position he now leaves.

H. D. JACKSON has been appointed general master mechanic of the Alabama, Tennessee & Northern and the Tombigbee Valley, with headquarters at Panola, Ala. He is also in charge of the shop at Calvert, Ala.

D. E. LEARY, formerly road foreman of engines and round-house foreman of the Atchison, Topeka & Santa Fe, at Fort Madison, Iowa, has been appointed fuel inspector with headquarters at Amarillo, Texas.

GEORGE McCORMICK has been appointed assistant general manager (mechanical) of the Galveston, Harrisburg & San Antonio, the Houston & Texas Central, the Houston East & West Texas, the Houston & Shreveport and the Texas & New Orleans, and superintendent of motive power and machinery of Morgan's Louisiana and Texas Railroad and Steamship Company, and the Louisiana & Western, with headquarters at Houston, Tex., succeeding J. W. Small, resigned.

H. W. RIDGWAY has been appointed superintendent of motive power and car department of the Colorado & Southern, with office at Denver, Col., succeeding H. C. Van Buskirk, resigned on account of ill health. Mr. Ridgway was born July 17, 1866, at Delaware Water Gap, Pa. He was educated in the common schools and began railway work in November, 1881, as machinist apprentice with the Denver & Rio Grande. From May to December, 1887, he was successively journeyman and foreman of the Mexico Central at Mexico City, and then for four years was with the Denver & Rio Grande as a journeyman and gang foreman. He returned to the Mexico Central in 1893, and until 1901, was foreman and master mechanic. In February of the latter year he went to the El Paso & Northeastern as superintendent of machinery, and from April, 1903, to February 1, 1904, he was superintendent of the contract shop. He then became superintendent of shops of the Mexican Central at Aguascalientes, Mex., where he remained until December 1, 1905. On January 1, 1906, he was appointed master mechanic of the Colorado & Southern and the Atchison, Topeka & Santa Fe at Denver, Col., from which position he has been promoted to that of superintendent of motive power and car department, as above noted.

N. L. SMITHAN has been appointed assistant superintendent of motive power of the Missouri, Kansas & Texas of Texas, with office at Dennison, Tex.

T. A. SUMMERSKILL has been appointed superintendent of motive power of the Central Vermont, with headquarters at St. Albans, Vt.

MASTER MECHANICS AND ROAD FOREMEN OF ENGINES

W. E. ANDERSON, master mechanic of the Colorado & Southern at Trinidad, Col., has been transferred to Denver, Col., as master mechanic of the Colorado & Southern and the Atchison, Topeka & Santa Fe, succeeding H. W. Ridgway, promoted.

HENRY BLAKE has been appointed road foreman of engines of the Plains division of the Atchison, Topeka & Santa Fe, with headquarters at Amarillo, Texas.



W. Garstang.

FRANK BOYD has been appointed road foreman of equipment of the Chicago Terminal division of the Rock Island lines, succeeding R. E. Wallace, promoted.

F. T. CHASE, whose appointment as master mechanic of the Missouri, Kansas & Texas Railway of Texas, with headquarters at Smithville, Tex., was announced in the February, 1913, issue of the *American Engineer*, was born at Atlanta, Ga., August 25, 1862. He was educated in the common schools, and after serving an apprenticeship as millwright and machinist, began railway work in October, 1881, as a locomotive fireman on the Texas & Pacific. From April, 1882, to September, 1887, he was engaged in other business, on the latter date re-entering railway service as a machinist for the Missouri, Kansas & Texas of Texas. He was a locomotive engineer on that road for ten years from August, 1889, and in August, 1900, he was appointed foreman of machinery at Smithville, Tex., which position he held until his appointment as master mechanic.

JAMES BRATTELL RANDALL, whose appointment as master mechanic of the Louisville, Henderson & St. Louis, with headquarters at Cloverport, Ky., was announced in the January, 1913, issue of the *American Engineer*, was born on January 8, 1861, at Athens, Ohio. He received a college education, and on November 12, 1879, began railway work with the Pittsburgh, Fort Wayne & Chicago, now a part of the Pennsylvania System, remaining with that road for five years when he went to the Indiana, Bloomington & Western, now a part of the Cleveland, Cincinnati, Chicago & St. Louis. He was then chief engineer of stations for four years with the Parkersburg Electric Light & Power Company, and later for one year was in the service of the Newport News & Mississippi Valley. On December 11, 1891, he became an engineman on the Louisville, Henderson & St. Louis, and on September 6, 1910, was promoted to the position of assistant master mechanic, which position he held at the time of his recent appointment as master mechanic of the same road, as above noted.



J. B. Randall.

FRANK COVALT has been appointed road foreman of equipment of the Oklahoma division of the Rock Island lines, succeeding C. S. Yeaton, promoted.

J. M. DAVIS has been appointed master mechanic of the Colorado & Southern at Trinidad, Col., succeeding W. A. Anderson, transferred.

W. H. EVANS has been appointed district master mechanic, second district, British Columbia division of the Canadian Pacific, with headquarters at Vancouver, B. C.

J. E. FITZIMONS has been appointed master mechanic of the Central Vermont, with headquarters at St. Albans, Vt.

H. L. FOSTER has been appointed road foreman of equipment of the Arkansas division of the Rock Island lines, with headquarters at Argenta, Ark., succeeding S. T. Patterson, resigned.

O. M. FOSTER, division master mechanic of the Lake Shore & Michigan Southern, at Elkhart, Ind., has been appointed master

mechanic, Lake Shore division, with office at Collinwood, Ohio, succeeding Joseph Chidley, promoted.

M. D. FRANEY, assistant master mechanic of the Lake Shore & Michigan Southern at Collinwood, Ohio, has been appointed master mechanic of the same road at Elkhart, Ind., succeeding O. M. Foster, transferred.

T. L. FRENCH has been appointed road foreman of equipment of the Kansas division of the Rock Island lines, with headquarters at Herington, Kan., succeeding F. Connolly, promoted.

R. C. HYDE has been appointed master mechanic of the Louisiana division of the Chicago, Rock Island & Pacific, with headquarters at El Dorado, Ark., succeeding H. J. Osborne, resigned.

B. F. KUHN, superintendent of shops of the Lake Shore & Michigan Southern at Collinwood, Ohio, has been appointed assistant division master mechanic at that point, succeeding M. D. Franey, promoted.

C. T. McELVANY has resigned as master mechanic of the Missouri, Kansas & Texas of Texas, at Dennison, Tex.

R. Q. PRENDERGAST has been appointed master mechanic of the Cincinnati, Hamilton & Dayton, with headquarters at Indianapolis, Ind., succeeding W. G. Rose, resigned.

J. W. RECORDS has been appointed master mechanic of the Plains division of the Atchison, Topeka & Santa Fe, with headquarters at Amarillo, Tex., succeeding C. J. Drury, resigned.

R. E. WOOD has been appointed road foreman of equipment of the Colorado division of the Rock Island lines, succeeding J. L. Boyle, promoted.

CAR DEPARTMENT

J. L. CUPP has been appointed car foreman of the Rock Island lines, at Waurika, Okla., succeeding E. A. Dolloff, resigned.

P. D. GALARNEAU, shop superintendent of the Armour Car Lines at St. Louis, Mo., has been transferred in that capacity to Meridian, Miss., succeeding A. B. Chadwick, resigned. Mr. Galarnau will also have charge of the New Orleans, La., and Mobile, Alabama, repair forces.

J. C. ROWE has been appointed shop superintendent of the Armour Car Lines, at South Omaha, Neb., succeeding C. H. Taylor, transferred.

C. H. TAYLOR, shop superintendent of the Armour Car Lines at South Omaha, Neb., has been transferred in that capacity to St. Louis, Mo., succeeding P. D. Galarnau.

SHOP AND ENGINE HOUSE

J. BRUNER has been appointed apprentice instructor of the Atchison, Topeka & Santa Fe, at Newton, Kan.

P. I. COSTELLA, division foreman of the Atchison, Topeka & Santa Fe, at Las Vegas, N. M., has been appointed general roundhouse foreman, with headquarters at Albuquerque, N. M.

A. F. DAVIS has been appointed assistant roundhouse foreman of the Rock Island lines, at Rock Island, Ill., succeeding F. Maher, transferred.

COBURN FALKENSTEIN has been appointed machine foreman of the Atchison, Topeka & Santa Fe, at Winslow, Ariz.

T. F. GAFFNEY has been appointed division foreman of the Wyoming district, Northern division, of the Colorado & Southern, with headquarters at Cheyenne, Wyo.

MARTIN J. GUNTHER, erecting foreman of the El Paso shops of the El Paso & Southwestern, has been appointed acting general foreman in place of Geo. Bruchlacher, granted leave of absence on account of ill health.

EARL G. LOWE has been appointed apprentice instructor of the Atchison, Topeka & Santa Fe, at Topeka, Kan., succeeding J. J. Heim.

GEORGE B. McELVY, general foreman boilermaker of the Erie, has been appointed foreman boilermaker of the Seaboard Air Line at Jacksonville, Fla.

FRANK MOLINE has been appointed roundhouse foreman of the Atchison, Topeka & Santa Fe, at Gallup, N. M.

W. O. MORTON has been appointed assistant roundhouse foreman of the Rock Island lines, at Burr Oak, Ill., succeeding R. Ostendorf, assigned to other duties.

L. C. NYER has been appointed general foreman, locomotive department, of the Rock Island lines, at Cedar Rapids, Iowa, succeeding C. J. Drury, resigned.

J. P. PEACH has been appointed night roundhouse foreman of the Atchison, Topeka & Santa Fe, at Shopton, Iowa.

FRED A. STUDER has been appointed general foreman of the Chicago & Eastern Illinois at Yards Center, near Chicago.

J. SUHL, roundhouse foreman of the Atchison, Topeka & Santa Fe, at Las Vegas, N. M., has been appointed division foreman at that point, succeeding P. I. Costella, promoted.

PURCHASING AND STOREKEEPING

JOSEPH J. BENNETT has been appointed assistant purchasing agent of the Illinois Central, with headquarters at Chicago.

GEORGE H. JENKINS has been appointed assistant to general purchasing agent of the Grand Trunk, with office at Montreal, Que.

T. J. LOWE has been appointed fuel agent of the Canadian Northern and the Duluth, Winnipeg & Pacific, with headquarters at Winnipeg, Man.

F. W. MAHL, assistant to director of maintenance and operation of the Southern Pacific, has been appointed director of purchases of that road and the Southern Pacific of Mexico, succeeding W. V. S. Thorne, resigned.

H. W. MORRIS has been appointed purchasing agent of the Wabash Pittsburgh Terminal and the West Side Belt Railroad Company, with headquarters at Rook, Pa.

J. C. SNYDER has been appointed assistant purchasing agent of the New York Central & Hudson River, with headquarters at Grand Central Terminal, New York.

The office of purchasing agent of the Texas & Pacific, heretofore held by C. Ludolph, has been abolished, and hereafter matters pertaining to the purchasing department will be handled through Vice-President Freeman's office at New Orleans, La.

RAILROAD CONSTRUCTION IN THE PHILIPPINES.—During the fiscal year ended June 30, 1912, 65 miles of new line were opened to traffic in the Philippine Islands, 33 miles were graded and track was laid on 43 miles.

NEW TRANSANDINE RAILWAY.—Engineers have now completed the plans for the new Transandine Railway the Chilean government intends to construct through the Maipo river valley, placing Santiago in direct communication with Buenos Ayres, Argentina, the journey taking only 30 hours.

PURE DRINKING WATER ON TRAINS.—The Treasury Department has issued an order to the effect that the drinking water on all trains, cars and boats used in interstate commerce must be certified by state or municipal authorities as being incapable of conveying disease. Ice which is put into drinking water must be taken from a safe source, duly certified, and must be washed with water that is safe; and must be handled so as to prevent contamination. Water containers must be cleaned by scalding at least once a week.

NEW SHOPS

ARMOUR CAR LINES.—The shops at Meridian, Miss., are being enlarged to accommodate a force of 300 men. The improvements include new tracks, machinery and buildings, and the work of making the changes is in charge of P. D. Galarneau, shop superintendent.

ATCHISON, TOPEKA & SANTA FE.—A temporary six-stall engine house is to be constructed at San Angelo, Tex.

BOSTON & MAINE.—A contract has been let for an addition to the roundhouse at Springfield, Mass.

CANADIAN PACIFIC.—Appropriations for improvements include the following: In Ontario, a 6-stall addition to the roundhouse at Fort William; at Kenora, a 6-stall addition to the roundhouse; in Manitoba, a 5-stall addition to the roundhouse at Minnedosa; in Saskatchewan, a 4-stall addition to the roundhouse at Arcola; in Alberta, a 6-stall addition to the roundhouse at Alyth; a 2-stall addition to the roundhouse at Lacombe.

CHICAGO, ROCK ISLAND & PACIFIC.—This company is planning to build new repair shops, a roundhouse and additional yards on the east side of the city of Des Moines, Iowa.

GULF, COLORADO & SANTA FE.—This company has appropriated \$260,000 for shop and engine house improvements.

HOUSTON & SHREVEPORT.—A contract has been let for the construction of a new roundhouse at Shreveport, La.

MICHIGAN CENTRAL.—Extensive additions are being planned to the shops at Jackson, Mich., including an addition 250 ft. long to the main shop building, a new blacksmith shop and a new 30-stall roundhouse.

MISSOURI PACIFIC.—A roundhouse and machine shop are to be built at Joplin, Mo.

MISSOURI & NORTH ARKANSAS.—Plans have been prepared for machine shops at Eureka Springs, Ark., and Harrison, Ark.

NASHVILLE, CHATTANOOGA & ST. LOUIS.—This company is building a machine shop at Paducah, Ky.

NEW LINE FOR BRAZIL.—The government of the State of Minas, Brazil, has signed a contract with Col. José Caetano Pimentel for the construction and operation for 50 years of a railway to run from the Doce river, near the Bueno Brandao colony, to Urucu station on the Bahia-Minas Railway.

NEW LINE FROM SHANGHAI TO PEKING.—China has opened her shortest cut from Shanghai, on the sea, to Peking. Early in December through traffic was opened from Pukow, on the Yangtze river (opposite Nanking) to Tientsin, and a journey is now possible from Shanghai to Peking tin 40 hours as against 5 days by the previous shortest route. The only other line from the Yangtze to Peking is that from Hankow, about 755 miles long. The newly opened line from Pukow to Tientsin is 626 miles, and that that has to be added the 73 miles from Tientsin to Peking and the 193 miles from Shanghai to Nanking, making the total rail distance from Shanghai to Peking some 892 miles, which is broken only by the Yangtze river at Nanking. The first through trains to run over the line from Pukow to Tientsin left Tientsin and Pukow, respectively, on December 4, and two trains per week are now running from both places, leaving Pukow for Tientsin on Mondays and Fridays at 9 a. m., and arriving at Tientsin on the following days at 11:07 a. m.; and leaving Tientsin for Pukow on Wednesdays and Saturdays at 1 p. m., and arriving at Pukow on the following afternoons at 3:15 p. m. The trains are provided with dining cars and comfortable sleeping cars, and passengers may make the journey in comparative comfort.

SUPPLY TRADE NOTES

The H. W. Johns-Manville Company, New York, has opened a branch office in the Dooly block, Salt Lake City, Utah.

C. J. Olmstead, who has been assistant manager of the Westinghouse Air Brake Company in the western district, has been appointed western manager with headquarters at Chicago. Mr. Olmstead was born in Concord, Mich., and in 1890 entered the employ of the Pullman Company at Chicago, as chief clerk in the manufacturing and sales department. He remained with this company in various capacities for several years, leaving in April, 1905, as assistant to the general manager, to become associated with the Westinghouse Air Brake Company as commercial representative in the western district. This position he held until he was promoted to the office of assistant western manager with headquarters at Chicago, on June 1, 1912, which position he has held until his promotion to the position of western manager.



C. J. Olmstead.

F. H. Allison has been appointed general purchasing agent of the American Vanadium Company and the Flannery Bolt Company.

A. B. Chadwick, superintendent of the Armour Car Lines shops, at Meridian, Miss., has resigned to become superintendent of the Grip Nut Company's plant, at South Whitney, Ind.

W. G. Rose, master mechanic of the Cincinnati, Hamilton & Dayton, at Indianapolis, Ind., has resigned to become mechanical superintendent of the Procter & Gamble Company, Cincinnati, Ohio.

John Hoffhine, for nine years assistant chemist of the Union Pacific at Omaha, has accepted an appointment with the American Brake Shoe & Foundry Company, with headquarters at 30 Church street, New York.

William N. Thornburgh has been appointed general manager of sales of the Standard Asphalt & Rubber Company, Chicago, with jurisdiction over the water-proofing, engineering, mastic floor and paving departments.

Frank N. Grigg, eastern representative of the Adams & Westlake Company, Chicago, for the past ten years, has resigned to become district manager of the Standard Heat & Ventilation Company, Inc., New York, with office at Washington, D. C.

Nathan B. Payne, who has been associated with Manning, Maxwell & Moore, Inc., New York, for several years, has been appointed manager of sales of the Davis-Bournonville Company, manufacturers of oxy-acetylene welding and cutting apparatus, 90 West street, New York.

A new company, under the name of Littlefield, Fry & McGough, has been incorporated with offices in the Monadnock block, Chicago, to make electric welded joints, as licensees of the Lorain Steel Company. The officers are Emmet M. Fry, president and general manager; S. P. McGough, vice-president, and Arthur S. Littlefield, secretary and treasurer.

The O. M. Edwards Company, Syracuse, N. Y., has been in-

corporated with \$1,000,000 common stock and \$250,000 seven per cent. preferred stock to make among other things freight car equipments, including padlocks, valves, etc. The officers are as follows: President, O. M. Edwards; first vice-president, W. A. Le Brun; second vice-president and assistant manager, E. W. Edwards; and secretary-treasurer, J. J. Edwards.

H. M. Perry has accepted a position with Edwin S. Woods & Co., Chicago, and will devote his energies to both the mechanical and sales departments. Mr. Perry has had a wide experience in car building, having been connected with the Flint & Pere Marquette, the Atchison, Topeka & Santa Fe, and the Algoma Central & Hudson Bay in the capacity of master car builder. He was also connected with the Pullman Company about 1885 as general superintendent, and shortly thereafter with the United States Rolling Stock Company in the same capacity; and at a later date with the Madison Car Company as manager. Later he devoted about three years to expert investigation on brake beams in service.

Leigh Best, vice-president of the American Locomotive Company, New York, in charge of finance, has been given full charge of the automobile department of this company in addition to his present duties. It is the purpose of the company to segregate the automobile department from the locomotive department so far as is practicable. Mr. Best was born at Chatham, N. Y., on November 4, 1867. He received a high school education and in 1892 entered the legal department of the New York Central Lines, with office in New York. Later he was made assistant to the president, while S. R. Callaway was president. In June, 1901, Mr. Callaway resigned his position to become president of the American Locomotive Company and brought Mr. Best with him as secretary of that company. Mr. Best retained that position until June, 1904, when he was made third vice-president in charge of financial, accounting, legal and corporate matters, which position he still holds. In future Mr. Best will divide his time between his present office at 30 Church street and his new office at 1886 Broadway.

John Fritz, pioneer ironmaster and one of the first to introduce the Bessemer process in this country, died at his home in Bethlehem, Pa., on February 13 at the age of 91. Mr. Fritz was born

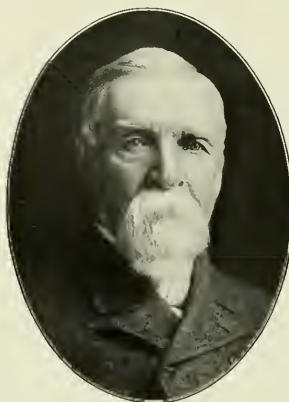

John Fritz.

in Chester county, Pa., on August 21, 1822. He received his early education in a country school and became an apprentice in a blacksmith shop in 1838. In 1844 he went to a mill for rolling bar iron at Coatesville, Pa., still serving as an apprentice. After three months he was made a mechanic, and three months later he was given charge of the industry as ironmaster. In 1852 he was associated with a brother and two brothers-in-law in the establishment of a small foundry and machine shop at Catasauqua, and two years later

he assisted in the construction of the Cambria Iron Works at Johnstown. In the same year he was made superintendent of that company. In 1860 he was called upon to design the plant of the Bethlehem Iron Company. He accepted, and when the plant was completed he was made superintendent and engineer. It was there that he helped perfect the Bessemer process, which was introduced in 1864. He was one of the very first to recog-

nize its significance, and a large measure of its success is due to him. In 1886 Mr. Fritz built for the Bethlehem company a plant for the manufacture of armor plate, which was the first plant of its kind in this country. He introduced processes from England and France for the manufacture of this product. He resigned his position as president of the Bethlehem Steel Company in 1893 and retired from active business. Mr. Fritz was a vice-president of the American Society of Mechanical Engineers from 1882 to 1884, and was president in 1896. He had also been president of the American Institute of Mining Engineers, and was an honorary member of the American Society of Civil Engineers. In 1893 he was awarded the Bessemer medal by the Iron and Steel Institute of England, and in the same year was elected an honorary member of that institute, one of the greatest honors an engineer can receive. His eightieth birthday was celebrated by a dinner given in his honor at the Waldorf-Astoria, New York, on which occasion the John Fritz gold medal for achievement in educational sciences in this country was founded. This medal is awarded annually by a committee of the American Society of Civil Engineers, the American Society of Mechanical Engineers, the American Institute of Mining Engineers and the American Institute of Electrical Engineers. The first medal was conferred upon John Fritz himself. Mr. Fritz understood thoroughly every branch of the iron and steel industry, and his great value lay in his genius for organization, his ability to improve upon methods and his capacity for handling men.

Another important addition has been made to the Westinghouse associated companies by the incorporation of the Locomotive Stoker Company, which corporation will take over the patents,

good-will and all other rights and interests, pertaining to mechanical stokers for locomotives, heretofore owned by the Westinghouse Air Brake Company. This includes the Street locomotive stoker, which has been so successfully developed under the auspices of the Westinghouse Air Brake Company, by Clement F. Street, who now becomes vice-president and one of the directors of the Locomotive Stoker Company. The directors of the company are: H. H. Westinghouse, John F. Miller, A. L. Humphrey, W. S. Bartholomew and Clement F.

Street. The officers of the company are as follows: W. S. Bartholomew, president; A. L. Humphrey, vice-president; Clement F. Street, vice-president; F. L. Wassell, secretary; P. W. Lander, treasurer, and J. H. Eicher, auditor. The headquarters of the company will be at Schenectady, N. Y., where the Street stokers will be manufactured as heretofore. Additional manufacturing facilities have been provided to care for the rapidly increasing demand. The New York office of the company is at 30 Church street, and the Chicago office, 827 Railway Exchange building.

W. S. Bartholomew, recently elected president of the Locomotive Stoker Company, has been in the railway supply business for over twenty-five years, having been for many years western representative of the Adams & Westlake Company, and later eastern manager of that company, with headquarters at Philadelphia. He went with the Westinghouse Air Brake Company, as New England manager, in 1903, and became western manager in 1905, which position he has held to date.

A. L. Humphrey, who, in addition to his many other duties, becomes one of the vice-presidents of the Locomotive Stoker Company, is well known in railway and railway supply circles, having

for ten years prior to 1888 been apprentice, foreman and master mechanic on the Chicago, Burlington & Quincy, Union Pacific, Southern Pacific and Atchison, Topeka & Santa Fe railroads. From 1888 to 1903 he was superintendent of motive power of the Colorado Midland, Colorado Southern and Chicago & Alton railroads; 1903 to 1905, western manager of the Westinghouse Air Brake Company, Chicago; 1905 to 1909, general manager of the Westinghouse Air Brake Company, Pittsburgh, and from 1909 to date vice-president and

general manager of the Westinghouse Air Brake Company, which position he still holds.

Clement F. Street, vice-president of the Locomotive Stoker Company was born near Salem, Ohio, and at the age of 18, after attending college for one year, entered the works of the Buckeye

Engine Company as a machinist's apprentice. After three years he entered the drawing office of the same company. The next two years were spent in drawing office work and in erecting steam engines and boilers on the road. For two years after this he was chief draftsman for the Johnstown Company, Johnstown, Pa., and for the following four years, chief draftsman in the motive power department of the Chicago & St. Paul Railway with office at Milwaukee, Wis. In 1892 he resigned this position to go to the

Railway and Engineering

Review, Chicago, as mechanical editor, with which publication he remained for seven years, both as mechanical editor and manager. One year of this time, however, was spent in a trip around the world in the interest of the Field Columbian Museum. He left the *Railway and Engineering Review* to go to the Dayton Malleable Iron Company and spent nine years in designing and selling railway supplies for this company, for the Wellman, Seaver, Morgan Company, Cleveland, Ohio, and for the Westinghouse Electric & Manufacturing Company, Pittsburgh, Pa. In 1907 he conceived his general idea of the locomotive stoker and arranged with the Westinghouse Air Brake Company to supply the necessary funds for developing it. Since that time he has devoted his entire time and energy to the perfection of the device, and during the past year has conducted a regular business of making and selling these stokers under the firm name of Clement F. Street, Inc., Schenectady, N. Y.



A. L. Humphrey.



W. S. Bartholomew.



Clement F. Street.

CATALOGS

BABBITT METAL.—The Magnolia Metal Company, 113 Bank street, New York, have issued a booklet which they call "Magnolia Talking Points," and which contains information concerning babbitt metal.

PUSH BUTTON CONTROL.—The General Electric Company, Schenectady, N. Y., has issued bulletin A-4070, describing the electrically operated remote control switch. This switch is especially adapted for controlling group drives in shops where it is desired to have instantaneous stops in various parts of the shop.

ELECTRIC APPARATUS.—A small catalog from the Sprague Electric Works of the General Electric Co., New York, illustrates and briefly describes some of the specialties manufactured at that plant. These include principally electrical equipments for buildings, such as generators, gasolene-electric generating sets, switchboards, motors, electric fans, lamps, etc.

PIPE UNIONS.—A leaflet from the Jefferson Union Company, Lexington, Mass., demonstrates, by means of illustrations and brief description, the advantages of the Jefferson unions. These unions are so constructed that a wrench of any width of face can be used and the threads are so placed that there is no danger of their being injured by the wrench. The pipe threads are made with a taper tap.

GRAPHITE PRODUCTS.—A catalog of 104 pages devoted exclusively to Dixon graphite products is being issued by the Jos. Dixon Crucible Company, Jersey City, N. J. The catalog is most complete, is thoroughly illustrated and includes a price list. It covers crucibles in capacities from a few ounces to one thousand pounds, lubricating graphites of all kinds, graphite paints, graphite specialties, pencils and erasers.

PNEUMATIC TOOLS.—Bulletin No. 124 from the Chicago Pneumatic Tool Company, Fisher Building, Chicago, is devoted to pneumatic riveting, chipping and calking hammers. These are shown in a full range of sizes and capacities, and tables are included giving the specifications of each tool. An extract from an article by G. H. Hays on the care of pneumatic hammers is included. Bulletin No. 130 from the same company gives instructions on the lubrication of pneumatic tools.

TOOL STEELS AND MANUFACTURING COSTS.—A booklet is being issued by the Firth-Sterling Company, McKeesport, Pa., for the purpose of presenting and proving the statement that if a tool steel will increase the output of a machine one per cent., an increased cost of 50 per cent. in the price of the tool steel is justified. It is stated in this argument that one-sixth of a pound of high speed steel is used on an average 20 in. lathe each day. This is based on work such that the tool requires grinding five or six times a day.

SHAPE BOOK.—The Illinois Steel Company, Chicago, Ill., has issued a leather bound book on structural shapes. The book is very thoroughly illustrated with detailed drawings of the various shapes and devices, containing the regular standard structural beams, as well as agricultural beams, concrete reinforcement bars, pipe bands, miscellaneous mill shapes, rails, etc. In the back of the book there are tables containing the weights of different sizes of flat rolled steel, wire gages, areas and circumferences of circles, etc.

THREADING MACHINERY.—Catalog No. 21 from the Landis Machine Company, Inc., Waynesboro, Pa., contains 79 pages, and illustrates bolt threading, pipe and nipple threading, bolt pointing and nut tapping machinery, screw cutting, die heads and special threading machines. These are shown in a full assortment of sizes, and each is accompanied by a table of specifications and a list of the equipment furnished. The cata-

log opens with a discussion of the features of the Landis die as compared with those of other threading tools; the reasons for its development and the success it has attained in actual practice.

MIKADOS FOR THE CHESAPEAKE & OHIO.—Bulletin No. 1012 from the American Locomotive Company, New York, gives the results that have been obtained in service with the Mikado locomotives built for the Chesapeake & Ohio. It is shown that these engines save 14 per cent. of the coal on a ton-mile basis as compared with consolidations. The dynamometer record from a test with a train of 7,590 tons is shown, and the capacity of the engine on various grades is given in one of the tables. These locomotives are of special interest, from the fact that their success led to a number of later and equally successful designs which are now in service on other roads.

SPARK ARRESTER.—Burton W. Mudge & Company, Chicago, Ill., have issued a four-page leaflet illustrating and describing the Mudge-Slater spark arrester or locomotive box front end, as it is sometimes called. This device was developed on the Chicago & North Western, for the elimination of spark throwing from locomotives. It takes the place of all of the usual front end nettings and baffle plates; it is much more simple in its construction, and is much easier maintained. It forms a seal between the front end and the stack, permitting only those cinders that will pass through the meshes of the netting to escape. It is installed on a large number of locomotives, and has not only proved to be an efficient spark arrester, but also a fuel economizer. It is especially desirable for locomotives traversing wooded territories.

REVERSING MOTORS.—Bulletin No. A-4081 from the General Electric Company, Schenectady, N. Y., gives a discussion of the advantages of, as well as a description of the apparatus required in connection with the use of reversing motors on planers and slotters. This type of reversing motor application was illustrated on page 46 of the January issue of this journal. The bulletin, however, gives more extensive illustrations and a more complete description of the details. Bulletin A-4085 from the same company is devoted to a complete description of battery charging motor-generator sets intended for use in connection with charging storage batteries.

BALL BEARINGS ON MACHINE TOOLS.—Reducing the friction of a bearing not only reduces the loss of power and the amount of lubricant required, but what is even of more importance in the case of a machine tool, it reduces the wear. Ball bearings largely reduce friction and, when they themselves do not cause an added source of trouble, the attendant advantages are very desirable. As an example of what can be accomplished with their use on a lathe there is quoted in a recent catalog from the Hess-Bright Manufacturing Company, Front street and Erie avenue, Philadelphia, Pa., the case of a 14-in. Lodge & Shipley lathe used in regular daily service, which was equipped with ball bearings on the spindle in 1905. This machine was put to work on alloy steel of great toughness and after six years' use examination showed the bearings to be in perfect condition and the lathe to have an error of only .0008 in. These bearings had received no attention during this time and were oiled but once a year. This catalog also discusses the use of bearings for various parts of different machine tools and illustrates suggested arrangements of the ball races in the different applications.

LIQUOR ON PASSENGER TRAINS.—The legislature of Indiana has passed a law making it illegal for any person to drink intoxicating liquors on a passenger train or car, steam or electric, except in case of actual sickness of the person using the stimulant, and excepting also drinks taken in cars regularly licensed to sell intoxicating liquors. The penalty for violation of this law is from \$5 to \$25.

AMERICAN ENGINEER

"THE RAILWAY MECHANICAL MONTHLY"

(Including the Railway Age Gazette "Shop Edition.")

PUBLISHED ON THE FIRST THURSDAY OF EVERY MONTH, BY THE SIMMONS-BOARDMAN PUBLISHING COMPANY, WOOLWORTH BLDG., NEW YORK, N. Y.

CHICAGO: Transportation Bldg. CLEVELAND: Citizen's Bldg. LONDON: Queen Anne's Chambers, Westminster.

EDWARD A. SIMMONS, President HENRY LEE, Secretary. L. B. SHEERMAN, Vice-President. A. E. HOVEN, Business Manager. The address of the company is the address of the officers.

ROY V. WRIGHT, Editor. R. E. THAYER, Associate Editor. E. A. AVERILL, Managing Editor. A. C. LOVON, Associate Editor. GEORGE L. FOWLER, Associate Editor.

Subscriptions, including the eight daily editions of the Railway Age Gazette published in June in connection with the annual conventions of the Master Car Builders' and American Railway Master Mechanics' associations, payable in advance and postage free:

United States, Canada and Mexico.....	\$2.00 a year
Foreign Countries (excepting daily editions).....	3.00 a year
Single Copy	20 cents

Entered at the Post Office at New York, N. Y., as mail matter of the second class.

WE GUARANTEE that of this issue 5,750 copies were printed; that of these 5,750 copies 2,450 were mailed to regular paid subscribers and 125 were provided for counter and news companies' sales; that the total copies printed this year to date were 20,176—an average of 5,044 a month.

VOLUME 87. APRIL, 1913. NUMBER 4.

CONTENTS

EDITORIALS:	
Supplies that Cost Nothing?.....	169
Improving Valve Gears.....	169
Work of the Firemen.....	169
Car Department Competition.....	170
Decreasing Shop Operating Costs.....	170
Locomotive Connecting Rods.....	170
Another Locomotive Testing Plant.....	171
New Books.....	172
COMMUNICATIONS:	
Handling Sand on Locomotives.....	172
Turning Driving Wheel Bires Shops.....	173
Exhibits Open in the Evening.....	173
Moving Pictures in Railway Educational Work.....	174
GENERAL:	
Locomotive Connecting Rods.....	175
Chrome-Vanadium Steel Wheels.....	181
Transmission of Electric Power.....	182
Superior European Roundhouse Facilities.....	185
Effect of Pigments on the Constants of Linseed Oil.....	189
Standardization of the Myriawatt.....	190
Baltic Type Locomotive.....	190
SHOP PRACTICE:	
Smith Shop Tools.....	191
Pneumatic Hammer for Boilers Shops.....	191
Turning Four-Bar Crosshead Wrist Pins.....	192
Shop Improvements at Burnside, Ill.....	193
A Link Grinding Machine.....	198
Repairing Locomotive Driving Boxes.....	199
CAR DEPARTMENT:	
Car Department Notes.....	203
Removing Flat Spots from Car Wheels.....	204
Growing Cost of Freight Car Repairs.....	205
Fifty-Ton Low Side Gondola.....	207
Steel Underframe Car for the Reading.....	211
Illumination of Postal Cars.....	212
NEW DEVICES:	
Locomotive Valve Gear Driven from the Crosshead.....	215
Rumsey Freight Car Door.....	216
Heavy Milling Machine.....	217
Postal Car Lighting Fixtures.....	218
Removing Scale from Arch Tubes.....	219
Non-Kinking Air and Steam Hose.....	219
Prest-O-Welder.....	220
Steel Box Car Ladder.....	220
NEWS DEPARTMENT:	
Notes.....	221
Meetings and Conventions.....	221
Personals.....	222
New Shops.....	224
Supply Trade Notes.....	224

Supplies That Cost Nothing?

"We are not interested in fuel economy; you know our coal does not cost anything. The company owns the mines." How well this statement, recently made by a railroad officer, represents the state of mind that exists with many officers and a large number of employes in regard to the value of railway supplies. The machinist thinks, "It makes no difference if I ruin this reamer or milling cutter, they are made here in the tool room and do not cost the road anything." The car repair man says, "Why should I bother to pick up those good bolts, our bolt department turns out thousands of them every day." The fireman cares nothing about overloading the tender and putting a half ton of coal on the ground; the coal chute men are there anyway and it will not cost anything to the railroad for picking it up. And so it goes on. A coal shovel, a pint of valve oil, a monkey wrench or a jack are valuable and must be taken care of, but a steel bar pounding an ash pan until it leaks, or the burning up of a long 1½ in. drill is of no importance, as they are made at the shops and do not cost anything (?).

Improving Valve Gears

In an attempt to correct an undoubted, but generally believed to be a minor fault of the ordinary types of locomotive valve gears, which results from the change in the relative positions of the main driving axle and the cylinders, a designer on the Chicago, Peoria & St. Louis has very materially increased a much more serious difficulty by practically doubling the weight of the gear. This design is illustrated and described in this issue, and it will be seen that in the effort to obtain a rigidly supported source of motion for an ordinary Walschaert gear, a number of very heavy parts have been added. The advisability of attempting any great refinement in the steam distribution of a locomotive is doubtful, especially where the ordinary reverse lever is employed. The conditions of operation are so constantly varying that in order to obtain the benefit of a thoroughly accurate valve gear giving an ideal steam distribution, it is necessary to make frequent small adjustments in the location of the point of cut-off. The full advantage of a refinement of this kind is entirely impossible with a reverse lever, and it is doubtful if it would actually be made even with a screw reverse gear. The experience of valve gear manufacturers and designers of locomotives has always led to the same conclusion, i. e., extreme accuracy in valve events or in steam distribution is not possible or even advisable. The successful valve gears have been those which presented a simplicity of arrangement, a low cost of maintenance and ease of inspection. On the other hand, a reduction in the weight of a valve gear is of decided importance. It is quite probable that when the design throughout is refined as it will be in the future, and advantage is taken of the high quality materials that are available, even the present valve gears will seem large and cumbersome. Any effort toward increasing the weight of the valve gear without an undoubted corresponding advantage is a move in the wrong direction.

Work of the Firemen

At one of the sessions of the Arbitration Board which is hearing arguments in connection with the demand of the locomotive firemen for increased wages, D. F. Crawford, general superintendent of motive power of the Pennsylvania Lines West, presented some interesting statistics based on actual observation of the amount of time spent by a fireman in manual labor. These observations covered a large number of trips, including both stoker and non-stoker locomotives running on various divisions of the Pennsylvania Railroad. The average for non-stoker locomotives weighing over 200,000 lbs. shows that the fireman is actually engaged in supplying coal to the firebox about 15 per cent. of the total time of the trip. He is shaking the grates, hooking the fire or shoveling down coal about 5 per

cent. of the time (this feature varies considerable on different runs), is engaged in other manual labor about 6 per cent. of the time and is idle, so far as performing manual labor is concerned, about 71 per cent of the time. On a stoker locomotive weighing over 200,000 lbs. he is engaged in supplying coal to the firebox with a shovel about 2 per cent. of the time, shaking grates, hooking fire, etc., about 5 per cent. of the time, performing other manual labor about 2 per cent., and is idle about 91 per cent. of the time. At the same time Mr. Crawford presented some statistics in connection with the increase in weight, tractive effort and coal consumption of locomotives. This was based on information from 40 railways. It shows that during the past three years the tractive effort has increased on an average of less than 7 per cent., the weight on drivers slightly over 7 per cent. and the coal consumed per locomotive mile 3.2 per cent. The wages of the firemen have increased 6 per cent. in the same length of time. For a twelve-year period from 1900 to 1912 these statistics show that on freight locomotives, the tractive effort has increased on an average of 52 per cent., the weight on drivers 46½ per cent., pounds of coal consumed per locomotive mile 47 per cent., while the wages have increased 59 per cent.

Car Department Competition

Eight papers were submitted in the car department competition which closed February 15. These were set in type, so that the judges might not be prejudiced in any way against those which were sent in in longhand and were not as easy to read as if typewritten, and were forwarded to nine judges, including five car department officers and four mechanical engineers who are noted because of the car designs which they have developed. The papers were numbered and each judge was requested to advise which number, in his opinion, should receive first prize, and which the second. The first prize of \$50 was awarded to F. F. Gaines, superintendent of motive power of the Central of Georgia, for his article on "The Growing Cost of Freight Car Maintenance and the Remedy," which appears elsewhere in this issue. The second prize was awarded to L. W. Wallace, assistant professor of car and locomotive design at Purdue University, for an article describing the method of designing a steel gondola car. An article by R. W. Schulze, general foreman car department of the Gulf. Colorado & Santa Fe at Cleburne, Tex., pushed Prof. Wallace's article hard for the second place. All of the articles possess merit and all have been accepted for publication, and checks are being mailed to the authors. The other competitors, with the titles of their papers, are as follows: C. L. Alden, foreman car repairs, New York Central & Hudson River, West Albany, N. Y., on Freight Car Troubles; Frank J. Borer, department foreman, Central of New Jersey, Elizabethport, N. J., on Defective Applications of Brake Apparatus; C. L. Bundy, general foreman, Delaware, Lackawanna & Western, Kingsland, N. J., on Freight Car Design; H. S. Fentress, foreman car department, Norfolk Southern, Berkley, Va., on Box Car Construction as Viewed by a Repairer; and H. E. Parsons, Berwick, Pa., on Tank Car Design.

The judges were F. W. Brazier, superintendent rolling stock of the New York Central & Hudson River; J. M. Borrowdale, superintendent car department of the Illinois Central; R. W. Burnett, general master car builder of the Canadian Pacific; J. C. Fritts, master car builder of the Delaware, Lackawanna & Western; J. H. Gimpel, general foreman car department of the Frisco Lines; W. F. Keisel, Jr., assistant mechanical engineer of the Pennsylvania; John A. Pilcher, mechanical engineer of the Norfolk & Western; W. P. Richardson, mechanical engineer of the Pittsburgh & Lake Erie; and C. A. Seley, mechanical engineer of the Rock Island Lines.

Six of the judges awarded the first prize to Mr. Gaines, one to Mr. Wallace, one to Mr. Alden, and one to Mr. Bundy. In addition to receiving one vote for the first place, Mr. Wallace received four for the second place; Mr. Schulze received three

votes for the second place; Messrs. Fentress and Alden each received one vote for the second place.

Decreasing Shop Operating Costs

An excellent example of what may be done economically to reduce the operating costs of old shops is shown in the changes that have been made at the Burnside shops of the Illinois Central, a description of which is given in another part of this issue. In this case a number of stationary engines were distributed throughout the plant to provide power for the various shops. These were supplied with steam from a main boiler plant, necessitating long steam lines, and also required high class labor for their operation. In cold weather it was found impossible to meet the steam demands with the boiler equipment at hand, and as a result several locomotives were pressed into service which provided the steam at a very high cost. By careful study and investigation it was found that it would be cheaper to discontinue the use of the individual engines, have one main engine room for the generation of electricity, and to generally electrify the shops. The results clearly show how money may be saved by bringing a plant up to date. The boiler plant has been rearranged so that a saving of about 50 per cent. in its operating cost has been effected, and by the addition of generators and some 150 to 175 motors the total cost of operation has been reduced, so that it will pay an annual return on the money invested to make these changes.

In many cases the very word "electrify" carries with it the feeling of additional costs for seemingly luxurious means of shop operation, but it has been proved in cases of this kind that the added expenditure is money well invested. This phase of shop operation should be carefully considered where unsatisfactory results are being obtained in the shop operation, for if carefully considered, and as carefully applied, there would be no more remunerative returns than this class of betterment work. There is no other method of power so susceptible of being expanded as the electrified shop, and there certainly is no more convenient service, especially where both the alternating and direct current are available. It is generally acknowledged that these two classes of power are quite essential, and in many cases where one only is directly provided it has been found expedient to install a motor generator set to provide the other.

The installation of low pressure turbines to use the exhaust steam from the main engines was adopted after a careful study of the possibilities of the economy in heating the plant with exhaust steam as against low pressure steam. The work is a credit to the mechanical department of the Illinois Central and bespeaks the value of maintaining a sub-department under the control of a competent shop engineer who devotes his whole time to the important problem of shop operation.

Locomotive Connecting Rods

The breaking of a locomotive main or side rod is an infrequent occurrence, but when it does occur the accident usually happens when the locomotive is in motion and most generally at high speeds. The fact that there are not more accidents of this kind speaks well for the ability of the designers, particularly those of the locomotive builders, for it is there that most of the rods are designed. A committee of the Master Mechanics' Association presented an excellent and quite complete report on the subject of main and side rods at the 1911 and 1912 conventions, which included a number of formulas, among them being those used at the Baldwin Locomotive Works. In this issue H. A. F. Campbell, who is largely responsible for the development of the standards of the Baldwin Locomotive Works in this particular, presents a complete explanation and discussion of these formulas and includes many tables, some of which give results of experiments that have not been heretofore published, while others are constants and ratios that will be found very convenient.

When rods do break it is very frequently found that the fault lies not with the design but with the material. Most American railways use open hearth steel having an ultimate tensile strength of 80,000 lbs. per sq. in. and the maximum working stress allowed should not be greater than 10,000 lbs. per sq. in. It has been found that even under the most rigid inspection, flaws in the steel will sometimes remain undetected and the rod will eventually break although the design was correct in every particular. This is especially true with I-section rods which are milled from a solid bar. In some cases return has been made to the rectangular section because of this difficulty while in others the rod is being forged to the I-section. Alloy steels, particularly those containing vanadium, are now also being used to some extent. It is evident that even after the rod is designed and has a size and shape that is properly suited for the conditions, its strength is by no means assured and the kind of material, methods of manufacture and ability of the inspectors need an equal or greater attention.

The question is frequently asked, "Why are main and side rods on European locomotives so much lighter than those on American locomotives?" Mr. Campbell presents data which shows that they actually are not lighter when the amount of work as performed by each rod is considered. Many of the European locomotives are of the four cylinder type and most of them have very short rods. This, taken in connection with the cross section selected by most of the foreign designers, makes the rods look decidedly lighter, but actually they are not, when compared on the basis of pounds of load carried to each pound of rod.

Another Locomotive Testing Plant

It would be impossible to estimate the value of the results to the railroads of the world, that have come from the locomotive testing plants at Purdue University, the St. Louis World's Fair and at Altoona. A scientific investigation of many features of design or operation of a locomotive is largely dependent upon results of tests that can be made only on a testing plant. Road tests are of great importance and give results which cannot be obtained by a testing plant, but, on the other hand, the testing plant furnishes data that cannot be reliably procured from any kind of a road test. It is only on the testing plant that all the conditions can be controlled so as to obtain reliable information on the effect of varying a single condition. The value of testing plant work is particularly evident in connection with the investigation of all questions relating to boiler and firebox performance and the action of steam in the cylinders.

A new and much larger locomotive testing plant will be put in operation at the University of Illinois during the current month. Its general arrangement and prominent features were described by Prof. E. C. Schmidt in a paper presented at the March meeting of the Western Railway Club. This plant will be decidedly larger than any in existence and is arranged to permit the testing of articulated locomotives of the largest size. The dynamometer will permit measuring draw-bar pulls up to 125,000 lbs., and the bed plate of the plant is of sufficient length to allow the installing of the largest locomotive now in use. It thus appears that it will soon be possible to obtain reliable information on some of the problems peculiar to the articulated type of locomotive of large size, concerning which there is now considerable doubt. In a general way the new testing plant is very similar to the one owned by the Pennsylvania Railroad and the one at Purdue University. The carrying wheels and their supports have the same general arrangement and provision has been made for the use of two diameters of supporting wheels, a feature of considerable importance for a plant that is expected to make tests at both high and low speeds. The Alden friction brake used on all of these plants for absorbing the power does not operate satisfactorily at very low speeds, while on the other hand difficulty may be incurred with the bearings and with the control of the water pressure on the brakes at very high speeds. In the new plant supporting

wheels either 52 in. or 72 in. in diameter may be used. At a speed of the locomotive drivers corresponding to 10 miles an hour the smaller wheels will have a speed of about 65 revolutions a minute. The larger wheels will have a speed of about 420 revolutions a minute at a locomotive speed corresponding to 50 miles an hour.

The dynamometer is of the same general type, but of much larger capacity than the one at Purdue, and employs the graphical recording of the pressure of oil in a closed chamber for obtaining the record of the draw-bar pull. This differs from the Pennsylvania dynamometer, which does not employ a liquid medium, but is arranged to give a pen movement of 8 in. from the maximum draw-bar movement of .04 in. by a system of levers and the torsion of a steel rod. It has a maximum capacity of 80,000 lbs. pull.

There has never been an entirely satisfactory method evolved for procuring accurate information as to the amount of fuel lost through the locomotive stack in the form of sparks and cinders. At Altoona various plans and arrangements have been tried, resulting finally in the building of an inclosed superstructure on top of the testing plant inclosure and providing vents for the gradual escape of smoke and gases at such points that there would be no direct draft to carry away the lighter cinders. This method, while it gave fairly accurate returns, has not been altogether satisfactory. Arrangements for collecting the cinders and gases from a certain known proportion of the stack area by means of an apparatus which could be swung to different positions on top of the stack has also been employed by Dr. Goss, but was not considered suitable for the testing plant. Therefore in the new plant a new and somewhat elaborate arrangement has been installed for collecting the solid matter in the exhaust. In view of the fact that the testing plant is located in close proximity to other university buildings at Urbana, it was desirable to have a stack of sufficient height to prevent the fumes from being offensive to the immediate neighborhood, and for this purpose it was determined to have it at least 80 ft. high. This requirement offered a solution for the spark collecting problem, and the plant as built has a separator at the base of a brick stack 8 ft. in diameter and 81 ft. high located at the rear of the laboratory. The steam and gases as discharged from the locomotive pass through a steel elbow which carries them up and over to the center of the building, where they are received in a horizontal duct of large size running through the center of the roof trusses. A suction fan at the end of this duct in the rear of the building draws the gases through it and discharges them through another flue to the separator in the base of the stack. This separator requires the incoming gases to assume a circular movement and to pass downward around an internal sleeve and then upward through the sleeve to the top of the stack. It is probable that most of the heavier cinders will be deposited in the horizontal duct, and traps are provided for removing them. The lighter ones passing through the fan will be thrown outward against the walls of the separating chamber by the circular movement of the gas stream and will fall to the hopper at the bottom, where they may be drawn off and weighed. The fan has a runner 6 ft. in diameter, and at maximum speed will pass 140,000 cu. ft. of gas a minute. The elbow from the horizontal duct to the locomotive stack is of steel, and it is expected that it will need frequent renewal. The other parts of the system, with the exception of the fan, are made of an asbestos board which will resist corrosion. A reinforced concrete reservoir of 100,000 gal. capacity will be built, and the water for the brakes will be drawn from this and returned to it so that none of it will be wasted with the exception of that used for feed water for the locomotive. It is not the plan of the University to own a locomotive for use on this testing plant. The facilities will be available for use in testing new designs or arrangements, and it is expected that the railways and locomotive builders will furnish the locomotives to be tested.

NEW BOOKS

Worm Gearing. By Hugh Kerr Thomas. Bound in cloth, 86 pages, 6 in. x 9 in. Illustrated. Published by the McGraw-Hill Book Co., 239 West 39 street, New York. Price \$1.50.

The literature on the subject of worm gearing is extremely meager, and it is believed that in this book, for the first time, this comparatively little understood branch of applied mechanics is exhaustively treated. A complete analysis of the principles of design is given, and throughout the subject is handled in an analytical and practical manner, diagrams, curves and formula being extensively used. The application of worm gearing as a differential driving gear on automobiles and for reduction gears in connection with steam turbines on ships is given special attention.

Characteristics and Limitations of the Series Transformer. By H. R. Woodrow and A. R. Anderson. Bulletin No. 61 from the Engineering Experiment Station, Urbana, Ill. Bound in paper. Illustrated, 45 pages, 6 in. x 9 in. Published by the University of Illinois, W. F. M. Goss, Director of the Engineering Experiment Station, Urbana, Ill. Copies free.

In determining the action of electric circuits of high voltage, or of heavy current, it is often desirable to connect instruments in a circuit which is arranged to carry a current bearing a known ratio to the current of the main circuit. These conditions are made by the use of a series or "current" transformer and this bulletin presents the results of a theoretical study of such transformers, and sets forth the conditions affecting the ratio of secondary to primary current and the phase angle between them. It demonstrates the inadequacy of the series transformer, especially when constructed with an iron core, for the recording of transient phenomena.

Practical Locomotive Operating. By Clarence Roberts, Assistant Road Foreman of Engines, Pennsylvania Railroad, and Russell M. Smith, Air Brake Instructor, Pennsylvania Railroad. Bound in cloth, 292 pages, 6 in. x 8½ in. 92 illustrations and 5 inserts. Published by J. B. Lippincott Company, Philadelphia, Pa. Price \$2.

This book is intended for the use of locomotive engineers and firemen, its specialty being the running, firing and care of locomotives in service. No attempt has been made to go into the questions of design and shop repairs, and where formulas are used they are given as briefly as possible, without any involved mathematics. No attempt has been made to describe the air brake system or its operation, the authors leaving that subject to those books which are devoted entirely to it, and no description of appliances which are in experimental use only, is included in the book.

Part one deals with horse power, tractive effort, train resistance and locomotive efficiency. Part two takes up the systems of locomotive classification most in use and gives illustrations of prevailing types, with tables of dimensions and characteristics. Part three is devoted to useful notes and tables, and deals briefly with such subjects as physics, mechanics and chemistry. Part four considers steam and its properties, saturated and superheated. Part five deals with boilers and related devices while part six covers the subject of lubrication. Part seven takes up cylinders, valves and valve gears. Part eight deals with the running and firing of locomotives, part nine with disorders and breakdowns, and part ten with parts and appliances, such as injectors, lubricators, etc. Part eleven is devoted to qualifications and responsibilities and deals with operating conditions, selection of engineers and firemen, etc., and concludes with a series of questions on the locomotive. Part twelve gives a summary of the federal laws pertaining to locomotives. The law pertaining to hoilers is dealt with in eight pages, and the more important requirements of the safety appliance law are given. The book is well printed and the illustrations clear.

COMMUNICATIONS

HANDLING SAND ON LOCOMOTIVES

YEADON, PA., December 27, 1912.

TO THE EDITOR OF THE AMERICAN ENGINEER:

In traveling over some of the leading railway lines of the East, the writer has been somewhat unfavorably impressed with the evident lack of proper care on the part of those whose duty it is to supply sand to the sandboxes of locomotives. In numerous instances quantities of sand which had been spilled in filling were allowed to remain on top of the boiler casing and on the running boards, from which points the vibration of the engine naturally caused it to silt downwards into the guides, valve gears, and beyond a doubt even into the axle boxes, especially those of the forward drivers and the truck; while the winds of nature, uniting with those caused by the swift motion of the engine itself, blew portions of it into the mechanism of passing engines.

It might be pertinent to ask whether even a very small portion of sand so out of place does not frequently cause unnecessary cutting of machinery and consequent earlier call for repair than would be the case from the unavoidable injuries from dust arising from the permanent way or cinders falling from the locomotives; or it might be a question whether the additional time consumed by the laborers in using greater care in filling sand, and the additional time lost by the engines from service while such care was being observed, would amount to more than the cost of repairs resulting from the present practice.

In one or two instances noted, one that of a passenger locomotive, the lids of the sandboxes were also missing, thus affording easy ingress to rain, or to water which might pass out with the exhaust in case a boiler was allowed to become too full, or evidenced a slight tendency to foam; and this entrance of water would of course result in packed sand, with probable delay of trains in consequence.

The position of the sandboxes in English practice has always appealed to me, both from the standpoint of convenience in handling and from the aesthetic, as its absence from the top of the boiler greatly improves the appearance of the engine and also dispenses with one obstacle to the engineman's clear view of the line. With the present large boilers the English position would certainly be an aid to those supplying the boxes with sand in many ways, even though two boxes must necessarily be attended to on each engine.

Of course I know that the position on the top of the boiler is largely favored on the continent of Europe, and one might say exclusively by locomotive builders of the United States, chiefly I believe, because of a claim that the sand becomes moister in the boxes placed under the running boards, and consequently gives trouble from packing, but travel over most of the leading lines of the British Isles has failed to show me trouble on those roads from this cause, hence it may be inferred that when such trouble does arise it is possibly in a great measure owing to quality of sand used and to imperfect drying.

During 1861 the Pennsylvania Railroad Company had six freight locomotives, four passenger and several tank engines, fitted with sandboxes under the running boards and retained them in that position for four or five years; and again in 1881 commenced to use the same position for the sandboxes of its famous Class K engines, afterward known as D6 in the new classification, and after that time all passenger locomotives built by the company except a few known as class D2a (old BA), were built with sandboxes under the running boards until 1892, at which time there were several hundred engines so equipped in service on the main and subsidiary lines. After 1892 the top of the boiler was chosen as the company's standard position and as the engines came in for repairs the underhung sandboxes were removed and single ones placed on the tops of the boilers.

In the early '70s, some one at the Altoona shops fitted a freight locomotive with four small steam pipes leading to the front and rear of the drivers on each side of the engine, and so arranged them that a jet of steam could be blown directly under the wheels instead of sand when greater adhesion was desired. This device worked quite well, but objection was made to it on the ground that the moisture of the steam left the rails in a condition which caused following engines to slip unnecessarily, and after quite a prolonged trial the device was taken off.

Numerous illustrations made from photographs still in existence of engines built from the designs of Mr. Milholland for the Philadelphia & Reading during the "fifties" show these engines equipped with sandboxes under the running boards, and this position must still have been in use on that road as late as 1866, as an experimental engine built at Lancaster in the latter part of 1866 for the Pennsylvania was constructed in every particular from Reading drawings, and has its sandboxes under the running boards.

In 1874 the Pennsylvania arranged one of its 4-6-0 Baldwin freight engines as a "condensing" tank engine for street service in Pittsburgh, Pa., and sent it out without sandboxes as it was believed that its great weight (for those days) of 94,600 lbs., caused by the super-imposed tank, would give it sufficient adhesion under any condition of rail, but the sequel soon proved the fallacy of the idea, and sandboxes to be hung under the running boards were prepared under a rush order.

C. H. CARUTHERS

TURNING DRIVING WHEEL TIRES

CHICAGO, Ill., March 7, 1913.

TO THE EDITOR OF THE AMERICAN ENGINEER:

Here is a report of a driving wheel tire turning test which was performed at Chicago shops of the Chicago & North Western, February 25, 1913, under the supervision of John Murrin, superintendent of shops. This test was undertaken to ascertain the number of pairs of wheels it was possible to do in one nine-hour day, taking the wheels as they came, on one machine. It will be found to compare favorably with the one published in the February issue of the *American Engineer* on page 62.

	1	2	3	4	5	6	7	8	9	10	11	12	13	14	15
Diameter wheel, finished, in.....	61	61	61	62½	62½	62½	62½	62½	62½	61¼	61¼	61	59¾	59¾	59¾
Diameter wheel, rough, in.....	61½	61½	61½	63	63	63	63	63	62	62	62	62	60½	60½	60½
Floor to chuck, minutes.....	9	6	6	5	6	7	5	5	5	5	6	7	5	7	7
Turning, minutes.....	28	29	29	24	21	23	29	27	22	17	22	27	28	18	21
Machine to floor, minutes.....	4	3	3	3	3	5	4	4	3	3	4	4	4	3	3
Total time, floor to floor, minutes....	41	38	38	32	30	35	38	37	30	25	31	37	39	26	31
Cutting speeds, ft. per minute.....	14 to 19	14 to 18	15 to 20	15 to 20	14 to 20	15 to 20	13 to 15	15 to 20	15 to 20	15 to 20	15 to 20	15 to 20	15 to 20	15 to 20	15 to 20

The feed was ½ in. per revolution. Fifteen wheels were turned in 8 hrs. 28 mins. The average cutting time for each pair of wheels is 24.33 min., and from floor to floor 33.86 min. The quickest time for a single pair of wheels was 25 min. The test was made on a 90 in. heavy-duty Niles-Bement-Pond wheel lathe driven by a 50 h. p., d. c. General Electric motor.

E. H. MOREY,
Shop Demonstrator, Chicago & North Western.

EXHIBITS OPEN IN THE EVENING

[Following the receipt of the letter—"Railroader," which was published on page 116 of the March issue, we addressed a communication to a small, selected list of railway and supply men who have been regular attendants at the Atlantic City conventions for a number of years, asking their opinion of the proposed plan. Practically all replied and a large majority were strongly in favor of having the exhibits held open at least part of the evenings during the convention. Extracts from a number of the answers received are given below. As we go to press, announcement is made that the exhibits will be held open this

year on Monday evening, June 16. If it is found that advantage is taken of the opportunity this year (as the expressions of our correspondence clearly indicate it will be) it is planned to extend the practice to include several evenings at the 1914 conventions.—EDITOR.]

I am very strongly in favor of the plan. Many times I have wandered around by myself at night at the pier looking over the exhibits, without the aid of light or anyone to explain them to me, and I feel sure that there are a number of others who are in the same predicament as myself; that is, we have so many meetings in the day time that we have little or no time left to go over the exhibits.—*Superintendent of Motive Power.*

I doubt whether the exhibits would be of more value to me if kept open during the evening.—*Assistant Mechanical Engineer.*

I heartily approve of the suggestion as I find that in the limited time frequently allowed at the convention, not sufficient time has been found during the day to make as careful examination of exhibits as desired.—*Mechanical Engineer.*

I think it might be desirable to give the matter a trial, if it is entirely agreeable to the exhibitors.—*General Superintendent of Motive Power.*

I am of the opinion that possibly it would be advisable to have the exhibits open on two evenings.—*Superintendent of Rolling Stock.*

I am of the opinion that it would be a good thing to have the exhibits open possibly for two nights during each convention.—*Superintendent of Motive Power.*

The suggestion appeals to me personally. I have always felt that there was not sufficient opportunity to make an examination of exhibits commensurate with the expense the people went to in having them placed.—*General Superintendent of Motive Power.*

I favor the idea of keeping the exhibits on the pier open for a part of the evenings during the conventions.—*General Superintendent of Motive Power.*

I think a large number of railroad men would avail themselves of the opportunity to examine exhibits during the evening, and it seems to me that this plan would be worthy of a trial.—*Mechanical Engineer.*

My experience has been, that it is impossible for me to go over

the full lines of exhibits under the present plan, but it does not seem to me that evening sessions would help very much.—*Superintendent Motive Power and Machinery.*

I am not thoroughly convinced that if the exhibits were open in the evening, they would be very largely attended, but believe it would be worth trying out for this year.—*Assistant General Superintendent Motive Power.*

I believe it is the proper thing to do, but it will be somewhat of a hardship on the exhibitors.—*Assistant Superintendent Motive Power and Machinery.*

I think it is a good idea to keep the exhibits open at least every other evening during the convention.—*Master Mechanic.*

Such action would also tend to keep the convention people more together on the pier in the evening, and for one I should like to see it tried.—*General Mechanical Superintendent.*

Personally, I should like very much to see the exhibits open during the evening, as I find there are a number of them I have to pass over quickly.—*Superintendent of Motive Power and Rolling Stock.*

I believe that having the exhibits held open during the evenings would result not only advantageously to the manufacturers, but

to the members of the association.—*Assistant General Manager.*

In the writer's opinion it would be advisable to have the exhibits open for one evening during each convention.—*Engineer of Tests.*

I believe it would be beneficial to both the railroad men and supply men to hold the exhibits open to inspection during the evenings. Personally I should be very glad to take advantage of this opportunity, as I have found in the past that my time during the afternoon has been very limited, and while I have started off systematically to take in the exhibits, I have found it impossible to cover them as I should like to, because of the limited time at my disposal.—*Mechanical Engineer.*

I would, no doubt, avail myself one or two evenings of the advantage of having the exhibits open at night, and I believe that for those who come down but for a short time, this would be a desirable change. However, for the person who goes yearly to the convention and spends a week at Atlantic City, I do not see that this is necessary, as the new things which come up from year to year are very few and a great many of the exhibits represent the same thing every year.—*Engineer of Tests.*

I see no object in holding the exhibits open in the evening at the convention, and furthermore I do not see that members can be criticized if they devote the evening to relaxation. I consider it absolutely absurd to discuss the advisability of avoiding any period of relaxation at these conventions, while the enormous waste of time in spreading a convention of this kind over two weeks in place of one is neglected.—*Assistant to Vice-President.*

I am in favor of having the exhibits accessible during the evening, and one or more representatives of the exhibitors in attendance to meet those attending the convention who care to visit the exhibit during the evening. I do not believe it advisable to have the machinery in operation. If the exhibits are open during the evening I think the general public should not be admitted.—*Exhibitor.*

We think it would be a good policy to have the exhibits open in the evenings, especially on a minor scale, so that people who do not have an opportunity at other times could see them.—*Machine Tool Manufacturer.*

I have often wondered that there was not more made of the exhibits at night, as the people could stand around and chat just as well at the exhibits as they do in the big hotels.—*Mechanical Engineer.*

It should be remembered that in many cases, these affairs are the only vacations that master car builders, master mechanics and superintendents of motive power get, and if they cannot be trusted to attend the conventions and conduct themselves in a manner which will uphold the dignity of themselves, their positions, and the companies they represent, they should be kept at home, rather than be herded together on the pier in the evening, and at such other times as they may not be actually engaged in discussing subjects which the writer has had served up to him broiled for breakfast, warmed over for lunch, and cold for dinner for about a quarter of a century. Any master mechanic or master car builder who performs his duties in the manner expected of him is kept down to his work very closely for nearly every day in the year, and a little recreation once in a while will not be injurious to him, but will be of much benefit to the company that employs him, and personally, I believe that efforts should be directed toward discouraging well meaning but unwise people from offering what I consider nothing more or less than an insult to the body of men in charge of the mechanical departments of the railroads in this country, whose standard of excellence, dignity and honesty are as high as those of any other railroad official organization in existence.—*Superintendent of Motive Power.*

I believe this is a good suggestion and we shall be glad to do our share of whatever is necessary to carry it out.—*President of Large Supply Company.*

I believe it will be an excellent idea if it can be arranged

one evening during each convention.—*Representative of Regular Exhibitor.*

MOVING PICTURES IN RAILWAY EDUCATIONAL WORK

SAVANNAH, Ga., March 4, 1913.

TO THE EDITOR OF THE AMERICAN ENGINEER:

I have noted with interest the article in the February issue of the *American Engineer* on the subject of "Moving Pictures in Railway Educational Work," and believe that your readers will be interested in knowing what the Central of Georgia's educational bureau is doing along this line.

The moving pictures referred to in the February number were taken on the Central of Georgia, under the direct supervision of D. C. Buell, of the Union Pacific, who is also chief of our educational bureau; and these pictures are therefore of particular interest to our employees, because of their strictly local character. The majority of our locomotive firemen are negroes, and a large percentage of them are not well enough educated to benefit by our educational courses. In order that these negro firemen may also receive benefits from our educational work, we adopted the plan of "showing" them the proper and improper methods of doing their work. It was with this as the prime object in view that the moving pictures were made. However, it has developed that these pictures are interesting and instructive to the white firemen, and also to the engineers. At one of our lectures at Macon, Ga., one of our oldest engineers remarked after the lecture that he had learned how to fire—that he never knew before. Several of the engineers and firemen have attended these lectures from three to five times, although there was no change in the lectures.

In addition to the moving pictures showing proper and improper methods of firing locomotives, we have gone a little further and included a lecture on train rules, and one on lost and damaged freight. We have selected the most important train rules; at least, the rules which have caused the men and the company the most trouble, and while the lecturer is talking about any particular rule, the rule itself is projected on the screen. We had lantern slides made of several photographs taken to show violations of certain rules and dangerous practices of trainmen. For instance, a photograph was shown of a blue flag properly placed to protect car men; one of a flagman who had failed to carry out Rule 99; another of a brakeman asleep at the switch; another showing a man riding on a brake wheel; and other photographs showing cars being kicked over road crossings; a man riding a brakebeam; kicking a coupler with the foot; adjusting the lock pin with the fingers; and last, but not least, a specially designed slide showing ALWAYS SAFETY FIRST.

We find that most of the trainmen are anxious to have these rules explained to them, and we believe that the method we have adopted has enabled us not only to reach a larger number, but to hold the interest and create a more lasting impression than we could have done with the ordinary lecture, or with any instructional matter we could have furnished.

Our lecture on lost and damaged freight was for the benefit of the agency forces and the local freight crews and the yard men. We had pictures showing the actual condition in which freight was received at destination, clearly indicating that it had been either improperly loaded or roughly handled by the train crew, sometimes both. These photographs were actual photographs taken by certain of our agents who had previously been furnished with kodaks for the purpose.

We have just completed a tour of the system, stopping only at the principal terminal points, and have lectured to 1,200 employees, including about 800 in train service, 200 in agencies, and 200 classified as miscellaneous. We have had comparatively little difficulty in getting the men to attend the lectures.

D. C. BOY,
Assistant Chief Educational Bureau.

LOCOMOTIVE CONNECTING RODS

Formulas and Constants Used by The Baldwin Locomotive Works Presented and Discussed

BY H. A. F. CAMPBELL.

The Master Mechanics' Committee of 1910 and 1911 on connecting rods, presented to the association an admirable and very complete report, that included the methods used by many railroads and some of the locomotive builders. The author proposes here to supplement that report by presenting more fully the standard method of figuring sizes and shapes of connecting rods used by the Baldwin Locomotive Works.

The loads and the resultant stresses on a set of connecting rods are many and varied. Possibly no two engineers would agree exactly on what loads to consider, much less on what their magnitude might be. The following formulas and tables are presented in their simplest form and can be easily understood and used. Furthermore they have been applied to the design of many connecting rods now running in the United States and foreign countries.

MAIN RODS.

(1) Rod as a strut in compression (locomotive just starting).

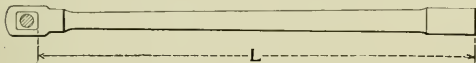

$$\frac{L}{r} = \frac{\text{Length } L}{\text{Least radius of gyration}} \quad (\text{Between } 100 \text{ and } 160.)$$

$$\frac{P}{A} = 8,000 \text{ lbs. per sq. in.}$$

P = Load on main rod. (See Table I below.)
 A = Least area of any section of the rod in the length L .
 r = Radius of gyration. (For rectangular sections see Table VIII.)
 8,000 lbs. per sq. in. = safe allowable working strength as a strut when $L \div r$ is between 100 and 160 (see Table II giving the tests on full sized rods made by Prof. Lanza at the Massachusetts Institute of Technology).

TABLE I—LOAD P ON MAIN RODS.

2 cyl. simple.....	Area cyl. \times full boiler pres. (See Table IV.)
4 cyl. balanced comp...	{ High pres. rods, = area high pres. cyl. \times $\frac{1}{2}$ boiler pres. { Low pres. rods, = area low pres. cyl. \times $\frac{1}{2}$ boiler pres.
Mallet compound...	{ High pres. rods, = area high pres. cyl. \times C. { Low pres. rods, = area low pres. cyl. \times C ₁ .
$C =$.3 (Wt. on drivers) \times dia. drivers (See Table V.)
$C_1 =$.3 (Wt. on drivers) \times dia. drivers (See Table V.)
2 cyl. cross comp..	Area low pres. cyl. \times K.
$K =$.3 (Wt. on drivers) \times dia. drivers (See Table V.)
	(Diam. L. P. cyl.) ² \times stroke

(2) Rod as a beam loaded uniformly by centrifugal force and compression or tension due to piston load (locomotive traveling at high speed).

$$\text{Fiber stress per sq. in.} = f + f_1 = \frac{.28 A V^2 l^2}{16 g r R} + \frac{C P}{A}$$

Fiber stress per sq. in. $f + f_1$ not to exceed 10,000 lbs. per sq.

TABLE II—CONNECTING ROD TESTS (FULL SIZE RODS). MASSACHUSETTS INSTITUTE OF TECHNOLOGY.

SERIES I SECTION TESTS MADE IN 1904.—Full-sized I Rods.

Rod.	$\frac{l}{r}$	Length, center to center.	Least radius of gyration.	Tensile Strength.			Compressive Strength.		
				Ultimate. Lbs. per sq. in.	Elastic limit. Lbs. per sq. in.	Elongation in 8 in. Per Cent.	Ultimate fiber stress. Lbs. per sq. in.	Working strength, factor of 4. Lbs. per sq. in.	
A.....	100 in.	89 $\frac{3}{4}$ in.	.8939	80,280	37,730	20.8	38,700	9,700	Constant section and length varied.
B.....	110 in.	98 $\frac{1}{2}$ in.	.8939	78,830	45,650	20.4	40,600	10,150	
C.....	120 in.	107 $\frac{1}{4}$ in.	.8939	77,840	43,900	20.4	39,300	9,825	
D.....	125 in.	111 $\frac{3}{4}$ in.	.8939	79,270	47,560	22.3	35,400	8,850	
E.....	130 in.	116 $\frac{1}{2}$ in.	.8939	79,250	45,820	...	39,300	9,850	
F.....	135 in.	120 $\frac{1}{2}$ in.	.8939	81,660	49,440	24.1	39,300	9,850	
G.....	140 in.	125 $\frac{1}{4}$ in.	.8939	79,690	39,590	24.4	38,000	9,520	
H.....	150 in.	134 $\frac{1}{2}$ in.	.8939	78,650	39,470	21.0	37,400	9,300	

SERIES II SECTION TESTS MADE IN 1906.—Full-sized I Rods.

Rod.	$\frac{l}{r}$	Length, center to center.	Tensile Strength.			Compressive Strength.						
			Ultimate. Lbs. per sq. in.	Elastic limit. Lbs. per sq. in.	Elongation in 5 in. Per Cent.	Ultimate fiber stress. Lbs. per sq. in.	Working strength, factor 4. Lbs. per sq. in.	A	B	C	D	E
1 b.....	129.6 in.	127 $\frac{3}{4}$ in.	69,290	26,310	29	29,410	7,353	5 $\frac{1}{2}$ in.	6 5/16 in.	4 in.	7/16 in.	11/16 in.
2 b.....	130.1 in.	127 $\frac{3}{4}$ in.	72,140	24,340	25.8	26,420	6,605	5 7/32 in.	6 $\frac{3}{8}$ in.	4 in.	13/32 in.	11/16 in.
3 b.....	129.6 in.	127 $\frac{3}{4}$ in.	72,500	27,380	29.2	31,600	7,900	5 31/32 in.	7 $\frac{1}{8}$ in.	4 in.	3/8 in.	11/16 in.
4 b.....	129.4 in.	127 $\frac{3}{4}$ in.	68,170	25,720	30.2	26,400	6,600	5 31/32 in.	7 $\frac{1}{8}$ in.	4 in.	5/16 in.	11/16 in.
5 b.....	130.4 in.	127 $\frac{3}{4}$ in.	74,740	30,500	25.4	32,390	8,097	5 31/32 in.	7 5/32 in.	4 in.	3/4 in.	11/16 in.
6 b.....	129.4 in.	127 $\frac{3}{4}$ in.	75,600	26,750	24.6	28,750	7,190	6 7/32 in.	7 15/16 in.	4 $\frac{1}{4}$ in.	5/16 in.	11/16 in.

SERIES II SECTION TESTS MADE IN 1906.—Full-sized I Rods.

Rod.	Length of span.	Tensile Strength.			Modulus of Rupture. Lbs. per sq. in.
		Ultimate. Lbs. per sq. in.	Elastic limit. Lbs. per sq. in.	Elongation in 5 in. Per Cent.	
1 a.....	132 $\frac{1}{4}$ in.	44,120
2 a.....	133 in.	76,000	31,110	22.4	49,990
3 a.....	131 $\frac{1}{2}$ in.	67,970	25,750	28.6	44,180
4 a.....	134 in.	65,420	32,190	29.0	41,210
5 a.....	136.8 in.	75,250	28,160	22.6	41,440
6 a.....	142 $\frac{1}{2}$ in.	30,000	25.2	45,130
X.....	122 $\frac{1}{2}$ in.	90,550	41,620	15.6	86,670
Y.....	96.5 in.	83,020	42,230	20.3	71,880

Same dimensions of A, B, C, D, E, as given above.

in. at a speed equal to the diameter of the drivers in inches.

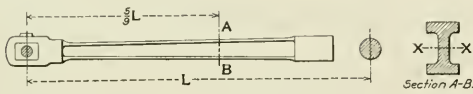

Maximum whip action at a section $\frac{5}{9} L$ from the crosshead pin—section AB

A = Area of section AB in square inches.
V = Linear velocity of the crank pin in feet per second.

(If the speed is taken as, "diameter speed," i. e., if a 62 in. diameter driver, 62 miles an hour; 84 in. diameter driver, 84 miles an hour, etc., then $V = 1.466 \times$ stroke in inches [see Table XI]).

l = Length of rod center to center in inches.
r = Radius of the crank in feet. (See Table XI.)
R = Resistance of section AB about axis X X.
C = Per cent. of full boiler pres. due to speed and cut off and the effect of various heating surfaces. (See Diagram II.)
P = Area of piston times the full boiler pressure. (See Table IV.)

$\frac{A}{R}$ of rectangular sections see Table X.

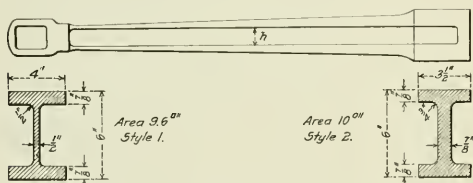

Mill or plane out a constant width h and taper the flanges. The section shown in style 2 is preferred to style 1 for main rods. Flanges less than $\frac{3}{4}$ in. thick should not be used.

SIDE RODS.

(1) The rod as a strut in compression. The loading on each side rod, to be used for the maximum compression loads on the rods, and the loads on the rod stubs and strength of side rod wrist pins are given in per cent. of the main rod load, P in Diagram VI.

These resultant loads can only be obtained at starting, and include a factor for shock, due to worn pins and brasses, uneven trammings of the rods, uneven alignment of the wheels, slipping of one wheel and transferring its load to another and catching the wheels on sand when slipping. These forces are hard to determine, and have been included in one general factor. This same loading on the side rods would be obtained if

a factor of adhesion of about .4 were used. This may seem high, but experience has shown that this loading on side rods in conjunction with the method of figuring the strength as given

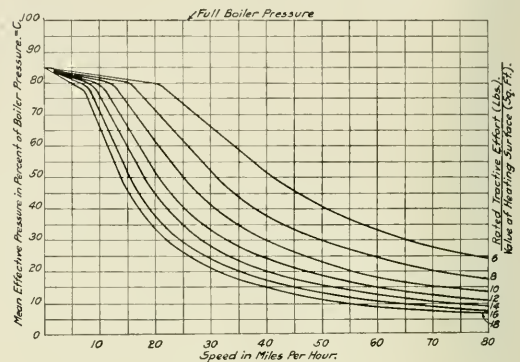

Diagram III—Mean Effective Pressure in the Cylinders.

here does not give a greater margin of safety than is necessary. The least sectional area of the rod is first tested as a strut (locomotive starting).

(a) If the rod section is I use a working strength of 8000 lbs. per sq. in. when $\frac{L}{r}$ is between 100 and 160.

(b) If the section is rectangular the working strength is taken

TABLE V—PISTON LOADS FOR LOW PRESSURE CYLINDERS.

Diameter of Cylinder.	Pressures, Pounds.							
	60	70	75	80	85	90	95	100
20 in.	18,850	21,991	23,600	25,133	26,700	28,274	29,850	31,416
21 in.	20,782	24,245	26,000	27,709	29,400	31,173	32,900	34,636
22 in.	22,808	26,609	28,500	30,411	32,300	34,212	36,100	38,013
23 in.	24,929	29,083	31,120	33,238	35,300	37,393	39,400	41,548
24 in.	27,143	31,667	33,900	36,191	38,400	40,715	42,900	45,239
25 in.	29,400	34,300	36,800	39,200	41,650	44,100	46,500	49,090
26 in.	31,900	37,200	39,800	42,500	45,100	47,800	50,400	53,090
27 in.	34,400	40,150	43,000	45,500	48,600	51,600	54,400	57,300
28 in.	36,950	43,100	46,200	49,300	52,300	55,400	58,500	61,600
29 in.	39,600	46,200	49,500	52,800	56,100	59,400	62,700	66,000
30 in.	42,400	49,500	53,000	56,600	60,100	63,600	67,200	70,700
31 in.	45,300	53,000	56,600	60,400	64,200	68,000	71,700	75,500
32 in.	48,300	56,300	60,300	64,300	68,300	72,400	76,400	80,400
33 in.	51,300	59,800	64,100	68,400	72,700	77,000	81,200	85,500
34 in.	54,500	63,500	68,100	72,700	77,200	81,700	86,200	90,800
35 in.	57,700	67,350	72,200	77,000	81,800	86,600	91,400	96,200
36 in.	61,000	71,240	76,300	81,400	86,500	91,600	96,700	101,790
37 in.	64,500	75,300	80,700	86,000	91,400	96,800	102,500	107,500
38 in.	68,100	79,400	85,100	90,700	96,400	102,000	108,000	113,400
39 in.	71,700	83,600	89,500	95,500	101,500	107,500	113,500	119,500
40 in.	75,500	87,900	94,200	100,500	107,000	113,000	119,500	125,600
41 in.	79,200	92,400	99,000	105,600	112,000	118,500	125,500	132,000
42 in.	83,100	97,000	104,000	111,000	117,500	125,000	132,500	138,500

TABLE IV—PISTON LOADS (P).

Diameter of Cylinder.	AREA OF CYLINDER X FULL BOILER PRESSURE. Boiler Pressure, Pounds.											
	130	140	150	160	170	180	185	190	200	205	210	220
5 in.	2,553	2,749	2,945	3,142	3,338	3,534	3,630	3,731	3,927	4,020	4,123	4,330
6 in.	3,675	3,958	4,240	4,523	4,806	5,089	5,240	5,372	5,655	5,800	5,938	6,221
7 in.	5,002	5,387	5,772	6,157	6,542	6,926	7,120	7,311	7,696	7,900	8,082	8,467
8 in.	6,534	7,036	7,539	8,042	8,544	9,047	9,300	9,549	10,053	10,300	10,556	11,059
9 in.	8,269	8,905	9,541	10,178	10,815	11,450	11,770	12,086	12,722	13,040	13,358	14,096
10 in.	10,210	10,995	11,781	12,566	13,352	14,137	14,520	14,902	15,708	16,100	16,493	17,297
11 in.	12,354	13,304	14,254	15,205	16,155	17,105	17,570	18,035	19,005	19,470	19,935	20,905
12 in.	14,703	15,834	16,965	18,096	19,227	20,358	20,900	21,439	22,620	23,100	23,571	24,852
13 in.	17,255	18,582	19,909	21,237	22,564	23,891	24,600	25,218	26,545	27,270	27,874	29,201
14 in.	20,012	21,552	23,091	24,630	26,170	27,709	28,500	29,284	30,838	31,600	32,327	33,866
15 in.	22,972	24,739	26,506	28,274	30,040	31,807	32,700	33,574	35,341	36,200	37,110	38,877
16 in.	26,138	28,148	30,159	32,170	34,180	36,191	37,200	38,201	40,212	41,200	42,223	44,234
17 in.	29,507	31,777	34,047	36,317	38,587	40,856	42,000	43,126	45,396	46,500	47,660	49,936
18 in.	33,081	35,626	38,170	40,715	43,259	45,804	47,000	48,180	50,894	52,100	53,339	55,784
19 in.	36,859	39,694	42,529	45,365	48,200	51,035	52,300	53,870	56,706	58,000	59,541	62,376
20 in.	40,841	43,981	47,124	50,266	53,407	56,549	58,100	59,690	62,832	64,400	65,974	69,116
21 in.	45,027	48,490	51,954	55,418	58,881	62,345	64,000	65,808	69,272	70,900	72,736	76,100
22 in.	49,414	53,218	57,019	60,821	64,622	68,423	70,300	72,224	76,026	77,900	79,828	83,629
23 in.	54,012	58,167	62,322	66,477	70,632	74,787	76,900	78,941	83,096	85,200	87,250	91,405
24 in.	58,811	63,335	67,858	72,382	76,906	81,430	83,700	85,954	90,478	92,800	95,000	99,526
25 in.	63,810	68,700	73,590	78,480	83,370	88,260	90,800	93,300	98,000	100,600	103,000	108,000
26 in.	69,000	74,300	79,600	84,900	90,200	95,500	98,200	100,900	105,800	108,600	111,400	116,800
27 in.	74,400	79,900	85,400	90,900	96,400	101,900	104,800	107,700	112,800	115,800	118,800	124,400
28 in.	80,000	85,600	91,200	96,800	102,400	108,000	111,000	114,000	119,200	122,000	124,800	130,400
29 in.	85,800	91,500	97,200	102,900	108,600	114,300	117,500	120,700	126,000	128,500	131,000	137,000
30 in.	91,800	97,600	103,400	109,200	115,000	120,800	124,200	127,600	133,000	135,600	138,200	144,400

from Table VIII. (Based on tests made by the Pencoyd Iron Works.)

Next test the rods as a beam loaded uniformly by centrifugal force and compression or tension due to the piston load (Diagram VII).

$$\text{Fiber stress per square inch} = f = \frac{.28 A V^2 P^2}{8 g r R} \quad f_1 = \frac{\% C P}{A}$$

$f + f_1$ should not exceed 10,000 lbs. per sq. in. at "diameter speed."

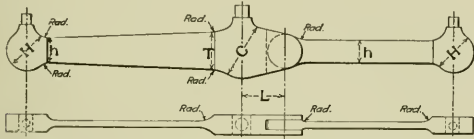

When C is 13 in. in diameter and over increase h to T as shown above.

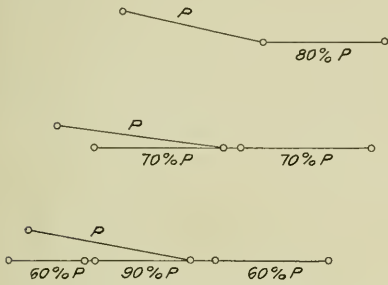
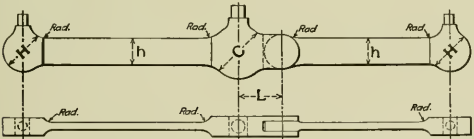

Diagram VI—Loading of Side Rods for Strength of Rods and Stubs.

When C is less than 13 in. in diameter make the rod section style as given below.



The following rules are important and should be carefully followed:

- h shall be at least $\frac{1}{2} H$; better $\frac{2}{3} H$.
- Use large radii as shown.

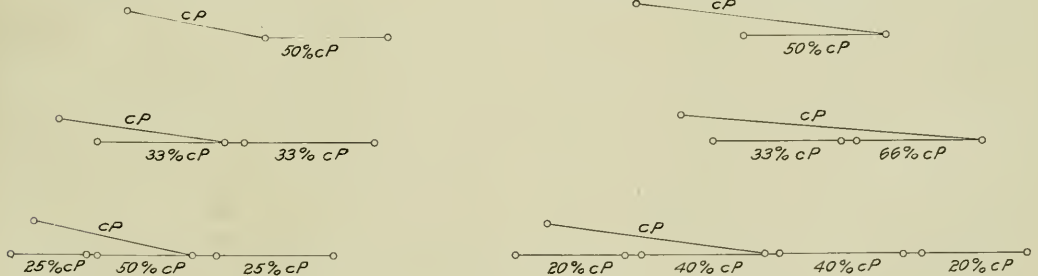
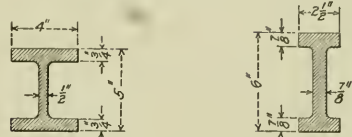

Diagram VII—Loading of Side Rods Due to Reduced Main Rod Load C P (Diagram III). Locomotive Travelling at High Speed.

- If possible have no side sets in the rods.
- Use the style of jaws as shown.
- Keep the overhang, L, as short as possible.
- Unless the side rods are over 90 in. center to center use a rectangular section deep and thin.

For side rods over 90 in. center to center use an I section.



Style No. 1. Area 7.5 in²

Style No. 2. Area 7.25 in²

The many and various stresses will be withstood better by the section shown as style 2, than by that designated as style 1.

Don't use flanges less than $\frac{3}{4}$ in. thick.

WRIST PINS AND CROSSHEAD PINS.

The sizes of wrist and crosshead pins are fixed by the amount of wearing surface necessary, and by the limits of the fiber stresses produced by the loads on the rods.

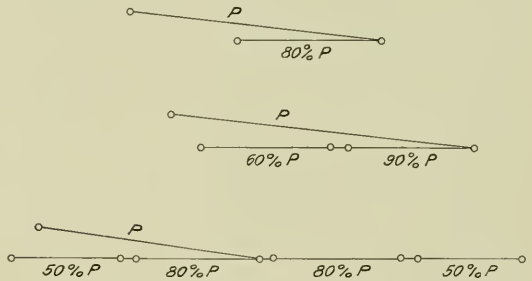

Locomotive Developing its Maximum Tractive Effort at Starting.

1.—Diameter of the Pin for Strength.

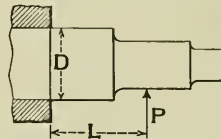

- P = Load on the main rod. (See Tables I, IV, V.)
- P_1 = Load on the side rods. (See Table VI.)
- D = Distance as shown.
- R = Resistance of the pin for bending at D, pin worn $\frac{1}{4}$ in. (See Table XII.)

Assume no support from side rods for calculations on the main pin.

$$f = \text{Allowable working fiber stress;} \\ = 18,000 \text{ lbs. per sq. in. for open-hearth steel;}$$

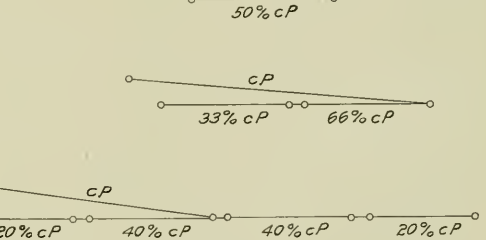

$$= 15,000 \text{ lbs. per sq. in. for wrought iron;} \\ = \frac{P \times L}{R}$$

2.—Size of Pins for Wearing Pressure.—The wearing surface and size are based on a load P as given in Table I.

Wearing pressure per sq. in. strap stubs with keys = 1,600 to 1,800 lbs.

Wearing pressure per sq. in. solid end stubs, no key = 1,000 to 1,200 lbs.

Wearing pressure per sq. in. crosshead stubs and knuckles = 4,500 to 5,500 lbs.

The wearing surface is the projected area of the brass.

STRAP STUBS.

For wrought steel straps:

Working stress, direct tension = 10,000 lbs. per sq. in.

TABLE VIII—RECTANGULAR STEEL RODS IN COMPRESSION.
(Tests made by Peacock Iron Works.)

1	Working comp. strength. Pounds per sq. in.	Factor of safety of ult. strength.	1	Working comp. strength. Pounds per sq. in.	Factor of safety of ult. strength.
20	21,900	3.2	140	6,410	4.4
30	15,400	3.3	150	5,500	4.3
40	13,500	3.4	160	5,950	4.6
50	12,600	3.5	170	4,980	4.7
60	11,700	3.6	180	4,460	4.8
70	10,800	3.7	190	3,960	4.9
80	10,000	3.8	200	3,580	5.0
90	9,260	3.9	210	3,180	5.1
100	8,550	4.0	220	2,880	5.2
110	8,070	4.1	230	2,640	5.3
120	7,590	4.2	240	2,410	5.4
130	7,000	4.3			

TABLE IX—RADIUS OF GYRATION FOR RECTANGULAR SECTIONS IN TERMS OF LEAST SIDE.

Least side.	Radius of gyration.	Least side.	Radius of gyration.	Least side.	Radius of gyration.	Least side.	Radius of gyration.
1/2	.1443	1 1/8	.343	1 3/4	.542	2	.740
3/8	.1805	1 1/4	.361	1 7/8	.560	2 1/8	.758
1/2	.1625	1 1/2	.379	2	.578	2 1/4	.776
5/8	.198	1 3/4	.397	2 1/8	.596	2 1/2	.795
3/4	.217	1 7/8	.415	2 1/4	.614	2 3/8	.812
7/8	.234	1 7/8	.433	2 1/2	.632	2 3/4	.831
1	.253	1 7/8	.451	2 1/4	.650	2 3/4	.848
1 1/8	.270	1 7/8	.470	2 1/2	.668	2 3/4	.867
1 1/4	.289	1 7/8	.487	2 1/2	.686		
1 1/2	.307	1 7/8	.505	2 1/2	.704		
1 3/8	.325	1 7/8	.524	2 1/2	.722		

TABLE X—RECTANGULAR RODS IN MOTION.

Ratio =		Area of Section		Resistance of Section		A	
= R		= R		= R		= R	
Depth of Rod. In.	A	Depth of Rod. In.	A	Depth of Rod. In.	A	Depth of Rod. In.	A
2	3.000	3 1/2	1.714	4 1/2	1.263	6	1.000
2 1/2	2.666	3 3/4	1.600	5	1.200	6 1/4	0.96
2 3/4	2.400	4	1.500	5 1/4	1.143	6 1/2	0.925
3	2.181	4 1/2	1.411	5 1/2	1.091	6 3/4	0.888
3 1/4	2.000	4 3/4	1.353	5 3/4	1.043	7	0.857
3 3/4	1.846						

TABLE XI—VALUE OF V², 16 g r, 8 g t FOR DIFFERENT LENGTH OF STROKES AT A VELOCITY EQUAL TO "DIAMETER SPEED."

Stroke. In.	16 g r	V ²	8 g r	In.	16 g r	V ²	8 g r
10	214.4	215.0	107.2	25 1/2	546.6	1,400.0	273.3
12	257.3	309.3	123.6	26	557.1	1,453.0	278.5
14	300.1	421.3	150.0	27	578.8	1,567.0	289.4
16	343.0	550.3	171.5	28	600.0	1,685.0	300.0
18	385.0	696.7	197.5	29	621.5	1,808.0	310.7
20	428.7	869.4	214.3	30	643.2	1,934.0	321.6
22	471.7	1,040.0	235.8	31	664.2	2,066.0	332.1
24	514.5	1,238.0	257.2	32	686.0	2,201.0	343.0
25	535.9	1,343.0	267.9	34	728.9	2,485.0	364.4

TABLE XII—MOMENT OF RESISTANCE OF CIRCULAR SECTIONS.

Diam. In.	Moment.	Diam. In.	Moment.	Diam. In.	Moment.	Diam. In.	Moment.
1 1/4	.1917	3 1/2	3.3702	5 1/2	14.206	7 1/2	37.412
1 1/2	.2352	3 3/4	3.7742	5 3/4	15.247	7 3/4	39.381
1 3/4	.3313	3 3/4	4.2093	5 3/4	16.334	7 3/4	41.418
1 3/4	.4213	3 3/4	4.6765	5 3/4	17.474	7 3/4	43.523
1 3/4	.5262	3 3/4	5.1772	5 3/4	18.664	7 3/4	45.699
1 3/4	.6472	3 3/4	5.7124	5 3/4	19.908	7 3/4	47.947
2	.7854	4	6.2832	6	21.206	8	50.266
2 1/8	.9423	4 1/8	6.8924	6 1/8	22.559	8 1/8	52.659
2 1/4	1.1182	4 1/4	7.5365	6 1/4	23.968	8 1/4	55.127
2 1/2	1.3152	4 1/2	8.2212	6 1/2	25.436	8 1/2	57.671
2 3/4	1.534	4 3/4	8.9463	6 3/4	26.962	8 3/4	60.292
2 3/4	1.7758	4 3/4	9.7126	6 3/4	28.547	8 3/4	62.991
2 3/4	2.0417	4 3/4	10.512	6 3/4	30.194	8 3/4	65.770
2 3/4	2.3333	4 3/4	11.375	6 3/4	31.902	8 3/4	68.629
3	2.6507	5	12.292	7	33.764	9	71.569
3 1/8	2.9962	5 1/8	13.215	7 1/8	35.510		

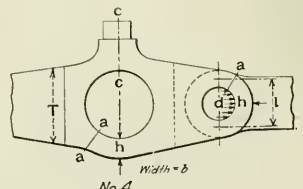
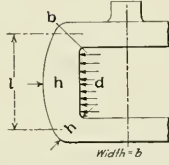
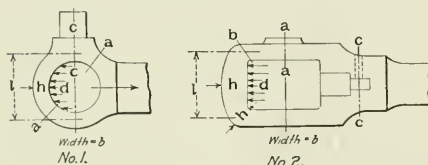

Solid End Stubs, Main or Side and Solid End Jaw Stubs.

TABLE XIII—PROPORTIONS OF P USED ON THE DIFFERENT PINS.

Class of Engine.	Cross-head Pin.	Main Pin.	Side Rods.			
			Main Pin.	Inter Pins.	End Pins.	Knuckle Pins.
2 Coupled.....	P	P	1/2 P	1/3 P	1/4 P	1/5 P
3 Coupled.....	P	P	2/5 P	1/3 P	1/4 P	1/5 P
4 Coupled.....	P	P	3/5 P	1/4 P	1/5 P	1/6 P
5 Coupled.....	P	P	4/5 P	1/5 P	1/6 P	1/7 P

Working stress, direct tension through keyways = 8,000 lbs. per sq. in.

Working stress, bending = 14,000 lbs. per sq. in. (main rods).

TABLE XIV—CARRYING CAPACITY OF WROUGHT STEEL BOLTS IN SHEAR AT 9,000 LBS. PER SQ. IN.

Bolts.	Strength.	3 in. Double Shear.	
		Bolts.	Strength.
1/2	7,070 lbs.	5 1/2	16,550 lbs.
3/4	11,040 lbs.	6	23,850 lbs.
7/8	15,900 lbs.	7 1/2	32,470 lbs.
1	21,600 lbs.	1	42,400 lbs.
1 1/8	28,300 lbs.	1 1/4	53,680 lbs.
1 1/4	35,800 lbs.	1 1/2	66,250 lbs.
1 1/2	44,180 lbs.	1 3/4	80,180 lbs.
1 3/4	53,450 lbs.	1 7/8	95,400 lbs.
1 3/8	63,600 lbs.	1 3/4	111,500 lbs.
1 3/4	74,500 lbs.	1 3/4	129,900 lbs.
1 3/4	86,500 lbs.	1 3/4	149,000 lbs.
1 3/4	99,500 lbs.	2	170,000 lbs.
2	113,000 lbs.		

Working stress, bending = 20,000 lbs. per sq. in. (side rods).
Shear on steel stub bolts = 9,000 lbs. per sq. in. (See Table XIV.)

SOLID END STUBS, MAIN OR SIDE AND SOLID END JAW STUBS.

Direct tension at section a-a and c-c under maximum loads (as already given) must not exceed 6,000 lbs. per sq. in. at any section of the strap.

The straps or eye must also be tested for bending, using P and the per cent. of P as already given.

Main rods at section d, No. 2.

$$f = 14,000 = \frac{P \times l \times 6}{16 \times b \times h^2}$$

Main rod at section b, No. 3.

$$f = 14,000 = \frac{P \times l \times 6}{12 \times b \times h^2} + \frac{P}{2 \times b \times h}$$

Side rods at section d, Nos. 1 and 4.

$$f = 20,000 = \frac{P \times l \times 6}{16 \times b \times h^2}$$

At a section c-c, through an oil cup or set screw, it is better to have 25 per cent. more area than at section a.

In No. 4 the main part of the strap at section a-a is subjected to a bending action. Any method of figuring this bending is rather unsatisfactory. It is, therefore, better to try to eliminate the cause of this bending action. To some extent this can be done by increasing the depth of the rod at T and using large fillets 20 in. to 40 in. radius as already shown in Nos. 1 and 2. The purpose of this method of design is to reduce too

sharp a change in the direction of the load as it goes across the top or bottom of the strap. If this is done the strap can be checked for its required area on the direct tension basis alone, using, as already stated, a working stress of 6,000 lbs. per sq. in. It must be carefully noted that the required area

the corner of the strap, and the number of bolts for the strap stubs.

The remaining diagrams of rods show the recommended practice of keying, when strap stubs are used.

TABLE XV.—DIMENSIONS OF SOLID END BRASSES.

Brasses for Solid End Stubs.

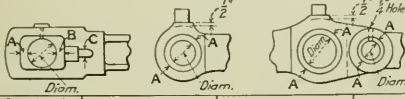

Crosshead Stubs			End Stubs		Jaw Stubs		Jaw Pins	
Di	A	B	A	Di	A	A	T	T
1 1/2	3/8	1/2	7/16	3/8	7/16	3/8	1 1/4	1 1/4
1 3/4	3/8	1/2	7/16	3/8	7/16	3/8	1 1/4	1 1/4
2	3/8	1/2	7/16	3/8	7/16	3/8	1 1/4	1 1/4
2 1/4	3/8	1/2	7/16	3/8	7/16	3/8	1 1/4	1 1/4
2 1/2	3/8	1/2	7/16	3/8	7/16	3/8	1 1/4	1 1/4
2 3/4	3/8	1/2	7/16	3/8	7/16	3/8	1 1/4	1 1/4
3	3/8	1/2	7/16	3/8	7/16	3/8	1 1/4	1 1/4
3 1/4	3/8	1/2	7/16	3/8	7/16	3/8	1 1/4	1 1/4
3 1/2	3/8	1/2	7/16	3/8	7/16	3/8	1 1/4	1 1/4
3 3/4	3/8	1/2	7/16	3/8	7/16	3/8	1 1/4	1 1/4
4	3/8	1/2	7/16	3/8	7/16	3/8	1 1/4	1 1/4
4 1/4	3/8	1/2	7/16	3/8	7/16	3/8	1 1/4	1 1/4
4 1/2	3/8	1/2	7/16	3/8	7/16	3/8	1 1/4	1 1/4
4 3/4	3/8	1/2	7/16	3/8	7/16	3/8	1 1/4	1 1/4
5	3/8	1/2	7/16	3/8	7/16	3/8	1 1/4	1 1/4
5 1/4	3/8	1/2	7/16	3/8	7/16	3/8	1 1/4	1 1/4
5 1/2	3/8	1/2	7/16	3/8	7/16	3/8	1 1/4	1 1/4
5 3/4	3/8	1/2	7/16	3/8	7/16	3/8	1 1/4	1 1/4

can be made up of many combinations of h x b, and careful judgment must be used to determine h.

Table XV gives the recommended size of brasses and jaw bushings for solid end stubs.

TABLE XVI.—DIMENSIONS OF STRAP END BRASSES.

Brasses for Strap Stubs.

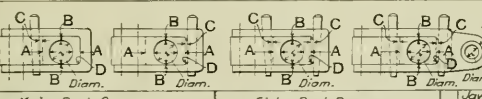

Main Rod Brasses				Side Rod Brasses				Jaw Pins	
A	B	C	D	A	B	C	D	T	T
1 1/2	3/8	1/2	7/16	3/8	7/16	3/8	7/16	3/8	1 1/4
1 3/4	3/8	1/2	7/16	3/8	7/16	3/8	7/16	3/8	1 1/4
2	3/8	1/2	7/16	3/8	7/16	3/8	7/16	3/8	1 1/4
2 1/4	3/8	1/2	7/16	3/8	7/16	3/8	7/16	3/8	1 1/4
2 1/2	3/8	1/2	7/16	3/8	7/16	3/8	7/16	3/8	1 1/4
2 3/4	3/8	1/2	7/16	3/8	7/16	3/8	7/16	3/8	1 1/4
3	3/8	1/2	7/16	3/8	7/16	3/8	7/16	3/8	1 1/4
3 1/4	3/8	1/2	7/16	3/8	7/16	3/8	7/16	3/8	1 1/4
3 1/2	3/8	1/2	7/16	3/8	7/16	3/8	7/16	3/8	1 1/4
3 3/4	3/8	1/2	7/16	3/8	7/16	3/8	7/16	3/8	1 1/4
4	3/8	1/2	7/16	3/8	7/16	3/8	7/16	3/8	1 1/4
4 1/4	3/8	1/2	7/16	3/8	7/16	3/8	7/16	3/8	1 1/4
4 1/2	3/8	1/2	7/16	3/8	7/16	3/8	7/16	3/8	1 1/4
4 3/4	3/8	1/2	7/16	3/8	7/16	3/8	7/16	3/8	1 1/4
5	3/8	1/2	7/16	3/8	7/16	3/8	7/16	3/8	1 1/4
5 1/4	3/8	1/2	7/16	3/8	7/16	3/8	7/16	3/8	1 1/4
5 1/2	3/8	1/2	7/16	3/8	7/16	3/8	7/16	3/8	1 1/4
5 3/4	3/8	1/2	7/16	3/8	7/16	3/8	7/16	3/8	1 1/4

With Brasses 6 1/2" and Wider use Wedges.

Table XVI gives the recommended size of brasses and jaw bushings, size of liner behind the keys, radius of the fillet at

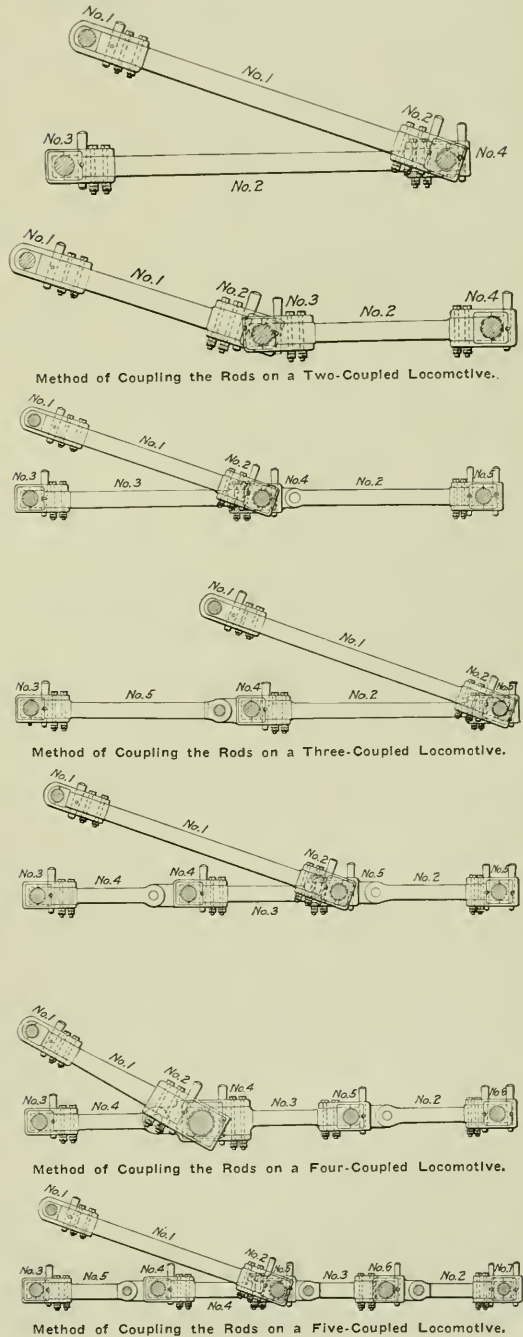

KNUCKLE PINS AND JAWS.

Knuckle pins must have ample bearing surface and the pressure per square inch, with the loads given in Table XIII, should not exceed 5,500 lbs. per sq. in.

The lateral displacement of side rods due to the difference of alignment of one driver with another, together with the permanent side set that some side rods are designed to work with,

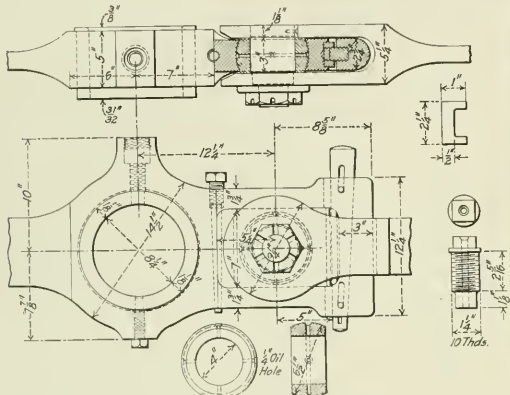

Ball Knuckle Pin for Side Rods.

cause excess twisting strains that often result in the failure of the rod.

Allow 1/16 in. total play between the jaw and its side wings. On five coupled engines, and even on four coupled that operate on very sharp curves, a ball knuckle pin will greatly reduce the excessive strains mentioned above. The type of ball knuckle pin here shown has been used on some of the latest Baldwin Mikados and five coupled engines.

The following set of rods shows a design used on a large order of high powered Pacific type locomotives. This design

lighter, in proportion to the loads they carry, than the rods on locomotives in the United States. European rods look very light, but the basis of comparison must not be made on looks but on the amount of load or work that each rod carries per unit of weight.

The conditions in Europe may be summed up briefly as follows: The connecting rods are of hammered iron, or 80,000 lbs. open hearth steel. The allowable load at the rail on one

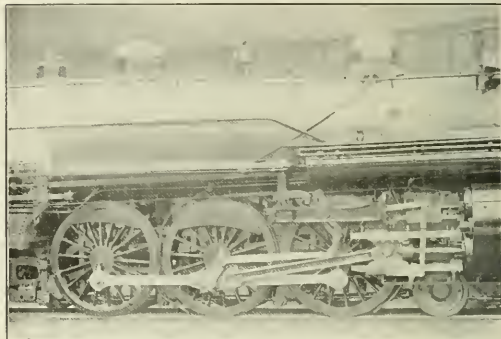

Connecting Rods of a High Power Pacific Type Locomotive.

driving axle seldom exceeds 20 tons. The main and side rods are made as short as possible. In many cases the total work is divided between four main rods. The stroke of the pistons is seldom over 26 in. With English inside cylinder locomotives the side rods outside revolve at a shorter throw than the main rods inside, thus reducing the whip of the side rods at high speed. The rod brasses, straps and pins are maintained in first class condition.

The conditions in the United States are as follows: The connecting rods are of 80,000 lbs. per sq. in. open hearth steel. The allowable load at the rail per driving axle is 35 tons, and

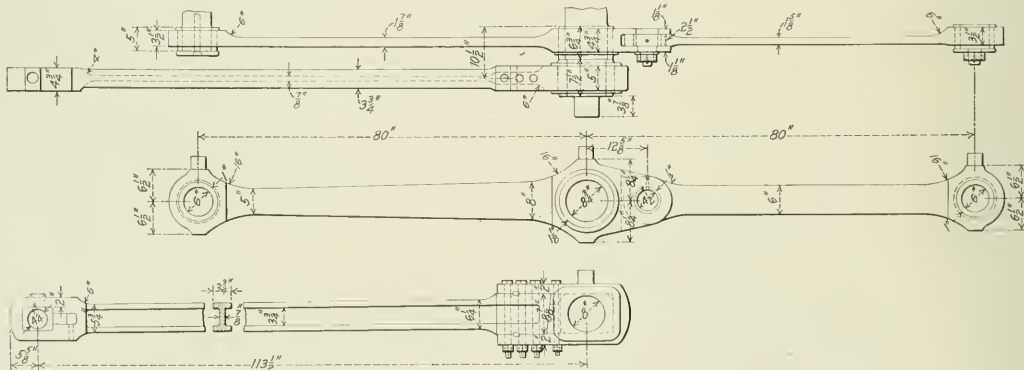

Set of Rods for a High Power Pacific Type Locomotive.

represents Baldwin standard practice, and was based on the rules here given. The main rod is the one referred to later in the comparative table of the weight of rods.

COMPARISON BETWEEN AMERICAN AND FOREIGN ROD DESIGN.

Frequently, the question is asked, "Why are the European locomotive builders able to design and build connecting rods so much lighter than the builders do in this country?" This question is rather easily answered. As a matter of fact, connecting rods on European locomotives are not very much

the limit of loading possibly has not yet been reached. The main rods are often very long. Two Atlantic type locomotives in this country have main rods 150 in. center to center, and many are 130 in. to 140 in. long. Except on the balanced compounds and Mallets the loads are all carried through one main rod on each side. The maximum load carried on one main rod has reached the high figure of 110,000 lbs. or 55 tons. The stroke of our pistons is seldom less than 26 in., and very often is 28 in., 30 in. and 32 in. The rod brasses and pins are not always maintained in first class condition.

The contrast as outlined would indicate that the American rods would be much heavier, and they are actually heavier as a whole. But when compared on the basis of the amount of load carried per pound of weight of the rod, it will be found that there is not a great deal of difference. The following table shows this.

The data on European rods is limited, but more examples would probably show that as many rods carry 100 lbs. and less per pound weight of rod as there are that carry over 100 lbs.

the design of a rod to see whether it is good practice or not. Steel for the rods tested as given in Table II was made to the following Baldwin specification:
Blooms made by the open hearth process free from seams, slivers and other surface defects.

To show the following analysis by Baldwin standard method.

Carbon, about.....0.40 per cent. Phosphorus, not over...0.05 per cent.
Manganese, not over...0.60 per cent. Sulphur0.05 per cent.

Blooms should be of such quality that a test piece machined

EUROPEAN MAIN RODS.						
Name of Road.	Type of locomotive.	Cylinders and boiler pressure.	Length of main rod, center to center.	Maximum load on the main rod.	Actual weight of the main rod.	Pounds of load carried per pound of rod.
Paris-Orleans	4-6-0 { De Glehn comp.	15 in. & 24 in. x 25 in. } 227 lbs. }	83½ in.	35,800 lbs.	283 lbs.	126 lbs.
Great Western—England	4-6-0 { 2 cyl. simple	18 in. x 30* in. } 220 lbs. }	128½ in.	55,800 lbs.	500 lbs.	111 lbs.
North British.....	4-4-2 { 2 cyl. simple	20 in. x 28* in. } 200 lbs. }	135 in.	62,800 lbs.	600 lbs.	104½ lbs.
Lancashire and Yorkshire.....	4-6-0 { 4 cyl. simple	16 in. x 26 in. } 180 lbs. }	128 in.	36,180 lbs.	438¾ lbs.	82 lbs.
						Average.... 105 lbs.
UNITED STATES PRACTICE.						
N. Y., N. H. & H.....	4-6-0 { 2 cyl. simple	21 in. x 26 in. } 200 lbs. }	128 in.	69,200 lbs.	692 lbs.	100 lbs.
Lehigh Valley	4-4-2 { 2 cyl. simple	20 in. x 26 in. } 200 lbs. }	130¼ in.	62,800 lbs.	689 lbs.	91 lbs.
Pennsylvania	4-4-2 { 2 cyl. simple	22 in. x 26 in. } 205 lbs. }	137½ in.	77,900 lbs.	658 lbs.	118 lbs.
Baltimore & Ohio.....	4-6-2 { 2 cyl. simple	24 in. x 32 in. } 205 lbs. }	104 in.	92,000 lbs.	890 lbs.	103½ lbs.
Assoc. Lines	4-6-2 { 2 cyl. simple	25 in. x 28 in. } 200 lbs. }	113½ in.	98,000 lbs.	920 lbs.	106½ lbs.
Assoc. Lines	2-8-2	26 in. x 28 in. } 200 lbs. }	122½ in.	106,200 lbs.	965 lbs.	110 lbs.
						Average.... 105 lbs.

The data on American rods is unlimited and the checking of many rods on this comparative basis gives about the same figure as the average for the six cases chosen.

Any main rod made of open hearth steel (80,000 lbs.) that carries 100 lbs. or more per pound weight of rod can be considered as good practice. This figure is a convenient way to check

cold from a full sized bloom of each heat has, when tested, an ultimate tensile strength of 80,000 lbs. per sq. in., and an elongation of 20 per cent. in a test section originally 2 in. long. Blooms will not be used that show an ultimate strength of less than 75,000 lbs. per sq. in., or more than 90,000 lbs. per sq. in., or an elongation of less than 15 per cent.

CHROME-VANADIUM STEEL WHEELS

Records covering five pairs of carbon and eight pairs of chrome-vanadium solid steel wheels under tenders of Atlantic type locomotives on the Vandalia show that the chrome-vanadium wheels will give about two and a half times as much mileage per unit of wear as the carbon steel wheels. The records cover three and a half years' service and up to the present time the vanadium wheels in these tests have made a mileage of over 300,000 miles and it is reported that they appear to be able to run 400,000 miles before being worn to the limit. The record of mileage for 1-16 in. reduction in diameter due to wear and also to wear and turning is given in the accompanying table:

	Chrome-Vanadium Wheels.	Carbon Steel Wheels.	Per Cent. Difference.
Coal capacity, tender, tons.....	12	12	...
Water capacity, tender, gallons.....	7,500	7,500	...
Weight of tender in working order, pounds....	143,000	143,000	...
Average load per wheel, pounds.....	17,875	17,875	...
Average mileage per ⅜ in. diam. wear.....	12,857	9,259	38
Average mileage per ⅜ in. diam. wear and turning	6,137	2,427	152
Maximum mileage per ⅜ in. diameter wear and turning	6,894	3,344	105
Minimum mileage per ⅜ in. diam. wear and turning	5,536	1,294	327

It will be noted that while the mileage of the vanadium wheels due to wear is about 38 per cent. greater, when the turning is also included it is 152 per cent. greater. This is because the increased flange wear on the carbon wheels necessitated a greater reduction in the diameter to obtain the proper contour.

A pair of chrome vanadium wheels included in these tests, which had then completed 258,000 miles, was exhibited at the last Atlantic City convention by the American Vanadium Company. Following the exhibition this set of wheels was cut up for test purposes and a series of physical and chemical tests were made. The physical tests showed an elastic limit from 89,400 lbs. to 105,450 lbs., with an ultimate strength varying from 132,530 lbs. to 148,000 lbs. The hardness tests showed an average across the cross section of the tread of 45 by the scleroscope.

During the past few years investigations have been conducted to determine the most satisfactory commercial method of heat treating chrome-vanadium wheels. As a result of this work a method of treatment has many advantages from a commercial standpoint, and gives a wheel of uniform physical properties, has been developed. This consists of heating the wheel to a certain temperature and then spinning it with the tread immersed in a trough of water to a little below the limit of wear line, for a predetermined length of time. It is then taken out and allowed to cool in the air after which it is re-heated for annealing. Results obtained from the investigations of wheels treated in this manner indicate that the best wheel should show on the tread and on the face of the wheel a scleroscope hardness of from 40 to 55 which represents an elastic limit across the tread of from 89,000 lbs. to 90,000 lbs. per square in., with an elongation in 2 in. of not less than 12½ per cent. and a reduction of area of not less than 40 per cent. The results of these tests and investigations indicate that a most satisfactory solution of the problem of excessive wheel wear and shelling can be obtained by heat treated vanadium steel.

TRANSMISSION OF ELECTRIC POWER

Flow of Water from Pumps Used to Explain the Various Systems of Electric Distribution

BY L. R. POMEROY.

There are two general systems of electrical distribution—direct current (d. c.) in which the flow is always in one direction and alternating current (a. c.) in which the flow is first in one direction and then in the other.

The direct current system may be divided in two classes: constant current, in which the current remains constant, regardless of the resistance of the circuit, and constant voltage, in which the pressure or voltage remains constant, regardless of the amount of current flowing. A constant current generator may be compared to a plunger pump, from which a constant volume of fluid is displaced, regardless of the resistance in the pipes or the head against which it works; while a constant voltage generator may be likened to a centrifugal fan, which delivers a constant pressure for any flow up to its limit. The constant current system is used extensively in America for arc lighting, where it is common practice to install long series of lamps for street lighting.

It will tend to move in such a direction as to increase the number of magnetic lines through the coil. Whenever a coil is rotated in a magnetic field, the magnetic lines pass through it, first in one direction and then in the other. This causes the pressure at the terminals to reverse or alternate in direction, and if a direct or uni-directional current is to be obtained from the generator, some arrangement must be provided for changing or commutating the direction of the current. This device is called a commutator, while the coils which produce the pressure, together with the core upon which they are wound, is the armature. The portion of the machine which produces the magnetic field is termed the field.

An arrangement consisting of a piston and cylinder with a pipe connecting the two ends of the cylinder is shown in Fig. 1. If the piston is moved back and forth, the fluid will be forced through the pipe, first in one direction, then in the other. In

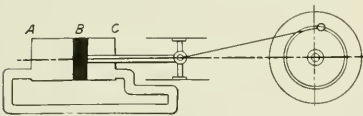

Fig. 1—Pump Giving a Reversing Current.

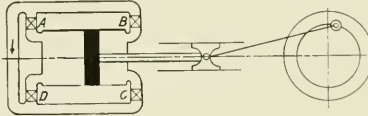

Fig. 3—Pump Giving a Direct Current.

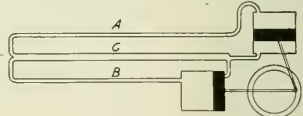

Fig. 5—Pumps Illustrating the Flow from a Two-Phase Generator.

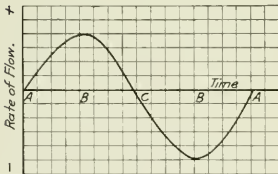

Fig. 2—Diagram of Flow from the Pump Shown Above.

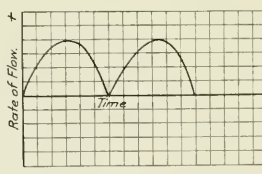

Fig. 4—Diagram of Flow from the Pump Shown Above.

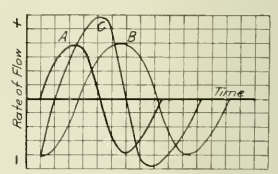

Fig. 6—Diagram of Flow in the Pipes Connected as Shown Above.

It is also used in France and Switzerland for transmitting power over long distances, in which case extremely high pressures are used. The constant pressure system is, however, the one which is employed in the great majority of cases, and it is the one referred to whenever direct current is mentioned, unless it is specifically stated otherwise.

The alternating current system may also be divided into constant current and constant pressure; the latter again into single and multi-phase. The constant current alternating-current system is generally used for arc lighting, but with this exception, all alternating-current working is on the constant pressure system. The single-phase system was installed originally for lighting only, but of late years the advent of the single-phase railway motor has brought it again into prominence for railway work. Single-phase motors of small size are now also made to give satisfactory service for industrial work, but the great majority of alternating-current power work is done on the two or three-phase system.

The operation of all commercial electric machines is based on the fact that when a coil of wire is moved in a magnetic field so that the number of magnetic lines threading through it is changed, a pressure or voltage is set up, and if the ends of the coil are joined, a current flows through it. Conversely, if a current is passed through a coil placed in the magnetic field

other words, there is an alternating current in the pipe. If the crank driving the piston is rotated at a constant speed, the flow through the pipe will be as shown in Fig. 2. When the piston is at *A* its speed is zero, as it moves to the right its speed increases, and reaches a maximum at *B*, then decreases again to zero at *C*. The rate of flow through the pipe corresponds to the velocity of the piston, and, as is well known, follows the sine law. In the same way, the pressure developed by an a. c. generator follows a sine law, and though certain conditions may modify the shape of the wave, the sine form is the one most desired.

A modification of the arrangement shown in Fig. 1 is illustrated in Fig. 3. At both the top and bottom of the cylinder are pipes connecting the two ends, and these two pipes are connected by a third. At *A*, *B*, *C* and *D* valves are placed. If, when the piston moves from left to right, valves *B* and *D* are opened, and *A* and *C* closed, then the fluid flows in the connecting pipe as is indicated by the arrow. If, as the direction of the movement of the piston is changed, valves *A* and *C* are opened and *B* and *D* closed, the current will flow through the common pipe in the same direction as before. An arrangement of this kind gives a direct current in the connecting pipe. The function of the valves *A*, *B*, *C* and *D* corresponds to that of the commutator of a direct-current machine.

It is to be expected that if trouble occurred with an arrangement of this kind it would be with the valve gear. Trouble would be especially liable to occur if the apparatus operated at high speed. The analogy holds with reference to a d. c. machine, where the chief source of trouble is the commutator, and although modern machines leave little to be desired so far as commutation is concerned, the commutator is always the part of the machine requiring the greatest amount of attention. Further, it is evident that the greater the pressure in the cylinder the greater the chance of trouble with the valve gear. The same holds true with regard to the commutator, and it has been found from actual practice that a pressure much above 600 volts is difficult to handle on a commutator unless very special precautions are taken, and it is this fact that has limited most of the d. c. systems to about 600 volts.

If there are two cylinders with their pistons displaced 90 deg., as shown in Fig. 5, each piston may drive fluid through a

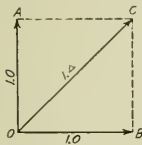

Fig. 7—Diagram Showing Resultant Pressure in Pipe C. Fig. 5.

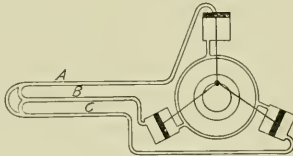

Fig. 8—Pumps Illustrating the Flow from a Three-Phase Generator.

pipe from one end of the cylinder to the other, as is Fig. 1, in which case the rate of flow from one cylinder will be a maximum when that from the other is zero. Fig. 6 represents this graphically, in which curve A shows the direction of the flow of the fluid in the pipe A of Fig. 5 and curve B the flow in pipe B.

There may be two pipes from each cylinder, in which case we have what is equivalent to a four-wire, two-phase system, but instead of using four pipes two of them may be combined and replaced by a single larger one as pipe C in Fig. 5, and since the maximum rate of flow does not occur at the same time in the two cylinders the common pipe need have only 1.4 times the area of the others. Therefore a saving has been made in the total amount of piping required. If the maximum rate of flow through A or B is 100 cubic feet a minute, then the maximum rate of flow through C is 140 cu. ft. a minute. Similarly, if the maximum pressure between A and C is 100 lbs. per sq. in., the maximum between A and B is 140 lbs. In other words, the flow through the common pipe is 1.4 times the flow through either of the single pipes, while the pressure across the outer pipe is 1.4 times that between either outer pipe and the middle one. The value 1.4 may be obtained, as in Fig. 6, by adding the values of the two curves A and B, in which case the resultant C is obtained, and its height will be found to be 1.4 times the height of either of the others. The same result may be obtained by the diagram of forces shown in Fig. 7.

The same conditions hold true for electric working. There are two windings on the armature displaced by 90 deg. A wire may be connected to each end of each winding, in which case we have a two-phase, four-wire system; or the two windings may be connected at one point and three wires brought out, giving a two-phase, three-wire system. The current in the middle wire is 1.4 times the current in either outer wire, while the pressure between the outer wires is 1.4 times that between either outer and the middle.

Three cylinders are shown in Fig. 8 with their pistons displaced by 120 deg. If a pipe is taken from the front and from the rear end of each cylinder, six pipes will be required, and give what is equivalent to a three-phase, six-wire system. It will be found that by taking the three pipes from the inner ends of

the cylinders, or the three from the outer ends, the flow outward in two of the pipes will always balance the flow inward in the other pipe. It is therefore possible to combine three of the pipes in one, as is shown at the inner ends of the cylinders in Fig. 8. The flow in the three pipes, A, B, and C, is represented by the curves in Fig. 9, and it will be seen that at any instant the flow in one pipe in one direction is always sufficient to balance the flow in the two remaining pipes, which is in the opposite direction. The arrangement shown in Fig. 8 is equivalent in electrical working to the three-phase, three-wire system. The current in each of the wires is the same as it would be in a three-phase, six-wire system, and the pressures between any two of the three wires are equal, but each of these pressures is equal to 1.73 times the pressure across a single cylinder.* This is due to the fact that the pressures combine at an angle of 60 deg., as is shown in diagrammatic form in Fig. 10.

In a three-phase generator there are three windings on the armature placed 120 degrees apart. The usual arrangement is to join one end of each winding to a common point called the neutral, and to connect the other ends to the three line wires. The currents in the three windings are equal, provided the machine is symmetrically loaded, and the voltage across two windings is equal to 1.73 times the voltage from any terminal to the neutral point.

In a single-phase system, watts equal current (C) times pressure or voltage (E). The two-phase, four-wire system is evidently equal to two single-phase systems, and where the two phases are equally loaded, watts = 2CE. A three-wire, two-phase system is also equivalent to two single-phase systems with a common return wire, and the watts = 2CE, where C = current in one outer wire, and E = voltage between either outer wire and the middle. The three-phase, six-wire system is equivalent to three single-phase systems, and the watts = 3CE, where C and E are current and voltage across one phase. A three-phase, three-wire system is equivalent to three single-phase circuits, except that the voltage between any two wires equals 1.73 times the voltage on any one of the three single-phase circuits. The watts therefore equal 3CE, but since $E = E_1 \div 1.73$ where E_1 equals the voltage across any two wires of a three-wire system the watts = $1.73CE_1^2$; i. e., in a three-phase, three-wire system the

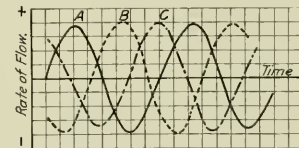

Fig. 9—Diagram of Flow in the Pipes Connected as Shown in Fig. 8.

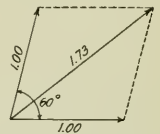

Fig. 10—Method of Obtaining the Pressure Between Either Two of the Pipes A, B or C in Fig. 8.

watts equal 1.73 times the current in one wire times the voltage between two wires. If a two-phase or three-phase system is not symmetrically loaded, it is necessary to find the watts in each phase and then take the sum.

LOSS IN TRANSMISSION.

Assume that 10 k. w. is to be transmitted at 2,000 volts by the following systems: Two-phase, four-wire; two-phase, three-wire; three-phase, three-wire, and that the resistance of each wire equals R. What will be the loss in each case?

Two-phase, four-wire.—Since there are two phases each will carry 5 k. w., and the current equals $5,000 \div 1,000$ or 5 amperes. The loss in each wire will be 5^2 times R or 25R, and the total loss will equal four times this, or 100R.

Two-phase, three-wire.—Each outside wire carries 5 amperes

*This is true if we consider that the pressure in the outer end of the cylinder is equal to that in the inner end, plus the driving pressure.

and the middle wire 1.4 times 5 or 7 amperes. The total loss will be $(2 \times 5^2 \times R) + 7^2 \times R = 99R$.

Three-phase, three-wire.—Since the output in watts of a three-phase, three-wire system $= 1.73CE$, the current in each wire $=$ watts \div 1.73E or 5.78 amperes, and the total loss will equal $3 \times 5.78^2 \times R = 100R$.

From the above it is evident that with the same voltage and losses it is possible to transmit power on the two-phase, three-wire or the three-phase, three-wire system with only three-quarters the amount of copper required for the single-phase, or for the two-phase, four-wire system, or for the direct-current, two-wire system. It should be noted, however, that with the two-phase four-wire system the voltage between the outer wires is 40 per cent. greater than with the three-phase system.

Since the power transmitted is equal to the pressure times the current, it is evident that if the pressure is increased the current is decreased proportionately, and since the loss in transmission varies as the square of the current, it is clear that if the pressure is doubled the loss is only one-fourth as great; or that the same power may be transmitted four times as far with the same loss, provided the same size of wire is used; or that the same amount of power may be transmitted the same distance with the same loss, using only one-fourth the weight of wire. For example, suppose it is desired to transmit 100 k. w., at 1,000 volts single-phase to a distance of one mile over a No. O. B. W. G. copper circuit. The current will be 100 amperes, while the resistance of such a circuit $= .95$ ohm. The loss in transmission, therefore $= 100^2 \times .95 = 9.5$ k. w. or 9.5 per cent. If the pressure is raised to 2,000 volts, the current will be 50 amperes, and the loss $= 50^2 \times .95 = 2.37$ k. w., or 2.37 per cent.

It is evident, therefore, that we may transmit at 2,000 volts for a distance of four miles over a No. O wire with the same loss as over one mile at 1,000 volts. If the voltage was raised to 10,000 the same amount of power could be transmitted 100 miles over the same size wire with the same loss, or it could be transmitted 10 miles with the same loss and same weight of copper as for one mile at 1,000 volts. This example shows the great economy in transmitting at high voltage. In fact, it is only by using very high voltages that long distance transmission is commercially possible, and even at voltages of 100,000 it is feasible only where large amounts of power are required, on account of the heavy cost of pole lines, insulators, etc.

TRANSFORMERS.

For transmission work, alternating current has one great advantage over direct current, in that it may be stepped up or stepped down by means of transformers to any pressure desired. A transformer consists essentially of an iron core around which two windings, the primary and the secondary, are placed. These are entirely insulated from each other. When an alternating current passes through the primary winding, it produces an alternating magnetic field in the core, which passes through the secondary winding, and as it alternately increases, decreases, reverses, etc., it produces a voltage in the secondary winding. The voltages on the two windings are proportional to the number of turns which each contains. For example, if there are 100 turns in the primary winding and 10,000 in the secondary, and 100 volts is impressed on the primary, the secondary will develop a pressure of 10,000 volts. It is evident that the theory of voltage generation in the secondary of a transformer is the same as in the armature windings of a generator, the difference in method being that in the generator the voltage is produced by varying the magnetic field through the coils by rotating them in a constant magnetic field, while the magnetic field through the secondary coils of a transformer is varied by the varying current through the primary coils.

The transformer is a very simple piece of apparatus. There are no moving parts, the coils are easily wound and insulated, and its efficiency is extremely high, large transformers giving over 98.5 per cent. efficiency at full load. The transformers thus

afford a ready method of obtaining high voltages for transmitting, and for lowering such voltages to values suitable for use on commercial machines. It is almost needless to say that while the pressure varies directly as the number of turns, the current varies inversely as the turns, so that except for losses in the transformer, the current times the pressure in one winding equals the current times the pressure in the others.

Quite often it is desired to transmit alternating current, and to distribute direct current for motors, lighting, etc. In such cases an alternating-current motor connected to a direct-current generator may be used. There is, however, another machine more efficient and cheaper than the motor generator set which is extensively used for this purpose. This is called a rotary converter, and is the combination of an alternating-current motor and a direct-current generator in a single machine.

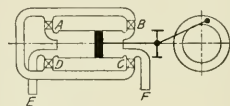

Fig. 11—Pump with Connections to Illustrate Action of a Rotary Converter.

The hydraulic analogy for a direct-current generator as given in Fig. 3, is reproduced in Fig. 11, with the addition of a pipe at each end of the cylinder. These pipes, E and F, are used to bring in fluid under alternating pressure, which is transformed to direct pressure in the cylinder. When fluid flows in at E the piston moves from left to right, with valves B and D closed and A and C opened, and current will flow through the main pipe as indicated by the arrow. If, when the end of the stroke is reached, valves A and C are closed and B and D opened, then as the current flows in at F the piston will move from right to left, and the flow in the main pipe will be in the same direction as before. Thus the alternating flow has been changed to a direct flow. In this case the piston does little more than operate the valves A, B, C and D, and the capacity of the cylinder is supposed to be very small as compared to the total amount of fluid flowing. The same conditions apply to a rotary converter. The alternating current flowing through the armature is changed by the commutator into direct current. It will be noted that the piston must move synchronously with the alternating current flow. The same applies to the rotary, which runs as a synchronous motor. If a direct current be supplied to the cylinder through the proper valves, alternating current will be delivered through the pipes E and F. The same facts apply to the operation of a rotary converter, and if it is supplied with direct current it will deliver alternating current.

It is evident also that if the outlet valves are partially closed, there may be a heavy pressure upon the piston, which is then capable of doing outside mechanical work. The same thing applies to a rotary converter. It may run as a synchronous motor and do mechanical work; it may run as a rotary converter without doing mechanical work; or it may run as a combination motor and converter, transforming from alternating to direct current, or vice versa, and at the same time do outside work.

In a three-phase rotary converter the alternating-current voltage is approximately 60 per cent. of the direct-current voltage, and in a two-phase or six-phase converter it is approximately 70 per cent. of the direct-current voltage. It is, therefore, necessary to install transformers for stepping down from the alternating-current supply voltage to such a value as to give the proper direct-current voltage. Since the ratio of alternating current to direct-current voltage is fixed within comparatively narrow limits, the direct-current voltage cannot be varied over a wide range unless some special regulating device is used. There are several devices for this purpose.

SUPERIOR EUROPEAN ROUNDHOUSE FACILITIES

As Seen on the Hungarian State Railways and in France, with Suggestions as to American Practice

BY HENRY W. JACOBS.

The engine house about to be described is at Budapest, Hungary, and consists of two roundhouses, one a half circle with 22 pits, the other a three-quarter circle with 34 pits. These are the most up-to-date roundhouses that it has been my good fortune to visit, and, therefore, merit special attention. They are built of brick and stone, with steel roofs, and a double swinging door to each stall. Both buildings are equipped with the Fabel central smoke uptake. The engines are backed into the stalls, tender first, and over the small diameter circle above their stacks is a large rectangular duct into which the smoke jacks carry the fumes from the locomotive stacks. One hundred and twenty degrees apart are ducts that lead from this inner circular duct to the outer wall where they are connected with a tall brick stack. In this way a good draft is secured that takes every vestige of smoke out of the roundhouse, leaving a clear atmosphere. I have never seen such a thoroughly successful method of ventilating a roundhouse. The chimneys are about

For boiler washing the Schilhan Wittenberg hot water system is installed, which utilizes the steam from incoming engines for heating the water. In the roundhouse is an electrically operated drop pit, using a 9 h. p. motor, which is kept in scrupulously clean condition. There are separate office buildings for the chief roundhouse foreman and the assistants and clerks attached to him; in this office building is, as in each of the shops, a small emergency surgical operating room.

In the air brake instruction room are facilities for instruction in the use of the brakes, as well as in the use of lubricators, first aid to the injured, high tension electric apparatus, different locomotive valve gear, signals, etc. On the walls are charts and tables illustrating these.

Attached to the roundhouse is a small shop with four pits for light locomotive repairs, and the necessary machine shop equipment for carrying on these repairs. A jib crane of five tons capacity serves to hoist heavy parts to their respective machines.

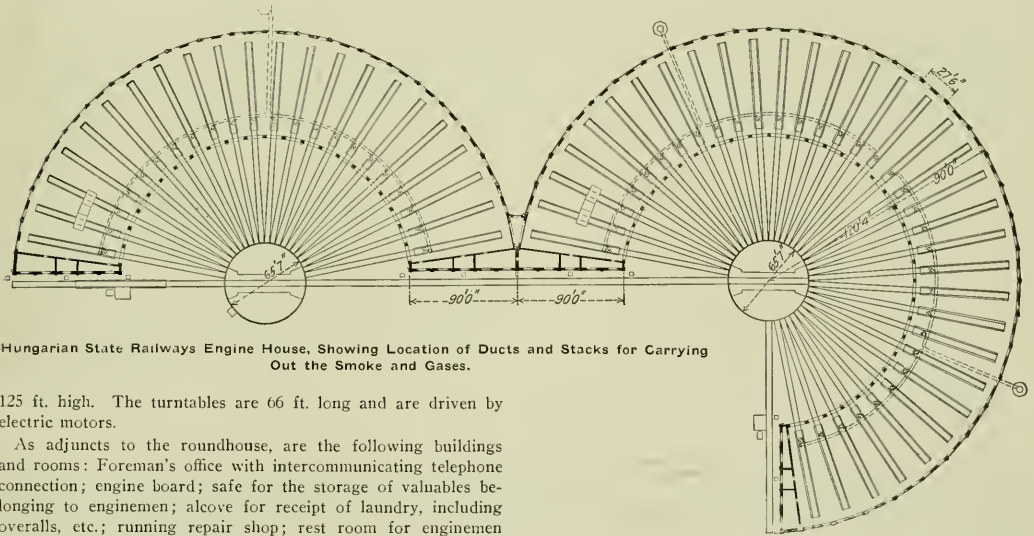

Hungarian State Railways Engine House, Showing Location of Ducts and Stacks for Carrying Out the Smoke and Gases.

125 ft. high. The turntables are 66 ft. long and are driven by electric motors.

As adjuncts to the roundhouse, are the following buildings and rooms: Foreman's office with intercommunicating telephone connection; engine board; safe for the storage of valuables belonging to enginemen; alcove for receipt of laundry, including overalls, etc.; running repair shop; rest room for enginemen with facilities for turning in time tickets, speed recorder diagrams, work books, etc.; the clothes lockers of each individual engineer are in the roundhouse proper; rest room for firemen and hostlers, heated by gas and fitted with clothes lockers for each individual man; room for the care of oil cans, each individual engineer having his own cans and allotted shelf; room for care of engine lamps; room for roundhouse machinists; room for air brake instruction; room for foreman of the electrical equipment; carpenter's shop; electric transformer room; and rooms containing gas hot water preheaters for outgoing locomotives.

A word should be said as to the care of the oil, oil cans, lamps and supplies for locomotives. These articles are assigned to the individual engineers so that notwithstanding the locomotive pooling system, the men retain their individual equipment of supplies and tools, and have an interest in their economical use.

In this shop building are also two smith fires, an oxy-acetylene welding outfit, pipe and coppersmith benches and fires, together with a babbitt furnace, etc. Attached also to the roundhouse is a complete store building with equipment for handling oils without waste, and for the safe storage and easy handling of new and scrap materials.

A provision that was made for the personnel was most surprising; namely, an auto bus service consisting of two auto buses that made regular scheduled trips to outlying residence districts to take the enginemen to and from their runs. A garage, with a room for the chauffeurs of these auto buses, was also provided.

Another small building contained twelve compartments for engineers and firemen, with individual beds, besides six bath rooms, four showers, two wash rooms and two dining rooms with heating facilities for the lunches that the men might bring

with them. Great importance was attached to absolute cleanliness and quiet in these lodging quarters. A lunch room where light refreshments and coffee could be purchased, and accommodating about 100 men at one sitting, was also provided.

A sand drying and storage house formed a part of the plant, together with ash pits permitting the cleaning of the fires of ten locomotives at the same time, with ten water cranes constituted so that water could be taken without moving the locomotives.

In connection with the coaling plant, where the coal was unloaded from the cars first onto the ground, thence to tram cars which were carried by elevator to a concrete platform, where they were dumped direct in the tenders, was an electrically driven circular saw for sawing scrap wood into convenient lengths for firing up locomotives. There was also a mechanical coal sorting device used to determine the quality of the coal received. An inspector would select arbitrarily certain cars of coal, dump these into the machine, which sorted the coal out and determined the proportion of each size, the chemical and heat unit analysis being made from samples of each size; the coal is purchased on the basis of certain specifications.

A conspicuous feature of the roundhouse was the water tower, which had a capacity of 35,000 cu. ft. The bottom of this tank was over 90 ft. above the level of the track, the top level of the water being over 120 ft. above it. The space in the enclosed brick portion underneath the tank served for certain stores.

The accompanying photographs describe better than words the general excellence of the arrangement of this roundhouse, which, as stated before, is the most improved and completely equipped one I have ever seen.

Below are statistics as to the locomotive performance for the 3,500 locomotives of the Hungarian State Lines, for the year 1911:

Total coal consumption for the year.....	3,580,000 tons
Thousand ton-miles run	20,300,000 tons
Price per ton of coal.....	\$1.48
Coal consumed per thousand ton-miles.....	350 lbs.
Cost per thousand ton-miles.....	\$0.27
Average locomotive miles run per year:	
1st Class engines	27,000
2nd Class engines	23,000

Another modern European roundhouse is in France. One of the most important division points on the Eastern Railway of France is at Mohon, and complete facilities have been provided for the proper terminal maintenance of locomotives. The arrangement provides for two connecting engine houses of 32 stalls each and a moderate size repair shop, together with coaling stations, etc. The most interesting feature of the terminal is the elaborate design of the engine house. As will be seen by

reference to the illustration, which is taken from the *Revue Generale des Chemins de Fer*, the track arrangement is the same as is employed in this country, and provides a 75-ft. turntable. The turntable pit and the inner circle of the house are com-

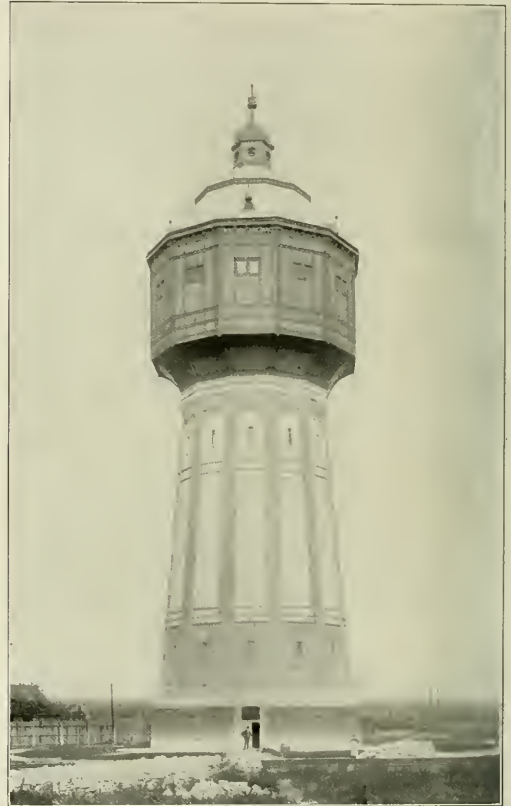

Engine House Water Tank 140 Feet High and Having 260,000 Gals. Capacity; Hungarian State Railways.

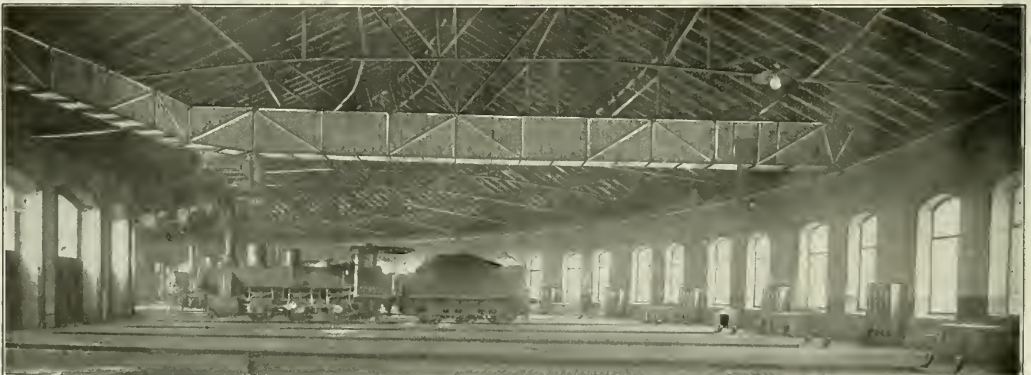

Locomotives face toward the center, and the smoke jacks carry the smoke and gases through the ducts to two high stacks outside, as shown on the drawing.

Interior of Engine House at Budapest on Hungarian State Railways.

pletely covered by a large dome having a clear span of about 132 ft. 2 in. This has a large ventilator in the center and a series of skylights near the bottom of the arch. Surrounding this is a series of what practically corresponds to separate gabled roofed structures, arranged radially, each of which covers two pits. The roof beams are supported by a series of four posts and the outer brick pilasters; this part of the structure is of wood except for the outer wall, which is of brick. The central arch is steel, covered with a zinc roofing.

The smoke jack arrangement indicates that the locomotives are stored with the tenders outward. On each side of the gables are large skylights and the outside wall is about two-thirds glass; it is evident from the illustration that the lighting will be entirely satisfactory if the glass is kept clean. In the top of each gable are large ventilators. Each of these engine houses is about 275 ft. inside diameter and the pits are 65 ft. in length. The distance from the outside wall to the steel columns supporting the dome is 71 ft. The dome is 54 ft. 10 in. high to the top of the ventilator in the center.

While the descriptions of European roundhouses may be of

of a door for each engine stall. The only doors necessary in this case are those at the entrance in the outer walls, which may be kept closed with much less difficulty. The roofed over central area may still further be made use of by paving the space between the tracks leading to the stalls and so making it available for trucking purposes.

Further, by covering the turntable pit with a floor attached to and revolving with the turntable, much time may be saved in trucking from one part of the roundhouse to another, because it would then be possible to take the shortest route over the pavement between the track and the covered turntable pit instead of being obliged to follow around the outer wall of the roundhouse, as is now the case.

The covered turntable pit would furthermore make it impossible for anything to fall into the pit and consequently prevent many accidents to the employees and to the turntable itself, with the resulting delays in getting engines into and out of the roundhouse.

Carrying this plan a step further, it should be practicable to enlarge the turntable pit until it had a diameter co-equal with

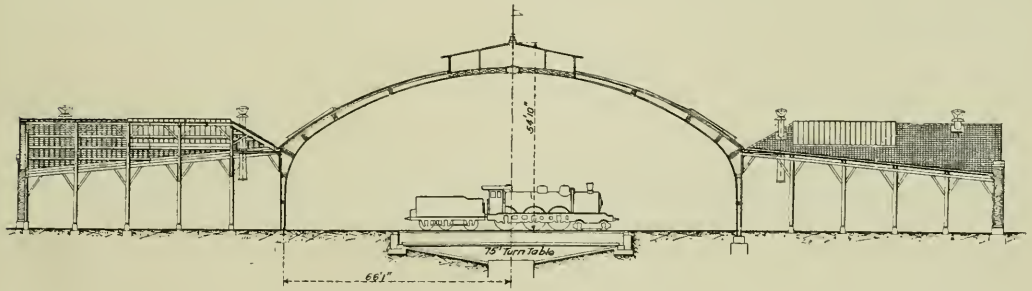
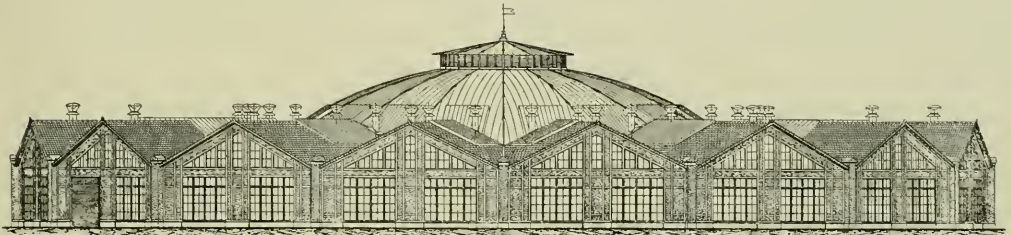

Engine House at Mohon on the Southern Railway of France.

interest, the practical American will ask how far these principles would benefit our conditions here. I believe the benefits may be very substantial, very practical, and not unduly costly. The present plan of roundhouse construction followed in this country possesses a number of highly objectionable features, some of which are outlined below together with suggestions for remedying them.

The difficulty experienced in properly heating a roundhouse in winter is in a large measure due to the inability to keep closed the numerous large and unwieldy doors necessitated by the type of construction employed. On some of the northern roads like the Grand Trunk Pacific, special types of quick closing doors have been introduced. This difficulty has also been overcome on some European roads by the simple expedient of roofing over the central area, as shown in the accompanying perspective drawing, thereby avoiding the expense and trouble

that of the circle bounding the inner ends of the stalls. This would require a turntable some 150 ft. or over in length, the construction of which should involve no serious difficulty. Such a turntable could be supported on several concentric rails and could also be so jointed and equalized as to allow of taking up slight inequalities of vertical movement due to the rails not being exactly level at all spots. But in turning, the engine would be balanced at the middle of the table as now, the main weight being borne by the center pivot. This pit might be very shallow, say 12 or 18 in. The girders supporting the turning locomotive, if raised above the floor level, should allow ample clearance so no men could be caught between them and the locomotive.

By then covering this whole central area with a revolving floor (and doing away with the radial tracks, except in the stalls themselves), certain light machines and benches, clothes lockers, offices and other roundhouse appurtenances taking up room but

not involving heavy weights, could be carried on this great central table, thus utilizing fully the entire investment in ground space and in roof. At the same time much greater convenience would result in the roundhouse handling and repair work.

The smoke jacks commonly provided for smoke removal have proved themselves very inadequate and the atmosphere of the roundhouse is usually heavily charged with smoke, soot and gases, making a disagreeable and unhealthful environment for the workmen. This smoke filled atmosphere shuts off the light from the stalls, which condition is aggravated by the deposits of soot and grime on the windows, reducing the amount of light

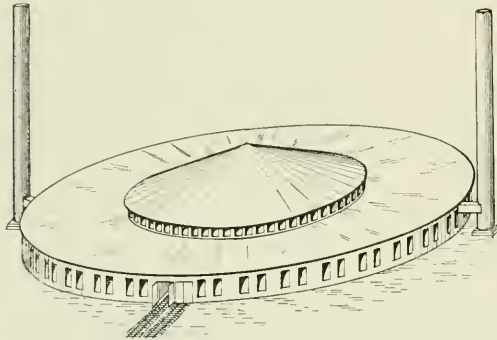

Roundhouse with Roof over Central Area and Engine Stalls Connected to High Stacks by Circumferential Smoke Ducts.

admitted, which is still further decreased by being absorbed by the smoke blackened walls and roof. Under such conditions it is impossible for the workmen to attain their highest efficiency, especially in winter when the numerous doors make it impossible to keep the temperature in a roundhouse comfortable.

We have referred to the European practice of removing the obnoxious gases and smoke by installing overhead circumferential smoke ducts or canals which are connected to tall chimneys located outside of the building. These ducts are provided with openings and hoods at each engine stall under which the stacks of the engines are placed. The strong draft induced by the

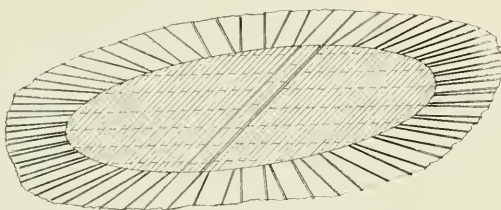

Turntable Pit Completely Covered by Revolving Floor Attached to Turntable and with Space Between Rails in Central Area Paved to the Level of the Tops of the Rails.

tall chimneys carries away every vestige of the products of combustion discharged from the locomotive stacks and leaves the atmosphere of the building clear and well ventilated.

If a steel stack were used instead of one of brick, and possibly a central support were adopted in connection with the turntable, a single stack at the center of the dome might economically take the place of the two or three commonly used in Europe for this purpose.

Some mention should be made of the European practice of placing the locomotives in the stalls with their stacks toward the turntable. With the covered center and with adequate roof lighting, this should cause no difficulty in doing work on cyl-

inders, valves, front ends, superheaters and flues, and should facilitate the handling of material. This plan should also make simpler the installation of a crane for handling cylinders, bushings, cylinder heads, valve chests, pistons, rods, etc.; in fact, the large revolving floor could be used as such a crane, carrying heavy material around to that part of the roundhouse near the machine shop or smith fires. An advantage of this proposed construction of central roof and revolving floor, is that it may be readily applied at a moderate expense to almost any existing roundhouse.

Lastly it may be observed that in many engine terminal layouts in this country and in Europe, there is a tendency to build too substantially, too permanently, too well, with brick and concrete, costly coaling stations, ash pits, and other structures. In five years, or in ten or fifteen, transportation conditions may so change that the facilities will also require extensive changes. Therefore, engine houses and their appurtenances should be so designed and built that they are temporary and removable in their nature, so that changes in terminal track location, in engine handling movement, in extension of stalls, even in removing completely the engine terminal to a new location, or in moving a division terminal, may be made with the least expense and the least loss in abandoned facilities.

EFFECT OF PIGMENTS ON THE CONSTANTS OF LINSEED OIL.*

BY HENRY A. GARDNER,

Assistant Director, The Institute of Industrial Research, Washington, D. C.

When sealed packages of paints of the cheaper grades are opened after having been stored for a considerable length of time, there is occasionally observed a degree of hardness that renders application difficult. The user is generally at a loss to account for such a condition, inasmuch as the modern metal container is air-tight and has but little room for improvement. The cause of the hardening that has taken place may therefore be assumed to result from certain reactions between the different constituents of the paint.

Nearly two years ago the writer carefully prepared a series of paints from various well-known pigments, using as a grinding medium a standard vehicle of pure linseed oil containing neither drier nor thinner of any type. The amount of oil used with each pigment was sufficient to bring the paints in every case to a relative viscosity or body, which was somewhat heavier than is ordinarily used in the application of paints to wooden or metal surfaces. These paints, after preparation, were carefully placed in friction-top tin containers. They were moved about occasionally and were subjected to shipment by freight on two occasions, finally remaining on a shelf in the writer's laboratory for nearly a year previous to examination. Upon removing the lids from the cans there was evidenced, by the appearance of some of the paints, a considerable change of a chemical nature. The paints were placed individually in two-quart glass jars with a large quantity of a solvent mixture made of 90 deg. benzol and 86 deg. petroleum ether. After the pigment content of the paint had settled out by gravity, the solvent containing the oil in solution was removed by a syphon and subjected to distillation. The temperature of distillation was kept at a point sufficiently high to remove the low boiling point solvent, but not high enough to affect the oil residue. The usual method of oil examination was then followed, many of the determinations being made in duplicate. The results of these tests are given in the accompanying table.

These results show that inert pigments such as barytes, iron oxide, graphite and carbon black do not enter into chemical action with linseed oil; the percentage of ash found in the oil extracted from the above pigments being practically identical

*Taken from the Journal of The Franklin Institute, October, 1912.

with the percentage shown by the raw oil. That such pigments may, however, have some physical action upon the oil, that will later develop a chemical change therein, seems evident. The thickened condition of the oil extracted from the silica paint, and the low iodine values and high acid values shown by all of the oils extracted from the above-mentioned inert pigments, would give credence to the above statement.

The pigment that is ordinarily termed American vermilion, the true form of which is a basic chromate of lead, seems to have had no very marked effect upon the oil in which it was ground. It would seem, therefore, that it would prove quite practical to transport this pigment in paste form. On account of its value as a protective of metal, it will probably replace, to some extent, the use of red lead for priming steel. The pigment red lead had a marked hydrolyzing reaction on the oil in which it was ground. The latter contained a very large percentage of lead linoleate, free fatty acid, and glycerin. The iodine number of this oil was lower than that of any other extracted.

Zinc oxide and zinc lead had but slight action with the oil, while basic carbonate-white lead showed somewhat greater action, but not sufficient to be of any detriment. With paints containing mixtures of lead and zinc pigments only slight action was shown. The perfect condition of these paints indicates that

being so hard that a knife was required to make any impression upon its solidified surface. These paints, moreover, contained pigments of a basic nature, containing a very high percentage of lead and zinc. An examination of the oil in which these paints were ground showed acid values ranging from 8 to 16. That the reaction of the free acid upon the pigments was the real cause of the hardening of the paint was the writer's conclusion. A series of tests were therefore made, in which was included the treatment of paints with small percentages of free oleic acid, one of the most prominent constituents found in oils of a high acid value. There were also included tests in which paints were treated with sulphites, there existing in the paint industry a false belief that lead and zinc pigments are apt to body and harden in oil if they contain even traces of sulphur dioxide or sulphites. Those who have held such a belief should some time examine paints made of sublimed blue lead, a pigment which contains nearly 5 per cent. of metallic sulphites and sulphides. This pigment will remain as a smooth paste in oils for months without any apparent hardening.

Small quantities of dry zinc and lead pigments (basic carbonate-white lead, basic sulphate-white lead, zinc oxide, and zinc lead) were ground in a pure raw linseed oil having a normal acid value of approximately 2.8. After standing for three days,

RESULTS OF EXAMINATION OF OILS EXTRACTED FROM PAINTS.

Pigment.	Specific gravity.	Analysis—			Acid value.	Condition on opening.
		Ash (per cent.)	Iodine No.	Acid value.		
Analysis of original oil.....	0.932	0.190	181	2.5		
Zinc oxide	0.9237	0.36	161	3.5	{ Paint in excellent condition. Light colored oil floating on top. Contained fine white zinc of a colloidal nature after extraction with solvent.	
Corroded white lead (basic carbonate-white lead).....	0.9372	1.149	157.5	8.6		
Leaded zinc	0.9389	0.922	157.4	5.7	{ Paint had thick, wrinkled skin on top but was in very fair condition. Oil, after extraction, was light colored and clear.	
50 per cent. corroded white lead (as above).....		0.674	154.1	6.7		
40 per cent. zinc oxide.....					{ Paint in very good condition. Considerable oil floating on top. Oil, after extraction, was somewhat cloudy, but cleared after 24 hours.	
10 per cent. barytes.....						
60 per cent. sublimed white lead (basic sulphate-white lead).....	0.9334	0.626	157.8	5.6	{ Paint in excellent condition. Some oil floating on top.	
40 per cent. zinc oxide.....						
Barytes (barium sulphate).....	0.9325	0.212	160.6	3.5	{ Paint settled to a considerable extent. Much clear oil floating on top.	
Silica	0.9465	0.204	149.2	8.7		
American vermilion (basic chromate of lead).....	0.939	1.271	156.7	8.3	{ Heavy, viscous oil, resembling a varnish, was floating on a partly-settled mass of pigment. Oil retained finely-divided pigment in suspension.	
Red lead		15.56	135.4	19.2		
Iron oxide	0.9457	0.456	156.3	8.6	{ Pigment settled very hard. Oil, after extraction, was dark, but clear. Pigment settled very hard. A thick, gelatinous oil floated on top of pigment. Oil, after extraction, was dark brown in color.	
Carbon black	0.9356	0.195	163	10.5		
Graphite	0.201	158.5	13.3		{ In excellent condition. Very soft, smooth paste. Oil—clear dark red after extraction.	
					{ Thin, wrinkled skin on surface. Paste below skin, very soft and smooth. Oil—clear light color after extraction.	
					{ Very soft and smooth paste. Oil—clear and light, after extraction.	

any properly-prepared combination pigment paint may be safely stored in cans for long periods without bad effects, provided the oil used is of normal grade.

The most astounding change shown in the tests was that in the iodine values of the oils extracted from all of the paints. It would appear, therefore, that when paints are stored for a considerable period of time and then examined for the iodine value of their oil content a lowering of the iodine value should not constitute cause for rejection or be sufficient evidence to state that the oil was adulterated with oils of lower iodine value. Cognizance of this statement should be given by railroads and corporations which have adopted specifications for oil paints.

When hydrolysis has taken place in a paint, considerable thickening is observed. In the tests which are charted above it will be observed that the most extravagant example of hydrolysis was shown by the red lead paint. The oil from this paint showed over 15 per cent. of inorganic lead compounds in the ash. It will also be noticed that the oil had become very acid in nature and had the appearance of a thick jelly, which may be accounted for by the large percentage of glycerin present. Although the red lead paint was very thick, difficult to break up, and too heavy for brushing, it was not really hard. The writer has had occasion, however, to examine several samples of paint recently which were very much harder than the red lead, one, in fact,

no tendency toward hardening was shown by any of the paints. They were then divided into small portions, and to each type were added various materials which were under suspicion as having, when used, some contributing effect in the hardening of paint. The following table shows the results of these experiments:

Treatment with 20 per cent. gloss oil (½ rosin, ½ benzine).....	{ Considerable hardening shown in 24 hours, indicating action between the acid rosin (resinic acids) and the basic pigments.
Treatment with 2 per cent. sodium hyposulphite	
Treatment with 5 per cent. oleic acid.....	{ No effect noticed in 6 days.
	{ Hardening occurred in two hours and increased with age. Paint resembled hard putty.

From these results it is apparent that oils of an acid nature are the most active cause of paint hardening. The use in cheaper paints of substitutes for linseed oil, which contain large percentages of rosin, as well as the promiscuous use of acid rosin driers, has been the cause of the hardening of many paints. Linseed oil containing high percentages of acid is, of course, dangerous. It is evident, therefore, that a careful consideration of the vehicle portion of a paint is even more important than the pigment part, and a careful record of the acidity of paint oils should be kept by the grinder.

The author wishes to acknowledge the assistance of Messrs. L. G. Carmick and J. E. Heckel in the analytical determinations.

STANDARDIZATION OF THE MYRIAWATT*

At a joint meeting of the American Society of Mechanical Engineers' Special Committee on Myriawatt, with the Standards Committee of the American Institute of Electrical Engineers, in December, it was decided to recommend to both societies that the "Myriawatt" be used as a unit of thermal and mechanical power. This has been done to introduce a new unit of power which will afford a basis of comparison of all converters of energy, thermal or mechanical. It will be international in its use, and is merely a new multiple of the watt, the word being taken from the Greek word "myria," meaning 10,000. With this unit, and the British thermal unit taken as 1/180 of the heat required to raise one pound of water from 32 deg. Fahr. to 212 deg. Fahr., and the equivalent evaporation from 212 deg. Fahr. as 970.4 B. t. u., which is taken from the Marks & Davis steam tables, we have the following equivalents, the myriawatt being designated as mw and the myriawatt-hour as mw-hr:

1 B. t. u.	= 0.00002928 mw-hr.
1 foot-pound	= 0.00000037662 mw-hr.
1 horse power	= 0.07457 mw
1 kilowatt	= 0.10000 mw
1 boiler horse power.	= 0.9804 mw

The value of one myriawatt will be:

1 mw	= 34150 B. t. u. per hr.
1 mw	= 26,552,000 ft.-lbs. per hr.
1 mw	= 13,410 h. p.
1 mw	= 10 k. w.
1 mw	= 1.020 boiler horse power

It is stated in the report to the American Institute of Electrical Engineers that since the present standard of one boiler horse power is equivalent to 33,479 B. t. u. per hour, and that a myriawatt is equivalent to 34,150 B. t. u. per hour, the ordinary method of determining the boiler capacity could be stretched 2 per cent., the difference between the two values, without materially affecting the present rating, and in this way entirely eliminating the term "boiler horse power," using the myriawatt in its stead.

BALTIC TYPE LOCOMOTIVE

The largest passenger locomotives in Europe were built during the past year for the Chemin de Fer du Nord, and are operating the Nord Express between Paris and Brussels. This train has a reputation of maintaining the fastest schedule in the world. The engines were designed to handle a 400-ton train

at the company's shops in Paris. They are of the four-cylinder, balanced compound type, the low pressure cylinders being between the frames, and drive through a cranked axle on the front pair of drivers. Because of the size of the inside cylinders it was not possible to place them side by side between the frames and they are therefore staggered. The main rods are of the same length, however, and the cylinder furthest ahead has a very long piston rod. Highly superheated steam is employed and the high pressure cylinders, which are about 17½ in. in diameter with a 25¼ in. stroke, have piston valves, while the low pressure cylinders, which are about 24¾ in. in diameter, with a 28¾ in. stroke, have slide valves. Each valve has an independent Walschaert valve gear.

The boiler is unusually large when compared with other European locomotives. It is about 68 in. in diameter at the front ring, of the straight top type with a Belpaire firebox on one locomotive and a water tube firebox on the other. In the Belpaire boiler there are 131 tubes; 34 of them are 2½ in. in diameter, and 97 are 2½ in. in diameter. There are also 27 superheater flues 5¼ in. in diameter. The tubes are about 23 ft. 7¼ in. in length between tube sheets and give a total heating surface of 3,190 sq. ft. The Belpaire firebox has a heating surface of 206 sq. ft., giving 3,396 sq. ft. total heating surface in the boiler. The grate area is 46.1 sq. ft. In the water tube firebox are 623 tubes, giving a heating surface of 1,280 sq. ft. The front end of the boiler is very long, measuring 10 ft. 6 in. from the tube sheet to the front ring. The superheater is of the Schmidt type, and the steam is carried through an outside pipe to the top of the high pressure steam chest.

The arrangement of the front and rear trucks is much alike and the equalization system of the drivers does not include either cross equalizers or a connection to the trucks at either end. The customary style of plate frame is employed and the springs are located above the driving boxes for the first and second pair of drivers and below at the third. The weight on the rear trucks is transferred from the frame through semi-elliptic springs secured to the outside of the locomotive frames and resting on the ends of the truck bolsters. The general dimensions of the locomotive with the Belpaire boiler are given below:

Tractive effort, compound.....	32,362 lbs.
Weight on drivers.....	119,000 lbs.
Weight on front truck.....	53,000 lbs.
Weight on trailer.....	53,000 lbs.
Weight, total engine.....	225,000 lbs.
Wheel base, driving.....	14 ft. 1 in.
Wheel base, total engine.....	41 ft. 3 in.
Cylinders, diameter.....	17½ in. and 24¾ in.
Cylinders, stroke.....	25¼ in. and 28¾ in.

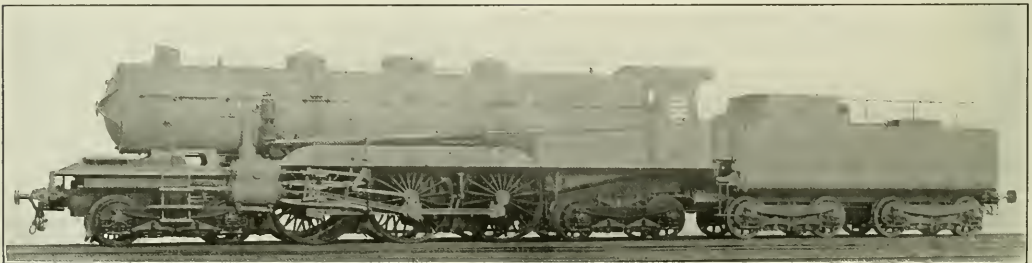

Largest Passenger Locomotive in Europe; Northern Railway of France.

behind the tender at a speed of 75 miles an hour on the level and 60 miles an hour on .5 per cent. grades.

These locomotives, of the 4-6-4 type, were designed and built under the direction of M. Asselin, chief engineer of motive power and rolling stock, the one illustrated being constructed

*Taken from the February Journal of the American Society of Mechanical Engineers.

Driving wheels, diameter.....	80 in.
Steam pressure.....	227 lbs.
Boiler, inside diameter at front ring.....	68 in.
Tubes, number and diameter.....	34—2½ in.; 97—2½ in.
Flues, number and diameter.....	27—5¼ in.
Tubes and flues, length.....	123 ft. 7¼ in.
Heating surface, tubes and flues.....	3,190 sq. ft.
Heating surface, firebox.....	206 sq. ft.
Heating surface, total.....	3,396 sq. ft.
Heating surface, superheater.....	753 sq. ft.
Grate area.....	46.1 sq. ft.

closed to the air pressure. The piston is thus driven to the rear, but is prevented from striking the rear head by the air cushion. At the rear part of the apparatus is a cylinder 8 in. in diameter which contains a piston and piston rod, and is used to brace the hammer and hold it against the work, the air pressure being supplied through the three-way cock *D*.

TURNING FOUR-BAR CROSSHEAD WRIST PINS

BY H. T. NOWELL,

General Foreman, Boston & Maine, Concord, N. H.

An arrangement for turning a four-bar crosshead wrist pin on an engine lathe is shown in the illustrations. The crosshead is first planed, centered and spotted on the top and bottom of the pin and placed in the lathe as shown in Fig. 1, counterweights being strapped on to make it run smoothly. The goose-neck tool

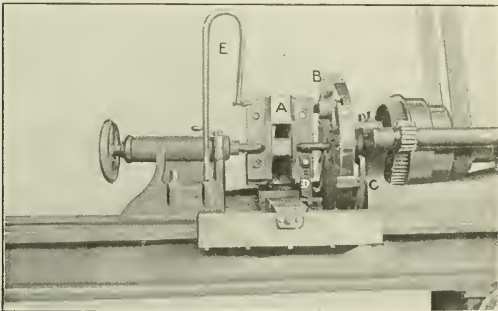

Fig. 1—Position of Crosshead at the Beginning of the Operation.

shown in Fig. 2 is used on the carriage of the lathe and is provided with right and left interchangeable heads, which are made on a swivel so that they will clear the work when the crosshead is returning to its original position. As shown in Fig. 1, the crosshead *A* is turned by the dog *B*, which is fastened to the faceplate and comes in contact with the arm *D* fastened to one end of the crosshead. The arm *C* is fastened to the bed of the

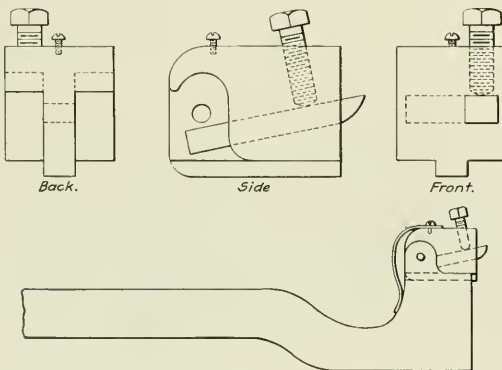

Fig. 2—Tool Used for Turning Wrist Pins.

lathe and trips the dog *B*, disengaging it from the arm *D* and allowing the coil spring *E* to pull the crosshead back to its starting position. Fig. 3 shows the crosshead just ready to be tripped. The construction of the driving-dog is shown in Fig. 4. When the arm *F*, located on the rear of the dog in a

recess, comes in contact with *C* (Fig. 1), it turns the pin *G* which bears on the projecting arm *D* on the crosshead. One-half of the end of pin *G* is cut away. This allows it to disengage from *D* when it is turned by the arm *C*. A spring is fastened to the arm *F* so as to return it to its original posi-

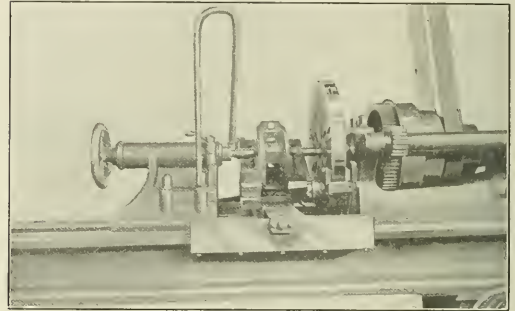

Fig. 3—Crosshead Just Ready to be Tripped.

tion after it has passed *C*. In this way the faceplate may rotate continuously and only turn the crosshead through one-half a revolution. One side of the crosshead pin is turned in this manner and then the crosshead is reversed in the machine

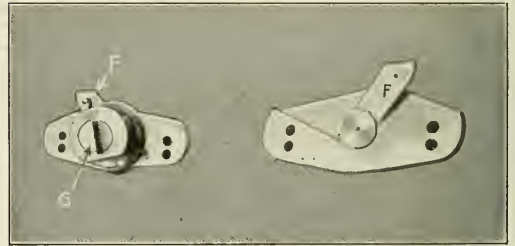

Fig. 4—Driving-Dog for Turning Crosshead Wrist Pins.

and the other half is turned. This device is simple and inexpensive, does good work and may be applied to any engine lathe with a faceplate.

RAIL CONNECTIONS BETWEEN VALENCIA AND MADRID, SPAIN.—The much talked of direct line from Valencia, Spain, to Madrid has not been included in the new law authorizing "complimentary" railways in Spain. The law only makes reference to the proposed line filling up the gap between the termini of existing lines at Cuenca and Utiel, and the Valencia people are not satisfied with this route, which is circuitous. On the other hand only 89 miles of line have to be built to connect these two termini, while of the proposed direct line via Motilla nothing is completed but the section from Valencia to Utiel. Valencia is the only large coast town which is not placed on one of the many direct lines which radiate from Madrid to the coast, although it is nearer than any other. As the crow flies the distance between the two cities is only some 186 miles, but the present route, via Encino, is 304 miles long, and the tri-weekly express takes 10½ hours to do the journey. By the Cuenca-Utiel route the distance would be reduced to 250 miles and considerably less again, via Motilla. Unfortunately, the latter route is through difficult country, and there is little hope of any local traffic of value, at least for a number of years to come, while the through passenger traffic is hardly enough to justify the present service of a daily mail train each way and an express every alternate week day.

SHOP IMPROVEMENTS AT BURNSIDE, ILL.

A Typical Illustration of What May be Done to Improve Power Conditions at Old Shops

Although the Burnside shops of the Illinois Central would hardly be considered as old shops, they have developed so rapidly during the past 10 or 15 years that in spite of boiler plant additions made in 1907, enough power was not available for the stationary engines situated in various parts of the plant. Soon after M. K. Barnum was appointed general superintendent of motive power an investigation was made by Willard Doud, shop engineer, and it was found that on account of the lack of facilities

boilers in the larger building. Nine of the boilers were equipped with Green chain grate stokers, and the products of combustion were taken care of by one brick stack 72 in. in diameter by 150 ft. high, one tile stack 86 in. in diameter by 153 ft. high, and two steel stacks 65 in. in diameter by 90 ft. and 77 ft. high respectively. All of this equipment was retained with the exception of the brick and steel stacks which were replaced by a 216 ft. reinforced concrete chimney 10 ft. inside diameter, designed by the M. W. Kellogg Company, New York, and shown in Figs. 1 and 2. It was found that the draft obtained with the old stacks had not been sufficient to burn the coal economically, and this chimney will more than handle the present number of boilers, and allow for increases in future. The 153 ft. tile stack handles the products of combustion for the 3 Cahall boilers in the second boiler house.

The handling of the coal from the cars to the boilers and the ashes from the ash pits was done entirely by hand, and

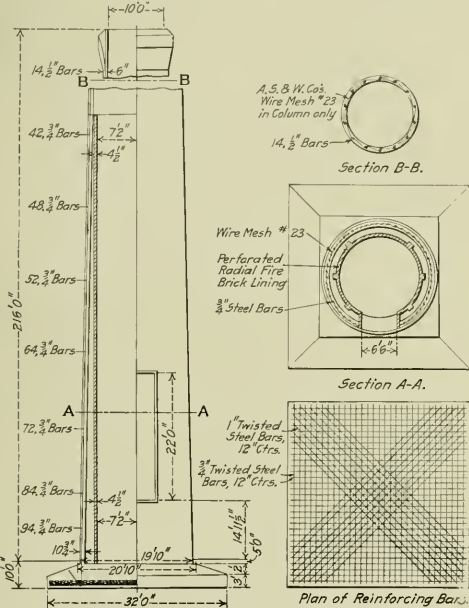

Fig. 1—Concrete Chimney for the Burnside Shops of the Illinois Central.

for handling coal and ashes, the steam was being generated at a comparatively high labor cost; that the boiler capacity could be increased by improving the chimney and ash pit arrangements; and that the cost of operating the engines distributed throughout the plant, and of transmitting the steam over the necessarily long distances, could be greatly reduced by the installation of motors throughout the plant, and generally electrifying the shops. It was also found that there was sufficient exhaust steam available in the mill engine room in addition to requirements for heating several buildings to operate low pressure turbines, which would provide the necessary amount of alternating current for the general electrification. A careful estimate of the cost of these changes showed that with an investment of about \$150,000, a substantial saving could be made in the operation of the plant. These changes have been made, which clearly demonstrate what can be done in an old plant to bring the operating costs down to moderate proportions, and to increase the efficiency of the boiler plant.

BOILER PLANT.

The boilers were located in two buildings about 50 ft. apart, and consisted of three 300 h. p. Cahall water tube boilers in the smaller building, and eight 300 h. p. Erie City water tube

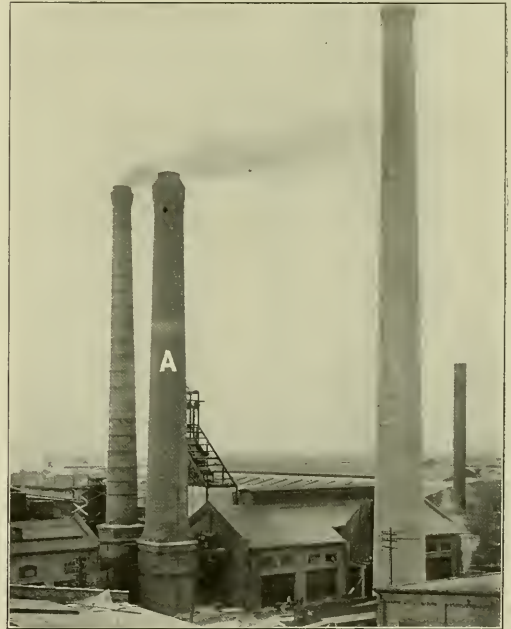

Fig. 2—Boiler House, Showing New Concrete Chimney.*

the labor cost for this work was excessive. A coal and ash handling arrangement was therefore installed, as shown in Figs. 5 and 6, which makes it possible to reduce this cost over 50 per cent. The coal is now dumped from the car directly into a depressed concrete hopper which feeds the coal automatically into two elevator buckets. These buckets are alternately raised to the top of the chute and automatically dumped into two storage bins above which a crusher is located for emergency use. From one of these bins it is distributed to a trolley conveyor, or hopper.

*The concrete chimney replaces the brick chimney A, the steel stack on the right and another steel stack, not shown, directly behind the new chimney. This photograph also shows the construction of the upper part of the coal chute. The receiving hopper and the coal crusher are plainly visible.

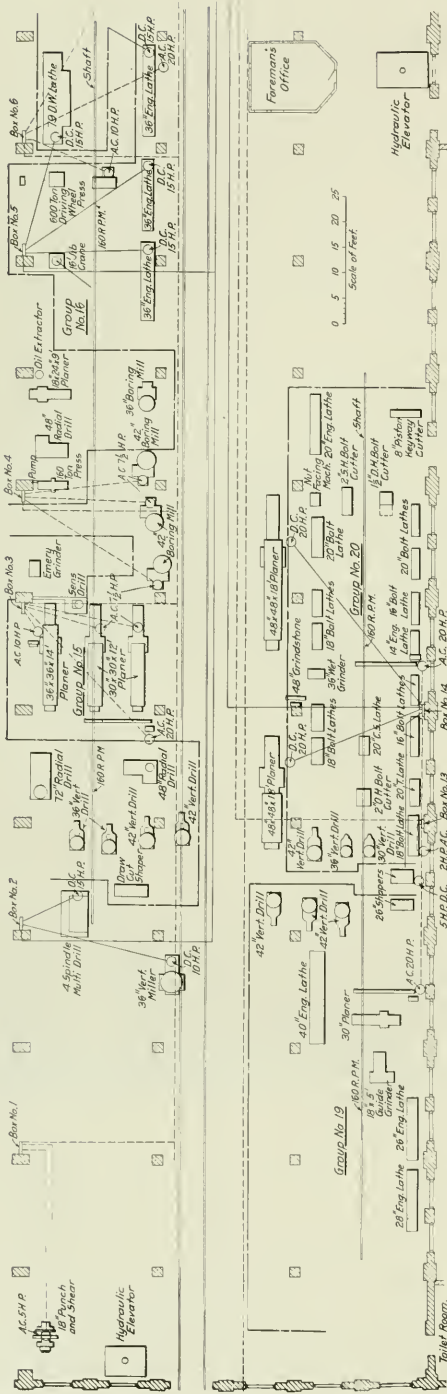

Fig. 3—South End of Machine Shop Showing Arrangement of Machine Tools, Motors and Wiring.

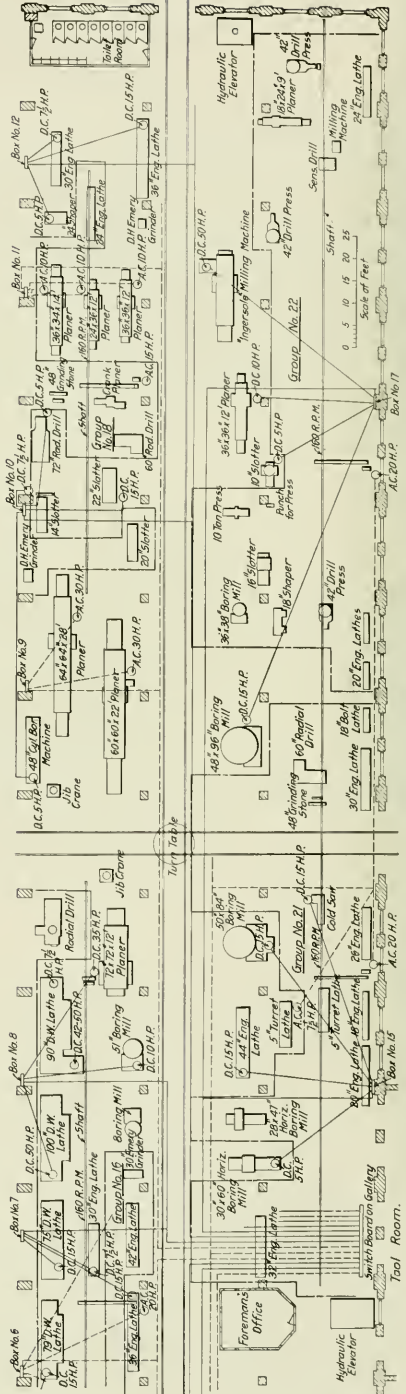

Fig. 4—North End of Machine Shop Showing Arrangement of Machine Tools, Motors and Wiring; Burnside Shops of the Illinois Central.

electrically operated, which feeds the stokers on the Erie City boilers in the main boiler house, and from the other to a belt conveyor which carries the coal over to the other boiler house

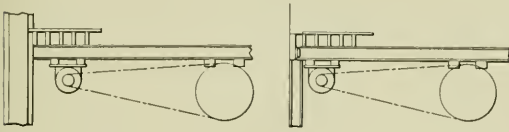

Fig. 4a—Arrangement of Motor Suspensions for the East and West Side Line Shafts.

for the three Cahall boilers. Two of these boilers are used for burning shavings and refuse from the planing mill.

It was also found that the ash pit arrangement permitted a leakage of air behind the grates which tended to cool the gases of combustion. To overcome this the stokers have been arranged to discharge into closed ash pits. The ashes are re-

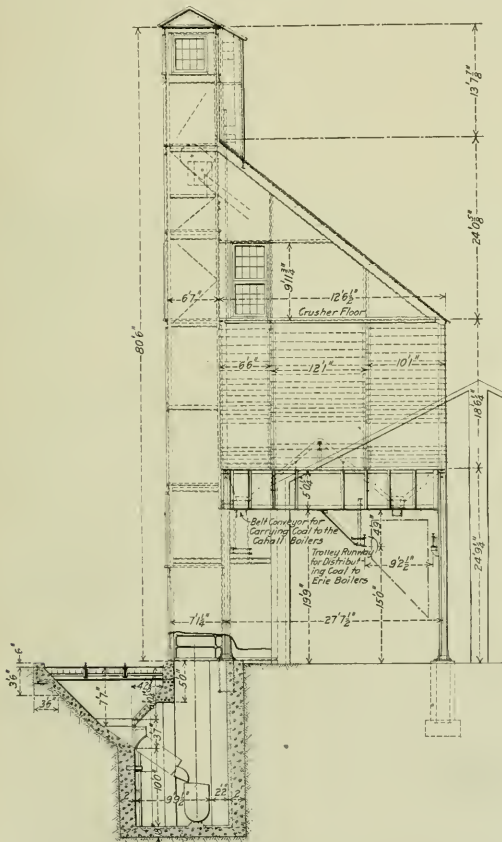

Fig. 5—General Arrangement of Coal Chute for Power Plant.

moved by a pneumatic ash conveyor designed by the Green Engineering Company, Chicago, which draws the ashes from the ash pit through a pipe to a separator and storage tank so located that the ashes may be dumped by gravity into a car for disposal. Two exhaust fans, each driven by a 30 h. p. motor running at 3,600 r. p. m., are installed for this purpose, one being held as an auxiliary. The ashes and air are separated in

the receiver or hopper so that there is no eroding action possible in the exhaust fans. This arrangement has proved very efficient and has eliminated the necessity for more than 3 men in the ash handling gang.

ENGINE PLANT.

The engine equipment consisted of various sizes of engines distributed throughout the plant at some distance from the boiler plant, which necessitated expensive labor costs and extensive steam lines with a corresponding loss in the transmission of steam. The engines in the mill engine room, which is near the boiler plant, were retained in service, but one 220 h. p. and 3 smaller engines in the machine and erecting shops, a 105 h. p. and 25 h. p. engine in the smith shop, and a 35 h. p. engine in the rolling mill, making a total of 7 engines, have been replaced by motors. An addition has been built to the mill engine room for two Allis-Chalmers 750 k. v. a., 3 phase, 60 cycle 440 volt direct connected mixed pressure turbo-generators arranged for normal operation on exhaust steam and shown in Fig. 8. While one is of sufficient capacity to supply the present demands for the additional electric power, two



Fig. 6—Coal Chute and Ash Separator for Power Plant

were installed as a matter of safeguard in case of breakdown, and to have ready means for supplying additional power when necessary to do so. The supply of steam for this equipment is taken from the engine equipment in the mill engine room, which consists of a 20 in. x 21 in. Buckeye single engine driving a 220 volt Westinghouse d. c. generator, a 28 in. x 48 in. Corliss driving the machinery in the planing mill, and two duplex air compressors, 22 in. x 30 in., and 20 in. x 26 in. respectively. A Westinghouse Le Blanc turbine driven condenser located on the engine room floor level is provided for each turbine, and the circulating water is cooled in a fan draft tower located adjacent to the engine room. Two 15 k. w., 125 volt Allis-Chalmers exciting generators are provided, one being driven by an a. c. motor and the other by a Terry turbine.

In making the change the only building originally using exhaust steam for heating where live steam is now used for the

same purpose was the machine and erecting shop where on account of the location of the building it was figured that the exhaust steam could not be used to any great advantage, and

low pressure steam from the boilers is now used for the heating system. A 3,000 h. p. Platt Iron Works feed water heater was installed to heat the boiler feed water. Two 14 in. x 8 in.

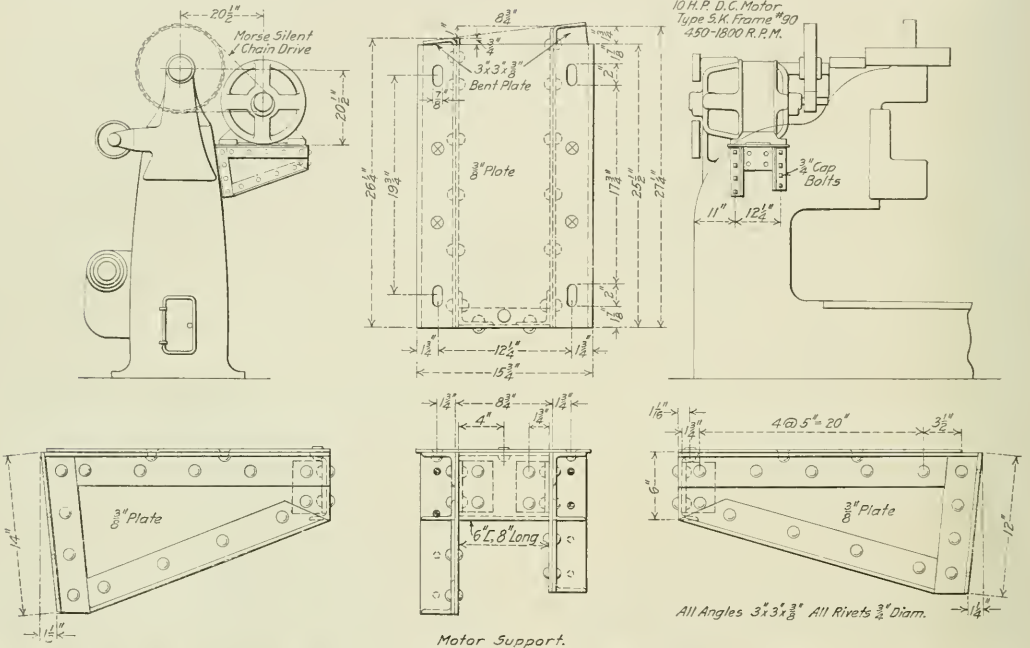

Motor Support.

Fig. 7—Application of a Motor Drive to a Vertical Miller.

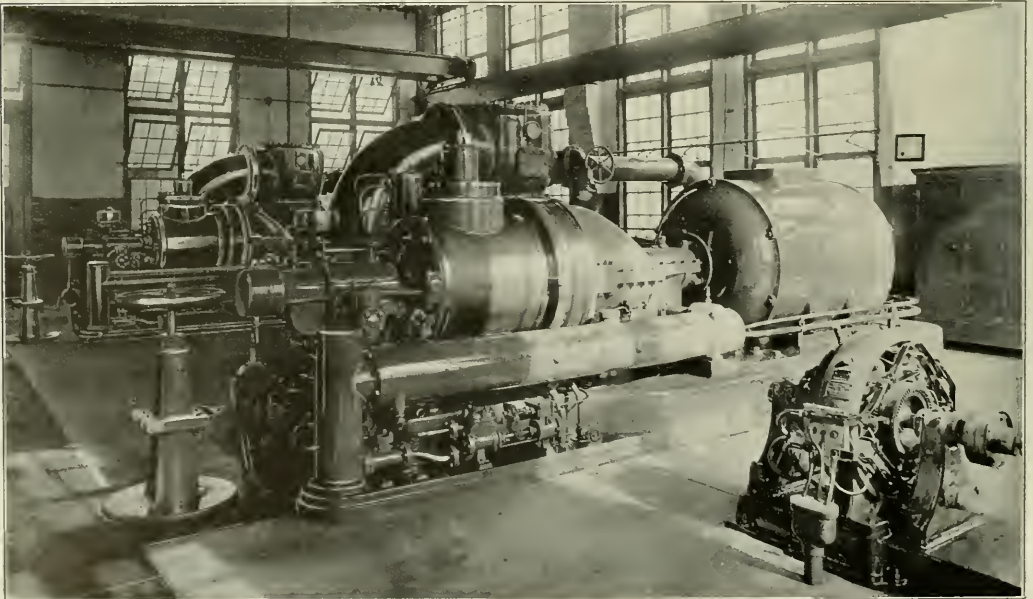

Fig. 8—Low Pressure Turbines and Le Blanc Condenser.

x 12 in. Blake pot valve pumps were also added for feeding the boilers.

MOTOR INSTALLATIONS.

With the addition of the alternating current generators it was found that a more logical and economical distribution of power could be effected, and in many instances direct current motors running at a constant speed were replaced by a. c. motors, the

d. c. motors being used where variable speeds were required. In the machine and erecting shop the machines were divided into groups, as shown in Figs. 3, 4 and 4a, each group being driven by an a. c. motor. This greatly reduced the length of main shafts required, and also eliminated the attendant losses due to friction.

One noteworthy change was in the elimination of a rope drive

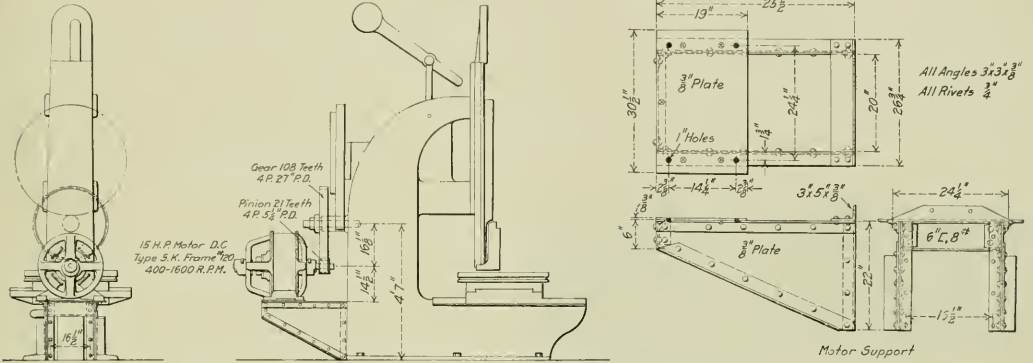

Fig. 9—Application of a Motor Drive to a Slotter.

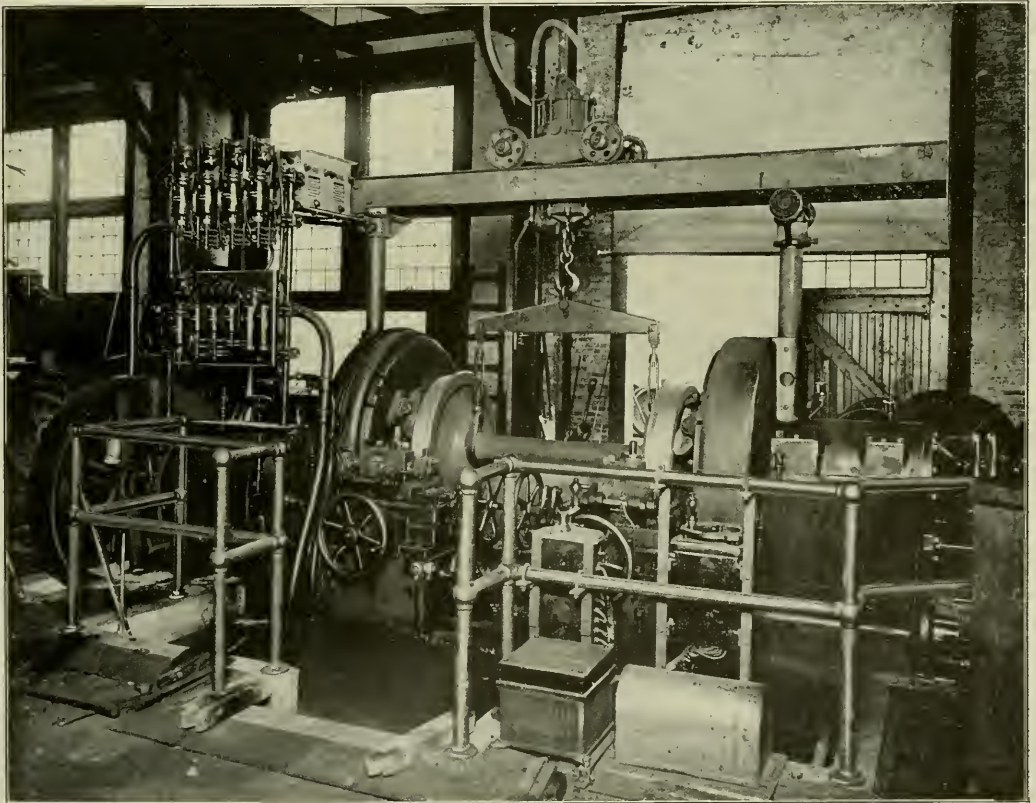

Fig. 10—42-Inch Motor Driven Car Wheel Lathe.

between the shaft of Group 21 and the shaft of Group 16, which will permit of locating a crane above a portion of the machine shop. The power required for each machine was carefully determined and a motor installed of sufficient power to drive each group. In some cases it was found that where a d. c. motor had been used an a. c. motor of much smaller capacity would answer the purpose on account of its rugged characteristics. Such an instance is shown in Fig. 11. The 15 h. p., a. c. motor in position on the wall is to replace the large 50 h. p., d. c. motor on the floor, and a chain drive is to replace the belt drive. It was also found that in some cases the motors could be directly applied to the machines more economically, and a few of the most interesting applications are shown in Figs. 7, 9 and 10. Fig. 10 shows a Sellers car wheel lathe driven by a 50 h. p., 220 volt d. c. motor with speed adjustment by field control from 500 to 1,000 r. p. m. Snap switches on the front and rear of the lathe en-

making these changes a distinct saving in the cost of operation of these shops would be made, production increased, a similar effect on the working floor space obtained, and that in general the shop operation would be much more reliable. Alternating current motors were also used to replace the engine in the blacksmith shop, and marked increases in output have been made by their installation.

The construction work, other than that applying to motors, was done by Westinghouse, Church, Kerr & Company, New York, and all of the new motors installed were made by the Westinghouse Electric & Manufacturing Company, Pittsburgh, Pa.

A LINK GRINDING MACHINE

BY V. T. KROPIDLOWSKI.

In constructing the link grinder shown in the illustration, two pieces of $\frac{1}{2}$ in. x 4 in. bar iron were used for the frame, but the writer believes that heavy 4 in. angles would make a more rigid construction. A crosshead *D* slides between the frame bars, and can be raised and lowered by a long rod *B*, which has a square thread. This rod fits into a block *I*, which is bolted between the bars of the frame. A handle *M* is provided to operate the screw. Through the crosshead a pin with a journal fit is provided, on the end of which a block *F* is fastened and kept from turning by a pin *H*; while through the block *F* is passed the rod *C*, which can be moved so as to suit the radius of any link, and is held in place by a set screw *G*. The lower end of the rod *C* has two jaws, from which are sus-

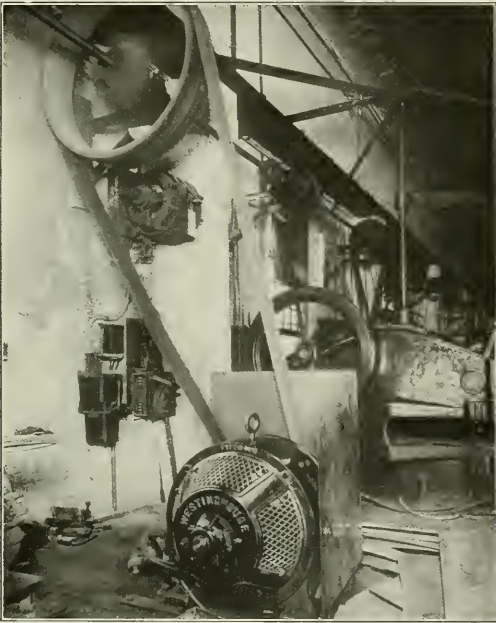
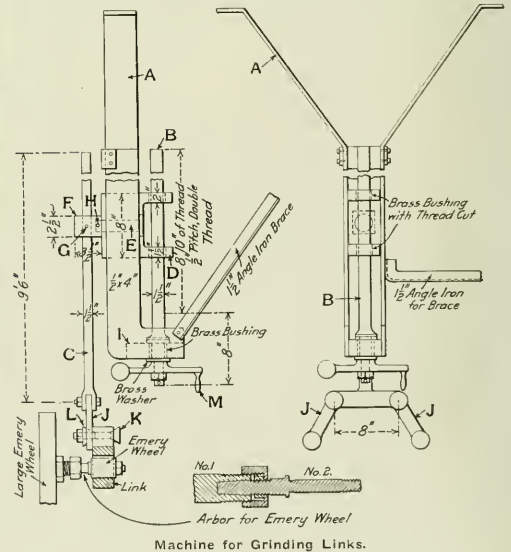

Fig. 11—A 50 h. p., 220-volt, d. c., Motor Replaced by a 15 h. p., 440-volt, a. c., Motor Placed on the Wall.

able the operator to start and stop the motor from either place. By means of a drum controller and suitable field resistance the desired speed is established. With one snap switch the motor is brought to this speed, while the other switch gives half speed for handling hard spots. Hence by combination of the controller and snap switches, the speed control is obtained without the intervention of gear changes.

Throughout the whole installation the accessibility of motor control for the operator was carefully considered. All of the auto-starters are equipped with overload relays instead of fuses and no-voltage releases, which afford protection to the motors, tools and operators. In case of the group drive, provisions are made at three different places in each group for stopping the motor in case of accident. Where it was possible to do so the motors for the group drives were suspended from the walls or rafters so as to give all the floor space possible and place the motors out of the way of possible injury. Alternating motors will require very little attention. It was believed that by



pendent two links *J*. These links have bolts *K*, which have taper heads, and which also are provided with a taper washer *L* and a nut, to suit any size holes in the different links. The arbor of the emery wheel that is used for grinding the links is attached to the arbor of a large emery wheel, which was already installed, this being done to obviate special shafting, pulleys, belts, etc. Referring to the illustration, No. 1 indicates the large arbor and No. 2 the small one. A medium grade of emery wheel is used and all the deep hollows are removed by this machine, the little polishing that is necessary afterwards being done by hand.

REPAIRING LOCOMOTIVE DRIVING BOXES

Brasses Cast in Place are Better Both
as to Service and Cost of Repairs

BY M. D. FRANEY,
Master Mechanic, Lake Shore & Michigan Southern, Elkhart, Ind.

The design of the driving box and its associated parts, the machinery available in the shop, its relative location, as well as the organization of the shop have an important bearing on the proper method of repairing driving boxes. In the following study of the subject the functions of the driving box and its associated parts will be considered first and will be followed by a discussion of the proper method of making repairs.

The ideal driving box is one having a general construction of ample strength to permit maximum wear and the restoring of

required the refitting of the main driving box brasses after 35,000 miles service. Increasing the length of the main bearing from 12 in. to 14 in. resulted in the same engines making 100,000 miles without refitting the boxes.

Fig. 1 shows the No. 1 and No. 3 box, and Fig. 2 the main axle driving box of a 22 in. x 28 in. Pacific type locomotive equipped with a superheater and carrying 200 lbs. steam pressure. The details of the method of holding and fastening the brass are shown in Fig. 3. It will be observed that this box is made to receive the brass in a molten state. Five dovetails are slotted in the crown of the box, and the hub face of the box is dovetailed to receive and hold the brass hub liner which is poured and cast on the box at the same time as the crown brass. The hub liner is a part of the brass, and with the two 1 in. projections in the two 1 in. holes, *A* and *B*, in the center dovetail it prevents the brass from working out, should it become loose in the box. The five projections on the crown brass are held closely to the sides of the dovetails in the box by shrinkage.

One great advantage of the poured brass over the pressed one is that a higher percentage of lead can be used without segregation. The sudden cooling in the steel box gives a very close grained uniform bearing metal. The poured brass with its high percentage of lead makes an ideal bearing and having the hub

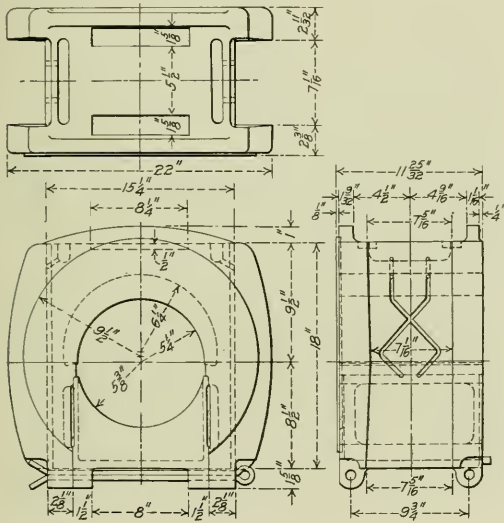

Fig. 1—Driving Box for the First and Third Axes of a Heavy Pacific Type Locomotive.

worn parts to their original dimensions. It should give the maximum service between general shoppings with a minimum amount of repairs. The following items affect the service and repairs; wear between the journal and the brass; the secure holding of the brass in the box; lateral wear between the driving box face and the driving wheel hub; securing and holding of the hub liners in the boxes and on the driving wheels; reducing to a minimum the wear between the shoe and wedge face and the driving box. The wedge bolts should have ample strength and a liberal bearing area between the bolt and the wedge. The flanges of the driving box for shoe and wedge fit should be tapered to prevent the raising of the brass from the journal, or the binding of the driving box and shoe and wedge during the rolling of the locomotive in service.

Experience proves that the wear on the main driving journal and brass is more rapid than on the front and back journals. This wear may be made to correspond to that of the other journals by increasing the length of the main driving journals by 18 or 20 per cent. This practice was tried on the Michigan Central at Jackson, Mich., in 1903 by D. R. MacBain, now superintendent of motive power of the Lake Shore & Michigan Southern. At that time Atlantic type locomotives on that road

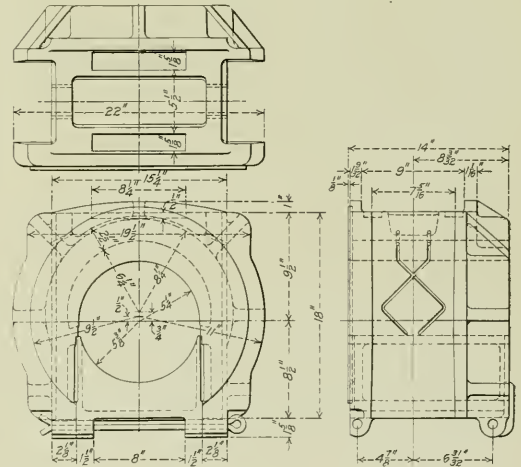

Fig. 2—Driving Box on the Main Axle of a Heavy Pacific Type Locomotive.

liner cast solid with it, in addition to the dovetail, makes an excellent method of fastening the hub liner as well as a cheap method of renewal to standard dimensions. There is a saving of labor in turning, shaping, pressing in, drilling and pinning the brass, and the pouring of the brass in the steel box costs less than pouring in a sand mold.

In applying new driving wheels there is no good reason why metal should be removed from the wheel hubs and similar metal patched on with bolts. The wheel hub should be left solid to

take the lateral thrust of the box. The writer has seen hubs without liners, except on the box, in service eight and ten years, which were in good condition.

Cast iron shoes and wedges and cast steel driving boxes do not make a satisfactory wearing combination and in the boxes illustrated two dovetails and two 1 in. holes are provided to hold the bronze liners, which are cast in place. This not only provides good bearing material, but also permits liberal fillets

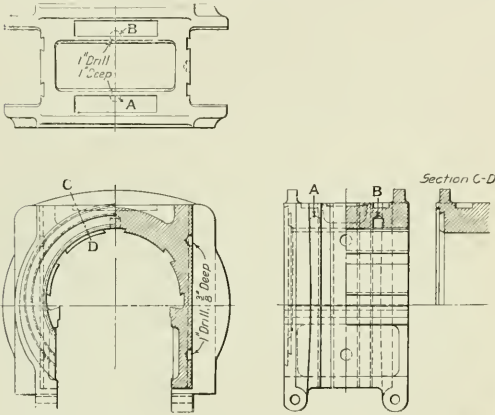

Fig. 3—Arrangement of Recesses for Holding the Crown Brass and Liners.

where the flanges join the steel driving box casting, which adds to the strength of the construction, and yet, when the liners are cast in place, allows the use of sharp corners on the shoes and wedges which gives a bearing on the full area of the shoe and wedge face. On the shoes used with these boxes there is an increased bearing area of $13\frac{1}{2}$ sq. in., as compared with a similar wedge having a fillet of $\frac{3}{8}$ -in. radius. This reduces the wear between the shoe and wedge and the driving box face and also

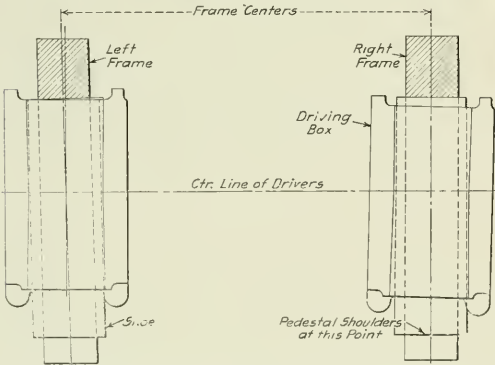

Fig. 4—Relation of the Driving Boxes and the Frames When the Driving Wheel Strikes a High Spot on the Track.

reduces the pounding. The brass face against cast iron permits a closer adjustment than with cast iron and steel.

Fig. 4 shows why the driving box flanges should be tapered to prevent the driving boxes tipping on the journals with the swinging and rolling of the locomotive. This clearance also prevents the binding of the driving boxes and the shoes and wedges with the resulting breakage of the flange on the box, the shoe and wedge flange, the wedge bolt, or all three.

SHOP PRACTICE.

The shop practice for finishing new driving boxes of this type in a shop repairing 650 engines per year has been well standardized and the results are very satisfactory. In the following description, the time given in each case is the average time required and includes dead time. It is based on piece work pieces and covers an extended period of time. All driving wheel and box repairs from the time the wheels are removed from the locomotive until they are again ready to place under it, are handled by the driving wheel and box department of the machine shop.

The new box as it is received from the foundry is clamped by bolts in the ordinary method on a 42-in. Bullard vertical turret lathe; both faces of the driving box are finished to the proper dimensions, and the hub face is dovetailed to receive the hub liner. This operation requires 90 minutes from floor to floor and costs 65 cents per box. The box is trucked from the boring mill to the slotter at a cost of 1 cent. The circle and dovetails are slotted to receive the poured crown brass. This requires two hours and costs 96 cents per box.

Experience in pouring driving box brasses has shown that the shrinking of the metal tends to draw the box in on the lower



Fig. 5—Face Plate and Burners for Heating the Box Preparatory to Pouring the Brass.

end and for this reason the new box is not milled for the shoe and wedge fit, or slotted for the cellars until after the brass is poured.

It requires eight minutes to take the box to the brass foundry and costs a little over 3 cents a box. The brass is melted in a Rockwell furnace and a special face plate with four special burners is provided for the pouring. This is shown in Fig. 5. Fuel oil is used in the burners and the boxes are heated to about 900 degrees before the brass is poured. A cast iron core with a pin projecting from the lower end is set in a receptacle just opposite each burner. This core has projections which core out the grease grooves and recesses to receive the sand cores for babbitt grooves; the brasses as poured are small enough in diameter to finish nicely to minimum size of journal for each class of engines. The hub liner in its molten state is retained in position on the box by wrought iron guards, about 1 in. high, providing ample stock for facing it to the required thickness and insuring the removal of all dross and waste material. Slots are provided in the edges of the iron cores and two wedges are used in each slot, one of the wedges is inverted and by driving the other it is easy to center the box on the core. These wedges form the mold for the lower edges of the brass.

In beginning the operation, the box is set on the face plate resting on its back face at the proper distance from the cast iron core. When properly located in respect to the core it is secured and the cast iron core is removed. The burner is lighted and the box is heated to its proper temperature. The guard for the hub liner is then placed on the box and the core is returned to place and the wedges driven down and all open places are closed with asbestos cement. The molten brass is then poured in the ladle and allowed to cool to a dull red heat before pouring in the box. Fig. 6 shows the operation of pouring.

Setting up the box on the face plate, heating, applying the



Fig. 6—Pouring Driving Box Crown Brass and Hub Liner.

guards and liners and pouring the shell and hub liners requires 30 minutes and costs 16 cents a box for labor.

The box is now returned to the milling machine and is securely clamped to a heavy angle iron. One end of the box is offset so that in milling the first shoe and wedge face the milling cutters also cut half the taper on the flanges. After the milling cutter has passed through, the boxes are reset by adjusting the wedge on the opposite edge of the box which completes the operation of milling the shoe and wedge face and tapering both ends of the flanges on one side of the box. The box is then turned over and the same operation is performed on the other side. This requires 2½ hours and a labor cost per box of one dollar, with 25 cents added for setting up on the machine, which usually applies for several boxes. This operation could be somewhat reduced if a heavier milling machine was used.

The box is trucked to the planer, which is in the same department, and the two dovetails are planed on each shoe and wedge face to receive the brass liners. This takes on an average of 45 minutes per box and costs 37 cents. It is then trucked to the brass foundry for pouring the shoe and wedge liner.

For pouring these liners, cast iron formers which fill the space between the flanges of the driving box and for the full length of the shoe and wedge face are provided. Four taper pins on the face of the liner hold it a proper distance from the box. Two formers are used for each box and are held in place by clamps. The labor for applying formers and pouring the side liners costs 6 cents a box.

The box is taken to the planer at a cost of a little over 3 cents

and the brass gibs are planed to the proper thickness to give the required width on the shoe and wedge face. This is handled on an ordinary 36-in. planer and the time required for setting up, finishing both sides and removing to the floor is 38 minutes and costs 30 cents for labor. The box is next delivered to the slotter and is slotted for the cellars which consumes 50 minutes and costs 38 cents.

Cleaning the sand out of the oil pocket and out of the babbitt slots takes 14 minutes per box, costing 7 cents. It is then trucked to the babbitt fire, babbitted and returned, requiring 12 minutes at a labor cost of a little over 8 cents.

The box is bored for the journal fit on an old Putnam wheel boring machine, which has been fitted up for this work. It is shown in Fig. 7 with a finished box in position. A heavy extension is provided on the end of the boring bar which extends into a sleeve in the table, so designed that the chips cannot cut the bar. An adjustable tool holder is provided in the bar and a double end tool is used. One end of the tool is for roughing and the other for finishing. A horizontal head is used for facing the hub liners. A ½-in. feed and a ¼-in. cut is used for rough boring and a 3/32-in. feed and a ¼-in. cut for facing, both operations being performed at the same time. A canvas curtain encloses the machine while boring and facing. The box is clamped with four heavy clamps and key-bolts.

The box is bored central with the shoe and wedge faces by using a special adjustable gage, Fig. 8, measuring from the shoe

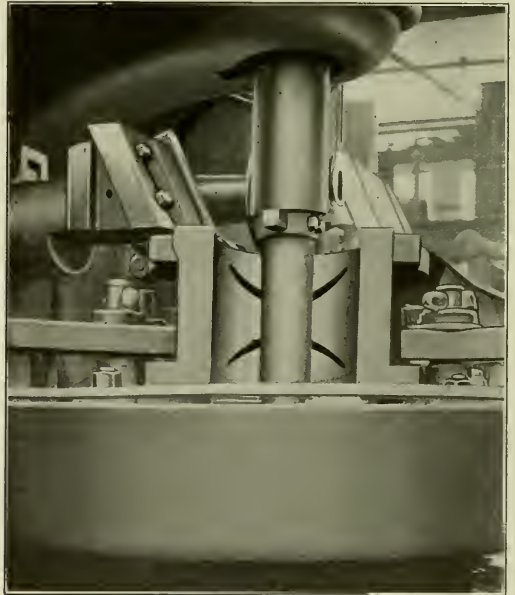

Fig. 7—Boring the Brass and Facing the Hub Liner.

and wedge face to the extension on the boring bar. This is also used for measuring from the steel box to the bar for the proper thickness of the crown brass. The operator is required to caliper the journal and is responsible for the proper fitting of the brass on the journal. Front, back and intermediate brasses are bored 1/32 in. larger than the journal and the main brass is bored to fit the journal. This is for engines equipped with grease lubricators. Setting up the box in the boring mill, calipering the journal, boring the brass and facing the hub liners to proper thickness takes but 25 minutes from floor to floor. The total cost of these operations is 25 cents.

The box is next delivered to the drill press in the same department and is drilled for the cellar bolts and oil holes. This takes one hour at a cost of 28 cents.

Planing the cellars to fit the box takes 25 minutes, fitting the removable grease doors to cellars five minutes, and drilling the holes in the cellars and grease doors 15 minutes. The cost for the three operations is 28 cents.

The box is delivered to the fitter who fits it to the journal, cleans the sand out of the grease groove with an air hammer and special chisel, removes the burrs and squares up the spring saddle. This takes one hour.

Placing the box on the journal, packing the grease in the cellar, fitting up a new grease plate and spring plate, fitting the cellar in the box and putting in the cellar bolts complete requires another hour.

This completes the operations on a new box ready for applying

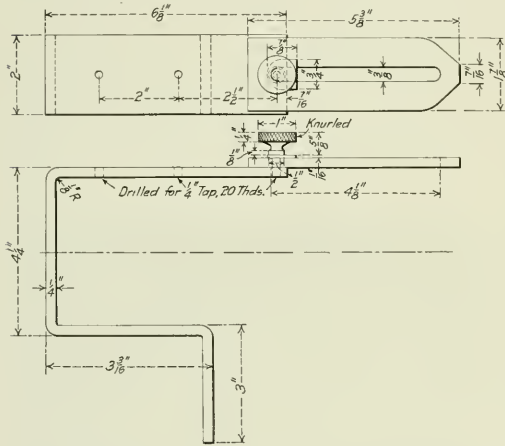

Fig. 8—Gage for Centering the Box on the Boring Mill.

the wheels under the engine. The total time as shown by the recapitulation is 14 hours and 41 minutes.

SUMMARY—NEW DRIVING BOXES.

	Time, Minutes.	Cost for Labor, Cents.
Clamping on the boring mill, finishing both faces, dovetailing for the hub liner	90	65
Trucking to the slotter	1	1
Slotting the circle and dovetail for the brass	120	96
Trucking to the brass foundry	8	3.2
Setting on the face plate, applying the formers, heating the box, pouring the brass and hub liner	30	16
Trucking to the milling machine	8	3.2
Setting up on the milling machine, milling the shoe and wedge face, including the tapering of flanges	150	100
For setting up the milling machine for the above operation	35	25
Setting on the planer, planing two dovetails in each face for shoe and wedge liner	45	37
Trucking to the brass foundry for pouring shoe and wedge liner	8	3.2
Applying the formers, heating the box, pouring the side liners	15	6
Trucking from the brass foundry to the planer	8	3.2
Planing brass gibs on shoe and wedge face	38	30
Slotting for the cellar	50	38
Cleaning the sand out of the oil pockets and babbit slot	14	7
Trucking to the babbit fire, babbiting and returning to the boring mill	12	8.3
Setting in the boring mill, caliper size of the journal, boring the brass, and facing the hub liner to proper thickness	25	25
Drilling the cellar bolt holes and oil holes for the shoe and wedge face	60	28
Planing the cellar to fit	25	20
Fitting removable grease doors to the cellars, leaving the box ready to go on the journal	5	2
Drilling the holes in the cellars and grease doors	15	6
Removing all burrs and sharp edges from the brass and hub liners, cleaning the sand out of the grease grooves in the brass, squaring up the spring saddle, and chipping the oil grooves in the shoe and wedge face, leaving the box ready to go on the journal	60	47
Filling the grease groove, placing on the journal, applying the spring grease plates and followers complete in the grease lubricator, filling the grease lubricator, placing the cellar in the box, and putting in the cellar bolts	60	35
Total	14 hrs. 41 min.	\$6.05

In handling an old box for repairs, the box is first removed from the axle and after the grease is taken from the cellars and placed in receptacles provided for the purpose, the box and cellar are placed in a basket for the cleaning vat. This work, including taking the box and cellar to the lye vat and cleaning and then returning them to the driving box department, requires twenty-eight minutes and costs about 13 cents.

Inspecting the driving box and pressing out the shell consumes sixteen minutes at a cost of about 6 cents. Where it is necessary to chip out the hub liners the time will be thirty minutes.

In removing the brass side liners for the shoe and wedge it is more satisfactory to plane them out and the cost of doing this by splitting them in two in the center with square nosed tool and removing the parts is also about 13 cents.

Trucking the box to the brass foundry for pouring a new brass and liners takes 8 minutes and costs a little over 3 cents. Setting up the box on the face plate, heating it, pouring the brass including the hub liner, applying formers for the side liners and pouring the side liners takes 45 minutes at a cost of 22 cents.

With repaired boxes all of the brass foundry work, including pouring of the hub and side liners, is performed at one time.

The box is then trucked to the planer and the side liners are planed to the original dimensions. This takes 38 minutes and costs 30 cents a box. Where the old shoe and wedge liners can be used and it is only necessary to plane them each box is planed to width separately. This is good practice as it preserves a maximum thickness of liners on the box. On the erecting floor the width of each box is laid out on its own pedestal from its respective center.

After the sand is chipped out of the oil pockets and babbit slots in the shell the box is trucked to the babbit fire, babbitted and returned to the boring mill. It is bored in the same way as a new box.

The box then goes to the fitter, the sand is cleaned out of grease grooves and the brass is fitted to the journal and the spring saddle bearings are squared up. It is now ready to be applied to the journal, after which the foreman inspects it for fit; the grease with lubricator is applied and the cellar is bolted in place and the box is ready for service.

SUMMARY—OLD DRIVING BOXES.

	Time, Minutes.	Cost for Labor, Cents.
Removing the box from the axle	8	3.2
Removing the grease from the cellars and placing the box in the basket for cleaning	5	2
Taking the box and cellar to the lye vat and cleaning	9	4
Trucking to the driving box department	6	2
Inspecting the box and pressing out the brass	16	6.3
Chipping out the hub liners	30	13
Planing the side liners and removing	18	13
Trucking to the brass foundry for pouring the liners and brass	8	3.2
Setting the box on the face plate, heating, pouring brass, hub liner and side liners	45	22
Trucking to the planer	8	3.2
Planing the side liners	38	30
Chipping sand out of the oil pockets and babbit slot in the brass	14	7
Trucking to the babbit fire, babbiting the brass and returning to the boring mill	12	7
Setting on the boring mill, calipering journal, boring the brass, facing the hub liners	25	25
Removing all burrs from the brass and hub liners, cleaning the sand out of the grease groove, chipping the grooves in shoe and wedge face. Box ready to go on the journal	60	47
Filling the grease grooves, applying on the journal, fitting up the lubricator complete, applying the cellar, putting in the cellar bolts. Box ready for service	25	13
Total	5 hrs. 27 min.	\$2.00

As stated in the beginning the detailed handling of driving box repairs will necessarily be varied to suit shop conditions, type of machinery, its relative location and the design of box used. It should be understood, however, that a few extra cents saved in the cost of repairing driving boxes may result in dollars spent in the roundhouse before the engine comes back for general repairs. The principal item to be considered first and always is the design of the driving box and the method of repairing, which will enable the engine to go from one general shopping to another with the last amount of repairs.

CAR DEPARTMENT

CAR DEPARTMENT NOTES

BY KEYSER.

Is there a railroad anywhere on which a car foreman can have the repair tracks switched at the time they need it? My experience has been something like this: The car foreman orders one of the repairmen to "Go up and tell the yardmaster we want a switch here in half an hour." The repairman returns in 45 minutes and says that after tramping all over the yard he finally found the yardmaster, who informed him that "he couldn't switch the rip tracks before dinner." There being, by this time, from two to twenty repairmen idle, the foreman proceeds to find what he can to keep them busy temporarily and sets out himself in search of the yardmaster. When he succeeds in running him down they spend another ten minutes in loud-voiced discussion that accomplishes nothing; the foreman returns to the repair track and cools his wrath by telling what should, in his opinion, be done to the yardmaster and the rest of the transportation officials, while the yard crew go about their regular work and switch the repair tracks when they get around to them.

I do not pretend to offer a solution of this problem. I have seen a number of trials made to solve it—designating certain times for the switching, etc.—but I have never yet known one of them to work out satisfactorily. Conditions vary so much at the terminals that a different treatment may be needed for each one, or at least each class of terminal; but I believe that the way to go about solving it is to have the matter thoroughly threshed out in a conference between the superintendent, the master mechanic or division master car builder, the yardmaster and the car foreman. Certainly something should be done to avoid the delays and consequent waste of keeping car repairmen waiting for switch engines.

* * * * *

When a man is made car inspector he sometimes gets the idea that all he has to do is to go around tapping wheels with a hammer and looking wise. There are plenty of railroads on which cars are set out and delayed on the repair tracks for trivial repairs, while a car inspector sits and gossips in the yard office. This may be largely overcome by erecting a small shanty for the inspector, within a reasonable distance of his work, and placing in it a small supply of brasses, nails, bolts, etc. The inspector can then, in many cases, very easily make such light repairs as are necessary without marking out the car and necessitating its removal to the repair track. There are great possibilities in this for the saving of money for the company and in preventing delays.

* * * * *

I talked to the foreman of a coach cleaning yard recently when a number of men were at work nearby washing down cars. I noticed two other workmen bring out a number of cushions and aisle carpets and one started blowing the dust out of the carpets with a compressed air cleaner, while the other commenced pounding the cushions. I expected to hear the foreman at once order these two elsewhere, but not a word was said. The dust blew against the wet cars and, of course, stuck there, and the train went out with several cars looking much worse than when they arrived, for the reason that they were uniformly dirty coming in and were spotted irregularly going out. Possibly the moral is "use vacuum cleaners," but until the appropriation goes through, a little thought on the part of the foreman would help materially to brighten the exterior of the passenger equipment.

When work trains are being operated, the aprons which carry the unloading plow from car to car are frequently a bane to the carman's existence, one of the prolific causes of trouble being the leaving down of the end apron by trainmen and conveniently forgetting it. The sequel is the backing in of another locomotive or train and the consequent crumbling up of the apron. It is useless to report these happenings. The superintendent may post bulletins and admonish from morning to night and trainmen will still "forget" the aprons. The easiest way is to assign a man several times a day to go over all the trains which may be awaiting load, or standing idle for any other reason, and have the end apron turned back; then it will not matter whether or not the trainmen forget.

* * * * *

It is just as easy to load car wheels properly as improperly, but it is surprising how many carmen, and even foremen, will, in unloading wheels, place them so that the flanges of one pair rest against the journals of the next. The result to the journals may be readily imagined.

* * * * *

The "safety first" campaign has resulted in great improvements as regards material left lying along the tracks in such a manner as to possibly cause death or injury to trainmen; but how common it is to see drawbars, draft sills, etc., left lying right where they fell when removed from a car on the repair tracks, the men in the meantime walking, or rather stumbling over them while about their work. In most cases a few steps and a few seconds more would place the old material out of the way, so that the men could work and move about with comfort and convenience.

While talking of safety, did it ever occur to you how easily a protruding nail or broken board on a roof or the floor of a flat car, could throw a trainman from the car? These are among the little things that, if let go, may cause serious injury or loss of life. I know of repair yards where one or more men are kept busy all the time looking for and remedying small defects of this nature. Aside from the safety feature, a loose nail may very soon mean a leaky roof.

* * * * *

I was much surprised recently to see a number of men engaged in shoveling back and boarding up the grain in a box car in order to get at the draft timber bolts, which were broken. There is a device, which I was under the impression was in general use, by which this work can be much simplified. It consists of a bottomless box or cylinder, about four feet in diameter or square, as the case may be, made of $\frac{1}{2}$ in. or $\frac{3}{16}$ in. iron; it is sunk to the floor of the car and the grain shoveled out. It may be made in a boiler shop in a few hours.

* * * * *

Many car foremen, unless the general storekeeper is watchful and checks their requisitions closely, follow the practice of ordering more material each month than they need, regardless of what is due on previous requisitions. They follow the old rule of ordering double what is needed because the stores department will reduce the amount by half, anyway. I believe that it requires no more clerical work and gives more satisfactory results to keep close track of what material is on order, and instead of ordering another supply each month, keep after the storekeeper until the old requisitions are filled. In many instances, if a foreman were to suddenly have all his outstanding requisitions filled he would not be able either to store or use the material.

REMOVING FLAT SPOTS FROM CAR WHEELS

BY CHARLES A. CURTIS, Jr.

Flat wheels are hard on the road bed and rolling stock, and are frequently the cause of much ill-natured comment on the management, particularly in the case of passenger equipment. The traveling public is looking for the best service, and smooth running wheels play a big part in it. The device described in

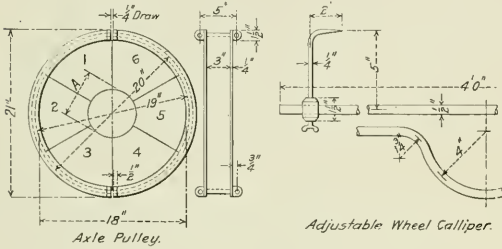

Details Used with Machine for Grinding Car Wheels.

this article will remove flat spots quickly and cheaply, without the necessity of removing the wheels from the car.

The machine may be set up and operated by one man. It is first necessary to jack up the end of the truck on which the flat wheel is located, so that the axle is free to turn in its bearings; then block the wheels which are not to be ground, so as to eliminate as much vibration as possible. The axle pulley is

clamps shown; a clamp must be placed at each corner of the frame. The wheel turning mechanism is next placed on the frame so that the driving pulley will be in proper alinement with the axle pulley, and is clamped in position by four hook bolts. No holes are provided in the frame for the hook bolts, as there is no certainty as to the location of the machine, due to different types of brake rigging, etc. The necessary holes are bored after the machine is set up, and the axle and the driving pulleys are then connected by a belt 3 in. wide. Power for turning the wheels is supplied by a 1/2 h. p. electric motor connected to shaft B by means of a flexible connection. The grinder is next placed on the rail with the part marked "front" at the wheels, and the part marked "outside" at the outside of the truck. It will be noticed that this machine has a longitudinal feed of 3 in. and a transverse feed of 6 in. After it is placed within the limits of its longitudinal feed it is secured to the rail by the set screws in the rail jaws. The grinder is driven by a 1/4 h. p. electric motor, which is flexibly connected to shaft A. This motor must have a separate frame and may be located to suit the operator.

The grinder should run at about 1,500 r. p. m. The operator has perfect control of the work by means of the two feeds. Care should be taken to grind both wheels to the same diameter, so as to preserve the good running qualities of the car. A wheel calliper is also illustrated, with which the size of the wheels may be taken accurately.

LONG DISTANCE WIRELESS.—A message by wireless telegraph sent from Key West, Fla., recently was heard at Cairo, Egypt, about 7,000 miles away.

FIRES ON THE PENNSYLVANIA.—The Pennsylvania reports the smallest fire loss in thirty-four years. In 1908 the company's

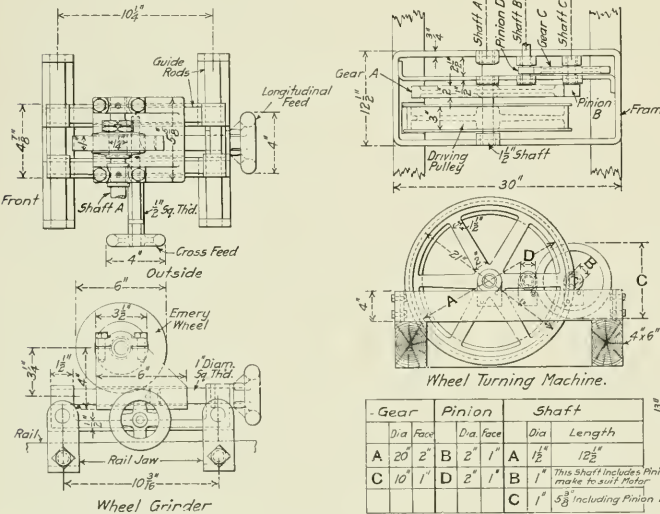

Apparatus for Grinding Car Wheels.

then placed on the axle. This pulley has a cast iron band filled with wooden segments, 1, 2, 3, etc.; a set of segments is required for each size of axle. Each set must fit the cast iron band, which is made in two pieces and bolted together.

The wheel turning machine is next set up. The frame of this machine is placed on the rails at a convenient distance from the axle pulley and is secured to the ball of the rail by the

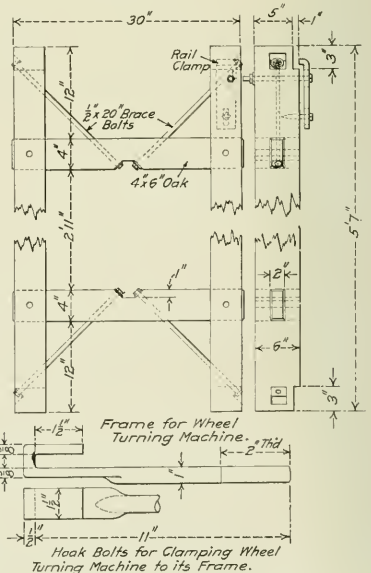

employees extinguished 274 fires out of a total of 1,397 which occurred on railroad property, and in 1912, 454 out of a total of 905. The steady increase in the efficiency of the fire fighting brigade was further developed last year by special training of employees and equipping additional locomotives in yard service with pumps. Including the fires to which city fire departments were called, the total loss was only \$219,892 from the 905 fires.

GROWING COST OF FREIGHT CAR REPAIRS*

Some of the Principal Causes; Also Suggestions for Changes in Design, and Methods to Reduce it

BY F. F. GAINES,
Superintendent of Motive Power, Central of Georgia.

With the motive power of six to ten years ago, together with the size and the method of handling trains of that period, a wooden underframe of eight sills was considered a substantial design for freight cars; but the introduction of hump yards and the Mikado and Mallet type locomotives has revolutionized operating conditions, and where action has not been taken to bring the cars up to the required standard, it has resulted in an abnormal amount of repairs, particularly to the draft gear, center sills and end sills. Many railway officers have realized this situation and have provided at least steel underframes and high capacity friction gears on all new equipment. Some have been content with the steel underframe and a weak draft gear, while others have taken steps to reinforce the older wooden equipment with metal draft sills and friction gears, as well as to use the high capacity friction gears with steel underframes on all new equipment.

About two years ago a special analysis of repair bills was made on the Central of Georgia to see which were the principal items of expense so that measures could be taken to improve them. The analysis covered a period of six months, and in addition to itemizing repairs, the percentage of each item was shown for each railroad making repair bills against that company. The following table gives the average cost of the principal items in per cent. of the total bills:

Air hose	3.08 per cent.
Brake shoes	4.11 per cent.
Brasses	9.85 per cent.
Cleaning cylinders and triples.....	1.19 per cent.
Miscellaneous air brake repairs.....	5.13 per cent.
Wheels	9.70 per cent.
Axles39 per cent.
Oil boxes94 per cent.
Longitudinal sills	1.29 per cent.
Knuckle pins, locks, etc.....	4.53 per cent.
Couplers	3.81 per cent.
Follower plates72 per cent.
Casements53 per cent.
Springs, draft	1.34 per cent.
Yokes30 per cent.
Yoke rivets and pocket bolts.....	3.56 per cent.
Draft timbers	1.76 per cent.
Draft bolts	28.37 per cent.
Carrier bolts	1.04 per cent.
Defect cards	6.27 per cent.
Miscellaneous	12.09 per cent.
Total	100.00 per cent.

Assembling all items connected with coupler and draft gear we have:

Follower plates72 per cent.
Casements53 per cent.
Springs	1.34 per cent.
Yokes30 per cent.
Yoke rivets and pocket bolts.....	3.56 per cent.
Draft timbers	1.76 per cent.
Draft bolts	28.37 per cent.
Carrier bolts	1.04 per cent.
Longitudinal sills	1.29 per cent.
Total	38.91 per cent.

This conclusively demonstrated the weakest spot and the one needing immediate attention. In rebuilding some wooden coal cars metal draft arms engaging the steel body bolster, and extending well back of the body bolster so as to reinforce the center sills at this point, were applied in connection with a substantial friction draft gear. These cars have been in service about three years without any cost for repairs of couplers or draft gears. One of them was in a collision on a foreign road and when returned had the eight longitudinal sills and the side planks broken, but there was no damage whatever between the center of the car and the ends, including the draft gear.

*Awarded first prize in the Car Department competition, that closed February 15, 1913.

The experience with this lot of cars, in connection with the analysis of the cost of repairs, resulted in a policy of improvement of all wooden underframe cars with an expected life of ten years or over. All such cars when requiring new center sills are equipped with the metal draft arms and a friction draft gear. In many cases where the center sills are only split by draft bolts the old sills are retained and metal draft arms are applied without the removal of the sills.

In designing new equipment the mechanical department of a railroad is in a much better position to do the work than the car builders. The latter are not familiar with operating conditions and approach the proposition from the standpoint of first cost, ease of construction, and with little or no concept of maintenance and repairs in case of accident.

The function of any car is to transport its lading under normal conditions without damage to either the car or the lading, and with a minimum of weight per ton of lading. Box cars must be water and burglar proof. The design must also be economical as to maintenance. Normal conditions of today mean long, heavy trains handled by powerful Mikado and Mallet type locomotives, hump yards, and congested terminals where the equipment must stand collisions at speeds of ten to fifteen miles an hour without damage to the car, at least. That these conditions require a steel underframe has been so thoroughly demonstrated as to require no further proof. In the earlier types of steel underframe, in order to keep the light weight of the car in line with contemporary wooden construction, there was entirely too little material used. Its thickness was such that a few years' exposure to the elements caused serious corrosion and a further weakening of an insufficient design. The material was not distributed to the best advantage to resist the shocks incident to the service. Pressed shapes were largely used, which involved serious delays when heavy repairs due to accidents required new parts.

Today we know that we must put enough material in the underframe to take care of the service, and disregard the light weight of the car. Structural steel is in every way preferable to pressed shapes, even if the first cost is slightly greater. The thickness of members constituting the underframe should never be less than $\frac{3}{4}$ -inch, and preferably $\frac{5}{16}$ -inch or over, to allow for corrosion. The center construction should be amply sufficient to transmit all shocks, jerks, etc. Whether in addition it should constitute the main carrying member or depend on the side framing for its portion is an open question, but in either event the fish belly type of center sill seems preferable. Eye-beams and channels, especially when not properly tied, do not fulfill the conditions required of them. There are in existence several thousand steel coal cars with channel center sills extending continuously from end sill to end sill, which even under service conditions frequently buckle back of the body bolsters, necessitating the cutting apart of the entire car to get them out for straightening or splicing. To eliminate such expensive repairs, underframes should be sufficiently strong between the body bolsters to withstand anything short of a heavy collision. The draft sills should be spliced ahead of the body bolsters so that in case of minor damage, repairs may be effected without dismantling the car. A heavy capacity friction draft gear is necessary to absorb as great an amount as possible of the blows delivered to it, and to transmit a minimum to the underframe.

On box and other house cars there should be at the end of

the frame a vertical member to which the end framing is attached, so that a shifting load will produce a shearing strain instead of tension at the bottom. Transoms, body bolsters and other members at right angles to the longitudinal axis of the car, should be flush with the side framing at the bottom. A slight side swipe that should do little more than scrape the side of the car, not even causing a derailment, will seriously damage transoms and body bolsters where they extend below the side framing, making an expensive repair job that could be eliminated by keeping them flush with the side framing.

A striking block of cast steel, integral with the underframe, to transmit the shocks to the center sills when the draft gear is solid, is another desirable feature. Various forms of carrier irons, which are easily removed when necessary to change couplers, as well as centering devices for couplers, are easily incorporated with this striking block. This arrangement prevents the driving in or pulling out of light end sills under service blows or jerks.

Trucks of substantial design are of varying detail. The tendency is to substitute steel castings for all or part of the truck side frame. Such castings, of proper design, which are well annealed allow of a better distribution of metal and the elimination of bolts and nuts that work loose and cause failure. Any one of several well known designs is entirely satisfactory from a maintenance standpoint. Cast iron wheels, well made, under lighter capacity cars have rendered a good account of themselves. For the heavier cars many wheel companies, at a slight increase in cost, are making special wheels that are equally efficient, and until we go beyond cars of 100,000 lbs. capacity, are economical and safe.

Hand brakes are frequently slighted in car design. The leverage should be such as to provide a good braking power without the use of clubs. A large percentage of damage to equipment and lading in terminal switching is caused by inefficient hand brakes.

Taking the three most generally used classes of equipment - box, flat and coal cars—there are some details of each about which there is a difference of opinion. A majority of the items for each, however, are pretty generally agreed on.

In box car design there is a question whether the superstructure should be composite or not. The composite type is expensive to repair in case of accident, generally requiring the dismantling of the entire superstructure. On the other hand, such a construction is probably cheaper to maintain against normal wear and tear. The end framing, at least, should contain a steel end plate securely fastened to the side plates, with steel corner posts, end posts and braces. The latter, in turn, should be secured to the steel end plate and the vertical flange of the underframe. At the belt rail a pressed steel fish belly girder extending across the end of the car and well anchored, in connection with the steel posts and braces, provides an end construction that will withstand almost any blow given by a shifting load. The same results are being accomplished by using an entire steel end with ribbing in concentric circles or horizontally to reinforce it.

The roof is the next item of importance, and is very frequently neglected. As a foundation, metal carlines should be used. Where the ends of the carlines are divided so as to form diagonal braces, they keep the superstructure from weaving. Metal carlines give a stronger body construction and more head room. There is a difference of opinion as to whether it is better to use an all-steel roof, an outside metal roof with wood underneath, or an inside metal roof with wood outside. The outside metal roof with wood underneath seems to have several advantages. The metal protects the wood from the weather and the wood acts as an insulation in hot climates. The inside metal roof with wood outside requires constant repairs to the wooden sheathing on account of the exposure.

Doors and fixtures are generally not of sufficient strength. Instead of the usual wooden door stop to which a staple is

secured for sealing, it is much better to use a malleable casting for that part of the stop that carries the staple, with short strips of wood above and below it. The sealing apparatus can be made integral with the stop and is burglar proof. The hasp on the door, instead of being secured by a clip with one or two bolts, should be locked into a wrought strap extending at least half the width of the door. This arrangement not only makes the hasp burglar proof, but prevents tearing off the front section of the door, as the stress from the hasp is distributed the length of the wrought strap, or half the width of the door. The hangers should be of substantial design and well bolted to the door. The door track should be of ample cross section to support the door without deflecting, and should be well secured to the side plate. The chafing iron at the bottom of the door should be not less than 2 inches wide, bolted, not screwed, to the door, with substantial malleable castings at each end to protect it and act as guides. There should be a sufficient number of bottom guides so that, whether open or shut, the door will engage two of them, and preferably three, when shut. Probably a better lock and one which is more of a protection to the door, is one applied to the rear of the door. When flush doors are used, a type without a bottom track should be selected, as the bottom track is frequently bent by drays backing up to load or unload, and when the track is bent the door is either inoperative or hard to move.

In flat car design about the only open question is the kind of material for the floor. Metal floors for many loads are not desirable, and as long as oak can be obtained at reasonable prices it makes the most desirable arrangement. Yellow pine does not stand exposure to the weather and requires frequent renewal. Hand brakes with demountable or telescoping shafts are desirable on account of overhanging loads, which cause frequent damage to the ordinary type of brake shaft.

Coal cars, as a rule, should be all-steel. The composite car of the hopper type has proved expensive to maintain, and the all-steel gondola is less expensive to maintain than the one with wooden sides and floor.

While it is true that altered operating conditions have made the general design of the car of six or more years ago an expensive car to maintain in its original condition, it is possible to remove the largest single item of upkeep by using friction draft gears, and, when of wooden underframe, by the addition of metal draft arms. On the other hand, there are in service many cars designed in substantial accord with the foregoing suggestions and only requiring renewals of wearing parts, with a minimum expense for repairs in case of accident. With the gradual retirement of the older equipment there should eventually come a decrease in maintenance costs.

In conclusion, it seems only fair to claim that the mechanical officials have been somewhat unjustly maligned in some quarters, and that they are in close touch with the situation and are taking the necessary action to remedy it.

FOREST FIRES.—The Department of Agriculture reports that the losses by fire in the national forests during the year 1912 were lower than for many years. The total is estimated at \$75,250. The aggregate number of acres burned over was 230,000 as compared with 780,000 acres in 1911.

RAILWAY IMPROVEMENTS IN THE NETHERLANDS.—A new railway line is soon to be constructed from Hoogeveen, in the province of Drenthe, to Ommen, in the province of Overysel. The distance is only 15 miles, but the new line will traverse a territory without railway facilities at present. This section is a great peat district. The railroad yards at Hoogeveen will be enlarged to meet the wants of the new line. Another important improvement in that region, soon to begin, is the double-tracking of the line between Hoogeveen and Groningen via Meppel, about 55 miles, coupled with enlargement of railway yards at several towns along the line.

FIFTY-TON LOW SIDE GONDOLA

Substantial Steel Underframe, Forty Foot Car, with Drop Ends, for the Jersey Central

The design of the latest steel underframe, low side gondola cars, one thousand of which have recently been put in service on the Central Railroad of New Jersey, is based on a long experience with a large number of the same type. It probably represents the most approved practice for this particular class of equipment for the conditions existing on this railway. These

is a $\frac{3}{8}$ in. top cover plate, $20\frac{3}{4}$ in. wide, running continuously for the full length of the car. The side sills are also fish belly type girders with a $\frac{3}{8}$ in. web plate and angles on the inside at the top and bottom. These sills are 24 in. deep for a distance of 11 ft. 2 in. at the center. The web plates of the center sills terminate at a point just beyond their connection to the

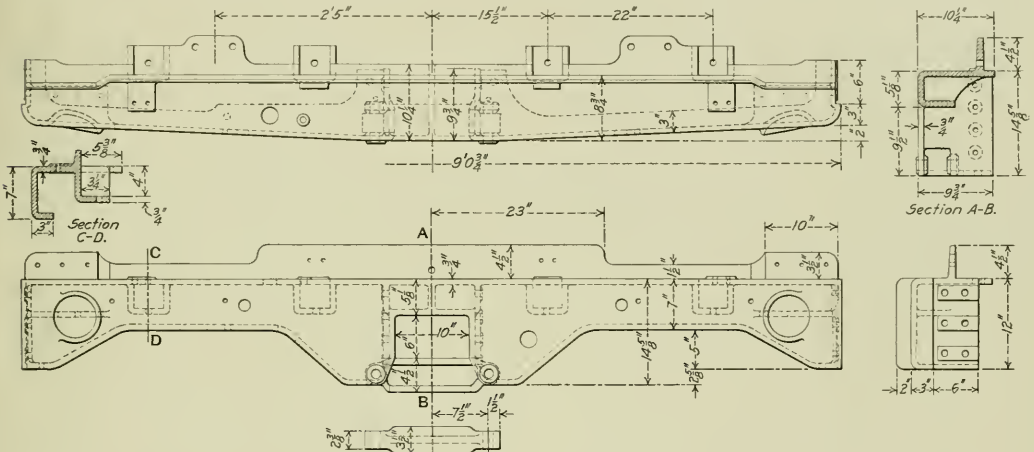

Cast Steel End Sills for Jersey Central Gondola.

cars are 42 ft. in length over the end sills and 40 ft. long inside of the body. They are arranged with drop end doors and safety chains for the handling of long material, and are designed to carry a concentrated load of 110,000 lbs. at the center of the car. The centers of the trucks are 31 ft. 4 in. apart. The floor is of $2\frac{3}{8}$ in. long leaf southern pine, and the sides are the same material, $\frac{3}{4}$ in. thick. The end doors are of 3 in. oak backed

body bolster, but the top angles extend continuously to the end sills. The inside bottom angles of the center sills stop $6\frac{1}{4}$ in. behind the bolster and the outer angle at the bottom extends 20 in. beyond the bolster. The separate draft sills are formed from $\frac{3}{8}$ in. plate pressed in channel shape and are spliced to the center sill web. There are inside and outside splice plates at this joint. The top angles of the center sills are also secured to the

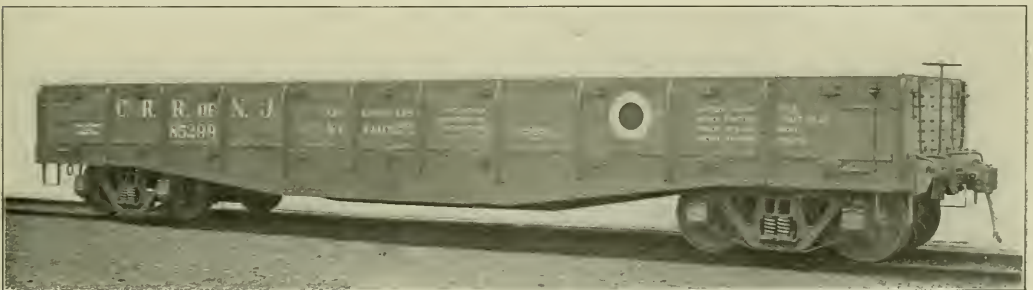

Steel Underframe Gondola Designed to Carry 110,000 Lbs. Concentrated at the Center of the Car.

with $\frac{3}{16}$ in. steel plates. In all other particulars except the floor stringers, the car is steel throughout.

The underframe consists of a pair of fish belly center sills, each sill having a $\frac{3}{8}$ in. web plate with an outside angle at the top and both outer and inner angles at the bottom. These sills have a depth of 30 in. over the angles for a distance of 11 ft. 2 in. at the center, and are $13\frac{1}{2}$ in. deep at the bolster. There

draft sills and the outer bottom angle is carried over the joint. The draft sills and side sills are secured to a cast steel end sill of the form and arrangement shown in the illustration. These sills were furnished by the Commonwealth Steel Company and are in one piece.

The body bolsters are of the built-up design having double, pressed steel, channel shaped plates set back to back, a $\frac{3}{8}$ in.

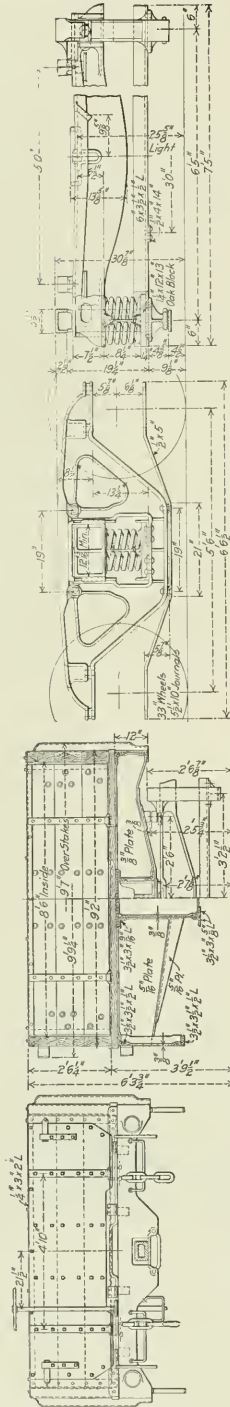

End Elevation and Sections of Jersey Central Gondola.

Trucks with Improved Andrews Cast Steel Side Frames.

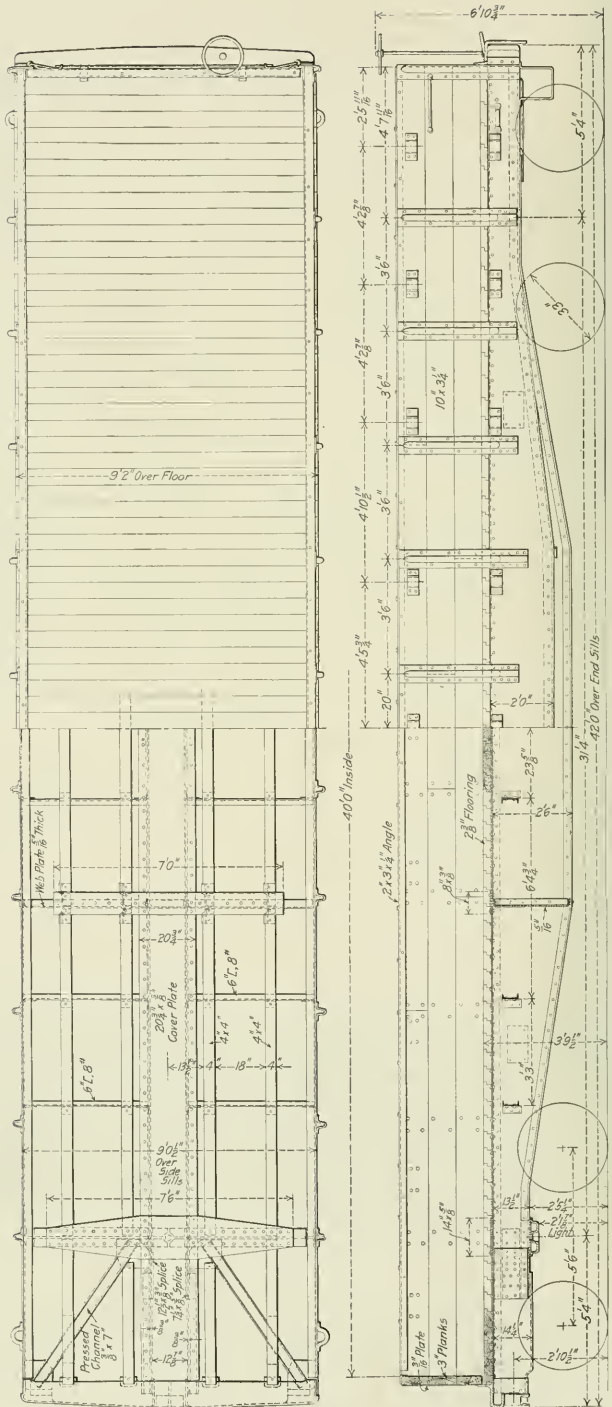

Plan and Elevations of Low Side, Drop End Door, Steel Underframe Gondolas for the Jersey Central.

top cover plate and a 1/2 in. bottom cover plate. The cross bearers are 5/16 in. pressed steel plate in channel section with a 3/8 in. x 8 in. top cover plate. These have a pressed steel channel reinforcement at the bottom, formed and applied as shown in the illustration. These cross bearers do not extend to the bottom of the center sills, but the filler sections between the center sills are arranged to extend the full depth. The cross ties, of which there are two between each of the cross bearers and the bolsters, are 6 in., 8 lb., channels secured to the side and center sills by 3/8 in. angles. The diagonal braces from the end of the side sills to the body bolster are pressed in channel shape from 3/8 in. plate. They are 5 in. in width and 13/4 in. in depth and are secured to the corner gusset plates at each end.

The wooden siding is bolted to side stakes pressed from 3/8 in. steel plate to the form and size shown in the illustrations. At the corners a special design of stake has been used which includes the stop for the sides of the end door. The part of this stake extending over the end, fits back of an extension on

able wearing plates at the openings for the bolster. The frames were furnished by the American Steel Foundries and have been somewhat strengthened at the point of support for the spring plank. Cast bolsters are employed and the wheels are of the 33 in. standard 725 lb. cast iron type. The journals are 5 1/2 in. x 10 in., and Gould malleable iron journal boxes have been applied. Some of the specialties employed on the car are: Miner friction draft gear, class A-7; simplex couplers; Flory carry iron; Waycott brake beam and Westinghouse schedule K. C. 1012 brakes with No. 10 pressure retaining valves.

Five hundred of the cars were built by the American Car & Foundry Company, and an equal number by the Standard Steel Car Company. They have a total weight of 44,100 lbs. The general dimensions are as follows:

Length over end sills	42 ft. 0 in.
Length inside	40 ft. 0 in.
Distance from center to center of truck	31 ft. 4 in.
Width over side sills	9 ft. 1/2 in.
Width over auxiliary stake pockets	9 ft. 9/14 in.
Width over side stakes	9 ft. 7 in.
Width inside	8 ft. 6 in.
Height from rail to top of sides	6 ft. 3/4 in.

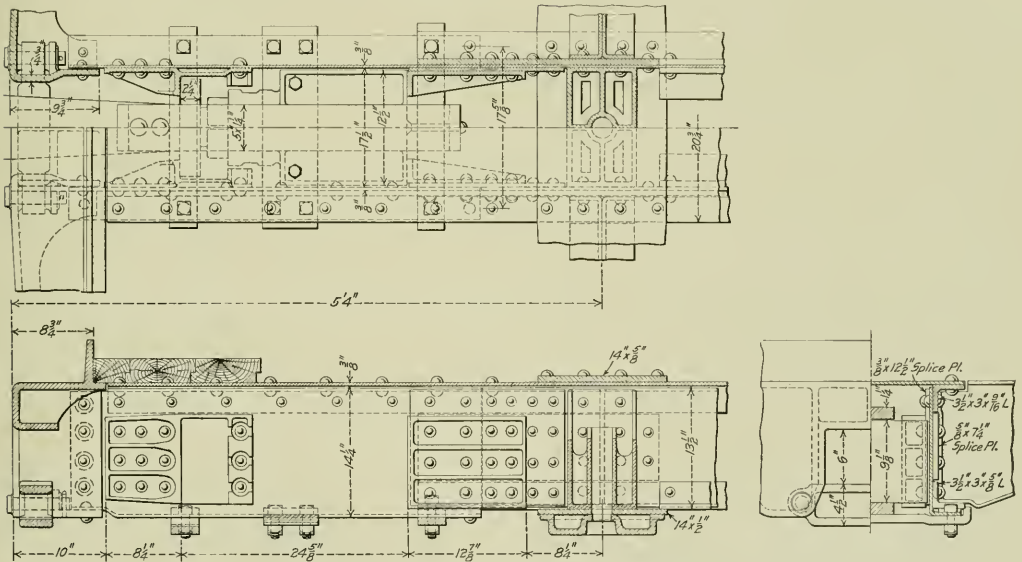

Details of Draft Sills on Jersey Central Gondola.

the top of the cast steel end sill. There is also an extension of this sill at the center of the car to reinforce the end door at the bottom and take the stress from the hinges. Pockets are provided for extra wooden side stakes where needed to carry a superimposed load. The sides are 2 ft. 6 1/4 in. high above the floor level and are capped by a 2 in. x 3 in. x 1/4 in. angle iron. The flooring is nailed to four 4 in. x 4 in. yellow pine longitudinal sills which rest on and are secured to cross ties. These sills rest in malleable iron pockets at the cross bearers and bolsters, and in recesses in the end sills. The ends of the floor planks rest on top of the side sills and extend 1/2 in. beyond them.

The end doors have two hinges. The straps extend the full depth of the door and swing on a staple bolted in the end sill. The doors are held in a vertical position by a simple design of clamp on either side. There is a permanent hand brake at one end of the car only. This is located 21 1/2 in. from the center line and passes through the end sill.

These cars are carried on trucks having a special improved Andrews cast steel side frame which is arranged with remov-

Height from rail to top of floor	3 ft. 9 1/4 in.
Height from rail to top of brake mast	6 ft. 10 1/2 in.
Height from floor to top of car body	2 ft. 6 1/4 in.
Width over flooring boards	9 ft. 2 in.

RAILROAD TO CONNECT SPAIN & FRANCE.—Construction work is under way on the Trans-Pyrenean Railway, which will connect Ax, in the southeastern corner of France, with Puigcerda and Ripoll, in the province of Gerona, in the northeastern portion of Spain.

HYDROPLANES.—The advantages and disadvantages of hydroplanes are much the same as those of the ordinary aeroplane. Their main disadvantages are the difficulty of landing in a rough sea, and the fact that on alighting the supporting planes, etc., are liable to cause instability if there is much wind. They have, however, one great advantage over aeroplanes, viz., that they can be made larger and carry greater useful load, as they are not limited in space for starting. Improvements necessary, are as for aeroplanes, flexible give-and-take supporting surfaces and, further, suitable arrangements for folding up these surfaces when floating on the water.—*The Engineer*.

STEEL UNDERFRAME CAR FOR THE READING

End Construction Reinforced by a Large Steel Plate, Heavy Cross Braces and End Sill Design.

The Philadelphia & Reading has in service nearly two thousand steel underframe, 85,000 lb. capacity box cars with a most substantial end construction. One thousand more of the same design are now being built by the American Car & Foundry Company. These cars have an inside length of 32 ft. 2 in., and

the superstructure framing and sheathing is of wood with the exception of the carlines and several special steel reinforcing plates.

There is but little in the underframe design that differs from the usual modern practice. The center sills are built up of

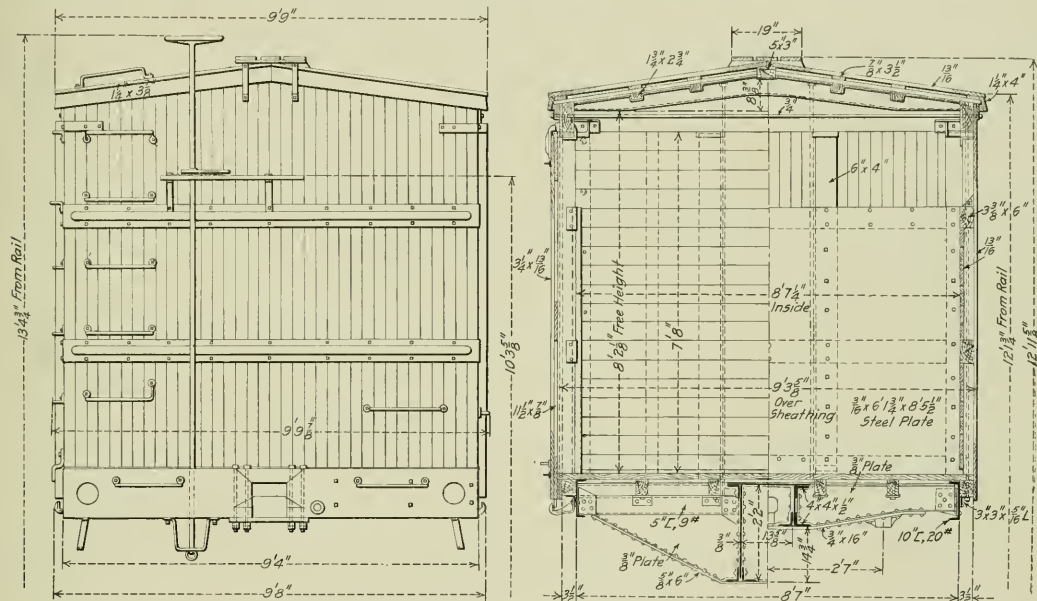

End Elevation and Cross Section of Philadelphia & Reading Box Car.



Steel Underframe Box Car with Reinforced Ends; Philadelphia and Reading.

ILLUMINATION OF POSTAL CARS

$\frac{3}{8}$ -in. web plates, 26 in. in depth for a distance of 9 ft. 9 in. in the center, and $11\frac{1}{2}$ in. in depth over the bolsters. These are reinforced at the top by a 4 in. x 4 in. x $\frac{1}{2}$ in. angle on the outside, and at the bottom by inside and outside angles of the same size. There is a top cover plate $\frac{1}{4}$ in. x $22\frac{1}{2}$ in. which runs continuous for the full length of the center sills proper, but does not include the draft sills. The side sills are 10 in., 20 lb., channels with the flanges turned inward, and have 3 in. x 3 in. x $\frac{5}{16}$ in. angles riveted on the outside of the web for supporting the outside floor stringers. The construction of the cross bearers and floor beams is clearly shown in the illustrations. Special attention is directed to the bolster top cover plate, which is of $\frac{1}{2}$ -in. steel, 24 in. wide at the center, thus giving a liberal connection with the center sills and materially stiffening their short extension beyond the bolster. The draft sills are pressed in Z shape from $\frac{3}{8}$ -in. plate, and have lap joints on the webs of the center sills to which they are secured by 19 rivets, 9 of which are $\frac{7}{8}$ in. The top cover plate of the center sills extends over this joint.

The construction at the end of the car offers the point of greatest interest in the design. The end sills are 13 in., 32 lb., channels, and are secured to the draft and side sills by substantial malleable iron connections and stiffeners. This channel extends several inches above the top level of the underframe, and has a 3 in. x 2 in. x $\frac{5}{16}$ in. angle riveted to its top flange. The outwardly extending flanges of the sill enclose a cast steel filling block that includes the push pole pockets. Back of the top extension of the end sill is a 4 in. x 7 in. wooden sill, and back of this a $\frac{3}{16}$ in. steel plate, which extends from the bottom of the floor boards to a height of 6 ft. $1\frac{3}{4}$ in. for the full width of the inside of the car. Outside of this plate are two 4 in. x 6 in. horizontal wooden members and two intermediate 4 in. x 6 in. end posts and the vertical $\frac{3}{16}$ in. outside sheathing. The superstructure also includes a $3\frac{3}{8}$ in. x 6 in. belt rail and an intermediate plate of the same size, both of which are reinforced on the inside by $\frac{1}{8}$ in. x 6 in. steel plates. These are bent over at the end and riveted to the end reinforcing plate, and are secured with numerous screws to the wooden member back of them. At the opposite end they are bent over and secured to the door post. As a further reinforcement to the end construction there are two pressed steel end braces formed in U section, 4 in. deep at the center of the car and tapering in at the corners. These are 6 in. in width and are secured outside the sheathing and have an extension on the side of the car for $14\frac{1}{4}$ in. where they are bolted through the side framing to the steel reinforcing plates just mentioned.

The arrangement and construction of the wooden superstructure closely follows accepted practice for this size of car, and is clearly shown in the illustrations. An improved Chicago-Winslow inside metal roof supported by Chicago-Cleveland pressed steel carlines has been applied. It will be noted that the floor is supported by six longitudinal 3 in. x 4 in. stringers which are carried by malleable iron brackets at the cross braces and bolster, and rest on top of the floor beams. The cars weigh 48,100 lbs. new.

PARCELS POST RECORD.—The postmaster general reports that the number of parcels carried in the mails during the month of February was about fifteen million, or 50 per cent. in excess of the number carried in January. The number mailed in Chicago was 5,167,540, more than a million greater than the number sent from New York, which showed the next largest record.

AVIATION RECORD.—On Tuesday, February 25, a French aviator, Marcel G. Brindejone des Moulinais, flying in a monoplane, traversed the distance from Paris to London, 287 miles, at the rate of about 90 miles an hour. There was a dense fog when he crossed the channel. The aviator started at 9:15 a. m., landed at Calais at 10:50, resumed his flight at noon, and descended in London at 1:30.

The lighting of postal cars, because of the character of the work performed in them and the length of time that artificial light is required, is a subject which requires very close study and attention. The Baltimore & Ohio, through its electrical department, made an extensive series of tests during the fall of 1912 in Washington, D. C., on one of its latest types of steel postal cars, in order to obtain adequate data on this subject. The standardization of the construction and of the arrangement of this type of car makes it possible to draw conclusions from these tests that will generally apply to cars built under the present government specifications.

Although the tests were carried out on a broad engineering basis, covering all practicable methods of car illumination available at the present time, the investigation was confined solely to the question of providing proper and adequate illumination. The questions of maintenance, of the most desirable kind of illuminants, and of the operating problems connected with the generation of light were not considered further than with respect to their influence upon the quality of illumination provided. In detail, the phases of the subject covered were the relative suitability of: first, Pintsch gas and electricity, representing the most important types of primary illuminants, as far as their influence upon the quality of illumination produced was concerned; second, the different types of reflectors and diffusers; and third, the different types and arrangements of lighting units. The investigation consisted of illumination tests to ascertain efficiency and uniformity data as well as shadow effects obtained with the various types of lighting units and spacing arrangements; also, visual intensity tests to ascertain the intensities of illumination required in the different sections of the car by the character of the visual work performed in those sections.

Two important features brought out by the investigation were: that adequate illumination may be provided with the amount of light that is at present generally provided by most railroads, the unsatisfactory illumination frequently obtained being largely due to the improper arrangement of the light units and unsatisfactory types of reflectors; and that the amount of illumination required for the work in the postal service has been considerably over-estimated.

In the direct system of illumination the correct location of the light is determined by absence of the shadows. In the bag rack section of the car the light units should be located along the center line of the car and the mounting height should be 7 ft. 7 in. from the floor to the center of the lamp filament or gas mantle in order to produce the least objectionable shadow effects as well as to eliminate shadows on the rear bag rack label. At the letter cases adequate illumination can be provided for only by light units independent of those used for illumination of the body of the car, and such light units should be located as far in front of the case as possible without shadows being thrown on the work by the body of the mail distributor. With the standard design of letter case having a 17 in. table this distance is 20 in. from the front of the letter case.

In determining the best types of reflectors for postal car service four qualities were considered: the effect of the resultant illumination upon the eye; the relative efficiency; the cleaning consideration; and the liability to breakage. As these are not of equal importance, relative values of these qualities were chosen after considering the question from several different points of view. Out of a total of 100 points an importance represented by the following figures was assigned to each of the qualities under consideration:

Effect on the eye	44
Efficiency	30
Cleaning	18
Breakage	8
Total	100

On this basis the relative suitability of the various types of reflectors for postal car lighting was found to be as follows:

Class of Reflector.	Make of Reflector Represented in Tests.
Aluminized metal	Holophane D'Olier No. 18460 body of car; Holophane D'Olier No. 18470 at letter case.
Heavy density opal glazed reflecting surface (specially designed for car lighting service)	Holophane No. 18626 redesigned.
Medium density opal glazed reflecting surface	Phoenix CL-50.
Porcelain enameled metal	Holophane D'Olier No. 18461.
Medium density opal depolished reflecting surface	Macbeth-Evans Alada No. SF-1623.

Class of Reflector.	Make of Reflector Represented in Tests.
Indirect lighting with enameled reflectors for gas lighting	Experimental enameled reflector.
Mirrored glass (direct lighting)	X-Ray 555.
Prismatic clear	Holophane No. 18226.
Prismatic satin finish	Holophane No. 18226-SF.
Reflecting and diffusing globes	Safety Corona No. 8026.

Extensive tests to determine the amount of illumination required for comfortable reading indicated that there was an appreciable difference in the character of the illumination afforded by different types of equipment. Certain types gave an illumination of such a character as to leave the eye in a less satisfactory condition for vision, thus requiring an increased intensity of

A SUMMARY OF THE BALTIMORE & OHIO ILLUMINATION TESTS.

Installation.	ENTIRE CAR.			BAG RACK SECTION.			LETTER CASE SECTION.			STORAGE SECTION.
	Nature of Value.	Foot candles.	Per Cent. Useful Lumens.	Ft. C. Center	Ft. C. Mouth	Ft. C. Vertical on Pap. Bx.	Horizontal Ft. C.	Vertical Ft. C.	Foot candles.	
Mirrored glass, X-Ray 696, 5 ft. spacing, 1 3/16 in., position	Avg.... 6.03 Max.... 17.90 Min.... 2.12	62.3	...	12.04 17.90 7.28	3.77 3.98 3.37	3.74 4.74 2.16	10.75 13.70 8.80	4.67 7.04 2.12	3.84 8.50 2.12	
Prismatic clear, Holophane 18226, 5 ft. spacing, 1 1/2 in. position	Avg.... 5.28 Max.... 14.65 Min.... 2.02	54.6	...	8.38 9.36 7.72	3.45 3.69 3.20	1.95 2.46 1.59	7.87 9.52 6.42	4.48 6.67 2.01	3.65 6.76 2.02	
Prismatic clear, Holophane 18226, 7 1/2 ft. spacing, 1 1/2 in. position	Avg.... 3.97 Max.... 11.30 Min.... .89	53.4	...	6.13 8.49 4.79	2.47 3.40 1.97	1.17 1.60 .97	6.94 7.67 6.14	4.48 6.67 2.01	2.92 8.00 .89	
Heavy density opal, Holophane 18626, 5 ft. spacing, 1 1/2 in. position	Avg.... 5.00 Max.... 11.55 Min.... 2.09	51.8	...	8.33 10.38 7.66	3.59 3.93 3.26	2.75 4.06 1.91	7.69 9.03 6.17	5.05 8.54 2.27	3.42 6.46 2.09	
Heavy density opal, Holophane 18626, 7 1/2 ft. spacing, 1 1/2 in. position	Avg.... 4.20 Max.... 12.52 Min.... 1.03	56.4	...	5.87 6.87 4.63	2.76 3.75 2.38	1.74 3.35 1.98	7.83 9.79 6.51	3.04 8.83 1.03	
Medium density opal, Phoenix 10456, 5 ft. spacing, 1 1/2 in. position	Avg.... 4.14 Max.... 8.45 Min.... 2.14	42.8	...	6.31 7.62 5.71	3.43 3.72 2.91	4.01 4.65 3.19	5.36 5.72 4.78	3.01 5.09 1.22	2.96 5.50 2.14	
Prismatic satin finish, Holophane 18226 SF, 5 ft. spacing, 1 1/2 in. position	Avg.... 3.78 Max.... 7.95 Min.... 2.09	39.0	...	6.07 6.87 5.36	2.89 3.41 2.51	2.52 3.08 1.99	5.51 6.14 4.95	3.16 5.10 1.46	2.74 4.73 2.09	
Aluminized metal, Holophane D'Olier 18460 and 18470, 5 ft. spacing, 1 1/2 in. position	Avg.... 4.28 Max.... 9.51 Min.... 2.39	44.2	...	5.86 6.14 5.58	3.35 3.57 2.96	2.66 3.69 1.35	8.42 9.51 7.13	3.95 5.86 2.23	3.03 5.19 2.39	
Aluminized metal, Holophane D'Olier 18460 and 18470, 7 1/2 ft. spacing, 1 1/2 in. position	Avg.... 3.38 Max.... 8.84 Min.... 1.15	45.3	...	4.37 5.21 4.02	2.50 2.83 2.23	1.46 3.38 .58	7.64 6.87 6.87	3.95 5.86 2.23	2.43 4.50 1.15	
Medium density opal, Macbeth-Evans SF-1623, 5 ft. spacing, 3/8 in. position	Avg.... 3.98 Max.... 7.85 Min.... 2.38	41.1	...	5.84 6.65 5.43	3.39 3.68 2.86	3.34 4.20 2.51	5.19 5.84 4.71	3.31 4.90 1.45	2.96 4.90 2.38	
Medium density opal, Macbeth-Evans SF-1623, 7 1/2 ft. spacing, 3/8 in. position	Avg.... 3.10 Max.... 6.76 Min.... 1.32	43.0	...	4.26 6.02 3.65	2.45 3.12 2.25	1.89 3.18 1.25	4.46 4.83 4.04	3.31 5.90 1.45	2.36 4.46 1.32	
Enameled metal, Holophane D'Olier 18461, 5 ft. spacing, 1 1/2 in. position	Avg.... 3.86 Max.... 8.17 Min.... 1.67	39.9	...	3.78 6.80 5.48	3.78 3.26 2.76	2.83 4.04 1.75	5.62 6.21 4.77	4.09 5.32 1.56	2.74 5.32 1.67	
Enameled metal, Holophane D'Olier 18461, 7 1/2 in. spacing, 1 1/2 in. position	Avg.... 3.23 Max.... 7.94 Min.... 1.26	43.4	...	4.39 6.30 3.68	2.38 3.08 2.08	1.47 2.97 1.80	5.44 6.31 4.67	4.09 7.17 1.56	2.52 5.42 1.26	
Heavy density opal, Opalux 123, 5 ft. spacing, 1 3/16 in. position	Avg.... 3.73 Max.... 7.00 Min.... 2.11	38.5	...	5.51 6.15 5.07	3.14 3.46 2.58	4.27 5.52 2.83	4.98 6.60 4.65	3.63 6.60 2.34	2.84 5.33 1.51	
Medium density opal, Phoenix CL-50, 5 ft. spacing, 1 1/2 in. position	Avg.... 3.81 Max.... 7.92 Min.... 1.75	39.4	...	5.54 6.30 5.13	3.12 3.28 2.57	2.63 3.14 2.13	5.11 5.68 4.45	3.46 .58 1.46	2.87 5.11 1.75	
Reflecting and diffusing, Adams & Westlake 15050, 5 ft. spacing	Avg.... 3.06 Max.... 5.63 Min.... 1.21	31.6	...	4.79 5.42 4.32	2.45 2.85 2.16	4.14 4.51 3.63	4.34 4.78 3.82	2.18 4.36 1.21	
Bare lamps, 5 ft. spacing	Avg.... 2.71 Max.... 5.20 Min.... 1.65	28.0	...	3.79 4.11 3.42	2.46 2.84 2.00	4.36 4.59 4.14	2.72 2.93 2.56	1.94 3.86 .59	2.10 3.69 1.65	
Aluminized metal, Holophane D'Olier 18440, 5 ft. spacing, "O" position, 15 watt lamps	Avg.... 2.28 Max.... 4.15 Min.... .38	44.6	...	3.63 3.96 3.32	3.10 2.23 1.99	2.34 3.54 1.98	2.28 2.71 1.50	1.69 3.05 .57	1.62 2.77 2.58	
Mirrored glass (indirect lighting), X-Ray E-100, 50 watt lamps, 10 ft. spacing	Avg.... 2.37 Max.... 4.26 Min.... .84	26.1	...	3.34 3.87 2.89	1.82 2.24 1.14	1.46 1.78 1.18	1.90 2.18 1.58	1.90 1.95 .93	2.05 4.26 .93	
Gas Lighting.										
Aluminized metal, Holophane D'Olier 18418 and 18490, mantle 3044, 7 1/2 ft. spacing	Avg.... 5.95 Max.... 17.10 Min.... 2.47	44.5	...	7.24 7.96 6.51	4.07 4.59 3.65	2.30 5.16 .93	15.4 17.10 12.55	6.08 8.90 3.69	4.78 8.33 2.97	
Enameled metal, Holophane D'Olier 18417 and 18479, mantle 3044, 7 1/2 ft. spacing	Avg.... 4.91 Max.... 11.88 Min.... 2.29	37.2	...	6.66 7.15 5.60	3.72 4.06 3.13	3.78 4.80 1.60	9.40 11.80 7.12	6.32 7.78 2.74	4.24 7.78 2.74	
Aluminized metal, Holophane D'Olier 18410 and 18490, mantle 3044 and 2640, 7 1/2 ft. spacing	Avg.... 4.88 Max.... 13.50 Min.... 2.78	45.0	...	5.61 6.26 4.52	4.01 4.47 3.09	4.54 9.18 2.03	11.22 13.50 9.63	5.15 7.51 3.05	3.92 5.48 2.92	
Reflecting and diffusing globe, Safety Corona 3425, mantle 3044, 7 1/2 ft. spacing	Avg.... 4.10 Max.... 7.50 Min.... 2.04	39.7	...	5.47 7.37 4.59	3.47 4.06 2.60	5.26 6.26 4.60	5.20 5.82 4.67	5.04 8.85 1.89	3.46 6.23 1.84	
Reflecting and diffusing globe, Safety Corona 8026, mantle 3044, 7 1/2 ft. spacing	Avg.... 3.86 Max.... 8.23 Min.... 2.00	28.9	...	5.18 5.95 4.25	2.85 3.23 2.42	4.56 6.05 3.72	5.56 6.22 4.83	4.05 6.60 1.93	3.37 6.20 2.00	
Diffusing globe (opal), Safety 3116, mantle 3044, 7 1/2 ft. spacing	Avg.... 5.21 Max.... 6.81 Min.... 1.50	24.0	...	4.58 5.63 3.52	2.19 2.63 1.84	3.48 4.73 2.80	5.59 5.94 4.67	3.20 4.94 1.69	2.79 5.79 1.50	
Enameled metal (indirect lighting), Safety mantle, "125 C. P.," 10 ft. spacing	Avg.... 3.06 Max.... 3.35 Min.... .90	18.9	...	3.13 3.34 2.88	1.70 2.20 1.13	1.36 1.56 1.19	1.38 2.02 1.04	1.69 1.03 1.51	1.95 3.14 .90	

illumination for adequate vision. For practical purposes it was found that with direct lighting systems the equipment could be divided into two classes relative to the character of illumination produced; one in which the specular element was considerable, such as was obtained from direct lighting systems employing mirrored glass, porcelain enameled, heavy density opal-reflectors with glazed reflecting surface; and one in which the illumination was largely diffused, such as was obtained from direct lighting systems using diffusing globes, opal reflectors of all classes except heavy density opal with a glazed reflecting surface, aluminized metal, and prismatic reflectors. This class of reflectors required approximately 80 per cent. of the illumination of the first class. Extensive tests made to ascertain the intensities of illumination required showed that 2.25 foot candles

as to render the eye much less efficient as well as more susceptible to severe eye strain than where reflectors are used.

The minimum and maximum initial illumination values, as well as the service illumination values required under the Post Office Department specifications, revised to December 28, 1912, were determined upon as a result of these tests in this connection, and they constitute the only authentic data thus far available on this subject.

So far as the question of illumination is concerned the investigation showed that when proper location of lamps and proper types of reflectors are provided, equally satisfactory results may be obtained with Pintsch mantle gas lighting and electric lighting. In conducting the tests the assistance of illuminating experts of the leading reflector, car lighting fixture, and in-

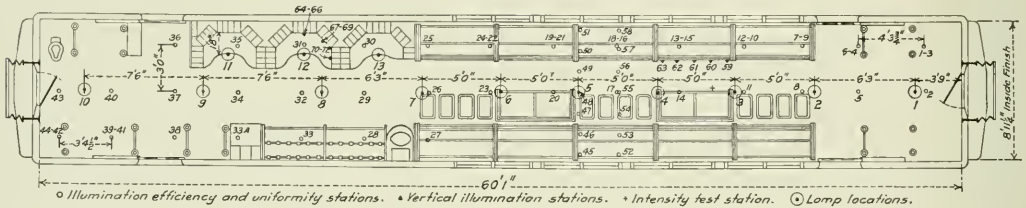

Location of Stations and Lamps with 5-ft. Spacing.

on the reading plane was a safe value for minimum satisfactory intensity for continuous close visual work under illumination derived from lighting units of the second class. On the same basis it was found that 3.5 ft. candles was ample illumination and that higher values were unnecessary for adequate service. It was further found that about one-half or slightly less of this minimum intensity value was required at the mouth of mail bags in the bag rack portion of the car, on the face of the letter cases and in the storage section. The results of the illumination tests with the principal types of electric and gas units tested are given in the accompanying table, while the two illustrations show the plans of the test car giving the location of the lighting units and of the test stations. The table gives the average, maximum and minimum foot candle values obtained in the car as a whole, the bag rack section, the letter case section and the storage section. The efficiency of the system is given as the ratio of light falling on the working plane to the total light generated by the lamps.

The importance of using proper types of reflectors in car light-

ing units was obtained, and in order to insure the greatest accuracy of the test results the National Bureau of Standards extended its co-operation by calibrating the instruments, rating the lamps used, and making photometric curves of all the light units tested.

Acknowledgment is made by the railway company to the Holophane Works of General Electric Company, Safety Car Heating & Lighting Company, Adams & Westlake Company, National Electric Lamp Association, General Electric Company, Westinghouse Lamp Company, Macheth-Evans Glass Company, National X-Ray Reflector Company, Phoenix Glass Company, Opalux Company, and the National Bureau of Standards for their co-operation in conducting this research.

PROGRESS AT PANAMA.—The total excavation for February was 2,108,530 cu. yds., place measurement, against 2,612,020 cu. yds. in January.

SOUTH AFRICAN RAILWAYS.—The report for 1911 of the gen-

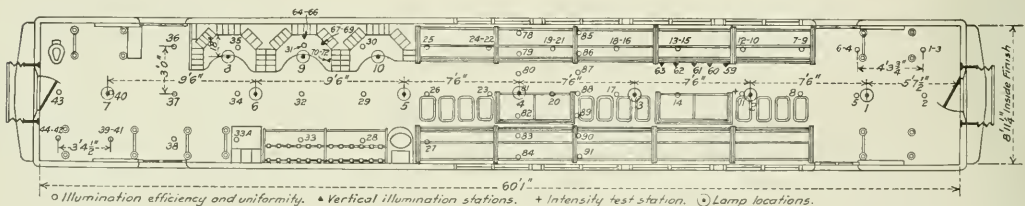

Location of Stations and Lamps with 7 1/2-ft. Spacing.

eral manager of the South African Railways and Harbours states that at the end of the year the open mileage was 7,546 1/2 miles, while about 913 miles were under construction. The earnings were 12 million pounds sterling, including over two millions from coal, and the expenditure £7,217,000, the surplus being £4,887,000. The results obtained from two locomotives built at Durban have convinced the chief mechanical engineer that the policy of building locomotives and boilers in the Durban and Salt River workshops should be considerably extended as soon as these shops have been enlarged.—The Engineer.

ing service for all classes of cars is shown in the comparison of the illumination obtained with the most efficient type of reflector tested, the mirrored glass, with the bare lamps, in which the illumination obtained on the working plane where the reflector was used was practically 220 per cent. of that obtained with the bare lamps, the number of lamps installed being the same in each case. The ceiling of the car had been freshly painted a dead white, which gave more favorable conditions for the bare lamps than would generally be obtained in service. Further, the glare effect obtained from the bare lamps is such

NEW DEVICES

LOCOMOTIVE VALVE GEAR DRIVEN FROM THE CROSSHEAD

The rolling of a locomotive changes the relative position of the driving axle and the cylinders and has some effect on the accuracy of the Walschaert and Stephenson type of valve gears.

crank on a revolving shaft fastened to the locomotive frame, instead of from the driving wheel in the customary manner. This driving shaft, which is marked *A* in the illustration, continues across the locomotive on top of the frames and is revolved by the lever *C* and the rod *B* which form a connection from the crossheads as shown. It thus has practically the same rotary

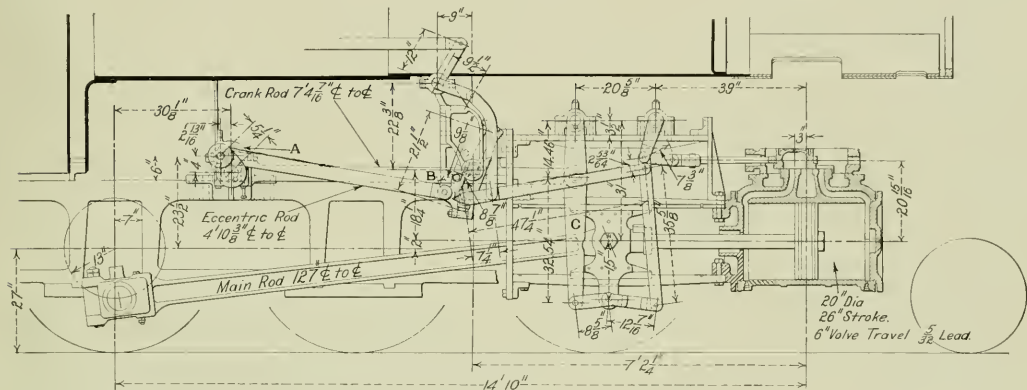

For the purpose of overcoming this objection, an original type of valve gear has been designed and put in service on the Chicago, Peoria & St. Louis. It consists essentially of a Walschaert gear deriving its motion for the valve travel from a return

motion as the driving wheel and the movement of the return crank delivers to the link the same speed and periodicity of oscillation as it would have if connected to the driving wheel. It should be noted, however, that the rotary shaft on the engine

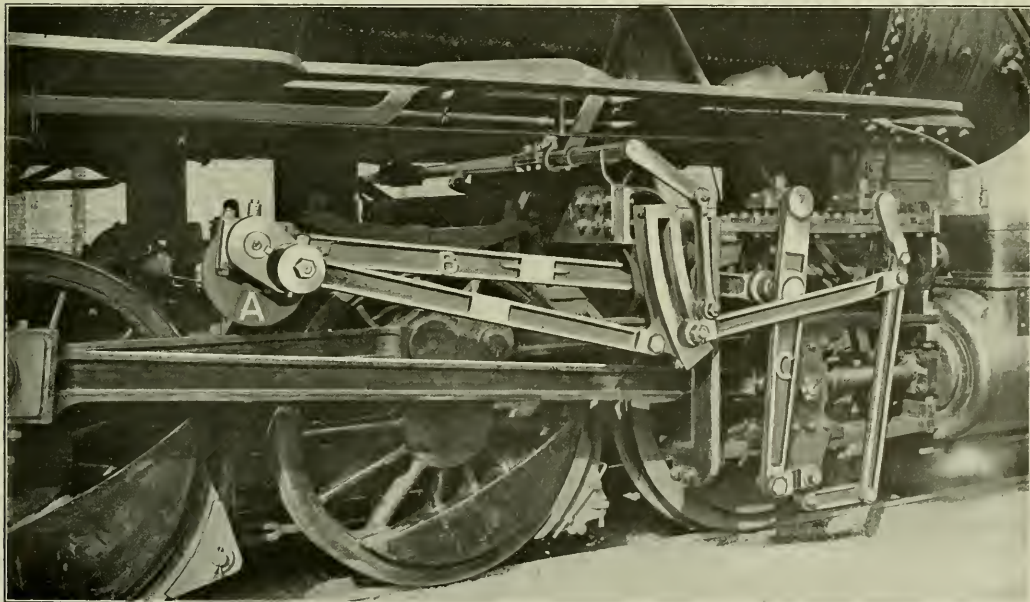

Locomotive Valve Gear Driven from the Crosshead; Chicago, Peoria & St. Louis.

is rigidly supported from the frame the same as the link, and their relative positions are therefore unchanged and unaffected by any vertical movement of the wheels and boxes in the pedestals. The eccentric or return crank is of the same general form and performs the same functions as in the ordinary Walschaert valve gear.

This valve gear has been applied to a Chicago, Peoria & St. Louis locomotive which was built to carry 200 lbs. steam pressure and it is reported that since applying the new gear the pressure has been reduced to 180 lbs. without reducing the efficiency of the locomotive. This is believed to be due to the more accurate and uniform movement of the valve.

RUMSEY FREIGHT CAR DOOR

A freight car door, designed to meet the requirements of all kinds of freight service, has been placed on the market by the Rumsey Car Door & Equipment Company, Karpfen Building, Chicago. At the first glance this door has all the appearances of the ordinary car door now in use on most roads. In fact, the design of the door itself is secondary to the design of the door housing in the side of the car. It has been the aim of the makers to so design the door and door opening that when the

features of the construction, is shown in section *CC*. A pressed steel shape encases and is securely bolted, or riveted in steel cars, to the main post and forms the pocket for the door. The outer end of the pocket is slightly bent outward so that when the door is closed it will be forced to a positive bearing against the inside face of the pocket, thereby forming a seal against any leakage of the material within, and against any moisture from without. The notch cut out of the filler block in the pocket is to allow any moisture that may collect to escape. The other end of the door is similarly forced against the door framing, as shown in section *DD*. By means of these guides the door is made to bear on all four sides of the framing. The right hand door post is also encased by a pressed steel shape which not only protects the wooden post, but also gives a much stiffer and durable arrangement.

Special efforts have been made to make the door water proof when it is closed, and a study of the construction will show that every means has been adopted to keep the water or moisture out. Where there is a possibility for any moisture collecting suitable drains have been arranged. Section *JJ* shows the seal applied to the end of the door in the runway to prevent moisture from entering at that place. If, however, any water should collect there it would be drained off around the outside door track, as shown in section *AA*. The pressed steel shapes used through-

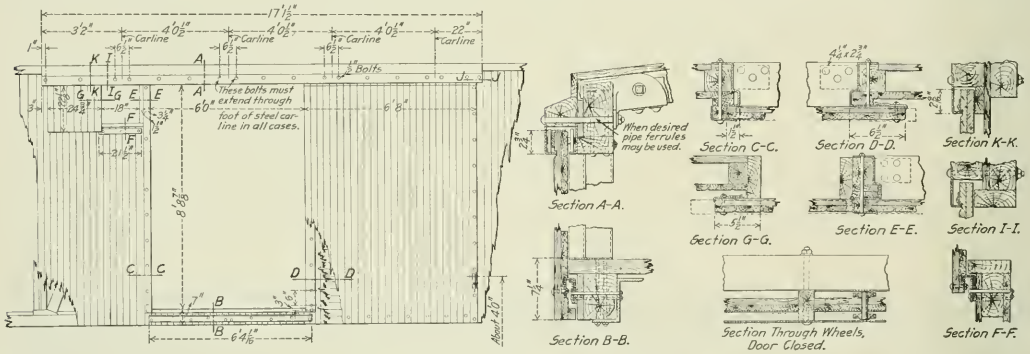

Rumsey Door for Grain and Refrigerator Cars.

door is closed the opening will be as thoroughly protected and as substantial as any other part of the car.

The chief difficulties experienced with freight car doors in general have been encountered when shipping grain, flour, etc., in bulk, or the ease with which they may be sprung open for unwarranted entry. This door is so designed that when closed it has a positive bearing on all four sides, and is so anchored in the side of the car that any attempt to force an opening, without breaking the seal, is practically impossible. The first feature eliminates the coooperage work necessary on old type doors, which at best is usually unsatisfactory, and the second feature will materially reduce the amount of the claims paid for stolen freight.

The door is made of two layers of boards, the inner layer running longitudinally with the door action. It is carried by two pairs of rollers running on pressed steel tracks bolted to the side plate, as shown in section *AA*. The axles of the rollers have a force fit in the stiffening angle. When the door is closed it will be forced to a bearing, on the top, against the edge of the inside door track. Section *BB* shows clearly the bottom guide. Both the guide on the door and on the car are of pressed steel; the guide on the car is securely bolted to the side sill. The block or filler attached to the door underneath the guide is to prevent the guides from being damaged by any vehicle backing up against the door.

The design of the door post, which is one of the important

features of the construction are of No. 10 gage, open hearth steel. This door is also adaptable to refrigerator cars, special insulation being applied between the door boards.

The small door to the left of the main door is for loading grain or other such commodities. It is also constructed so that it too may be closed tightly. The sections *AA*, *EE*, *FF* and *GG* show clearly the method of accomplishing this result. The door is locked by a malleable iron lock bar, as shown in the elevation drawing of the door. This bar is hinged to the door and swings vertically. It is provided with a tongue extending through the door that fits into a notch in the car side, so located that the door can only be locked wide open or closed. When opposite either notch the bar falls into mesh with a staple on the door, and is sealed by a lead rivet seal. The door cannot be opened without raising the lock bar, which will of necessity break the seal.

The claims of the builders for this door are as follows: It is so housed in the side of the car that it will be as substantial as any other part of the car; the steel door posts prevent bulging and make the operation of the door easy; the interlocking of the door with the door posts forms a moisture proof seal and prevents grain leakage; by insulating the door a practical and safe refrigerator door may be made; the door cannot be sprung open and entry must be made by breaking the seal; on account of its rigid construction the cost of maintenance will be materially reduced.

HEAVY MILLING MACHINE

A new type of milling machine has been recently placed on the market by the Kempsmith Manufacturing Company, Milwaukee, Wis. It is known as the Lincoln type and is especially designed for the manufacture of heavy duplicate parts. It is of the constant speed type, all changes of the spindle speed being effected through change and sliding gears. For each change of spindle speed there is a corresponding change of back gear ratio, which never falls below one to 2.15 and runs as high as one to 13 on the slowest speed, thus adapting the machine to taking the heavy cuts with high speed cutters. This feature combined with the large bearing surfaces of the saddle and table and the essentially rigid construction enables the machine to be used on a wide range of both light and heavy work.

The driving pulley is 15 in. in diameter and is flanged to carry a 4 in. double belt at a constant speed of 250 r. p. m. The arrangement also permits the application of a motor drive. The pulley is keyed to the main driving shaft, which runs in a pair of Standard roller bearings. This shaft is connected to the gear train through a clutch so

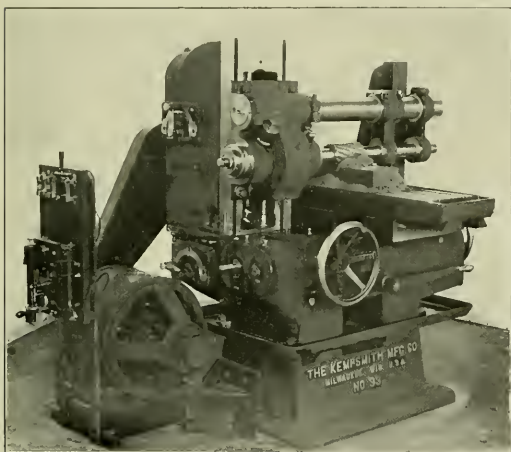

Heavy Motor Driven Milling Machine.

designed that it starts on friction and is later thrown into a positive three-tooth hardened steel clutch. Starting and stopping of the entire gear train, and consequently of the spindle, is controlled by either one of two levers from either side of the bed of the machine. To start the spindle the operator raises the starting lever, which when it is in its lowest position holds the clutch out. It is therefore impossible for jar or vibration to throw the clutch into engagement.

The power is transmitted to the spindle driving shaft by means of a train of spur gears mounted on short heavy shafts running in Standard roller bearings. As the changes in speed are secured solely through sliding gears it has been possible to make these gears with a large diameter and a wide face. The teeth have a coarse pitch with a 20 deg. pressure angle. The spindle is driven by a worm and gear. The worm is of hardened steel and is carried by a vertical shaft running in roller bearings, the end thrust being taken by ball bearings. The worm gear is made from a large bronze casting and is mounted between the spindle bearings. This construction is of considerable advantage since it reduces the torsional strain on the spindle. The worm and worm gear run in a totally enclosed case, containing an oil bath for the lubrication of the drive.

The spindle is made from a crucible steel forging, the bear-

ings and inside taper hole being accurately ground. It runs in phosphor bronze bearings and is so arranged that the adjustments for wear may be made without disturbing the alignment. It is 18 in. long, and the diameter of the rear bearing is 2 3/4 in., the largest diameter of the front bearings is 4 1/2 in. and the diameter of the nose is 4 in. The arbors fit in a tapered slot in the end of the spindle, being held in mesh by a "drawn in" rod, which gives a positive drive. The headstock into which the spindle boxes are fixed is provided with ample oil pockets and large glass oilers.

The head frame is of the box type construction, braced internally, with a face of ample dimensions, to which the headstock is firmly bolted by the four bolts. A heavy boss in the headstock fits accurately into a corresponding slot in the head frame, which preserves the vertical alignment. In addition to the spindle the headstock carries one end of the 4 in. overhanging solid steel arm, which is supported at its outer end by the outboard support. This overhanging arm is furnished with an intermediate arbor support, brass bushed, which can be used close up to the cutter. This arrangement gives positive alignment of the arbor and prevents the arbor being knocked out of line under a heavy cut. When not in use the over-arm may be pushed back out of the way.

Vertical adjustment of the headstock is made by means of a shaft projecting from the front of the bed below the head frame instead of at the top of the head frame as in former models. This shaft is provided with a dial graduated to thousandths of an inch, and also with hand wheel.

The table is provided with power longitudinal feed only and the changes in the rate of feed are secured in much the same manner as are the changes in spindle speed. The mechanism is simple and durable, with very little possibility of getting out of order, and is totally enclosed within the bed of the machine. There are no knuckle joints and the parts are readily accessible. The power feed is controlled by one lever at the front end of the bed, the feed at all times being engaged, released or reversed by means of this lever. The position of this lever always indicates the direction of feed. If in an upright position the feed is not engaged; if the lever is inclined to the right, the table travel will be to the right, and if the lever is inclined to the left, the table travel will be to the left. Six changes of table feed are provided ranging from 7/8 in. to 15 in. per minute. The quick return of the table is provided through a hand wheel, giving a table travel of 2 in. for each turn of the wheel.

The machine is so designed that a table much larger than that regularly furnished may be used without altering the saddle or bed, or impairing the efficiency of the machine. The table has three deep T-slots, 5/8 in. wide, and is provided with means for a return flow of the lubricating compound. The base of the machine has a large oil pan fully protecting the floor from any dripping of oil or other lubricant. For lubrication of the cutters every machine is regularly furnished with a geared oil pump running at a constant speed and driven by a Diamond roller chain.

The general specifications and dimensions of this machine other than those already mentioned are as follows:

Length of power longitudinal feed.....	36 in.
Working surface of table.....	42 in. x 13 in.
Length of table bearing on saddle.....	32 in.
Transverse adjustment of table.....	12 in.
Minimum and maximum distances of center line of spindle to top of table.....	2 in. to 12 in.
Distance from underside of overhanging arm to center line of spindle.....	5 1/2 in.
Maximum distance from end of spindle to inner side of outboard support in position.....	25 in.
Spindle speeds.....	19 to 116 r. p. m.
Extreme floor space, 58 in. in direction of length of bed by 84 in. in direction of table travel.....	
Height of top of table from floor.....	37 in.
Extreme height of machine.....	62 in.
Net weight.....	about 4,000 lbs.

POSTAL CAR LIGHTING FIXTURES

To meet the requirements of the exhaustive tests made on a Baltimore & Ohio postal car at Washington during the latter part of last year, which are described elsewhere in this issue, and the recent specifications for lighting postal cars issued by the post office department, the Safety Car Heating and Lighting Company, New York, has developed a new line of fixtures for this class of service.

Where the Pintsch lighting system is used, it was found desir-

able to make the labels at all points in the bag-rack and storage portions of the car very distinct.

The reflector unit shown in Fig. 2 is designed for use at the letter cases and its characteristic light distribution curve is such as to insure ample illumination on the horizontal reading plane as well as on all the letter case labels. The conditions of letter case lighting are such as to require careful study in the design of a reflector to meet the requirements, and without extreme care the lighting at some points on the letter case labels is very apt to fall below or above the specifications.

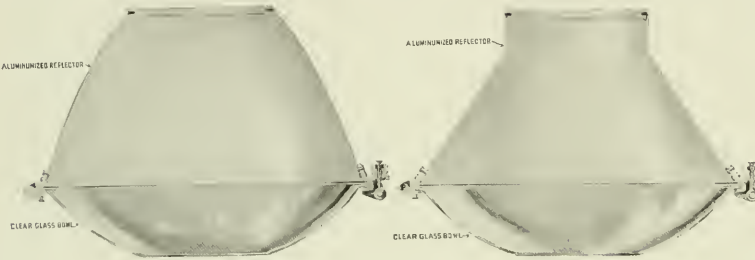

Figs. 1 and 2—Bowl Units for Pintsch Mantle Lamps.

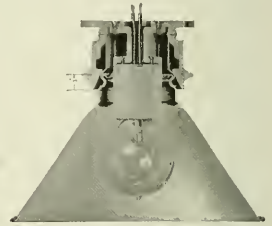

Fig. 3—Shade Holder and Adjustment for Electric Lamp.

able to use a type of metal reflector that would distribute the light properly on the letter cases, bag-racks and paper boxes without a wasteful use of the light on the ceiling and other parts of the car where it was not needed in the distribution of mail matter. Two types of aluminized steel reflector units have been developed, one for letter case lighting and the other for bag-rack, paper box and storage lighting. Both of these reflector units are

This reflector meets these requirements in all cases and allows an ample margin for depreciation. With the standard postal car construction adopted by the post office department the mounting height of Pintsch mantles should be 7 ft. 7 in. from the center of the mantle to the floor of the car, and two different types of mantles are recommended for use with these reflectors.

For electric lighting the government has allowed a wide lati-

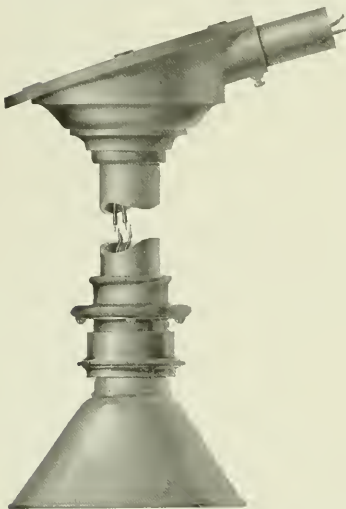

Fig. 4—Universal Electric Lighting Fixture for Postal Car Letter Cases.

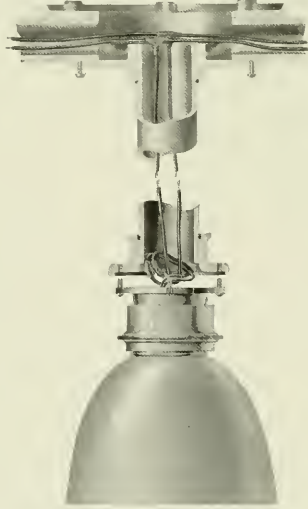

Fig. 5—Universal Electric Lighting Fixture for Bag Racks, Paper Boxes and Storage.

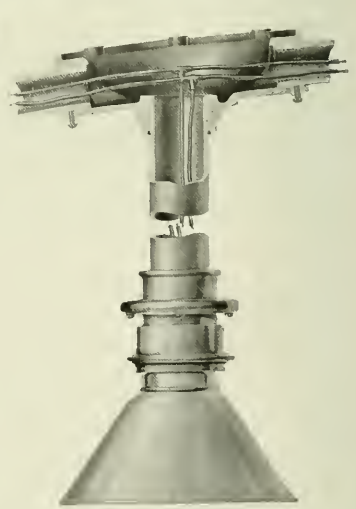

Fig. 6—Universal Electric Lighting Fixture for Letter Cases in Apartment Cars.

made to fit the standard Pintsch mantle lamp, and not only give the required illumination at all points in the car but, by a careful distribution of the light, economize on the gas consumption. The reflector unit shown in Fig. 1 is designed for use on Pintsch lamps in the center of the car to light the bag-racks and paper boxes as well as for general illumination in the car. The characteristic light distribution curve of this reflector is such as to

titude in the use of lamps and reflectors, and the development of a universal type of lighting fixture has necessitated careful study of all conditions. With different spacing of the light units, any of the standard electric train lighting lamps may be successfully used. Considering the metal reflectors alone, it is necessary to provide a fixture that will give a variety of mounting heights considered in the relation of the top of the reflector to the base

contact of the electric lamp. A reflector is designed to meet certain lighting requirements by providing a characteristic light distribution curve when the center of the light source is in a certain fixed relation to the reflector, and it is on account of the variable position of the filament in different types of electric lamps of different shapes and different wattages, that different heights of the base contact of the lamps in relation to the top of the reflector must be provided for in any universal lighting fixture. As in the case of the Pintsch mantle lamp, the light should be distributed where it is needed for the distribution of mail, and not wasted to light the ceilings of the car. It is claimed that the aluminized and enameled steel reflectors are most satisfactory for this purpose, since they distribute the maximum light downward and in addition are practically free from the danger of breakage. Five types of steel reflectors have been selected for postal car lighting, of which that for letter case lighting is shown in Fig. 3. This is intended for all types of electric lamps used at the letter cases. To provide for the use of these different types of lamps and reflectors, six different positions of the base contacts of the lamps in relation to the top of the reflector must be available, and a shade or reflector holder has been developed on the principle of the safety shade holder, wherein a practically universal adaptation to any of these types of reflectors or lamps is obtained. The variable mounting height of the lamp filament in the reflector is taken care of by an extension member or socket support inside of the shade holder, while all the other parts of the shade holder are interchangeable for all conditions of postal car lighting. These shade holders are made to attach to the base and stem of a fixture designed to give the correct height from the center of the lamp filament to the floor of the car according to the requirements in the government specifications. The bases of these fixtures are made with either one or two outlets for either $\frac{1}{2}$ -in., $\frac{3}{4}$ -in., or 1-in. conduit, and provide for an easy and accessible method of conduit wiring inside the car. This universal type of shade holder is also adapted, without change in its construction, to the many types of Crouse-Hinds condulets occasionally preferred by the engineer in installing his electric wiring. The feature of universally adapting a fixture for every requirement in postal car lighting should be of immense advantage in car lighting, since it provides for future developments in electric lamp manufacture or for a change in the standard types and sizes of lamps in use on the railway having these fixtures already installed.

REMOVING SCALE FROM ARCH TUBES

In some districts where waters that contain heavy scale forming salts are used, considerable difficulty is found in removing the incrustation from the interior of the arch tubes. Owing to the high temperature and the rapid evaporation from this heating surface, it is desirable, from the standpoint of safety as well as efficiency, to keep it as clean as possible. Because of the bends

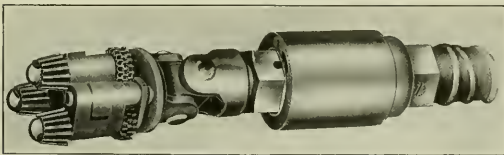

Device for Removing Scale from Arch Tubes.

in the pipe it is necessary to have a flexible arrangement for a cleaner and if the scale is very hard, the ordinary type of cleaner is not efficient. A flue cleaner that is especially suited for this work has been designed by the Lagonda Manufacturing Company, Springfield, Ohio, and is shown in the illustration. It is

a turbine cleaner driven by an air or steam motor and has a very short head with a flexible tube connection so that it may be easily forced through the arch tube and will thoroughly clean it of all scale. It will be seen that the head contains revolving cutters and that it is connected to the tube by a universal joint. By its revolving motion the scale is scraped and chipped from the metal.

NON-KINKING AIR AND STEAM HOSE

An armored hose that will resist a crushing pressure of from 300 lbs. to 800 lbs. to each four turns of the spiral, depending on the size of the hose, and which is especially suited for shop air hose and hot water washing out hose in the roundhouse, is being made by the H. W. Johns-Manville Co., New York. It consists of a good grade of durable rubber hose protected against injury by a metal armor made in the form of a ribbon with crimped edges, forming, when wound, a continuous, interlocking flexible spiral, which is said to be practically pressure tight in itself. This spiral prevents any pulling strain coming on the

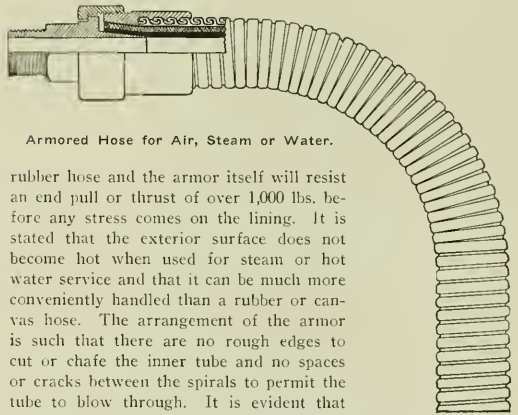

Armored Hose for Air, Steam or Water.

rubber hose and the armor itself will resist an end pull or thrust of over 1,000 lbs. before any stress comes on the lining. It is stated that the exterior surface does not become hot when used for steam or hot water service and that it can be much more conveniently handled than a rubber or canvas hose. The arrangement of the armor is such that there are no rough edges to cut or chafe the inner tube and no spaces or cracks between the spirals to permit the tube to blow through. It is evident that this armor will prevent any sharp bends or kinks and furthermore, that its smooth exterior surface will allow it to be handled with ease around the shop. The construction is such that when the inner tube does finally become worn out it can be renewed without the loss of the armored protection.

A special design of coupling of malleable iron or brass is furnished with each length of hose. This, as may be seen in the illustration, consists of three pieces, one threaded and riveted to the armor, the second the threaded connection and the internal nipple fitting inside the inner tube, and the third a binding nut which holds them together and wedges the nipple tightly against the inner walls of the lining. It is recommended that when used for washout and other roundhouse work the armor should be made of copper instead of steel.

BRAZILIAN SURVEYS APPROVED.—The president of the state of Sao Paulo, Brazil, has signed a decree approving the definite surveys of the first section of five miles of the line from Jaboticabal to Rio Pardo.

CEMENT IN RUSSIA.—The production of cement in Russia is developing rapidly, and new works are springing up and old works are extending their plants, notably around St. Petersburg and in the Baltic and South Russian districts. The result is that importers are feeling the effect of the home production very keenly. Although the price of the imported article has been lowered in order to combat Russian competition, this measure has so far been unsuccessful.—*The Engineer.*

PREST-O-WELDER

The Prest-O-Lite Company, Indianapolis, Ind., has recently placed on the market an oxy-acetylene portable welding outfit for general use in repair shops. Storage tanks of 100 cu. ft. capacity are furnished for each of the gases used. The whole equipment is mounted on a small steel truck as shown in the illustration which when fully assembled weighs 300 lbs. A temperature of 6,300 deg. F. may be obtained with this apparatus, which is considerably more than that required to melt any of the commercial metals. The acetylene is stored in a cold drawn seamless steel tank, and is dissolved in acetone in a porous filling inside the tank. It is fed through a regulating valve, which automatically maintains a constant flow of the gas. The oxygen is controlled by a regulating valve so that the heat of the flame may be maintained at the desired temperature. The welding points on the blowpipe are interchangeable,

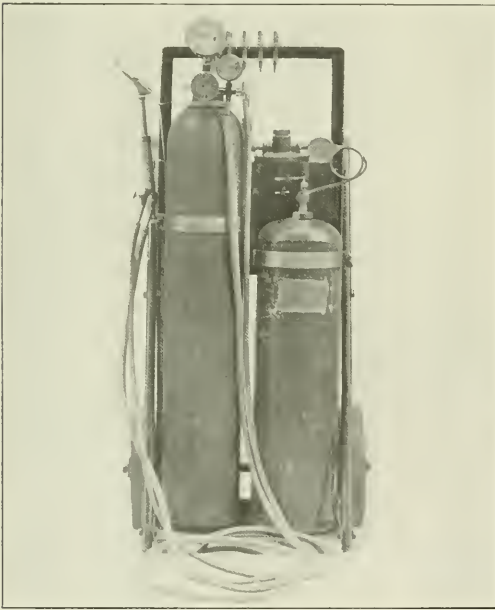

Oxy-Acetylene Welding Outfit.

and easily adapted for different sorts of materials and castings. The operation of this device is not difficult, and the ordinary workman may soon become proficient in all its uses. Cast iron, steel, brass, bronze or aluminum may be welded with it.

STEEL BOX CAR LADDER

An all-steel combination side and end ladder which includes roof grab irons, and is furnished in its complete form ready for bolting to the car, is being made by the Safety Steel Ladder Company, 810 Olive street, St. Louis, Mo. This ladder has rungs riveted to stiles made of bar steel and is held the proper distance from the car side by cast iron spools on the holding bolts. It requires no bolts in the roof and those in the sides are so spaced as to encounter solid members of the framing, eliminating all danger of bolts becoming loose or pulling through the siding. At the top, the stiles are bent over and down so that the ends rest on the roof or on the side running board in the

case of metal roof cars. The end stile of the side ladder is carried over and bolted to the extending end of the inside stile of the end ladder and in this way it forms the roof grab iron for the latter. A rung riveted across the extending stiles forms the grab iron for the side ladder. In the case of cars with steel roofs, the side running board is formed separately and secured only to the ends of the ladder, this fastening being by means

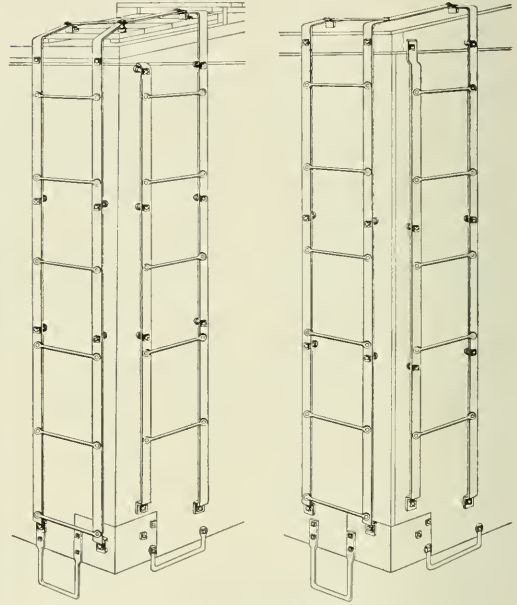

Combination Side and End Box Car Ladders.

of three bolts which are sufficient to properly hold it in place and do not require any perforation of the roof sheet. With wooden roof cars the ends of the stiles simply rest on top of the roof and depend on the fastening through the plate for security. While the sill steps are not shown as being a part of the ladder, in the illustration, they can be so formed if desired.

SULPHUR AND OXYGEN IN IRON AND STEEL.—A paper on this subject, read before the Scotch Branch of the British Foundrymen's Association, by Dr. C. H. Desch, showed, according to *The Engineer*, that the presence of the sulphur in iron was most deleterious to the metal when it existed in the form of iron sulphide, which, having a lower melting point than the iron, was able to encase the crystals in a very brittle mesh-work. With the addition of manganese, however, and the formation of a double sulphide iron and manganese, this was much less harmful, owing to its higher melting point. This property entailed its separation from the metal before the iron solidified. In the case of steel too much sulphide produced brittleness. The effect of oxygen was to produce oxides in steel, it being very infrequently met with in iron. The inclusions found in burnt metal were said to be capable of largely increasing the tendency of the metal to corrode rapidly, and similar defects were apt to be set up by welding. Silicates were also formed, and either alone or in conjunction with the sulphides, produced weakness in the metals containing them.

PROPOSED NEW YORK-NEW JERSEY BRIDGE.—The length of the proposed suspension bridge across the Hudson river at New York, would be 8,300 ft., and the estimated cost, \$42,000,000.

NEWS DEPARTMENT

The Central Safety Committee of the Chicago & North Western has awarded the company's "Safety" banner for the best record of safety for the year 1912 to the East Iowa division.

The Atchison, Topeka & Santa Fe is planning to build a very complete reproduction of the Grand Canyon of Arizona to be exhibited at the Panama-Pacific Exposition in San Francisco. The reproduction of the canyon will occupy five acres.

Officers of the Grand Trunk say that the increase in wages paid for organized labor for 1912 over 1911 amounts to \$750,000, and that the increases for other classes of employees will amount to very nearly an equal amount; bringing the total wage increases for the year up to nearly \$1,500,000.

The New York, New Haven & Hartford announces that since Mr. Mellen made his ten-thousand-dollar offer, published a few months ago, 1,574 automatic train stops have been presented to it; and that two of the devices submitted are going to be tried. The names of these two are not given, being withheld, evidently, for the purpose of breaking the news gently to the friends of the other 1,572.

The Rock Island Lines have purchased a roll of moving picture films on fuel economy from the International Railway Fuel Association, which is being used in connection with lectures to the engineers given by H. Clewer, superintendent of locomotive operation, at the principal points on the system. Bound proceedings of the 1912 convention of this association have also been furnished the master mechanics, road foremen of equipment and the supervisors of locomotive operation; and copies of D. C. Buell's paper on Fuel Economy, presented before the Fuel Association last year, have been distributed among the engine crews. The results obtained by Mr. Clewer and his staff of supervisors have been very encouraging.

FIREMEN'S ARBITRATION PROCEEDINGS

The arbitration of the firemen's wage controversy under the Erdman Act commenced at the Waldorf-Astoria hotel, New York, Monday, March 10. Under the terms of the act, a decision must be rendered within 30 days unless both sides agree to an extension of time. As the evidence will not be submitted in sufficient time to permit a decision being reached in the time allowed, the railroads and firemen agreed to an extension on March 26.

MEETINGS AND CONVENTIONS

General Foremen's Association.—The next convention of the International Railway General Foremen's Association will be held July 15-18, 1913, and not July 22-25, as announced in the March issue of the *American Engineer*.

Canadian Railway Club.—Following the examples of several other clubs during the past year the subject of safety was dis-

cussed at the March meeting. The paper was by N. S. Dunlop, claims adjuster, Eastern Lines, Canadian Pacific. It briefly pointed out the importance of the "Safety First" movement and was largely devoted to reviewing the causes of avoidable accidents.

Central Railway Club.—At the March meeting the report of the committee on revision of the M. C. B. rules of interchange was presented and discussed. Various recommendations were made for minor changes in a large number of the rules. These will be referred to a joint committee of all railway clubs, which will then report to the Arbitration Committee of the Master Car Builders' Association. In addition to this report, W. S. Sitterly, general car inspector of the Pennsylvania Railroad, gave a talk on the proper preparation of repair and defect cards.

American Society of Mechanical Engineers.—Arrangements have been perfected for the New York meeting which has been planned by the Railway Committee for the evening of April 8, when the subject of "Steel Passenger Cars" will be discussed. The members of the New York Railroad Club and of the Railway Club of Pittsburgh have been invited to join with the society on that evening. To allow for a thorough discussion the meeting will be opened at 8 o'clock sharp. The following engineers have consented to prepare ten minute discussions on the subjects which have been assigned to them, and about which they are particularly well posted. Several of these have already been received and are being printed for advance distribution. The following subjects will be considered: Introduction to General Discussion of Steel Passenger Cars, H. H. Vaughan, assistant to the vice-president, Canadian Pacific; Problems of Steel Car Design, W. F. Kiesel, Jr., assistant mechanical engineer, Pennsylvania Railroad; Steel Underframes, J. McE. Ames, American Car & Foundry Company; Roof Structure for Steel Cars, C. A. Seley, mechanical engineer, Rock Island Lines; Suspension of Steel Cars, E. W. Summers, president, Summers Steel Car Company; Trucks for Steel Passenger Cars, J. A. Pilcher, mechanical engineer, Norfolk & Western; Interior Finish for Steel Passenger Cars, Felix Koch, assistant mechanical engineer, Pressed Steel Car Company; Painting of Steel Passenger Cars, C. D. Young, engineer of tests, Pennsylvania Railroad; Provision for Electric Lighting in Steel Passenger Cars, H. A. Currie, assistant electrical engineer, New York Central & Hudson River; Provision for Electrical Equipment on Steel Motor Cars, F. W. Butt, assistant engineer, New York Central & Hudson River; Air Brakes for Heavy Steel Passenger Cars, A. L. Humphreys, vice-president and general manager, Westinghouse Air Brake Company; Cast Steel Double Body Bolster, Platform and Frames for Steel Cars, C. T. Westlake, chief mechanical engineer, Commonwealth Steel Company; Draft Gears for Steel Passenger Cars, S. P. Bush, Buckeye Steel Castings Company; Special Ends for Steel Passenger Cars, H. M. Estabrook, president, Barney & Smith Car Company.

RAILROAD CLUB MEETINGS

Club.	Next Meeting.	Title of Paper.	Author.	Secretary.	Address.
Canadian	April 8	System as Applied to Shop Repairs of Locomotives	A. H. Kendall	Jas. Powell	Room 13, Windsor Hotel, Montreal.
Central	May 9	The Signal Department	B. H. Mann	H. D. Vought	95 Liberty St., New York.
New England	April 8	Modern Air Brake Equipment for Steam Roads	Charles V. Jeys	Wm. E. Cade, Jr.	683 Atlantic Ave., Boston, Mass.
New York	April 18	German Railways	Prof. Wm. Cunningham	H. D. Vought	95 Liberty St., New York.
Pittsburgh	April 25	Operating Conditions and the Air Brake	W. V. Turner	I. B. Anderson	Union Station, Pittsburgh, Pa.
Richmond	April 14	A Trip Through the World's School House	I. F. Bartlett	F. O. Robinson	C. & O. Ry., Richmond, Va.
St. Louis	April 11	The Package Car	L. R. Cavanagh	E. W. Frauenthal	Union Station, St. Louis, Mo.
Western	April 15	Specifications	Bruce V. Crandall	Jos. W. Taylor	390 Old Colony Bldg., Chicago.

New York Railroad Club.—The annual electrical night was held on the evening of Friday, March 21; following the usual custom there was no paper prepared, but the meeting was addressed by several electrical experts on different phases of electricity as employed for heavy railroad traction. William McClellan reported, as chairman of the committee on this subject for the club, and his remarks were practically the keynote for the expression of the later speakers. He pointed out that the electrical engineers have greatly modified their expectations of a number of years ago and have come to the realization that there will be no general and complete electrification of steam railroads for many years to come. This is due largely to financial conditions. At present there is no new steam railroad electrification under way, although there have been several material extensions to the systems already in use. Within a short time there will be a considerable amount of new electrification undertaken. The two principal projects that have been settled are 204 miles on the Denver & Rio Grande, and 440 miles on the Chicago, Milwaukee & St. Paul. It was pointed out, however, that in both of these cases electrification was in mountain districts where power could be obtained very cheap. Mr. McClellan stated that there is no barrier to extensive electrification so far as the choice of the system to be used or the mechanical and electrical engineering features are concerned. It is assured that electric locomotives, transmission lines, power houses, etc., can be built to satisfy any existing condition. It appeared to make comparatively little difference in a general way as to which kind of current is employed. As an example of the effect of the financial features on the subject, the investigation of the Boston & Albany on electrification in the suburban district of Boston, was given, where it was conclusively shown that with the same rates of fares as at present and with a normal increase in traffic there would be a loss of \$500,000 a year in this district if the lines were to be electrified. E. B. Katte, chief engineer of electric traction of the New York Central & Hudson River, reported that the extension of the electric division to Croton, N. Y., was proceeding rapidly and that the suburban motor car trains were now being operated to that terminal. Within the next year all passenger trains will be operated electrically as far as Harmon, N. Y. The reliability of the electrical equipment was mentioned, and it was stated that locomotives operate on an average of 4,500 miles for each electrical attention, and the motor cars run 11,000 miles for each electrical attention. The cost of repairs to locomotives was reported as 3¼ cents a locomotive mile, and the motor cars as 1.8 cents a car mile. Other speakers included Frank J. Sprague, J. Mailloux and Frank Hedley.

The following list gives names of secretaries, dates of next or regular meetings, and places of meeting of mechanical associations.

- AIR BRAKE ASSOCIATION.**—F. M. Nellis, 53 State St., Boston, Mass. Convention, May 6-9, 1913, St. Louis, Mo.
- AMERICAN RAILWAY MASTER MECHANICS' ASSOC.**—J. W. Taylor, Old Colony building, Chicago. Convention, June 11-13, 1913, Atlantic City, N. J.
- AMERICAN RAILWAY TOOL FOREMEN'S ASSOCIATION.**—A. R. Jarvis, Central of Georgia, Macon, Ga. Convention, July 22-25, 1913, Chicago, Ill.
- AMERICAN SOCIETY FOR TESTING MATERIALS.**—Prof. E. M. Berg, University of Pennsylvania, Philadelphia, Pa. Annual convention on June, 1913.
- AMERICAN SOCIETY OF MECHANICAL ENGINEERS.**—Calvin W. Rice, 29 W. Thirty-ninth St., New York. Annual meeting, December 3-6, Engineering Societies' Building, New York. Railroad session, Thursday morning, December 5.
- CAR FOREMEN'S ASSOCIATION OF CHICAGO.**—Aron K'ine, 841 North Fiftieth Court, Chicago; 2d Monday in month, Chicago.
- INTERNATIONAL RAILWAY FUEL ASSOCIATION.**—C. G. Hall, McCormick building, Chicago. Convention, May, 1913, Chicago.
- INTERNATIONAL RAILWAY GENERAL FOREMEN'S ASSOCIATION.**—William Hall, 829 W. Broadway, Winona, Minn. Convention, July 15-18, 1913, Chicago, Ill.
- INTERNATIONAL RAILROAD MASTER BLACKSMITHS' ASSOCIATION.**—A. L. Woodworth, Lima, Ohio. Convention, August 18, 1913, Richmond, Va.
- MASTER BOILER MAKERS' ASSOCIATION.**—Harry D. Vought, 95 Liberty St., New York. Convention, May 26-29, 1913, Chicago.
- MASTER CAR BUILDERS' ASSOCIATION.**—J. W. Taylor, Old Colony building, Chicago. Convention, June 16-18, 1913, Atlantic City, N. J.
- MASTER CAR AND LOCOMOTIVE PAINTERS' ASSOC. OF U. S. AND CANADA.**—A. P. Dane, B. & M., Reading, Mass. Convention, Sept 9-12, 1913, Ottawa, Can.
- RAILWAY STOREKEEPERS' ASSOCIATION.**—J. P. Murphy, Box C, Collinwood, Ohio. Convention, May 19-21, 1913, Auditorium Hotel, Chicago, Ill.

PERSONALS

It is our desire to make these columns cover as completely as possible all the changes that take place in the mechanical departments of the railways of this country, and we shall gladly appreciate any assistance that our readers may give us in helping to bring this about.

GENERAL

L. A. RICHARDSON, master mechanic of the Rock Island Lines at Chicago, has been appointed mechanical superintendent of the third district at El Reno, Okla., succeeding C. M. Taylor, transferred.

C. M. TAYLOR, mechanical superintendent of the third district of the Rock Island Lines, at El Reno, Okla., has been appointed mechanical superintendent of the second district at Topeka, Kan., succeeding S. W. Mullinix, transferred.

G. W. SEIDEL, superintendent of shops of the Chicago, Rock Island & Pacific at Silvis, Ill., has been appointed superintendent of motive power of the Minneapolis & St. Louis, with headquarters at Minneapolis, Minn., succeeding C. E. Gossett, general master mechanic, deceased.

GEORGE McCORMICK, whose appointment as assistant general manager (mechanical) of the Sunset-Central Lines of the Southern Pacific, with headquarters at Houston, Tex., was announced in the March issue of the *American Engineer*,



George McCormick.

was born July 15, 1872, at Columbus, Colorado county, Tex. He was graduated from the Agricultural and Mechanical College at Bryan, Tex., with the degree of Mechanical Engineer, in 1891. He began railway work in 1891 as apprentice in the shops of the Galveston, Harrisburg & San Antonio at Houston, Tex. In a short time he was transferred to San Antonio, Tex., as draftsman, returning to Houston in 1895 as chief draftsman. He was appointed mechanical engineer in 1900, where he remained until December 20, 1911, when he went to El Paso, Tex., as assistant superintendent of the El Paso division. He held the latter position until his appointment on February 17 as assistant general manager (mechanical) of all the Sunset-Central Lines.

NICHOLAS LUKE SMITHAN, whose appointment as assistant superintendent of motive power of the Missouri, Kansas & Texas Railway of Texas, with headquarters at Denison, Tex., was announced in the March issue of the *American Engineer*, was born in December, 1862, at Cornwall, England. He was educated in the public schools of Hazleton, Pa., and began railway work in 1877 as boilermaker apprentice with the Lehigh Valley. In the latter part of 1881 he went with the Colorado Iron Works at Denver, Colo., as boilermaker, remaining there a year, and then until the latter part of 1883 was with the Denver & South Park Railway as boilermaker. From that time until December, 1884, he was employed by the Denver & Rio Grande in a similar capacity, leaving to go to the Houston & Texas Central at Houston, Tex. In March, 1885, he was transferred to Walnut Springs, Tex., as general foreman in charge of boiler work.

He was made general foreman of the Texas Midland at Terrell, Tex., in 1893, and two years later was promoted to master mechanic, resigning in January, 1901, to become master mechanic of the Texas Central at Walnut Springs, Tex. He then returned to the Texas Midland as master mechanic, and nine months later again entered the service of the Texas Central as master mechanic, which position he held until his recent appointment as assistant superintendent of motive power.

MASTER MECHANICS AND ROAD FOREMEN OF ENGINES

T. S. UNDERWOOD, general foreman of the St. Louis & San Francisco, at Monett, Mo., has been appointed master mechanic, at Paris, Tex.

H. W. CULVER has been appointed road foreman of engines of the Canadian Northern, at Winnipeg, Man., succeeding J. A. Carroll, transferred.

J. C. RHODES, road foreman of equipment at Trenton, Mo., has been appointed master mechanic of the Dakota division of the Chicago, Rock Island & Pacific, with headquarters at Estherville, Ia.

N. C. BETTENBERG, locomotive foreman of the Great Northern at St. Paul, Minn., has been appointed master mechanic, with headquarters at Crookston, Minn., succeeding J. W. Smith, transferred to Duluth, Minn.

G. W. WHITELEY, district master mechanic of the Canadian Pacific, at Moose Jaw, Sask., has been appointed master mechanic of the Alberta division, with headquarters at Calgary, Alta., succeeding A. T. Shortt, promoted.

E. J. HARRIS, master mechanic of the Kansas City Terminal division at Armourdale, Kan., has been appointed master mechanic of the Missouri division of the Chicago, Rock Island & Pacific, with headquarters at Trenton, Mo.

R. L. STEWART, master mechanic of the Missouri division of the Chicago, Rock Island & Pacific at Trenton, Mo., has been appointed master mechanic of the Chicago Terminal and Illinois divisions, with headquarters at Chicago, in place of L. A. Richardson, promoted.

R. Q. PRENDERGAST, whose appointment as master mechanic of the Indianapolis division of the Cincinnati, Hamilton & Dayton, with headquarters at Indianapolis, Ind., was announced in the March issue of the *American Engineer*, began railway work as a machinist apprentice with the Baltimore & Ohio at Benwood, W. Va. After completing his apprenticeship he was made foreman at Cameron, W. Va., and subsequently was transferred to several of the large shops on the Baltimore & Ohio system, including the position of erecting shop foreman of the Mt. Clare shops. He left the Baltimore & Ohio to go to the Cumberland Valley at Chambersburg, Pa., and later became general foreman of the Delaware & Hudson at Carbondale, Pa. He resigned about five years ago to accept the position of master mechanic of the Denver & Rio Grande, at Pueblo, Colo., which he held until his recent appointment.

CAR DEPARTMENT

R. J. BANNON has been appointed car foreman of the Louisiana division of the Chicago, Rock Island & Pacific, at El Dorado, Ark.

A. R. JAY has been appointed foreman of the heavy repair yard of the Pennsylvania Lines West of Pittsburgh, at Conway, Pa., succeeding Charles Buss, transferred.

CHARLES BUSS, foreman of the heavy repair yard of the Pennsylvania Lines West of Pittsburgh, at Conway, Pa., has been transferred to Allegheny as foreman of freight car builders.

SHOP AND ENGINE HOUSE

C. BAKER has been appointed locomotive foreman of the Canadian Pacific at Outlook, Sask.

ROBERT F. BRUMBACH has been appointed foreman of the Houston & Texas Central at Hearne, Tex.

A. E. BENNETT has been appointed locomotive foreman of the Canadian Pacific at Grand Forks, B. C.

THOMAS GORDON has been appointed roundhouse foreman of the Rock Island Lines at Valley Junction, Ia.

C. W. WARcup has been appointed night roundhouse foreman of the Rock Island Lines, at Rock Island, Ill.

L. FENSTUMAKER has been appointed foreman of the boiler shop of the Erie railroad, at Galion, Ohio, succeeding John Meyers.

M. L. CRAWFORD, general foreman of the St. Louis & San Francisco, at Fort Smith, Ark., has been transferred to Monett, Mo.

W. G. REID has been appointed general foreman of the Globe shops of the Arizona Eastern, succeeding Max Fiedler, promoted.

C. J. DRURY has been appointed general foreman of the St. Louis & San Francisco at Fort Smith, Ark., succeeding M. L. Crawford, transferred.

F. CLARK has been appointed locomotive foreman of the Canadian Northern, at Radville, Sask., succeeding R. H. Mann, assigned to other duties.

H. D. VAN VALIN has been appointed foreman of the locomotive department of the Chicago, Rock Island & Pacific, at Forty-seventh street, Chicago, Ill.

A. T. SHORTT, master mechanic of the Alberta division of the Canadian Pacific, at Calgary, Alta., has been appointed superintendent of the Ogden shops, Calgary.

H. B. MINNICK has been appointed assistant machine shop foreman of the Lake Shore & Michigan Southern, at Collinwood, Ohio, succeeding W. C. Cruwell, promoted.

W. C. CRUWELL, assistant machine shop foreman of the Lake Shore & Michigan Southern, at Collinwood, Ohio, has been appointed machine shop foreman, succeeding I. C. Newmarch, promoted.

S. W. MULLINIX, mechanical superintendent of the second district of the Rock Island Lines, at Topeka, Kan., has been appointed superintendent of shops at Silvis, Ill., succeeding G. W. Seidel, resigned.

R. H. MONTGOMERY, general foreman of the locomotive shops of the Lake Shore & Michigan Southern, at Collinwood, Ohio, has been appointed superintendent of shops, succeeding B. F. Kuhn, promoted.

I. C. NEWMARCH, machine shop foreman of the Lake Shore & Michigan Southern, at Collinwood, Ohio, has been appointed general foreman of the locomotive shops, succeeding R. H. Montgomery, promoted.

PURCHASING AND STOREKEEPING

A. F. McCool, chief clerk to the purchasing agent of the St. Louis & San Francisco at St. Louis, Mo., has been appointed assistant purchasing agent of the south Texas and Louisiana lines, with headquarters at Houston, Tex., succeeding J. L. White, resigned.

E. B. DAILEY, assistant mechanical engineer of the Union Pacific at Omaha, Neb., and H. B. Henry, who has been in the office of the director of maintenance and operation of the Harriman Lines at New York, have been appointed assistants to the director of purchases of the Southern Pacific Company, both with offices at New York.

NEW SHOPS

CANADIAN PACIFIC.—A concrete machine shop will be built at McAdam Junction, N. B.

LOUISVILLE & NASHVILLE.—Plans are being prepared for repair shops at Lexington, Ky.

GULF, COLORADO & SANTA FE.—It is planned to enlarge the capacity of the roundhouse at Slaton, Tex.

OREGON SHORT LINE.—This company is said to be planning the erection of a large addition to its shops at Ogden, Utah.

DULUTH, SOUTH SHORE & ATLANTIC.—This company is preparing to build a new 15-stall roundhouse at Marquette, Mich.

GRAND TRUNK.—It is reported that a new roundhouse and shops will be erected at Hamilton, Ont. This item is not confirmed.

CHICAGO, ROCK ISLAND & PACIFIC.—This company has announced that appropriations have been made for the enlargement of its shops at Fairbury, Neb.

CHICAGO, ROCK ISLAND & PACIFIC.—This company will spend \$500,000 this year, it is said, building new terminals, shops and roundhouses at St. Paul, Minn.

MISSOURI, OKLAHOMA & GULF.—This company has let contracts for the erection of new shops and other improvements at Muskogee, Okla., to cost about \$250,000.

MISSOURI & NORTH ARKANSAS.—This company will construct general shops and terminals at Harrison, Ark., at a cost of \$125,000, and a roundhouse at Heber Springs, Ark.

LAKE SHORE & MICHIGAN SOUTHERN.—Land has been purchased at Ashtabula, Ohio, on which repair shops will be built for steel cars. The plant and land will cost about \$1,000,000.

TEXAS & NEW ORLEANS.—Work has been started on the construction of a new blacksmith and boiler shop building of reinforced concrete construction, 314 ft. x 120 ft., at Houston, Tex.

BUFFALO, ROCHESTER & PITTSBURGH.—Changes are to be made at the shops at Du Bois, Pa., which will double their present capacity. A building, 35 ft. x 70 ft., for the reclaiming of scrap, will be erected and a steel car shop, 192 ft. x 400 ft. is under consideration.

FUEL OIL IN ROUMANIA.—A few locomotives were converted into oil burners as long ago as 1887. In 1911, out of a total of 595 locomotives, 499 used oil for fuel. About five-eighths of the fuel is petroleum, one-eighth is coal from Cardiff and Westphalia, more than a seventh lignite, and one-tenth wood.—*The Engineer.*

ARGENTINE RAILWAY CONCESSIONS.—The Argentine Director General of Railways is drafting a bill dealing with the conditions to be fulfilled by applicants for railway concessions. The object is to put a stop to acquiring concessions which will never be carried out and are obtained for speculative purposes, either by endeavoring to sell to an existing railway company whose zone has been invaded or for land speculation.

LAW AGAINST STEALING FROM CARS.—One of the measures recently passed by Congress makes it a felony to break the seal of a railroad car containing interstate or foreign shipments of freight, express, or baggage, or to enter such a car with intent to steal, or to steal, conceal, or by fraud or deception obtain from any railroad car, station house, depot or platform any goods or chattels which are part of an interstate or foreign shipment of freight, express, or baggage.

SUPPLY TRADE NOTES

Edgar N. Easton is now associated with the railroad sales department of Joseph T. Ryerson & Son, with headquarters at New Haven, Conn.

R. C. Fraser, representative of the Buffalo Brake Beam Company, has been made vice-president of the company, with headquarters at 30 Pine street, New York.

C. J. Morrison has resigned his position with Suffern & Son, and with others has organized Froggatt, Morrison & Company, 149 Broadway, New York, efficiency engineers.

The Kerr Turbine Company, Wellsville, N. Y., manufacturers of the Economy steam turbine, have appointed F. A. Mazzur & Co., 141 Milk street, Boston, as their New England representatives.

John H. Craigie, formerly with the mechanical department of the Boston & Maine, is now associated with the railroad sales department of Joseph T. Ryerson & Son, with headquarters at Boston, Mass.

Abram Lucas, general foreman of the locomotive department of the Chicago, Milwaukee & St. Paul, with office at Milwaukee, Wis., has resigned to go to the Jacobs-Shupert U. S. Fire Box Company, Coatesville, Pa., with office at Chicago.

H. F. BALL has been elected president of the Economy Devices Corporation, 30 Church street, New York, which has taken over the business of the Radial Buffer Company, the

the latter company having been dissolved.

Among the devices which will be marketed by the new company is the radial engine and tender buffer which was described in the September, 1912, *American Engineer*, page 489. Mr. Ball entered the service of the Pennsylvania Railroad as an apprentice at Altoona, Pa., in 1884.

Four years later he entered the drafting room at Altoona, and in 1890 was appointed chief draftsman of the car department of the Lake Shore & Michigan Southern. Two years later he was placed in

charge of the car shops at Cleveland, as general foreman, and in 1894 was appointed general car inspector. Five years later he was made mechanical engineer of the Lake Shore, which position he held until his promotion to the position of superintendent of motive power in February, 1902. In 1906 he left the Lake Shore to accept the vice-presidency of the American Locomotive Automobile Company; a few months later his jurisdiction was extended over the American Locomotive Company, as vice-president of engineering. In December, 1912, he left the American Locomotive Company to open an office as a special consulting engineer. Mr. Ball was president of the Central Railway Club in 1900, and of the American Railway Master Mechanics Association in 1905-6.

The Pedrick Tool & Machine Company, 3640 N. Lawrence street, Philadelphia, Pa., has been formed by A. D. Pedrick and H. A. Pedrick, who have recently resigned from the firm of H. B. Underwood & Co. The new company will make and



H. F. Ball.

sell the Pedrick portable tools, including cylinder boring bars, cylinder and dome facers, crank pin turning machines, driving box planer tools, pipe benders, milling machines, radius planing attachments, and valve seat rotary planers. D. W. Pedrick has also resigned from H. B. Underwood & Co.

Burton W. Mudge & Co., Chicago, have been made agents for the Industrial Works, Bay City, Mich. This company will handle the products of the Industrial Works, including wrecking, locomotive and freight station cranes, pile drivers, transfer tables and grab buckets.

H. B. Underwood & Company, Philadelphia, Pa., have announced a change in partnership, Morris G. Condon having purchased his partners' interests. There are now associated with him in the company David C. Hitchner, Hiram D. Griffith and Charles O. Ralph.

The Meeker Grip Nut Company, 1170 Broadway, New York, has just been formed to make and sell Meeker grip nuts. The officers of the company are as follows: President, Fred J. Lancaster; vice-president, Walter Schulze; and secretary and treasurer, Samuel G. Meeker. George Owens has been made manager of the sales department.

GEORGE M. BASFORD

George M. Basford, assistant to the president of the American Locomotive Company, has resigned to accept a position as chief engineer of the railroad department of Joseph T. Ryerson & Son, Chicago, with headquarters at 30 Church street, New York. Mr. Basford was graduated from the Massachusetts Institute of Technology in 1889. Directly afterwards he entered



George M. Basford.

the Charlestown shops of the Boston & Maine, later going to the Chicago, Burlington & Quincy as a draftsman at Aurora, Ill. From there he went to Omaha, Neb., to take a position in the motive power department of the Union Pacific, and was also for some time connected with the test department of that road. Leaving the motive power department service he became signal engineer of the Chicago, Milwaukee & St. Paul, after which he was superintendent of construction of the Johnson Railway Signal Company, was for a short time

with the Union Switch & Signal Company, and was signal engineer of the Hall Signal Company. In 1895 he left signal work to become mechanical department editor of the *Railway & Engineering Review*, and in 1897 was made editor of the *American Engineer & Railroad Journal*. In September, 1905, he accepted a position with the American Locomotive Company as assistant to the president, which position he now leaves to enter the service of the Ryerson company.

For a number of years, 1897 to 1905, Mr. Basford was editor of this journal, and it is with great pleasure that we reproduce the following account of his past work, which appeared in the *Railway Age Gazette* of March 14, 1913:

"Mr. Basford is the father of the Railway Signal Association. Shortly after taking up editorial work in Chicago he called together a number of those interested in signaling, to consider the formation of a Railway Signaling Club, which later de-

veloped into the national association. For the first two years, 1895 and 1896, he was secretary-treasurer of the organization and a most active factor in its upbuilding.

"Few men associated with the railway interests can number so many friends—real friends—as can Mr. Basford. And this he richly deserves, for he has been untiring in aiding others, either with advice or by helping them to better their condition. He has an unerring engineering instinct, which enables him to discard those things which are superficial and quickly get at the heart of a problem. It was this instinct, coupled with an extensive experience, and with his splendid character which made him such a power as an editor—for many years the *American Engineer* was informally designated as "Basford's paper," and still is by some, although it is seven and a half years since he left it. And when we recall that for a considerable part of his eight or nine years' work on that paper he had no editorial assistant, no stenographer, and that the office was not equipped with a telephone, we marvel at the powerful influence he was able to exert through its pages in securing a more fitting recognition of the real importance of the motive power department in the railway organization.

"In the fall of 1903 Mr. Basford was in receipt of a signal honor, the like of which has never been conferred upon a man in the railway or railway supply field before or since. In a quiet way fifty-eight of the railway and railway supply men who were known to be close personal friends of Mr. Basford's, joined together and presented him with a volume of personal letters expressing their appreciation of him, and accompanied by a substantial check to defray the expenses of a trip abroad. The following is taken from an informal presentation address made by W. S. Morris, who was then with the Erie Railroad: 'The gentlemen around you are not only your personal friends, but they are here to represent a host of admirers, whom you can with pride claim also as friends. We are here to tender not only our admiration of the efforts God has infused within your character and ambition, and to thank you in behalf of the many who have been instructed and benefited by your industry and faithfulness to the science through which we all claim kin to one another. In all probabilities this is the first time in the history of this generation, at least, that one has been so honored by the mechanical fraternity of this country, and we assure you it is extended with every thought of true manliness and absolute worthiness on the part of him to whom these words are addressed. To be plain, Mr. Basford, your friends feel that you have well earned some token of recognition at their hands, and we beg that you will accept this volume, which contains the sentiment, individually, of those whom the gentlemen here present have the honor to represent, and this, which is intended to give you a much needed rest in the way of an extended trip to Europe; and, also, although perhaps selfishly, we hope you may find some time to tell us of your travels and give some hints of interest which may be found on the other side.'

"Mr. Basford is widely known because of the impetus he gave to the development of the movement for educating and training apprentices and workmen, for he had a keen realization of the fact that the most vital problem confronting the railways is that of men. In 1905, after he had given several years of careful study to the situation he presented a paper before the Railway Master Mechanics' Association on 'The Technical Education of Railroad Employees—The Men of the Future.' The principles which he outlined in this paper attracted wide attention, not only in the railroad field but in the industrial world as well, and were taken as the foundation of such modern apprenticeship systems as those on the New York Central Lines and the Atchison, Topeka & Santa Fe. And it may be said at this date, almost eight years after the presentation of the paper, that apprenticeship systems on the railways have proved successful in so far as they have followed the fundamental principles laid down in Mr. Basford's address. The

preparation of this paper might well be studied by young men who are ambitious to make their efforts felt in the railway field, and it affords a marked contrast to some of the papers and reports which are often presented before railway clubs and technical associations. It was the result of years of study of conditions on the railroads in this country and a practical experience in mechanical department work. Foreign methods had been carefully looked over on his trip abroad and then the whole scheme was carefully planned and outlined. The paper was then drafted roughly and was rewritten and rewritten until every sentence was carefully rounded out and every superfluous word removed, so that the thought was clear and forceful throughout. It was then submitted for criticism to a number of leading railway officers and industrial managers, and their comments were carefully considered in its revision, although it may truthfully be said that such revision as was made was very slight indeed. And dominating it all was a broad spirit of fellowship for his fellow man, which is so characteristic of Mr. Basford. It is little wonder that it marked the real corner-stone of railway apprenticeship education in this country, and it is to be regretted that more railroads have not adopted and lived up to its spirit.

"It would be hard to comment intelligently upon Mr. Basford's work as assistant to the president of the American Locomotive Company, for necessarily a large part of it was in special assignments and would be very little known outside of the officers of the company. Of one definite duty, however, which was assigned to him during the entire time of his association with that company we may speak authoritatively, and that is the matter of publicity. Many years ago when an editor Mr. Basford said that the day would come when the advertising pages of the railway technical papers would be read first, for the advertiser when he awakened to the real possibilities of advertising would have a distinct advantage over the editors, because he could display his data to so much better advantage, not being tied down to the standards of typography that the editor must observe; and to Mr. Basford belongs the honor of being the first to consistently make such use of the advertising pages as to secure the close attention of railway officers and indeed to make many of them tear out and preserve the ads. of his company, so valuable was the information presented therein. Most of our readers are familiar with this work. The campaign was carefully planned and developed, just as the editor of a paper would plan and develop his editorial policy, and was based upon supplying to the railways information which they greatly needed, and presented in such a way as to make railway men read it and feel its forcefulness. This feature, which was quickly observed by other companies, is being adopted by many of them and has brought about a new era of publicity in the railway field.

"During the winter of 1908-9 while the Railway Business Association was in its early stages of development an arrangement was made with the American Locomotive Company whereby Mr. Basford gave part of his time to the work of that association. That his efforts were fruitful is indicated by the following paragraph in a letter written by George A. Post, president of the association (a copy of which Mr. Post has kindly furnished us) when it became necessary for Mr. Basford to withdraw from active personal participation in the work, because of the pressing demands of his duties with the American Locomotive Company: 'Whatever may be the ultimate verdict as to the usefulness and necessity for this association, there can be but one judgment of what you did in an emergent situation, when you brought to it the vigor of your push and industry, the good cheer of your persuasive personality and the impetus of your alert and fecund mentality. To work with you has been an unalloyed pleasure; to confer with you has been to draw inspiration, and to part with your services is a distinct loss which I shall constantly deplore. If, in carrying the burdens developing upon me in this work, no other dividend of the

like were mine than that afforded by the opportunity to feel that I am heart-bitched to George Basford thereby, I shall always feel that the Railway Business Association did a splendid thing for me.'

"Mr. Basford's hobby has always been the locomotive, and his efforts in its development were recently summed up by one of his friends as follows: 'He has persistently striven to impress upon every one connected with the work, both through his paper and through his personal contact, with a possibility of improving locomotive practice by rational and progressive engineering methods, and is largely responsible for the improvement that has taken place not only in the general design of the locomotive, but also in the improvement in the construction of its various parts which has so largely increased its efficiency and economy in operation. The care which Mr. Basford took in carrying out the experiments on locomotive front ends and nozzles, which led to the completion of these experiments by the Master Mechanics' Association, is only one example of his endeavors to place the design of the locomotive on a thoroughly sound foundation. The success of these experiments was no doubt a strong factor in the adoption of the locomotive testing plant, and the knowledge we now possess as to what engines are actually doing, and what results can be obtained from them. Not only in locomotive design, but in shop practice and road work generally, Mr. Basford has energetically encouraged his friends and acquaintances, including all the important mechanical men in the country, to continually improve their results. I do not think you will make any mistake in crediting him with a large share of the development in the last fifteen years.'

"Possibly this sketch might well be closed with the following brief summation of his personality by another one of his friends: 'He has a clear conception of mechanical and operating needs. A way of keeping himself in the background and furnishing his numerous friends with good ideas from his generous store. Taking great pleasure in the advancement of young men and helpful to all with whom he comes in contact.'

The Equipment Improvement Company, 30 Church street, New York, has been organized to handle the Markel devices for locomotives and the Perfection door stop. The directors of the company are as follows: Alexander Turner, Bronze Metal Company, New York; R. H. Weatherly, Pilliod Company, New York; Le Grand Parish, American Arch Company, New York; F. H. Clark, Watson-Stillman Company, Ampere, N. J.; T. H. Hopkirk, American Steel Foundries, New York; T. Rumney, formerly assistant second vice-president of the Chicago, Rock Island & Pacific; and P. H. Ferguson, Pittsburgh Steel Products Company, Pittsburgh, Pa. The officers are as follows: President, F. H. Clark; vice-president, W. E. Weatherly; and secretary-treasurer, R. H. Weatherly. In the near future the company will handle other devices in addition to those mentioned above.

W. H. Foster has resigned as master mechanic of the Hudson division of the New York Central & Hudson River, to accept a position with the Ashton Valve Company, as representative in the railroad department, with headquarters in New York. Mr. Foster was born June 29, 1873, and entered railway service in June, 1889. After considerable experience in shop work, and as fireman and locomotive engineer, he became air brake instructor for the American Magazine Company, and later became connected in the same capacity with the International Correspondence Schools. In February, 1902, he was appointed supervisor of air brakes for the New York Central, and in 1907 his jurisdiction was extended over the Boston & Albany, which placed him in charge of air brake instruction on all divisions of the New York Central lines east of Buffalo. On January 1, 1908, he was promoted to master mechanic.

AMERICAN ENGINEER

"THE RAILWAY MECHANICAL MONTHLY"

(Including the *Railway Age Gazette* "Shop Edition.")

PUBLISHED ON THE FIRST THURSDAY OF EVERY MONTH, BY THE
SIMMONS-BOARDMAN PUBLISHING COMPANY,
WOOLWORTH BLDG., NEW YORK, N. Y.

CHICAGO: Transportation Bldg. CLEVELAND: Citizen's Bldg.
LONDON: Queen Anne's Chambers, Westminster.

EDWARD A. SIMMONS, *President* HENRY LEE, *Secretary*.
L. E. SHERMAN, *Vice-President*. A. E. HOOVEN, *Business Manager*.
The address of the company is the address of the officers.

ROY V. WRIGHT, *Editor*. R. E. THAYER, *Associate Editor*.
E. A. AVERILL, *Managing Editor*. A. C. LOUDON, *Associate Editor*.
GEORGE L. FOWLER, *Associate Editor*.

Subscriptions, including the eight daily editions of the *Railway Age Gazette* published in June in connection with the annual conventions of the *Master Car Builders* and *American Railway Master Mechanics*' associations, payable in advance and postage free:

United States, Canada and Mexico.....\$2.00 a year
Foreign Countries (excepting daily editions)..... 3.00 a year
Single Copy 20 cents

Entered at the Post Office at New York, N. Y., as mail matter of the second class.

WE GUARANTEE, that of this issue 4,050 copies were printed; that of those 4,050 copies, 3,666 were mailed to regular paid subscribers and 125 were provided for counter and news companies' sales; that the total copies printed this year to date were 24,226—an average of 4,£45 copies a month.

VOLUME 87. MAY, 1913. NUMBER 5.

CONTENTS

EDITORIALS:	
June Dailies for Foreign Subscribers.....	227
Ratio of Compound Cylinders.....	227
Water Glass Shields.....	227
Larger Locomotive Cylinders.....	228
Lake Shore Mikados.....	228
Steel Passenger Cars.....	228
Saving Time in the Drawing Office.....	229
Modern Locomotive Practice.....	230
New Books.....	230
GENERAL:	
Large Mikados for the Lake Shore.....	231
Tests of Smoke Abatement Devices.....	236
Distribution of Power in Mallets.....	237
Locomotive Cab Furnishings.....	241
SHOP PRACTICE:	
Selection of Operators for Oxy-Acetylene Welding.....	243
Repairing Injectors.....	243
Portable Rivet Heater.....	244
Painting Steel Passenger Cars.....	245
Pneumatic Chuck for Staybolt Drilling.....	247
Diagram of Machine Tool Operation.....	248
Apprenticeship on the Illinois Central.....	249
Machine for Drilling Tell-Tale Holes in Staybolts.....	252
Welding Oil Cups on Rod Straps.....	253
Small Face Plate for Air Brake Work.....	253
Shop Kinks.....	253
CAR DEPARTMENT:	
Box Car Construction, as Viewed by a Repairer.....	255
Portable Rivet Heater.....	255
Steel Passenger Car Design.....	257
Mine Rescue Car.....	263
Refrigerator Cars for the Union Pacific.....	263
Care and Maintenance of Air Brakes.....	265
Car Brass Boring Machine.....	266
Freight Car Troubles.....	266
Babbitting Car Journal Brasses.....	267
Freight Car Design.....	268
NEW DEVICES:	
Reversing Motor Planer Drive.....	269
Gasoline Cars for the Holton Interurban.....	270
Mandrel for Sectional Tube Expanders.....	271
Hydraulic Pit Jack.....	271
Duplex Spring Clips for Tracing Files.....	271
Heavy Engine Lathe.....	272
Improved Type of Corrugated Tubes.....	273
Oilstone Tool Grinder.....	273
Engine and Tender Coupler.....	274
NEWS DEPARTMENT:	
Notes.....	275
Meetings and Conventions.....	277
Personals.....	278
New Shops.....	279
Supply Trade Notes.....	280

June Dailies for Foreign Subscribers

Since the *American Engineer* has been enlarged and combined with the Shop Section of the *Railway Age Gazette*, it has been the practice to furnish the subscribers in America with copies of the eight *Daily Railway Age Gazettes*, issued during the Master Mechanics' and Master Car Builders' conventions during June. This has obviated the necessity of publishing a report of these conventions in the July number of the *American Engineer*. It was felt that the foreign subscribers to the *American Engineer* would not be specially interested in the *Dailies* and because of the additional expense involved they were not sent to them last year. It is the purpose to follow the same practice this year, although we shall be glad to furnish the *Dailies* to any of the foreign subscribers that express a desire to have them.

Ratio of Compound Cylinders

In most locomotives of the Mallet articulated type, it is desired to have the same amount of power delivered to both groups of wheels, and great care is given to so distribute the weight that the amount on each group will be the same. Long experience with two-cylinder compound engines has settled approximately the correct ratio of the area of the high to the low pressure cylinders. The same basis has been used for Mallet locomotives and a ratio from 2.4 to 2.5 has been accepted as good practice. In cases, however, where there are different numbers of drivers in the two groups, as has occurred on a few designs in this country, the designer is in a practically unknown and uncharted region. Furthermore it is sometimes possible to obtain a much more satisfactory design if an unequal distribution of weight on the two groups is allowed, even if there are the same number of wheels in each.

The first discussion of this interesting and important phase of the design of the Mallet locomotive to appear, in this country at least, is given on page 237 of this issue, under the heading of "Distribution of Power in Mallets," by Paul Weeks. Mr. Weeks has studied this subject most thoroughly, and has had an opportunity to experiment and prove the correctness of his contentions in practice. He points out exactly how the correct proportion of cylinders can be obtained under any condition of weight distribution and develops a new formula for giving the tractive effort of Mallet compound locomotives which is applicable to all cylinder proportions.

Water Glass Shields

An interesting detail in connection with the Lake Shore & Michigan Southern Mikados, which are described elsewhere in this issue, is the water glass shield. According to the report of the chief inspector of locomotive boilers for the year ending June 30, 1912, there were 165 accidents because of burst water glasses, resulting in one fatality and 168 injuries; there were also eight accidents because of defective water glass cocks and appurtenances. The accidents chargeable to the burst water glasses may be divided into two general classes—flying glass, and those due to scalding from the escaping steam and hot water. A shield made of wire netting—and these have been extensively used in the past—will not stop the finer particles of flying glass unless the mesh is very fine, in which case it is difficult and almost impossible to see the water level in the glass. Moreover the wire netting shields do not protect the enginemen from injury from the escaping steam and hot water. For this reason the government authorities have discouraged its use.

A general type of shield, which has met with much favor, has been that with a case fitted with slabs of heavy glass, arranged so that the water glass may be observed through them by either the engineer or fireman from the positions usually occupied by them in their work. There are several classes of this type of shield. An objection to some of the earlier forms was

that although injuries due to flying glass were eliminated, the shields were open at the bottom so that the escaping hot water would scald the firemen when in the act of shutting off the lower water glass cock. To remedy this difficulty the shields were closed at the bottom and opened at the back, so that the escaping water would be deflected against the boiler head. These are more satisfactory, but where the holes for the escaping water are not made sufficiently large the pressure due to the bursting of the tubular glass causes the heavy glass in the shield to break or crack. The new shield on the Lake Shore overcomes these difficulties by providing a discharge pipe to carry the water downward out of the cab and is of a sufficient size to prevent any possibility of the heavy glass in the shield being broken when the tubular glass bursts.

Larger Locomotive Cylinders

A 24 in. diameter cylinder requires a mean effective pressure equal to about 84 per cent. of that required by a 22 in. diameter cylinder when giving the same horse power at the same speed. A 23 in. diameter cylinder requires 92 per cent. of the mean effective pressure of the 22 in. diameter cylinder for the same horse power. In other words, a locomotive having 24 in. diameter cylinders will deliver the same horse power or tractive effort with a considerably shorter cut-off than the 22 in. diameter cylinder provided the port areas are of sufficient size to keep up the admission pressure equally well in both cases. Economy in steam consumption on the basis of pounds of steam per indicated horse power per hour, will increase proportionally to the point of cut-off, other things being equal. The shorter the cut-off the greater the economy. When using saturated steam a larger cylinder than actually necessary for the power is not advisable, as the increase in the condensing effect from its larger surface will largely overcome the gain made by the shorter cut-off and the longer expansion. On the other hand, with superheated steam this difficulty does not appear and there is no objection to using the larger cylinders if the clearance and weight limits will permit it. It has been found that with low speeds at very long cut-off there is no gain by superheating, and the indications are that the value of superheated steam increases with the shortening of the cut-off, although probably not at the same rate. All of these conditions point toward the advantage of using larger cylinders than have been considered proper heretofore. Another feature that should not be overlooked is the fact that less steam per stroke may permit the use of a smaller valve, and a smaller valve usually means a lighter one. An objection that immediately arises to the suggestion of increasing the size of the cylinders is the fact that it will make the engine slip more easily at starting, and this of course is true. Slipping, however, depends on both the admission pressure and the point of cut-off in the cylinder, and any troubles of this kind may be easily overcome by a partial opening of the throttle, thus reducing the admission pressure, or by shortening the cut-off somewhat. The former is probably the better practice. In starting an amount of power less than that required to slip the drivers must be used, and this power may be obtained as well from a large cylinder as from a smaller one.

Lake Shore Mikados

The new 2-8-2 type locomotives for the Lake Shore & Michigan Southern are interesting, not so much because of their very large size, as they have been nearly equaled in this respect by several previous designs, nor on account of their great power, as they are exceeded in this particular by others already in operation; but because of the design and arrangement of various detail features. For instance, vanadium alloy steel is used to a larger extent on this locomotive than any previous one with the possible exception of No. 50,000. It has been specified after a fairly long period

of experiment with the material, and the indications are that steel alloyed with vanadium is proving all that its champions expected. In this case it is used for the frames, axles, main rods, springs, piston rods and in the cylinders of all the locomotives, in addition to the valve motion parts of ten of them. There is, however, no apparent reduction of section or weight on any of these parts with the exception of the axles where, it is claimed, three of them are from $\frac{3}{4}$ in. to 1 in. less in diameter than would have been required with a heat treated carbon steel of the ordinary quality.

Very long driving boxes have been applied on the main axles for the first time in a locomotive of this type. Boxes of this kind have been experimentally used on a few very heavy passenger locomotives with considerable success. The main driving box of a locomotive wears much faster than the others and it has been found in the cases of passenger locomotives, at least, that these long boxes will about equalize the wear of all of the boxes on the locomotive. Causes that lead to increased wear also imply increased friction and a remedy for the former will also probably result in considerable decrease in the tendency toward heating with this box. A novelty is noted at this point in connection with carrying projections from the frame braces around the inside of the faces of the pedestal jaws and forming the seat for the shoes and wedges entirely on these extensions instead of half on the frame and half on the brace as has been the practice with the previous boxes of this width. From a maintenance standpoint the arrangement of the whole design at the main journals can excite but favorable comment.

An auxiliary lubricator which insures a positive and increased supply of oil to the cylinders when the throttle is open, an efficient shield around the water glass, permanent and rigid fastenings for the various pipes, and an arrangement whereby the fireman's hose for sprinkling down the coal is provided with cold water from the tank instead of hot water from the boiler, are among the other details that add to the interest in this design.

Steel Passenger Cars

While the steel passenger car expert can properly object that there was comparatively little of value to him in the thirteen papers presented at the Railway Session of the American Society of Mechanical Engineers on April 8; to railway motive power department men in general, as well as to the layman, there were matters of great interest and value brought out in this discussion. Summing up the meeting as a whole, the evidence is clear that, in the minds of the experts who prepared the papers, the all-steel passenger car is the preferable construction. A small amount of natural or artificial wood can be permitted on the interior finish, but the underframe, superstructure framing, exterior sheathing and moldings should be of steel. There were no definite recommendations made as to the value of the all center sill or the all side supported car. Advocates of both designs were heard, and it appears that both are in successful use. There was, however, a uniformity of opinion in favor of a very heavy and strong end construction for the body of the car. One of the speakers advocated, and described at some length, a design of vestibule which is built somewhat weaker than the car body structure, and is arranged to collapse in the case of a severe collision shock. The contention is that, in its destruction, it will absorb the momentum of the train and reduce the effect of the shock on the passengers, and, at the same time, protect the car body from damage. No objection was raised to this suggestion, although it is but fair to state, there was but little time given for the discussion of the papers. Those who care to present their views on any phase of the subject may submit them in writing and they will be published in the journal of the society. Another recommendation that was allowed to go

by default, because of lack of time for discussion, was that six-wheel truck frames should be of the built up, wrought steel design.

Possibly the paper that aroused the greatest amount of interest was the one by C. D. Young, on the painting of steel passenger cars, in which he described the method that has been in experimental use at the Altoona shops of the Pennsylvania, wherein the complete car is placed in an oven and subjected to a high temperature after receiving each coat of paint. This rapidly dries the paint and reduces the amount of time required for painting a steel passenger car by about ten days. When used in connection with a suitable mixture of paint and varnish, it is believed that this practice will produce a much more durable wearing surface on both the interior and exterior of the car. A liberal extract of this paper, including a description of the oven and the schedule for applying the different coats of paint to the car, is found on page 245 of this issue. On the Hudson & Manhattan Railway, where the cars are subjected to extreme ranges of temperature due to their combination surface and tunnel operation, a method of artificially drying the finish on the interior of the car by means of electric heating has been very successful. Approximately the same temperatures and methods are used as on the Pennsylvania, but as it is not necessary to maintain the same high and durable finish on the exterior that is required for steam railway practices, no special oven is employed. Special paint formulas had also to be developed by this company for this work.

Saving Time in the Drawing Office

While the waste of time and the consequent waste of money on railroads is not so great as some of the efficiency men would have us believe, there are a great many points where savings could be made by more careful planning and assigning of the work. For example, in the drawing office, there are many assignments to be made, some of them relating to work that is of great importance and requiring the thought and labor of possibly months; while others, although they may be of prime importance, require only a few hours or, at most, a few days to complete. If the man in charge of the drawing office familiarizes himself with the general run of work to be handled, he can develop a plan of assignment that will permit of a minimum of time being lost in shifting from one job to another.

This is a matter that needs more consideration in many drawing offices. It is not uncommon to find a draftsman who has an important piece of designing in hand, called upon to do some minor work every few days. This breaks in on his calculations and on his trend of thought; he loses time in changing to the new work and in changing back again and finding just where he left off. As long as railroad requirements remain what they are, it will not be possible to eliminate such losses entirely. There will always be times when the general manager or the superintendent of motive power wants some piece of information in a hurry and it will be necessary to break in on the work of some man or men; in some cases it is even necessary to take the whole office force off their assignments and put them on special work that is of the utmost importance to the company. There is, however, an opportunity, by the careful study and selection of the men who are employed and by a study of the class and quantity of the work passing through the office, to reduce these interruptions of the office routine to a minimum.

It is difficult to apply a hard and fast rule to every case; indeed, it is doubtful if such a thing is possible, but a method that has given considerable satisfaction in at least one case is that of assigning the jobs which are likely to require considerable time, as well as mature judgment, to a selected number of men, leaving the smaller or what might be termed transient work to the younger and less experienced ones. By following

this plan it is possible, to a large extent, to eliminate the interruption of the more important work, as, if some rush order comes in it can generally be handled by one of the minor draftsmen whose work will be least disturbed by the interruption. The important feature of this method is that while it provides, among the minor draftsmen, for the necessary flexibility in the office force, it permits of the older men going on with their more important work, completing it and getting other assignments, instead of having a design or a set of calculations hanging fire, partly completed, for months, while a file of correspondence accumulates containing, for the most part, excuses and explanations for the non-completion of the work. Most drawing offices are under-manned, which, in itself, tends against efficiency, and the higher officers should be brought to realize that an adequate payroll can be made to more than offset itself and that their part in such an efficiency program is the providing of the funds necessary to secure enough men of the right character.

A cause which contributes freely toward the waste of time, not only on the part of the draftsmen, but those above them, is the inability of a great many railroad employees to make an intelligent report. Very commonly, if a draftsman is instructed to make an investigation and prepare a report on his findings, he hands in a document which, if any information is to be obtained from it, requires long study and remaking on the part of the higher officer. It is quite possible that the chief draftsman or the mechanical engineer may wish to discuss the matter at issue over the telephone with some one else; there may be considerable at issue, with the possibility of a large expenditure of money involved. In such a case the man who is discussing the report needs the information where it is instantly available for the answering of any question that may arise. What he wants is a plain, intelligent report, arranged logically and as briefly as clearness will permit; what he gets, nine times out of ten, is a jumble of words, probably not even paragraphed, with some points that amount to little enlarged upon several times, and others of great importance given almost no attention. If the matter under consideration can be covered in a report of a few words, it should be done; the most important points should be emphasized, but above all there should be a sequence and logical order to the sentences. If, for example, a report on a locomotive is being prepared it is not logical to deal with the axles in one sentence and with the throttle valve in the next, yet things as inconsistent as this are by no means uncommon.

Too much stress may be laid upon brevity, which while very desirable, should not be permitted to affect the clearness of the report. There are frequently matters which cannot be dealt with in report form without going to considerable length, and in such cases a summary may often be used to advantage. This summary should deal briefly with the more important conclusions and refer, when possible, to the specific items in the detailed report; but even when it is necessary in preparing a report, to go to considerable length, logical order and conciseness should not be lost sight of.

While the making of reports has been referred to here only in connection with the drawing office, the same considerations apply anywhere in the mechanical department. The road foreman of engines and the engine house foreman in making reports to the master mechanic, the master mechanic in reporting to the superintendent of motive power, and the latter reporting to the general manager, should all endeavor to so shape their reports that they will save their own time and that of their superiors, for a poorly constructed report is quite likely to react on the maker by being sent back for reconsideration and reconstruction. This is a subject which should be given serious attention in apprentice schools; but those men who have not the opportunity of attending such schools may improve and broaden themselves greatly by reading and self-education, keeping always in mind that what is required is brevity, consistent with clearness.

Modern Locomotive Practice

Lawford H. Fry recently presented a paper before the Institution of Locomotive Engineers in London, in which he analyzed the general features and principal dimensions of typical modern locomotives in the United States and Europe for the purpose of obtaining an idea of the general trend of locomotive practice at the beginning of the present year. The locomotives selected include examples of the latest designs from fourteen American, twelve British, four French, three German, one Italian and one Belgian railway. The European roads selected have about 64,000 miles of track and about 60,000 locomotives, while the American roads have about 57,000 miles of track and about 15,000 locomotives. The examples of freight locomotives range in total weight from 100,000 lbs. for the North British 0-6-0 type, to 540,000 lbs. for the Virginian 2-8-8-2 type. Between these extremes the other locomotives fall more or less clearly in three groups according to the nationality. At the lighter end are the British, and at the heavier end the American, while the continental engines take intermediate positions. Mr. Fry states that the average American freight locomotive is about twice as heavy as the average British, while the heaviest American is over three times the weight of the heaviest British. He points out that this condition is not because of undue conservatism on the one side, or the tendency to exaggeration on the other, but that it is legitimately produced by the difference in the conditions of the traffic in the two countries. In Great Britain there are about 1,800 inhabitants per mile of railway, while in the United States there are only about 450. From the longer hauls thus necessitated in this country, as well as because of the larger quantities of raw material to be handled, it follows that, while in England it is economical to provide an intensive service with a large number of trains of moderate weight, in the United States less frequent and more heavily loaded trains give more economical results. In this connection it is noted that in England there are 12.1 locomotives for each 10 miles of road, while in America there are only 2.7 locomotives for each 10 miles of road.

A study of the locomotive types in use in the various countries indicates that in Great Britain, while the lighter types, such as the 0-6-0 and the 0-8-0 in freight service and the 4-4-0 and the 4-4-2 type in passenger service, are still used, the 4-6-0 type is becoming more popular in passenger service as the demand for increased power becomes greater. In freight service the 2-6-0 type is being introduced on several railways. It thus appears that the tendency is toward the ten wheeler for passenger service and the mogul type for freight service, although tank engines have given excellent results on some lines. All but three of the British engines shown in a table included in the paper, were equipped with superheaters, and the indication is that an increasingly large number of new engines will be provided with superheaters. All the engines are single expansion, and it appears that the compound is hardly more than holding its own in Great Britain. In speaking of compounding, Mr. Fry said that although there are greater advantages in compounding with passenger than with freight engines, it appears that the determination as to whether the advantages or disadvantages are greater is largely a matter of nationality, the English and American believing the disadvantages to be most prominent, while the continental designers think otherwise. He is unable to see why four single-expansion cylinders should be used under any conditions.

In France, the freight service is being handled mainly by the 2-8-0 and the 2-10-0 types, and the passenger service by 4-6-2 type locomotives. Four-cylinder, compound engines are being maintained in spite of the introduction of superheaters. When superheat was first introduced there was a tendency to revert to single expansion, but the evidence is now clear that compounding is just as advantageous with superheat as with saturated steam.

The German locomotives selected are all of three railways, two being in South Germany and the Prussian State Railway in North Germany. The South German engines are all of the four-cylinder, compound, superheater design. The 2-8-0 type and the 0-10-0 type are used for freight service, and the 2-6-2 type and the 4-6-2 type for passenger service. The South German roads are alone in Europe in using bar frames of the American pattern. On the Prussian State Railways the 0-8-0 and the 0-10-0 type, two-cylinder, superheater locomotives are used for freight service, while the 4-4-0 and the 4-6-0 type are used for passenger service. For heavy, high speed, passenger service, superheater, 4-6-0 type locomotives, both simple and compound, have been employed. The results from the compound, however, have been so satisfactory that it is probable that the Prussian State Railway will return permanently to compound cylinders for the heaviest class of high speed locomotives.

In Italy the heaviest freight traffic is handled with 0-10-0 type locomotives, with four compound cylinders and saturated steam. In passenger service the trains do not operate at very high speeds and locomotives of the 2-6-2 type have given very satisfactory results. A Pacific type has been introduced but, for the present at least, this engine is more powerful than is necessary, and is so heavy that it cannot be used on all parts of the railway. Passenger engines in Italy are being fitted with superheaters and four cylinders, in most cases.

The conclusion for the United States indicates the 2-8-2 and the Mallet types for freight service and the 4-6-2 type for passenger service, to be the present tendency. It is pointed out that compounding is but little used and that superheating is being generally introduced, but not quite so widely as in Europe. In his general conclusion, Mr. Fry states that compounding shows a revival on roads where it has been dispossessed by the introduction of superheating, and while there is plenty of evidence that economy in coal can be effected by the double expansion of the steam, the engineer who decides to forego it for the sake of simplicity, will do so in very good company.

NEW BOOKS

Book of Standards. National Tube Company, Pittsburgh, Pa. 559 pages, 4 in. x 6½ in. Price, \$2.

This book is strictly a pipe handbook, is printed on thin paper so that it is not quite 5/8 in. thick, and is a handy size for pocket use. Several pages are devoted to a descriptive article covering the main process of manufacturing both welded and seamless tubes. There are a number of pages which give weights, dimensions, threads per inch, test pressures, sections of joints, specifications, etc., of the various kinds of pipes and tubings. Several pages describe, illustrate and contain tables in regard to lap-weld and seamless tubes, upset and expanded, wrought pipe bends, butted and strapped joints, etc. Considerable prominence is given to strength of tubes and cylinders under internal fluid pressure and collapsing pressures. Considerable attention is devoted to the mechanical properties of solid and tubular beams, of usual and unusual shapes. Chapters are included giving information in regard to water, gas, steam and air. It has not been the intention to go very deeply into these various subjects, only in so far as they concern tubular products. There is a large collection of tables, such as fifth roots and fifth power, decimals of a foot for each 1/64 of an inch, etc. Several pages are devoted to area and weight factors for tubes and pipes. A table showing properties of tubes and round bars is given with an explanatory article. The Metric system is included with conversion methods for most of the more commonly used measures, including temperatures. A table of wire and sheet metal gages as adopted by the Association of American Steel Manufacturers is given. A glossary of terms used in the pipe and fittings trade will also be found.

LARGE MIKADOS FOR THE LAKE SHORE

Heaviest Locomotives of Their Type Replace
Powerful Consolidations with Decided Economy.

The heavier class of freight service on the Lake Shore & Michigan Southern is very largely handled by consolidation type locomotives. These are equipped with superheaters and are among the heaviest and most powerful of their type in this country. Traffic conditions on many parts of the Lake Shore seem to be well adapted for developing the advantages of the Mikado type locomotive to the fullest extent. This is proved by the service of twenty 2-8-2 type locomotives of the largest size which this company has recently received from the American Locomotive Company. Although the tractive effort has been increased but $22\frac{1}{2}$ per cent., as compared with the consolidation type of locomotive used, the tonnage rating for main line work gives the new Mikados 4,300 lbs., while the superheater consolidation locomotives are rated at 3,200 tons. This is an increase of nearly 35 per cent.

The new engines are the heaviest of their type on our records, having a total weight of 322,000 lbs., and represent the latest practice in design in every particular, although they have no new or untried general features. With a steam pressure of 190 lbs. the tractive effort is 56,000 lbs. This is 4,800 lbs. less than the Chesapeake & Ohio Mikados, illustrated on page 128 of the March

ular service over various divisions, shows what they are doing in every day work. The consolidations with which they are to be compared have a total weight of 239,500 lbs., of which 214,400 lbs. is on drivers. The tractive effort is 45,800 lbs., the cylinders are 25 in. x 32 in., steam pressure 200 lbs. and the drivers 63 in. in diameter. They are equipped with superheaters having about 600 sq. ft. of superheating surface and the evaporating heating surface of the boiler is 3,023.1 sq. ft. On the eastern division out of Collinwood, the consolidations have a tonnage rating of 3,200 tons, while the Mikados are given 4,300 tons. Out of Seneca, the consolidations have a rating of 2,600 tons, while the Mikados are given 3,500 tons. On the Franklin division, out of Youngstown, the consolidations are given 3,400 tons and the Mikados 4,300 tons, while on the Toledo division the consolidations have 3,000 tons and the Mikados 3,500 tons.

In addition to the increase in power which would be expected with a larger engine, there has also been a notable economy of coal and water. Records taken from the Eastern and Michigan divisions give a somewhat unfair comparison which, however, indicates what may be expected under ordinary operating conditions. The average for three trips of a superheater consolidation

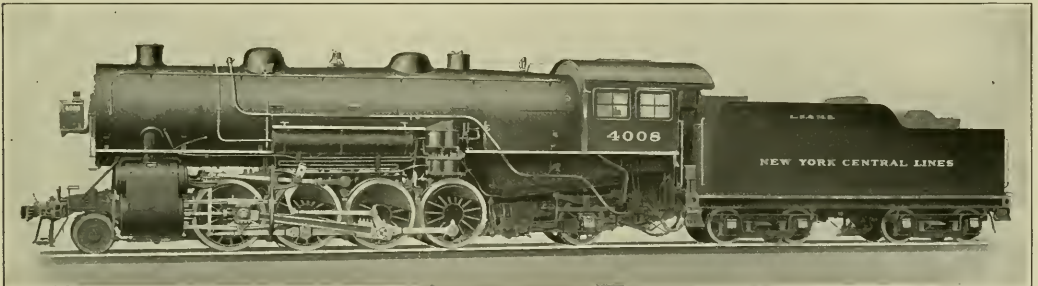

Heaviest Mikado Type Locomotive; Lake Shore & Michigan Southern.

issue of this journal, which are the most powerful of their type. The Lake Shore engines have a reasonably high factor of adhesion, the ratio being 4.37 as compared with 4.00 on the Chesapeake & Ohio engine. It is the practice of this company to use a fairly high ratio of weight on drivers to tractive effort, for the purpose of giving ample adhesion when the tires have been worn nearly to the limit. The importance of this feature will be readily understood when it is considered that if the tires are worn 2 in., thus reducing the diameter of the wheels by 4 in., and if at the same time the cylinders have increased $\frac{1}{2}$ in. in diameter, the tractive effort will be raised to nearly 62,000 lbs. This reduces the factor of adhesion from 4.37 to 3.95. Although these engines are being operated with 190 lbs. steam pressure, they are designed for a pressure of 200 lbs., so that a tractive effort can be increased to 59,000 lbs. if desired.

An idea of the power of these locomotives can probably best be obtained from a knowledge of the trains they are hauling on the road. A profile of the section between Carson and Coalburg, Ohio, is shown in one of the illustrations. The maximum grade for the direction in which the test runs were made is 16 ft. to the mile. The average train for three runs over this section contained 100 cars having a tonnage of 6,345 tons and was hauled at an average speed, excluding delays, of 14.58 miles per hour. These, of course, are test runs, but a comparison of the tonnage rating of these locomotives and the consolidations in reg-

locomotive having a total weight of 241,000 lbs. shows that it burns 15.9 tons of coal per trip of about 130 miles when hauling a 60-car train of 2,335 tons. This gives 8.17 miles per ton of coal, or 19,100 ton-miles per ton of coal. The average of three trips over the same division with a Mikado is 12.85 tons of coal when hauling a train that averaged 70 cars of 3,203 tons. This is 10.1 miles per ton of coal and 32,400 ton-miles per ton of coal. Although the figures for the Mikado are favorably affected by the cars in the train being more heavily loaded, still the conditions are normal to ordinary operation.

The difference between an increased hauling power of from 35 to 40 per cent. and an increased tractive effort of $22\frac{1}{2}$ per cent. can only be attributed to the increased boiler capacity. If the equivalent heating surface (evaporating heating surface plus $1\frac{1}{2}$ times the superheater heating surface) is taken for the two locomotives under comparison, and the same rate of evaporation is assumed for each, it will be seen that the Mikado is well over 50 per cent. more powerful as a steam maker than the consolidation. This indicates that to make as good a record as it did, the consolidation had to evaporate at a considerably higher rate per square foot of heating surface in these tests. If a comparison is made on the basis of theoretical maximum horsepower delivered with 700 ft. per minute piston speed, it will be seen that the Mikado is about 40 per cent. more powerful than the consolidation and, when operating under these theoretical conditions, it

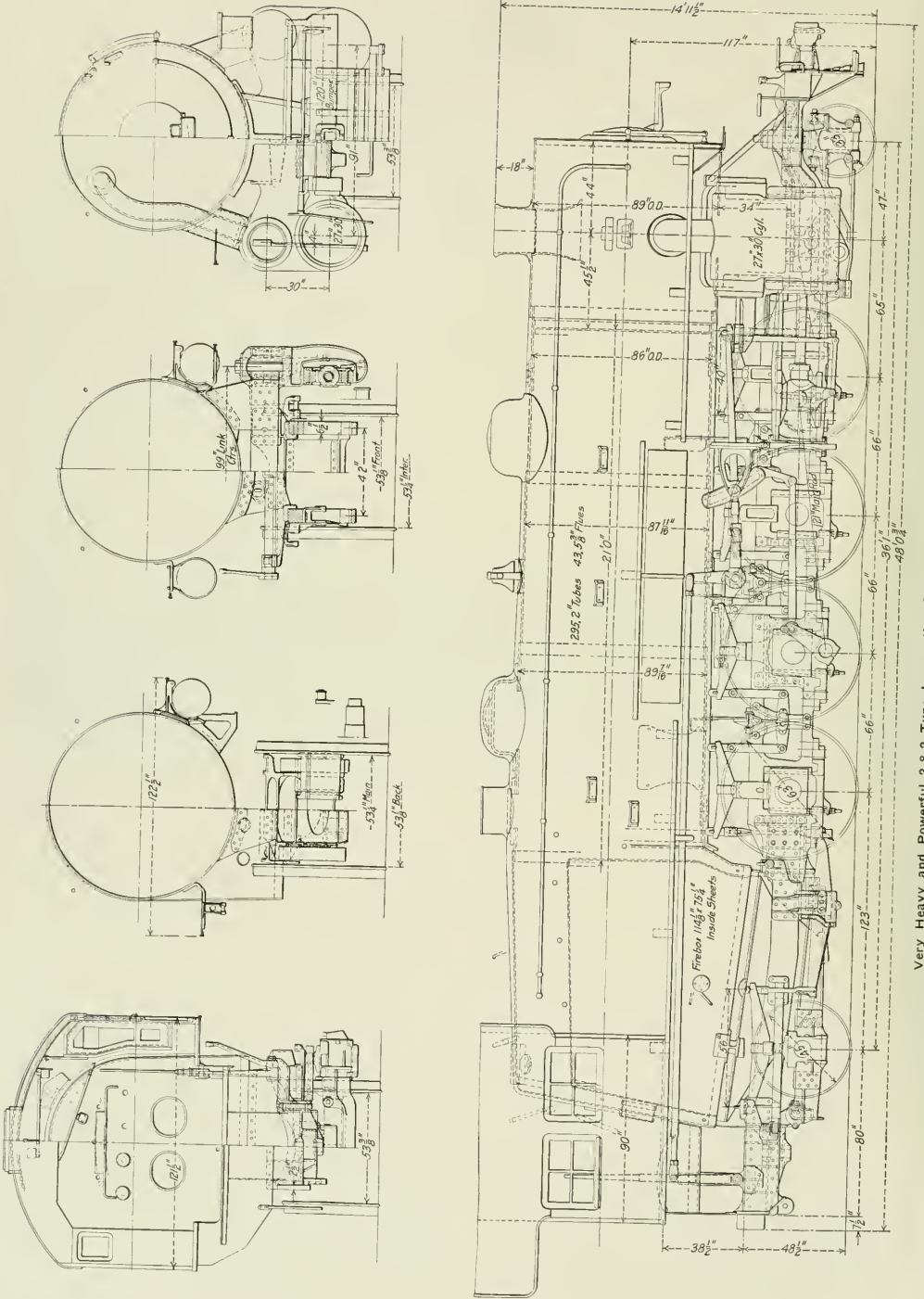

Very Heavy and Powerful 2-8-2 Type Locomotive for the Lake Shore & Michigan Southern.

will evaporate about 5 per cent. less per square foot of evaporative heating surface.

In the following table an opportunity is given for comparing this design with other large Mikado locomotives of recent design.

Road.	I. S. & M. S.	C. & O.	C. R. I. & P.	C. B. & Q.
Total weight, lbs.	322,000	315,000	318,850	303,400
Weight on drivers, lbs.	245,100	243,000	243,200	231,000
Per cent. weight on drivers.	76.2	77.1	76.3	76.4
Tractive effort, lbs.	56,050	60,800	57,100	60,000
Factor of adhesion.	4.37	4.00	4.26	3.85
Average weight per driving axle, lbs.	61,250	60,750	60,800	57,750

cator valve, Franklin pneumatic fire doors, feed water connections, cold water sprinklers, and radial buffers, a special design of pipe clamp, a new water glass shield, and very long main driving boxes.

An interesting feature of the design is the extensive use of vanadium steel and iron for various parts. This material is used for the main frame, driving springs, piston rods, main and side rods, driving axles, trailer springs and main rod straps, as well as for the links, link blocks, pins and bushings in the motion

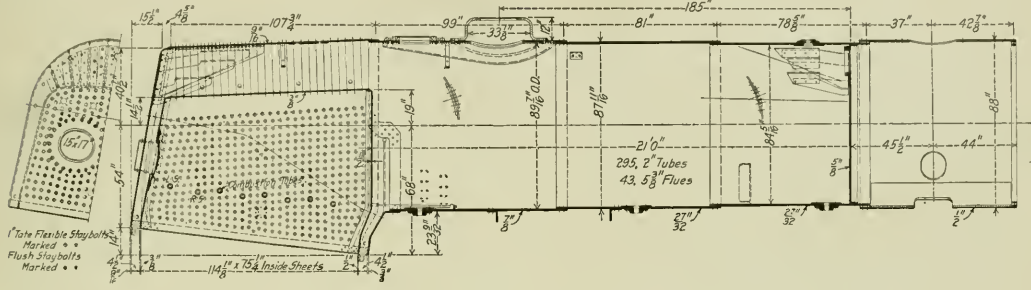

Straight Top Boiler Without Combustion Chamber; Lake Shore 2-8-2 Type Locomotive.

Cylinders, diameter and stroke, in.	27 x 30	29 x 28	28 x 30	28 x 32
Diameter of drivers, in.	63	56	63	64
Steam pressure, lbs.	190	170	180	180
Heating surface, evaporating, sq. ft.	4,730	4,051	4,264	4,627
Heating surface, superheater, sq. ft.	1,065	845	848	961
Ratio evap. to super. heat. surface.	4.4	4.8	5.03	4.82
Equivalent heating surface, sq. ft.	6,338	5,319	5,536	6,069
Maximum theoretical horsepower.	2,610	2,500	2,470	2,470
Evaporation per sq. ft. heating surface†	11.60	12.95	12.15	11.20

work of ten of the locomotives. The cylinders are also made of cast iron with a vanadium content.

Reference to the illustration and table of dimensions will show the features of the very large boiler which has been applied. It will be noticed that this design differs from customary practice in but few particulars. The firebox is of a normal radial stay arrangement, with two fire doors and does not include a combustion chamber. Two inch tubes, 21 ft. in length, are employed

*Taken at 700 ft. piston speed and 62 per cent. maximum tractive effort.
†Evaporating surface only, 21 lbs. of water per horsepower hour assumed.

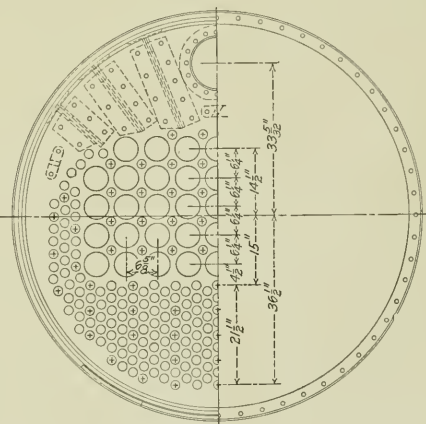
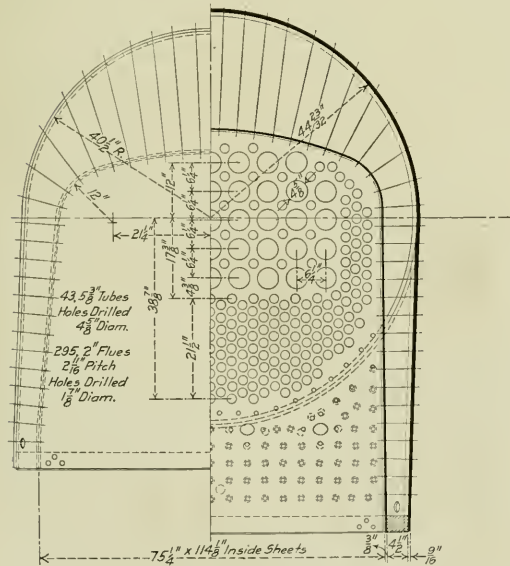

43.5" Flues Holes Drilled 5/32" Diam.
295, 2" Tubes, 2" Pitch Holes Drilled 1/8" Diam.
Tubes Marked Thus + Beaded Over.

Sections of the Firebox and Boiler; Lake Shore Mikados.

In general features of construction the design is normal and is thoroughly modern in every particular. A number of new features of a minor, but important, nature have been included, some of them being used on this locomotive for the first time. Among these might be mentioned the MacBain auxiliary lubri-

and are distributed in the normal manner. The superheater elements are included in forty-three 5 3/8 in. superheater flues. An improvement, which is now being applied to a number of the more recent locomotive boilers, is an inspection manhole, 16 1/4 in. in diameter, located just back of the dome and about 2 ft. ahead of

the back tube sheet. The $3\frac{1}{4}$ in. liner that stiffens the opening around the dome is carried back to include this opening as well. The cover plate of the inspection manhole carries the safety valve and it takes the place of the auxiliary dome which has often been installed at this point. The stringent requirements of the boiler inspection law make it necessary to frequently enter the interior of the boiler and since, when this is done through

in thickness which fits snugly to the inner faces of the jaws. The very wide shoes and wedges are fitted to these cross-tie extensions and have an increased bearing surface of about 350 sq. in. over what they would have if they were applied to the frames only. The pedestal binder is also of extra width and a second wedge bolt is provided for handling the wide and heavy wedge.

The main journals are $11\frac{1}{2}$ in. x 22 in. and the driving box is quite similar to the one used on the Delaware Lackawanna & Western Pacific type locomotive, which was illustrated and described on page 391 of the August, 1912, issue of this journal. Driving boxes of this type have been in experimental service on the New York Central Lines for some time, particularly on passenger locomotives, and have given most satisfactory results.

A somewhat unusual method of equalization has been employed. It has been found that on locomotives of the Mikado type where the first two driving wheels and the engine truck are equalized together, the springs are difficult to maintain in a level position. For this reason it was decided not to carry the forward unit back of the first pair of drivers in this case and the engine is equalized with the forward pair of drivers and the front truck forming one unit and the last three pairs of drivers and the trailing truck forming the other units on each side in the usual manner.

By the use of vanadium steel the front, rear and intermediate axles have been reduced to $9\frac{3}{4}$ in. in diameter between the journals, which are 11 in. x 12 in. This is $\frac{3}{4}$ in. less, in the case of the front and intermediate axles, and 1 in. less in the case of the rear axles, than common practice would require for carbon steel axles with journals of the above size on locomotives of this type.

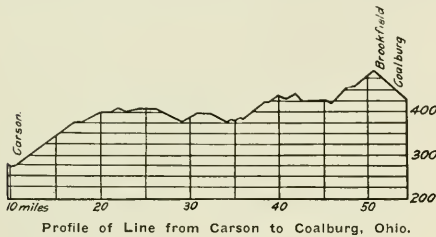

the ordinary dome, it requires the removal of the throttle stand pipe, this auxiliary manhole is an improvement that is welcomed by the inspector.

Five of the engines are equipped with the O'Connor type of fire door flange and all have a full installation of flexible stay-bolts with the exception of six longitudinal rows of button head radial stays at the top of the crown sheet. There are four 2 in. combustion tubes placed in each side water leg. These permit air to enter the firebox over the top of the fuel bed and thus

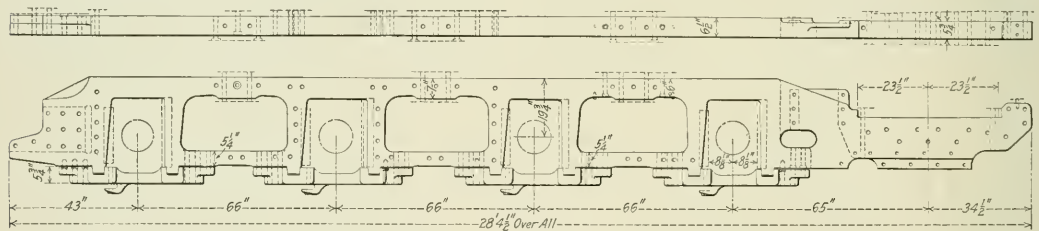

promote combustion. The throttle rod is carried by two V-shaped supports swung from the top of the boiler and is held at the bottom of the V by a pin extending through the supports just above it. This attachment prevents the rod from buckling and therefore practically eliminates the lost motion of the throttle lever when the throttle is tightly closed. The back head and front tube sheet are both stayed with $\frac{1}{2}$ in. boiler steel gusset plates which are riveted to 4 in. x 4 in. angles on both the heads and the shell.

Vanadium cast steel frames $6\frac{1}{2}$ in. in width and 7 in. deep over pedestals are used. The rear frames are in the form of a slab $3\frac{1}{2}$ in. in width and 15 in. deep, which is spliced to the main frame just back of the rear pair of driving wheels. Care has been given to provide ample strength at the points of possible failure. In addition to using the best material of ample section in the main frame, the frame bracing has also been given considerable attention. This is noted particularly in connection with the design of the lugs on the frame braces where the frame bolts pass through. A bearing area for the bolts is provided that will develop practically their full shearing strength. There are vertical frame braces or cross-ties applied on the rear pedestal jaws of the last three pairs of drivers and to the forward jaws of the main drivers as well. The construction at the main pedestal is of particular interest in connection with the arrangement for the application of the very long driving boxes that are used. The vertical frame cross-ties on both sides of this pedestal are continued through to the outside of the frame by a projection 1 in.

Vanadium cast iron is used in the cylinders, which are cast integral with the saddles and are interchangeable, right and left. Both the cylinders and valves are bushed with Hunt-Spiller gun iron and the piston and valve packing rings and the crosshead shoes are made of the same material. The diameter of the valve and the valve setting are shown in the table of dimensions at the end of this article. The valve gear is designed to give a

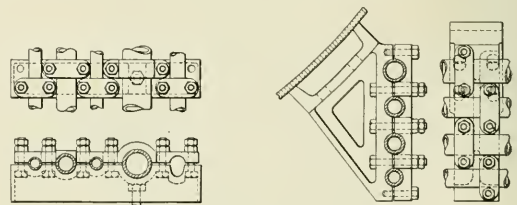

cut-off of 88 per cent. in full gear in order to secure the maximum tractive effort in starting.

These locomotives are equipped with an arrangement for forcing the oil through the feed pipes when the throttle is open, that was designed by D. R. MacBain, superintendent of motive power. It employs a valve that is held seated by a spring and is so located and arranged that its extending stem will be forced in-

ward by an extension on the throttle lever when the latter is open. This unseats the valve and allows a passage for steam directly from the boiler to the oil pipes leading from the lubricator to each cylinder. Its arrangement and operation is clearly shown in the illustration. It insures the proper lubrication of both cylinders as soon as the throttle is open, but when the latter is closed the lubricator will feed in the ordinary way only.

A feature that is ordinarily given but scant attention has in this case been given the study it really deserves. This refers to the arrangement and clamping of the various pipes. Special designs of clamps have been prepared by A. R. Ayers, general mechanical engineer of the New York Central Lines west of Buffalo, which not only holds them firmly in place but provides a separate clamp for each pipe so that one may be removed without disturbing the others. The arrangement is most substantial and the pipes will not be subjected to the vibration which so often leads to failure at the joints. Furthermore, the pipe fitters have a definite alignment to work to, as the piping is laid out in the drawing room, and each pipe is in a definite place and can

through the outlet pipe to the outside of the cab and there will be no opportunity for small pieces of glass to fly. As will be seen, it offers no obstruction to the ready application of a new glass when necessary.

The tender is fitted with the railroad's standard 7,500 gal., 12-ton, water bottom tank which is carried on a Commonwealth cast steel frame. Commonwealth cast steel trucks are employed and the tender has a standard water scoop.

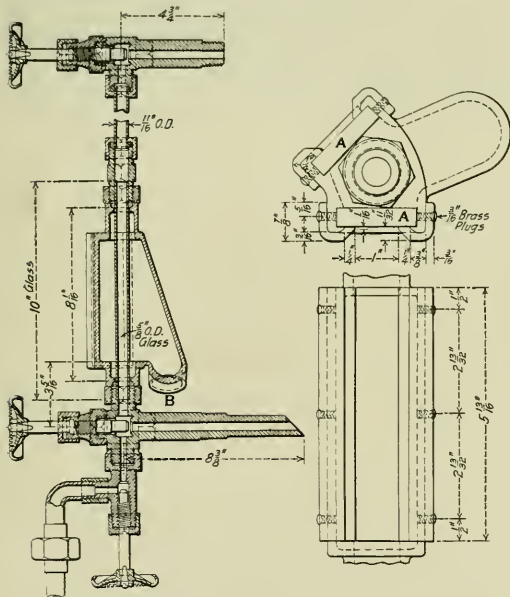

Water Glass Shield Used on the Lake Shore Mikados.

only be attached in that place. This not only makes the work much easier for the pipe fitters, but prevents them doing their work in a haphazard manner. In connection with the pipe clamp, a slot has been provided for the cylinder cock reach rod. This rod extends back from the cylinders to a rocker under the cab running board and the lever is placed just inside the cab within easy reach of the engineer who may operate it by hand instead of kicking it open and closed with his foot.

Another interesting device that has been applied to this locomotive and is here illustrated is a design of water glass shield which has recently been made standard on this road. This shield completely encloses the water glass, the only outlet being at the point marked B in the illustration, from which a pipe leads downward through the floor of the cab. There are two glass plates marked A, which are 1 13-16 in. x 6 in. x 13-32 in. and are set at an angle of 45 degrees to each other in the shield. This shield completely protects the water glass from danger of accident by external means and also prevents any accidents in case the glass should break of itself, as the steam and water will pass down

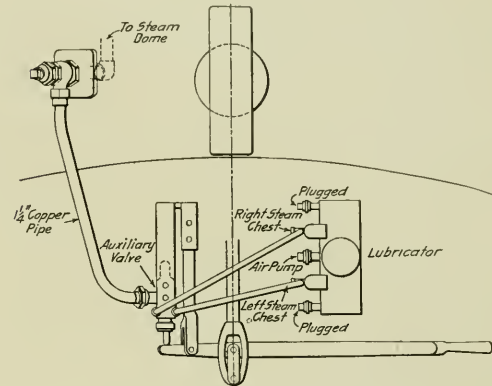

MacBain Auxiliary Lubricator Valve.

General dimensions, weights and ratios of these locomotives are shown in the following table:

General Data.	
Traction effort	56,050 lbs.
Total weight in working order	322,000 lbs.
Weight on drivers	245,000 lbs.
Weight on leading truck	27,500 lbs.
Weight on trailing truck	49,500 lbs.
Weight of engine and tender in working order	477,800 lbs.
Wheel base, driving	16 ft. 6 in.
Wheel base, engine and tender	68 ft. 10 1/2 in.

Ratios.	
Weight on drivers ÷ traction effort	4.37
Total weight ÷ traction effort	5.72
Traction effort x diam. drivers ÷ evaporating heating surface	746.00
Evaporating heating surface ÷ grate area	79.50
Firebox heating surface ÷ total heating surface, per cent	5.20
Weight on drivers ÷ total evaporating heating surface	51.70
Total weight ÷ total evaporating heating surface	68.00
Volume both cylinders, cu. ft.	19.86
Total evaporating heating surface ÷ vol. cylinders	239.00
Grate area ÷ vol. cylinders	3.00

Cylinders.	
Kind	Simple
Diameter and stroke	27 in. x 30 in.

Valves.	
Kind	Piston
Diameter	16 in.
Greatest travel	7 in.
Outside lap	1 in.
Inside clearance	0 in.
Lead	5 in.

Wheels.	
Driving, diameter over tires	63 in.
Driving journals, main, diameter and length	11 1/2 x 22 in.
Driving journals, others, diameter and length	11 x 12 in.
Engine truck wheels, diameter	33 in.
Engine truck journals	6 x 12 in.
Trailing truck wheels, diameter	45 in.
Trailing truck journals	8 x 14 in.

Boiler.	
Working pressure	190 lbs.
Outside diameter of first ring	86 in.
Firebox, length and width	114 1/2 x 22 in.
Firebox plates, thickness	3/8 and 1/2 in.
Firebox, water space	452 in.
Tubes, number and outside diameter	295 2 in.
Flues, number and outside diameter	43 3 1/2 in.
Tubes and flues, length	21 ft.
Heating surface, tubes	4,494 sq. ft.
Heating surface, firebox	246 sq. ft.
Heating surface, total evaporating	4,740 sq. ft.
Superheater heating surface	1,065 sq. ft.
Grate area	59.6 sq. ft.
Smokestack, height above rail	14 ft. 11 1/2 in.

Tender.	
Frame	Cast steel
Wheels, diameter	36 in.
Journals, diameter and length	5 1/2 x 10 in.
Water capacity	7,500 gals.
Coal capacity	12 tons.

TESTS OF SMOKE ABATEMENT DEVICES

The Chicago & North Western made a demonstration run Tuesday, April 15, for the benefit of various railway officials and press representatives from Chicago to Proviso, testing out a device for smoke abatement on locomotives recommended to the railways about Chicago by the General Managers' Association. Some months ago O. Monnett, smoke inspector for the city of Chicago, called the attention of the General Managers' Association to the fact that there were wide differences of opinion among the railroads as to the most efficient locomotive smoke preventing device—each road maintaining that the devices used by it were the best.

The General Managers' Association accordingly appointed a special committee consisting of representatives of the mechanical departments of the Pennsylvania, Chicago & North Western, Chicago, Burlington & Quincy, Chicago, Milwaukee & St. Paul, and the Chicago & Western Indiana Railways, which committee was asked to make comparative and efficiency tests of the several smoke preventing devices. Extensive tests were made on the Pennsylvania Railroad's testing plant at Altoona, the results of which will be presented before the Master Mechanics' Association at its June convention. In brief, it was found that either the double or multiple tip blower nozzles should be used; that the grate should have not less than 30 per cent. air opening; that sufficient air tubes should be provided above the fire, so that a total of 2,000 cu. ft. of air per minute could be supplied by means of steam jets, the nozzles of which should be located 8½ in. from the inside ends of the tubes; that the brick arch prevents more smoke while the locomotive is running than when standing, and that such an arch gives the best results when fitted tight up against the flue sheet; that there is advantage in a large quick-opening blower valve.

The test run was made with an 18 in. x 24 in. superheater 6-wheel switch engine equipped in accordance with the above recommendations. The trip out to Proviso was made with a train of about 1,000 tons gross, and the results obtained were

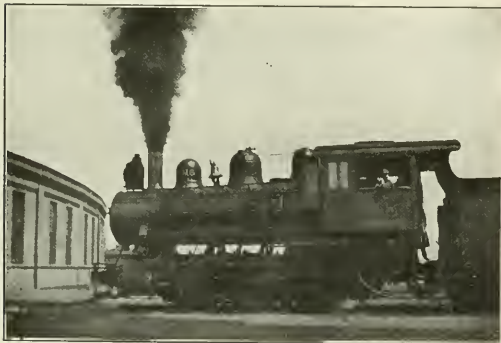

Without Smoke Abatement Devices In Use.

considered very satisfactory by all observers, there being practically no smoke thrown from the stack throughout the whole trip. On reaching Proviso some severe tests were made on the device. It was cut out of service and the engine was allowed to smoke as badly as possible, then when being put into service again it was found that the smoke could be eliminated in from five to seven seconds. On the return trip a trainload of over 1,200 tons was hauled, a part of the distance being up a grade of 32 ft. per mile, no objectionable smoke being emitted from the engine at any time. The smoke density to Proviso was 4.6 per cent., and from Proviso 4.3 per cent.

In addition to the above mentioned test committee the Gen-

eral Managers' Association appointed a standing committee consisting of M. K. Barnum (chairman), Illinois Central; H. T. Bentley, Chicago & North Western, and E. F. Jones, of the "Belt" Railway. This committee developed the plan for the "Railroad Smoke Inspectors' Association of Chicago," which was organized on January 2, 1913, for the purpose of bringing about the thorough interchange of ideas between the smoke inspectors employed by the various Chicago railroads, and to utilize the inspectors for the joint benefit of all lines by requiring them to report cases of emission of dense smoke, whether made by locomotives of their own company or by those of any other

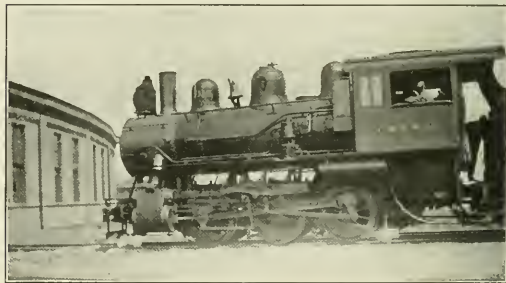

Seven Seconds Later With Devices in Service.

railway coming under their notice, thus bringing about increased efficiency in this line of work.

This association holds a meeting every alternate Friday, and the co-operation secured in this manner has done much in the way of reducing smoke on the part of the railroads in this district. The number of smoke inspectors on Chicago railroads has been increased from 32 to 41, making the number of locomotives in daily operation in Chicago per inspector employed 40 as compared to 52 under the former practice. The chairman of the association is J. H. Lewis, chief smoke inspector of the Chicago, Burlington & Quincy, and the chairman of the executive committee is C. W. Corning, chief smoke inspector of the C. & N. W., with C. P. Burnalle, chief smoke inspector of the A. T. & S. F., as the secretary.

The railroad smoke conditions in Chicago today as compared to the smoke densities in other cities and towns where no smoke ordinance is in effect is as follows:

Nashville, Tenn.....	30 per cent.	LaSalle	30 per cent.
East St. Louis.....	40 per cent.	Down town Chicago...	6 per cent.
Peoria	30 per cent.		

In 1910 the smoke density of down town Chicago was 23 per cent., which figure represents the density for South Chicago today. Intermediate sections of the city show a density of 12 per cent., showing that the effort of supervision in the down town section has had the effect of reducing the smoke density to a point which was thought absolutely impossible two or three years ago.

PENSIONERS ON THE PENNSYLVANIA.—The number of pensioners who are more than 80 years of age on the Pennsylvania system is 296.

CLASSIFIED EQUIPMENT DEFECTS.—The following table gives the number of defects for 1,000 freight and passenger cars and locomotives inspected by the government inspectors during the fiscal year of 1912:

Couplers and parts.....	6.12	Hand brakes	10.12
Uncoupling mechanism	8.09	Footboards13
Air brakes	33.51	Pilot-beam sill steps.....	.06
Handholds	7.98	Handrails02
Height of couplers.....	1.09	Power brakes03
Steps97	Ash pans03
Ladders62		
Running boards	4.43	All classes	73.45

DISTRIBUTION OF POWER IN MALLET'S

Valve Setting and Cylinder Ratios When the Weight on the Two Groups of Drivers Is Unequal.

BY PAUL WEEKS.*

In a Mallet compound locomotive where the high pressure cylinders drive a different number of wheels than the low pressure cylinders, the work of the whole locomotive instead of being equally distributed between the high and low pressure cylinders, as is usually the case, must be distributed in proportion to the adhesive weight on the drivers in each group. Such engines have been built and sufficient experiments made so that the problem of cylinder design can be intelligently discussed.

The questions that arise in approaching the subject are as follows: What valve arrangement will give a constant ratio of

than their share. It was noticed from these cards that the high pressure cylinders did a larger share of the work as the speed increased and the reverse lever was hooked up to give shorter cut-offs.

The next arrangement tried was to reduce the high pressure cylinder to 22 in. in diameter, leaving the low pressure cylinder and the valve setting on both the high and low the same as before. This gave a better work distribution than before, but the ratio of work in the high to that in the low was still too small when running at slow speeds with long cut-off, and increased very rapidly with higher speeds and shorter cut-offs. The results with this arrangement are shown in Fig. 1.

It was at this stage of the experiments that a theoretical study of the conditions was made with the view to making further changes more intelligently.

It was not expected that the exact valve setting and cylinder sizes could be determined from the study unless great refinement was used in the matter of back pressure, drop in the pressure in the receiver, and wire drawing in the throttle and valves, all of which would vary to some extent with every engine studied. The object was rather, therefore, limited to what a chemist

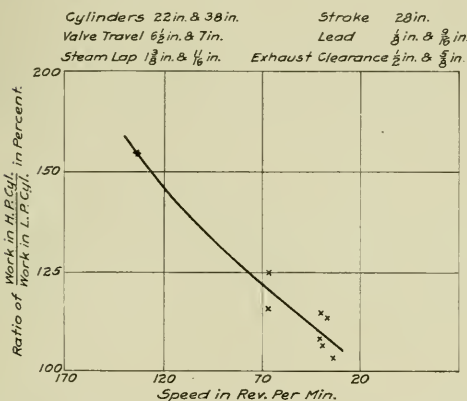

Fig. 1—Distribution of Power in the Locomotive at the Beginning of the Investigation.

work at all speeds and cut-offs? What ratio of cylinders is necessary to give the desired ratio of work? What sizes of cylinders are necessary to give the best return from the adhesive weight of the whole locomotive?

In order to produce a steam distribution in the cylinders of a locomotive of this type on one of the western railways, such that each pair of cylinders would do work proportional to the weight on the drivers coupled to those cylinders, several arrangements of valve setting and cylinder ratios were tried. The high pressure cylinders in this case were connected to three pairs of drivers and the low pressure to but two pairs, making it necessary that the high pressure cylinders should do $1\frac{1}{2}$ times as much work as the low pressure.

As the engines were sent from the builders the cylinders were 24 in. and 38 in. in diameter, and the valve gear was of the Walschaert type. The valves had a $1\frac{1}{4}$ in. steam lap and were set with a $\frac{1}{4}$ in. lead for the high pressure cylinders and $15/16$ in. steam lap and $5/16$ in. lead for the low pressure cylinders. It was found that this arrangement gave too much work in the low pressure cylinders. The result was that the front group of wheels continually slipped, this slipping even taking place before the full power of the high pressure cylinders could be exerted.

The valves were therefore changed to have $1\frac{3}{8}$ in. steam lap and $\frac{1}{4}$ in. lead for the high pressure and $11/16$ in. steam lap and $9/16$ in. lead in the low. Indicator cards taken with this arrangement showed an improvement in the work distribution, but at slow speeds the low pressure cylinders still did more

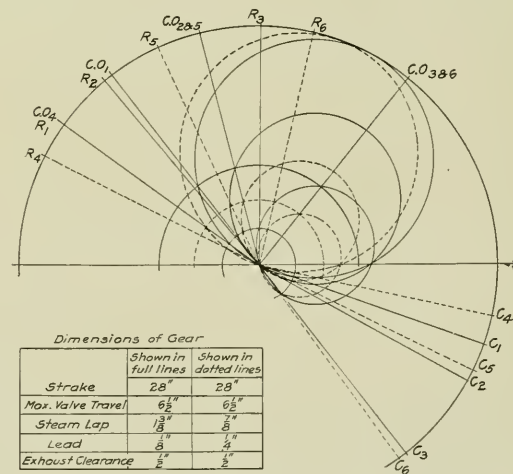

Cut-off	Release	Compression	Cut-off	Release	Compression
C.O. 1-2-3	R 1-2-3	C 1-2-3	C.O. 4-5-6	R 4-5-6	C 4-5-6
22.48"	25.42"	.81"	25.42"	26.5"	.404"
17.16"	22.75"	1.75"	17.16"	20.6"	1.55"
5.39"	13.79"	5.25"	5.39"	10.75"	5.72"

Fig. 2—Zeuner Valve Diagram for Three Positions of the Reverse Lever and Two Valve Arrangements.

would call a qualitative analysis instead of an exact quantitative analysis.

The plan followed in making the investigation was to determine by means of Zeuner valve diagrams the events of the stroke (cut-off, release, compression and admission) for several different valve arrangements and for different positions of the reverse lever for each valve arrangement. With these events, theoretical

*Mechanical Engineer, Los Angeles, Cal.

indicator cards were drawn for several different ratios of cylinders.

In drawing the indicator cards certain assumptions were made, as follows: The clearance volumes of the high and low pressure cylinders were considered to be equal. The expansion of the steam in the cylinders was assumed to follow the curve of a rectangular hyperbola. There was assumed to be no drop in pressure between the exhaust from the high and the admission to the low pressure cylinders. The receiver volume was assumed to be large enough, so that the admission line of the low pressure cylinder would be horizontal.

The Zeuner diagram, Fig. 2, is drawn for two valve arrange-

From the data thus obtained the curves shown in Fig. 5 were drawn illustrating the relation between the ratio of work in the two cylinders and the cut-off in the high pressure cylinder. There are six curves, each of them representing one of the conditions shown in Fig. 4.

Examining these curves with references to the first question, viz., What valve arrangement will give a constant ratio of work at all speeds and cut-offs? it will be noticed that curves *A* and *E* rise very rapidly, as the cut-off is shortened and an inspection of the valve conditions on which these curves are based shows a very long steam lap in the high pressure cylinders and a very short steam lap in the low. Curves *B*, *C* and *D* do not rise as

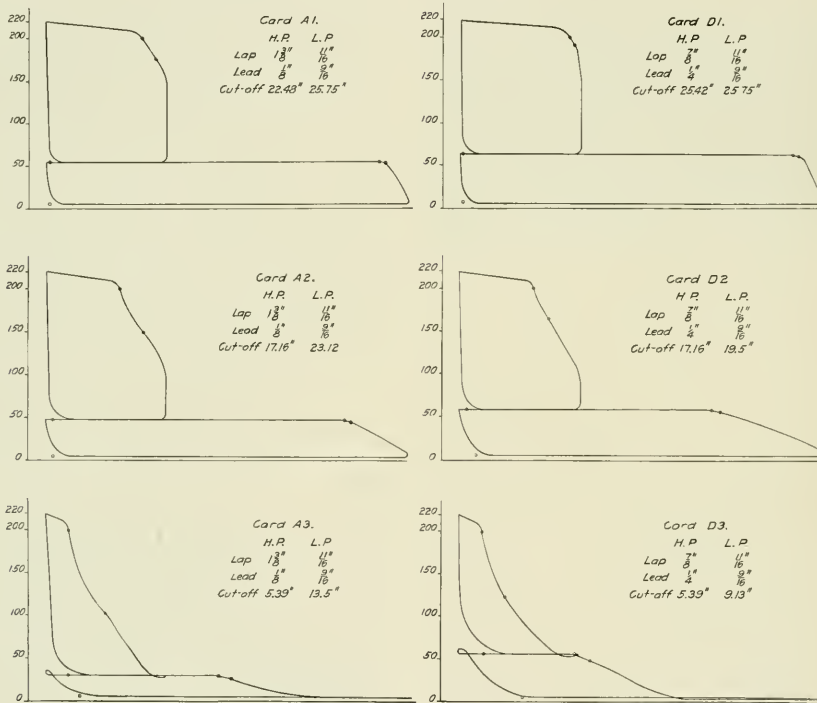

Fig. 3—Indicator Cards Constructed from the Information Given by the Zeuner Diagrams.

ments on the high pressure cylinder showing the reverse lever in three different positions for each.

A similar diagram for the low pressure cylinders gives the valve events as shown in the table below. On these cylinders

Valve Events for Low Pressure Cylinders			
Cut-off in High Pressure	Cut-off in Low Pressure	Release	Compression
22.48° & 25.42°	25.75°	26.06°	$.25^\circ$
17.16° (L&L= $\frac{1}{2}$)	23.12°	23.5°	$.56^\circ$
17.16° (L&L= $\frac{1}{16}$)	19.5°	20.06°	1.25°
5.39° (L&L= $\frac{1}{2}$)	13.5°	14.38°	2.88°
5.39° (L&L= $\frac{1}{16}$)	9.13°	10.0°	4.83°

the valves have a maximum travel of 7 in., a steam lap of $11/16$ in., a lead of $9/16$ in., and an exhaust clearance of $3/8$ in.

Theoretical cards were then constructed for one ratio of cylinders and the events shown on the Zeuner diagrams. These are shown in Fig. 3. Fig. 4 shows the figures obtained from the diagrams and cards for these two conditions and for four others.

rapidly as *A* and *E*, as the cut-off is shortened and it will be noticed that they are based on a much shorter steam lap in the high pressure, but the same lap in the low pressure as curves *A* and *E*. Curve *F* is more nearly horizontal than any of the others and is based on valve conditions with the high the same as *B*, *C* and *D*, but the low with a longer steam lap. It therefore appears that a valve setting with the steam laps in the high and low pressure cylinders nearly equal will give a more uniform work distribution than any arrangement with widely different laps.

Again examining the curves with reference to the question of what ratio of cylinders is necessary to give the correct work ratio, it will be seen that as the chart is plotted with this ratio as ordinates the location of the curves, one above the other, will indicate the effect of a change of cylinder ratio. The three curves, *B*, *C* and *D* are arranged with *B* at the bottom, corresponding to the smallest cylinder ratio, and *C* at the top, corresponding to the largest cylinder ratio. Curves *A* and *E* are also located with *E* below, corresponding to a smaller cylinder ratio than *A*. The conclusion to be drawn from these facts is that

the larger the ratio of cylinders, the more work in proportion is done in the high pressure cylinder.

These curves cannot be assumed to give the exact ratio of work which would be found in an actual locomotive under the same conditions. It will, therefore, be necessary to see if it is

another locomotive of the same type, while the plotted points are taken from actual indicator cards. The curve *J* shows a work ratio of about 75 per cent, whereas the points fall mostly between 80 and 95 per cent.

The locomotive now under investigation was, therefore, kept

Cord	Diam. of Cyl.		Cyl. Ratio	High Pressure				Low Pressure				Cut-Off			Release			Compression			Area of Card		Total Area	Tractive Effort	X
	High	Low		Valve Travel	Steam Lap	Lead	Exhaust Clearance	Valve Travel	Steam Lap	Lead	Exhaust Clearance	High	Low	High	Low	High	Low	High	Low	Ratio					
B 1	26"	36"	2.137	6 1/2"	7"	7"	1 1/2"	7"	11"	16"	8"	16"	25.42	25.75	26.5	26.06	.4	.25	247	346	714	533	77500	146	
2													17.16	19.5	20.6	20.1	1.55	1.25	215	276	78	491			
3													5.39	13.5	13.79	14.38	5.25	2.88	114	67	170	181			
E 1	24"	36"	2.508	6 1/2"	7"	7"	1 1/2"	7"	11"	16"	8"	16"	22.48	25.75	25.42	21.06	.81	.25	238	252	95	490	64100	141.5	
2													17.16	23.12	22.75	23.5	1.75	.56	216	206	105	422			
3													5.39	13.5	13.79	14.38	5.25	2.88	114	67	170	181			
D 1	22"	36"	2.985	6 1/2"	7"	7"	1 1/2"	7"	11"	16"	8"	16"	25.42	25.75	26.5	26.06	.4	.25	204	232	.88	436	57000	150	
2													17.16	19.5	20.6	20.1	1.55	1.25	179	197	.91	376			
3													5.39	9.13	10.75	10.0	5.72	4.88	76	73	1.04	149			
A 1	22"	36"	2.985	6 1/2"	7"	7"	1 1/2"	7"	11"	16"	8"	16"	22.48	25.75	25.42	26.06	.81	.25	214	196	1.09	410	53600	141	
2													17.16	23.12	22.75	23.5	1.75	.56	196	167	1.17	363			
3													5.39	13.5	13.79	14.38	5.25	2.88	106	51	2.08	157			
C 1	18 1/2"	36"	4.218	6 1/2"	7"	7"	1 1/2"	7"	11"	16"	8"	16"	25.42	25.75	26.5	26.06	.4	.25	167	159	1.05	326	42600	158.6	
2													17.16	19.5	20.6	20.1	1.55	1.25	149	125	1.19	274			
3													5.39	9.13	10.75	10.0	5.72	4.88	65	45	1.46	110			
F 1	18 1/2"	36"	4.218	6 1/2"	7"	7"	1 1/2"	7"	11"	16"	8"	16"	25.42	24.44	26.5	25.38	.4	.5	164	162	1.01	326	42600		
2													17.16	15.12	20.6	18.56	1.55	2.25	133	121	1.05	260			
3													5.39	6.25	10.75	10.0	5.72	6.62	32	47	1.11	99			

Fig. 4—Information Given by the Indicator Cards Arranged in Tabular Form.

possible to estimate the location of the actual curves from the theoretical results.

Actual indicator cards would be smaller than the theoretical cards as drawn, due to a higher back pressure, a drop in pressure in the receiver and wire drawing in the steam passages. The low pressure card will lose more area than the high on account of its greater piston area (the theoretical cards are based

with the 22 in. and 38 in. cylinders and the setting of the valves was changed to conform to the dimensions marked D in the table.

Figure 7 shows the curve *D* and plotted points from actual indicator cards which were taken. The points will be seen to fol-

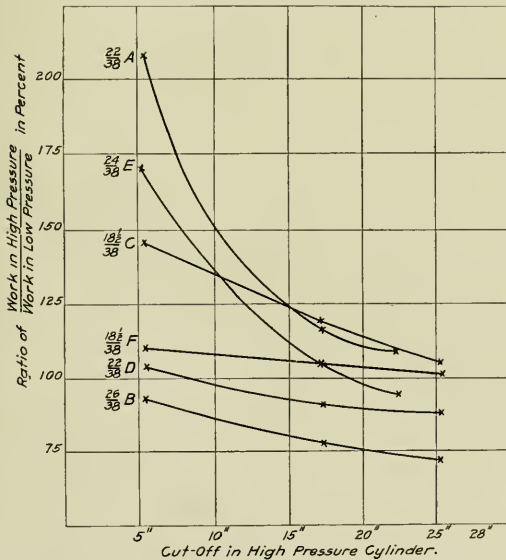

Fig. 5—Curves Showing the Theoretical Distribution of Power for the Conditions Given in Fig. 4.

on cylinder volume). The actual curves will, therefore, apparently lie higher on the chart than the theoretical curves, because the ratio of work in the two cylinders is larger.

This is proved by comparing the curve *J* and the plotted joints on Fig. 6. Curve *J* represents the same theoretical study for

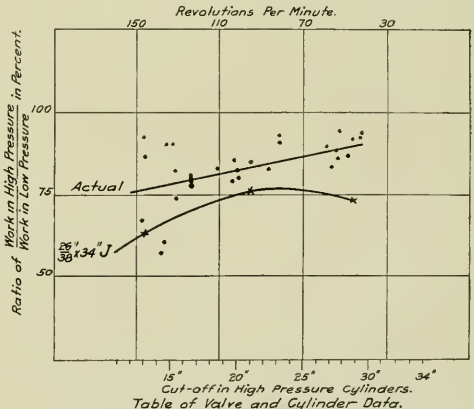

Table of Valve and Cylinder Data.

Diameter of Cylinders		H.P.	L.P.
26"		25"	36"
Valve Travel		6 1/2"	7"
Lap		1 1/2"	1"
Lead		1/16"	5/16"
Exhaust Clearance		3/8"	3/8"

Card	Cut-off		Release		Compression		Area of Card		
	High	Low	High	Low	High	Low	High	Low	Ratio
J 1	28.7	30.4	32.0	32.7	1.47	1.06	224	306	.73
2	20.9	23.7	28.7	29.9	4.09	3.11	195	258	.76
3	13.0	15.5	24.2	25.5	7.53	6.5	123	197	.63

Fig. 6—Comparison of Actual Conditions and a Theoretical Curve of Power Distribution.

low a line at about the same angle as curve *D*. This shows that a valve arrangement is being used which gives nearly equal work distribution at all speeds and cut-offs, as was predicted by curve *D*. The actual curve is, however, higher on the scale of work distribution, which confirms the statement made above that the

actual cards show more work done in the high pressure cylinder than the theoretical cards.

The actual cards with the cylinder ratio of 22 to 38 do not, however, give a work ratio of 1.5, the figure desired. The curve *F* must, therefore, be considered. This curve with 1½ in. and 38 in. cylinders gives a work ratio of about 105 per cent, and it may be judged that in actual service the same cylinders and valve arrangement would give a ratio averaging about 140 or 150 per cent. The steam lap and lead in the low have been changed in this curve in order to bring it more nearly horizontal.

As the desired work ratio is 150 per cent, it appears that the ratio of cylinders shown by curve *F* is none too large. We can then assume that the cylinder ratio can not be less than 4.2, as is used in curve *F*.

We have now answered the first two questions. In order to an-

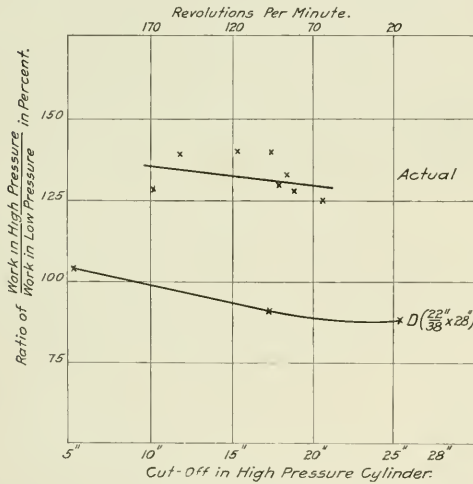

Fig. 7—Results of First Trial Compared with the Theoretical Curve.

swer the third, viz.: What sizes of cylinders are necessary to give the best return from the adhesive weight of the locomotive? it is necessary to have a correct formula for tractive effort for Mallet compound locomotives. We are dealing with a cylinder ratio very much out of the ordinary, and as the tractive effort does not vary in a direct ratio with the size of the high pressure cylinder alone, as is shown in column *X* of Fig. 4, which gives the tractive effort divided by the area of the high pressure cylinder. Nor does the tractive effort vary directly with the size of

Diameter of cylinders.	Admission pressure from theoretical indicator cards.	Ratio.	Cylinder areas.	Ratio = R.	
18½ in. and 38 in.	220 lbs. and 37 lbs.	5.95	269 sq. in. and 1,134 sq. in.	4.218	$\frac{\log 5.95}{\log 4.218} = \frac{.775}{.625} = 1.24$
22 in. and 38 in.	220 lbs. and 57 lbs.	3.86	380 sq. in. and 1,134 sq. in.	2.985	$\frac{\log 3.86}{\log 2.985} = \frac{.587}{.474} = 1.237$
26 in. and 38 in.	220 lbs. and 86 lbs.	2.56	531 sq. in. and 1,134 sq. in.	2.137	$\frac{\log 2.56}{\log 2.137} = \frac{.408}{.329} = 1.24$
Average.....					1.24

the low pressure cylinder alone, since the varying tractive efforts in Fig. 4 are all from the same size of low pressure cylinder. Therefore, those formulas which are based on either the high pressure cylinder or the low pressure cylinder only, cannot be used.

The formulas given in Fig. 8 show what has been proposed so far, with the results they give for two ratios of cylinders. It will be noted that the results differ very much. Tractive effort of 68,800 lbs. and 61,050 lbs. are obtained by the formula about

to be developed. The first corresponds most nearly to the Baldwin formula No. 2 and to D. F. Crawford's formula, whereas in column *B*, 61,050 lbs. correspond most nearly with Baldwin formula No. 1, and to G. R. Henderson's formula. This shows that the new formula is of different form and gives results which do not follow any of those previously in use.

The Baldwin formulas will not apply to all ratios of cylinders, as they are based entirely on the size of the high pressure cylinder. The formula of B. R. Van Kirk will not apply, since it makes the ratio of work decrease as the cylinder ratio increases, whereas the charts just discussed show the opposite to be true. The formulas of D. F. Crawford and Geo. R. Henderson seem to be more nearly adapted for our use, but they will not apply for the following reason.

Change the formula to the following form:

$$T. E. = \frac{1.7 \times P \times C_1^2 \times S}{(R + 1) D} = \frac{1.7 \times P \times C_2^2 \times R \times S}{(R + 1) D}$$

which is true because $C_1^2 = R C_2^2$. Notice that for very large values of *R* the formula approaches the value

$$T. E. = \frac{1.7 \times P \times C_2^2 \times S}{D}$$

which is twice as large as it should be.

The formula of the American Locomotive Company, would of course, be correct if a table showing the correct value of *k* for all values of *R* was available. Such a table, however, has not been published.*

An examination of the theoretical indicator cards drawn for the different cylinder ratios shows that starting cards are very nearly rectangular in form, and their areas can be easily figured if the pressure in the receiver is known, since the mean-effective-pressure in the high is the difference between the boiler pressure and the receiver pressure, and the mean-effective-pressure in the low is approximately the receiver pressure. These pressures should be reduced by a factor, such as .85, just as is done in the formula for single expansion engines.

The problem then is to find the receiver pressure for all ratios of cylinders. The formula which gives this pressure must be such that if the ratio be either one or infinity the formula will become

$$\frac{D}{.85 P_1 C_1^2 S}$$

This means that in the formula for receiver pressure *R* (the ratio of cylinders) must appear in the denominator by itself or raised to some power. The receiver pressure is always some fraction of the boiler pressure, therefore, the formula adopted must have the form $P_1 = P \div R^x$. It is then necessary to determine what value of *x* must be used.

This will be done by working backwards from the pressures on the theoretical indicator cards as is shown in the following table:

The value of *x* is therefore 1.24, and the formula for tractive effort becomes

$$T. E. = \frac{.85 S (P_1 C_1^2 + P_b C_b^2)}{D}$$

$$\text{Where } P_1 = P \div R^{1.24} \\ P_b = P - P_1$$

This formula will be used in determining the size of cylinders necessary to utilize the adhesive weight of the locomotive.

*[The values of *k* used by the American Locomotive Company are derived from actual tests and include the normal range of *R* only.—EDITOR.]

The weight on drivers in this case is 268,000 lbs. Assume that 9/40 of this weight is a proper drawbar pull. The factors 1/4, 9/40 or 1/2 have been established by practice. In the case of single expansion engines the tractive effort has always been figured by a formula which gives the tractive effort at the drawbar. The formula just derived also gives the tractive effort at the drawbar, so the same adhesion factors will apply.

$$268,000 \text{ lbs.} \times \frac{9}{40} = 60,300 \text{ lbs. tractive effort desired.}$$

In Fig. 8 the 68,800 lbs. was derived from this new formula using 26 in. and 38 in. cylinders. Trial will therefore first be made with a 24 in. high pressure cylinder and, as previously decided, a cylinder ratio of 4.2. If low pressure cylinders 49 in. diameters are selected, the ratio is 4.17. Then,

$$P_1 = \frac{220 \text{ lbs.}}{4.17^{1-21}} = 37.6 \text{ lbs.}$$

$$T. E. = \frac{.85 \times 28}{73} (37.6 \times 2,400 + 182.4 \times 576) = 63,600 \text{ lbs.}$$

As this is too large, a trial with smaller cylinders must be

C_h = diameter of H.P. cylinder in inches	P = boiler pressure
C_L = diameter of L.P. cylinder in inches	P_1 = absolute pressure = $P + 14.7$ lbs.
S = stroke of piston in inches	R = ratio of cylinders
D = diameter of driving wheels in inches	T = tractive effort
Baldwin Locomotive Works	
Formula 1 $T = \frac{C_h^2 \times S \times k \times P}{D}$	76000 lbs. 62200 lbs.
Formula 2 $T = \frac{C_h^2 \times S \times k \times P_1}{D}$	68450 lbs. 58000 lbs.
B. R. Van Kirk $T = \frac{C_h^2 \times S \times .53 P}{D} + \frac{C_L^2 \times S \times .30 P_1}{D}$	71300 lbs. 38700 lbs.
D. F. Crawford $T = \frac{4.7 \times P \times C_h^2 \times S}{D}$	66100 lbs. 64000 lbs.
G. R. Henderson $T = \frac{1.6 \times P \times C_h^2 \times S}{D}$	62300 lbs. 60200 lbs.
American Loco. Co. $T = \frac{C_h^2 \times P \times k \times S}{D}$	64500 lbs.
Paul Weeks $T = \frac{.85 \times S (P_1 C_h^2 + P_h C_L^2)}{D}$	68800 lbs. 61050 lbs.
Where $P_h = \frac{P}{R^{1.24}}$ and $P_h = P - P_1$	
Column A gives results for a locomotive with 26" and 38" cylinders, 28" stroke, 73" drivers, $R = 2.196$	
Column B gives results for a locomotive with 23 1/2" and 48" cylinders, 28" stroke, 73" drivers, $R = 4.17$	

Fig. 8—Tractive Effort Formulas for Articulated Locomotives.

made. 23 1/2 in. high pressure and 48 in. low pressure cylinders also give a ratio of 4.17, and the tractive effort equals:

$$T. E. = \frac{.85 \times 28}{73} (37.6 \times 2,304 + 182.4 \times 552.5) = 61,050 \text{ lbs.}$$

This gives an adhesion factor of 4.39, which is very nearly 9/40. Cylinders 23 1/2 in. and 48 in. in diameter are therefore the correct size for this locomotive.

CONCLUSION.

The problem called for the answers to three questions. These are repeated and accompanied with the correct answers.

What valve arrangement will give a constant ratio of work between the two pairs of cylinders at all speeds and cut-offs? It appears that the proper valve setting is with the steam laps in the high and low pressure cylinders nearly equal and of the proper length to give a maximum cut-off at about 90 per cent. of the stroke.

What ratio of cylinders is necessary to give a correct ratio of work? In this case where the high pressure cylinders must do 1.5 times as much work as the low, the low pressure cylinders must be about 4.2 times as large as the high.

What sizes of cylinders are necessary to give the best return from the adhesive weight of the locomotive? As the locomotive under consideration has 268,000 lbs. weight on the drivers, 28 in. stroke and 73 in. drivers, the cylinders must be 23 1/2 in. and 48 in. in diameter.

LOCOMOTIVE CAB FURNISHINGS

BY ALDEN B. LAWSON.

Most railroads have, at one time or another, been in controversy with their engineers regarding the accommodations on the locomotives. Various designs of seats, seat boxes, arm rests, etc., have been tested to meet the views of the men, whose comfort should have due consideration. In the modern locomotive the space in the cab is often crowded and it is difficult to locate

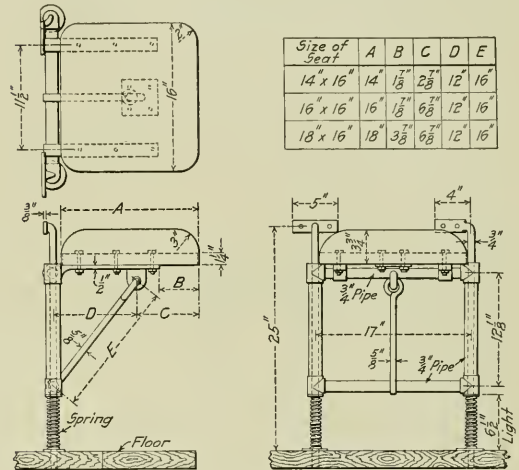

Fig. 1—Drop Spring Seat.

all the fittings conveniently and just where the engineer can reach or see them without moving from his seat.

The seats, arm rests, etc., which are described in this article have been adopted as standard by a large railroad and in doing so the wishes of the men were carefully considered and every effort made to conform to them as far as possible. The engineer's seat shown in Fig. 1 is a drop type, rigidly secured to

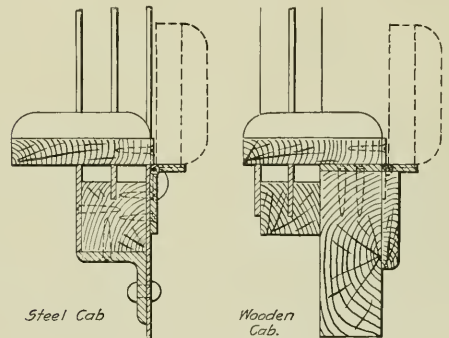

Fig. 2—Hinged Arm Rest.

the side of the cab, and is fitted with springs. To suit all classes of locomotives three sizes are used, as shown in the table, the larger size being applied wherever possible. The seat is held in position by an arm and when it is desired to lower it, it is raised sufficiently to permit the arm to disengage from the support, the seat then dropping against the side of the cab. The covering for the cushion may be easily obtained from old Pantasote car curtains, etc.

Various types of arm rests have been tried out, some loose,

some screwed into position and some attached by a chain so that when it is desired to close the windows the arm rest may be

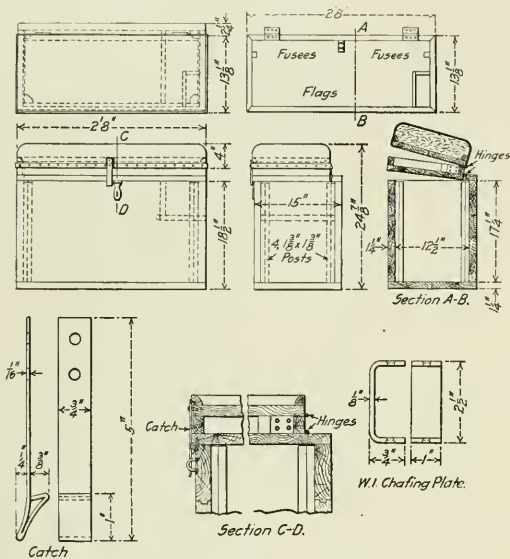

Fig. 3—Combined Seat Box and Flag Holder.

removed. None of these types were entirely satisfactory, and many were either lost or thrown away. To overcome this, the

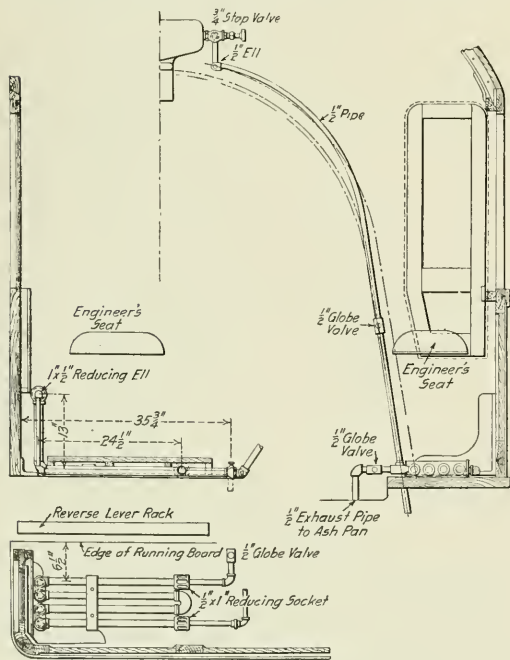

Fig. 4—Details of Cab Heater.

hinged type shown in Fig. 2 was adopted. This is hinged to the window sill in such a way as to permit its being swung out

of the way when it is desired to close the windows. A shelf is fastened to the cab to support it.

The fireman's seat box shown in Fig. 3 combines a seat and a box for flags and fuses, as well as providing a receptacle in the bottom for clothes and other private property. The flags, fuses and torpedoes being in a separate compartment, may be neatly arranged and do not become mixed in with the tools, etc., as is often the case when a separate box is not provided. The box is secured to the cab floor and may be locked to secure the fireman's personal property, leaving the flag box unlocked so that its contents are accessible at all times.

The cab heater shown in Fig. 4 is used only under the engineer's seat, and consists of four or five lengths of 1-in. pipe, depending on the width of the cab, connected by return bends and

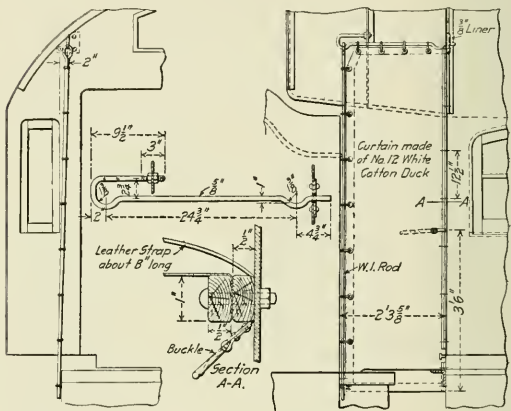

Fig. 5—Side Curtain Fitted with Anchor Rod to Prevent Flapping.

elbows, and resting on the cab floor. These pipes are extended up behind the engineer's back and very materially add to his comfort during cold weather. On passenger locomotives, the steam supply is taken from the train heater pipe beyond the reducing valve, and on freight locomotives the heater pipe is connected to the manifold or turret in the drawing. The waste valve is left slightly open to prevent condensation and freezing, and a wooden tread is used to cover the steam pipes.

The side curtain shown in Fig. 5 is made of white duck and is fitted with an anchor rod at the back to hold it in place and prevent flapping and tearing. Wrought iron edge rings are inserted for the guide rod, one end of which extends through the back of the cab, while the other end is secured to a carline on the roof extension, and is arranged with nuts so it may be readily taken down.

PENALTIES UNDER FEDERAL LAWS.—The total amounts, exclusive of costs, collected from the railroads as penalties under the Safety Appliance, Hours of Service and Ash Pan laws, as of November 1, 1912, are as follows: Safety Appliance Law, \$259,900; Hours of Service Law, for trainmen, \$40,921; for telegraphers, \$11,715; and for failures to file reports, \$500; Ash Pan Law, \$3,400. The grand total was \$316,436.

STEAM TURBINE ADVANTAGES.—The benefits from using superheated steam are not the same in the turbine and reciprocating engines, although they are considerable in both. The increased economy of the reciprocating engine using superheated steam is because of reduced initial condensation and valve leakage. The turbine benefits by the reduced frictional resistance offered to the rotor by the dryer steam, in addition to the reduction of steam leakage past the blades.—*Power.*

SHOP PRACTICE

SELECTION OF OPERATORS FOR OXY-ACETYLENE WELDING

BY J. C. REID.

Oxy-acetylene welding and cutting, which was introduced into the United States about seven years ago, is being extensively used in railroad shops, and is by many considered one of the most important factors in repair work. Its field of application is broad, and its money-saving possibilities are surprisingly large. In welding it is not restricted to any particular class of metal; steel, cast iron, brass, aluminum, etc., can be worked. In cutting it is restricted to steel, wrought and malleable iron, but its cutting speed in these metals may fairly be compared with that of a sharp saw through soft pine, and the cut is very nearly as smooth.

Oxy-acetylene welding is considered a poor investment by many railroads, and the welds made by the process very unsatisfactory. If some one would visit each person who has this impression and find out the direct cause of it, the writer believes that in nearly all cases it would be found to be based on some piece of work or demonstration performed by an incompetent welder. There are many people who claim to be oxy-acetylene welders, and who, when given an opportunity to demonstrate their ability, show that they know almost nothing of the work; it is such men that have given many people a poor opinion of the process. The art of oxy-acetylene welding is not one that can be mastered in a few days, or even in a few months. Something new turns up each day, which necessitates study and research to determine just how to proceed in order to make a success of the work. I have in mind a certain man who is considered one of the best welders in the United States; when asked if he was an expert he replied, "I am not an expert, but merely learning."

When a welding plant is installed one of the first problems which arise is that of selecting a man to handle it. The one chosen may be a machinist, machinist handyman, machinist's helper, boiler maker, boiler maker handyman, boiler maker's helper, or possibly the job will be advertised on the bulletins and given to the first applicant. The writer has had several years' experience with oxy-acetylene, both in doing the actual work and in instructing others, and can say from experience that there are some people who can never make successful welders. There are others who, in their own estimation, can learn it in a few weeks; while there are still others who are quick to take to the work, become interested and learn something each day no matter how long they continue. The man selected may be of the latter type, and still after several months his work may not give satisfaction.

If boiler and general repair work is to be done, which is the case in practically all railroad shops, there should be a boiler maker put on the work and not a machinist. He should be a good practical boiler maker; one who can think for himself and does not need to be told how to do each individual job. He should know the effect of heat on iron, so that he will understand just where to direct his torch in order to produce a draw on any part of the work. He should be thoroughly acquainted with patch work, so that he will know just how to cut out a patch to obtain the best results, and he should oversee the laying out of patches preparatory to welding. If the shop is large enough, there should be a boiler maker assigned to do the work of laying out patches, etc. He will soon become familiar with it and will seldom have to call on the welder for help as to how to proceed.

A large part of the success in welding is due to preparing the

job for the weld and knowing when and how to pre-heat. Some patches, for example, require corrugation; others a slight roll, while still others require neither. The majority of machinists would be at a loss to know just how to handle this work unless they had had considerable boiler experience, which is seldom the case. Much damage may be done in a firebox by one unfamiliar with boiler work.

Most of the railroads that use the oxy-acetylene process keep a record of all the work done in order that it may be seen at a glance how much money and time the machine is saving the company each month. These reports should be made out daily by the operator and should allow for the time to prepare the work for the weld, time consumed in welding, labor, oxygen and acetylene gas, material, and time to complete the job after the weld is made. The time and cost of doing the same job by the old method should also be shown and at the end the saving effected by using the oxy-acetylene process should be given. Here again, the advantages of a boiler maker over a machinist are evident. Being thoroughly acquainted with boiler work and knowing all the piece work prices, he can readily compute the cost of doing the job by the old method.

Many companies have trouble in keeping a man after he becomes a good welder. From the record he keeps he sees that he is saving the company a large amount of money, and if his rate of wages is not raised he soon becomes dissatisfied and leaves. It is essential that the man receive a fair rate of wages, which should be a few cents more than a boiler maker's rate, for if he becomes dissatisfied it is easy for him to shirk, as he is probably the only man around the plant who knows anything of the work.

Beginners in this work all seem to be afraid to try vertical and overhead welds, such as patches in side sheets or crown sheets. After they have done some of this work, and have learned how to control the metal, they find the work becomes more simple each day.

REPAIRING INJECTORS

BY CHAS. MARREL,

Shop Foreman, Chicago & North Western, Clinton, Ia.

The standard method of repairing injectors in use on the Chicago & North Western has been very successful. Injector failures have been greatly reduced, on some divisions being practically eliminated, since its introduction. This system centralizes the repairs at one point on each division and includes the furnishing of limit gages and complete instructions for procedure to each engine house or other point where injectors are inspected. Blue prints are furnished each of the designated repair shops giving the name and pattern number of every part of all sizes of injectors in use, and when a new part is required it is ordered from the Chicago shop where all parts, finished to standard size by the use of jig and box tools, are kept in stock. All engine houses are furnished with hand tools for reseating the steam or jet valve seat without taking the injector from the locomotive. The division repair shops have limit gages as to range of wear allowable and a set of special tools for making complete repairs to all parts.

When an injector is reported not working the instructions require that the inspector shall first see if the opening is free between the check valve and the injector, next to see if the branch and feed pipes have an air leak and if the tank hose and tank well are tight. If these are found to be in good condition, the injector is removed from the locomotive and a repaired one sub-

stituted for it. It is then sent to the division repair shop where it is immediately repaired and returned.

All injectors sent to the shop are first taken apart at the throttle, the jet and the water opening and are placed in a muriatic acid bath where they remain until no agitation of the acid is seen, when they are washed with clear water. They are then taken to a bench where the body part is separated from the front part by a special clamp and screw which separates them without hammering, wedging or damaging any of the parts. The nozzles are then pressed out under a screw press and if not worn practically to the limit are again returned to place. All repairs are usually made at the bench and in the vise without taking any part of the injector to a machine. The only machine operation required is when the jet seat is worn to the limit. It is then taken to a lathe which holds and centers it in a special chuck and the seat is drilled and bored out and tapped with a special tap. A special pattern of brass bushing is then screwed in place and drilled and reseat, bringing it to standard size. Standard gages are provided for all parts that may need repairs and each new part is formed to fit the proper gage. If the threaded connection where the steam or water inlet pipe connect is worn and has poor threads, it is expanded by a roller and a solid die is run over the thread. Hand tools are used for facing all ball joints and the joints on the body where the jet and throttle bonnets screw in, as well as for reseating bonnets if they require it.

At stated periods, an injector repair expert visits the division engine houses and inspects their tools, gages and methods. This insures these points having good standard tools on hand and keeps the injector repairman at the small terminals posted as to the latest tools and best methods of doing the work.

PRESSING IN PISTON VALVE BUSHINGS

BY V. T. KROPIDLOWSKI.

In pressing in valve chamber bushings it is general practice to do the work by hand, which requires two men working from one to two hours for each bushing. At the suggestion of the general foreman of the shop with which the writer is connected, an arrangement of gearing operated by an air motor was de-

The same illustration shows the new arrangement, the rod, heads *E* and *F* and nut *G* being retained, but instead of the wrench the train of gearing is attached to the nut and the motor replaces the men.

The other illustration shows the detailed construction of the gearing, as assembled in the sheet steel frame. The gears of a discarded lathe were made use of to avoid the expense of cutting new ones; they have a width of face of 1 in. To make the gear *A* suitable for turning the nut *G* it was necessary to turn a countersunk depression in its body and rivet a wrought-iron disk *K* to it. The gear with the disk fastened to it was then bored out for the hub *I* to be pressed in. This hub is hexagonal on the inside to fit the nut *G*. The spindle *D* is of tool steel, one end of which is turned to a Morse taper to fit the motor socket. The body is then turned down to 1 1/4 in. diameter and is milled with teeth to mesh with the gear *C*, the other end being again turned down to 1 in. diameter and threaded to receive the nut *S*,

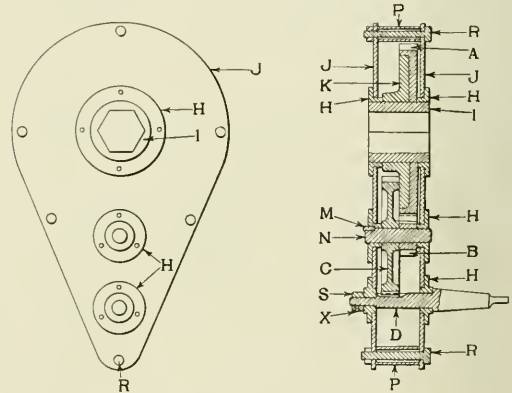

Machine for Pressing in Piston Valve Bushings.

which is held in place by the dowel *X*. The diameter of the pitch lines of the gears in the train are as follows: *A*, 11 1/2 in.; *B*, 2 1/2 in.; *C*, 8 in., and *D*, 1 1/2 in.

The frame *J*, which also forms the casing, is made of 3/16-in. sheet steel. It was first roughly punched out in a punching machine to the shape shown with a 1/4-in. punch, and the periphery was afterwards trued up on an emery wheel. It was then put under a steam hammer and straightened. The necessary holes were drilled and the larger ones bored out; brass bushings, *H*, were pressed in and riveted to the plate, serving as bearings. The sheets are held in place by the bolts *R*, and parted by the pipes *P*, and the periphery is closed by a galvanized-iron band.

This arrangement has given good satisfaction and with a No. 1 Little Giant motor, has ample power for the work. On one occasion it appeared to work so easily that the foreman thought the bushing was too loose; but when he detached the machine and had a man try to turn the nut with a 36-in. wrench, he could not move it, and two men could barely turn it.

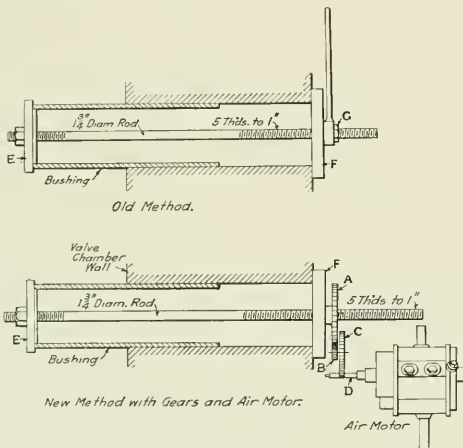

Old and New Methods of Pressing in Piston Valve Bushings.

signed, by means of which the time is reduced to half an hour and but one man is required.

One of the illustrations shows the old method of pulling in the bushing by hand by means of a wrench revolving the nut *G*.

DEFECTIVE APPLIANCES ON RAILROAD ROLLING STOCK.—The report made to the Interstate Commerce Commission by the chief inspector of safety appliances states that during the fiscal year 1912 there were inspected 451,090 freight cars, of which 29,091, or 6.44 per cent., were found to be defective. The number of defects reported was 34,337. There were 17,120 passenger cars inspected, of which 348, or 2.03 per cent. were found to be defective, the number of defects reported being 780. The total number of locomotives inspected was 22,182, of which 697, or 3.14 per cent., were defective. The number of defects reported was 904.

PAINTING STEEL PASSENGER CARS*

Artificial Method of Drying Saves Ten Days on Each Car and Gives a More Durable Surface.

BY C. D. YOUNG,
Engineer of Tests, Pennsylvania Railroad.

The artificial driers and gums ordinarily used in hastening the time of drying and hardening of the various coats and permitting the necessary rubbing, continue their action so that the paints and varnish increase in hardness and brittleness, rendering them susceptible to cracking and chipping, and the process of disintegration is hastened by the excessive expansion and contraction of the steel surfaces as compared with wood. The linear expansion of steel being more than twice that of wood would seem to indicate the use of more elastic coatings than formerly used for wooden cars.

This fact has been borne out in the service of the paint

for interior finishing under the present existing practice of painting steel.

To obtain some data indicating what should be done to meet the conditions, preliminary experiments were made by painting a number of panels and baking them in a heated oven. Repeated experiments along this line indicated that artificial driers could be almost, if not entirely, eliminated in the paint formulas and that more elastic materials could be used without the aid of artificial oxidizing agents. It was also observed that the elastic varnish used on the exterior of the cars could, under this system, be used to advantage on the interior, and by the aid of the heat of the oven they could be dried to the desired hardness, permitting the rubber with oil and pumice to get a flat finish.

The outcome of the experiments indicated that it would be desirable to extend the experimental panels to a full size car and, therefore, a proper baking oven was planned that would accommodate one of the largest existing steel passenger cars for the purpose of baking each coat as applied to the exterior and interior surfaces.

This oven is 90 ft. 3 in. long, 13 ft. wide and 15 ft. high. The frame work is made up of 3-in. I-beams for the sides,

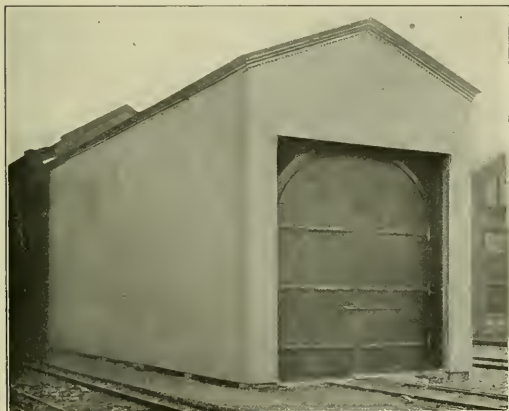

Exterior of Oven Used for Baking Paint on Steel Cars.

in a great many cases in an investigation which recently came under my observation. It was noticed that when some of the equipment had been in service about four months, the interiors of the cars were showing varnish cracks and checks. As time went on, more cars gave evidence of this deterioration, the final outcome being that an investigation was made to see how serious the condition was. Some 400 cars were carefully examined, special attention being paid to choose cars built by various manufacturers, where different makes of surfacers and varnishes were employed. An endeavor was also made to determine whether the cracking of the painted surfaces was confined to the varnish coats or the surfacer coats, or both.

The result of this examination showed that the exteriors, including the sides, ends and vestibules, were in fair condition. There were a few exceptions to this, but they amounted to less than 6 per cent. of the total having serious varnish and surface cracks. Interiors were found generally to be in a poor condition. About 80 per cent. of the equipment examined had the varnish checked through to the surfacer.

Some of these conditions developed after four to eight months' service, indicating either that an entirely new system of painting would be necessary to overcome these troubles, or that a more elastic paint would have to be used



A Steel Car in the Oven.

spaced 5 ft. centers. The roof framing is made of the same sections and curved to conform closely to the contour of the car roof. Each end of the oven has two large doors. The oven is lined on the inside with $\frac{1}{8}$ -in. steel plate, and on the outside with galvanized iron of 0.022 gage. The 3-in. space is filled with magnesia lagging, thus effecting the needed insulation. The doors are insulated in a similar manner. Along the walls of the interior of the oven are placed 16 rows of $1\frac{1}{2}$ -in. steam pipes, and along the floor, close to the walls, are arranged manifold castings with small lengths of pipe tapped in them at right angles. By this means over 2,000 sq. ft. of heating surface is provided. A

*Abstract of a paper presented at the Railway Session of the American Society of Mechanical Engineers, April 8, 1915.

steam pressure of approximately 100 lbs. to the square inch is used, making it possible to get an oven temperature of over 250 deg. Fahr. Rectangular openings, made adjustable, are provided on the sides near the floor line, allowing the necessary admission of air for circulation. Four 8-in. Globe ventilators are spaced at equal distances in the roof, likewise provided with dampers to regulate the size of the opening. By this means of ventilation, fresh air, which is required for the proper drying of paint, is obtained, as well as providing for the egress of the volatile matter present. Automatic ventilation and steam regulation have not, at the present time, been applied, but these have been considered advisable, if the result of the experiment seems to warrant a more extended application of the practice.

A track is placed on the floor of the oven and connected at each end with other tracks leading into the regular paint shop where the different coats of paint are applied to the car before each baking operation.

The method of painting a car in this oven is briefly as

the outside, pale green, bronze, and bronze green on the inside, are then put on. Two coats of each color are required to get standard shades. Each coat of color is likewise baked.

TIME SCHEDULE FOR PAINTING EXTERIOR AND INTERIOR OF STEEL PASSENGER CARS.

Period of Work	Body	Outside		Inside			
		Roof	Trucks	Body above window	Head	Body below window	SHES
1	1st prime	1st prime	1st prime	1st prime	1st prime	1st prime
2	glaze	glaze	glaze	glaze	glaze
3	1st surface	rub ground	rub	rub	rub
4	2d surface	2d prime
5	3d surface
6	rub
7	1st tuscan	3d prime	2d ground	1st green	1st green
8	2d tuscan	stipple
9	stripe and letter
10	1st varnish	truck	1st varnish	2d green
11	2d varnish	color	2d varnish
12	3d varnish	3d varnish	1st varnish
13	rub	2d green	air dry

The car then receives the required lettering, striping, etc., after which the outside and inside surfaces get three coats

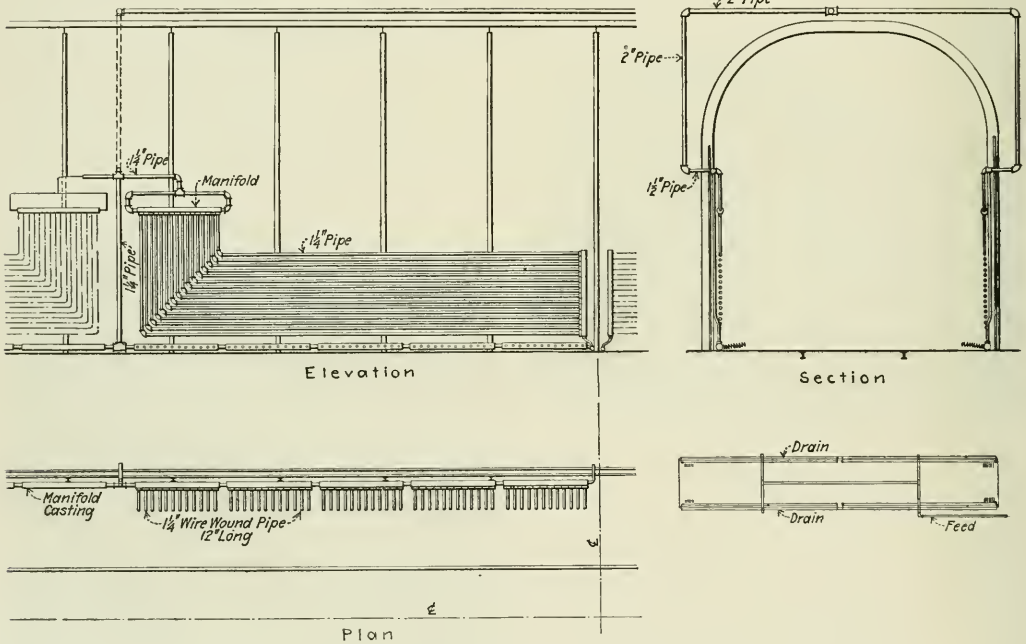

Steam Piping in Oven for Baking Paint on Steel Passenger Cars.

follows: First, a priming coat is given the exterior and interior of car, which is then moved into the oven and baked for three hours. The temperature at the start is about 160 deg., but rapidly rises at about 1 deg. per minute until a temperature of 250 deg. is reached, requiring about 1 1/2 to 2 hours. The oven is held at this temperature until the lapse of 3 hours, when the car is withdrawn, allowed to cool sufficiently to work on, after which the surfaces are glazed and depressions and uneven places puttied. The car then receives its first coat of surfacer, is returned to the oven for 3 hours, baked and removed for additional coats which vary from two to three in number as the needs of the case require.

After the last coat of surfacer has been applied and baked, the outside surface of the body of the car is rubbed down with emery cloth and oil to produce a flat and smooth surface. The various color coats used, such as tuscan red on

of a high grade finishing varnish, especially adapted for the baking process. Each coat of varnish is baked at a temperature from 120 deg. Fahr. at the start to 150 deg., which is maintained until the expiration of 3 hours. The interior surfaces of the car are then rubbed with pumice and oil, giving the flat finish desired, thus completing the painting of the car.

To illustrate better the schedule of operation followed, or the timing of the various coats, both for the outside and inside of the car, to secure the most economical conditions, the above table is given. The column headed "Period of Work" does not necessarily refer to days, as in some cases three of these periods are performed in one day.

All of the work done by the baking process of painting can be accomplished in six to eight days, thus effecting a saving in time of about ten days as compared with the

standard or present air drying system. Further, the paints and varnishes have been worked up so that they are especially adapted for this baking process, having greater elasticity. Exact formulas for the various mixtures are well defined, so that uniformity in material is expected, thus giving greater durability, better appearance and longer life for the paint work.

The checks and cracking previously found will be considerably lessened, if not almost removed. By oven painting the work is done under more uniform conditions, which at the present time are so hard to control. It enables the surfaces of the car to be heated uniformly and dried thoroughly, thus removing any objectionable moisture before the first priming coat is applied, which is a very desirable feature of the new method.

A considerable saving will be effected by the shorter time that cars will be held out of service when undergoing repairs and repainting in the shops. It is expected that dirt, soot, etc., will not adhere or imbed themselves so readily and that the general appearance of the car will be improved by the baking method.

This oven was placed in service the early part of this year, and the results of the complete car at this time seem to justify the experiment. They seem to indicate that the results obtained from a small panel can be duplicated in the full size passenger equipment car and that, if this is the case, this method of painting can not only be used to advantage for the painting of steel passenger equipment cars, but for the painting of any other full size steel structure of a similar character where protection and finish are desired.

PNEUMATIC CHUCK FOR STAYBOLT DRILLING

BY J. C. BREKENFELD,

Assistant Machine Shop Foreman, St. Louis & San Francisco, Springfield, Mo.

The illustrations show a device that was designed to reduce the breakage of drills to a minimum and increase the output of the machines in drilling 7/32-in. holes, 1½ in. deep, in staybolts

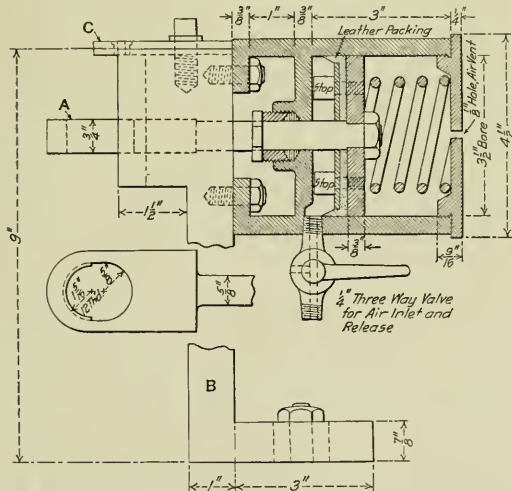

Details of Pneumatic Chuck for Drilling Staybolts.

for locomotive boilers, in order to comply with the government requirements. Before the introduction of this pneumatic chuck, the method used was that of screwing a hardened tool-steel cap

on the staybolt for a drill guide, and holding the bolt in a small chuck with a V cut on one of the sides; a handle was provided to hold the bolt in the V of the chuck. The breakage of drills by this method was excessive, there often being as many as six or eight broken per day in drilling from 175 to 300 bolts on a machine.

Having available three drilling machines of one type, it was decided to place them close together and equip them with pneumatic chucks. Heavy galvanized-iron chutes were placed underneath the tables to convey the bolts and lubricating liquid to a pan on the floor, so located as to serve all three machines. A small geared circulating pump was placed at the back of the base of one machine and belted to the smallest driving pulley cone. A ¼-in. pipe was led from the pump to each machine, just back of and through the machine column to the height of the top of the chuck, and a ½-in. pet cock was used to regulate the flow of lubricant. In the operation of the chuck air is admitted behind the piston, which draws in the clamp A. A staybolt having been previously placed in this clamp, the action of the air pressure holds it firmly in the V-shaped notch in the

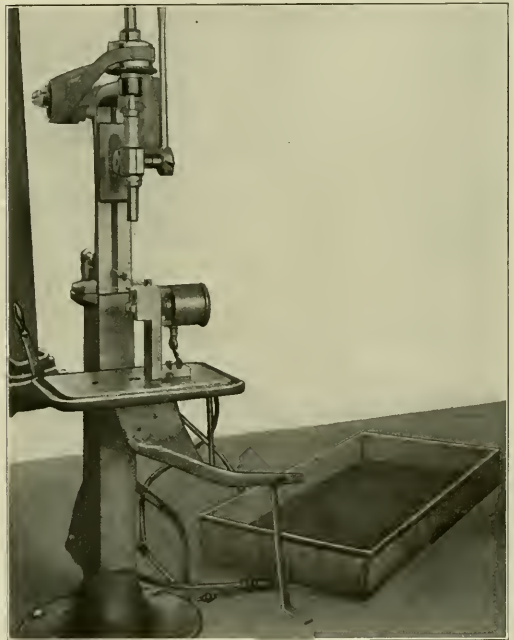

Pneumatic Staybolt Chuck Applied to a Drill.

chuck body B. The bolt is thus centered under the small hole in C, through which the drill is guided.

The original feed handles on the machines were only 12 in. long, but these were increased in length to 18 in. and made of ½-in. gas pipe so as to be light enough for the counterbalance spring of the spindle to raise the drill out of the staybolt after the right depth had been drilled. This leaves the operator's right hand free to release the air chuck, and the left hand free to place another bolt in the chuck. The drilled bolt, on being released, falls through the table and follows the chute to the pan on the floor, from which the bolts are delivered to the stores department by laborers as often as the pan requires to be emptied.

With these changes and the machines speeded to 800 revolutions per minute, the output of each machine was increased to

about 800 bolts per day of nine hours, and the breakage of drills was reduced to only one or two each day, sometimes none being broken. The average drilling time is thirty seconds per bolt.

DIAGRAM OF MACHINE TOOL OPERATION

BY L. R. POMEROY.

The accompanying diagram permits information to be quickly and accurately obtained in an investigation of the amount of metal removed by a machine tool, as well as the horsepower required, when it is operating under various conditions of cuts, feeds and speeds. The scale at the bottom of the left half of the diagram gives the depth of cut in inches, which will be one-

example shown by the dotted line indicates that a machine working with a 1/2-in. depth of cut and a 1/8-in. feed and running at 80 ft. per min. cutting speed will remove 60 cu. in. of metal a minute. This would require 24 horsepower if the metal was cast iron, 36 horsepower if of wrought iron or steel, and 60 horsepower if steel tires were to be turned. To indicate another way of using the table, we will assume that a lathe has a motor which will deliver 20 horsepower for the length of time that the operation requires. Assume that a cast-iron piston head, 24 in. in diameter, is to be turned. The machine is assumed to be fitted with speed changes such as will allow a speed of 95 revolutions a minute of the spindle to be obtained, which will give a cutting speed of about 60 ft. per minute. If the diameter is to be reduced 3/4 in. the depth of cut will be 3/8 in. Referring to the table, it will be seen that 20 horsepower for cast iron is

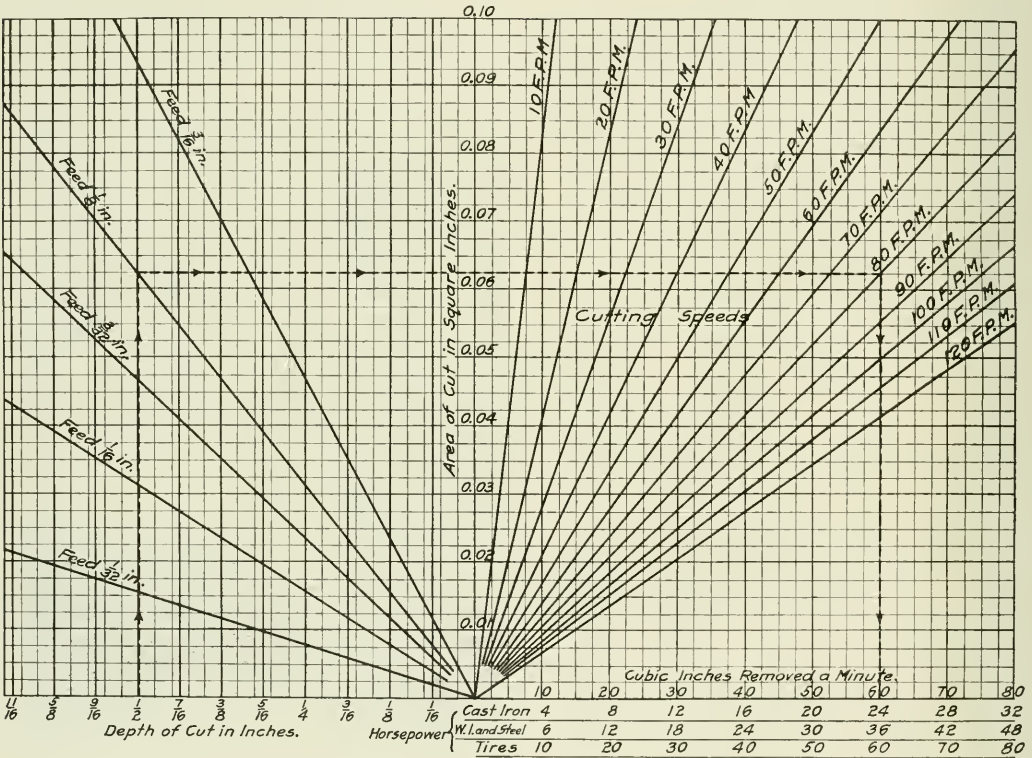

Diagram Giving the Relations of Feeds, Cuts, Cutting Speed, Metal Removed and the Horsepower for Machine Tools.

half of the reduction in diameter in the case of lathe or boring mill work, and above it are diagonals marked for various feeds from 1/32 in. to 3/16 in. The combination of the depth of cut and the feed will, of course, give the area of the cut in square inches and this is shown in the scale at the center of the table. In the right half of the diagram are shown the cutting speeds from 10 to 120 ft. per minute. The area of the cut multiplied by the cutting speed will give the cubic inches of metal removed a minute. This is shown on the bottom scale of the right-hand half of the diagram. Directly below this is given a scale of the horsepowers required for doing the work on three different materials, viz.: cast iron, wrought iron and steel, and steel tires. This horsepower indicates the size of the motor required on the machine for the work.

equivalent to the removing of 50 cu. in. of metal a minute. Following on the line through the point 50 up to the diagonal line marked 60 ft. per minute cutting speed and then directly across until the vertical line from 3/8 in. depth of cut is intersected, it is found that a feed of about 3/16 in. will be required to develop the full power of the machine. Other methods of using the table will readily suggest themselves to the foreman or operator.

SUBWAY FOR GENOA, ITALY.—Genoa is confined to a comparatively narrow territory, between the mountains and the sea, and can only grow at the two ends. Two engineers, E. Ravà and S. Cattaneo, have planned a subway and elevated railway to serve it, from a suburb on the west to one on the east, a distance of a little over 6 miles, about three-fourths of which will be underground. The cost is estimated at \$5,000,000.

This diagram can, of course, be used in various ways. The

APPRENTICESHIP ON THE ILLINOIS CENTRAL

Both the Shop Apprenticeship Methods and the Co-Operative Plan Possess Unique Features.

A general system of apprentice instruction was established on the Illinois Central and Central of Georgia last July under the direction of the Educational Bureau, a department established on these roads in 1911 for the purpose of providing free instruction to the employees who desired to educate themselves further in their respective fields of railroading. Although these roads have employed apprentices before this time, there were no instruction classes held except at Water Valley, Miss., and Vicksburg.

The Educational Bureau having become thoroughly established was in a position to handle the apprentice instruction in an effective manner, and under the direction of D. C. Buell, chief of the bureau, nine schools on the Illinois Central and one on the Central of Georgia were in full operation within two months' time, the lesson papers being prepared by the Bureau. The handling of the problem in this way makes it possible to operate these schools at a reasonably low cost. The following table shows the operating cost for the two lines:

Road.	Miles.	Num-ber of ties en-rolled.	Cost per year.	Cost per school per year.	Cost per apprentice per year.	Cost per mile of road per year.
I. C.	6,127	9 365	\$9,000	\$1,000	\$24.66	\$1.47
C. of Ga.	1,914	1 75	1,500	1,500	20.00	.78

After a careful study of the situation it was decided to have 30-minute class sessions, beginning at 7 o'clock in the morning; this allows ten classes to be handled each morning. In all but the Burnside shops at Chicago, it is possible to finish the class work before noon. This length of session was chosen because it was believed that the apprentice would be able to assimilate more than if required to spend a longer time in the class room. The boys come to class knowing that the period is short, and that they must pay attention, because there is barely time to get what they want. They go away still fresh and interested, and wanting more instruction rather than being satiated with what they have tried to absorb.

A second consideration was that by having half-hour class periods the instruction work is more flexible, and at the smaller shops the classes need not consist of more than three or four boys; at the larger shops the maximum number in a class would not be over eight or nine. In this way the boys may be kept in classes which suit their progress, and may be given practically individual instruction.

There is a third feature that is also important from an economic standpoint, and that is that with the exception of the very largest shop, the instructor is through with his instruction work at noon each day, and can spend the afternoon doing special work for the shop officers, or in organizing special night classes for the journeymen and handymen in the shop who want instruction. These evening classes are offered to the men free of charge, and in some places they are very well attended.

The next consideration was the relationship of the apprentice instructor to the shop. It was especially desired not to take the control of the apprentice boy away from the shop organization, and it is thoroughly understood on the Illinois Central and Central of Georgia that the apprentice instructor has no authority over, or any concern in, the boys' shop work. The master mechanic, shop superintendent, or general foreman, is, of course, naturally interested in his apprentice boys, and will have a special desire to teach them to become efficient journeymen, but if, through the establishment of an arbitrary apprentice instruction organization, the control of the apprentice boys in the shop is taken away from these men and turned over to the apprentice instructor, it naturally creates a condition where the shop officers lose a certain amount of interest in the shop work of the boys, which is not counteracted by the work the apprentice instructor

is able to do in the shop. The shop officers, therefore, continue to have the same jurisdiction and responsibility for the boys as before apprentice instruction was established. They are responsible for the education of the boys in the shop, and the apprentice instructors, under the direction of the Educational Bureau, are responsible for the class work only. This system of organization has worked out successfully, and the shop officers have taken a renewed interest in the whole apprentice question, having arranged for a shop foreman or demonstrator to have special charge of the boys in the shop. The fact that the apprentice instructors do not arbitrarily step in and take the apprentice away from the control of the foreman is considered one of the chief advantages of this system.

CLASS INSTRUCTION.

No mechanical drawing is taught in the apprentice schools during the first year and a half or two years of a boy's apprenticeship. It is not the aim of the apprentice class work to make draftsmen, but to make more efficient shopmen. The apprentice boy needs to learn to read working drawings; he needs to learn to make a shop sketch quickly and accurately, but he does not need to be a mechanical draftsman to accomplish these results. Consequently, the first work in the shop apprentice classes consists of a series of 85 half-hour lessons on reading working drawings. These lessons have been specially prepared, and the thirty-sixth lesson is an actual shop blueprint.

The lessons in the reading of working drawings are given on alternate days, or three times a week. They are followed by shop sketching lessons, of which there are about 60 in the series. With this schedule the apprentice boys should be able to read any shop blueprint, and to make any necessary sketches in connection with their work at the end of the 145th lesson. Following the instructions in these two subjects, which is given to all classes of apprentices, will be lessons in shop practice, arranged according to the different trades that the apprentices are learning.

Such boys as desire to take mechanical drawing will be allowed to do so in the last half of the last year of their apprenticeship, although any of the boys who are particularly anxious to qualify as draftsmen may take up the regular mechanical drawing course of the Educational Bureau on their own time during any period of their apprenticeship.

The alternate days not given up to the course of lessons just described, are assigned to the study of arithmetic and general mechanical subjects. The first year apprentices are started out with lessons in addition, subtraction, multiplication, division, etc. Those who are qualified in these subjects simply take the lessons as a review and quickly work themselves up to a higher class. These lessons are continued with practically no interruption through decimals, and then through higher mathematical subjects, such as square root, cube root, formulas, geometry and trigonometry; interspersed between the latter series are other lessons of a practical nature on mechanical railroad subjects. For instance, the Educational Bureau's unit on "Locomotive Boilers" is read and discussed in class, and the class may meet in the shop at some dismantled locomotive to complete their study of this subject. Following this some other paper on the locomotive is taken up. The locomotive chart is studied to familiarize the boys with the names of all the parts of a locomotive. The car chart is studied in a similar way by the car shop apprentices. Other of the Educational Bureau lessons are used in a similar manner to give the boys as broad a general knowledge as is possible in the time allowed.

During the study of the lessons in the reading of working

drawings the instructor, who is equipped with a T-square, triangles and a compass for use on his blackboard, draws some of the figures in the lessons, explains some of the simple principles of geometrical drawing, etc. The boys also go to the blackboard and make freehand drawings of many of the objects illustrated in the lessons, to make sure that they are understood. In this way the student receives a fairly good elementary knowledge of sketching while learning to read working drawings, and all through the lessons on this subject and sketching the student is learning the fundamental principles of mechanical drawing so that on the completion of the course in the reading of working drawings and sketching lessons it will not be difficult to make a fair draftsman of him.

In a similar way the shop practice covering each of the drawings that a boy receives in class is outlined and covered in connection with the reading of the drawing, so that a boy when taking the first actual blueprint, which is lesson 36, does not look at it simply as a cellar bolt, but is told what a cellar bolt is for, how it is made, what kind of a machine it is made on, what kind of material is used, how the stock is obtained, what is done with the finished stock, etc. This principle is followed through in all of the lessons.

CO-OPERATIVE PLAN.

A short time after the apprentice schools had been established the co-operative plan was started on the Illinois Central at McComb, Miss., by which high school students are received as apprentices in the shop while they are attending school, the time being equally divided between the shop and the school. This plan is similar to that originated by Dean Herman Schneider of the University of Cincinnati, and while there have been similar co-operative plans between high schools and shops it is believed that this is the first such plan adopted between a railroad shop and a high school.

The reason for starting it was rather unique. Professor H. P. Hughes, of the McComb city schools, wanted a manual training department to help make the high school more attractive to the boys. He had a rather peculiar experience in the case of two boys that clearly demonstrated the necessity for such a department. Two chums were graduated from the eighth grade at the same time: one went to work in the railroad shop as an apprentice, while the other was persuaded to continue on through the high school. By the time this boy was graduated the other, having served his apprenticeship, was a journeyman at his trade, and was earning 39 cents an hour. The high school graduate, seeing no other opening, applied for work at the shop, and the best that could be given him was a first year apprenticeship at 12 cents an hour. It happened that this high school graduate at 12 cents an hour was put to work as the helper of the chum, a journeyman earning 39 cents an hour. Parents and children alike in McComb could only see, after this experience, the difference of four years in time and 27 cents an hour in money in favor of *not* going to high school, and it was to overcome this condition that Professor Hughes asked the Illinois Central for aid.

The details of the plan were handled by Mr. Buell, chief of the Education Bureau, and it was arranged for the boys to spend alternate days in the shop. Two boys constitute a unit in the shop and in the school. One boy reports to the shop and works as an apprentice Monday, while the other boy of the unit is in school. Monday afternoon, after school hours and before the shop closes, the school boy hunts up his partner in the shop, and finds out what he is doing, so that he can report for work at the shop Tuesday morning and let his shop partner attend school Tuesday. The boys alternate thus each day, so that the unit always represents one apprentice boy in the shop and one student in the school. Experience proves that there is practically no confusion in the shop due to this method of alternating the apprentice boys; and so far no change has been required in the present school program.

The railroad accepts as a student on the co-operative plan any public school student 16 years of age, or over (in accordance with state laws), who shall be recommended by the proper school officer. There are few formalities connected with the plan. The student signs the same form of apprentice indenture as any other apprentice boy, who applies for work at the shop and is accepted, would sign. Each boy must agree to be faithful and diligent in both his shop work and his school work, and respecting the discipline of the shop while at the shop. Unsatisfactory work in the shop or school will be sufficient cause to bar a student from further participating in the benefits of this plan.

The regular four years' high school course, when taken on the co-operative plan, contemplates the student working in the shop during the summer months when the school is not in session. Taking this into consideration it may be seen that under this plan the high school student at graduation will have worked about two years and five months actual time in the shop, but the Illinois Central allows three years' time on the apprenticeship period of every high school student who graduates under this plan, so that on graduation the co-operative student will have only one year more of apprenticeship to serve before becoming a journeyman.

This plan proves successful in practice because of the fact that every such boy becomes a responsible factor in the every day work of his community. It is up to him to be on time at the shop and to know what he must do; it is also up to him to study with his partner and keep pace with his class. In addition to this the boys are paid regular apprentice rates for every hour they work in the shop, so that as wage earners under shop discipline they begin to grow into useful manhood. The sense of responsibility, the fact that wages are paid for work done, and the broader insight into practical affairs that the boys obtain through this plan, all unite in giving them a clearer understanding and a higher appreciation of the value of their school work. Experience proves also that under this plan they are able to do with ease twice as much in school as the average high school student.

There are only two really good reasons why a boy in good health leaves school before he graduates from high school. The first is that he must earn money for his own support or the support of his parents. The second is that the school does not interest him—he wants to get out in the world, to "get to work," to be earning some money. The co-operative plan nullifies both of these reasons for a boy leaving school, and leaves practically no excuse for parents interrupting a boy's schooling before he graduates from the high school, for the reason that a high school boy can earn from \$15 to \$20 a month while going to school and working on this plan, and for the added reason that his desire to go to work is fulfilled, his desire to earn money is fulfilled, and the school work instead of being drudgery is a welcome interruption on alternate days from the hard work of an apprentice in the shop. This plan does not appeal to boys who are lazy or who have a yellow streak in them, but it does appeal most strongly to the majority of boys who now want to leave school before graduation.

The adoption of this plan has developed another interesting feature, and that is that without exception at the places where it has been started there have been one or more boys in the shop who have not completed the high school course, who have gone back to school under the co-operative plan, continuing on their term of apprenticeship, and at the same time arranging to complete their high school education; and in more than one instance the co-operative plan has appealed to them so strongly that boys who had left school in the first year of high school with no intention of getting any further education, are now going back to school and are planning to go on at the completion of their high school work to a technical school which offers co-operative education.

This plan costs the railroad company practically nothing, but it is giving the company a considerably higher class of appren-

tics. In a similar manner the plan costs the community which adopts it nothing, but it makes the high school work much more effective, and enables many boys, who would otherwise leave school, to continue their schooling and become high school graduates, while at the same time they are able to pay their way from the money they earn in the shop, and are learning a trade.

Soon after this plan was well started at McComb the same opportunities were offered at other shops, and the plan is now in effect at Centralia, Ill., Clinton, Ill., Waterloo, Ia., and at Birmingham, Ala. While it has only been in operation for a short time, it has been so well received by both the students and the local school authorities that it bids fair to extend rapidly.

SHOP ORGANIZATION.

The shop instruction and the class room work are in no way connected to each other, the educational work being directly controlled by the Educational Bureau, and the shop instruction directly controlled by the mechanical department officials. The mechanical department is represented by F. W. Bason, who, as supervisor of apprentices, follows up the work of the apprentices in the shop and has general charge of the apprentices from the mechanical department standpoint. The apprentice is hired by the local mechanical department officers, who, after receiving a report of his educational qualifications from the local apprentice instructor, pass on his character and general qualifications as an apprentice.

The following schedule has been arranged for the transferring of apprentices from one class of work to another, so as to give the boy a general knowledge of all the different classes of work pertaining to his particular trade:

MACHINISTS.	Months.
Drill press (large and small)	2
Lathe (bolt lathe first; then general)	2
Shaper	2
Planer	2
Slotted	1
Boring mill	3
Work above running board, consisting of hand rails, posts, whistles, boiler mountings and all similar work	4
Frames, shoes and wedges, wheeling engines, putting up spring rigging, expansion gear, removing and applying cylinders, etc.	4
Applying pistons and steam chests, putting up motion work, lining guides, etc.	4
Vise work on rods, etc.	4
Vise work on motion work, pistons, cross-heads, etc.	4
Tool-room work, handing out tools, running machines such as tool and drill grinder, lathe, milling machine, etc.	5
Vise work on tools to consist of general repairs to tools of the various departments, die sinking, etc.	5
Total	48

When the apprentice is not placed in the tool room he is placed in the air brake department for the following experience:

Months.	
Overhauling and applying brake rigging, air pumps, lubricators, engineer's valves, injectors, steam and air gases, gage cocks, posts, whistles and all work handled in this department	9

As it will be necessary to have the apprentices in the round-house machinery repair gang, and on the surface or laying-out table, the time allotted to these departments is as follows:

Roundhouse from six months to one year; machinery repair gang from two months to six months; surface table from one to three months.

Credit is given the apprentice for experience and time spent on this class of work, and he is exempt from serving any time on the regular schedule on work of a similar nature.

BOILER SHOPS.	Months.
Heating rivets, scaling boilers, and general helping on light work, punch and shears	6
Ash pan and netting work, also as much sheet iron work and miscellaneous light boiler work as possible	10
Tank work, such as patching, riveting, applying angles, etc.	6
Flue setting	6
Firebox work, reaming and tapping staybolt holes, setting and cutting off staybolts, etc.	8
Working with boilermaker on general work, such as flanging, riveting, applying new sheets, bracing and staybolt work	6
The last six months to be spent on work either under the instruction of the lay-out or working on general boilermakers' work with helper and handymen, the apprentice to be in full charge of work. The work to consist principally of patches, half side sheets, door sheets, back and front flue sheets, smokebox extensions, smokebox liners, and general boilermakers' work.	6

In shops employing a sufficient number of boilermaker apprentices, one apprentice to be kept with the lay-out, and as one apprentice is retired, another to be ready to take his place.

BLACKSMITH.

	Months.
Running steam hammer	6
Heating bolts	3
Helping on small fires (light work)	6
Running bolt header and forging machines	6
Helping on tool fire	6
Light work on fire with helper	8
Heavy work on fire not requiring any particular skill	10
Working on fire, all classes of work, filling the place of absent blacksmiths and doing general blacksmith work	6
Total	48

The last year of the blacksmith apprentice work consists of general blacksmith work, working on frame fires, heavy work under the steam hammer, such as drawing out, forging billets, piston rods, equalizers, main and side rods, etc., and such other work as will familiarize the apprentice with handling iron under the large hammer. He is also given an opportunity to operate the large up-setting machine.

TIN AND PIPE SHOP.

	Months.
Helping on pipe work	10
Injectors, lubricator pipes and copper pipes in cab	10
Air brake pipes	6
Jackets and sheet iron work	4
Tin roofing, headlights, classification lamps, lanterns, oil cans and general light tinmith work	6
General pipe and tin work	12
Total	48

CAR DEPARTMENT.

Carpenter Shop.		Months.
Making boxes, etc.		6
Bench work		6
Passenger Shop.		
Stripping, etc.		6
Platform work		6
Body work		6
Inside finish and trimming		6
Freight Shop.		
All around car work		6
Office work in car department office on defect cards, etc.		6
Total		48

The following individual monthly report is made out by the shop demonstrator and the educational instructor, and is approved by the local master mechanic:

CD 19-3300
Form 1221

Illinois Central Railroad Company.
 The Yazoo & Mississippi Valley Railroad Co.

SHOP AND CLASS RECORD OF APPRENTICES AT
 _____ 191____

Shop, Month Ending		CLASS				
NAME OF APPRENTICE	CLASS OF WORK	SHOP		CLASS		
		Days Worked in Shop	Efficiency	Clean Work	Showing in Materials	Showing in Drawing
Number of Apprentices engaged during Month.		Required.				
Efficiency of apprentice to be based entirely on quality and quantity of work, where 100 is with equal a normal output. (D)Very () A. Perfect. B. Good. C. Fair. D. Unsatisfactory. E. Failure. Grades Mathematics 10% to be allowed for mistakes of work, and problems to be graded according to percentage correct normally in each instance.						
Demonstrator Approved.				Technical Instructor of Apprentice		
Master Mechanic.						

Form Used for Monthly Shop and Class Record of Apprentices.

This report is made in duplicate, one copy being sent to Mr. Buell, chief of the Educational Bureau, and the other being held at the local shop. A second form is made out monthly by each shop for the office of the general superintendent of motive power, showing the average efficiency in the shop and class room of all apprentices in each trade for the first, second, third and fourth year apprentices. From this form a summary is made, with the same headings, but with the totals from each shop so that a comparison may easily be made. The following table

gives the classified list of apprentices on the Illinois Central system:

	APPRENTICES PER TRADE PER SHOP.					Carpenters.	Found.
	Machinists.	Boiler-makers.	Black-smiths.	Tin and pipe.	Painters.		
Burnside Shops.....	62	10	3	16	1	17	..
Memphis, Tenn.....	26	3	1
Vicksburg, Miss.....	20	6	2	2
McComb, Miss.....	20	5	2	..	5	5	5
Water Valley.....	22	1	3	2	2
Waterloo, Ia.....	13	9	2	..	1
Paducah, Ky.....	32	6	1	3	2	1	..
Centralia, Ill.....	13	2	..	2
Clinton, Ill.....	24	5	2
Mattoon, Ill.....	6	1
Freeport, Ill.....	5	2
Mounds.....	2	2
East St. Louis, Ill.....	7
Total per trade.....	252	51	13	29	11	26	5
Total entire road.....	387						

MACHINE FOR DRILLING TELL-TALE HOLES IN STAYBOLTS

BY PAUL R. DUFFEY.

It has been the general practice to drill tell-tale holes in staybolts before applying the bolts and to countersink the ends sufficiently to prevent closing the holes when riveting. A number of shops applied bolts without drilling, but when the drilling

by a suitable flat bar supported at the ends by upright pieces of angle iron which are fastened to the floor by lag screws. This frame is braced to the backhead of the boiler and the slide holder X, placed on the flat bar, supports the slide D.

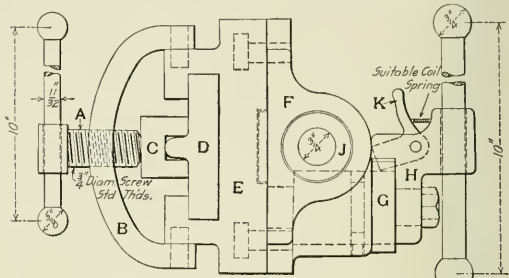

Apparatus for Drilling Tell-tale Holes in Staybolts.

The machine is clamped in any desired position on the slide D by means of the support clamp B, support clamp block C and screw A. The swivel plate A has a bracket F for the spindle feed, attached to it in such a way that it may be turned to any position and the main spindle J, which holds the drill,

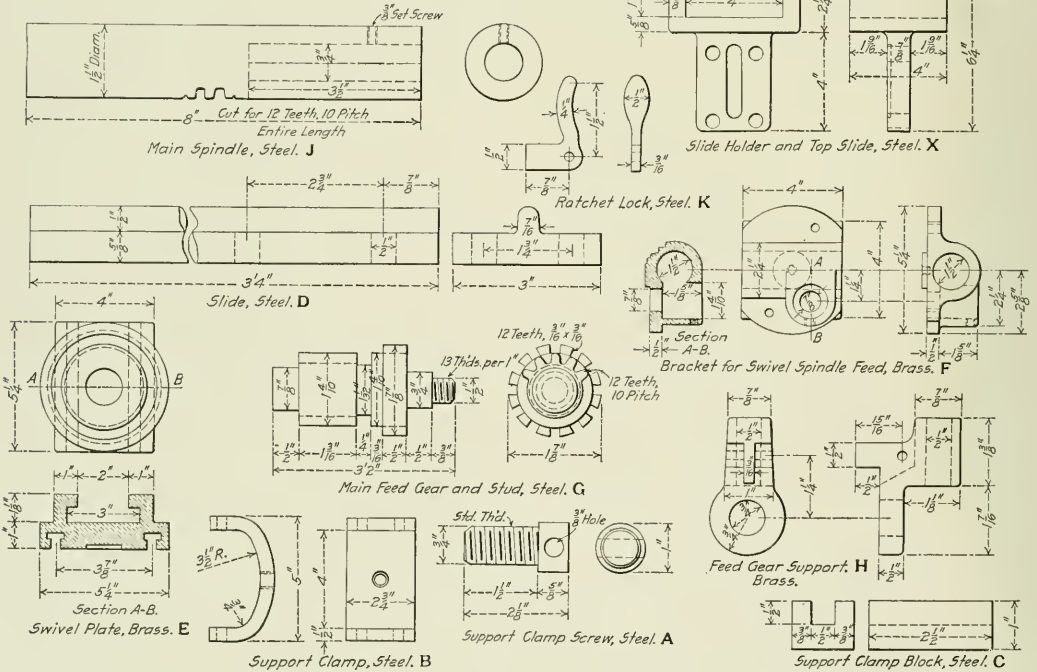

Details of Machine for Drilling Tell-tale Holes.

was done later the depth of the holes did not conform to the present standard, and in consequence had to be redrilled to standard.

In order to drill the bolts to the proper depth after they are applied, the machine illustrated here was devised. It permits of accurately drilling holes in staybolts at any angle after they are in position in the firebox. The whole machine is supported

passes through this bracket. The feed gear G, which has teeth engaging with those on the main spindle J, is controlled by means of the handle in the feed gear support H and the ratchet lock K. The power for operating the drill is supplied by an air motor. This device is in use at the Portsmouth, Ohio, shops of the Norfolk & Western, where 1,800 holes have been drilled by it with six 3/16 in. drills.

WELDING OIL CUPS ON ROD STRAPS

BY E. L. DUDLEY.

The drawing shows an oil cup machined, ready to weld on the strap. It is made from a piece of round iron of the proper size, chucked in a lathe where thimble *B* and groove *A* are formed. The strap is counterbored the size of thimble *B* to receive the oil cup. The thimble is about 1/4 in. long, and the counterbore in the strap is just deep enough to allow the cup to rest flat on the strap. The cup and strap are then delivered

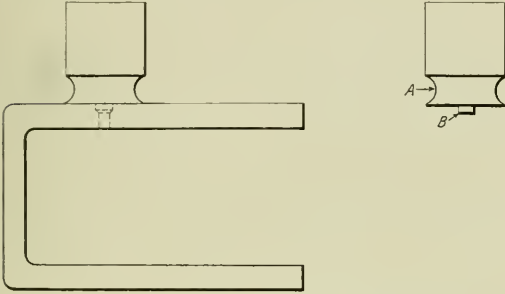

Oil Cup Prepared for Welding to Strap.

to the blacksmith shop, where both are brought to a welding heat and the weld is made in the usual manner. The groove *A* is to help the blacksmith in using his tools. After welding, where no special tools are in use for the purpose, the cup may be easily finished by chucking the strap in a lathe.

SMALL FACE PLATE FOR AIR BRAKE WORK

BY F. W. BENTLEY, Jr.,
Chicago & North Western, Huron, S. D.

Face plates used in connection with air brake repair benches are often few in number and in poor condition, two or three men sometimes using the same plate, with the result that it gets but little care.

The plate illustrated is made from an old reversing cylinder cap from a Westinghouse 8 in. air pump. The threaded portion of the cap can be used to hold it in the lathe chuck jaws

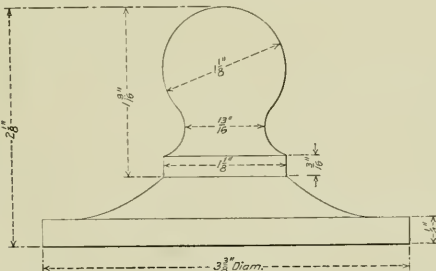

Face Plate Made from Reversing Cylinder Cap.

while the handle is being turned up. By turning the cap around and protecting the finished portion with copper strips between it and the jaws, the threaded portion may be turned off and the part used as a face may be gone over and trued up. A lathe in good condition can turn out a very accurate plate. The plate should be kept in a small tin box, the bottom of which should be covered with a flannel rag soaked in oil. By using these

old caps each repair man may have a face plate of his own, and they will be found triple useful in spotting slide valve feed valve valves, flat faced triple valves, rotary seats and for a great variety of other work.

SMITH SHOP KINKS

BY C. L. DICKERT,
Assistant Master Mechanic, Central of Georgia, Macon, Ga.

WELDING JAWS ON BRAKE CYLINDER PUSH RODS.

The jaws for the brake cylinder push rods may be made on a forging machine at a little more than one-half the cost of doing the work by hand. The dies shown in Figs. 1, 2 and 3

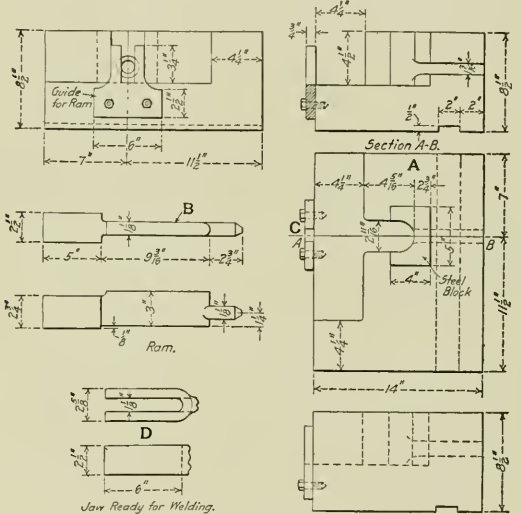

Fig. 1—Dies for Forming Brake Rod Jaws.

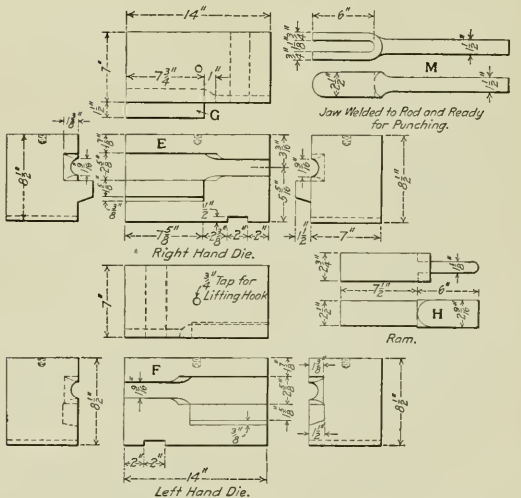

Fig. 2—Dies for Welding Jaws to Brake Rods.

are used for forming the jaw, welding it on the rod and for punching the pin hole through the jaws. Fig. 1 shows the dies

used for forming the jaws. A hole is punched through bottom of the jaw to receive the end of the push rod. A bar $2\frac{1}{2}$ in wide by $\frac{3}{4}$ in. thick is placed in the die *A*. The ram *B*, which punches the hole and at the same time bends the jaw, is steadied by the guide *C*. The finished jaw is shown at *D*.

The end of push rod is swaged down to fit the hole in the jaw, and both of them are welded together by the dies shown in Fig. 2. The female dies are made of the two blocks *E* and *F*. The block *E* has a projection *G* which fits in a recess in *F*.

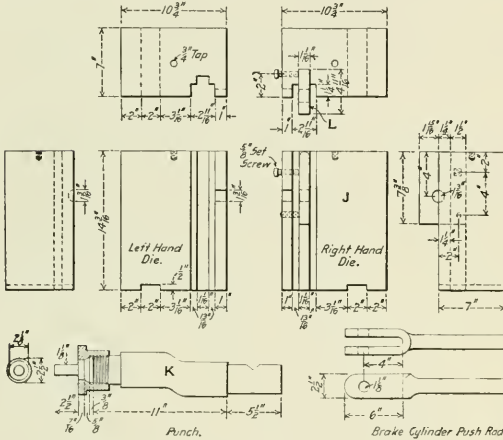

Fig. 3—Dies for Punching Pin Holes in Brake Rod Jaws.

The ram *H* enters between the forks of the jaw and welds it to the rod. The rod with the jaw welded on is shown at *M*.

The pin hole is punched in the jaws by the dies shown in Fig. 3. The die *J* is provided with the spacing plate *L* which fits between the jaws and keeps them from bending while being punched. The punch *K* has an adjustable head, so that different size punches may be used.

UPSETTING AND PUNCHING COUPLER YOKES.

Dies for upsetting and punching coupler yokes are shown in Fig. 4. The finished yoke is shown at *A*; the ram for upsetting the ends is shown at *B*, and the punch and receiving dies

machine in one operation, the bending being done in the bending machine shown in Fig. 5. The yokes are completed in three operations and are finished in the smith shop, formerly the holes were layed out and drilled in the machine shop. One operator and a helper can upset and punch 30 yokes in an hour.

AIR BENDING MACHINE.

An air bending machine that may easily be made from scrap material is shown in Fig. 5. The main cylinder is 18 in. in diameter inside. The piston fits in the crosshead that operates

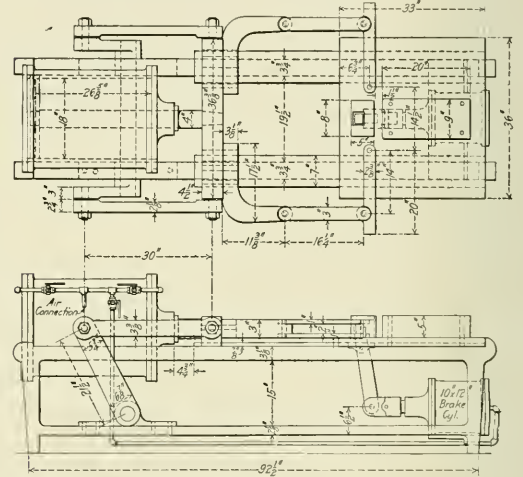

Fig. 5—Bending Machine for Coupler Yokes.

the bending arms through jointed rods. The crosshead is held from twisting, due to the inequality of the load on the bending arms, by the rocker located under the main cylinder. The 10-in. x 12 in. cylinder at the lower right hand end of the machine operates a clamp which holds the bar that is to be bent, firmly in place.

This machine is used to good advantage in bending the coupler

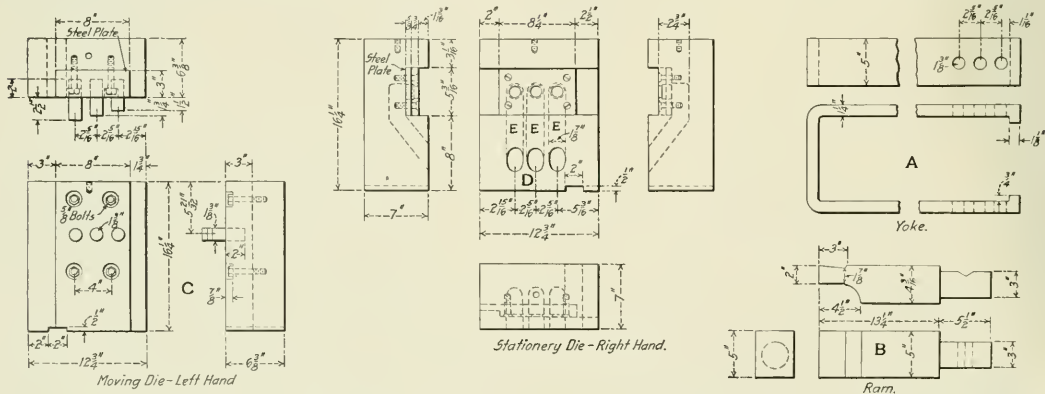

Fig. 4—Dies and Punch for Upsetting and Punching Coupler Yokes.

are shown at *C* and *D*. The receiving dies are cored out as shown at *E* to allow the punchings to fall away from the dies. The punching and upsetting is done in a 4-in. Ajax forging

yokes shown in Fig. 4. This machine was designed by Jack Jenkins, of Decatur, Ala., with the exception of the clamping device, which was put on by the writer.

CAR DEPARTMENT

BOX CAR CONSTRUCTION, AS VIEWED BY A REPAIRER*

BY H. S. FENTRESS,
Foreman Car Department, Norfolk Southern.

During the past few months I have noticed several lots of cars, recently built, which have been equipped with outside metal roofs. This class of roof is a grave mistake. I make this unqualified statement because of personal observation. The first objection is the almost impossible task of keeping the metal protected from the weather. An inspection of roofs turned out during the first half of 1912 will bear out the above statement; consequently the metal left unprotected will soon rust, and in a short time leaks will develop, causing claims for damaged goods and necessitating the removal of the cars from service for repairs to the roof. Cars doing service near the sea coast for any length of time will suffer in this way quicker than those in service away from the influence of the salt air.

There are, of course, several preparations on the market purporting to be just the thing for metal roofs, but so far as I know, nothing has been found to adhere to the metal satisfactorily. It has been suggested that the roofs remain uncovered until corrosion begins, thus giving the paint something to hold to. This, I believe to be a fallacious idea, for corrosion, having begun its work while the metal was unprotected, continues to eat like a cancer, and under cover of the coat of paint it received too late its work of destruction is not noticed; the first intimation the car department has of the leaky condition of the roof is through the claim agent. Then again, should we persuade ourselves that this suggestion is a good one, it is in a large measure an impractical one, as the owners are unable to keep the cars home, and a certain percentage remain away for many months; there is a possibility of the roof receiving no attention, and of the rust destroying it while the car body is comparatively new.

The short running boards, added to the fore and aft boards, with their saddles constantly bearing on the metal, and the working of these saddles, little as it may be (and there will be some no matter how much attention is given them), causes the metal to wear under the saddles, thus creating leaks difficult to detect, and thereby adding another source of annoyance to the car department and extra work for the claim department.

There are grave defects to be found in the designs of many inside, or covered metal roofs. In a majority of cases the metal is not properly held in position in the groove of the ridge pole to take care of the working of the car body; other designers have secured the metal in this regard, but have omitted to take sufficient care of the lower ends of the sheets, allowing the drip to fall into the joint formed by the side plate and the siding. I have recently tested several of the roofs that were reported leaking to the extent of damaging the lading by water. The test showed that the roof was intact and in the same condition as originally constructed. There was no furring strip on the side plate and the fascia boards were nailed tight to the siding with no space between. The car had not opened, being equipped with metal carlines securely fastened to the side plates, but the water, finding its way through the roof sheathing, ran down to the plate. The roof boards being nailed tight at this point, the water flowed back over the plate and into the car, as well as finding an avenue between the siding and the plate and dropping on the belt rail, and then on the lading. This style of roof shows the defect in construction only in severe rain storms.

What is badly needed is a roof so designed that the sheets will be held firmly in the ridge pole groove, and the sub-carlines, or parting strips, will be secured at the ridge pole and side plate, while the nailing strips will be bolted to the sub-carlines. The sheet should also flange downward, and be fastened to the siding. A roof bolted together as above suggested would be held more firmly in position. The expense of replacing roofs lost in wind storms is a frequent and considerable item in the charges against the upkeep of freight equipment. A very little added to the cost of application would save a large part of this expense.

There is another advantage for the covered metal roof as compared to the outside metal roof under similar conditions. It is well known that switchmen will take chances on car clearance in the yards, and while the all-metal roof reduces the width of the car at the eaves, the switchman is just as liable to mistake the distance with this type as he is with the wider one. In fact observation has proved to me, at least, that the narrower the car, the more the chances taken. Accidents of this nature happening to an all-metal roof mean torn sheets; the car must go to the repair tracks, which necessitates its removal from service for from one to three days, according to the switching facilities at the point where the accident occurs; the same accident to a covered metal roof would not necessarily remove the car from service, but repairs can be made by inspectors on duty in freight yards, whose business it is to keep loaded cars moving.

Roof conditions are not the only causes that bring about claims for damage to lading. The loose fitting door has contributed its share to this constant leak in the revenue of the operating department. There are more cars being interchanged without doors today than ever before, and the amended M. C. B. rules of interchange will, I believe, increase the number; hence the necessity of insisting on a door that can only be dislodged by a rake or side wipe. Doors lost in transit, owing to a poorly designed hanger, or a track too weak to bear the weight of the door without sagging, represent many dollars that could be saved by adding a very little to the first cost. The door selected should be so constructed as to form a water tight joint when closed, thus protecting the lading from damage during a driving rain storm. The door fastenings on modern cars are very good of their kind, but they do not entirely answer all requirements. Doors on empty cars are allowed to run back and forth at will in switching, thus receiving shocks that tend to impair their usefulness. A device that would secure the doors in an opened or closed position would be beneficial in maintaining their efficiency against the weather, as well as the possible burglar. In other words an automatic door lock is now in order.

I wish to call the designer's attention to another matter that seems to have been overlooked; the inner lining should be carried to the plates on the sides as well as at the ends of the car. The roof and doors may be perfect, and yet in a severe rain and wind storm, damage may occur to the lading in the following manner: The rain will drive through the sheathing, creating a dampness that would ruin lading, which might be particularly susceptible to dampness. It could be argued that this is a rare occurrence. Admitting that it is, the payment of one claim of this nature might more than balance the extra cost to the entire lot of cars, and as the cars deteriorate the chances of the above possibility increases. The extra lining would stiffen the car body, thus enabling it to sustain shocks with less damage.

The steel frame box car that has come to my notice seems to be weak in the end construction. Dressed lumber is a great menace to car ends; therefore that part of the car should be strengthened to meet the sudden shocks incident to the shifting

*Entered in the Car Department competition, which closed February 15, 1913.

of the loads. It is a common sight to see steel frame cars on the repair tracks undergoing repairs to the end, the damage being due to a shifting load knocking out the ends. A large part of this damage could be avoided by adding a substantial horizontal metal end brace securely fastened to the side frame of the car. This might be in the form of a T-iron riveted on the outside of the vertical members of the frame and with the sheathing fitting over the flanges of the T. As now constructed, there is no support at the center of the end post and braces, and when the weight of the shifting load is delivered to that point they are not stiff enough to resist, consequently they must bend with the result that the end sill and end plate are twisted. As the cost to repair one of these ends is considerably more than to one of the all-wood ends, the additional expense of the end brace suggested would be insignificant when compared with the amount saved in material and labor, and in keeping the cars in service.

We will, of course, always have cars on the repair tracks,

signed draft device for which the car owner was responsible, but owing to the combination formed was relieved of by the M. C. B. rules. Happily the designer of the modern draft gear has made the possibility of this condition a thing of the past. The designer is to be congratulated on the wonderful strides made in car construction.

PORTABLE RIVET HEATER

BY LEROY SMITH,

Draftsman, Pennsylvania Railroad, Olean, N. Y.

The portable rivet heater shown in the drawing is simple, easily built and quite economical in operation. It was designed originally for use in the freight car repair yard, but on account of its light construction and the ease with which it can be moved about it is useful for other classes of work.

The wheels are about 20 in. in diameter and are of any suit-

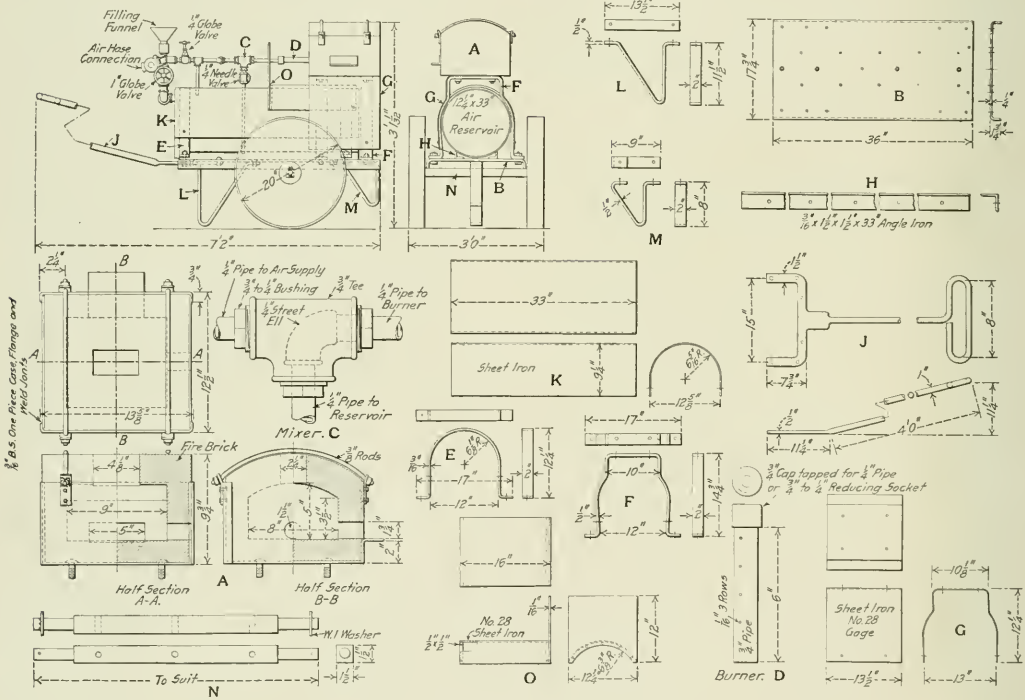

Details of Portable Furnace for Heating Rivets.

but I believe the designer can, and will, in time, reduce the bad order list to a minimum. This belief is strengthened with the appearance of almost every new design. The progressive spirit is especially noticeable in the underframe, and it would be difficult to suggest any idea that would be an improvement over the latest designs. It is encouraging to note the tendency to get away from the old coupler stops, and their attendant followers and straps, which have always been points for the suspicious scrutiny of the car inspector, and have caused the hold-up at interchange points of many important shipments. It is also gratifying to note the gradual disappearance of the coupler pocket and rivet that have played no small part in keeping the repair track busy, and whose weakness has been the primary cause of many combination defects that the car user was compelled to stand for, when really the defect originated from a weakly de-

able pattern; the axle is made to suit. The bed is made of 1/4 in. boiler or tank plate, flanged on the sides to make it more rigid. The tank is a 12 1/4 in. x 33 in. air reservoir, equipped at the front end with I in. pipe fittings, through which the air supply enters and the oil is passed to the burner. The tank is well sheathed, with sufficient air space to amply protect the reservoir from the heat of the furnace.

The furnace is built from 3/16 in. boiler or tank steel with all seams welded. The inside is thoroughly lined with fire brick and clay, which is easily replaced when necessary.

THE NEW OVERLAND LIMITED.—An extra fare train has been put in service between Chicago and San Francisco, running over the Chicago & North Western, Union Pacific and Southern Pacific. The run is made in 64 hours.

STEEL PASSENGER CAR DESIGN

Papers Presented at the Railway Session of
the American Society of Mechanical Engineers.

Thirteen papers, each on a different subject connected with the design of steel passenger train equipment, were presented at the Railway Session of the American Society of Mechanical Engineers, held in New York on the evening of April 8, 1913.

THE GENERAL PROBLEM.

The opening or introductory paper was presented by H. H. Vaughan, assistant to the vice-president, Canadian Pacific. After pointing out the difference in the conditions which control the development of the steel passenger car from those which influenced the design of the steel freight car at its inception, he stated that the questions that now confront us relate to the design and construction of cars of the present type and of the materials that may be advantageously employed in place of the wood which has been used for so long. They are complicated by the necessity of providing for greater safety for the passengers than was secured in the wooden car, with an equal degree of comfort, and the difficulty of anticipating the behavior of this new equipment in the case of accident. Certain difficulties, such as the best systems for heating, lighting and ventilation, are common to both steel and wood construction, and improvements in these matters pertain to general progress rather than the use of steel construction.

The steel underframe and wood superstructure does not appear to be a satisfactory or permanent development. There is but little saving either in weight or cost over the all-steel construction, and it is difficult to see how the same strength in case of accident can be obtained. It can hardly be regarded except as an intermediate step between all-wood and all-steel construction.

In all-steel construction the side-girder car presents advantages, but as in freight construction, both types will probably persist. The side-girder construction obtains greater strength on the side framing without superfluous weight, and it is possible that greater framing strength may prove necessary. With equal strength of side framing, the side-girder car may be made lighter than the center-girder type, and the weight of steel passenger cars is one of the most serious problems to be faced by any railroad not having a level line. Apparently side-girder cars as so far constructed have a decided advantage over the center-girder type in their light weight and greater strength in case of accident tending to crush in the side of the car. This will probably lead to the use of this type on roads on which weight is of importance.

The circular roof has been extensively introduced on steel passenger cars on account of its lightness and simplicity of construction. It has the objection that deck sash ventilation cannot be employed. The deck sash is of value for this purpose in a standing car and, when properly screened, is certainly advisable in hot weather, especially when the road is dusty. The Canadian Pacific has compromised on this question and is using a roof of approximately circular form with deck sash. The strength and simplicity of the circular roof is retained with the ventilating qualities of the clerestory type.

The preferable material for inside finish is a matter for future decision. With the ample protection afforded by a steel car against accident, there does not appear to be any objection to wood inside finish on the ground of safety. It is more ornamental than steel and a better insulator. There is today very little difference in cost, and it appears probable

that in the future the tendency will be to adopt steel interior finish, if not entirely, at any rate to a great extent.

The floor construction in steel cars is entirely different from that in wooden cars, and is usually of metal covered with a flexible cement. In constructing a sample car, the writer used in addition an underfloor covered with insulating material, and covered the cement with $\frac{1}{2}$ in. of cork. This car was also exceptionally well insulated at the sides, 2 in. of cork being used next to the outside plating. Tests during the past winter have shown that this car is actually warmer than the ordinary wooden car, the same amount of heating surface being used in both types. The question of insulation is an important one, both in hot and cold weather. With proper insulation there is no question of the steel passenger car being satisfactory.

PROBLEMS OF STEEL PASSENGER CAR DESIGN.

W. F. Kiesel, Jr., assistant mechanical engineer, Pennsylvania Railroad, outlined briefly some of the more important problems that confront the designer. Before the first steel passenger car for regular steam railroad service was built, a committee composed of representatives of both car builders and railroads carefully analyzed the whole subject and reported that, at first, steel passenger cars would cost approximately 20 per cent. more per passenger than wooden cars of the same type, but that the steel cars would probably cost much less to maintain. This committee, however, was of the opinion that the probable decrease in cost of manufacturing steel cars and the increased cost of good lumber would soon absorb this differential, and Mr. Kiesel stated that at the present time steel passenger cars cost no more than equivalent wooden cars.

Differences of opinion still exist as to whether the cars shall be all-steel, or steel frame with wood lining. In the all-steel car the steel lining can be securely riveted to the framing and adds somewhat to the strength of the complete structure. Satisfactory results have been realized from the use of a double steel lining between the seats, forming a hot-air duct, extending from the heater pipes to the window sill, with an outlet through small holes in the lining proper, located immediately below the window sill. Wood lining requires considerable wood furring, and adds weight to the car without adding to the strength. As a car with metal lining riveted to the framing has the advantage in strength, weight and cost, it will gain in favor. The results of several years' experience indicate that the lining must be insulated throughout and, if the spaces between lining and sheathing are properly isolated, little is gained by insulating the sheathing; more will be gained by the use of double windows. Furthermore, the heat lost in cold weather by conduction through and radiation from the walls, in cars with insulation on the lining alone, is negligible when compared with the heat carried off by adequate ventilation.

The laws governing load-carrying strength are well known, but this cannot be said of the laws governing wrecks. Each wreck forms a separate study, and we seldom find two that can be placed in the same class. The study of wrecks shows that the car underframe must be reasonably strong to resist end strains, that the ends of the superstructure must be reinforced with strong vertical members, and that the car must not collapse when rolled down an embankment.

A better knowledge of the relative value of steel and wood in car construction has led the designer to abandon the basis of ultimate strength of the material, and to substitute the

basis of elastic limit, and finally to select a ratio of 4 to 1 as the relation of the elastic limit of steel as used in cars, to that of good timber.

Selecting from the last generation of wooden cars one used in heavy trunk line service, with four 5-in. x 9-in. wooden sills bunched together near the center, and so located as to be nearly uniformly affected by the end strains, steel platforms with draft gear securely attached, and the remainder of the car to correspond, the analysis of its end-shock resisting capacity leads to the consideration of the elasticity of the material, the transverse bracing preventing buckling, the concentration of strength near the longitudinal center line of car, and the reinforcement at the platforms. A corresponding steel car should have a center sill area of 45 sq. in. braced against buckling, a strong and efficient draft gear as a substitute for the elasticity of the wood, and a ratio of 0.04 for stress to end force, the calculations to include consideration of the lever arm of force below the neutral axis of the center sills. For lighter service a steel car with a center sill area of 32 sq. in. and a ratio of 0.05 for stress to end force may be considered as a substitute for a wooden car with four 4-in. x 8-in. sills bunched near the center of the car. The use of steel permits a distribution of material to better advantage than is possible with wood. The box girder center construction is continually gaining in popularity, the strong vertical members at the car ends, to prevent one car overriding and penetrating the superstructure of another, are now considered a necessity, and a superstructure, including a roof sufficiently strong to bear the car when turned upside down without collapsing, is very desirable.

The impression that cars with six-wheel trucks necessarily have better riding qualities than those with four-wheel trucks has proved to be incorrect. The substitution of four-wheel trucks for six-wheel trucks saves about 18,000 lbs. per car. Increased journal bearing surface obtained by an increase of diameter of journal only is of little or no benefit in preventing hot boxes, because the periphery velocity increases in the ratio of the diameters. The weight per journal should not exceed 1,500 lbs. per inch of length. A long spring base, low-lying center plate, and anchoring the dead levers to the car body instead of to the truck frame promote smooth action and easy riding at all times. The equalizing springs should, therefore, be placed as near to the journal boxes as possible, or directly over the boxes, and the bolster springs should be on or near the center line of the truck sides. If the dead levers of the truck brake are anchored to the car body, the truck frames have no tendency to tip when the brakes are applied, and the jarring effect is entirely eliminated. A special axle with $3\frac{1}{2}$ in. x 11 in. journals for passenger cars would be of material benefit and would permit using four-wheel trucks under all coaches and 60-ft. baggage cars. Longer cars with six-wheel trucks would have sufficient margin for the excessive loads sometimes encountered and the danger of hot boxes would be avoided.

ROOF STRUCTURE.

C. A. Seley, mechanical engineer of the Rock Island Lines, presented the discussion on this subject. His paper, in part, is given below.

The advent of the steel car has encouraged the use of the oval roof, particularly for cars used for baggage, express, and postal purposes. It is cheaper to build and maintain and fulfills requirements for such cars. For passenger cars the clerestory type prevails very generally, as it assists in lighting and ventilation and in decorative effect.

The framing for oval roofs consists of carlines, each a single member, bent to the shape of the arch and extending from plate to plate. There are no through longitudinal members and the roof sheets are riveted to the carlines.

The shape of the carlines of either type of roof should be such as to facilitate fastening of the roof and of the inner ceiling or finish, and between these there should be a generous amount of insulating material to intercept the heat of summer and the cold of winter.

The specification for full postal car construction, approved by the Postoffice Department in March, 1912, contains the following paragraphs in regard to the roofs of such cars and is probably as authoritative a statement as there is available. The strength of roofs of some cars that have been rolled over in accidents has been checked against the formula used, and has been found ample to afford support against serious roof distortion in such cases.

"The roof may be of either the clerestory or turtle-back type. In the clerestory type, the deck plates shall be in the form of a continuous plate girder, extending from the upper-deck eaves to the deck sill, and either built up of pressed or rolled shapes or pressed in one piece from steel plates. The carlines may be either rolled or pressed steel shapes, extending in one length across the car from side plate to side plate, or may extend only across the upper deck. In the latter case the lower deck carlines may be formed by cantilever extensions of the side posts or by independent members of pressed or rolled shapes. In the turtle-back type, the carlines may be of either pressed or rolled shapes, extending in one length across the car between side plate and side plate, or may consist of cantilever extensions of the posts.

"The projected area of the portion of roof in square feet, supported by carlines, divided by the sum of the section moduli of the carlines, must not be more than 100.

"Roof sheets, if of steel or iron, shall be of a minimum thickness of 0.05 in., and either riveted or welded at their edges."

SUSPENSION OF STEEL CARS.

E. W. Summers, president of the Summers Steel Car Company, Pittsburgh, Pa., drew attention to the fact that the unevenness of the track due to natural causes as well as the necessary change in the rail level on curves, made the proper suspension of steel car bodies a difficult problem. He stated that in passing from a tangent to a curve the truck on one end of the car might be in wind with that on the other end by as much as four or five inches, depending on the degree of curvature and the length of the car. This statement was later questioned by Mr. Pilcher, who stated that an examination of a car with fifty-foot truck centers, and on the sharpest practical curve showed that the difference in level of the two trucks would not be over one inch. Mr. Summers did not have an opportunity to reply.

An abstract of Mr. Summers' paper follows:

Steel car bodies of the enclosed type, such as box, mail, baggage, or passenger cars, are of rigid construction and have high torsional resistance. The use of truck springs helps the illusion that we are distributing the car body load on all of the wheels. The uneven deflection of the springs indicates directly the increased load of one spring over the other. When the track surface is warped more than the total spring travel, the whole load is carried at two diagonal corners, tending to twist the car body. This twisting tendency is constantly changing, first in one direction and then in the other, as the super-elevated rail changes from one side of the track to the other.

The necessity for flexibility between the car body and the trucks, and for an even distribution of the load on all of the wheels seems not to be fully appreciated as yet, but with each succeeding year wrecks due to broken rails, wheels and truck structure, will drive this home. Suspension of steel cars, as has been developed by the writer in the past three years, does permit of a more even distribution of the load upon the wheels than with center-bearing trucks. (Mr. Summers' method of side suspension was fully illustrated and described in the *American Engineer*, April, 1912, page 194.)

With this type of suspension, the car body is carried at each side almost directly under its rigid side girders, which have great depth and can carry the load with the least deflection. Floor beams may be made continuous from side to side of the car. The necessary huffing and pulling column may be dis-

posed with its web in a horizontal position under the transverse beams, greatly simplifying the car framing.

SIX-WHEEL TRUCKS.

John A. Pilcher, mechanical engineer of the Norfolk & Western, after discussing the various parts of a passenger truck separately, summed up the subject as follows: The introduction of heavy passenger equipment is rapidly going away with both the four-wheel and six-wheel wooden frame trucks. Cast-steel one-piece frames, and riveted wrought-steel frames of various cross-sections have been worked out and are now in use; both are reported as giving satisfactory service.

The cast-steel one-piece frame has become a great favorite even in the face of the high unit cost of these particular castings. The adaptability of the castings to the various changes of form and section necessary on account of the limited available space has no doubt had much influence. The attractiveness of the one-piece structure, eliminating all joints, and furnishing a frame ready set up, is another strong argument in its favor. The manufacturers having control of this cast-steel truck frame have evidently been successful in reducing to a minimum the concealed flaws often met with in steel castings. This, no doubt, has added largely to its popularity.

While the absence of riveted joints and the consequent doubling of material at the joints, helps to keep down the weight, the fact that the working fiber stress of cast steel is taken low, and the sections at many points have to be made larger than is necessary, on account of foundry limitations, the weight of the frame as a whole is great. This added to the large unit cost for special steel castings makes the user pay well for the advantages gained.

The riveted wrought-steel frame seems to have been held back in its development by the success of its rival in cast steel. Many users have shown conservatism in making use of the good thing already considered acceptable, hesitating to try out the different construction with the hope of lower first cost, with less weight and equally good service. Wrought steel at a very moderate unit cost has the advantage of a very reliable material which can be worked to a relatively high fiber stress. The cost of fabrication, when the work is done in any large quantity, added to the cost of material, will still leave a large margin in its favor. Is it possible that the lack of a specially interested advocate has prevented its virtue from becoming prominent, and delayed the experience needed to prove its worth in actual service?

I find several railroads building and using both four and six-wheel trucks, of the usual type of construction, with riveted wrought-steel frames, and from all reports they are giving satisfaction. One railroad is using both four and six-wheel trucks, of a form of construction differing from the ordinary type, but built of riveted wrought steel. As a large number of these are in daily use and they are constantly being built, they must be proving the worth of the riveted wrought-steel construction, as well as that of the special type of construction.

Several years' experience and a careful comparison of the cost of maintenance will be needed to determine whether the one-piece cast-steel frame, or the riveted wrought-steel frame truck would be the most advantageous, when both the first cost and weight are considered, together with the cost of maintenance.

Variety of choice offers an opportunity for discussion. In the hope of bringing out this discussion we advocate for steel passenger cars: Six-wheel trucks; the riveted wrought-steel frame; the use of the M. C. B. standard axles, boxes and parts, and pedestals, and 36-in. wrought-steel wheels.

STEEL INTERIOR FINISH.

Felix Koch, assistant mechanical engineer of the Pressed Steel Car Company, stated that there has always been, and still is, a difference of opinion as to how far it is advisable to substitute metal for wood in passenger car construction. He did

not object to the use of a small amount of wood in the interior finish as, for instance, window sash, moldings, seat arm rests, window capping, etc., as it has certain advantages over steel which are desirable. Wood, however, should be eliminated wherever possible on account of the many advantages possessed by steel, among which may be mentioned: Non-combustible; prevents splintering in case of wrecks; easily removed should it become necessary to repaint the car on the inside surface of steel sheets; makes it possible to increase the interior width of the car where the outside width is limited; avoids trouble which may be experienced due to the different expansion of the materials, steel and wood; and it will, by comparison, be cheaper every year for the reason that it becomes more difficult to obtain the right kind of lumber for interior finish. The three to four years' apprenticeship required to become an expert able to apply wood finish to a car is reduced to six to twelve months with steel. A more uniform color can be maintained on steel finish than on wood, and the average life of paint applied to steel finish will be much greater for the reason that wood darkens with age. It is possible to manufacture the interior finish in much less time by the use of more men than it is possible to employ when applying a wood finish, as only a limited number have room to work at the same time in a car when the greater part of the fitting and cutting, etc., has to be done.

All of these advantages are almost exclusively confined to the use of steel or other metals, although a composite material of a wood pulp nature or similar material made fireproof and waterproof by different processes, if applied in a proper way and used for ceilings and below the window sills, is not objectionable, and may be applied in practically the same manner as stated.

The advantages possessed by wood over metal as a non-conductor can be very much reduced by the use of proper insulating material correctly applied.

PAINTING STEEL PASSENGER CARS.

C. D. Young, engineer of tests of the Pennsylvania, presented one of the most interesting papers of the evening. He described at some length the method now being used at Altoona, of artificially drying the paint on steel car bodies and trucks by means of an oven. An extensive abstract of Mr. Young's paper will be found in the Shop Practice section of this issue.

ELECTRIC LIGHTING.

H. A. Currie, assistant electrical engineer of the New York Central & Hudson River, presented a brief paper in which he drew attention to some of the features to which the designer should give careful attention in order to improve the reliability of the electric lighting of cars. He said in part:

From a standpoint of practical consideration for the welfare of passengers, the lighting plays one of the most important parts; therefore, every effort should be made to arrange the light units so that no discomfort is occasioned, and to install the apparatus and wiring so that operating failures are reduced to a minimum.

Convenience and accessibility of apparatus, fixtures, junction boxes and wiring mean much to the inspector. The average inspector will pay little attention to those parts which are difficult of access, and much better inspection work will result where parts are arranged in a get-at-able manner. It is of equal importance that the various parts be protected in such a way as to avoid all possibility of injury to them while the car is in service. The other essential features of the lighting installation are discussed in the following paragraphs:

It would be a consummation much to be desired if truck designers would provide a generator support built integral with the truck. The requirements are not difficult and it is certain that the generator builders would be glad to make their machines conform to the truck builder's suspension. For mounting the axle pulley, a straight machined seat should be provided in all cases if electric lighting is planned or can be anticipated.

Head room for the generator should be considered in laying out deep center girders, brake rigging and piping. All the open space that can be provided about the generator is desirable because it facilitates thorough inspection. The generator terminal board should be attached to the underframe of the car close to the generator and readily accessible.

The switchboard locker should be so located as to be at all times easily accessible to the trainmen; no pains should be spared in the design and installation of the board; nothing but fireproof material should be used. A receptacle for spare lamps and a report card holder are convenient accessories. The regulator locker is generally located under the switchboard and on the generator end of the car. Good ventilation is a necessity. Provision against dampness and dirt is imperative. The regulator lockers should be fitted with locks.

It was formerly customary in applying electric light to retain gas lighting as a reserve. Increasing reliability of electric lighting apparatus has made this unnecessary and in the best present practice no gas equipment is provided. For emergencies it is customary to provide holders for candle lamps but it is only on rare occasions that these have to be used, if the electric equipment is of a good modern type.

ELECTRICAL EQUIPMENT ON MOTOR CARS.

F. W. Butt, assistant engineer in the electrical department of the New York Central & Hudson River, stated that particular attention should be given to locking bolts, nuts, screws, etc., to prevent them working loose on account of vibration, especially those which are used to secure the electrical apparatus. The vibrations of the motor gearing are transmitted to all parts of the car and they are more pronounced when the motor suspension lug is mounted on the truck transom, without the use of suspension springs. Vibration is more easily transmitted through the solid structure of steel cars than it is in cars of wood.

In the design of new cars it is sometimes found convenient to locate various members of the structure, especially in the underframe, so that the apparatus can be suspended from them without the use of intermediate supports. This is desirable, as it is often found that many extra parts may be omitted from the car. Where heavy apparatus is to be suspended from intermediate supports, large heavy members are required, necessarily complicated in design in order to obtain clearance between parts of the structure or apparatus.

Where it is possible, hangers should rest on the members which support them and not depend entirely on a vertically bolted or riveted connection. The hangers should be well braced, especially those which hang far below the underframe, to prevent swaying of the apparatus, due to the motion of the car. The hangers can be so designed as to provide the necessary bracing.

It is recommended, in order to interfere as little as possible with the general anti-telescoping scheme, that two small switchboards be used, one placed in the bulkhead on each side of the body-end door opening, and located as high above the platform as the size of the boards will permit.

AIR BRAKES FOR STEEL PASSENGER CARS.

A. L. Humphrey, vice-president and general manager of the Westinghouse Air Brake Company, briefly reviewed the development of the air brake, made necessary by the continual increase in the weight of high-speed passenger trains. The perfection of the electro-pneumatic brake and the clasp brake were mentioned as the latest developments in this field. It was shown that the weight on drivers of high-speed passenger engines had increased from 25,000 lbs. to 180,000 lbs. since the introduction of the air brake, while the drawbar pull has increased from 7,000 lbs. to 30,000 lbs. The weight of passenger cars has increased from 20,000 lbs to 150,000 lbs. while, at the same time, schedule speeds of passenger trains have increased from 30 miles an hour to 65 miles an hour. Taking the average weights of trains and

average speed at the time the air brake was introduced as compared with the trains and speeds of today, the weight per vehicle has not only increased nearly eight times, but the foot-pounds of energy to be destroyed is nearly 15 times as much. In order to meet the demands of modern service conditions as efficiently as heretofore, means should be provided for dissipating the total energy stored up in this swiftly moving mass in at least as short a time and distance as before. In fact, it is desirable to do this in as much less time as is consistent with comfort to passengers and accuracy of control, in the case of service stops, and in as much shorter distance or time as may be possible in the case of emergency. Not only must the brake be automatic in its operation, but it must be capable at any time and under any conceivable circumstances of producing the maximum possible retarding force within as short a period of time as the known resources available and physical limitations will permit.

When we consider that it requires a distance of 8 to 12 miles for a locomotive of modern design, hauling a train of say ten cars, to accelerate to a speed of 80 miles an hour and that this same train should be brought to a standstill within the shortest possible time, say in one-tenth of the distance required to accelerate to this speed, it is hardly conceivable that this can be done with the means available, which is a retarding force produced by frictional contact of metal shoes against the wheels, which is, in turn, limited by the adhesion between the wheels and the rail.

The improvements made in air brakes in recent years, which have made it possible to control the present heavy high-speed passenger trains with approximately the same degree of efficiency as the older forms controlled the equipment of their day, have been based on scientific principles and experience in obtaining reliable information and data. The matter of time of transmission of compressed air was not so important a factor with the shorter trains and slower speeds as it is today, where a train running at 80 miles an hour passes over a distance of 117 ft. a second; consequently a few seconds saving in the time of getting the brakes fully applied is just so much relative gain in the time and length of stop. With the latest improved pneumatic equipment, the maximum brake cylinder pressure can be obtained throughout a modern train of ten cars in 4 seconds, which is the shortest possible time that this can be obtained by serial quick action through a train of this length. For the purpose of shortening this time serious consideration is being given by some railroad officers to the type of brake equipment used on the New York subway, and known as the electro-pneumatic, which would not only tend to cut the time of full application in two, but by means of the electric control all brakes are applied simultaneously, which not only assists in shortening the stop but in preventing shocks, etc.

Another equally important factor now coming more prominently in use is the application of brake shoes to each side of the wheel, known as clasp brakes. The virtue of clasp brakes, however, is not so much in the aid they afford in shortening the stop as in the equalizing effects of pressure on the wheels, journal box bearings and trucks, the minimizing of lost motion which affects the brakes through increased piston travel, and the less tendency toward wheel sliding while the brakes are applied.

CAST-STEEL DOUBLE BODY BOLSTERS.

C. T. Westlake, chief mechanical engineer of the Commonwealth Steel Company, briefly reviewed the history of cast-steel as a reliable material for steel passenger car underframes. This material was comparatively unknown as recently as 1893, but since that date has been used in an increasingly large number of places throughout the car.

Mr. Westlake stated that the ideal underframe should have all connecting members in the same plane so as to avoid buckling due to eccentric loading; it should be so designed that each member will independently perform its individual functions,

passing the stresses from one member to the other through the smallest number of properly aligned connections; and all should be so arranged in relation to each other as to form one powerful, compact, shock-absorbing element throughout the length of the car.

This can be accomplished to advantage in cast-steel construction since the metal can be properly distributed in proportion to the stresses. The gusset plates can be placed in the same plane as the flanges of intersecting members, and the whole reduced to minimum weight and to the smallest number of parts with practically no joints. It can be molded to any desired conformation, can be shaped to any curve, useful or ornate, without the use of expensive dies, and can be provided with necessary projections joined to the main members by proper fillets. Openings may be provided with finished and reinforced edges, and all parts may be molded to symmetrical, pleasing contour, all edges rounded and a complete, practical, operative device, emanating from a single source, furnished to the car builders ready for application.

The underframe receives the force of end collision as a column load on its longitudinal members, while the end frame receives it as a transverse load on exposed members supported at their ends. As it is impracticable under these conditions to make the end frame equally as strong as the underframe, provision should be made for protecting the end frame against destructive forces. The underframe should be arranged so as to receive the initial impact, and if the encountered force is sufficient to destroy it, it should fail in such manner as to form additional protection to the end frame.

This is accomplished in cast-steel construction by arranging the parts of the longitudinal members so that when loaded to destruction by a collision force, the end portions yield upwardly, thus folding the exposed portion of the platform up against the end of the car body, and forming an addition to the end frame to assist in distributing the force to all the longitudinal members of the superstructure. The advantage of this construction has been demonstrated in wrecks when this identical action has taken place, the safety of passengers being assured, and the property loss low.

In designing the cast-steel end frame we assume it to be a beam supported at its upper and lower ends and loaded at a point about 18 in. above its lower end. We provide connections between the end frame and balance of the car frame of sufficient value to develop the full transverse strength of the end frame; the vertical members of the end frame are connected by horizontal members so that in case the end frame is loaded to destruction the connections are sufficient to disrupt all the longitudinal members of the car frame, and when they yield, all parts will be forced toward the center of the end of the car and tend to prevent one car telescoping the other.

Cast steel stands preëminent in car construction as the best material for reducing the weight and number of parts to a minimum while maintaining requisite strength and other essential properties, and its popularity and use will proportionately increase as its benefits and advantages become more generally recognized.

UNDERFRAMES.

John McE. Ames, mechanical engineer of the American Car & Foundry Company, confined his remarks to the underframes of steel passenger cars for through service, or those at least 70 ft. in length, and did not attempt to discuss underframes for suburban or individual service where they are not subjected to the same severe service strains. Lantern slides were used to demonstrate the effect of severe collision shocks on the center sills and other parts of the underframe of the various types mentioned in the paper. These showed that the designs recommended by the author were fully capable of withstanding the most severe stresses that could be imposed on a passenger car.

Abstracts from the paper prepared by Mr. Ames follow:

The natural division of underframe designs is: The load carried equally on all of the sills; the load carried on the center sills only; the load carried on the sides only; the load carried on both side and center sills.

Each of these types has its partisans and each is in successful operation today. The first is used abroad almost universally and at home for repairs under wooden cars, the bodies of which are too good to destroy but need better underframing. With most of the foreign cars the body rests on and is bolted to the underframe from which it may readily be removed. The buffing and draft conditions differ from ours in that the buff is taken through the side sills on account of the use of separate side buffers, and the draft through the center sills. This permits of a distribution of metal in each sill member to give a uniform stress.

An example of the first type designed for a wooden superstructure, consists of four deep sills of what is known as the fish-belly type. These center sills are composed of vertical 5/16-in. plates, 30 in. deep at the center with 3 in. by 3 in. by 3/4 in. angles riveted along the top and bottom edges; the plates are reduced to a depth of 12 3/4 in. over the bolster. The center sills have a square inch section of 37 at the center and 26 at the draw gear. One disadvantage in these long plate sills is that when punching the line of holes along the edges the plate becomes distorted and wavy. It is then difficult to rivet the angles in place and obtain their full value. Again, in case of accident and the dropping of the underframe on the roadway, the bottom angles are bent or broken, making a difficult repair operation.

In general, the deep side sill has been discarded because of the difficulty of inspection beneath the car. The deep center sill is much in vogue at present because it looks strong, but on a car with deep center sills inspection must be made of the parts attached to the underframe from one side of the car at a time, and the introduction of axle light equipment becomes difficult on account of the interference of the deep sills. Again, to sustain its own weight without deflection on a 60 ft. span, too much weight of metal is required to make such a sill economical.

Of the second type, that is, with the whole weight to be carried on the center sills, a common form has center sills of two special 18-in. channels with 1/2-in. cover plates top and bottom, all sections extending the full length of the car in one piece. The box girder so formed has a square inch section of 50, and the superstructure load is transferred to these sills by means of four cross bearers, two of which take the place of the body end sills in other designs. There are no side sills as such, the angles simply forming the attachment for the superstructure. The parts are usually assembled with the bottom of the sills upward and allowed to deflect. The girder is then reversed and the camber straightens out by the weight of the metal. The sills are the same depth and section throughout their length and with this construction a truck of special design must be used, the center plate of which must be nearer the rail than usual. The weight of the body rests on the side bearings as well as the center plate. The service given by this underframe has been excellent.

The third type, with all the weight carried by the car sides, has the center sills used only for buffing and pulling. An example which may be referred to has two I-beams running the full length of the car in one piece, with a square inch sectional area of 23. They are held up by the three cross bearers which pass under and are attached to them. There are no side sills, the carrying members being the sides of the car. These members are composed of 1/8-in. plates, about 36 in. deep, stiffened vertically by the window posts and having a 6 in. by 6 in. by 5/8 in. angle at the bottom and an equal square inch section of metal at the belt rail, the two girders having a square inch section of 48 in all. With this construction a substantial body bolster is essential, as the weight must be carried at the bolster extremities. Usually a cast-steel structure, built into the underframe

and securely riveted to it, is used, as the weight of the metal may thus be economically distributed. With an underframe of this type there is no trouble due to difficulty of inspection or interference with attachment for axle light or other equipment under the car.

The fourth type is a combination of the second and third. Here deep center sills are used, having a section of about 40 sq. in. at the center and 39 sq. in. in cast steel at the draw gear. The side girders have a combined section of 21 sq. in. Most underframes of this type now in service are built with cast-steel ends, and portions which include in one casting the body bolster, platform, side and center sills extending as far back of the bolster as may be necessary to secure a substantial connection to the center sills proper.

While several of these four types have been in service for a number of years, the required time has not passed in which to develop structural defects due to unseen causes, such as fatigue of metal, crystallization, etc. If such defects exist they should make themselves known during the next three or four years, if freight construction is any criterion. We know fairly well the behavior of these types under unusual service conditions due to wrecks.

SPECIAL ENDS FOR STEEL PASSENGER CARS.

H. M. Estabrook, president of the Barney & Smith Car Company, briefly traced the development of passenger car ends and roofs from the beginning. It was shown that until the advent of the narrow vestibule in 1887 no systematic attempts had been made to strengthen the ends of cars. The broad vestibule was introduced in 1888. About the year 1890 there came in use what was known as an anti-telescoping end framing. Somewhat later this type of end framing was elaborated on.

The increased weight of the vestibules and anti-telescoping end framing developed the necessity for a stronger platform construction than the old style wooden platform that had been used for many years. About the year 1895 the standard steel platform, composed of steel I-beams, came in general use, and was employed continuously until the advent of the steel car superseded it by other designs.

Notwithstanding the efforts of Congress toward the general adoption of steel passenger cars, it has been stated on reliable authority that no vestibuled wooden passenger car, in the construction of which was employed the anti-telescoping end framing, in a straight-on end to end collision (although frequently having the ends concaved) has ever had the end crushed in to the extent of the adjoining car body telescoping and entering it.

When the steel passenger car made its appearance about the year 1905, the passenger car entered a period of transition and evolution from which it has not yet entirely emerged with a recognized standard form of construction. In the construction of the early steel passenger cars an attempt was made to follow closely the lines employed in the construction of wooden cars, with the result that the first steel cars were inferior in strength of end construction to the prevailing wood construction, but the evolution has been rapid, one improvement following close on the heels of another. This has resulted in rapid improvement of end construction until we have today reached a design that is considered practically standard. This development has no doubt been hastened by the action of Congress relative to steel postal cars and the cooperation of committees of the railway mail service, the railroads and the car builders, to the end that a standard specification for the strength of the various parts of the car, and especially the end construction, has been adopted by the Postoffice Department.

There are at this time three distinct forms of construction employed: The one most generally used is composed of rolled-steel sections with the center sills running the full length of the car from buffer beam to buffer beam. Another type is that in which the rolled steel center sills connect at the bolster with a steel casting, forming a combined body bolster, center and side

sills, and end sills. Another type is that in which the rolled-steel center sills connect at the bolster with a steel casting, forming a combined body bolster, center and side sills, end sill and the entire end frame of the car.

It is, of course, apparent that the weight of the steel car is much greater than a car of the same size of wooden construction, and that the wooden car possesses in itself a natural elasticity to absorb buffing shocks, such as are produced by collision that the steel car does not furnish. Hence, in the development of the steel car, with the enormous increase in weight of trains and the high speed at which they run, there has been a growing tendency to increase the strength of the structure with the view of making it as nearly indestructible as possible to compensate for the absence of elasticity. It is also apparent that, notwithstanding the strength of the structure, if it encountered an opposing force of sufficient magnitude, it might be annihilated, and so this strengthening process, and the increasing weight and speed might go on indefinitely without furnishing the result sought for. It is equally true that if the structure is designed for such strength as to be indestructible, when the two opposing forces meet the movable objects within the cars, which is the human load, must suffer the damage. To avoid this possibility the idea has been evolved to construct that portion of the end of the car between the end of the main body and the vestibule face plates, so that it will collapse under a less shock than would be required to crush in the end of the car body itself.

This idea is based on the theory that in a train in which there are say ten vestibuled cars, there is the space between the main bodies of each two coupled cars occupied by the platforms and vestibules of approximately 8 ft., or in a ten-car train a space of approximately 80 ft., of shock absorbing space, which, if properly utilized in the instant of collision, would remove to a large degree the shock and resultant damage to the car body itself and likewise lessen the possibility of damage to the persons of the passengers. From this idea has developed what is termed a collapsible vestibule. It is generally conceded that if two vestibuled cars coupled together could maintain their respective horizontal planes at the instant of shock due to collision, there could be no telescoping and that telescoping is due to one car assuming, at the instant of collision, a higher or lower horizontal plane than its adjoining neighbor, causing one to ride the other with the resultant telescoping effects.

It is also generally conceded, that in cases of two cars tending to telescope, the point of maximum shock is never over 20 in. above the floor line. In the government postal car specifications, this point has been definitely fixed at 18 in. above the floor line, and with this in view the end posts are reinforced for a distance of about 4 ft. above the floor line by steel angles riveted to the Z-bar end posts.

In the construction of this collapsible vestibule the longitudinal sills and floor members are designed to stop at the end sill of the car body proper, the end of which is sheathed with a heavy steel plate extending in one piece vertically from the roof downward to the bottom of the end sill.* If the shock of collision is not entirely absorbed by the vestibule members before the end of the car body proper can be crushed, this plate will tend to pull the roof downward and cause the direction of the oncoming car to deflect obliquely upward. Further to offset the effect, should the two cars change their horizontal planes in collision, pressed steel shapes in the nature of anti-climbers, are placed below the buffer beam and platform.

The platform, vestibule and hood members are designed with a view of withstanding all shocks incident to regular service, but in abnormal shocks, such as would result from collision, the rivets connecting the various members would shear off with the exertion of less energy than would be required to crush the end of the car body, thereby causing the vestibule to collapse, absorbing the shock and furnishing a cushion between the two

*This design of vestibule and end was illustrated on page 87 of the February issue of the *American Engineer*.

car bodies proper. It is assumed that in case of a collision these would be the only parts seriously damaged, and the car could be repaired and replaced in service with a minimum of expense and delay.

The entire collapsible vestibule, comprising the platform, vestibule and hood, is constructed as a unit, detachable and separate from the car body proper and can be applied after the car is built or in the alteration of cars already built and is equally applicable to cars of either steel or wood construction.

MINE RESCUE CAR

A special car has been built by the Lehigh Valley which contains apparatus and facilities for use in mine rescue work and in caring for the injured at serious mine disasters. It was formerly a combination baggage and smoking car; the baggage compartment has been fitted with an operating table, sets of surgical instruments, first aid supplies, and all other facilities of a first class operating room. There are six regular army stretchers held in racks overhead, and along the wall are fifteen large oxygen tanks and the pumps for charging oxygen helmets of which there are a dozen stored in this compartment. Other apparatus for rescue work includes the small oxygen tanks to be used with the helmets, spare potash cartridges, pulmotors, inhalers and tools for emergency mine work. In the former smoking compartment of the car a galley with a cook stove has been installed and there are two facing seats arranged so that they may be quickly converted into a bed. An overhead tank provides a liberal supply of water and both hot and cold water are at all times available. The car is heated by steam and is arranged so that the steam hose may be run to it from any colliery; there is sufficient radiation capacity to insure comfort in any weather. This car can accommodate fifteen men, and while primarily designed for rescue work is also being used

for a demonstration room for instructing miners on the subjects of safety and rescue work.

REFRIGERATOR CARS FOR THE UNION PACIFIC

The Union Pacific has recently received from the American Car & Foundry Company a number of refrigerator cars equipped with Bettendorf steel underframes and the Bohn system of refrigeration. These cars, which are for the Pacific Fruit Express line, have a capacity of 60,000 lbs., are 39 ft. 10 $\frac{3}{4}$ in. long inside of the end linings, and weigh 48,100 lbs.

The center sill is an 18-in. 92-lb. I-beam, and is 33 ft. 4 in. long; the draft sills are of cast steel, with lugs cast integral for the draft springs, and are riveted to the center sill. The body bolsters consist of 8-in. 34.6-lb. I-beams; there are four cross-bearers, between the body bolsters, built up of 8-in. 18-lb. I-beams. The side sills are 4 in. by 3 in. by $\frac{3}{8}$ in. angles and the end sills are 4 in. by 4 in. by $\frac{3}{8}$ in. angles. The sub-side sills and sub-end sills are of Oregon fir, the former being 3 $\frac{5}{8}$ in. by 9 $\frac{1}{4}$ in., while the latter are 5 $\frac{3}{8}$ in. by 8 $\frac{3}{4}$ in. Four intermediate stringers or nailing sills of 3 in. by 4 in. Oregon fir are used. The steel underframe is diagonally braced at the ends between the end sill and body bolster by two 6-in. 3-lb. channels.

Cement-coated nails are used throughout the car in the insulation. The first or blind floor is covered with a coat of hot Hydrex compound; the two intermediate floors are of ship-lapped Oregon fir, while the top floor is in two layers, both being tongued and grooved. Between the two top floor layers is a layer of Monarch mica surfaced car roofing insulation paper. The body framing is of Oregon fir throughout. Per Bona insulating paper, manufactured by the Lehon Company, is used in the sides, ends, doors and roof. In the insulation of the roof there are a $\frac{3}{4}$ -in. inside lining, two courses of intermediate lin-



Refrigerator Car with Bettendorf Steel Underframe.

ing and a 3/8-in. blind lining, all with air spaces between them, and there is also an air space between the blind lining and the roof proper. Between the two 3/4-in. layers of roof boards is a layer of insulating paper and one of Hydrex compound applied hot.

There are four ventilators, one over each hatch, the latter having an opening 28 1/4 in. by 22 1/4 in., and there are four well traps, one located near each corner of the car. The hatches are equipped with the Bohn patent hatch ventilator, and are also provided with hatch plug indicators, which show whether the plugs are opened or closed.

The trucks are of the arch bar type, with 4 1/4 in. by 8 in. jour-

Total cubic capacity	2,440 cu. ft.
Available cubic capacity between ice tanks	2,041 cu. ft.
Capacity of both ice tanks	11,000 lbs.
Width inside of lining	8 ft. 2 3/4 in.
Width over side sills	9 ft. 1 1/2 in.
Width over sheathing	9 ft. 2 3/8 in.
Width over eaves	9 ft. 6 in.
Distance, center to center of body bolsters	0 ft. 8 in.
Truck wheel base	5 ft. 6 in.
Total wheel base	36 ft. 2 in.
Height of side door opening	5 ft. 9 7/8 in.
Width of side door opening	0 ft. 8 in.
Height, top of rail to eaves	12 ft. 3 11/16 in.
Height, top of rail to top of brake shaft	13 ft. 7 1/4 in.
Height, top of rail to top of running board	13 ft. 0 1/2 in.
Light weight of each truck, about	6,100 lbs.
Weight of car complete	48,100 lbs.

CARE AND MAINTENANCE OF AIR BRAKES*

BY RALPH WOLFE.

On account of the increased size and efficiency of the locomotives throughout the country, which has resulted in the handling of 80 and 125-car trains, it has been necessary to make a more severe inspection of the air brake apparatus in order that the proper results may be obtained, which is not only the question of stopping the trains, but the results obtained at the time the stop is being made. The capacity of the cars has also increased, which has resulted in a larger volume of air to be handled and carried on each car to get the required braking power. This, of course, has resulted in the increasing of the pump capacity on the locomotive from 66 cu. ft. of free air to be handled per minute to 131, or about 100 per cent. With the increased pump capacity and the increased volume of air, there are many factors to be taken into consideration in order to get the proper operation of the brakes. There are (1) the efficiency of the pump and what it costs to pump against leakage on big trains; (2) the brake pipe leakage and if the rate of reduction is sufficient to cause undesired quick action of the triples; (3) the length of piston travel in order to get the proper brake pressure with a given brake pipe reduction, which will have the proper retarding effect on each car, and (4) the results obtained due to unequal distribution of braking power throughout the train.

With an 80-car train of 10-in. equipment, we have a volume of 275,200 cu. in. If the conditions were such that we had a 12-lb. brake pipe leakage per minute, we would lose 130 cu. ft. of free air per minute, which would be equivalent to the capacity of the 8 1/2-in. cross compound pump. If the leakage was 6 lbs. per minute, we would be losing 65.5 cu. ft. of free air per minute, which would be equivalent to the capacity of the 11-in. single stage pump. It is estimated that the 11-in. pump requires a coal consumption of 200 lbs. per hour; this would require 4,800 lbs. of coal to operate the pump for twenty-four hours. Estimating the price of coal at \$2 per ton, it would cost \$9.60 to pump against a 6-lb. leakage on an 80-car train for 24 hours. If 30 trains were being handled under the same conditions for 24 hours, it would cost \$288 for fuel alone. While working under the same conditions with the 8 1/2-in. cross compound pump, the cost of fuel would be approximately \$100 for pumping against leakage.

With the cost of pumping against leakage, the question of handling the train without damage to the equipment has got to be considered, and what will take place when an automatic brake application is made. If with a 12-lb. brake pipe leakage per minute on an 80-car train, we lose 130 cu. ft. of free air per minute, when an automatic brake application is made, the rate of reduction will be increased 76 cu. ft. of free air per minute, making a total of 206 cu. ft. of free air per minute, which will cause all triples to move to full service position. If we have a valve in the train that is sticky or has a port restriction, an undesired quick action will be obtained which in many cases may result in the ends of two or three cars and as many draw-

*Presented before the Car Foremen's Association of Chicago, April 14, 1913.

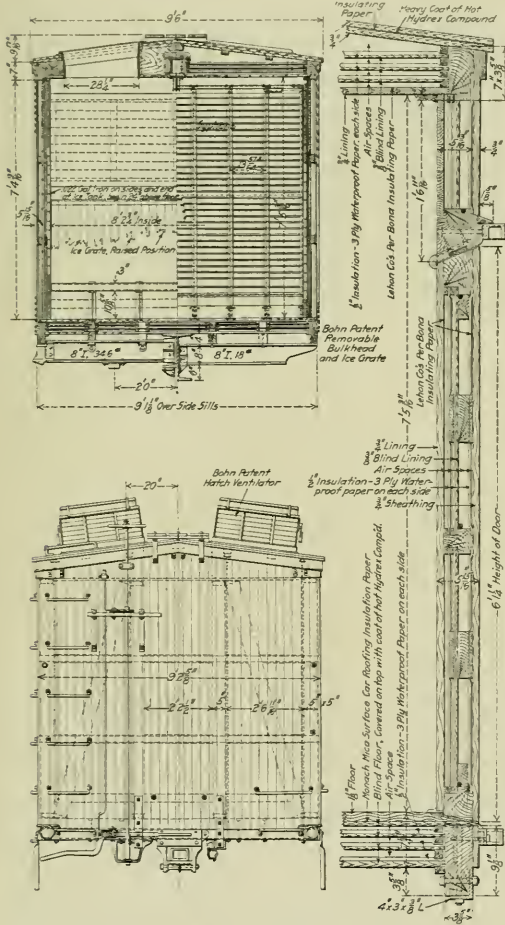

End Elevation and Cross Sections of Union Pacific Refrigerator Car.

nals, and are equipped with the Barber truck roller device. Chilled cast-iron wheels are used and the truck wheel base is 5 ft. 6 in. The side bearings are of the Miner gravity roller type; the draft gear is the Miner tandem, with M. C. B. class G springs.

The principal dimensions and data are given in the following table:

Length over end sills	40 ft. 9 3/4 in.
Length over sheathing	40 ft. 11 1/8 in.
Length inside of lining	39 ft. 10 3/4 in.
Length between ice tanks	33 ft. 4 1/2 in.
Height, top of floor to ceiling	7 ft. 5 3/16 in.

bars being pulled out. It is readily seen that under the above conditions the engineer has no control of the brakes in the way of a given brake pipe reduction. There has, however, been a decided improvement in the air brakes in the past two years. This has been due to the close attention given the triples, as well as the tests they are subjected to on the improved test racks.

But the conditions relative to leakage remain about the same; this is because the test given the cars at the time of cleaning is not severe enough to develop the small leaks, as it is customary when a car is cleaned to attach a hose to the brake pipe and test for piston travel and such leaks as can be observed by sound. If the cars were tested by coupling a dummy to the opposite end of the car from where the test hose was applied and the joints and angle cocks were coated with soap suds, it would indicate the small leaks, which are the ones that cause the trouble. This would show about 60 per cent. of the angle cock plugs to be leaking on account of foreign matter collecting on the plug, holding it from its seat, and that 50 per cent. of the hose couplings are leaky on account of improper application of the gaskets, which are the principal leaks that cause the trouble. This might require more help and more material; but, figuring the cost of pumping against leakage and the cost of maintenance of the equipment, a soap-suds test for all cars when on repair tracks will be economical.

CAR BRASS BORING MACHINE

Many car brasses are returned to the shop for rebabbiting, before they have covered their possible mileage, for some minor defect which might be corrected by simply boring them to a smooth bearing. In many cases, however, the time and labor incident to this work would not be warranted with the present equipment in most shops. The machine shown in the illustrations has been designed for this special purpose, and will handle brasses at the rate of five per minute. With such a machine located at the various division shops on a railroad system the brasses with minor defects may easily be bored and kept in service for a much longer time. This would materially reduce

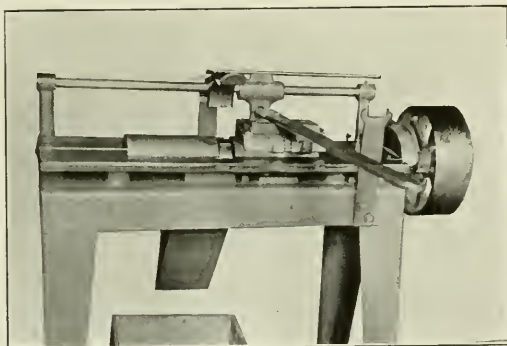

Brass Boring Machine Ready for Operation.

the number of brasses to be rebabbiting, would make possible a much smaller rebabbiting plant, and would greatly reduce the number of brasses carried in stock. Usually the rebabbiting is done at the main shops, which are some distance from the outlying points, necessitating sending the brasses back and forth over the road.

The machine consists essentially of a rotary cutter provided with six teeth. This is mounted on a spindle which may be driven either by a belt or by a motor. The brass is placed on the guide block at the right of the cutter, and is fed over the cutter by pressing down on the lever extending across the

machine. The farther end of this lever contains a split nut, which is lifted into mesh with a lead screw; the screw is driven by the spindle through gears, when the operator bears down on the other end. This will feed the brass across the cutter at a uniform rate of speed. The shavings are caught in a box underneath the machine, and may be returned to the babbiting plant for remelting. Incidentally, it has been found that the value of the shavings will more than pay the wages of the operator.

The second illustration shows the apparatus with the various

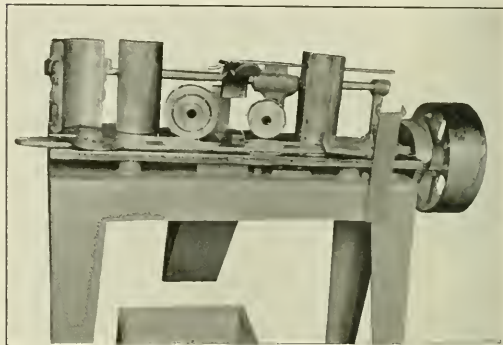

Brass Boring Machine Showing Guides and Cutters.

removable parts placed on the bed of the machine. Different sizes of cutters and guide blocks will be required for the different sizes of brasses. The guide blocks are held in place by dowel pins and may be easily removed. The shield, which is shown in both illustrations in the raised position, is to protect the operator from injury. It is automatically raised as the shoe passes over the cutter. This machine was designed by Bernhardt Henrikson, Austin, Ill. It is used in the Chicago & North Western shops at Chicago, being driven by a 2 h. p., d. c. shunt motor which is connected to the spindle by a belt.

FREIGHT CAR TROUBLES*

BY C. L. ALDEN,

Foreman Car Repairs, New York Central & Hudson River, West Albany, N. Y.

How often we have repeated, and heard others repeat, the old adage, "a stitch in time saves nine," and yet until recently little attention was paid to this in designing and building freight cars.

Freight traffic is essentially the revenue earner of nearly, if not all, railroads. One would naturally think, therefore, that the designing and building of freight cars would receive the utmost attention to the end that repairs, delays due to repairs, and loss of car service, etc., would be reduced to the minimum. It has been estimated that each day a car is on the repair tracks there is a loss of \$2.50 in earnings. At that rate, and assuming that only 10,000 cars a day are on the repair tracks, there would be a yearly loss of \$8,125,000 in car service alone. What portion of this sum may be charged to the improper design of the car or its parts? Of course we have no way of knowing, but we do know it is considerable. If it were only as much as 10 per cent. it would total \$812,500.

Not enough attention is given to the design of metal end sills. They are made too light and are collapsing wholesale, involving a great deal of labor to repair or renew. Stop castings on metal underframes are defective for the same reason. An eastern railroad is losing practically all grain loading in its cars because

*Entered in the Car Department competition, which closed February 15, 1915.

they leak grain; many of its cars move home empty, while foreign loaded grain cars are hauled over the road.

Ends fail generally because of a lack of proper stays or ties. Some secure the ridge pole to the end plate by a casting and bolts. This is very good so far as it goes, but it does not go far enough. The ridge pole is never very large and the result is that when the end is forced outward the ridge-pole is split—and away goes the end plate. Why not run a plate the whole length of the ridge-pole, and have an angle under it on each end, to fasten to the end plates? Why not run a plate from the corner post back to the door posts and have a tie worth while? Two many seem to think only of the first cost—nothing of future repairs and attendant delays. All-steel ends are on the market having corrugations. These corrugations, as a rule, are elliptical or horizontal. I believe they should be vertical.

Every car having bolts or rods should have them secured by lock nuts *that lock*. Wherever possible, journal box and column bolts should be eliminated. Care should be taken to see that the center channels are not too light. We must get back to some kind of a brake beam safety hanger—and it must not be a chain safety hanger, for they have proved a delusion and a snare. All-metal or metal underframe cars should be provided with drag chains or other provision for chaining the cars together. Many cars which have been derailed are not provided with means for readily chaining the truck to the car in order to raise both simultaneously with a wreck crane to place the car back on the track. This should be done on every car, as there is no other way to readily and expeditiously "do the trick."

On many metal underframe cars there is but 4 in. or 5 in. at the side sill on which to nail side sheathing. This is not enough, and suggest that the sheathing be secured by a small plate of wrought iron and bolts. Brake shafts should be square, or with a square fit for the ratchet wheel, and provision made so that the ratchet wheel will not creep up or down; instead of the shaft bearing being secured to the roof it should be placed on a step.

The car roof is a mooted question. Shall they be of steel outside or inside, plastic, double board, or what? We do find an outside metal roof to be rather dangerous to trainmen, especially when wet or icy. Why not, after painting, provide some kind of rough covering to prevent one's sliding over the surface? We all want a good freight car roof, one that does not leak a short time after its application.

We want a draft gear so designed as to permit the replacement of a broken coupler by two men anywhere in fifteen minutes at a cost of 12 to 15 cents, and we can have it by using a single cross key type of coupler with a suitable draft gear. Why the long delay or shopping of a car at a labor cost of \$1.20 when it can be done with slight delay in the train, at one-tenth the cost? Echo simply answers, why? Riveted couplers should be retired as rapidly as possible, along with continuous draft rods, wood brake beams, etc. Some metal underframe cars are designed with truss rods. An underframe that must depend on truss rods is not much of an underframe, and no metal underframe car should be so equipped.

Refrigerator cars should not be so designed that the longitudinal sills are concealed, thus preventing inspection. This is one of the most prolific sources of "no bill" bad order cars. These sills, concealed as they are, are broken, split, decayed, and cannot be detected by inspection; the result is that the draft timbers pull out, taking with them the couplers and attachments, breaking the head blocks, end sills, posts, sheathing, etc., and the delivering company foots the bills.

From a repair standpoint metal cars, or metal underframe cars, should not have center sills in one continuous piece from end sill to end sill. They should be so designed as to permit removal of sections in front of the body bolsters, and these front sections should be of cast steel, and include all necessary draft gear attachments without riveted stops, etc.

There are cars fitted with safety appliances on which the bottom end ladder rung does not coincide with the bottom rung of the side ladder. This should be otherwise, for trainmen come down the end ladder and stand on the pin lifter and end grab iron on the end sill, which is quite a considerable variation from the distance between the ladder rungs. They should be designed to obviate this and venture to predict the roads will make these changes voluntarily for their own interest, as it is positively dangerous.

The foregoing are some of the defects which, in my opinion, should be corrected. Of course all bolts on trucks and underframes should be secured by a nut, and a lock nut that grips. Many are lost off, probably due to not having been properly drawn up. There is a type, however, have never seen lost off.

BABBITTING CAR JOURNAL BRASSES

BY E. H. MOREY,
Shop Demonstrator, Chicago & North Western, Chicago, Ill.

Some five or six years ago, when car journals were smaller than they are today, the weight on them less, and the speed of trains not so fast, the journal brass was cast with a pocket for the babbitt and was filled through a hole in the center of the brass. There was no finishing done on this brass before being babbitted and when the journal wore through the babbitt to the lining and began to wear on the rough uneven surface it would cause trouble by running hot. Also, the hole through which the babbitt was poured weakened the brass just where strength was most needed.

About 1907 the design of the brasses was changed. They were



Incorrect Method of Babbitting Car Brasses.

cast with a straight face and bored out smooth, then trimmed and filled while hot on an upright mandrel, the babbitt metal being poured straight down the top end, as shown in the first illustration. The mandrel was kept cold by two ½ in. streams of water constantly running through it. The brasses filled in this way had all appearances of being good, but on taking a light cut over them they were found to be full of blow holes all the way down the center. Some were so bad that the bearing was insufficient at the center of the brass and was increased at the sides where there were no holes, thereby increasing the unit

bearing pressure and causing hot boxes. After considerable investigation it was found that the babbitt was being poured in too fast and after pouring a small stream of babbitt in several brases it was found that the blow holes were decreased but not altogether eliminated, there still being a streak of holes down the center. By further experimenting it was found that the cause of the holes was the metal carrying air in with it and pocketing it in such a way that it could not get out, consequently the babbitt hardened in this disturbed condition against the cold face of the mandrel.

To overcome this the mandrel was mounted so that it could be swung down, as shown in the second illustration. The metal is now poured in with the brass in this position, the babbitt



Correct Method of Babbitting Car Brases.

running down on the brass, which has previously been heated. In this way the babbitt cools more gradually and the air is given a better opportunity to escape. A foot lever is placed under the bench and a counterweight is fixed on the other end of the plate. After a series of experiments it was found that 45 degs. was about the proper amount to tilt the mandrel. To completely fill the brass the mandrel is raised to a vertical position for the last few drops of babbitt.

FREIGHT CAR DESIGN*

BY G. L. BUNDY,

General Foreman, Delaware, Lackawanna & Western, Kingsland, N. J.

No one can question the importance of the car department on a railroad and the freight car should be given more consideration in a great many cases than it has in the past. The designer should be given ample help and be allowed sufficient time to draw up the specifications and drawings in a thorough manner. Specifications should be clear, concise, and complete in all details. In some cases they are very incomplete; much is left to the builders, who naturally introduce their own standards and methods which are not always to the best interests of the railroad. Builders having no complete and definite specification to go by when making bids are tempted to reduce their manufacturing cost at the expense of material and workmanship so that

they will be enabled to submit prices which will be lower than those of their competitors. Past experience has taught us that builders should not be expected, without explicit and definite understanding, to build equipment which will be the best for the service and the most economical to maintain.

More uniformity should be encouraged among railroads in designing equipment, as having as many parts standard or interchangeable as possible, results in a great saving of time and money. It is not uncommon for railroads to hold cars 60 days awaiting material ordered for making repairs to a foreign car. Master car builders at their annual conventions should adopt more standards and follow them in designing new cars wherever it is practical to do so.

When new cars are to be built or purchased the designer should call together the car men from all repair points and learn from them the parts that have shown a weakness in actual service. These men are in a position to observe the actual condition of cars in service and should be given an opportunity to offer suggestions to the designer. In the past designers of freight cars have in a measure failed to design cars to meet the requirements of actual service, and this is especially true of certain parts, the most important of which are as follows:

(1) The ends of cars have shown a decided weakness, especially because of loads shifting in switching service, and should be strengthened.

(2) The roofs have cost the railways vast amounts of money to keep in repair. Also large sums are paid annually for claims on account of goods damaged in transit due to leaky and defective roofs.

(3) Freight car side doors have caused a great deal of trouble and are expensive to maintain; like the roofs they have been responsible for lading being damaged in transit and should be given more consideration in designing new cars.

(4) Some railroads are still applying spring draft gears to cars which are of too small a capacity for the service they are subjected to. These gears should be replaced with high capacity friction draft gears. If this were done it would effect a big saving in the cost of maintenance and a large saving in damaged freight. It would also be the means of keeping cars in service a greater proportion of the time, as there are more cars made bad order on account of defective draft gear than for any other reason.

One of the railroad periodicals has been publishing a series of articles under the head of, "The Growing Cost of Maintenance of Equipment." A study of these articles shows that the draft gears, roofs, doors, and ends of cars are the parts that have been giving railroads the most trouble. If any one doubts this, a visit to the repair tracks will prove the truth of the statement and will show many weaknesses in car construction which would never have existed if the cars had been built to carefully prepared specifications in which first cost was not the only consideration. Therefore, let us design cars with better roofs, better doors, more substantial ends, and better draft gears to meet the service which is required of the freight car of today.

PUBLIC ROADS.—The Department of Agriculture reports that in the five years preceding March, 1912, the office of public roads of the department built 215 object-lesson roads; in all about 300 miles of road 15 ft. wide, and by expert advice aided in the formation of more than 650 model county road systems. It has also assisted 26 states in effecting equitable state-aid plans.

EFFICIENCY OF MINERS.—The report of the Department of Mines of Pennsylvania shows that in 1902 there were 36,392 miners employed and each had an average output of 8.74 tons of coal a day. In 1911 there were 43,324 miners employed and the average output for each was 7.65 tons a day, a decrease of over one ton a day. This decrease in efficiency means a loss of over 40,000 tons of coal a day.

*Entered in the Car Department competition, which closed February 15, 1913.

NEW DEVICES

REVERSING MOTOR PLANER DRIVE

On page 46 of the January issue of this journal appeared a description of a reversing motor drive for planers developed by the General Electric Company. A similar arrangement, but different in some essential features, has been perfected by the Triumph Electric Company of Cincinnati, Ohio. This company began a series of experiments several years ago with a view of developing a special apparatus for meeting the requirements of a direct connected reversing motor planer drive, at first using the type of motor that had been successful in connection with the belt drive. It was soon found, however, that a special design of motor would be required and this has been provided.

The essential difference between the Triumph arrangement and the one illustrated in our January issue, lies in the fact that the former does not employ dynamic braking for stopping the motor.

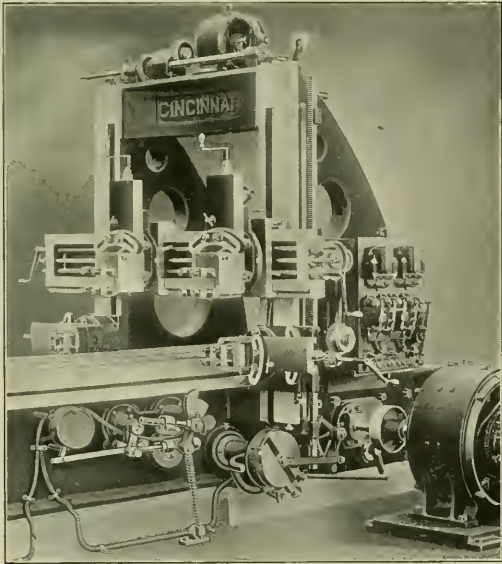

Large Planer Fitted with Triumph Direct Connected Reversing Motor.

In this case the planer is stopped and reversed by disconnecting the circuit to the motor and applying reversed power. It is claimed that this method results in increased speed of reversal, greater uniformity in length of stroke and decreased wear on both the motor and the controller. The reversed power is applied through resistances both for braking and reversing, and it is stated that the peak load never exceeds 50 per cent. overload.

A large panel carries all of the apparatus for automatically accelerating the motor to a predetermined speed in the required direction and for starting and stopping it at every cycle. This is mounted on the side of the planer housing as shown in the illustration. The apparatus on this panel is in duplicate, one-half being for the cutting stroke and the other for the return stroke. It includes, at the bottom, two rheostats for adjusting the speed of the platen on the cutting or return strokes independently. The tumbler handle on the side of the bed is replaced

by a master switch and this is connected by a short rod to a reversing switch also on the bed of the planer. Dogs on the table of the machine limit the length of stroke in the ordinary manner.

The master switch is thrown in the direction in which it is desired to have the table move and the switches on the controller automatically connect the motor in the circuit and successively cut out the different resistances and promptly bring the motor to its predetermined speed. The sequence of controller operations, when starting the motor, are illustrated diagrammatically in one of the illustrations. When the master switch handle is turned in either direction, the motor armature is connected in the circuit through resistances as are shown in the diagram at the top of the illustration. The series resistance is first cut out and the motor then operates as a compound, interpole machine with full field strength. The series field coil is next short-circuited and the motor then becomes a shunt, interpole ma-

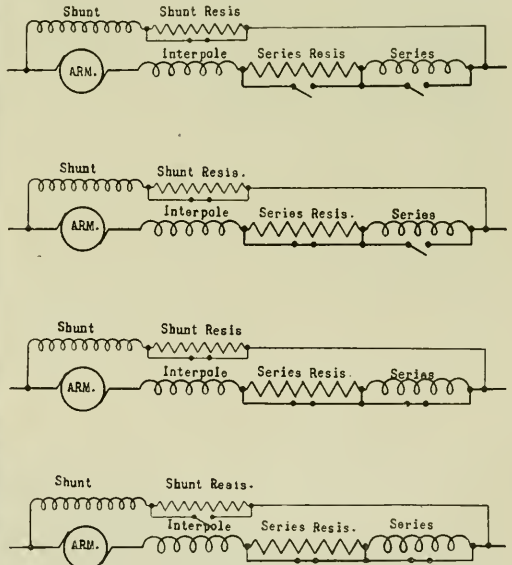

Sequence of Connections on Starting or Reversing the Motor.

chine still retaining the full shunt field strength. The shunt resistance short-circuiting switch is then opened as shown in the last diagram which causes the motor to attain its predetermined speed. When the trips on the platen reverse the master switch the switches return to their initial position and power is immediately applied in the reverse direction. It requires but one second from the time the master switch is thrown until the last switch operation for the full speed of motors is made. When the master switch is brought to the vertical position the motor and table are immediately stopped.

The speed of either the cut or return may be quickly varied in small steps, without stopping the planer, by a slight movement of the tumbler. Edging in $\frac{1}{2}$ in. strokes is also easily accomplished and it is claimed that the length of the stroke is accurate to within $\frac{1}{8}$ in. on cuts of any length or speed, making it possible to plane in pockets or close to ledges.

GASOLENE CARS FOR THE HOLTON INTERURBAN

The Holton Interurban, Redlands, Cal., has recently placed in service a type M-6 gasolene motor car made by the Hall-Scott Motor Car Company, San Francisco, Cal. This is the second Hall-Scott motor car purchased by this company, a type M-4 having been placed in service about two years ago. The power plant consists of a six-cylinder gasolene engine of 150 h. p. capacity, and has a speed range of from 4 m. p. h. to 60 m. p. h. in four stages in either direction. This flexibility of speed control will permit of yard switching and of the handling of one or more trailers, dependent, of course, on grade conditions.

room, a space 12 ft. long by 3 ft. wide being available for that purpose. The total weight of the car is 67,850 lbs.

During the first three months of service this car made an average of 75.6 miles per day. The following table gives the operating cost during this time.

RESULTS OF OPERATION FOR THREE MONTHS ENDING FEBRUARY, 1913.

	1912. December	—1913—		Average	Average cost for car operating under ordinary conditions
		January	February		
No. miles traveled.....	2,238	2,458	2,138	2,278
No. miles traveled per day..	72	79	76	75.6
Gallons gasolene used.....	767	785	725	759
Gallons gasolene used per mile	0.342	0.319	0.339	0.333
Cost gasolene per gallon....	0.23	0.215	0.215	0.22	0.10



Hall-Scott Gasolene Motor Car Hauling Twelve 20-Ton Beet Cars.

The car is of steel construction, the steel body, trucks, gasolene motors and driving mechanism being designed and built in the builders' factory at West Berkeley, Cal. It is 60 ft. long over end sills and has a seating capacity for 64 passengers in the main passenger compartment. The baggage room is 16 ft. long and is equipped with lift wall seats for eight additional passengers. Baggage and mail may also be carried in the engine

Cost gasolene per mile.....	0.079	0.068	0.073	0.074	0.033
Total cost gasolene	\$176.41	\$168.77	\$155.87	\$167.02	\$75.90
Gas engine oil used.....	26	37	24	29
Cost gas engine oil per mile..	0.006	0.0078	0.0058	0.0066	0.005
Cost gas engine oil per gal..	0.52	0.52	0.52	0.52	0.40
Engine oil per mile.....	0.011	0.015	0.011	0.012
Total cost engine oil.....	\$13.52	\$19.24	\$12.48	\$15.08	\$11.60
Machine shop bill	33.35	31.90	27.15	30.80
Cost repairs per mile.....	0.0149	0.013	0.0126	0.0135	0.0135
Cost operators per mile.....	0.089	0.081	0.093	0.087	0.087
Total operative cost per mile	0.189	0.169	0.184	0.181	0.1385



Gasolene Motor Car for the Holton Interurban.

Operator's cost figured on basis of \$125.00 per month for motorman.

Operator's cost figured on basis of \$75.00 per month for conductor.

Note that cost of gasoline and oil is excessive on account of the car being operated so far from distributing points for oil and gasoline. The last column at the right shows the operating cost for the car on the basis of Eastern prices for oil and gasoline.

The engine is mounted directly on the center sills of the car underframe. The clutch is of the contracting band type. The transmission is hung on the forward axle of the rear truck, and the axle is driven through a train of bevel and spur gears of hardened forged steel. The operating levers are placed on the right hand side of the car in a position convenient for the operator, being similar in their functions to automobile practice. The circulating water is cooled by a radiator placed directly in front of the car, as shown in the illustration, which provides a positive thermo-syphon circulation of the water and a ready means of completely draining the whole circulating system. A cooling fan is placed directly back of the radiator.

One of the illustrations shows another car of this same type, built for the Ventura County Railway, handling 12 side dump beet cars which have a tare weight of about 20 tons each. This motor car also hauls one of the road's standard coaches, as a trailer, in regular service.

Both these cars are equipped with the Westinghouse automatic and straight air brake systems; a double-cylinder water cooled air compressor directly driven from the main engine; and an electric generator, also driven from the main engine, which charges the storage batteries for lighting and starting the main engine.

MANDREL FOR SECTIONAL TUBE EXPANDERS

In order to remove the mandrel or pin from a sectional tube expander, it is generally struck with a hammer to loosen it. This is likely to cause the edges to break and fly, and serious injury may result to the operator. A new type of expander pin is shown in the illustration. It is designed for operating with either a short or long stroke pneumatic hammer in shop and roundhouse work. The tube is expanded by driving the pin into the expander in the usual manner. For releasing the pin,

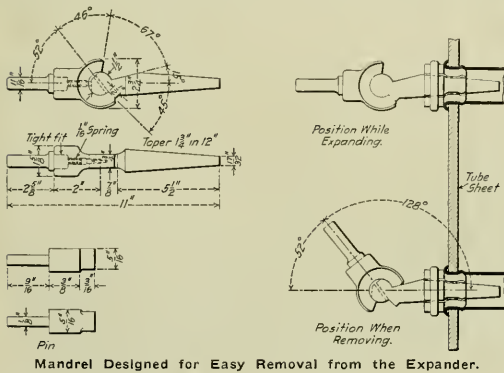

DUPLEX SPRING CLIPS FOR TRACING FILES

Comparatively few special devices have been introduced in railway drawing rooms for protecting tracings from damage and wear by handling. A spring clip for tracing files, blue print files and various kinds of loose leaf devices, which has been recently put on the market by G. G. Dana, 2311 Washington avenue, Racine, Wis., is shown in the illustration. The double or duplex spring, as the name implies, gives a pressure on the contents of the file preventing them from slipping about while the portfolio is being handled. It also prevents tracings from becoming curled or folded on the upper edge; without the clips they become worn and creased on the edges and corners, making them hard to handle in making blue prints and a source of general annoyance to the users.

The clip is so shaped that a tracing, blue print or sim-

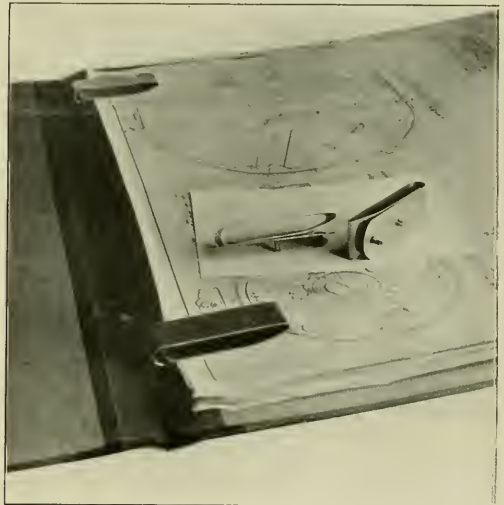

Special Clips for Holding Tracings in Portfolio.

ilar article may be easily slipped into its place or removed therefrom. Any sheet in the group may be removed without disturbing the remaining portions. An important advantage of the clip is the protection it gives to tracings in preventing the curling and folding over of the edges and corners. The clips are made of polished steel, are neat in appearance and convenient in use. They are attached to the back cover of the portfolio by clinch rivets.

HYDRAULIC PIT JACK

An improvement has been made in the construction of hydraulic pit jacks by the Watson-Stillman Company, New York. The hand-operated pumps have been replaced by pumps driven by air engines, and to make the power connection it is merely necessary to run a rubber hose or other flexible tubing from the shop air main to the pump engine. The operating valves may be placed in any convenient position, and the use of the compound air engine eliminates the necessity of having a pump operator.

By the use of air power the speed of operation is greatly increased. When it is desired to raise the saddle, air is admitted directly into the top of the reservoir, forcing the water into the

the knuckle joint is swung around to the position shown and a few taps with the hammer in this position loosen it and permit its easy removal. One of the features of this pin is that it can be used by the operator without separating the pneumatic hammer from the shank of the pin, thus eliminating the danger of possible injury from flying pieces, as well as saving time. The knuckle joint is made with ample bearing surface to prevent wear and does not interfere in any way with the working of the expander. This pin was devised by H. Neville, and is made by the Faessler Manufacturing Company, Moberly, Mo.

cylinder and lifting the ram. As soon as the load becomes too great for this pressure, the air is by-passed into the air engine, which in turn lifts the ram.

In the jack illustrated the ram raises at the rate of $7\frac{1}{2}$ in. per min., whereas only 2 in. per min. is attainable with a hand

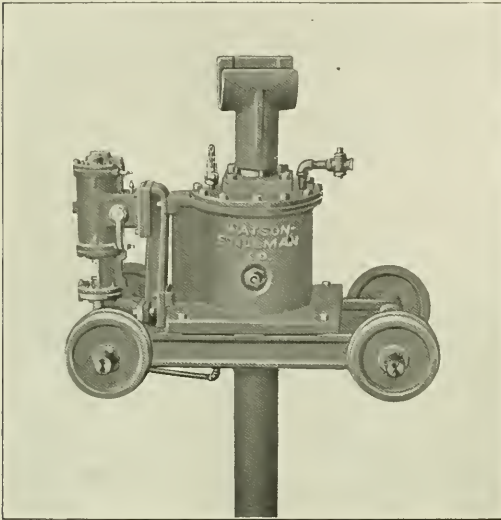

Hydraulic Jack for Use in Drop Pits.

power pump. It has a lifting capacity of 10 tons and a total lift of 103 in. The ram is telescopic in two lengths, 4 and 5 in. in diameter, respectively.

HEAVY ENGINE LATHE

Notable among the recent improvements in engine lathes is the quick change gear lathe, made by the Cincinnati Lathe

& Tool Company, Cincinnati, Ohio. There is an arrangement on it by which a combination of extra or metric pitches with a U. S. standard lead screw, or vice versa, is possible. The standard threads may be changed from one to another without duplicating or removing a gear by simply operating two levers. This gives the machine a very wide range. The device is complete in one unit, being assembled in a box mounted on the

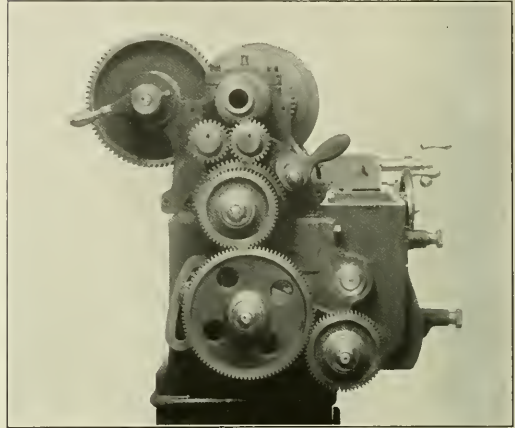

End of Cincinnati Lathe With Gear Cover Removed.

front of the lathe. It provides the facilities of a standard lathe, and each gear will cut not only the pitch required, but through the series of gear box changes will give others as well.

The bed of the lathe is made of semi-steel, being designed to give the necessary rigidity under heavy cuts. The head-stock is made in three styles, one with a three-step cone and double back gears, and with the four or five-step cones with single back gears. The spindle is made of high carbon forged steel and is provided with a collar on the chuck end, which gives a good, stiff bearing. The thrust bearing at the rear end of the spindle consists of a hardened tool steel collar arranged

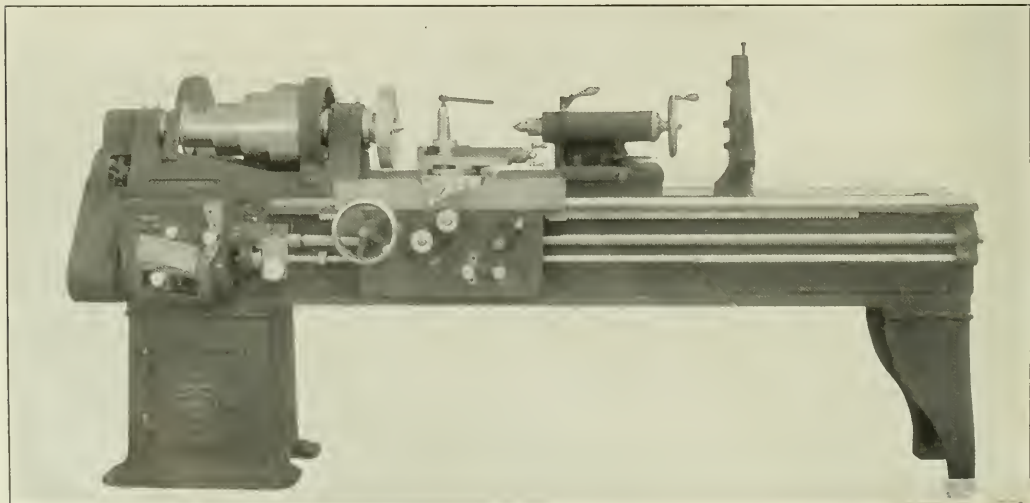

Cincinnati Quick Change Gear Lathe.

for adjusting the wear, the thrust being taken against the front end of the rear box. The spindle bearings are lubricated by self-enclosing dust proof oilers.

The apron is of the box type construction, being rigidly bolted to the carriage. The rack pinion is made of steel and is operated by compound gearing. The longitudinal and cross friction feeds may be started, stopped, or reversed while the lathe is running, but they cannot be engaged when the lathe is set for cutting screws. A thread chasing dial is provided which permits the half nuts to be opened, the carriage to be run back by hand and the thread to be picked up at any point, thus doing away with the necessity of reversing the lathe for this purpose. An automatic stop is also provided for throwing out the feeds.

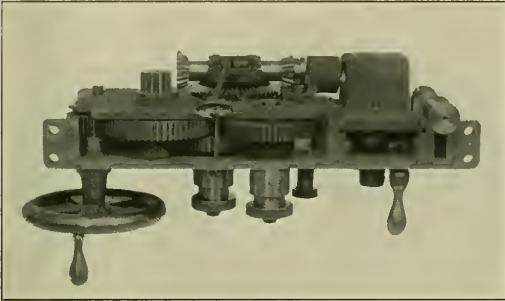

Feed Gears of Cincinnati Lathe.

The reverse plate for cutting right and left hand threads is on the outside of the headstock, and is used only for reversing the lead screw when cutting threads and not for reversing the feed. These machines have the feed reverse in the apron. The screw cutting and feed mechanism shafts are bushed through-out with bronze.

The tailstock has a long bearing on the bed, and is made to withstand the severe treatment of heavy work. It is of the offset type, allowing a compound rest to be set in a plain parallel with the bed. The tailstock spindle is of large diameter, and is equipped with a bronze nut for the lead screw. A special clamping device is used to hold the spindle in position instead of the split barrel construction. All gear changes may be made while the gear is running under heavy cut.

IMPROVED TYPE OF CORRUGATED TUBES

An improved process for making corrugated tubes has been developed by Mr. Maciejewski, a Polish engineer, in which standard wrought iron or steel tubes are used. The corrugations are made by an ingenious method of pressing the material together in such a way that, while shortening the tubes, the original inside diameter is not decreased. Furthermore the thickness remains absolutely uniform and is the same as in the original tube. During the process of corrugating, any defects in the material at once become apparent. In this process small and medium sized tubes are made from ordinary steel tubing, while for large diameters lap welded and re-rolled tubes are used. Tubes of any diameter from 1 3/4 in. to 18 in. may be corrugated; very long tubes may be partially corrugated.

Tubes of this type are adapted for use where expansion due to a considerable range of temperature has to be absorbed, or where a large external stress must be resisted. They are sometimes used in fire-tube boilers, especially where very long tubes are required. In such cases the corrugations, by taking up the expansion, relieve the tube sheets from carrying the strain. The principal field of usefulness, however, is in connection with steam

pipng. In short lines of pipe a straight corrugated tube will take care of the expansion satisfactorily, while in longer lines of pipe a corrugated tube bent in U shape is required. Tests have shown that a bend made of corrugated pipe will absorb over three times as much expansion as will the same size bend made of straight pipe.

Mr. Maciejewski's process has been patented in the United States and is controlled by Schuchardt & Schutte, 90 West street, New York.

OILSTONE TOOL GRINDER

A new design of tool grinder which has two oilstones, one coarse and one fine, as well as a ring emery wheel, has been designed by the Mummert-Dixon Company, Hanover, Pa. This grinder is especially adapted for tool room work and has two oilstone wheels mounted on the front arbor. In connection with each is a tool rest which can be adjusted to any angle desired and is held by a convenient locking device. These wheels are cup shaped and the oil is directed to the inside of the wheels and is passed out through the pores. When the wheels are once saturated they require very little oil. There is a guard to prevent the oil being thrown off the wheels and any surplus is caught in a pan and returned to the reservoir. Kerosene is employed and is handled by a rotary pump which takes its supply from the

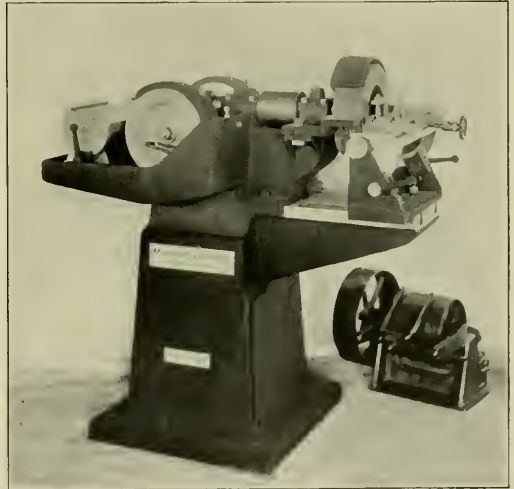

Tool Grinder with Two Oilstones and an Emery Wheel.

reservoir in the base of the machine. This keeps the stones sharp and prevents glazing and also protects tools from undue heating while being ground.

At the back of the grinder there is the ring emery wheel which operates at four times the speed of the oilstones. A slide is provided in connection with this wheel which has a micrometer adjustment and can be arranged for grinding at any angle. The table is arranged so that any part of the wheel can be readily used.

The machine shown in the illustration is arranged for belt drive, but when a motor drive is desired, the motor is mounted in the base of the machine and belted directly to the pulley.

THIRD-CLASS SLEEPING CARS IN NORWAY.—Norway follows the example of Sweden in ordering some third-class sleeping cars. They have three berths to a section, each 24 in. wide, and there are 12 sections to a car. These cars will weigh 76,000 lbs.

ENGINE AND TENDER COUPLER

A form of connection between locomotive and tender, which permits the use of a spring or friction draft gear on the front end of the tender, has been developed on the Santa Fe. This connector includes an operating gear and can be connected and disconnected in the same way as an automatic car coupler. It has been in experimental use on a large Mallet locomotive for over two years, and during this time has not developed any faults of consequence. On one occasion the locomotive was derailed by a split switch, but even under this condition the coupler did not separate. It has been found of great convenience

atically held unlocked in the same manner as the pin of a car coupler. This permits the tails of the knuckles to swing inward.

The inner faces of the knuckles where they connect to the drawhead on the tender are arranged at such an angle that most of the stress in pulling comes on the pins on which the knuckles swing and comparatively little pressure must be resisted by the locking block at the rear. This angle, however, is not so great but that the pull on the knuckle will tend to force the tail portions together when the locking block is raised. One of the knuckles has a slotted section at the rear of proper size to admit the tail of the other, so that the faces of the two knuckles will separate sufficiently to allow the tender drawbar head to disengage.

Starting with the uncoupled position when the locking block is held in its raised position by the lugs, as is shown by the dotted line in the illustration, and the knuckles are open at the face to allow the drawbar on the tender to pass between them; the operation is as follows: The special shaped drawhead on the tender, after passing between the knuckles, will strike the inwardly extending portions of the tail and tend to force them apart. This action continues until the tails are sufficiently far apart to allow the locking block to enter between them. Just before they reach this position the beveled face of an extension on the block is engaged and it is released from its disengaged position at the top and drops between the tails of the knuckles. The faces of the knuckles are then locked behind the lugs on the tender drawhead and the apparatus is securely connected. The locking block is of considerable weight and any jarring of the locomotive will only tend to hold it more firmly in position. When uncoupling, the locking block is lifted by the uncoupling gear and when fully raised tilts forward and locks itself in that position. The pull on the tender drawbar then forces the tails

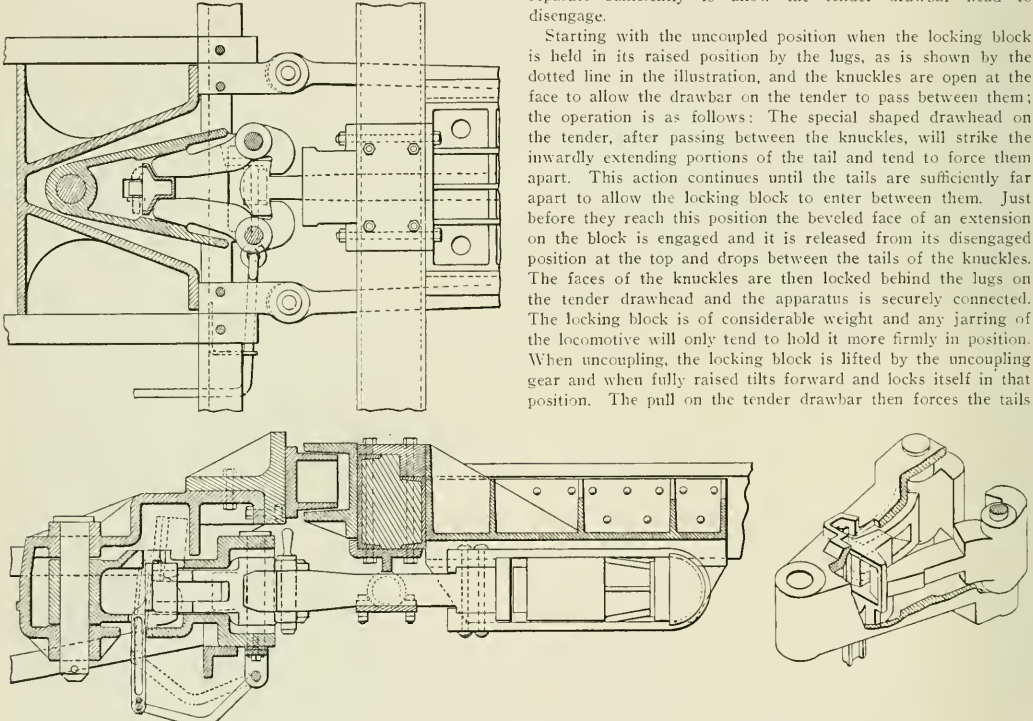

Automatic Connector Between Engine and Tender; Atchison, Topeka & Santa Fe.

at the engine house to be able to connect and disconnect the tender from the locomotive easily and quickly. The use of a suitable draft gear at the front end improves the riding qualities of the locomotive to some extent, and probably has a favorable influence in preventing any tendency toward derailment of the tender trucks.

This arrangement, which has been perfected by M. J. Drury, shop superintendent, and G. W. Wright, consists of a special drawhead on the locomotive of the form and arrangement shown in the illustration. This drawhead can either be included in the deck casting or may be applied to a locomotive arranged for the ordinary type of drawbar. A pair of special shaped knuckles with long tails are hinged on each side of the outer end of this drawhead. Between the tails of the knuckles is a locking block which is allowed a vertical movement and passes through an opening in the top of the drawhead when in the uncoupled position. This block is connected to the operating gear through an extension on the bottom and suitable lugs are arranged so that when it is lifted to the full height it is auto-

of the knuckles together until the faces are disengaged and the coupler is separated.

LARGE HANNA TYPE RIVETER.—A yoke riveter with a gap of 168 in. in depth and 12 in. in width, which will exert a pressure of 100 tons on the rivet with 100 lbs. air pressure in the air cylinders, has recently been installed by the General Electric Company at its Pittsfield, Mass., shops. It was built by the Hanna Engineering Works and has an air cylinder 18 in. in diameter with a 22 in. stroke. It operates by means of a combination toggle and leverage action which is followed by a plain leverage action. The plunger and upper die of the machine has a movement of 5 3/4 in.; 4 3/4 in. of this distance is traversed during the first 11 in. of the stroke of the air cylinder, while the remainder of the stroke gives but 1 in. movement of the plunger. This last 1 in. is given at a uniform travel and pressure, and it is stated that this gives the machine all the advantages of a hydraulic riveter without the disadvantages of the very high hydraulic pressure and the necessity of a return line.

NEWS DEPARTMENT

At a "Safety rally" of employees of the Buffalo, Rochester & Pittsburgh, held at DuBois, Pa., on April 12, three thousand persons were present.

President B. L. Winchell, of the Frisco lines, traveled 55,394 miles in 1912, and 59,173 miles in 1911. During 1912 he attended seventy-five meetings, which included banquets and conferences.

The United States Civil Service Commission announces competitive examinations, to be held May 21 and 22, 1913, for the positions of structural steel draftsman, copyist marine engine and boiler draftsman and assistant engineer in forest products.

The safety department of the Chicago, Burlington & Quincy, of which E. M. Switzer is the superintendent, has had a car fitted up especially for use in the "safety first" campaign. It is arranged similar to a small theater, having seats for 70 persons, and a platform with a large screen on which moving picture views will be shown during lectures to be given by Mr. Switzer. Lectures will be given from this car at prominent points on all parts of the Burlington system, the purpose being to have the car go to the men, instead of requiring the men to go to a hall to attend the lectures.

Sixty-nine apprentices were graduated between January 1 and December 31, 1912, from eight shops on the New York Central Lines West of Buffalo at which apprentice schools are maintained. These shops include Beech Grove and Bellefontaine on the Big Four; Collinwood and Elkhart on the Lake Shore & Michigan Southern; Gibson on the Chicago, Indiana & Southern; Jackson and St. Thomas on the Michigan Central, and McKees Rocks on the Pittsburgh & Lake Erie. The trades represented were as follows: Machinists, 53; boiler makers, 4; blacksmiths, 3; tanners, coppermiths and pipe fitters, 4; pattern makers, 2; painters, 1; electricians, 1; car builders, 1. Of the sixty-nine, 62, or 90 per cent., remained a service for at least 60 days after graduation, and 57, or 83 per cent., are still in service. Apprentice schools have recently been established at Bucyrus on the Big Four and Kankakee on the C. I. & S. There are now 466 apprentices in shops on the New York Central Lines West of Buffalo which maintain apprentice schools, as compared with 380 one year ago.

THE LATEST THING IN SIGNS

The Chicago & North Western has installed a novel electric advertising sign over the river front in Chicago, facing the Rush street bridge. The sign measures 50 ft. square, and shows a large passenger locomotive and part of a train. In front of the locomotive is a semaphore signal which automatically changes from the stop position to the clear position. When the change has been made the driving wheels of the locomotive are seen to revolve and a small ribbon of smoke is emitted from the stack. When the signal goes back to the stop position the wheels slow down and stop. Surmounting the sign is a large trade mark of the company in colors, and underneath the train are a few lines of advertising of its service. The sign stands on the roof of one of the company's freight houses, and is so located that it is seen by thousands of people. The sign contains 3,800 tungsten lamps, 29,500 lbs. of steel and 30,000 ft. of wire. Its total weight is 18 1/2 tons.

SPEED RECORDERS ON THE BALTIMORE & OHIO

The through passenger trains of the Baltimore & Ohio are now equipped with speed recorders, two to a train; one in the baggage car and one in the locomotive. In the baggage car

the "Haushalter" speed tape is used, while on the locomotives the Boyer speed recorder is used. Both of these machines make records on tapes. At the end of each trip the tape is taken out by the local inspector, who makes a suitable record of the date, time, etc., and sends the whole to the office of the general inspector of transportation, where a permanent record is kept. The information given on the tapes is checked against the rates of speed prescribed in the rules limiting speed at different points on the road, so that excessive speed is at once brought to notice. The maximum speed of passenger trains on the Baltimore & Ohio, except between Philadelphia and Washington, is 60 miles an hour, and the officers require a rigid observance of the limit. On the Philadelphia-Washington line the limit is 65 miles an hour.

PENNSYLVANIA PENSIONS

The Pennsylvania Railroad has now paid pensions 13 years, and a total of 7,152 men have received payments, through the funds, of \$8,368,786, all out of the earnings of the various companies in the system. Of this amount \$6,319,902 has been paid on the lines east of Pittsburgh, and \$2,048,884 west of Pittsburgh. At the present time there are 3,807 men on the pension rolls. The names, occupations, and divisions where last employed of those over ninety years of age were as follows:

Name.	Occupation.	Division.
Michael Eckerline.....	Laborer.....	Altoona shops.
James Kaylor.....	Blacksmith.....	Altoona shops.
Elias Griffith.....	Watchman.....	Altoona shops.
James L. Shields.....	Foreman mason.....	Conemaugh.
David L. Graef.....	Machinist.....	Philadelphia.
Thomas C. Payne.....	Laborer.....	Trenton.
Charles Lupton.....	Car builder.....	Philadelphia Terminal.
James Gray.....	Agent.....	Elmira.
Chas. A. Jeteries, Sr.....	Signal repairman.....	Philadelphia.

The pension amounts to 1 per cent. of the average salary or wage for the ten years previous to retirement, multiplied by the number of years the man has been in the employ of the company. Employees retire without any obligation whatever to the Pennsylvania Railroad, and many of them engage in outside occupations. This pension plan, inaugurated by Mr. Cassatt in 1899 with much doubt as to its eventual success, is now declared by the officers of the company to have proved to be of immense benefit to a large number of men, and to have contributed enormously to the contentment of the men in the service of the road.

FIREMEN'S ARBITRATION AWARD

The award of the arbitrators between the eastern railroads and their firemen was filed April 23, 1913, and in accordance with the provisions of the Erdman act, will take effect ten days later. The following are the terms of the award:

Article 1: Ten hours or less, or one hundred miles or less, shall constitute a day's work in all classes of service, except as otherwise specified. The time for which firemen will be paid shall begin at the time he is required to report for duty, and end when the engine is delivered at the point designated.

Article 2: The following rates of wages per day shall be the minimum rates paid in all classes of service on all railroads, parties to this arbitration:

(a) PASSENGER SERVICE.	
Weights of Locomotives	
in pounds on Drivers.	
Less than 80,000 lbs.....	\$2.45
80,000 to 100,000 lbs.....	2.50
100,000 to 140,000 lbs.....	2.60
140,000 to 170,000 lbs.....	2.70
170,000 to 200,000 lbs.....	2.85
200,000 to 250,000 lbs.....	3.00
250,000 to 300,000 lbs.....	3.20
300,000 to 350,000 lbs.....	3.40
All engines over 350,000 lbs. on drivers.....	3.60
Mallet engines regardless of weight on drivers.....	4.00

FREIGHT SERVICE.

Less than 80,000 lbs.	\$2.75
80,000 to 100,000 lbs.	2.85
100,000 to 140,000 lbs.	3.00
140,000 to 170,000 lbs.	3.10
170,000 to 200,000 lbs.	3.20
200,000 to 250,000 lbs.	3.30
250,000 to 300,000 lbs.	3.55
All engines over 300,000 lbs. on drivers.	4.00
Mallet engines regardless of weight on drivers.	4.00

Where two firemen are employed on a locomotive as a result of the application of Article 6 hereinafter, the rates of pay to each fireman shall be as follows: Weight on drivers, 100,000 up to 250,000 lbs.\$2.75
Weight on drivers, over 250,000 lbs. 3.00

(b) SWITCHING SERVICE.

Switch engine firemen on locomotives weighing less than 140,000 lbs. on drivers, per day of ten hours or less.	\$2.50
Switch engine firemen on engines weighing 140,000 lbs. or over on drivers, per day of ten hours or less (excluding Mallets \$4.00)	2.60

(c) HOSTLERS.

Hostlers, per day of ten hours or less.	\$2.40
If hostlers are employed in handling engines between passenger stations and roundhouses or yards, or on main tracks, they will be paid, per day of ten hours or less.	3.25
If men are employed to assist hostlers in handling engines between passenger stations and roundhouses or yards, or on main tracks, they will be paid, per day of ten hours or less.	2.50

(d) HELPER ON ELECTRIC LOCOMOTIVE.

The term "helper" will be understood to mean the second man employed on electric locomotives, and he shall receive in passenger service, per day of ten hours, or less, one hundred miles or less.	\$2.50
In through freight per day of ten hours or less, one hundred miles or less.	2.50
In switching service, per day of ten hours or less.	2.80

All working conditions applicable to steam locomotive firemen in steam service will apply to helpers in electric service.

(e) Firemen on locomotives in pusher and helper service, mine runs, work, wreck, belt line and transfer service, and all other unclassified service will be paid through freight rates according to the class of engine.

(f) Firemen in local freight service will be paid fifteen cents in addition to through freight rates according to class of engine.

(g) For the purpose of officially classifying the locomotive, each railroad, party to this arbitration, will keep bulletins posted at all terminals showing accurately the weight on drivers of all engines in its service.

Article 3: (a) Overtime in all classes of service, except passenger, will be paid for pro rata on the minute basis. Except as otherwise specified ten hours, or one hundred miles will be the basis for computing overtime. Miles and hours will not be counted together; when miles exceed hours, miles will be allowed, and when hours exceed miles, hours will be allowed.

(b) Overtime in passenger service (except suburban service) will be paid at the rate of thirty cents per hour on the basis of twenty miles an hour, computed on the minute basis. Five hours or one hundred miles or less, to constitute a day's work.

(c) On short turn around runs, no single one of which exceeds eighty miles, including suburban service, overtime shall be paid for all time actually on duty, or held for duty, in excess of eight hours (computed on each run from the time required to report for duty to end of that run) within twelve consecutive hours; and also for all time in excess of twelve consecutive hours, computed continuously from the time first required to report to the final release at the end of the last run. Time shall be counted as continuous service in all cases where the interval of release from duty at any point does not exceed one hour.

Article 4: No initial terminal delay is allowed beyond that involved in the rule that pay shall begin in all cases at the time fireman is required to report for duty, but final terminal delay after the lapse of one hour will be paid for at the end of the trip, at the overtime rate, according to the class of engine, on the minute basis. For freight service final terminal delay shall be computed from the time the engine reaches the designated main track switch connecting with the yard track. For passenger service final terminal delay shall be computed from the time the train reaches the terminal station. If road overtime has commenced terminal overtime shall not apply, and road overtime shall be computed to the point of final release.

Article 5: Firemen in pool freight and in unassigned service held at other than home terminal, will be paid continuous time for all time so held after the expiration of eighteen hours from time relieved from previous duty, at the rate per hour paid him for the last service performed. If held fourteen hours after the expiration of the first twenty-eight hour period, he will be paid continuous time for the next succeeding ten hours, or until the end of the twenty-four hour period, and similarly for each twenty-four hour period thereafter. Should a fireman be called for duty after pay begins, his time will be computed continuously.

Article 6: When a second fireman is deemed necessary on any engine or assistance is deemed necessary on any engine where one fireman is employed, the matter will be taken up with the proper officials by the Firemen's Committee. Failing to reach a settlement the matter shall be referred to an Adjustment Commission, to be composed of five persons, two of whom are to be chosen by the railroad, two by the Firemen's Committee, and one to be selected by the four thus chosen, who shall be the chairman of the commission. Should the four men fail to agree upon the fifth, then three days after the last of the four is selected, the fifth man shall be named by the presiding judge of the United States Commerce Court. If, for any reason, the selection of the fifth man cannot be made by the presiding judge of said court, he shall be named by the United States district judge of the district in which the controversy may have arisen. All expenses incurred in connection with the settlement of such matters shall be borne equally by the two parties to the controversy.

Article 7: Firemen will be relieved of cleaning engines. Lubricators will be filled, headlights, markers and other lamps cared for (including filling but not lighting), and all supplies placed on engines at points where roundhouse or shop force are maintained. The firemen shall not be relieved of responsibility of knowing that engines for which they are called are properly equipped for service.

Article 8: Firemen tied up between terminals on account of the hours of service law, will be paid continuous time from initial point to tie-up point. When they resume duty on a continuous trip they will be paid from tie-up point to terminal on the following basis: For fifty miles or less, or five hours or less, fifty miles pay; for more than fifty miles up to one hundred miles, or over five hours, and up to ten hours, one hundred miles pay; over one hundred miles, or over ten hours, at schedule rates. This provision does not permit the running of firemen through terminal or around other firemen at terminals, unless such practice is permitted under the pay schedule.

Article 9: The earnings of firemen in any class of service shall not be diminished by the provisions of this award; and if the rates that were higher or the conditions that were better antecedent to this award are necessary to guarantee this requirement they shall be maintained. Neither shall the earnings of the firemen, in any class of service, be increased above what the higher rates of pay and the conditions that were better antecedent hereto guaranteed him, by a combination of the rates herein established with the conditions of service antecedent hereto, or vice versa.

It is not intended that any of the terms or provisions of this award shall debar committees from taking up for adjustment with the management of the respective railroads any questions or matters not specifically covered herein.

Article 10: This award shall take effect at the time and in the manner provided by the act of congress entitled "An Act Concerning Carriers Engaged in Interstate Commerce and Their Employees, Approved June 1, 1898." All parties to this arbitration having stipulated in writing, and incorporated in the record an agreement, extending the time within which the award may be made and filed, from the second day of April, 1913, to and including the twenty-third day of April, 1913, the arbitrators now, on this twenty-third day of April, 1913, signed this award without dissent in any particular to any of its provisions by any one of them, and have required the secretary to attest the same.

MEETINGS AND CONVENTIONS

Western Canada Railway Club.—H. D. Cameron, chief draftsman, mechanical department, Canadian Northern, presented a paper on the hauling capacity of locomotives at the March meeting. He discussed the resistances that enter in the operation of locomotives and cars, and recommended certain reductions in tonnage rating for low temperatures. It was pointed out that most economical trainloading is something that must be finally determined by experiments with a dynamometer car.

Master Car and Locomotive Painters' Association.—The forty-fourth annual convention will be held at the Chateau Laurier, Ottawa, Canada, September 9 to 12. Papers will be presented on the following subjects: Railway Paint Shop Supplies; Finishing Steel Car Equipment; Safety First as Regards the Paint Shop; Economy in Locomotive Painting; Paint Protection for Steel Freight Equipment; Silvering Mirrors; Removing Old Paint from Equipment, and Brushes. A. P. Dane, Reading, Mass., is the secretary.

New England Railroad Club.—The thirtieth annual meeting was held on March 11, 1913. The election of officers resulted as follows: President, C. B. Smith, mechanical engineer, Boston & Maine; vice-president, H. E. Astley, roadmaster, New York, New Haven & Hartford; treasurer, C. W. Sherburne, Boston; finance committee, C. B. Smith, B. M. Jones, F. A. Barbey. The new executive committee includes the officers and C. B. Breed, J. P. Snow, W. J. Cunningham, G. W. Wildin, E. W. Holst, F. O. Wellington, W. C. Kendall, P. M. Hammett and J. B. Hammill. The report of the secretary showed that the club has a membership of 578. The treasurer's report indicated a balance of \$2,-844.22 on hand.

Air Brake Association.—The annual convention will be held at the Planters Hotel, St. Louis, Mo., May 6-9. The subjects to be discussed and the committees selected are as follows: Will the Triple Valve Operate as Intended? That Depends, S. W. Dudley; Starting, Running and Stopping Long Freight Trains, F. B. Farmer; Undesired Quick Action, Its Prevention and Remedy, C. N. Remfry; Clasp Type of Foundation Brake Gear, T. L. Burton; Friction and Wear of Brake Shoes, Robert C. Angur; Recommended Practice, S. G. Down, chairman, Geo. R. Parker, H. A. Wahlert, J. R. Alexander, N. A. Campbell; Topical Subject, Air Hose Failures, T. W. Dow; Topical Subject, Steam Heat Drips, C. W. Martin.

Railway Fuel Association.—The following subjects will be discussed at the annual meeting, which will be held at the Hotel Sherman, Chicago, Ill., May 21-24:

Standard Form of Contract Covering the Purchase of Railway Fuel Coal.

Location, Construction, Development and Operation of a Bituminous Coal Mine.

Sub-Bituminous and Lignite Coal as a Locomotive Fuel.

Self-Propelled Railway Passenger Cars.

Scaling of Locomotive Boilers and Resultant Fuel Loss.

Modern Locomotive Coaling Station—Its Design, Construction, Operation and Maintenance.

The tentative plans for entertainment include a theater party on Wednesday evening, May 21; moving pictures of interior of mine works Thursday evening, May 22, and an automobile trip Friday afternoon, May 23.

Railway Storekeepers' Association.—The tenth annual convention of this association will be held at the Hotel Sherman, Chicago, Ill., May 19-21, 1913. The following regular subjects will be discussed:

Reducing Inactive and Disposing of Obsolete Stock.

Rolling Mills at Railroad Scrap Docks. Economy Effected.

Couplers and Parts, M. C. B. Marking by Manufacturers for Identification.

What Effect, if Any, Has a Well-Organized Store Department on the Operating Cost of a Railroad?

The topical subjects which will be brought up for discussion are as follows: Store House; Store-House Casting Platforms; Oil House and Waste Storage; Dry Lumber Shed; Stationary Store House; Supply Car; Scrap Dock and Reclaiming Machinery; Specifications for and Testing of Material, and Effect on Storekeepers' Stock; Ice—Proper Method of Storage; Disbursement, Shrinkage and General Handling on Railroads, and Standard Book of Rules Governing Store Department Practices.

Master Boiler Makers' Association.—The following subjects will be discussed at the annual convention, to be held at the Hotel Sherman, Chicago, Ill., May 26-29, 1913:

How many rows of expansion stays is it advisable to apply to the crown sheet to secure the most efficient service, considering the wear and tear of the boiler?

Is there any limit to the length of a tube in a boiler without a support midway of the boiler, and will a support prove objectionable in circulation?

When is a boiler in a weak and unsafe condition?

Best method of welding superheating tubes, and the tools used.

What effects do superheaters have on the life of fireboxes and flues?

What are the advantages or disadvantages of using oxy-acetylene and electric processes for boiler maintenance and repairs?

The proper inspection of a boiler while in service.

Best form of grate to be used to insure removing of fire at terminals with the least abuse to the firebox and flues, insuring the most economy as well as high efficiency in service.

The best method of applying and caring for flues while engines are on the road and at terminals.

Steel vs. iron tubes. What advantages and what success in welding them and advantages of either in maintenance, mileage, etc.

What benefit has been derived from treating feed water for locomotive boilers, chemically or otherwise?

The following list gives names of secretaries, dates of next or regular meetings, and places of meeting of mechanical associations.

AIR BRAKE ASSOCIATION.—F. M. Nellis, 53 State St., Boston, Mass. Convention, May 6-10, 1913, St. Louis, Mo.

AMERICAN RAILWAY MASTER MECHANICS' ASSOC.—J. W. Taylor, Old Colony building, Chicago. Convention, June 11-13, 1913, Atlantic City, N. J.

AMERICAN RAILWAY TOOL FOREMEN'S ASSOCIATION.—A. R. Davis, Central of Georgia, Macon, Ga. Convention, July 22-24, 1913, Chicago, Ill.

AMERICAN SOCIETY FOR TESTING MATERIALS.—Prof. E. Marburg, University of Pennsylvania, Philadelphia, Pa. Annual convention, June, 1913.

AMERICAN SOCIETY OF MECHANICAL ENGINEERS.—Calvin W. Rice, 29 W. Thirty-ninth St., New York. Annual meeting, December 3-6, Engineering Societies' Building, New York. Railroad session, Thursday morning, December 5.

CAR FOREMEN'S ASSOCIATION OF CHICAGO.—Aaron Kline, 841 North Fifthth Court, Chicago; 2d Monday in month, Chicago.

INTERNATIONAL RAILWAY FUEL ASSOCIATION.—C. G. Hall, 922 McCormick building, Chicago. Convention, May 21-24, 1913, Chicago.

INTERNATIONAL RAILWAY GENERAL FOREMEN'S ASSOCIATION.—William Hall, 829 W. Broadway, Winona, Minn. Convention, July 15-18, 1913, Chicago, Ill.

INTERNATIONAL RAILROAD MASTER BLACKSMITHS' ASSOCIATION.—A. L. Woodworth, Lima, Ohio. Convention, August 18, 1913, Richmond, Va.

MASTER BOILER MAKERS' ASSOCIATION.—Harry D. Vought, 95 Liberty St., New York. Convention, May 26-29, 1913, Chicago.

MASTER CAR BUILDERS' ASSOCIATION.—J. W. Taylor, Old Colony building, Chicago. Convention, June 16-18, 1913, Atlantic City, N. J.

MASTER CAR AND LOCOMOTIVE PAINTERS' ASSOC. OF U. S. AND CANADA.—A. P. Dane, B. & M., Reading, Mass. Convention, Sept. 9-12, 1913, Ottawa, Can.

RAILWAY STOREKEEPERS' ASSOCIATION.—J. P. Murphy, Box C, Collinwood, Ohio. Convention, May 19-21, 1913, Auditorium Hotel, Chicago, Ill.

TRAVELING ENGINEERS' ASSOCIATION.—W. O. Thompson, N. Y. C. & H. R., East Buffalo, N. Y. Convention, August, 1913, Chicago, Ill.

PERSONALS

It is our desire to make these columns cover as completely as possible all the changes that take place in the mechanical departments of the railways of this country, and we shall greatly appreciate any assistance that our readers may give us in helping to bring this about.

GENERAL

The headquarters of W. L. Kellogg, superintendent of motive power of the Missouri, Kansas & Texas, have been transferred from Parsons, Kan., to Denison, Tex.

MAX FIEDLER, general foreman of the Globe shops of the Arizona Eastern, has been appointed assistant superintendent of the Globe division of that road.

JOHN E. GARDNER has been appointed electrical engineer of the Chicago, Burlington & Quincy, with headquarters at Chicago.

FRED HOOKER has been appointed superintendent of locomotive fuel service of the St. Louis, Brownsville & Mexico, with headquarters at Kingsville, Tex.

B. G. HORTON has been appointed superintendent of locomotive fuel service of the New Orleans, Texas & Mexico, with headquarters at DeQuincy, La.

EDWARD A. PARK has been appointed superintendent of motive power and equipment of the Peoria & Pekin Union, with headquarters at Peoria, Ill., and the position of master mechanic, held by J. W. Hill, has been abolished.

C. A. SELEY has resigned as mechanical engineer of the Rock Island Lines, effective May 1, to engage in a manufacturing business, the details of which will be announced later. This

closes a career of 25 years of active railroad service. Mr. Seley was born December 26, 1856, at Wapella, Ill., and began railway work in 1879 as a draftsman for the St. Paul, Minneapolis & Manitoba. From 1881 to December, 1886, he was engaged in other work of a mechanical engineering nature, and then until January, 1888, was chief draftsman for the St. Paul & Duluth. The following four years he was with the Great Northern, and in May, 1892, he entered the railway supply business, returning to active railway service in March, 1895,



C. A. Seley.

as chief draftsman for the Chicago Great Western. He left the latter road in April, 1899, to become mechanical engineer of the Norfolk & Western, which position he held until May, 1902, when he was appointed mechanical engineer of the Rock Island Lines, with headquarters at Chicago. Mr. Seley has been an active member of various railway associations in committee work, and has served as a member of the executive committee of both the Master Car Builders' and Master Mechanics' Associations for many years. For three years prior to January 1 last he was a member of the sub-committee of mechanical officers of the Special Committee on Relations of Railway Operation to Legislation, which conducted the negotiations between the railways and the Interstate Commerce Commission and the post-office department on safety appliances, boiler inspection rules and steel postal car specifications. He acted as chairman of this

sub-committee most of the time. Mr. Seley was president of the Western Railway Club in 1907 and 1908, and has been chairman of various committees. He is also author of many papers on railway electrification and on car, locomotive and boiler design. His varied experience has built up for him a very large acquaintanceship with railway mechanical officers and railway supply men throughout the country.

J. W. SMALL, formerly assistant general manager (mechanical) of the Sunset-Central lines of the Southern Pacific, has been appointed superintendent of motive power of the Seaboard Air Line, with office at Portsmouth, Va., succeeding A. J. Poole, resigned.

O. TEFTELLER has been appointed superintendent of locomotive fuel service of the St. Louis, Brownsville & Mexico, with headquarters at Kingsville, Tex.

T. F. UNDERWOOD, whose appointment as master mechanic of the St. Louis & San Francisco, at Paris, Tex., was announced in the April issue of the *American Engineer*, was born at DeKalb, Mo., in 1859,



T. F. Underwood.

and was educated in the public schools at Atchison, Kan. He commenced railroad work when 15 years old as a waterboy on the Atchison & Nebraska Railroad, now a part of the Burlington system. In April, 1876, he entered the Central Branch shops of the Union Pacific as a machinist apprentice, remaining there for 4 years, when he was transferred as a machinist to Atchison, Kan. Later he served as a machinist for the Atchison, Topeka & Santa Fe at Raton, N. Mex., and for the Chicago & Alton,

at Bloomington, Ill., remaining in the latter position for two years, when he was appointed roundhouse foreman at Bowling Green, Mo. In May, 1888, he was appointed division foreman of the Atchison, Topeka & Santa Fe, at Atchison, Kan., and in February, 1893, was transferred to Emporia, Kan., as general foreman for the same company, in charge of locomotive and car work. In April, 1898, he was appointed division master mechanic of the same road at Winslow, Ariz., remaining there for one year, when he entered the service of the Kansas City, Fort Scott & Memphis as general foreman at Fort Scott, Kan. He was later transferred to Springfield, Mo., as general roundhouse foreman, remaining there until March, 1911, when he was appointed general foreman at Monett, Mo., in charge of locomotive and car department, the position which he held at the time of his recent appointment.

MASTER MECHANICS AND ROAD FOREMEN OF ENGINES

O. C. BREISCH has been appointed master mechanic of the Kansas City Terminal division of the Rock Island Lines at Armourdale, Kans.

J. R. GREINER, general foreman of the Cincinnati, Hamilton & Dayton, at Lima, Ohio, has been appointed master mechanic of the San Pedro, Los Angeles & Salt Lake, with headquarters at Milford, Utah, succeeding T. M. Vickers, resigned.

FRANK HOPPER, division master mechanic of the Chicago, Rock Island & Pacific at Estherville, Iowa, has been appointed master

mechanic of the Duluth, Winnipeg & Pacific, with headquarters at West Duluth, Minn.

F. A. HUSSEY has been appointed road foreman of engines of the Boston division of the Boston & Albany, with office at Beacon Park.

J. E. INGLING has been appointed road foreman of engines of the Erie at Jersey City, N. J.

J. LANG has been appointed road foreman of engines of the Buffalo division of the Erie.

M. E. MACKERLY has been appointed road foreman of engines of the Erie at Jersey City, N. J., succeeding J. A. Cooper, transferred.

MATTHEW F. REAGAN has been appointed road foreman of engines, on the Hudson division of the New York Central & Hudson River, with headquarters at West Albany, N. Y., succeeding W. P. Davis, promoted.

L. J. McDONALD has been appointed road foreman of equipment of sub-divisions 30, 30-A and 31 of the Rock Island Lines, at Eldon, Iowa.

T. R. McLEOD has been appointed master mechanic of the Canadian Northern Ontario, with office at Toronto, Ont., succeeding C. L. Webster, resigned.

CAR DEPARTMENT

SAMUEL LENZNER has been appointed master car builder of the Michigan Central, with headquarters at Detroit, Mich., succeeding D. C. Ross, resigned. Mr. Lenzner was born June 30, 1861, at Lancaster, N. Y., and has been with the Michigan Central since July 12, 1886, when he began railway work as a coach carpenter. In September, 1889, he was made foreman of the cabinet department, and in March, 1909, was advanced to general foreman of the car department, which position he held until his recent promotion.

JOHN OTTO has been appointed general foreman, car department of the Michigan Central at West Detroit, Mich., succeeding Samuel Lenzner, promoted.

D. C. ROSS, master car builder of the Michigan Central at West Detroit, Mich., has resigned.

SHOP AND ENGINE HOUSE

H. G. DORR has been appointed roundhouse foreman of the Rock Island Lines at Brooklyn, Iowa.

J. F. FITZSIMMONS has been appointed foreman boiler maker of the Erie at Hornell, N. Y., succeeding Jas. McNeil.

J. I. HALLER has been appointed fitting shop foreman of the Erie at Susquehanna, Pa., succeeding James Burrell, transferred.

FLOYD S. HARTWELL has been appointed night roundhouse foreman of the Rock Island Lines at Biddle, Ark.

J. H. MUSGROVE has been appointed roundhouse foreman of the Pittsburgh & Lake Erie at College, Pa.

J. M. RAY has been appointed machine foreman of the Atchison, Topeka & Santa Fe, at Amarillo, Tex.

F. J. STULL has been appointed assistant foreman boiler maker of the Erie at Hornell, N. Y., succeeding Robert McKenzie.

D. J. SULLIVAN has been appointed machine shop foreman of the Erie at Susquehanna, Pa., succeeding L. C. Emery, transferred.

C. W. WARcup has been appointed assistant roundhouse foreman of the Rock Island Lines at Forty-seventh street, Chicago.

J. E. WHITEFORD has been appointed day roundhouse foreman of the Rock Island Lines at Cedar Rapids, Ia., succeeding W. H. Wenke, resigned.

NEW SHOPS

ATCHISON, TOPEKA & SANTA FE.—This company is planning to begin work shortly on a 12-stall roundhouse and shops at Wichita, Kan.

CANADIAN NORTHERN.—This company will enlarge its shops and increase its yard capacity at Pembina, N. D.

CHICAGO & ALTON.—A contract has been let to George B. Swift & Company for a 30-stall roundhouse, a coal tipple and ash pit at Glenn Yards, Chicago.

CHICAGO & NORTH WESTERN.—This company will build a new 40-stall engine house, brick power house, store and oil houses, mechanical coal chute, water tank, ice house, and other buildings in connection with track changes and other improvements at Green Bay, Wis., to cost approximately \$350,000 in all.

CHICAGO, ST. PAUL, MINNEAPOLIS & OMAHA.—This company has begun work on a new 32-stall roundhouse, machine shops and other improvements at Altoona, Wis.

CINCINNATI, NEW ORLEANS & TEXAS PACIFIC.—Important improvements in the Ferguson shops near Somerset, Ky., are contemplated. The work includes an extension to the shop building, additional storehouse and repair track capacity, and the installation of a number of modern appliances.

DELAWARE & HUDSON.—Land has been purchased adjoining the shops of this company at Oneonta, N. Y., and several new buildings, including a coach shop, will be erected.

GALVESTON, HARRISBURG & SAN ANTONIO.—Repair shops and an 18-stall concrete engine house are to be erected at Del Rio, Tex.

LAKE SHORE & MICHIGAN SOUTHERN.—This company will build two roundhouses and a power plant at its Air Line Junction yards.

LOUISVILLE & NASHVILLE.—According to press reports the Louisville & Nashville is making plans for putting up a roundhouse, shops, etc., at Lexington, Ky.

NATIONAL TRANSCONTINENTAL.—A 12-stall engine house, without machine shop, will be constructed at O'Brien, Que.

PITTSBURGH & LAKE ERIE.—A contract has been let, it is said, for building a roundhouse, a shop structure, a storeroom and a power house at Dickerson Run, Pa.

SPOKANE, PORTLAND & SEATTLE.—This company has announced plans for the expenditure of \$200,000 for roundhouses, car shops and storage tracks.

SPOKANE, PORTLAND & SEATTLE.—This company plans to erect a large engine house and shops at Overlook, Wash.

TENAS & NEW ORLEANS.—Work has been begun on new machine shop buildings and other improvements at Beaumont, Tex., to cost about \$40,000.

FREIGHT CARS IN PRUSSIA.—The average capacity of all Prussian freight cars in 1910 was 15.7 tons. Practically all of them have but two axles. Only one-third are fitted with brakes of any kind and only a very few of these with air brakes. Automatic couplers have not been adopted, although used experimentally. The standard box car of Prussia is 26 ft. long and has a capacity of 16.6 tons. Coal cars run in capacity from 22 to 40 tons, but those of the higher capacity are relatively few. The dead weight of the standard box car is 10.7 tons, or 65 per cent. of its capacity.—*Wm. J. Cunningham before the New York Railroad Club.*

SUPPLY TRADE NOTES

The Gould Coupler Co. has moved its New York office from 347 Fifth avenue to 30 East Forty-second street.

The Grip Nut Company is moving its Chicago office from the Old Colony building to 661-663 McCormick building.

The Watson-Stillman Company, New York, has moved its Chicago office from the Rookery to the McCormick building.

The Yale & Towne Manufacturing Company, New York, has moved its general offices from 9 Murray street, to 9 East Fortieth street, New York.

The Horace L. Winslow Company, contractors and heating experts, has moved into new and larger offices at 990 Old Colony building, Chicago.

Henry Jungerman, formerly in the motive power and inspection department of the Harriman Lines, has been made railway representative of Tate-Jones & Company, Inc., Pittsburgh, Pa.

H. Martin Gower, formerly in charge of the apprentice work on the Canadian Pacific, has accepted a position in charge of the railway department of the A. R. Williams Machinery Company, of Winnipeg, Ltd., with headquarters at Winnipeg, Man.

Andrew Thompson, general manager of the Titanium Alloy Manufacturing Company, Niagara Falls, N. Y., will hereafter have charge of the sales of that company. A. C. Hawley has been made representative of the company for the Pittsburgh district, with office in Pittsburgh, Pa.

A. E. Rosenthal has resigned his position as western representative of the Lima Locomotive Corporation, Lima, Ohio, and the Chicago office of that concern has been temporarily discontinued. Mr. Rosenthal retains his position as president of the National Railway Equipment Company, Chicago.

Davis-Bournonville Company, manufacturers of oxy-acetylene welding and cutting apparatus, West Street building, New York, has removed its New York office to the Hudson Terminal building, 30 Church street. The Chicago sales office of the company has been moved from 515 Laflin street to rooms 202-206 Monadnock block.

At a meeting of the board of directors of the United States Light and Heating Company, held Thursday, April 17, Charles A. Starbuck was elected chairman of the board of directors, J. Allan Smith was elected president, Frank P. Frazier and William P. Hawley were elected vice-presidents, and A. H. Ackermann was elected general manager.

Charles Robbins, manager of the industrial and power department of the Westinghouse Electric & Manufacturing Company, East Pittsburgh, Pa., with office in Pittsburgh, has been made assistant sales manager, with office at East Pittsburgh. J. M. Curtin, assistant manager of the industrial and power department, has been made manager of that department, succeeding Mr. Robbins.

Charles A. Lindstrom, chief engineer of the Pressed Steel Car Company, Pittsburgh, Pa., has been made assistant to the president, with headquarters in Pittsburgh; B. D. Lockwood, assistant chief engineer of the same company, has been made chief engineer; J. F. Streib, mechanical engineer of the company, has been made assistant chief engineer, and Felix Koch has been made mechanical engineer.

The Duff Manufacturing Company, Pittsburgh, Pa., has moved into its new plant and general office building on Prehle avenue, Pittsburgh. The old works on Marion avenue have been dismantled. The new factory building has about 68,000 sq. ft. of floor space, and is located on a tract of ground approximately five acres. It has track connections with the Pennsylvania Railroad and the Baltimore & Ohio. This company is also planning

to erect a new plant in the Chicago district, and one at either Windsor or Hamilton, Ont. Both of these plants are expected to be in operation in the fall of 1913.

On account of the rapid development of the business of the Dearborn Chemical Company in Canada, a Canadian company has been recently organized to carry on the business there, and make further extensions. A manufacturing plant is in process of erection at West Toronto, Ontario, with shipping facilities on both the Canadian Pacific and the Grand Trunk railways. The active head of the Canadian enterprise as vice-president and general manager is A. W. Crouch, who has been connected with the Dearborn Chemical Company for fifteen years, having established their Pittsburgh office, and been for the past eight years district manager, in charge of a number of branches. The Canadian company will specialize in the analysis and scientific treatment of boiler feed waters, both for steam railroads and stationary steam plants.

Willard Doud, who on April 1, resigned as shop engineer of the Illinois Central, to engage in special work on industrial engineering projects, terminates a railroad career of eleven years, devoted principally to the design, construction and supervision of railroad shops and power plants. After a course in mechanical engineering at the University of Illinois, Mr. Doud in 1902 entered the employ of the Keneffick Construction Company, Kansas City, who were engaged in railroad construction work in Indian Territory. He remained in this work until 1904, when he entered the mechanical department of the Kansas City Southern, at Pittsburg, Kansas, in the capacity of machinist's helper, later serving as draftsman and chief draftsman with this company. Mr. Doud entered the service of the Chicago, Burlington & Quincy in 1905 as draftsman on general locomotive and car design, and after two years in this work he was appointed shop engineer. While with the Burlington, Mr. Doud had general supervision over the mechanical end of shop improvements, and supervised the electrification of the West Burlington and the old Havelock shops, and had charge of the entire construction work of the new Havelock shops. In February, 1911, he entered the service of the Illinois Central as shop engineer, and during his two years' service with that company directed the work of electrifying Burnside, Waterloo and Memphis shops, the entire mechanical and electrical portion of the Centralia terminal, recently completed, and extensive improvements to the power plant equipment of the various shops. Mr. Doud is located at 15 West Kinzie street, Chicago.

GERMAN LOCOMOTIVES.—In a paper before the New York Railroad Club, W. J. Cunningham states that the Prussian passenger locomotive on through trains is considerably lighter than ours, but there is not as much difference as is generally supposed. In that class of service the Atlantic and 10-wheel type predominate. A large proportion of all locomotives is of the compound type. Germany is the home of the superheater and nearly all engines are equipped with the device, as well as feed water heaters, draft regulators, screw reversing gear, and other appliances which are not common here. The interior of the cab, especially in those equipped also with cab signals, seems somewhat complicated to the American observer. The tank locomotive, which is comparatively light, appears to be the favorite in local passenger service. Freight locomotives vary in size, but most of them are little more than half the size of our freight locomotive. With the small freight cars and light grades of the main lines, the length rather than the weight of the train is the controlling feature, and heavy engines are not needed. In Southern Germany, however, where the grades are heavier, there are many locomotives which in weight and power compare favorably with those of the American consolidation type. In 1910, Prussia had 19,670 locomotives of all kinds. This is an average of 84 locomotives per 100 miles of line.

CATALOGS

FORGING MACHINES.—National Header Talk Number 8, issued by the National Machinery Company, Tiffin, Ohio, deals with the National motor drive, wedge grip header, giving a description and illustrations.

BORING MACHINES.—The Betts Machine Company, Wilmington, Del., has issued a leaflet illustrating an extra heavy, double drive, 8 ft. boring and turning mill built for the new Canadian Pacific shops at Calgary, Alta.

BLACKSMITHING AND DROP FORGING.—This is the title of a 16-page bulletin issued by Tate-Jones & Company, Incorporated, Pittsburgh, Pa. It is the first of a series, and deals with welding, giving a number of illustrations.

AIR COMPRESSORS.—The Ingersoll-Rand Company, New York, has issued a 28-page booklet dealing with their class *PE* direct connected, electrically driven air compressors. This booklet gives instructions for installing and operating, and includes a duplicate part list.

GENERAL ELECTRIC BULLETINS.—Thompson Watt-hour meters is the subject of bulletin No. A-4092 recently issued by the General Electric Company, Schenectady, N. Y. Bulletin No. A-4087 is devoted to a brief description of direct current motor starting panels for heavy service.

SUPERHEATERS.—A 15 page booklet, issued by the Heine Safety Boiler Company, St. Louis, Mo., deals with that company's superheater for stationary use, and includes a reprint, from the *Journal of the Engineers' Society of Pennsylvania*, of a paper on Superheating, by C. R. D. Meier.

STOKERS' TOOLS.—The Economy Stokers' Tool Company, Portland, Maine, has issued a leaflet describing fire hoes, slice bars and pricker bars with detachable heads. The heads may be replaced easily by the fireman while on duty, making it unnecessary to take the tool to a blacksmith.

OIL SWITCHES.—The General Electric Company, Schenectady, N. Y., has issued Bulletin No. A-4113, describing small capacity oil switches, Type F, Forms P-3 and P-6, for induction motors of not over 25 h. p. capacity at 600 volts. This bulletin supersedes the company's previous bulletin on this subject.

ENGINE LATHE.—A quick change gear engine lathe that includes all the improved appliances and attachments that lead to greater convenience or an improvement in production is fully illustrated and described in a leaflet being issued by the Cincinnati Lathe & Tool Company, Oakley, Cincinnati, Ohio.

FEED WATER HEATERS.—In a booklet recently issued by the Hoppes Manufacturing Company, Springfield, Ohio, various types of exhaust steam feed water heaters and purifiers for power plants are illustrated and briefly described. The catalog also shows a number of designs of steam separators.

TURRET HEAD BORING MILL.—The Gisholt Machine Company, Madison, Wis., is sending out a leaflet, to be bound in a loose leaf binder, which illustrates a 52 in. boring mill with a turret head in the center and an auxiliary side head. Some of the more important advantages of this type of machine are briefly referred to.

GRAPHITE FOR THE BOILER.—Fine flake graphite when introduced into a boiler, penetrates the scale and gradually disintegrates and loosens it. A small leaflet issued by the Joseph Dixon Crucible Company, Jersey City, N. J., explains the process and gives instructions in the best method of introducing it in the boiler and the kind of graphite that has proved most successful.

ELECTRIC FANS.—The Sprague Electric Works of the General Electric Company, 527 West Thirty-fourth street, New York,

is issuing an attractive decorated catalog, printed in colors, fully illustrating and describing a complete line of electric fans, showing them as arranged for ceiling, bracket or portable use. Prices of complete fans and of all the parts of the various designs are included.

HAMMER DIE.—William E. Sheehy, East Boston, Mass., has issued a leaflet describing the Sheehy free rocking-faced hammer die by which tapered forgings may easily be made. The rocking member is so supported that it may rock freely about a fixed axis, the desired taper being obtained by holding the work at the required angle to the face of the hammer. It will handle work up to 8 in. thick.

STEAM TURBINES.—Elbert Hubbard recently made a visit to the works of the Kerr Turbine Company, at Wellsville, N. Y., and has written a booklet entitled, "A Little Journey to the Home of the Economy Steam Turbine," which records his impressions. This is expressed in the author's well known distinctive style, and is most interesting. Copies are being issued by the Kerr Turbine Company.

HEATING WITH EXHAUST STEAM.—A special type of control valve has been designed by the Monash, Younker Company, New York, for use when exhaust steam from a power plant is employed for heating. This valve, together with various types of pressure regulating valves and vacuum pump governors, is illustrated and briefly described in a recent publication from that company. This design of radiator is claimed to be entirely noiseless and to give an unusually high efficiency.

MOLDING MACHINES.—Descriptions of jolt ramming machines in several sizes and operated by either electricity or compressed air, form the principal part of a catalog, designated as number 51, which is issued by the Mumford Molding Machine Company, Chicago, Ill. A variety of other machines that have proved their ability to produce economies in connection with molding are also illustrated and briefly described. These include hand and power squeezers, as well as vibrator machines, power riddles, etc.

DRILLING AND BORING OPERATIONS IN RAILWAY SHOPS.—An article written by P. G. Valentine of the Chicago, Milwaukee & St. Paul, which recently appeared in the *American Engineer*, is being published in pamphlet form by Pawling & Harnischfeger, Milwaukee, Wis. In addition to the interesting description of the method of doing certain classes of work in the Milwaukee shops, the pamphlet also includes some facts in connection with the horizontal drilling and boring machine manufactured by this company.

SHEARS AND PUNCHES.—A 24-page catalog from the Young Machine & Tool Company, Worcester, Mass., illustrates several arrangements of moderate sized punches and shears, both combined and as separate machines. With each style a table is included giving the range of sizes procurable, together with the weight, capacity and price. The catalog contains a brief illustrated description of some of the more important working parts of this design of punch and shear, and also illustrates an example of the type of engine lathe manufactured by the same company.

MOTOR DRIVEN TRACK CARS.—A leaflet describing the No. 3 triple ignition, motor car for railroad use is being issued by the Chicago Pneumatic Tool Company, Chicago. This car is arranged with a gasoline motor that drives through a series of clutches the same as an automobile. It is most substantially constructed for hard service and has two speeds ahead and two reverse. The reverse speeds are the same as those ahead, so that the car may be operated in either direction. A 4 h. p. motor is supplied, which gives the car a speed of 25 miles per hour.

BRIQUETTES.—A brief, comprehensive description of the making and use of briquettes, particularly as applied to this country, is included in a catalog issued by Renfrow Briquette Company.

Central National Bank building, St. Louis, Mo. An illustrated description of the Renfrow coalette press, which produces briquettes of an ovoid round shape about $3\frac{1}{2}$ in. in diameter, and $2\frac{1}{2}$ in. thick weighing from 13 oz. to 16 oz., occupies part of this booklet. A discussion of the grades of coal that have proved suitable for this work, as well as a discussion of the best binders and a full description of the process of making coalettes, is given.

CHAIN GRATE STOKERS.—An analysis of some 300 samples of coal from mines in practically every coal producing district in this country and some from abroad, is included in a catalog issued by the Illinois Stoker Company, Alton, Ill. This company's type of chain grate stoker is illustrated and described in detail, and illustrations showing its application to various types of boiler are given. An efficiency table based on the evaporation from and at 212 deg. F., giving the evaporation per pound of coal and the pounds of coal per horse power per hour that correspond to various ranges of efficiency from 50 per cent. to 80 per cent., and with coals having from 7,500 B. t. u. per pound to 14,500 B. t. u. per pound, is also included.

RAILROAD MOTOR CARS.—Complete illustrations and descriptions of four different types of gasolene railway motor cars are included in catalog No. 101, issued by Mudge & Company, Peoples Gas building, Chicago. These include a light inspection car suitable for signalmen, telegraph linemen, inspectors, etc., a light section car for maintenance work, a heavy car for carrying large section and work gangs, and for performing heavy service, which is driven by the Jacobs design of four-cycle engine, and the Au-Tra-Kar, which is a portable power plant car designed primarily for laying tracks with screw spikes, and is also suitable for many other classes of construction work. These cars and their parts are very fully described, and the illustrations show them in operation. A price list of motor car accessories is included.

GENERATING OXYGEN AND HYDROGEN.—The principle of the system for the generation of oxygen and hydrogen that forms the basis of the apparatus designed by the International Oxygen Company, 115 Broadway, New York, is the separation of water into its elements by means of electricity. The apparatus consists of generators or cells each capable of producing 3 cu. ft. of oxygen and 6 cu. ft. of hydrogen an hour. The operation of the cells is entirely automatic and it is only necessary to fill them with a little less than a gallon of distilled water for twenty-four hours' operation. Pamphlet No. 9 from this company discusses the operation of this system and gives a comparison of costs with other methods of obtaining oxygen or hydrogen. The apparatus is illustrated and tests of it are given. Bulletin No. 10 from the same company gives a complete description of the apparatus.

CLOTH PINIONS.—A new departure in noiseless pinions is described in bulletin No. A-4110, published by the General Electric Company, Schenectady, N. Y. These gears are made of a cloth or cotton filler compressed under a hydraulic pressure of several tons per square inch, and are held in compression by steel shrouds and threaded studs passing entirely through both the shrouds and the filler. They are applicable and especially desirable on a large number of machine tools, such as lathes, planers, traveling cranes, drill presses, punches, etc. It is claimed that they are as strong as the best grade of cast iron, that they are not liable to damage from contact with oil, that they are unaffected by atmospheric changes. They may be stored for an indefinite time without damage, are vermin proof, and have sufficient elasticity to absorb shocks. Beveled pinions, however, cannot be supplied. The bulletin also contains data relative to tooth dimensions and instructions for selecting the proper pinions.

LITTLE BREAKS.—A little break in an air brake hose often means a resultant expense many times larger than the cost of new hose for many cars. Guilford S. Wood, Great Northern building, Chicago, Ill., is issuing a leaflet drawing attention to air hose failures, pointing out at what point on the hose

the greatest number of failures occur, what causes them and how they may be prevented. This discussion of the subject is interesting and convincing. Data are given showing the causes of failure in the percentage of total number, and the illustrations show how air brake hose usually fails. Among other features this booklet points out that 10 per cent. of the bursted hose fails on account of an internal puncture due to mounting by improper devices. Recent investigations have shown that it takes longer to mount the fittings by machinery than by hand, and that machine mounted hose is very liable to be punctured. The test developed that eight out of ten pieces of hose mounted by an air machine were punctured in the inner tube before going into service.

ELECTRIC DRIVEN AIR COMPRESSORS.—Two publications on duplex, direct connected, electric driven air compressors are being issued by the Ingersoll-Rand Company, 11 Broadway, New York. The first, designated as No. 3008, fully describes this compressor, devoting 40 pages to illustrations of the various details and a discussion of the design. Among the principal features shown is an automatic clearance controller which consists of a number of clearance pockets which are automatically thrown in communication with the ends of each air cylinder in proper succession, the process being controlled by a predetermined variation in the receiver pressure. The hurricane inlet valve is a development of the original Sargent piston inlet valve, and is so arranged that there can be no escape of clearance air. The inlet valve cannot open until the air in the clearance space has expanded down to the intake pressure. This valve is made very light to prevent shock when opening or closing. A large water separator or moisture trap is placed on the discharge pipe of the intercooler of this type of compressor when of 18 in. stroke and larger. This will separate entrained moisture from the air and insures the delivery of practically dry air to the high pressure cylinder. A separate booklet, designated as Form No. 575, contains instructions for installing and operating this type of compressor. It also includes a duplicate part list.

PERFORMANCE OF GERMAN LOCOMOTIVES.—William J. Cunningham in a recent paper before the New York Railroad Club, reported that the cost of maintaining locomotives in Prussia in 1910 averaged 4.8 cents per mile, which indicates commendable efficiency even when due allowance is made for their small size. Failures are infrequent and the locomotives generally have the appearance of being well maintained. The Prussian policy differs from ours in that they expect and obtain a comparatively long life from their locomotives. The average life of all locomotives in 1910 was 10.2 years. One-quarter of the entire equipment ranged from 10 to 20 years in service; 45 per cent. ran from 5 to 10 years; and 22 per cent. had an average age of less than 5 years. The average mileage per locomotive in 1910 was 25,600. The same average for this country was approximately 29,100. The Prussian statistics showing the performance of locomotives are remarkably complete. Among other things they give the number of days all locomotives were in service, the per cent. of time in actual use, and the per cent. of time they were in the shops for repairs. They were actually used in train service 32.79 per cent. of their time; 18.91 per cent. of their time was spent in the shops for repairs; leaving 48.3 per cent. of the time when they were idle in or near the engine house. The high proportion of time idle is accounted for by their policy of single crewing. When not single-crewed, it is the general practice to assign one engine to two crews. Enginemen are required to do much of the light running repairs themselves, and on single-crewed engines the fireman is required to report at the engine house two hours in advance of leaving time, in which to kindle the fire and get up steam. At the end of the trip it is his duty to clean the fire and do other work which here is done by the engine house forces.

Railway Age Gazette

MECHANICAL EDITION
INCLUDING THE
AMERICAN ENGINEER

PUBLISHED ON THE FIRST THURSDAY OF EVERY MONTH, BY THE
SIMMONS-BOARDMAN PUBLISHING COMPANY,
WOOLWORTH BLDG., NEW YORK, N. Y.

CHICAGO: Transportation Bldg. CLEVELAND: Citizen's Bldg.
LONDON: Queen Anne's Chambers, Westminster.

EDWARD A. SIMMONS, *President* L. B. SHERMAN, *Vice-President*.
HENRY LEE, *Secretary*.
The address of the company is the address of the officers.

ROY V. WRIGHT, *Editor*. R. E. THAYER, *Associate Editor*.
E. A. AVERILL, *Managing Editor*. A. C. LOUDON, *Associate Editor*.
GEORGE L. FOWLER, *Associate Editor*.

Subscriptions, including the eight daily editions of the *Railway Age Gazette* published in June in connection with the annual conventions of the Master Car Builders' and American Railway Master Mechanics' associations, payable in advance and postage free:

United States, Canada and Mexico.....\$2.00 a year
Foreign Countries (excepting daily editions)..... 3.00 a year
Single Copy 20 cents

Entered at the Post Office at New York, N. Y., as mail matter of the second class.

WE GUARANTEE that of this issue 4 400 copies were printed; that of those 4 400 copies, 3 771 were mailed to regular paid subscribers and 125 were provided for counter and news companies' sales; that the total copies printed this year to date were 28 626—an average of 4 771 copies a month.

VOLUME 87. JUNE, 1913. NUMBER 6.

CONTENTS

EDITORIALS:

Our Change in Name	283
Hot Boxes on Locomotives.....	283
High Water and Superheats.....	283
Watering Locomotives in the Engine House.....	284
Railway Storekeepers' Association	284
Notes on the Fuel Convention.....	284
New Books	285

GENERAL:

Air Brake Association Convention.....	286
Laminated Locomotive Drawbar.....	288
Railway Fuel Association.....	289
Railway Storekeepers' Association.....	297
Stump Locomotive Cylinder.....	304

SHOP PRACTICE:

Rolling Mills at Scrap Docks.....	305
Exhaust Systems for Grinding Wheels.....	305
Eccentric Blade Bender.....	306
Dry Lumber Shed	307
Lying Off Shoes and Wedges.....	307
Miscellaneous Shop Kinks.....	309
Standard Oil House.....	310
Santa Fe Apprentice Instruction.....	311
Standard Casting Platforms.....	313
Master Boiler Makers' Association	314

CAR DEPARTMENT:

Undesired Quick Action of Brakes.....	317
Marking Couplers and Parts.....	318
Will Triple Valves Operate as Intended?.....	319
Grand Trunk Hopper Bottom Box Cars.....	323
Self-Propelled Cars.....	324
Location of Steam Heat Traps.....	328
Air Hose Failures	329
Car Wheel Failures	329

NEW DEVICES:

Improved Throttle Lever Rigging.....	331
Little David Riveting Hammer.....	332
Air Hose Coupling.....	332
Safety Devices for Locomotive Boilers.....	333
Offset Boring Head.....	335
New Model Driving Wheel Lathe.....	336
Mark Cold Drawn Steel Union.....	337
Heavy Duty Back Gaged Shaper.....	338
Drill Speeder	339
Hydraulic Forging and Bending Press.....	339

NEWS DEPARTMENT:

Notes	340
Meetings and Conventions	341
Personals	342
New Shops	344
Supply Trade Notes.....	345
Catalogs	346

Our Change in Name

Beginning with this issue the name of the *American Engineer* will be changed to *Railway Age Gazette, Mechanical Edition*, although the name *American Engineer* will accompany it, as shown on the title page. From a sentimental standpoint the necessity of making this change is to be regretted, for the name has made a warm place for itself in the hearts of many mechanical department officers. On the other hand, in this day of highly specialized technical journals, it is not only advisable, but almost necessary to use names that clearly define the fields which the various journals are designed to cover. The *American Engineer* was primarily intended to meet the needs of railway mechanical department officers and foremen, but the name did not imply this, and in many cases has been known to create a wrong impression. In seeking for a better name it seemed best to have the paper known as the mechanical edition of the *Railway Age Gazette*, which is so thoroughly well known in the railway field. The change is a change in name only—the editorial policy, the editorial staff, the grade of paper and printing, etc., will remain the same as before. We trust that the new name will meet with the approval of our readers.

Hot Boxes on Locomotives

A frequent cause of hot boxes on locomotives, and one which it is very difficult to avoid, is the running of the wheels through the piles of cinders which spread out over the rails after an ashpan has been cleaned while the locomotive is on the road. It is possible, however, that a considerable part of this trouble could be avoided by a systematic inspection of all the boxes of each locomotive at the engine houses, and it is quite certain that a great deal of the trouble which is caused by hot boxes could be eliminated by the inauguration of some such system. When it is considered that the possibilities of delays due to one hot box are almost unlimited, it is surprising that some system of periodical inspection and packing of boxes has not been installed on all railroads. In the majority of cases boxes are packed only when they are reported as having given trouble, or when the indicators on the hard grease boxes are so far up that it is evident that the box needs packing.

High Water and Superheats

While there is always more or less difficulty in educating enginemen in the use of new devices, it would seem that the superheater had been in use a sufficient length of time on many roads for the men to have obtained a good general knowledge of the purpose for which it is intended; yet on some of the roads which have a large number of locomotives so equipped, there are still enginemen and even mechanical department officers who cling to the idea that the superheater is intended simply as a steam dryer. Instances are not lacking of enginemen carrying the water so high in the boiler that it is continually being carried over into the superheater, which, instead of performing its function of superheating has to abandon part of its heating surface for evaporative purposes. In some cases this practice has even been sanctioned by the minor mechanical officers, and while it is expected, in the case of switch engines, owing to the conditions under which they work causing a tendency to raise the water through the throttle valve, that the superheater will have more or less evaporative work to do, it is difficult to see the necessity for carrying the water so high in the boilers of locomotives in road service.

Aside from any possibility of damage to the superheater, under such conditions it is losing part of its heating surface in order to assist the boiler in evaporating the water, a purpose for which it was not intended, and for which it should not be used. The heating surface of the superheater, when compared with that of the boiler to which it is applied, is so small that

comparatively little water passing over will appropriate so much of the heat that should go to superheat the steam, that the device will be made useless as a superheater. It has been abundantly demonstrated that a high degree of superheat is essential to the efficient working of the superheated steam locomotives, and it will be readily seen that whatever portion of the superheating surface is given to evaporating water will lower the degree of superheat proportionately. No one desires an engineman to take chances of burning a crown sheet by carrying the water too low, but they should be given to understand in the case of superheater locomotives, aside from increasing the work of the fireman and reducing the steam space of the boiler, that by expecting the superheater to evaporate water they are reducing the efficiency of the locomotive. The superheater cannot be expected to give the results desired from it when it has to assist in the work which should be done by another part of the locomotive.

Watering Locomotives in the Engine House

Delays in getting locomotives out of the engine house at the time for which they are ordered occur at times in spite of all efforts made to prevent them. Some parts of the repair work may have taken longer than estimated, or some other unforeseen cause may have contributed to the delay. At such times every minute that can be saved is of the utmost importance, particularly if the locomotive is for passenger service. If water could be taken in the engine house at such times, from 10 to 20 minutes could be saved in the delay, depending on the size of the tank and the amount of water in it at the time. In the Norfolk & Western roundhouse at West Roanoke, Va., a 3 in. water line has been run around the entire building under the roof and so located that it is directly over the tenders. Globe valves with a short hose connection are placed so that one valve will water two locomotives, and when it is thought that a locomotive is likely to be delayed this hose is turned into the manhole of the tender and the latter is filled, so that the locomotive is ready to leave for its train as soon as it passes over the turntable. A water line of this kind costs very little and has great possibilities as a time saver; its application is well worth consideration not only in new engine houses but in those already in use.

Railway Storekeepers' Association

Among the most valuable papers presented at the recent convention of the Railway Storekeepers' Association were those considering the effect of the stores department on the operating costs of a railroad, and the reduction of inactive and obsolete stocks. An excellent example of what a stores department can do to reduce operating expenses is shown by the system in vogue on the Atchison, Topeka & Santa Fe. This road, by judicious and careful planning, so regulates its supplies that a comparatively small percentage of material is held in stock. This is accomplished by a central stores organization, whereby the general storekeeper knows soon after the close of each month just how much stock there is distributed over the whole system. This permits of carrying less stock or, in other words, requires less capital to be tied up in material. This capital may be used for other operating requirements.

The reducing of inactive stock may be accomplished by careful supervision. It is the natural tendency for any department to maintain a rather large amount of surplus or emergency stock to provide for extraordinary demands, but when the general stores department can win the confidence of the other departments and insure the maintenance of a complete, though small, stock, it will be found that less trouble will be experienced with the reduction of this class of material.

G. G. Yeomans stated that the opportunities of the storekeeper were unlimited, and it would seem that this is true, when it is considered that a year's supply of material is held in stock

on all the railroads of this country taken as a whole. The reduction in stock means money to a railroad; even the smallest reduction would provide capital that could be spent in other important improvements. When some roads claim that only three months' supply is held in stock it would seem that the storekeepers of other roads are not making the most of their opportunities.

While there were a large number of interesting and instructive papers the scheme of having several members present separate papers on the same subject may be criticized as wasting the time of the association during the convention period. It is practically impossible for five papers to be presented on the same subject without a repetition of many ideas, provided, of course, the authors stick to their subject. A much better way would be to take the main arguments from them all and fuse them into one paper that would represent a thorough and concise presentation of the subject. There is also a tendency for the members to discuss topics while on the floor of the convention that are irrelevant to the subject at hand and sometimes wholly out of the jurisdiction of the stores department. This was especially noticeable in the extended discussion on the status of the engineer of tests and the preparation of specifications. There seems to be a lack of close co-operation that is necessary to make the organization a more effective unit and not infrequently resolutions have been adopted by votes cast in an entirely perfunctory manner which should have been done only after the most careful consideration.

Notes on the Fuel Convention

In most railway fuel contracts, in the bituminous district, there is a maximum and minimum clause which often permits the railway company to demand a daily or weekly amount that varies by as much as 100 per cent. The maximum demand naturally comes at the time of the greatest train movement which is usually the period of the greatest demand for cars, and the greatest difficulty in obtaining cars for coal loading. Furthermore, since this generally occurs in the fall and winter months, it is the time when the demand for commercial coal is largest and the price the highest. Under these conditions, the coal operator is compelled to deliver most of his output to his railroad customers at a price considerably less than he could obtain elsewhere and, in addition, after the railroad demands are supplied, there usually remain comparatively few cars in which he can load commercial coal.

For these reasons, the coal operators are strongly in favor of having the railroads provide storage yards in which they can store coal during the summer months in sufficient quantities to supply their excess demands during the winter. They are sometimes willing to grant some reduction in price if this practice is followed.

Mr. Peabody, president of the Peabody Coal Company, in his address to the association, strongly urged the storage of coal during the summer and suggested the storing of four months' supply. He stated that it would cost but fifteen cents a ton to do this if the proper facilities were provided. Of this amount, ten cents was assumed to cover the cost of depreciation.

Comparatively few railroads make any effort to store bituminous coal in even small amounts except where labor trouble may be pending. One of the principal objections advanced is the reduction in the quality of the fuel due to the extra handling and the weathering. With some coals, this alone may cost thirty-five cents a ton and, unless complete facilities are provided for unloading and reloading, another ten or twelve cents is added to this. Furthermore, the idle investment is a matter to be considered. In but very few cases can a reduction of as much as ten cents a ton be obtained by agreeing to store the excess winter supply, although, in some instances, the coal operator will carry the financial burden. It is thus hard for a railroad company to find that this practice has any advantages,

and but few are planning on extending it, although it is admitted that every practical effort should be made to help the coal mines on its lines.

In one case at least a form of contract is in force which seems to solve the problem in another way. In this the spread, or difference between the maximum and minimum demands permitted, is very small and the contract provides that for all coal demanded by the railroad over its maximum a premium of ten cents a ton will be paid for the first small percentage of the maximum, and twenty cents a ton for the next equal amount, and thirty cents a ton for the next, and so on. Such a contract seems to be thoroughly fair to the coal operator and is not hard on the railroad if the future requirements are estimated as carefully as they should be.

* * * *

That the brown or true lignite can be successfully used on locomotives is proved by the practice of at least two of the railways running through the western coal fields. These are the Chicago & North Western and the Chicago, Burlington & Quincy. The former now has twenty-one locomotives in service which use lignite as fuel exclusively. They were designed especially for this fuel and have a grate area about 50 per cent. larger than would be required for bituminous coal. From the beginning no trouble was found in making steam, but great difficulty appeared in obtaining a front end arrangement that would prevent sparks. The problem was finally solved by the use of an arrangement termed a "gyrus," which was illustrated on page 143 of the March, 1912, issue of this journal. This extinguishes the sparks by using a centrifugal action to throw them against a series of plates. These locomotives are now reported to be successful in every particular.

It is necessary, however, to use lignite very soon after it is mined, as it disintegrates rapidly on exposure to the air. This prevents it from being shipped to even a comparatively short distance and only those locomotives on the divisions where lignite is mined are possible users of it. The most reasonable method of extending its use seems to be by briquetting, and this is now being actively investigated with very encouraging results. It appears that the chief difficulty is to find a suitable binder which will not be so expensive as to make the briquettes cost more than other fuels in the district. It is believed that this will soon be accomplished.

* * * *

A complete manual of firing practice is being prepared by a committee of the Fuel Association, and two full sessions were devoted to the discussion of the preliminary report at this year's convention. This manual will include illustrations and specifications of recommended firing tools, instructions in the best method of manipulating the grates, dampers, blower, etc., under different conditions of operation and quality of fuel, recommended practice in all the details of hand firing and in handling a mechanical stoker, best methods for educating firemen and obtaining their co-operation, how best to interest operating officials in fuel economy, and a list of the ways in which firemen unnecessarily waste coal. This is not, in any way, to be an instruction book for the firemen themselves, but for those whose duty it is to train them and be responsible for the quality of their work. Judged on the basis of the possibilities for large savings, this is probably the most important work that is now being undertaken by any of the railway mechanical associations.

* * * *

"I will guarantee to save 10 per cent. of the locomotive coal if I am given an accurate individual fuel record of the engineers and firemen," was the statement of one of the members discussing the report on coaling stations. This statement was explained to be based on experience with the ordinary coaling station, where the amount is estimated by the engineer or coal chute attendant and with coaling by buckets handled by an air hoist

where the amount supplied is accurately known. The same sentiment was echoed by a number of others. The value of the accurate individual performance record—it must be accurate to be of any value whatever—lies not only in the appeal to the pride of the engineers, but also in the opportunity offered to discover the need of changes or adjustments in the locomotive itself and in any variation in the quality or condition of the fuel.

Some means of accurately weighing the amount of coal put on the tender every time coal is taken, is one of the essentials of such a system. A more or less elaborate system of reports and records is also needed for the best results. So far as appeared, there is but one railway that has such a system in practice on a large scale. On the Atchison, Topeka & Santa Fe the coaling stations have weighing hoppers, and the reports are most complete and comprehensive* in their character. The results have proved to be even better than had been anticipated in the beginning and savings of surprising amounts were claimed and demonstrated. The sentiment of the meeting was strongly in favor of weighing hoppers or some other means of obtaining the exact amount of coal put on a tender.

In connection with the same report, the depreciation of the fuel caused by its passage through a mechanical coaling station was strikingly demonstrated by a series of photographs. These showed the coal on the car; as it appeared in the storage bin of the coaling station, and as it appeared on the locomotive tender.

* * * * *

The associations which are of the most value to their members and the railways are those that select appropriate subjects and give them full discussion, arriving at a definite conclusion or a future line of action. To do this with any subject that is worthy to be brought before these conventions, takes considerable time. In this respect the International Railway Fuel Association stands among the best of the mechanical associations. Seven subjects were selected for four days' work. This gave but two subjects to be considered for each day except the last. It was thus possible to devote a whole day of eight hours to two subjects if necessary. This, coupled with a presiding officer who compelled the speakers to confine their remarks strictly to the subject under discussion, made the convention unusually satisfactory in every particular. Other associations would do well to follow the same practice.

The subjects proposed for consideration at the next convention include a number of special importance, and indicate that the interests of the membership are broader than might be supposed from the name of the association. They include some dealing with features of locomotive designs that have an effect on fuel economy, *viz.*, front end arrangement and design of grates and ash pans. Locomotive stokers are also proposed as a subject for report and discussion. Other subjects are, sizing of coal, weighing coal, motor car fuel, in addition to the reports of the standing committees on firing practice and coaling stations. It is not expected that all of these will be brought up next year, but from this list five or six subjects will be selected.

NEW BOOKS

Safety Valve Rating. By Alfred G. Carhart, C.E. Illustrated. Bound in paper. 6 in. x 9 in. 105 pages. Published by the author at 10 Roland street, Charlestown, Mass. Copies free.

This book is probably the most complete technical discussion of the factors that enter the formulation of rules for safety valves that has ever been published. All the features of design of the valves and their relation to the boilers to which they are applied are thoroughly considered, and three new rules differing from anything heretofore suggested are proposed. The calculations leading to these rules are given in detail and each step is made clear to any reader at all familiar with the subject.

*See *American Engineer and Railroad Journal*, May, 1910, page 161.

AIR BRAKE ASSOCIATION CONVENTION

Several Important Reports Were Presented at the Annual Meeting, Which Was Well Attended.

The twentieth annual convention of the Air Brake Association was held at the Planters Hotel, St. Louis, May 6 to 9, President W. J. Hatch, general air brake inspector of the Canadian Pacific, presiding. The president, in his address, called attention to the importance of the proper maintenance of the air brake equipment, not only from an economical standpoint but also for the safety of the general public; he emphasized the fact that the members were in a position to produce by efficient work a decrease in the maintenance costs, especially of freight equipment. He strongly recommended the terminal testing plants by which the air brake equipment of trains may be immediately tested on their arrival at the terminals, pointing out that by this method defective equipment may be located and thoroughly repaired before the cars are required to go out on the road again. He spoke of the air hose failures as being one of the most troublesome features in air brake maintenance, especially in northern climates where the extreme cold freezes the hose so that it is practically impossible to keep the hose connected while on the road. In this respect he advocated the use of hose that would resist this freezing action, and as a general proposition raised the question as to whether or not it would be practical for the M. C. B. Association to adopt a time limit for the hose to be held in service, in this way anticipating a large percentage of the hose failures and greatly decreasing the damage done to equipment from these causes.

The secretary's report showed a total of 788 active members and a cash balance of \$2,619 in the treasury. About 275 members registered at the convention, and the meetings throughout were well attended.

Four of the papers which were read are so intimately concerned with the work of the car department that they are included in the Car Department section of this issue as individual articles. They are "Undesired Quick Action, Its Prevention and Remedy," by C. N. Remfry; "Will the Triple Valve Operate as Intended," by S. W. Dudley; "Air Hose Failures," by T. W. Dow, and "Location of Steam Heat Traps," by C. W. Martin.

OPERATING LONG FREIGHT TRAINS.

F. B. Farmer, of the Westinghouse Air Brake Company, read a paper on this subject, an abstract of which follows:

Next to safety comes the less spectacular, but very potent argument of needed economy in cost of transportation. An editorial in the *Railway Age Gazette* of February 7, 1913, says: "From 65 to 80 per cent. of the damage to freight cars is caused by defective draft gears," basing this on a statement by a master car builder of a large road. Part of this damage is caused in train handling, and while inherently weak draft gear and gear all wed to leave terminals in a defective condition contribute to break-in-twos, yet, as good handling will, even under such adverse conditions, avoid many failures that occur, the opportunities for improvement are obvious. Our efforts should be toward keeping trains moving toward destinations without damage. That this may be done, and safely, requires, of course, some standing time for testing and repairs, but this merely emphasizes the need of avoiding unnecessary damage and delay.

Air Brake Instruction.—The instruction facilities of an air brake instructor car, including the instructor, are of value in so far as they contribute to safer, more expeditious and more economical train movement and no farther. Too often the air brake man, outside of, as well as in the car, allows his interest in some details to obscure the main object, and thereby accomplishes less of the desired results than he could. Enginemen should, of course, be given a working knowledge of the construction and operation of the engine and car brake apparatus

so they may operate and test it intelligently and make needed reports of defects. But too often the construction, operation and defects are dwelt on to an extent that excludes adequate consideration of the main theme, manipulation or train handling. In fact, with the fundamentals of construction and operation explained, any elaboration should accompany and develop from instructions on manipulation, and will thereby be less dry, better appreciated and more valuable.

The instructor, to succeed, must realize, and ever keep in mind, that the air brake is a means and not an end; that it is to promote train movement as far as is compatible with safety and economy; that this is obtained largely in train handling (starting, running and stopping), and that all instructions on train handling should be based on the fundamental and all-important fact that with draft rigging in fair to good condition no damage in train handling (not including switching) will follow if the slack is not allowed to run in or out harshly. The facts that the head brakes commence to apply and to release earlier than the rear ones; that with the same application brakes hold better as speeds are lower; that brakes retard empties better than they do loads, etc., are of lessened value to all engineers and of no value to some unless directly associated with their effect on slack action. All instruction on train handling must be based on and tied to train slack control, must teach engineers the various causes for slack running in and out, and how to use the brakes, the steam and the sand to prevent harsh slack action.

The instruction car work is merely the beginning, and if it is not followed up by individual instructions and observations on the road the results will be disappointing and out of proportion to the time expended. If either must be slighted it should be the car instructions. Especially on large systems that do not have district air brake men, and even where the latter are had, all of the regular, individual instructions in service must be given by the traveling engineer. Therefore, the main duty of the air brake man should be to thoroughly post the traveling engineer, both in the car and by riding trains with him and demonstrating, mainly for his benefit, by personal directions to engineers and by handling trains.

Break-in-Two Records and Investigations.—Without reasonably accurate and complete records of every break-in-two officials are working largely in the dark, and accurate and complete reports are impossible without suitable forms. The conductor and the engineer must be shown by such forms just what information is wanted, and the writing to give it must be reduced to a minimum. The first report of each should indicate on its face whether anything farther than a record is necessary. If so it should ordinarily require little investigation preliminary to a decision.

The importance of investigations and the necessity for suitable report forms are indicated in the following extract from a committee report made at a meeting of operating officials of the Illinois Central, by J. L. East, agent of the loss and damage bureau:

The matter of rough handling of trains can be readily corrected if those connected with the transportation department holding supervisory positions will follow up closely with their superior officers any rough handling of trains coming under their observation in a sufficiently perceptive manner, to enable proper investigation of each specific case. It should be possible to surround this whole question of rough handling of trains on road, as well as in terminal yards, with such close and constant supervision through the co-operation of the entire division staff, as to make possible a thorough investigation of at least the majority of cases of rough handling occurring on any division. This is a matter of the most importance, and there is no question but that a great improvement in the way of reducing claims can be made.

Train Handling.—Draft rigging in fair to good condition is not pulled out. It is either driven in or jerked out, both implying a severe blow. The severity cannot be judged by any shock felt by those riding trains, particularly the engineer of a heavy locomotive. For a shock to be felt the speed must change suddenly and considerably. The amount of the instant reduction in speed of a modern freight locomotive necessary to cause a break-in-two, is too little to be felt. Engineers who do not understand this are prone to attribute resulting failures to the condition of the draft rigging instead of to their handling. Another overworked explanation for draft gear failures is "old defect."

Records show, regarding break-in-tuos with ordinary freight trains of from 1,700 to 2,400 tons, that 20 per cent. to 25 per cent. occur within five cars from the engine; about 40 per cent. between the engine and tenth car, and 60 per cent. to 65 per cent. between the engine and twentieth car, conclusive proof that it

gain such headway as to generally do damage when the stretched portion of the train is reached.

G. B. Pierce has had considerable experience running a Mallet pusher. Stalled one night with over-tonnage he arranged with the others of the crew to try a new plan of starting. The head man was to do all he could and then keep his throttle open moderately, but prepared to ease off as much as necessary when he was started so as to avoid a lurch. Mr. Pierce took as much slack as deemed necessary, then started carefully, simply. The results proved so satisfactory that the method was repeated where necessary with other trains and is now the standard on that road. Its logic is apparent, as the helper cannot drive the slack into the head end and the two engineers are more certain to work together. Also, draft rigging will stand more thrust than pull.

Running, including slowing but not stopping, demands first that the engineer know how the curvature and change of grade will affect the train slack and that he make such use of steam, sand and the air brakes, including the independent engine brake, as to prevent any severe shocks. Instances are known where changes of grade caused the slack to run in harshly from the rear and in spite of steam being used heavily to prevent. The remedy is to bunch the slack carefully with the independent brake just before reaching the point where it would otherwise run in heavily. It is always undesirable to shut off suddenly where steam is being used heavily, but particularly so at a point where the track conditions alone would cause the slack to run in.

Stopping, like starting, is where much of the damage is done. Stopping long freight trains with the engine brakes only should generally be discouraged. Granted that it can be done with many advantages where conditions favor, as they frequently do, yet the fact is too often attested by trainmen, particularly those in the caboose, that it is abused. Some engineers either apply it too heavily or, if light enough, do not wait long enough to get the slack in to the rear before applying harder. Again, this part may be done well, but the brake be held applied to the stop. Its power should always be reduced nearing the stop and completely released if on even a gently ascending grade. Otherwise, the compressed coupler springs will run the slack back fast enough to do damage. The only safe general recommendation is to use the train brakes when stopping with more than a few cars.

Mr. Farmer closed his paper with detailed instructions in train handling for freight engineers.

Discussion.—This paper was enthusiastically received. While many of those present stated that their instructions to enginemen were very similar to those Mr. Farmer presented, several questions were raised which were of a more special nature than could be covered in the paper.

W. W. Schriver (B. & O.) mentioned the operating of 160 car trains which he had found impossible because of the difference in train line pressure between the head end and rear end of the train. The question of the permissible difference in head end and rear end brake pipe pressure was raised, many members stating that on long trains it seems unnecessarily large. This was due perhaps to excessive train pipe leakage or the incorrect reading of the gages, as there should not be a difference much greater than 5 or 6 lbs. Mr. Wood, of the Santa Fe, explained that his road would not allow a train pipe leakage of more than 5 lbs. per minute.

Experiences were narrated where trains would break-in-two without the engineer knowing it, but it was clearly shown that if the train pipe had been charged to its full pressure this could not happen. There are cases of trains standing with the engine disconnected, while taking water and coal or to do switching, where the air will leak out of the train pipe, allowing the brakes to release. If, after the engine is coupled to the train again, it starts before recharging the train pipe it is possible for a break-in-two to be experienced without the engineer realizing it. The train pipe would then have an open end and the

Duluth, Missabe & Northern Railway Co.

ENGINEER'S BREAK-IN-TWO REPORT

Train _____ Direction _____ Date _____ Eng. No. _____ Condr. _____

Total Cars Coupled Loads _____ Emptys _____ Number Emptys behind Loads _____

Tone _____ Delay Hrs _____ Min _____ Nearest mile post or station (Give branch letter) _____

Was train Starting _____ Stopping _____ Running _____ Backing _____ Switching _____

If starting was slack taken? _____ How? _____

Was steam being used? _____ Light _____ Heavy _____ Speed at break-in-two _____

Were brakes being released? _____ If so, at what speed? _____

Were engine or train brakes being used? _____ Speed when shutting off? _____

How long before brakes applied _____ Am's first red'n _____ Speed then _____

Am's final reduction _____ How far from stop _____ Total reduced just before final reduction _____ (Note: Where engine brakes, independent or straight-air used, give brake cylinder pressure where reduction asked for.)

Any precious severe shocks? _____ Where? _____ Cause? _____

No. of cars from engine where break occurred? _____

State fully your reason for break-in-two _____

Engineer _____

Make reports in duplicate and mail original to Traveling Engineer and duplicate to Train Master.

Engineer's Break-in-Two Report.

is the harsh running out or pulling out of slack at the head end that does most of the damage in train handling.

As it is a false pride that prevents some engineers from encouraging the conductor to advise of any severe shocks to the rear of the train, the wise man will pocket his pride and get this information, appreciating that in no other way can he judge how to handle trains without damage toward the rear. This simple and commonplace suggestion is very important in good handling.

Starting a freight train properly requires fundamentally that the engine be kept at a slow and uniform speed until the rear car is moving. The distance to accomplish this will vary. Stopping properly will usually bunch the slack sufficiently for starting, but if slack has to be taken it should be either a foot or two or that of the entire train. Stalling in starting, taking the slack on part of the train and then trying to start is very bad practice. Almost unconsciously the engine is allowed to

compressor would not be able to build up a train pipe pressure large enough to operate the brakes under this excessive leakage. It was, therefore recommended that sufficient time be given for the compressor on the engine to fully charge the train pipe and that the brakes be tested before leaving

OTHER BUSINESS.

Among the other speakers at the convention were E. F. Kearney, vice-president of the Missouri Pacific; J. F. Enright, superintendent of motive power and equipment of the Denver & Rio Grande, and Walter V. Turner, chief engineer of the Westinghouse Air Brake Company. Mr. Kearney stated that now, as never before, was the loyalty of railway employees necessary to keep the equipment in the best possible condition, for the railways, being handicapped by government rulings, must exercise the utmost care in keeping down the cost of operation.

Mr. Enright stated that he realized the great importance the air brake men play in train operation, since the Denver & Rio Grande is located in a very mountainous district, where it is necessary that the air brakes be maintained in a very efficient condition. His greatest difficulty is in not receiving cars on his lines in sufficiently good order to get them over the road. This is probably due to the fact that the delivering roads, which were, as he termed them, valley roads, did not find it necessary to have the brakes at their highest possible efficiency. In accepting trains it has often been found that 50 per cent. of the cars were not in suitable condition to be carried over mountainous lines.

Walter V. Turner gave an informal talk to the members of the association in the afternoon of the second day of the convention.

The executive committee voted as the sense of the association against the formation of a suppliers' association to work in conjunction with the Air Brake Association, desiring to furnish their own entertainment at the conventions.

The following officers were elected for the ensuing year: W. J. Hatch, Canadian Pacific, president; L. H. Albers, New York Central Lines, first vice-president; J. T. Slattery, Denver & Rio Grande, second vice-president; T. W. Dow, Erie, third vice-president; F. M. Nellis, Westinghouse Air Brake Company, secretary, and Otto Best, Nathan Manufacturing Company, treasurer.

LAMINATED LOCOMOTIVE DRAWBAR

Several railways are now using drawbars between the locomotive and tender which are composed of several layers of steel plate, secured together at the ends, instead of a solid wrought iron bar as has been customary. The wrought iron drawbar may contain interior defects which do not show until after failure, and this new steel plate bar has been developed largely for the purpose of obtaining a design which would give a preliminary warning of any weakness. Experience has shown that it is very successful in this particular and, although it costs from 15 to 20



Steel Plate After Having the Ends Shaped and the Rivet Holes Punched.

per cent. more than a forged bar, it is easy to repair, as in case of failure, one plate only will break and this can be removed and replaced by a new one at a slight expense and the bar may be promptly returned to service. Drawbars of this type cannot be used where it is necessary to offset for a difference in the height of the engine and tender.

A drawbar of this kind in use on the Canadian Pacific is shown in the illustration. It has six 1/2 in. mild steel plates, held together by two rivets at either end. The section at the center is 4 1/2

in. wide; it is 8 in. wide at the ends. When these bars were first designed, spring steel was used, but it has been found that mild steel is much more satisfactory. In the early design also three rivets were applied at either end, the third one being inside of the drawbar pin hole and on the center line. It was soon found, however, that the bars would fail by cracking from this hole diagonally outward to one side and therefore this third rivet has been eliminated and no further failures have developed at this point.

In manufacturing the bars, the 1/2 in. plates are cut to a width of 8 in. and a length to suit the class of locomotive for which they are intended. The ends are then heated and cut to shape in a hydraulic flanging press to which special dies and cutters are applied. The appearance of the plate after this operation is shown in the photograph. After both ends are stamped out, the rivet holes are marked and are then punched 1/16 in. smaller

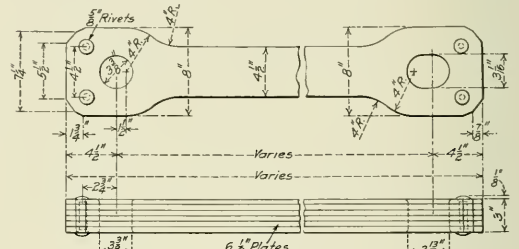

Drawbar Made of Steel Plates; Canadian Pacific.

than the finished diameter. The next operation is to shear off the superfluous metal between the heads in the shank of the plate. This is done without heating. The plates are then put together, the rivet holes are reamed to the proper size and the rivets are driven. The bar is marked off for the drawbar pin holes, which are drilled to size, and the oblong hole in the one end is milled to the proper shape.

On this road the use of the laminated drawbar is not confined to any one class of locomotive nor to locomotives equipped with any special device, such as a radial buffer device between the engine and tender, but is used wherever the solid drawbar has been employed except in the case of an offset bar.

STEAM CAR FOR NAVIGATION.—Mr. Benjamin Phillips, architect, of Philadelphia proposes to construct a steam car to travel on rivers at a speed of 20 to 25 miles per hour to carry one hundred passengers, to draw 15 inches of water, to be only one-third the weight of any other ordinary steamboat of the same dimensions now afloat; of far superior strength and safety, constructed on entirely new principles; the whole material except the engine and boiler to cost about \$1,600 completely furnished and ready for operation by the first day of May next.—From the American Railroad Journal for January, 1833.

EARLY RAILROAD TRAVEL.—We are requested to state that there has not been a day since the opening of the Camden & Amboy Railroad that the Philadelphia and New York passengers have not been taken over the road each way with the exception of Saturday and Monday last, notwithstanding the recent heavy falls of snow. On those days there were no passengers from Philadelphia owing to the company's not being able to procure coaches to convey passengers from Philadelphia to the railroad. The passengers that left New York on the above-mentioned days were taken over the railroad in cars and forwarded to Philadelphia the same evening in sleighs. The stage arrangements being now completed, passengers will be conveyed from the railroad to Philadelphia in coaches until the river Delaware opens.—From the American Railroad Journal, March 9, 1833.

RAILWAY FUEL ASSOCIATION CONVENTION

Recommended Firing Practice Among the Subjects Discussed at the Fifth Annual Meeting.

The fifth annual convention of the International Railway Fuel Association was opened at the Hotel Sherman, Chicago, on May 21 by the president, H. T. Bentley, assistant superintendent motive power and machinery, Chicago & North Western. After prayer by Rev. William C. Shaw, Mr. Bentley, in addressing the meeting, drew attention to the growth of the association from 35 to over 500 members in the five years of its existence. He suggested that a paper be prepared by a committee of coal operators outlining what is being done to increase the percentage of coal removed from the mines to the total amount in place. Some of the more important suggestions in this address are given below.

PRESIDENT BENTLEY'S ADDRESS.

Several of the larger roads have found it profitable to organize a regular fuel department for the purpose of checking waste, instructing enginemen, etc., and with a very limited organization it has proved a good investment. It is, however, possible to get better results on nearly all roads with practically no additional expense, if everybody will co-operate. We should first see what can be done under conditions as they exist, and later, when we are sure of our ground, make such recommendations that we can back up with figures, to show that we are justified in asking for improvements.

On account of the constantly increasing cost of fuel, a special effort must be made to use the lower grades of coal, and also the true lignite, which can be burned successfully with a properly designed firebox, boiler and front end arrangement. In certain localities there is a demand for lignite coal for commercial use during the winter months only and, as a result, it hardly pays to operate the mines six months of the year; but, if it was used on locomotives, it could be mined all the year and thus result in building up the industry for the benefit of both the coal and railroad companies.

Bulletin 14, issued by the Bureau of Mines, states that there are about 150,000 square miles of workable lignite beds in this country. It is estimated that there are 104,544,000,000 tons of this fuel available. If briquetted, its heating value is increased nearly 50 per cent., and as certain samples submitted from North Dakota for test were made into briquets without the addition of an artificial binder, it would appear as if this subject should receive more attention than it has in the past. Only 8,451,365 tons were mined during 1911.

Efforts have been made at different times and by different railroads to burn pulverized coal, but, from the fact that nothing has been done for the past few years, it is evident that very serious difficulties were encountered and it is, therefore, of interest to learn that the subject is again being taken up in a very thorough manner by one of the railroads. We may hope to hear something about it before long. The obstacles heretofore appear to have been in the inability of the fire-brick to withstand the intense heat generated, and to properly pulverize and store the coal in a locomotive tender. If we could utilize pulverized coal in a locomotive firebox satisfactorily, it would definitely solve the problem of the large engine and the capacity of a fireman.

During the winter months, in the northern states, there is difficulty in moving cars and a greater demand for them than in the summer. The coal operators and railroads are harassed to give more prompt service and under greater difficulties than in the warm weather, so that if railroad and commercial coal could be stored in central locations during the summer months near where it is to be used, and distributed from there late in the season, it would often save the long haul under adverse weather conditions. While there is some loss on account of slacking, un-

loading and picking up, etc., I believe the cost could be reduced by the mine operators for coal furnished when the commercial demand is less and the handling of empty cars to the mines could be considerably reduced during the cold weather.

The use of larger passenger and freight locomotives has in a number of cases decreased rather than increased the amount of coal consumed in doing a given amount of work; this being more noticeable when the engine in the first place was worked up to its capacity to handle a heavier train than it was designed for and a larger engine put on that could haul the loads easily, the saving effected in some cases being as high as 15 per cent.

MR. QUAYLE'S ADDRESS.

Robert Quayle, superintendent of motive power, Chicago & North Western, strongly urged the adoption of every practical means for increasing the efficiency in the use of fuel. He believed that larger grate areas on locomotives were advisable and laid special stress on the value of better prepared coal for locomotives. Coal pushers and other devices to aid the fireman should be applied. Brick arches are of great value and all types of locomotives, even switchers, should be fitted with superheaters. Team work between the engineman and fireman should be fostered in all cases.

MR. PEABODY'S ADDRESS.

Francis S. Peabody, president of the Peabody Coal Company, outlined some of the problems of a coal operator in an impressive manner. The amount of coal now left in place in the mines after operations are finished is about 40 per cent. It is easily possible to remove all the coal, but, in doing it, the cost is considerably increased on all the coal taken out. The present methods are those which give the cheapest product. He referred to the hardship on the coal operator by the enforcement of the maximum and minimum clause in the contracts. The maximum tonnage is always demanded by the railroad when the price is the highest and cars fewest. Also just before a strike. In this connection Mr. Peabody stated that the railroads were often directly responsible for the success of miners' strikes because of their action in offering a high premium for coal and causing some operators to break their agreement with the others. The strike of 1912 was mentioned as an illustration. This strike resulted in an increase of six cents a ton in the cost of coal.

He strongly favored the storage of coal by railroads and believed that four months' supply, at least, should be stored during the summer months. The building of trestles for unloading coal to be stored and steam shovels for again loading, was recommended. He stated that the cost would not exceed 15 cents a ton, of which 10 cents would be the loss due to depreciation and 2 cents for unloading. This apparently applied to a particular grade of fuel.

Mr. Peabody gave the increase in the cost of coal during the past 15 years for his company. In 1897 the cost was 25 cents a ton at the mine. At present it is 90 cents. Sixty per cent. of this increase is due to increased cost of labor. Of the present cost of 90 cents a ton, less than 3 cents is for the coal itself.

Secretary's Report.—The secretary's report showed a membership at the opening of the convention of 523. At the close of the meeting it was announced that the membership was 590.

STANDARD FORM OF CONTRACT

The committee on this subject submitted a proposed standard form of contract which included specifications as to the mines from which the coal was to come; a provision of maximum and minimum daily and weekly tonnage; an understanding to determine the proper percentage of the order which must be fur-

nished in times of car shortage; a provision that coal loaded longer than ten days would not be acceptable; agreement as to methods for weighing under different conditions; a preference clause giving the railroad the first call on the mine's output; inspection agreement; prices and an understanding in the event of strikes. The committee consisted of J. G. Crawford, chairman, H. L. Badham, E. A. Foss, I. C. Hatch and B. T. Jellison.

DISCUSSION.

Objection was raised to a feature of the proposed contract which specified the way in which coal could be delivered in case of a car shortage. It was urged that the matter of supplying cars and the purchase of coal should be kept separate. It was also suggested that the invoices should carry the serial way-bill numbers. The question of including some specification as to the quality of the coal in the contract was advocated by some members. One wished it to include the heat value and the percentage of ash, and another speaker proposed a specification as to the minimum temperature at which the ash would fuse. It seemed that none of these suggestions were practical in a railroad contract as they would have to take the coal the mines on their lines could produce. So far as appeared no railroad is purchasing on a sliding scale of price varying with the heating value.

SUB-BITUMINOUS AND LIGNITIC COAL.

Samuel B. Flagg, engineer, Department of the Interior, Bureau of Mines, read a paper on this subject, an abstract of which follows:

Availability is one of the principal factors governing the cost of fuel for any road, and for this reason, largely, some roads or divisions are using wood, others are using oil, and still others anthracite, bituminous, sub-bituminous, or lignitic coals or coke. In some foreign countries peat has also been tried, but, so far as the author knows, without great success.

Unfortunately the dividing line between lignitic and sub-bituminous coals and also between sub-bituminous and bituminous coals cannot be sharply drawn. In general, however, lignitic coals are characterized by a high moisture and high volatile matter content, by a fairly low percentage of ash, and by a low heat value. They are of a brownish color, have a woody appearance as regards their structure, and give up their moisture and disintegrate rapidly upon exposure to the atmosphere.

The lower grades of sub-bituminous coal differ from the lignites mainly in their appearance, as is indicated by the designation, "black lignites" that is frequently given them. These lower grades of sub-bituminous coal, like the lignitic coals, are high in their moisture and volatile matter contents and low in heating value. Their behavior on exposure to the air is also similar to that of the brown lignites, but the structural resemblance to wood is much less marked and, in many cases, is absent. The better grades of these sub-bituminous coals, on the other hand, have a much lower moisture content and a higher heat value; in fact, the heat values of some of them are considerably higher than those of many of the bituminous coals. Even these high grade sub-bituminous fuels, however, have the same tendency to disintegrate on exposure to the air, and the same is true upon exposure to heat in a furnace. Another characteristic feature of both the lignitic and sub-bituminous coals is their liability to heat in the pile or bunker and to take fire spontaneously. This difficulty is experienced with many of the bituminous coals as well, but is not so uniformly encountered with such coals as with the lower grade fuels.

A few typical analyses of fuels from some of the different fields are given in the table below, the last two being classed by the United States Geological Survey as medium grade bituminous coals, although they are frequently designated as sub-bituminous or lignitic coals.

It has been estimated that of the coal easily accessible and still remaining in the coal fields of the United States one-third

is represented by the lignitic and the sub-bituminous deposits.

Mining costs in the different fields producing sub-bituminous coals vary considerably, probably ranging between \$0.80 and \$1.70 a short ton as extreme values. These costs, of course, are proportionately higher where the output is small than where the development has been more extensive. They are also affected by

PROXIMATE ANALYSIS	Ohio, Highgate Co., Wyo. (Sub-Bit.)		Utah, Carbon Co., Wyo. (Sub-Bit.)		Hudson, Fremont Co., Wyo. (Sub-Bit.)		Montana, Musselshell Co., Mont. (Sub-Bit.)		Erie, Weld Co., Colo. (Sub-Bit.)		Gallego, McKinley Co., N. Mex. (Sub-Bit.)		Lump, Nut and Stick, W. Va. (Lignite).		Beck Springs, Sweetwater Co., Wyo. (this)		Superior, Sweetwater Co., Wyo. (this)		
	U. P. R.	U. P. R.	U. P. R.	U. P. R.	U. P. R.	U. P. R.	U. P. R.	U. P. R.	U. P. R.	U. P. R.	U. P. R.	U. P. R.	U. P. R.	U. P. R.	U. P. R.	U. P. R.	U. P. R.	U. P. R.	
Moisture	16.58	6.72	8.37	7.83	15.84	11.90	42.88	7.32	7.40	31.97	45.06	41.10	32.66	34.55	37.85	24.22	39.83	40.17	46.95
Vol. Mat	46.05	39.51	48.02	53.63	43.95	41.57	24.22	45.37	46.95	5.40	8.05	3.51	5.88	5.34	8.68	7.94	6.42	4.57	6.4
Fix. Car	5.40	8.05	3.51	5.88	5.34	8.68	7.94	6.42	4.57	64	63	38	22	22	56	1.53	1.06	91	10699
Ash	10699	11462	12771	10215	11077	5683	12017	12883
B. T. U.

the character of roof and other physical mining conditions, by the cost of timber for props, and by the prevailing scale of wages. Some idea as to the costs of production in some of the sub-bituminous and some of the bituminous fields can be gained from the following figures:

Location of deposits.	Production cost per ton.	
Carbon County, Mont. (Sub-bituminous).....	\$1.40	to \$1.60
Bighorn County, Wyo. (Sub-bituminous).....	1.10	to 1.40
Sheridan County, Wyo. (Sub-bituminous).....	.70	to 1.38
Boulder District, Colo. (Sub-bituminous).....	1.05	to 1.10
Gallup District, N. Mex. (Sub-bituminous).....	1.25	
Illinois Field (Bituminous).....	.85	to 1.40
Pennsylvania Field (Bituminous).....	.85	to 1.25
West Virginia Field (Bituminous).....	.87	to .90

The substitution of these low grade coals for bituminous fuel introduces, in addition to other difficulties, a number of problems of operation. Because of the generally lower heat value and the difficulty of realizing this value in the firebox it is obvious that a much larger quantity of coal must be burned in a given time in order to develop the required horsepower. For this reason the grate area must be greater—one authority says 50 per cent. greater—than would be required for good bituminous coal.

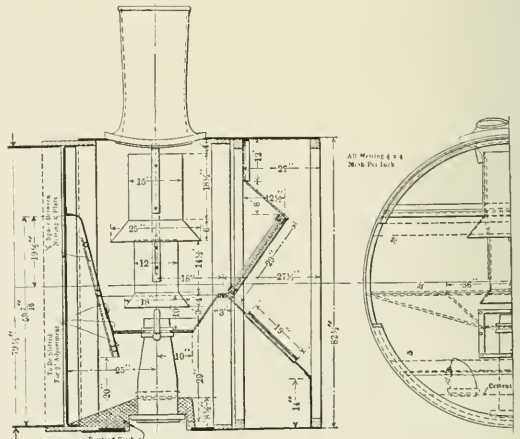

Fig. 1—Unsuccessful Arrangement of Front-End for Burning Lignite.

The disintegrating action of the heat further complicates matters by increasing the resistance of the fuel bed to the flow of air through it. High drafts are necessary to overcome this resistance and maintain the required rates of combustion, and to get them, the exhaust pressures must be increased to such an extent that the efficiency of the locomotive is reduced 5 to 10 per cent. thereby.

One point in favor of these sub-bituminous coals that should not be overlooked is the freedom from clinker troubles. The percentage of earthy matter in them is usually low—in many instances under 5 per cent.—and the sulphur content is also low. If the refuse has any clinkering tendency at all, the clinker is of such a nature that it is easily broken up and therefore introduces no serious operating difficulties.

In some sections the greatest problem connected with the use of sub-bituminous fuels has been the one of preventing spark troubles. Because of the high drafts necessary for burning these coals and on account of the absence of any coking properties

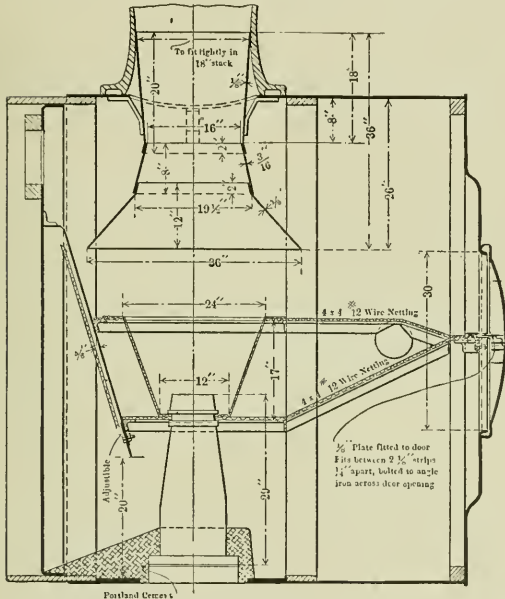

Fig. 2—Double Screens in Front-End for Burning Lignite. This Arrangement Has Been Discarded.

of the fuels, large quantities of sparks are carried out of the fire-box. These sparks must either be caught by some arrangement of screens, or so delayed in passing out that they are cooled down to a temperature at which they will do no harm, or they must be broken up into particles of such small size that they will be dead before reaching the ground. The first attempts to solve this problem were made with different sizes and arrangements of screens and usually included two screens for the gases to pass through. Examples of such front-end arrangements are shown in Figs. 1 and 2. It was usually found, however, that one of the screens clogged and prevented the free steaming of the engine. By using a single screen, properly set, most of the clogging trouble can be done away with, unless there is a steam leak in the smoke-box or wet slack coal is being used, and some roads claim to have found the screen as satisfactory and effective as any means for eliminating spark troubles. Screens set horizontally will, with some forms of stacks, remain clear longer and give less trouble than if set on an incline, and likewise small mesh netting of small wire is more satisfactory than small mesh netting made of large wire.

In using these small mesh screens in locomotives burning sub-bituminous coals it is very important that no holes be left around the edges of the screen or where it comes in contact with steam pipes, as any holes of this sort will give serious trouble. The front ends should be so arranged that they may be readily inspected and cleaned, and it is of the greatest importance that ins-

pections be frequently and thoroughly made. Fig. 3 shows single-screen arrangements that have given good results.

A front-end arrangement designed to reduce in size the sparks or cinders, and also delay their delivery from the stack, is shown in Fig. 4, patents on which are held by the American Locomotive Company. On the western lines of one road a number of locomotives have been equipped with this device and it is stated that the sparks are reduced to such small size that they give no trouble. Some of the engines so equipped have been in service as long as four years and others for over two years, and during this time no fires have been set by sparks from them, although they are operated on the most dangerous divisions of the line.

Another front-end arrangement for sub-bituminous coal burners is shown in Fig. 5. This device was designed by one of the road engineers of a western road and has been used principally in locomotives burning coal from the Roundup, Mont., district. With this arrangement the sparks do not pass through any screens or netting, the success of the device depending rather upon the delayed delivery of the solid particles, thus allowing them time to cool down. A roughened plate of $\frac{1}{4}$ in. steel is attached to the regular baffle plate at the front flue sheet and this, together with the table plate, fastened to a flange on the upper end of the exhaust pipe, deflects the sparks and gases,

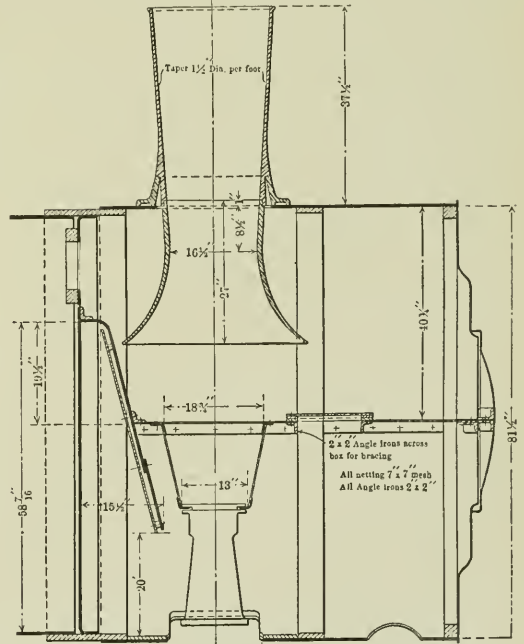

Fig. 3—Successful Front-End Arrangement for Burning Lignite.

causing them to pass to the front of the smokebox. A liner plate attached to the front-end door serves as another deflecting plate. From this point the paths of the sparks and gases are indicated by the direction lines and arrows. The top and bottom sides of the plate midway between the two petticoat pipes are faced with 4 x 4 mesh No. 8 netting, shaped as shown in the drawing. Sparks in passing between the housing surrounding the petticoat pipes and entering the latter strike these screens and are broken up into smaller particles before being discharged out of the stack. It is stated that this device will absolutely control the giving off of sparks, floaters or fires of any description.

In the following table are given some of the principal data and

results of road tests made by different railroads to determine the value of the lower grade fuels. The coals from Las Animas, Colorado, and from Buxton, Iowa, are bituminous coals; the others are classed as sub-bituminous, although most of them are probably referred to more or less frequently as lignites. So far as the writer knows none of these coals in question have the very high moisture content or the other identifying lignite characteristics such as those of the Williston, N. Dak., fuel, analysis of which is given in the previous table.

Gross Ton-Miles.	Number of Cars in Train.	Train Weight, Tons.	Coal Used, Pounds.	Water Used, Gallons.	Equip. Exp. f and a 2 1/2¢ F. per Lb. of Coal Fired.	Average Speed Miles per Hour.	Coal—source and grade.
86,594	11.67	632.0	24,916	14,724	5.95	29.65	Hannah, Wyo., Sub-Bit.
88,291	11.33	633.3	33,120	14,304	4.34	28.30	Erie, Colo., Sub-Bit.
213,149	51.66	1,888.9	42,360	27,255	6.47	17.15	Hannah, Wyo., Sub-Bit.
209,541	55.33	1,853.0	57,311	28,435	4.99	14.30	Erie, Colo., Sub-Bit.
.....	7.2	17,960	10,265	85.86	32.90	LaFayette, Colo., Sub-Bit.
.....	7.5	11,650	10,030	88.76	33.20	Las Animas, Colo., Bit.
161,117	34.0	1,445.0	17,749	11,900	6.83	Roundup, Mont., Sub-Bit.
145,011	34,034	19,575	23.1	Hudson, Wyo., Sub-Bit.
113,387	21.5	388.9	38,726	21,841	21.9	Hudson, Wyo., Sub-Bit.
136,387	20,845	13,428	23.8	Buxton, Iowa, Bit.

The results of these tests show that the better of these low-grade fuels can be used, and, in fact, they are today being used

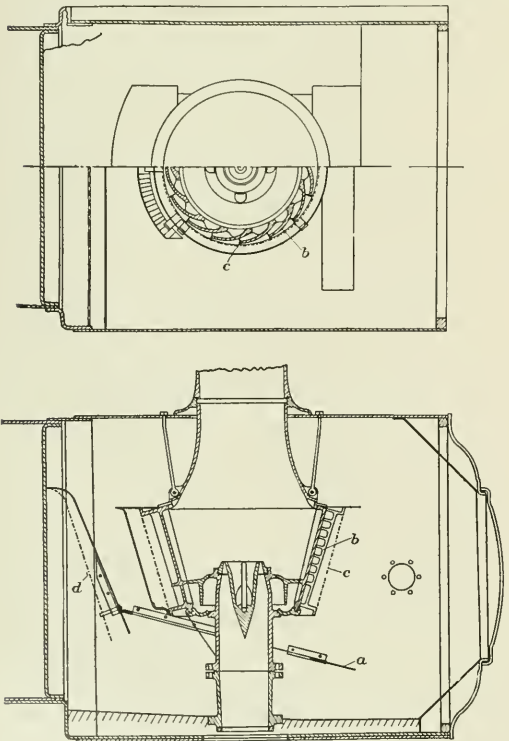

Fig. 4—Cyrus Spark Arrester; a Successful Front-End for Burning Lignite.

over those divisions of the roads where length of haul of bituminous coal makes it too expensive or otherwise inadvisable to use the latter fuel. The use of oil, however, has so many advantages that it will usually displace any solid fuel whenever

the cost of oil is low enough to keep the fuel item in operating expense near to what it would be with coal used on the road. This substitution of oil for coal has to a considerable extent taken place in the Wyoming territory since the development of the oil fields in that state.

As to the future use of these coals, there seems to be no question but that they will be used in increasing quantities. There is doubtless much to learn yet relative to the proper grate area to heating surface ratios that will give best results with different

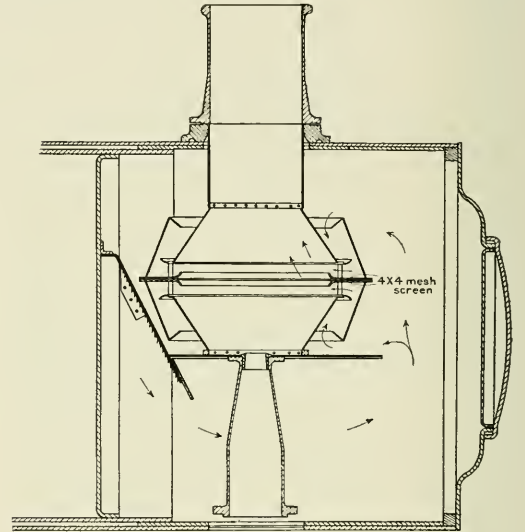

Fig. 5—Front-End Without Netting for Burning Lignite.

coals. Some of the lines which are today using this sub-bituminous fuel are using it on the same engines that at other times burn bituminous coal. It is possible that it may sometimes be found of sufficient advantage to build all the locomotives which are to be fired with the lower grade fuels with special reference to obtaining the best results from them.

The probability of a marked increase in the use of the true lignites in the near future is believed to be not great. The present undeveloped condition of the parts of the country in which the lignites are found, their low heating value, and the availability of the better sub-bituminous coals are all factors that will check the increased use of lignitic coals for steaming, and particularly for locomotive purposes.

Committee—Samuel B. Flagg, chairman; S. C. Graham, J. H. Grove and O. N. Terry.

DISCUSSION.

It appeared that the Chicago & North Western is not using brick arches on lignite burning locomotives and that the Chicago, Burlington & Quincy is using them in practically the same district. No explanation was forthcoming as to the reason for this variation in practice, except it was suggested that the C. & N. W. engines have a smaller ratio of cylinder volume to heating surface. On the basis of stationary boiler practice it seemed that the arch should be used with this form of fuel.

The possibility of briquetting lignitic coals was considered and appeared to be a future possibility. It developed that American-made briquetting machines were now available that would do as satisfactory work as the foreign machines. The trials of making lignite briquettes without a binder were reported as a failure.

The design of the grates to give plenty of air opening is an

important feature in burning lignite. The ash pans must be air tight at the bottom and the air openings in the side must be covered by a fine netting. The locomotives built especially for burning lignite on the Chicago & North Western have a grate 50 per cent. larger than normal. These worked well from the start as regards steaming, but threw many sparks. The application of the apparatus termed a gyrus, as illustrated in the report, cured the trouble. Twenty-one engines of this design are now in successful service.

CONSTRUCTION AND OPERATION OF A BITUMINOUS COAL MINE

J. A. Garcia, of the Allen & Garcia Company, Chicago, presented an extensive and interesting paper on the above subject. He pointed out that the natural conditions, both on the surface and under the ground, are different in each coal field, and that each requires special consideration. A year or more is required for the study and design of a new mine before it is actually under way, and the mine should be constructed in accordance with carefully prepared drawings made and approved by men skilled in both the technical and practical sides of coal mining. A coal mine should be built in accordance with plans and specifications in every particular, in the same way as a large commercial structure would be erected. It is common practice in the bituminous section to figure an average extraction of 1,000 tons per foot of vein per acre, which is approximately 56 per cent. of the coal in place. The author believes, however, that the extraction should reach 75 per cent., and he presented a table showing the percentage and the number of tons extracted per foot per acre for different thicknesses of coal veins. The more important provisions of the mining laws were mentioned, and each step in the construction of a modern coal mine was taken up in detail. Both photographic views and line drawings were freely used and costs were given wherever possible.

DISCUSSION.

Some of the factors causing the increase in the cost of bituminous coal were pointed out by the several members speaking on this subject. The ability and quality of the miners themselves was mentioned. Formerly miners were trained from childhood, but now untrained labor of all kinds has to be used. The Illinois mining laws were claimed to be the best in the country, but it appeared that the better the law the greater the expense to the coal operator. The value of the surface of the ground, which must be protected by leaving much of the coal in the mine, was another feature. It is impossible under present conditions for the operator to control the quality of coal loaded in the mine. He must take and pay for whatever the miners load. It was suggested that a law to make the miners a party to the conservation movement would be a good thing.

The value of the mine rescue campaign was indicated by the fact that there had not been an explosion in a mine in Illinois in over three years. This is largely due to educational methods and improvements in the arrangements in the mines. Further extension of the educational movement and attention to the social welfare of the miners was suggested by Mr. McAuliffe, general coal agent, St. Louis & San Francisco.

FIRING PRACTICE.

The report of the committee on this subject was taken up by sections and action taken on each as shown below. The committee consisted of D. C. Buell, chairman; T. E. Adams, W. C. Hayes and A. N. Wilsie.

FIRING TOOLS.

In each case the committee was requested to supply a drawing showing the recommended form of tools with its report next year.

Shovel.—A shovel holding from 14 to 15 lbs. of bituminous coal and with long or short handle, as suited to the fireman and conditions on the locomotive, was recommended.

Coal Pick.—A suitable coal pick, best suited to the requirements of the railroad, shall be provided.

Rakes.—There was considerable discussion on the advisability of supplying a rake on locomotives, but finally the committee's recommendation as given below was adopted: "It is poor practice to rake the fire. The committee hesitates to make a recommendation concerning rakes on locomotives for the purpose of raking fires, although it will probably be some time before firemen can be educated to a point where it will not be necessary to equip engines with some kind of a rake. The committee believes it pertinent to state that a good fireman does not need a rake and does not use one."

Slice Bars.—Length and size should be governed by the particular locomotive on which the slice bar is to be used, and according to whether the dump-grate is in the front or the back of the fire-box.

Shaker Bars.—The committee recommended a pin-connected removable bar where permanent bars could not be applied. The discussion developed that this was not the best design and the matter was referred back for further consideration by the committee.

Care of Firing Tools.—The association recommended that, where practicable, a place should be provided where each fireman can store, under lock, his firing tools, such as shovel, coal pick, etc.

Manipulation of Grates.—Should it be necessary to shake the grates at all they should be shaken only while the throttle is shut off, or while the engine is standing still, and then very lightly. With coal low in ash, and first-class management, it is not necessary to move the grates on the entire trip over the division.

Draft Appliances and Blower.—Careful attention to the tightness of the front end, the cleaning of the front end of cinders, the very moderate use of the blower, and care to prevent the fire burning down while on a side track and then turning on the blower, a practice which is sure to cause leaky flues, were the recommendations adopted.

Flues.—Flues should be kept clean and flue clinker should be knocked off the flue sheet whenever it forms. This is especially important on many types of superheater engines.

HAND FIRING.

Preparation of Coal.—The coal should be broken to firing size before being placed on the tank of the engine. If this is not done, all lumps larger than a man's fist should be broken by the fireman before firing. If necessary to wet down coal on account of dust, only enough water should be used to lay the dust. With very fine coal, better results can sometimes be obtained by wetting the coal enough to hold it together until it strikes the fire and cakes or cokes. The operation of mechanical coal-chutes should be watched, to see that the chute is not delivering all lumps to one engine and all slack to another.

Systems of Firing.—The recommendations of the committee were as follows: Instruct firemen to carry a light fire, a level fire, and a bright fire. Coal should be supplied to the fire in small quantities at frequent intervals. On the larger locomotives not over three or four medium-sized scoops per fire are required to produce the best results. The fire-door should be closed after each scoopful is fired. The coal should be spread on the fire to cover the bright spots, and only enough should be added to take care of the needs of the run.

There was some discussion on the advantage of closing the fire-door between each scoopful. The evidence, however, was most conclusive in favor of the practice. As an example that it was not an undue hardship on the fireman, the results of tests made for evidence before the board of arbitration on firemen's wages were quoted. These showed that the fireman was working on an average of but 25 per cent. of the time, on hard runs. Tests made on runs where the door was closed between each scoopful and another where it was not were reported. These

showed a saving of four or five tons on a trip of a freight train when the door was closed.

Grade of Coal.—As far as possible, coal of uniform quality should be supplied to engines, so that the firemen can familiarize themselves with the grade furnished, and regulate their firing to get the best results with that particular kind of coal. When various kinds of coal are being supplied the engines must be drafted to successfully burn the poorest grade.

Prevention of Smoke.—Careful firing and co-operation between engineer and fireman will prevent practically all smoke. Undue use of the blower should be avoided. Smoke-prevention devices are not necessary except under special conditions, such as on suburban engines, switch engines in terminal territory, etc.

Prevention of Clinkers.—Prevention of clinkers is best obtained by careful preparation of the fire before the trip, and by careful firing on the trip. The fire must be clean to start with. Banks should not be allowed to form in the fire, and the less the grates are shaken the less liability there is of forming clinkers. Hooking or raking a fire breeds clinkers in it. If clinkers start to form in the fire, moderate shaking of the grates with sharp, quick jerks has a tendency to break up the clinker formation.

Prevention of Popping.—Careful firing, and co-operation between the engineer and fireman, are required to prevent the engine from popping. With a light train, or on easy parts of a run, it is recommended that ten pounds less than the full boiler pressure be carried to avoid popping.

Prevention of Leaky Flues.—Careful firing is the best preventative. The fireman should understand the supreme importance of keeping a good fire up against the flue-sheet and of firing so carefully that there will be no danger of holes forming in the fire. The practice of letting fires die out on side-tracks should be discouraged.

Prevention of Engine Failures.—Have a clean boiler, clean flues, and clean fire. Have the engine properly drafted. Provide a fair grade of coal, and have the fireman trained to fire it according to correct principles. Under these conditions, co-operation between the engineer and fireman will prevent a large majority of the engine failures due to steam trouble.

MECHANICAL STOKING.

Preparation of Coal.—Specially prepared stoker coal, if required by the type of stoker in use, should be kept on hand so that it can be regularly furnished to engines equipped with stokers. This refers to coal broken to the proper size to be used by the stoker without crushing on the engine.

Manipulation of the Stoker.—The report made recommendations in connection with some difficulties that had developed in the handling of the underfeed type stoker. It was explained, however, that changes in the design had remedied the trouble and thus this section of the report was not accepted.

Keeping an Even Fire.—It was recommended that care be taken to maintain the adjustment of the stokers. One member reported that considerably less experience was required for a fireman to keep an even fire with a stoker than with hand firing.

Hand Firing.—The report made no definite recommendations on this point. One of the speakers told of a stoker that had been giving 100 per cent. firing for nine months.

EDUCATION OF FIREMEN.

Breaking in New Firemen.—A school for new firemen, conducted at a central point on each road, through which all men must pass before being assigned to regular work, is practicable, and the committee expects to see it largely in use in the near future. Pending this time it was recommended that new firemen be broken in personally by the traveling fireman, if there is such a man on the division; or, if not, by the road foreman of engines.

Traveling Firemen.—The report favored the use of traveling firemen who should be provided with counters to check the fuel consumption. Several members were opposed to having this grade, preferring to use traveling engineers for this purpose,

since they could be in full authority while on the locomotive. The combination of traveling firemen and traveling engineers working together had been most successful on some roads. The recommendations of the committee were carried.

Books and Pamphlets.—The committee recommended the progressive examination as a means of promoting study, the firemen being given their instruction books with the understanding that they will be examined after they have been in the service for a certain period.

Combustion Lectures.—The ordinary lectures on fuel economy are of value only when they are followed up by road supervision and instruction. This conclusion was adopted after some discussion.

Moving Pictures.—The report stated that experience on several roads that have used the moving-pictures and other illustrations on fuel economy has demonstrated this means to be the best devised for interesting firemen in this important subject. Astonishing results have been obtained and great interest manifested. The method is strongly recommended. This was accepted.

Waste of Coal.—Complete instructions to a fireman to prevent the waste of coal were included in the report. These included a number of features in addition to the direct manipulation of the fire itself. These were adopted.

The last section of the report included a discussion on the best methods of obtaining the fireman's co-operation to prevent waste of fuel. These were largely along the line of a proper appreciation of his responsibilities and a proper method of instruction at the beginning.

MODERN LOCOMOTIVE COALING STATION

A typical coaling station for the southern states would hardly fit the conditions of the climate of the northern states and Canada, but it is believed that there are certain prevailing and dominant factors that will have to be carefully considered for almost any local condition, and having this in mind, it would not be the thought nor the intention to consider climatic conditions as affecting the recommendations.

Wherever it can be accomplished without too great an expense, modern coaling stations should not be located at the large centers of population. In fact, it is believed that it will always prove economical to locate coaling stations away from terminals a distance equal to that which can be covered by one locomotive tank supply, and that no engines, except possibly one or two fast passenger engines, be coaled at the larger terminals. This conclusion is reached after carefully considering the delay and cost due to stopping passenger trains en route for coaling purposes, and also after giving due consideration to the desirability of having all of the motive power activities of a division consolidated under one general supervision. Like all other rules, this one has its exceptions. It would not be economical to so locate a coaling station, where the fuel was being delivered at the terminal in question, that it would mean dead haul of loads and empties for double the distance between the terminal and the coaling station. Grade conditions, density and directions of traffic, junction points and location of supply are all additional factors for careful consideration.

It is believed that the most elastic temporary or emergency coaling plant that can be established is the locomotive crane, and this is particularly so where property values are excessively high, and where it is desired to store an emergency supply on the ground from time to time. In fact, there are some who advocate this method of handling locomotive fuel at all points and under all conditions.

Answers to a circular sent to the members indicated a preference for the trestle type of station where there is sufficient room for the construction of the incline approach, but naturally the cost of property in the larger terminals would materially offset any advantage that might be claimed. Some favor this type

for large stations, handling 10,000 tons or more per month, and where not more than two tracks are to be served. Storage of coal with this type, except such as may be provided through the medium of the pockets and the road cars, is practically prohibitory, due to the additional initial cost.

The balanced bucket mechanical station was recommended in a majority of the replies for locations where the space is restricted and where two or more tracks are to be served. This type is particularly favored for large stations serving 50 or more locomotives, and, in fact, for any service calling for an issue of 100 or more tons of coal daily. As this type calls for the installation of considerable machinery, due care should be given its permanent location so that it will not be disturbed by future improvements.

The bucket conveyor type was favored by some for use at the larger stations where two or more tracks are to be used.

A number of members recommended the locomotive crane and clam-shell for the smaller stations, and for temporary use where the larger plant cannot be permanently located. This type is favored as being very flexible in its use in any class of road cars, and its adaptability to many purposes at any point on the railroad.

Wooden structures were favored for small plants and where they are isolated from other buildings and where first cost is an important element. Steel is recommended in preference to frame or concrete where fireproof construction is desirable, and where there is any possibility that the tracks may be altered at some future time, requiring the moving of the plant. All steel that comes in contact with the coal should be protected by concrete. Concrete is favored, where the cost is not prohibitive, for use in all mechanical plants that are permanently located.

A combination of frame, steel and reinforced concrete would appear to be economical and safe for the trestle type. The trestle approach should be of cross-timed timbers on concrete piers. Framing of supports under bins, hoppers and general structure to be of steel. Bins and any other parts coming in contact with the coal to be reinforced concrete slabs. The same general method of construction could be used for the other types, omitting the frame approaches.

In connection with the pocket capacity recommended for 24 hours' service for various numbers of locomotives from 10 to 200 the replies received were wide enough to cover almost any condition. The majority favored from 6 to 10 tons capacity to each locomotive handled.

An operator should not be required to look after more than one plant, particularly where he is required to secure the coal tickets from the enginemen; but it is believed that all of the work of hoisting coal should be so arranged that no night work need be required.

As a general rule the storage of coal is not recommended, except temporarily and locally overcome local or general failures of transportation, or mining, or on account of possible car shortage. The general objection was the deterioration of the heat values.

One reply favored storing a supply in summer for winter use for the following reasons: To have the equipment which would otherwise be in use in company coal service available for revenue coal service. It is economical to haul as much as possible in warm weather. To give the mine operators every opportunity to sell all commercial coal possible at the period when the highest prices are obtainable. To increase the operators' summer orders with the result that they can hold their miners through the summer, and be ready to put out a large winter tonnage. For economy of purchase, as summer storage coal could usually be purchased at a lower price than coal purchased under a contract with a maximum twice the minimum, and orders even running below the minimum in summer.

The proper elevating capacity per hour for pockets from 50 to 600 tons capacity appears to be that which will fill the pockets in about 5 hours. Replies on this feature varied widely and gave recommendations from one to ten hours to fill the pockets.

[Replies on the cost of operation and maintenance were quoted at some length in the report. They were not, however, in sufficient number or based on conditions that will permit a general or average cost to be obtained. The report to the next convention will tabulate this data.—Ed.]

Eight out of eighteen replies are opposed to any attempts to weigh coal to each locomotive, whereas six replies are in favor; three qualified replies have been received and are in the affirmative, if the weighing appliances are practicable and reliable, and records are kept and followed with each individual locomotive and each individual locomotive engineman.

It is the general recommendation to arbitrarily proportion any and all shrinkage losses to all locomotives in each class of service. One member recommends that no adjustment be made and that losses be prorated to the various classes of service by the auditor.

Opinions naturally differ, as much as the character of coal varies, but it is agreed that there must be more or less depreciation due to the coal passing through the handling plant, which can be corrected to a certain extent by breaking the fall through deflectors, spirals or by some other mechanical devices.

Considerable difficulty is experienced, due to coal becoming separated, lump coal from fine coal, resulting in the coal sticking in the pockets, or a poor distribution of coal to locomotives, although four of the replies would indicate none. Handling coal by buckets and belt conveyors appears to present the greatest difficulties.

It is recommended that the cut-off gates releasing the coal be opened full whenever a tank of coal is discharged. If bins and pockets are kept full, and coal is dumped directly over the outlets, much of the trouble will be obviated. It may sometimes be advisable to provide additional outlets with aprons to correct the matter.

The locomotive crane equipped with clam shell is not looked upon with favor as a competitor of the modern coaling station, and its use should be confined to temporary and emergency service only.

Committee—Hiram J. Slifer, chairman; E. A. Averill, E. E. Barrett, W. E. Dunham, G. W. Freeland, W. T. Krausch, and R. A. Ogle.

DISCUSSION.

Breakage of coal in passing through a mechanical coaling station was claimed to be a serious objection to that general type. Tests had shown an increase in the proportion of slack from 25 per cent. to over 60 per cent. after passing through a balanced bucket station. The trestle type of station was generally favored where there is room for its installation.

One member would guarantee a saving of 10 per cent. if he could have an accurate individual coal record. The Santa Fe is using many stations equipped with weighing hoppers with great success.

SCALING OF LOCOMOTIVE BOILERS

Statistics from the United States government experts on the cost of generating horse power in steam boilers show that to produce 100 horse power for 3,000 working hours, price of coal at \$1.50 per ton, and with absolutely clean flues and boiler, would cost \$1,269.99; with scale 1/16 in. thick, the same length of time, would mean \$1,459, an increase of 14.88 per cent.; with scale 1/4 in. thick, \$2,030, an increase of 59.84 per cent.; with scale 1/2 in. thick, \$3,173.50, an increase of 71.14 per cent.

We would expect a greater comparative increase in cost or heat loss resulting from varying thicknesses of scale. Instead, we find that with the 700 per cent. increase of the scale (from 1/16 in.) we have a 71 per cent. increase in cost only.

Dr. Joseph G. Rodgers has placed the conductivity of iron to that of boiler scale as 1 to 37.5. If this is so, and scale perfectly tight, the thickness of a boiler tube being 1/2 in., from the above figures it would cost approximately \$47,625 to generate the 100 horse power through the tubes, instead of \$1,649. Through the

firebox, the plates and scale each being $\frac{1}{2}$ in. thick, would cost the same, instead of \$3,173.50, as shown above.

While this is but a rough comparison the differences are startling enough to cause a question.

The amount of data available on the scale question is small indeed. In endeavoring to collect this important information it was found that railroads had nothing to offer. This indicates either that railroads are negligent or that the bugbear of scale, in some minds at least, is to a certain extent, imaginary.

It should not be understood that the committee believes no ill effects result from scale. There can be no doubt of a loss of heat. It, however, believes such loss is overestimated.

Say that a new engine goes on a run of 130 miles and consumes 12 tons of coal. If, after several months have elapsed and a scale $\frac{1}{16}$ in. has formed, according to the above data, it would require 13.8 tons to do the same work; or if a $\frac{1}{4}$ in. scale has formed it would require 19.2 tons. We do not know of any case where this difference in coal consumption has occurred, but $\frac{1}{4}$ in. boiler scale is common.

On account of the more general introduction of water tubes, it seems advisable at this time to call attention to the necessity for great care and that most rigid inspection to be given them. Convenient and accessible plugs should be supplied. Some competent employee should inspect these tubes after the boiler is washed, and before any of the plugs have been replaced. Inasmuch as these tubes are located in the hottest part of the firebox and the generation of steam is consequently rapid, failure of a badly scaled tube may be expected.

It is believed that the present arch tube is of a diameter too small to adequately take care of the steam generated therein, and it is recommended that the size be increased to an internal diameter of at least $3\frac{1}{2}$ in. This will mean a heavier tube and one stronger on account of the less ratio between diameter and length.

Careless boiler washing has considerable to do with a locomotive's performance. Some steps should be taken to provide a better class of labor for this work. The money usually paid is such that it is not attractive. On many roads it will be found that the boiler washer fails to remove all the plugs. Each plug should be removed and after the washing is completed the boiler should be carefully candled by an inspector.

This first step in the fight against scale can easily be taken by everyone. Scale forming ingredients can be removed from water. The ideal way is to treat the water in settling tanks so that it is commercially pure before its entrance into the boiler. This is expensive and in order to avoid the required outlay some roads use soda ash, the fireman throwing a predetermined amount into the tank each time water is taken. This is improper because the compound is sometimes added to a water already containing an excessive amount of the same ingredient and which is causing trouble from foaming. Too much or too little may be added, therefore each treatment should be chemically correct and the hit-or-miss method avoided wherever possible.

We are strongly of the opinion that pure amorphous graphite will be of material benefit to any boiler. It is purely mechanical in its action, will readily adhere to plates and tubes, and being adhered will prevent anything further sticking thereto. It has a tendency to act upon scale, already formed, by penetrating into the cracks and even into the scale itself. It will render such scale softer and will eventually cause it to fall away from the surfaces.

Committee—J. S. Sheafe, chairman; F. W. Foltz, F. A. Moreland, Harry Bentley, and W. T. Ray.

A supplement to the report gave an outline of the work soon to be undertaken by Henry Kreisinger, U. S. Bureau of Mines, in connection with experiments on the transmission of heat into steam boilers. This work will likely be the first extremely accurate testing done under such conditions as to permit accurate and indubitable determination of the harmful effects of scale and soot.

These investigations will consist of a large number of tests

made on specially designed horizontal multi-tubular boilers. The object of the investigations will be to study the laws governing heat transmission primarily, and to gather any incidental data as to the effect of scale and soot accurately. The first set of several hundred tests will be made with four horizontal multi-tubular boilers having lengths of five, ten, fifteen and twenty feet each. Each boiler will be equipped with several sizes of tubes successively ranging from three-quarters of an inch to four inches in internal diameter. Each of these boilers will be fed with gas heated by burning natural gas or petroleum, to various temperatures ranging from 1,000 to 2,250 degrees, in steps of 250 degrees Fahrenheit. It is planned at present to investigate the following factors: The effect of velocity of gas through tubes; the effect of initial temperature of gas; the effect of the steam pressure in the boiler; the effect of the different diameters of tubes; the effect of the different lengths of tubes; the effect of conductivity of the tube metal (both iron and copper tubes will be used at different times); the effect of scale on the water side of the tubes, and the effect of a coating of soot on the gas side of the tubes.

Drawings were included showing the arrangement of the apparatus to be used in these tests.

DISCUSSION.

It appeared that a decided loss of fuel could be attributed to boiler scale, and that there seemed to be little difference noticed in this respect with variation in the character of the deposit. Boiler compounds and graphite were reported to be successful in removing it, but care must be used in the use of the former, as cases of pitting had resulted from excessive amounts. The deposit of soot on the inside of the firebox and tubes was believed by some of the speakers to be of more harm than the scale. Where compounds or soda ash are used in comparatively large quantities, frequent blowing-down periods of short duration are good practice. Cases were reported where the blow-off cocks were opened from 3 to 5 seconds in every 1 to 3 miles. Larger arch tubes were favored by several of the speakers.

OTHER BUSINESS

Self-Propelled Cars.—An extensive report on this subject was presented and will be found in abstract in the Car Department section of this issue.

Election of Officers.—The following officers were elected for the ensuing year: President, R. Collett, superintendent locomotive fuel service, St. Louis & San Francisco; vice-presidents, D. B. Sebastian, fuel agent, Chicago, Rock Island & Pacific, and D. C. Bnell, chief of the educational bureau, Union Pacific. Executive members for two years: B. P. Philippe, coal agent, Pennsylvania Railroad; C. F. Ludington, chief fuel supervisor, Atchison, Topeka & Santa Fe; J. S. Sheafe, engineer of tests, Illinois Central, and F. F. Gaines, superintendent of motive power, Central of Georgia. For one year: E. McAuliffe, general coal agent, St. Louis & San Francisco, and W. H. Averell, superintendent, Staten Island Lines, Baltimore & Ohio.

THE SLIPPING OF BELTS.—Driving belts, states a contemporary, often undergo improper treatment. If they fail in their work by slipping over the pulley without driving it, what is usually resorted to is rosin, which is a good help for the time being but is sure to spoil the belt by making it rough and brittle. In a dusty room an emery like mixture is formed by the dust and the rosin which rubs away the belt.—*The Engineer.*

TURNING DRIVING BOX BRASSES ON A BORING MILL.—At the Norfolk & Western roundhouse at West Roanoke, Va., a boring mill is used for turning the box fit on driving box brasses. The brass is held in place by a semi-circular cast iron plate placed on top of it and held by a bolt and nut. By using the boring mill a brass may be quite readily set up and turned complete in the time which it would take to set it up in a lathe.

RAILWAY STOREKEEPERS' ASSOCIATION

Abstracts of the Papers and Outlines of the Discussions at the Tenth Annual Convention.

About 275 members registered at the tenth annual convention of the Railway Storekeepers' Association at the Hotel Sherman, Chicago, May 19-21. After prayer by Rev. William E. Barton, of Oak Park, President J. R. Mulroy, general storekeeper of the Pullman Company, called on E. Chamberlain, manager equipment clearing house, New York Central Lines, to address the meeting. Mr. Chamberlain drew attention to the growing importance of the storekeeper's position.

President Mulroy, in his address, drew attention to the past work of the association, stating that it had been of great benefit in raising the standard of the whole purchasing and supply department. He complimented the membership committee on its work, which had resulted in an increase of about 150 in the membership during the year.

G. G. Yeomans was called on to speak and presented some striking statistics on the value of the material held in stock on the railways. He urged the members to follow closely the recommendations of the association. If they did not agree with them, the floor of the convention is the place to voice their objections.

The secretary-treasurer's report showed that the membership was 744. The balance in the treasury is \$886.81.

The committee on piece-work reported that its investigation indicated the piece-work system to be the best and most efficient wherever the conditions permitted its use. One of the members in charge of a large creosoting plant stated that 90 per cent. of his force worked on piece-work, with a decrease of 25 to 40 per cent. in the operating cost. The men get high wages and he considers the highest paid man the cheapest for the company.

INACTIVE AND OBSOLETE STOCKS

BY E. J. ROTH, C. B. & Q.

All obsolete stocks are inactive, but of course all inactive stocks are not composed entirely of obsolete material. If they were, the proposition would be comparatively simple. It should pass without question that the thing to do with obsolete material is to scrap it and utilize the scrap to the best possible advantage. The loss due to the difference between the value of the scrap material and the manufactured product in many cases is small. Obsolete forgings can usually be worked over in a blacksmith shop into standard articles with a slight loss. The value of scrap brass is not much less than that of the manufactured product. The loss is greater, of course, in case of iron and steel castings and other similar articles, but even then there is nothing to be gained in carrying year after year as an asset, with resultant handling, interest charges, taxation, etc., material which cannot be used and which has a real and intrinsic value only as scrap.

In our experience the most effective remedies for reducing inactive stocks in storehouses and material yards have been:

First—Maintain stock books at all points where material is carried, whether this is directly in charge of a representative of the store department or of some other department.

Second—List all material of all kinds in the stock book.

Third—Carefully check the stock book to determine material that is surplus.

Fourth—Send with orders from division or district stores to the general storekeeper stock books or their copies and stock lists. Stock lists with a description of the material printed on them, containing information as to material on hand, due, ordered current year, ordered past year and surplus, if any, have seemed the better practice. This leaves the stock book in the hands of the stock man where it belongs, and the printing of

the description of the material on the stock lists insures the material being listed on all reports to the general storekeeper in the same order and facilitates checking them with the orders in the general storekeeper's office. One of the other large railroads in the middle west is putting into effect a plan which appears very efficient and economical. Their storekeeper's stock book is printed in duplicate, two sheets being placed together, which are exactly alike except that the bottom sheet has perforations separating the entries for each month. A carbon sheet is placed between the sheets when stock is taken and after all the information has been filled in, the carbon copy is torn off at the perforations. These carbon copies for material in each classification are sent to the office of the general storekeeper where they are pasted in a printed stock book, a duplicate of the one which the storekeepers have. The slips from each store are identified by classification and page number and placed in the general storekeeper's stock book next to corresponding slips from other stores opposite the items they cover. This gives the general storekeeper a complete stock book for the entire line with very little if any additional work.

Fifth—When making orders the storekeeper should consult frequently and freely with responsible officers in the departments using the material ordered for stock as well as for special work.

Sixth—Assemble surplus material as far as practical at the general or distributing store, where it is readily available for use at any point where needed, storing it with other material of similar kind so that it will be constantly before the stock man and may be used by him at every opportunity in filling orders—frequently by substitution, this always with the consent of the party ordering.

Seventh—Where surplus material is of such a character or conditions are such that it would entail unnecessary expense to move this to the general or distributing store, a special report to the general storekeeper or the general or distributing store of all such material with complete descriptions, etc., should be made.

Eighth—Advertise surplus material among the departments which might be able to use it. On this I wish to lay particular stress. We have found that with the knowledge which they get, from the periodical reports we make them, of engines, pumps, boilers, large pipe, second hand lumber, brick, track material, etc., etc., on hand, the engineering, operating, mechanical and bridge and building departments are frequently able to arrange their plans for work to use such material instead of purchasing new. The storekeeper must have a knowledge of the purpose for which such material was originally purchased or can best be used and bend his energies in directing toward it the attention of the men who order material for this particular kind of work.

Ninth—A surplus committee composed of practical men from the mechanical, engineering and store departments, periodically visits each storehouse and material yard, going over the stock in detail with the storekeeper and his stockmen, considering all surplus material of all kinds whether obsolete or not and authorizing scrapping of obsolete material or surplus material where, upon thorough investigation, this is found advisable. Where the character of the material is such that the difference between the value of scrap and the manufactured product is small, it is frequently found advisable to scrap material of which there is so large a surplus that there is no chance of it being used within a reasonable time.

Local representatives of the departments who use the material of the class being considered assist the surplus committee in its deliberations. These local men are usually foremen, who by their work with the committee, become more familiar with the storekeeper's stock than they otherwise would and are fre-

quently able to arrange for substitution and use up surplus material which would otherwise remain on hand indefinitely.

Possibly the most important feature of our present plan is that of working closely with the departments who use the material. This accounts for a great deal of what success we have had. The storekeeper who can keep closely enough informed as to market conditions affecting time of delivery of material, and so gage his estimates of future requirements that he will not order and receive more material than he actually requires, will not have to worry much about inactive stocks.

BY H. A. ANDERSON, PENNSYLVANIA.

In determining what amounts shall be reported as surplus, care must be exercised to consider the issues of preceding months, and in the case of "seasonal" material, to issues during a corresponding period of the previous season. In addition, it is also essential that consideration be given the amount of stock permitted to be carried on hand, and the length of time required in which to replenish the stock by requisitions on manufacturers. After deciding on surplus items, a list should be prepared and forwarded to the officer responsible, for the transfer of such material. This list should include, for each item reported, the quantity to be disposed of, complete description with pattern and tracing numbers and the unit price. In fact, on this list the information should be in the order, and as complete as would be required in the making of a requisition for the same item. The list should be checked by the purchasing agent, or general storekeeper, with all requisitions calling for the purchase of material.

These reports should also show the number of months each item has been so reported. This information would be the means for a ready reference to material that should receive special attention. For any material appearing on this list continuously for a period of twelve months, there would seem to be little need. While exceptions to this general rule would be noted, at the expiration of the twelve months' period each item so appearing should be separately considered, to determine the advisability of continuing to show it available for transfer or making final disposition of it.

Inactive and obsolete material is that for which there is no further demand. Its accumulation has been brought about chiefly through the release of equipment, changes in design and standards and to reclaiming from the scrap of items without regard to requirements. There is little that can be done in the case of this material, lacking authority or ability to disburse the old standards, until exhaustion of the stock, but to consign it to the scrap pile. The proper course would be to make disposition immediately upon the appearance of the inactive items. It has been found, however, that the mechanical and roadway departments are loath to take what they term hasty action in these cases, with the result that material is often continued in stock for an indefinite period.

Having considered the disposition of an item after being reported as surplus for twelve months, and deciding to prolong its existence, except where, during such period, there may have been call for the article, it is thought that such item should be discontinued on the surplus list and included on the list of inactive and obsolete material. This inactive list should contain the same information as the surplus list, except that the entire stock, as a rule, should be shown. It should be necessary that its listing among the inactive items be continued only three or four months before again being considered for final disposition. This last attention should be given jointly by the representatives of the operating and stores departments, and, lacking visible use for the material, it should be scrapped and the difference between the carrying and scrap values debited to the expense account to which the material would have been charged, had it been actually used. In so disposing of either surplus or inactive material, particularly on the larger systems, it is likely that a small quantity of more or less serviceable material will

be scrapped, but it is inconceivable that such seeming waste can total in money value the expense incurred by perpetuating the material in stock, considering the interest on investment and the clerical labor involved in handling and in monthly accounting for and reporting such items.

In connection with the lists which have been mentioned, it would be well to state that these would seem hardly necessary when the railroad is operating under the general storehouse plan. To such storehouses, we presume, would naturally be shipped all surplus and inactive material and the final disposition of it would be decided there. On a road which has no general storehouse these lists are essential, and we endeavor to scrap the material at the carrying point, except in the case of small outlying points, where knowledge of system requirements is, as a rule, very meager, in which case it seems well to have it returned to the distributing storehouse.

The question of endeavoring to dispose of material to the manufacturers from whom it was originally purchased has received careful attention, but the results in such cases have been so doubtful, considering the expense of packing and shipping, as to indicate that the interests of the railroad can best be served by handling the material as indicated above.

BY W. D. STOKES, ILLINOIS CENTRAL.

The first consideration would seem to be the establishment of some tangible system of interchange between stores, and in order to accomplish this result it is obvious that a knowledge must be had by all interested of the location and amount available. For the sake of rapid consumption, it has been the practice, to some extent, to make up at each division store, periodically, an itemized list of all surplus articles, sending one copy to each of the other stores and to the general store. From this, in lieu of ordering on the general store, requisitions are made between stores and prompt action obtained. In the event that requisitions for material of this nature are for amounts in excess of the surplus, and from more than one storekeeper, it is important that the ordering storekeeper be promptly notified in order that he may make such other arrangements as may be necessary. Where traveling storekeepers, inspectors of stores or other representatives of the department, in constant touch with local conditions, are employed, it is possible to make extensive transfers to advantage, and in this manner minimize the detail materially.

Another plan, apparently ideal for medium sized roads, is to so arrange requisition forms as to show, in addition to amounts on hand, due and ordered, the average monthly consumption and from these the general storekeeper issues what may be termed a general store back-order on division stores, to serve in lieu of orders on the purchasing agent. It would probably add to its efficiency to require stock books to be forwarded with the requisitions, partially as a check, but largely with a view toward having all amounts in surplus designated in the ordered column in red figures, as in this manner an idea could be obtained of all surplus, irrespective of whether appearing on the requisition or not.

An elaboration of the foregoing and possibly the most efficient of any, contemplates all items printed in stock books in order to insure uniformity of order and to have a surplus stock list printed in the same order, arranged to show the amount of surplus of all items, together with the average monthly consumptions and the amount on hand. This gives the general storekeeper an opportunity to size up the situation.

Semi-monthly lists of hard stock, material on hand for work deferred, and the principal items of heavy character on hand, will, if furnished the general storekeeper, oft-times result in movement, in lieu of purchases.

Whatever the method of imparting the information or of working out the details of this proposition, one thing is absolutely imperative, viz.: correct information regarding the amounts on hand and due, as without this precaution no hope can be entertained of intelligently coping with the situation.

Disposition of obsolete material, not contemplated in the foregoing, presents a less complicated problem and is dependent largely on decision, location and amount. By decision is meant the passing by competent operating authority on the items set aside or relieved. It is plainly the duty of the storekeeper to institute an insistent campaign looking toward the desired end, and thereafter the question is simply one of convenience of movement, as having been classified as other than obsolete it no longer can be considered in that light and must be dealt with as hard or slow moving stock.

BY H. STEPHENS, L. S. & M. S.

Mr. Stephens confined his remarks principally to the design and use of maintenance of way department material, and made some suggestions on the best way of handling it through the storehouse.

DISCUSSION.

A number of members spoke favoring, in a general way, the methods advocated by the authors of the papers. The forming of a committee to make recommendations on the disposition of inactive and obsolete stock was reported as being successful. In one case at least, including the chief draftsman on this committee had been an important factor in its success. Local foremen are generally called into consultation with the committee as it travels over the road.

EFFECT OF SPECIFICATIONS AND TESTING OF MATERIAL ON THE STOREKEEPERS' STOCK

BY W. DAVIDSON, ILLINOIS CENTRAL.

Ordering material by specifications will help a storekeeper's stock because the company will get full value for every dollar spent. Purchasing first class material will also bring about a saving in other ways than affecting the stock of the storekeeper. There is more to storekeeping than trying to reduce stock. It is expensive to apply inferior material to equipment. If a company buys material by specifications, in time it will reduce stock, as good material lasts longer and gives better results. The purchases will not be so heavy and when purchases are reduced, the stock will naturally show a decrease.

It is not necessary to make up specifications for all material, but only for such items as lumber, axles, wheels, tires, engine and staybolt iron; common, round and flat iron; brass, malleable, grey and steel castings; rubber goods; firebox, boiler and tank steel; paints, oils, frogs, switches, etc. All of the above material should be inspected at the point of shipment where practical and if not, the requisition should specify "To be inspected at destination." The manufacturer knowing that the material is going to be inspected and must be in accordance with specifications, will undoubtedly see that it meets the requirements. You can readily see that the company using this method of ordering material has an advantage over companies ordering material other than by specifications.

Material not ordered by specifications should be watched by the storekeeper and the department using it should report any inferior articles received. This would keep a check on the engineer of tests or inspector, or whomsoever the company has to inspect the material. The inspector should be required to go over the storekeeper's stock on hand with a view of catching material furnished that is inferior, reporting such articles to the storekeeper, so that he can return them to manufacturers. Ordering material by specifications saves considerable correspondence and relieves the storekeeper and purchasing agent of any criticism.

BY J. S. SHEAFE, ILLINOIS CENTRAL.

The test department should be separated from the purchasing and store departments. As the mechanical department uses the bulk of the stock carried, it is perhaps better for the inspection to come directly under such jurisdiction. Railroads for many years operated with material purchased without specifications

and with more or less indifferent inspection. The same could be done today, but the loss to a company would, without doubt, be more than enough to pay for the support of a testing department.

There are so many specifications now in existence that any road may have a complete set by merely copying what has already been printed. It is advisable, however, for each to make its own and to put in, whenever possible, something which will prevent the substitution of poorer material.

On the Illinois Central a specification is blocked out and several copies are sent to the purchasing agent, who submits one to each manufacturer for his criticism. It will always be found that this criticism is forthcoming and from the whole it is possible to fix the high limits of requirements to each of which two or three companies have agreed. If necessary, a revision can be made and again submitted. When finally in shape they are approved and printed and purchases are made to the standard requirements.

A specification should be more than a stereotyped form. It should be as strict as possible but with due regard to commercial practice.

The testing of material is simply the following out of carefully predetermined methods, together with a little judgment or common sense. The arbitrary rejection of a large quantity of material on a technicality should be frowned on, unless it is repeatedly evident that the manufacturer shows no disposition to improve his product, not to the grade the inspector may consider proper, but to that which the better class of his competitors maintain.

Although all chemical laboratory, and some physical laboratory work is more or less technical, yet the constant effort should be towards practical simplicity. Chemical laboratory results are of secondary importance, in many materials tested, to a practical performance or comparison. They are valuable more as a check or as a prophecy as to what the material will or will not accomplish in service. Methods of testing should be towards comparative results. While this is a slow process it is educational. As for the effect on stock of material inspection there is no reason for the store department to suffer any inconvenience in normal times.

BY F. H. HANSON, L. S. & M. S.

There are three predominating methods used in the purchase of material.

Some purchasers adopt the method of purchasing from the lowest bidder in the open market, entirely disregarding the matter of specifications as well as that of tests. Invariably this method involves great sacrifice of quality, which in itself represents loss in so far as the service obtained from the material is concerned, not considering the likelihood of accidents due to the existence of defects not detectable, except by test. This method has proved to be extravagant. While the first cost apparently is low, the subsequent outlay often totals to many times that paid for first class material and its resultant satisfactory service.

As an example; one gallon of pure No. 1 lard oil costs 46 cents, whereas a gallon of adulterated lard oil costs 40 cents. The adulterated product often consists of one-half pure No. 1 lard oil, costing 23 cents, and one-half gallon of refined petroleum at 7 cents, making the total cost of the adulterated oil 30 cents, or a loss of 10 cents to the purchaser, who thinks he is saving 6 cents on the first cost. The fact remains undisputed that the purchaser who does not inspect or test material bought in the open market very often receives material that has been rejected by the purchaser who does inspect or test, or who has his material furnished to specifications. Several months ago the writer observed a case in which a large number of castings were rejected by a railroad company's inspector, and the following day the same lot of castings was shipped to another railroad where no inspection was made. These, and innumerable other cases that might be cited, show the absolute necessity of furnishing

specifications; also, the testing and inspecting of the material.

The second method is that of purchasing only a few brands of material, of long established excellence and reliability. This method, while it is reasonably safe and invariably insures the purchase of good material, is frequently found to be expensive, for while the product might be first class, its cost is greatly in excess of that of material of less popularity, but which might withstand the necessary tests admirably.

The third method is the practice of purchasing on the basis of specifications and the testing and inspecting of all material. The specifications are merely definite statements concerning the kind and quality of material desired. This plan places all bidders on a fair and equal basis, and at the same time protects the manufacturer against unfair, discriminative and unwarranted complaints. He knows what is wanted and the specifications show him what will be accepted. This method of purchasing material is now so generally known and practiced that no supporting argument is necessary in its behalf. The only discussion pertinent to this plan is that treating of the extent to which the system should be carried, and of the details to be employed in its use.

While it is true that material should be of the proper quality at all times, yet the fact remains that certain definite tests and inspections might not always be necessary. Obviously, certain material on which depends the safety of the public and employees, should be regularly and thoroughly examined; likewise material especially liable to physical imperfections or subject to willful adulteration. Conditions, however, must be the governing factor, as at times certain material may demand extremely careful examination of each piece, while later conditions governing the manufacture and sale of a certain product might be improved so markedly as to render this rigid examination unnecessary. On the other hand, the opposite extreme might be true. Material at one time so reliable as to require but little inspection may, by reason of increasing scarcity of that particular commodity, price-cutting, or for other reasons, become adulterated, or embody other physical imperfections, and thus demand the most scrupulous inspection and test.

If material be inspected and tested at destination, then the purchaser must provide the necessary facilities for properly doing the work. On all large roads a laboratory is indispensable, and testing machines of the proper type are essential to the study of the material in service. Roads of medium proportions are but moderately equipped in this respect.

The question of cost, as in any other operation, should be given due consideration, and if the work be systematized, inspection on arrival will involve very little additional labor in the way of handling the material, as this is done while the material is being unloaded. If laboratory tests are to be made, the material should be so stocked as to preserve its identity, if this be necessary in connection with the contemplated tests. Often, however, all desired tests can be completed within a day, in which case the material might be left in the car until tests are completed. This practice is but seldom desirable as rejections occur so rarely that the item of cost incurred in reloading material is a factor so small as to be almost insignificant. If, on the other hand, conditions so shape themselves that rejections become frequent, the purchasing agent invariably withholds orders from the manufacturer furnishing unsatisfactory material and places them with concerns who will deliver the goods.

Careful consideration of all phases of the question of inspection, as it relates to cost, discloses the fact that inspection at the point of manufacture is from two to five times greater than inspection at destination, and this applies to nearly all classes of material.

An inspector at the purchaser's shops or storehouse is kept busy continually while on duty, whereas from actual experience we find that an inspector at the mill is busy not more than 50 per cent. of his time on duty. Coupled to this "dead-time" loss is that of the usual traveling and personal expenses of such inspector, amounting to from 75 per cent. to 100 per cent. of his

salary. Further than this, the inspector at the mill is alone and must be fully conversant with and experienced in every branch of the work he touches; he must meet the manufacturer's representatives (each expert in his particular line), and only a thoroughly competent man will be satisfactory. On the other hand, an inspector working in the purchaser's shops is constantly in touch with his superior officer, and, therefore, may be a less experienced and a cheaper employee.

The decision regarding "where to inspect," naturally, must be governed solely by the character of the material to be inspected. Heavy material that may be readily identified, may advantageously be inspected at the mill. For instance, car wheels have individual numbers cast on them, and the receiving storekeeper, by such numbers, can readily identify them as being the wheels inspected and accepted. Likewise, boiler plate, axles, steel castings, and other similar material may easily be stamped with the inspector's special mark, thus indicating acceptance. This scheme of marking, however, is not practicable in the case of small articles, such as rivets, bars of merchant iron, etc. Also, it is impracticable to make analyses outside of the laboratory, consequently it is desirable to inspect on arrival certain materials, such as oils, paints, pig and ingot metals, alloys and similar material that is tested chemically.

The railroads as a whole are beginning to realize the necessity of more uniformity in the drafting of specifications covering material and a considerable saving is sure to result. Recently the Master Car Builders' Association took steps to bring about a more logical arrangement in the matter of specifications, and a revision of its standards and specifications. Other organizations have taken similar action with this end in view, and an effort is being made to combine the railroads under one head as regards the inspection of various classes of material. In many ways the drift of present-day thought toward uniformity in this respect is apparent.

Heretofore the value of specifications has not been generally realized, but the time has come when a grand awakening to their value is in sight. More extensive use of specifications, more adequate and capable inspections and tests, and a building up of mechanical engineering forces are recommended, in order that railroads may avail themselves of the advantages thus offered, and protect themselves against the perils of using imperfect material, and at the same time form a basis of acceptance or rejection.

DISCUSSION.

Inspectors at outside points or an outside bureau of inspectors had been found to be very satisfactory in many instances. The New York Central Lines are considering the forming of a bureau of their own to be located at the principal points of supply to do inspecting for all its lines and also for other roads, if desired.

There was considerable discussion on the proper position of the engineer of tests in the organization. Some speakers believed that this officer should not report to the superintendent of motive power, others favored having him report to the storekeeper. A difference of opinion developed as to the proportion of the test department work that originated with or was returned to the mechanical department.

HANDLING OF ICE

Several papers were presented on the "Proper Method of Storage, Disbursement, Shrinkage and General Handling of Ice on Railroads." The statement was made in one of these that service buildings should be constructed to prevent shrinkage and should be sanitary. Two wheel sanitary cars, painted white, having tight covers, should be provided to handle ice from the service building to the trains. Refrigerator and cream cars should have the doors guarded with canvas curtains when working the car. Cold cars should be kept in continuous service and the use of warm cars prevented as much as possible. Ice for office use should be clean and handled promptly from the storage to the

cooler. The ice should not come in contact with the water, but be put in a separate container and the container put in the water.

In the discussion E. J. Roth, Chicago, Burlington & Quincy, reported that a yearly saving of \$50,000 had been made in the handling of ice on that railway since it had been in the storekeepers' department.

EFFECT OF STORES DEPARTMENT ON OPERATING COST

BY N. M. RICE, A. T. & S. F.

The effect of a well-organized store department on the operating cost of a railroad is far-reaching. In their organization the Santa Fe purchasing and stores departments are somewhat different from those of other railroads, in that the head of each reports to the same vice-president, and while to a certain extent each is a separate department in itself, yet at the same time the two departments work in accord; consequently the assistance given by either department to the other brings advantageous results not obtainable otherwise.

Primarily, purchases made of railroad material and supplies, governed by quality and controlled by competitive bids, as well as those items bought under contract, assist very materially in laying the foundation of an economic effect on the operating cost; however, should the effort stop here the surplus and consequent waste thereafter to be encountered would destroy entirely the results thus far obtained.

It is well known that a railroad operating under most favorable circumstances, in so far as management is concerned, will suffer, from a monetary standpoint, from gross errors made in over-estimates of material required in construction of renewals. Then again there is an expensive outlay to meet the demands of new conditions. To reduce the expensive effect of conditions such as these, the store department must keep in touch with the situation and handle through its channels the surplus and out of date material, giving credit to operating accounts, and then by application, by substitution, wherever possible, prevent expenditures proved unnecessary by the acceptance of the substitute. The sources from which reclaims can be made are numerous and embrace items ranging from large and expensive bridge timbers left on the right of way at some bridge to serviceable second-hand track spikes found in the scrap yard, and which when returned to the stock of the store department and the proper operating account receives credit therefor has its effect on reducing operating expenses.

In a great many cases even where full care and caution are used by the heads of the different branches of the operating or constructing department, in figuring estimates and in placing requisitions for material required for some specific work, changes made after the material is on the ground and charged to that particular work, will oftentimes result in several dollars' worth of material being left unused, which if not taken up and turned back to store stock for credit and used elsewhere, will necessarily stand charged to the work for which it was originally ordered, and even though at that particular time it is the intention, at some future date, to use this material in connection with similar work at some other point, the probabilities are when that time arrives, if ever, it will be found that deterioration will prevent, thus necessitating another supply of material and its consequent additional charge. Conditions, however, on the Santa Fe, under which the store department endeavors to make its system effective, practically demand the prompt return of this material to its jurisdiction, and there have been years when the value of material returned to stock, on the entire Santa Fe system, amounted to over \$2,250,000, or approximately 6 per cent. of the issues. In these figures, however, are included approximately \$420,000 worth of serviceable material reclaimed from scrap.

The mechanical working stock at terminals and shops embraces exactly the same features as the line stock, only it is conducted on a larger scale and carries with it the additional advantage of

being located in close proximity to the work for which it is required, thus dispensing with the necessity of mechanical department employees making long trips for material and thus securing their greater application to the work. This principle of handling is in universal practice on practically each and every item of material, the objective point being to prevent charges for material until actually required.

With the practice of issuing supplies and stationery from supply cars, which run monthly, the requisitions are made for thirty day needs only, instead of considering it necessary to carry on hand an extra 30 or 60 days stock for emergency, thus reducing charges to this class of operation, monthly, to a minimum.

One of the many economic effects on operation can be procured in systematizing the storing and distributing of oil. In the first place the cost of the oil is placed at the minimum, when proper storage has been provided therefor, by purchasing for delivery in tank cars. The use of steel tanks for storage and self-registering pumps for delivery eliminates the inevitable attendant loss, not including increase in purchase price, when bought in barrels and issued therefrom through faucets. Practical tests by competent engineers show losses, in the barrel and faucet method of handling, of from 5 to 25 per cent. on lubricating oils and on volatile oils the loss is much greater.

Another source from which the store department can always draw means with which to affect operation is the scrap yard. Each and every ton of scrap picked up on the right of way or at terminals and sent in to the central scrap yard is just that much reduction in charges to operating accounts, and the more care and diligence that are employed in sorting the scrap and in the reclaiming of serviceable material, just that much more benefit will accrue. Brass, of course, is the one item of scrap, which on account of its value, stands out clear and distinct as requiring more care, more diligence in following up, than any other single item. Monthly comparisons of receipts of scrap brass with purchases of new, as well as care in safe storing are essentials, which, if overlooked, play havoc with returns in this class of scrap. When one takes into consideration that the cost of new brass on the Santa Fe System for one year is between \$700,000 and \$750,000, while the value of scrap brass sold is approximately \$500,000, it is needless for me to add anything further to prove the effect on operation by this one item of scrap alone.

Reclamation and utilization of serviceable material taken from scrap has each year broadened and expanded until now practically no item which can be utilized to an advantage is placed on the market for sale. As mentioned heretofore, the value of serviceable material reclaimed from scrap approximates \$420,000 yearly, while the sale of scrap, restricted somewhat on account of unsatisfactory market prices, has averaged for the past two years \$1,250,000.

An arrangement is in effect on the Santa Fe whereby the store department periodically makes a check of way car equipment, and even though requisitions for this class of supplies are approved by trainmasters and superintendents, it is amazing in how short a time a surplus will accumulate. Just a short while ago a check of 32 cars resulted in the return to stock of \$2,291.94 worth of supplies not required, an average of \$71.62 per car. The return to stock of these items, of course, affects the operating cost of a railroad.

Fuel is the most expensive single item for which railroads pay and the one single item which can be made the greatest factor in handsome returns to operation. We have on the Santa Fe organized a branch of the store department, which gives its entire attention to this pursuit. If information procured on methods in use on other railroads in connection with handling fuel is correct, the system under which we are operating is decidedly more far-reaching than any other in existence.

It was not until June, 1908, that the store department assumed entire control of fuel handling. It is therefore necessary to use the twelve months following that date as a basis of comparison

for the three fiscal years, ending since June, 1909. While the decrease per ton mile since that time is fairly good, yet as this was the initial year in our efforts to reduce consumption, in view of the success secured since, it is apparent that the decrease from periods prior to June, 1908, for the years following 1909 is really greater than actually appears. The following is the result of the comparison of the fiscal year 1912, years 1910 and 1911 being not so good, but still a considerable decrease from 1909.

Ton miles	29	per cent. increase
Fuel consumed	16.2	per cent. increase
Fuel consumption per ton mile	9.7	per cent. decrease

Or in other words, the efficiency of a ton of coal was raised 9.7 per cent., which, when applied to a \$9,500,000 yearly fuel bill, shows the effect on operation in no uncertain terms.

In the face of this decrease, for the first eight months of the fiscal year 1913, due to more rigid supervision, there is a further reduction from the same months of 1912 of \$421,438.83. These figures take into consideration increase in purchase price of fuel and are based on the increased efficiency this year over last of a ton of fuel as compared with the increased cost to operation, had the efficiency of the fuel remained stationary or decreased.

BY H. C. PEARCE, SOUTHERN PACIFIC.

The real value of a well-organized and efficient supply department can only be determined by the final results of the operation of the property. Its service should be measured from day to day. The condition of the property under its control shows for itself. The investment is indicated by the balance sheet. The real economy which is effected will be best shown by the percentage of purchases to the issues over a period, with knowledge of conditions.

The supply department should be organized and operated to reduce purchases and not to increase them. The unit of price, unless service and need is considered, is a false one. The real unit is making the most of what you have and making everything give its full measure of usefulness and so handling and disposing of the salvage as to obtain every dollar there is in it, the ultimate purpose of it all being the net cost of materials and not the first cost.

It is to this department that we must look for savings in values, which are otherwise generally overlooked. The dollar is watched, checked and supervised. The same value in material hardly receives a thought. Our railroads must look to their supply departments to protect their materials to the same extent that they now look to their accounting and treasury departments for the protection of their dollars.

The first purpose of a supply department is to supply the needs of the railroad. It must be organized in such a way that what is best suited for the purpose can be laid down promptly at the time it is needed, at the least cost. The saving made by having an organization of this character can never be shown by statistics. It is represented only in the cost of the work.

Its second purpose is to market the salvage. With railroads having their own foundries and rolling mills, the railroad itself is its best customer and salvage should be handled in such a way as to apply it to the requirements of the railroad to the best advantage.

I will not attempt to go into detail as to how the salvage on our railroads should be handled, controlled and marketed. This matter was presented at last year's convention and in an article appearing in the *Railway Age Gazette*, issue of December 13, 1912. I wish to simply point out the one fact that the use and marketing of salvage is of second importance only to the providing and caring for the company's property.

The third purpose of a supply department is to handle its material with the least expense, always taking into consideration the first two principles, i. e., that it is necessary to provide and properly care for what you have.

The fourth purpose is to prevent deterioration and reduce interest on investment, deterioration for want of proper care and housing facilities, system, etc., changes in standards, changes in

plans, curtailment of forces, lack of proper facilities and lack of proper care. The losses here are enormous. An efficient organization should be such as to have perfect control and knowledge of every item on hand and on order and the organization should be so conducted as to reduce losses by deterioration, changes in plans, changes in equipment, etc., to the lowest possible basis. Interest on the investment is a big item and one which should be fully considered by any well-organized department, but this is one of the items which is exposed and the management can easily watch and protect this item, and, further, if the other purposes I have mentioned are taken care of, this item will take care of itself.

DISCUSSION.

F. D. Reed, Rock Island Lines, drew attention to the chance of loss through improper supervision or a swollen emergency stock. He favored a centralized storehouse and the handling of all material to be manufactured on the road, by the storekeeper.

G. G. Yeomans said that it is generally very difficult to arrive at a fair basis of comparison on which the value of a stores department could be determined. He, however, reported a case that he had investigated of a fair-sized road which had had no such department and each of the general departments was handling its own supplies and material. A stores department was organized and a comparison of five-year periods, before and after, gave a very good idea of its value. The average annual operating cost was reduced \$1,359,000. Meanwhile the number of locomotives was increased 9.3 per cent a year and the tractive effort 24.9 per cent. a year. The ton-miles increased 30.6 per cent. a year. The car mileage density increased 16.4 per cent. On the basis of purchases, the saving in operating cost directly due to the stores department was \$774,000. The cost of handling the material previous to the organization of the stores department was \$11,416 a month. The average of the same cost for the next five years was \$12,100 a month. This indicates that with an increased cost of \$700 a month a saving of over \$700,000 a year was made possible.

STANDARD SUPPLY CAR

BY D. D. CAIN, SOUTHERN PACIFIC.

The real purpose of the supply car is to deliver material where it is wanted on a specified time each month, and at the same time pick up all tools and other material not needed and make a monthly clean-up of all scrap on the division. To properly handle material with supply cars, the following will be needed on each division or district: An oil car with the required number of tanks for oil desired on the respective roads. This car should be equipped with hand pumps and with air pressure arrangement. The air is taken from the train pipe line through a reducing valve. A general car equipped with the necessary shelves for small miscellaneous material and supplies for all departments. This car should be arranged with space for sleeping accommodations for the attendants and a desk at which to transact the clerical business necessary. A car with the necessary racks for roadway tools, block signal supplies, large station supplies, and similar material. A car for case oils, gasoline, etc., where used. A car for stationery where delivered by supply cars. A car for spikes, track bolts, and track supplies.

It is economy to use steel under-frame cars for this service. To the above should be added the necessary cars for assembled jobs complete, also for hand cars, velocipedes, frogs, switches, track trimmings, etc., and, where treating plants are operated, lime, soda ash and distillate, and such flat cars as may be needed with side boards for scrap.

The first five cars should be equipped with end doors to enable the attendants to pass from one to another while the train is in motion for the purpose of assembling material for the next stop. These cars should also be equipped with electric lights, which can be installed at a cost of \$35 per car. We use a set of the same batteries that operate our block signals.

In practically all of our supply trains on eight divisions we use from twelve to as high as thirty cars, depending on the amount of business each month.

With a properly organized division and the supply cars in charge of a thoroughly competent division storekeeper, there is no need for requisitions being delayed by having the approval

of division engineers, roadmasters, section foremen, agents, signal maintainers, pumpers, trainmasters, yardmasters, etc., so that all tools, scrap, etc., may be ready for quick inspection and handling.

The supply car must always be accompanied by the division storekeeper and by the roadmaster and signal supervisor over

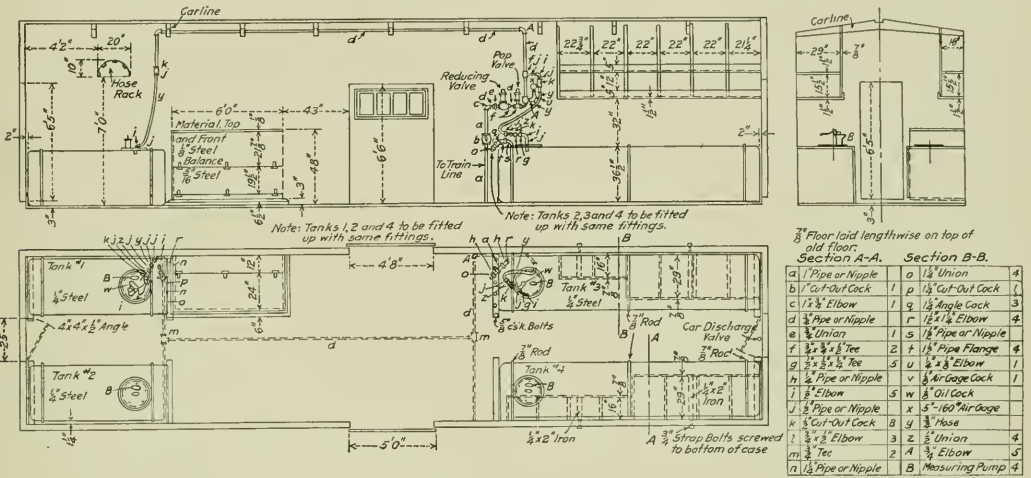

Floor Plan of Oil Supply Car Showing Air Unloading Arrangement and Racks Above Tanks; Southern Pacific.

of every officer on the division. These cars are built for action, and we are going to deliver what is needed and pick up everything that is not needed. Requisitions covering the estimated requirements for the ensuing thirty days are made by all departments and sent direct to the division storekeeper. These requisitions are stamped, "supply car," and turned over to the supply

their own respective districts in order to be properly handled and to get the best results. Stops must be made at each tool house and station. Tools and supplies required are checked between stations and made ready for quick delivery.

When the supply cars were first instituted on the Southern Pacific we ran them in local trains. We found by handling our

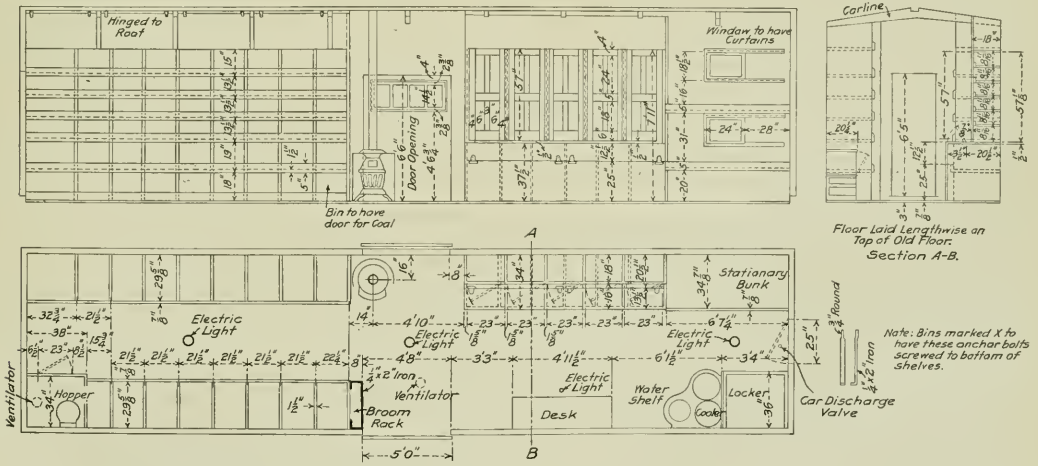

Standard General Supply Car—Southern Pacific.

car storekeeper and assistant, who draw off a summary of the material required and check it with the various section storekeepers.

Schedules showing the dates on which these cars move, train numbers, etc., are prepared in advance and placed in the hands

cars in locals the proper time could not be given unloading and picking up without seriously delaying the train. The superintendents have combined their own trips with ours. Thus, on practically all divisions we now have our supply trains run on a regular monthly schedule as an inspection train accompanied

by the superintendent, resident engineer, division storekeeper, roadmaster, etc.

In handling material with supply cars there is the following saving: No delays to trains on account of the train crews stopping at each point during the month to handle thousands of articles needed along the line. No waste labor in packing material. No labor expended in billing thousands of articles that are handled from the supply trains. No cars destroyed for shippers by having oil spilled in them. No billing or shipping back of empty containers to the store. No pilfering of material. No loss from breakage. No claims or correspondence regarding shortages.

One of the greatest advantages of the supply cars is the fact that we are able to carry out the exchange arrangement regarding station supplies, signal supplies, track tools and supplies. This can be accomplished in no other way.

BY L. O. GENEST, CANADIAN PACIFIC.

On the Canadian Pacific western lines eight cars are operated as separate units and patrol 7,500 miles at stated monthly intervals. They are equipped and directed by four divisional storekeepers with a storeman in charge of each car. Deliveries are confined to light supplies and tools such as are required for maintenance purposes for stations, sections, water supply, etc. Requisitions from each of the sixteen sub-divisions are sent to each of the respective divisional storekeepers not later than the twenty-second of the month for the following month's requirements, and are fastened separately in station order for each department and each section or branch, as the case may be, to enable a check to be made in the superintendent's office to insure receipt of all requisitions. The storeman in charge of the car wires the superintendent a day or so in advance stating the subdivision of his district the car will cover so that all concerned may be advised to have their oil cans and old material in readiness for the arrival of the car.

DISCUSSION.

The carrying of handy workmen on the supply train to do small work, such as fitting window glass, repairing locks and hinges, etc., on buildings and other structures along the road, had been found most satisfactory.

THE AUTHORIZED LIST

BY E. J. M'VEIGH, GRAND TRUNK.

The meaning of this is that we have on our railways a list of all the items of material we use; this list to be most carefully compiled, and finally approved by our president and his vice-presidents. This looks like a large order, and it is, but it can be done. This list establishes our standards as they have never before been established. It gives them the stamp of approval, and in getting it up our people will make such a study of the supply question as they have never made before in the history of railroading. With this list in working order each department will know what they can and should ask for. Each storekeeper will know what he can and should have in stock. Any departure from the list will be cause for inquiry. Each inquiry will help to guard our standards and prevent increasing our items. The increasing of our items means the increasing of our stocks on hand.

The association should appoint a committee to look into this question and report, and further, each member of the association should take the matter into careful consideration, and assist the committee by giving them the benefit of his views.

OTHER PAPERS, ETC.

Abstracts of several other papers which were read at the convention will be found in the Shop Practice section of this issue, including Rolling Mills at Scrap Docks, Standard Dry Lumber Shed, Standard Oil House, and Standard Casting Platforms. A paper was also presented on "The Importance of Conforming to

the Custom Regulations When Shipping Repair Parts for Cars Disabled on Canadian Lines."

The committee on the book of standard rules made a progress report and evidently have a most complete and valuable report in prospect.

Election of Officers—The following officers were elected: President, J. W. Gerber, general storekeeper, Southern; first vice-president, George C. Allen, general storekeeper, Chicago, Milwaukee & St. Paul; second vice-president, H. C. Pearce, general storekeeper, Southern Pacific; secretary-treasurer, J. P. Murphy, general storekeeper, Lake Shore & Michigan Southern.

STUMPF LOCOMOTIVE CYLINDER

A locomotive on the North Eastern Railway of England has been fitted with an arrangement of cylinders designed for using the uni-flow system of steam distribution. This was briefly explained in the discussion of the paper on "Factors in the Selection of Locomotives," presented at the Railway Session of the American Society of Mechanical Engineers last December. It consists chiefly of an arrangement of special valves, pistons and passages so as to avoid any return or backward motion of the steam after entering the cylinder. Its use requires cylinders of a length nearly equal to twice the stroke and with steam admission ports at either end in the ordinary manner and special exhaust ports at the center. The piston is a large hollow casting of a length practically equal to the stroke of the locomotive. The valve controls only the admission and point of cut-off of the steam and the exhaust is controlled by the piston which opens the exhaust passages at the center of the cylinder as it reaches the end of its stroke.

The construction of the cylinder as applied to the locomotive

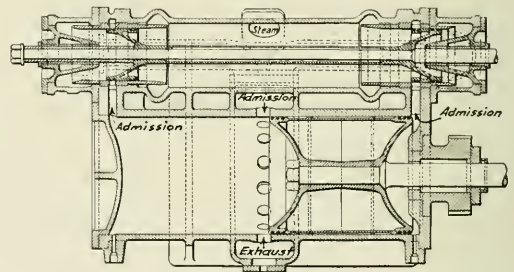

Cylinder and Valve Arranged for the Use of the Uni-flow System of Steam Distribution.

on the North Eastern Railway is shown in the illustration which is taken from the *Railway Gazette* of London.

Experiments on the continent with this type of locomotive have indicated that it possesses considerable economical advantage as regards steam consumption. In fact, it is claimed that it is superior to the usual superheater locomotive. This increase of economy is apparently due to the fact that the cylinder walls and the piston head are not cooled as much by the outgoing steam as when the steam is exhausted through the same passages through which it enters. Furthermore the exhaust passage can be made larger and the steam is released much more promptly.

When working at full stroke, as is the case in starting, the valves are so arranged that they add to the exhaust passage and allow a small portion of the steam to escape through the admission passages. This action, however, only takes place when working at practically full stroke.

STATION PLATFORM CHARGES IN ENGLAND.—The London & Northwestern now makes a charge of one penny for admission to train platforms at Waterloo Station, London.

SHOP PRACTICE

ROLLING MILLS AT SCRAP DOCKS

At the annual meeting of the Railway Storekeepers' Association, G. G. Allen of the Chicago, Milwaukee & St. Paul read a paper on "Rolling Mills at Railway Scrap Docks—Economy Effected," an abstract of which follows:

The C. M. & St. P., has, for many years, manufactured practically all of its freight cars and a large proportion of its locomotives, and one of the best methods we have found for employing the rolling mill is to select the scrap, old arch bars, rods, etc., shear them to the proper size, and roll them for special parts that enter into the construction of this new equipment, such as brake hangers, carry irons, brake jaws, bolts, etc., that are required in very large quantities.

Thousands of drift bolts for the bridge and building department are made from re-rolled iron, in fact comparatively little new iron is used for common bolts for any class of work.

The mill was located in the blacksmith shop chiefly for the reason that there was no room, nor were there facilities for doing this work on the scrap dock, and owing to the practice of utilizing the product of the mill for special purposes, a great deal of the iron is worked up in the same shop just as it comes from the mill, and the scrap from the shears, both from the original bar, as well as the cuttings from the finished bar, is used also, in the same shop, in the hammer furnaces. The blacksmith shop location under these conditions is a convenient one, but as a general proposition for roads that have modern scrap docks, equipped with power, hammers, shears, etc., and where the making of special parts is not the rule the scrap dock is unquestionably the proper location.

The billets used are from 12 to 24 in. long and the output of the machine varies from three to six tons per day, depending on the size of the material rolled. The total cost of operation is \$18.35 a day.

Various tests made from time to time have demonstrated the fact that the re-rolled iron is of good quality and usually superior to the ordinary grades of new iron, the improvement being due to the additional rolling.

In computing costs and figuring profits, we have endeavored to be conservative. Scrap has always been charged at higher than market prices and all legitimate items of expense added. The cost of re-rolling, not including value of scrap, is from \$3 to \$6 per ton according to size of iron rolled, and the profits will average \$10 per ton.

The net saving of a similar mill at the Burnside shop of the Illinois Central is reported to amount to well over \$12 per ton, everything considered except interest on the money invested and the steam consumption. There are no depreciation charges. The present average daily output is three and one-half tons. Cost for labor and fuel \$4 to \$4.75 per ton, and profits \$700 to \$900 per month.

The Chicago & North Western is also operating a mill of the C. M. & St. P. type at the Chicago shops, reducing 1½ in. and 1¼ in. round bars to ¾ in. and ¾ in. The daily output is one and one-half tons at a cost of about \$8 per ton. In addition they have ordered an Ajax three-roll mill, which will have a capacity of from 2 in. to 5½ in. It is the intention to operate both mills.

The Chesapeake & Ohio has an Ajax reclaiming roll on its scrap dock at Huntington, W. Va. The total cost of rolls, furnaces, oil tanks, shed, motor, etc., was in the neighborhood of \$12,000. The average daily output is three and one-half tons on which it is stated they are making a profit of \$1,100 per month.

The Southern Pacific Company is operating a rolling mill on the scrap dock at the Sacramento shops, with a maximum output

of 190 tons and average output of 90 tons per day. The total cost per ton including scrap is \$28.00, and the total profits are \$56,000 a year. This, however, would hardly be considered a re-rolling mill proposition, but a general rolling mill.

As the difference between the market price of new iron and the market price of scrap is not always maintained at the same level, the profits from the operation of re-rolling mills must necessarily vary. The greater this difference, the greater the profit, but with sufficient tonnage to keep a mill steadily employed and manned by a regular crew, the profits from such a mill as I have described, having a capacity of from three to six tons per day, should not, at any time, be less than \$10 per ton.

The question, therefore, of the economy to be effected by the installation of re-rolling mills at railroad scrap docks is one that each road can readily decide for itself, depending on whether or not it has sufficient accumulation of old material suitable for re-rolling, the present disposition of which is not bringing a return that will compare favorably with the above figures.

DISCUSSION.

W. O. Thompson described the arrangement and proposed operation of a large reclaiming shop that is soon to be built by one of the largest railways. The facilities to be provided are elaborate and well arranged.

A point was raised as to the advisability of using the rolling mills at scrap docks with billets and making new material direct. The consensus of opinion seemed to be that this would not be an economical practice. One member reported that \$960,000 worth of material had been reclaimed with a re-rolling mill at a total cost of about half the value of new material.

EXHAUST SYSTEMS FOR GRINDING WHEELS

The New York State Department of Labor has issued specifications for the design, construction and operation of exhaust systems for grinding, polishing and buffing wheels. These specifications were prepared by William Newell, mechanical engineer of the department of labor, and the more important items are as follows:

Minimum sizes of branch pipes allowed for different size emery or other grinding wheels are given in the accompanying table:

Diameter of wheels.	Maximum grinding surface, sq. in.	Minimum diameter of branch pipe in in.
6 in. or less, not over 1 in. thick.....	19	3
7 in. to 9 in. inclusive, not over 1½ in. thick.....	43	3½
10 in. to 16 in. inclusive, not over 2 in. thick.....	101	4
17 in. to 19 in. inclusive, not over 3 in. thick.....	180	4½
20 in. to 24 in. inclusive, not over 4 in. thick.....	302	5
25 in. to 30 in. inclusive, not over 5 in. thick.....	472	6

In case a wheel is thicker than given in this tabulation, or if a disc instead of a regular wheel is used, it must have a branch pipe no smaller than is called for by its grinding surface, as given.

Minimum sizes of branch pipes allowed for different size buffing, polishing, or rag wheels, as they are variously called, are given in the table.

Diameter of wheels.	Maximum grinding surface, sq. in.	Minimum diameter of branch pipes in in.
6 in. or less, not over 1 in. thick.....	19	3½
7 in. to 12 in. inclusive, not over 1½ in. thick.....	57	4
13 in. to 16 in. inclusive, not over 2 in. thick.....	101	4½
17 in. to 20 in. inclusive, not over 3 in. thick.....	189	5
21 in. to 24 in. inclusive, not over 4 in. thick.....	302	5½
25 in. to 40 in. inclusive, not over 5 in. thick.....	472	6½

The thickness given in this table for buffing wheels applies to the thickness of the wheel at the center. In case the wheel

is thicker than given in the table, it must have a branch pipe no smaller than is called for by its grinding surface.

Branch pipes must be not less than the sizes specified, throughout their entire length.

All branch pipes must enter the main suction duct at an angle not exceeding 45 deg., and must incline in the direction of the air flow at the junction with the main.

Branch pipes must not project into the main duct.

All laps in the piping must be made in the direction of the air flow.

All bends, turns, or elbows, whether in main or branch pipes, must be made with a radius in the throat at least equal to one and one-half times the diameter of the pipe on which they are connected.

The inlet of the fan or exhauster shall be at least 20 per cent. greater in area than the sum of the areas of all the branch pipes and such increase shall be carried proportionately throughout the entire length of the main suction duct, i. e., the area of the main at any point shall be at least 20 per cent. greater than the combined areas of the branch pipes entering it between such point and the tail end or dead end of the system. If such increase is made greater than 20 per cent. the area of the main at any point, except that portion of it between the branch entering it nearest the fan and the fan, shall bear approximately the same ratio to the combined areas of the branches preceding that point (i. e., between it and the tail end of the system) as the area of the main at the branch nearest the fan bears to the combined areas of all the branches. (This provision is made to permit the use of a fan having a larger inlet area than the area of the main at the branch pipe nearest to the fan, if desired.)

The area of the discharge pipe from the fan shall be as large or larger than the area of the fan inlet throughout its entire length.

The main trunk lines, both suction and discharge, shall be provided with suitable clean-out doors not over 10 ft. apart, and the end of the main suction duct shall be blanked off with a removable cap placed on the end.

Sufficient static suction head shall be maintained in each branch pipe within one foot of the hood to produce a difference of level of 2 in. of water between the two sides of a U-shaped tube. Test is to be made by placing one end of a rubber tube over a small hole made in the pipe, the other end of the tube being connected to one side of a U-shaped water gage. Test is to be made with all branch pipes open and unobstructed.

Plans for all exhaust system installations, showing location and sizes of all wheels, hoods, main and branch pipes, fan, and dust separator should be submitted to this department in duplicate for approval before work is begun, and it must be clearly specified that the system is to be installed in strict accordance with these specifications. The test specified positively must be obtained before the system will be acceptable to the Department of Labor.

The contract for the installation of an exhaust system should contain a provision to the effect that payment will be withheld until the above test shall have been made and the system accepted by this department.

In addition to the specifications, a number of recommendations are given from which the following quotations are taken:

Emery wheel and buffing wheel exhaust systems should be kept separate, owing to danger of sparks from the former setting fire to the lint dust from the latter, if both are drawn into the same suction main.

In the case of undershot wheels (i. e., the top of the wheel runs toward the operator) which is almost always the direction of rotation of both emery and buffing wheels, the main suction duct should be back of and below the wheels and as close to them as is practicable; or it should be fastened to the ceiling of the floor below, preferably the former. If behind the wheels, it should be not less than 6 in. above the floor at every point to

avoid possible charring of the floor in case of fire in the main duct and also to permit sweeping under it. For similar reasons it should be at least 6 in. below any ceiling it may run under.

Both the main suction and discharge pipes should be made as short and with as few bends as possible, to avoid loss by friction. If one or the other must be of considerable length, it is best to place the fan not far beyond where the nearest branch enters the large end of the main, as a long discharge main is a lesser evil than a long suction main.

Avoid any pockets or low places in ducts where dust might accumulate.

If there is a likelihood of a few additional wheels being installed in the future, it is advisable to leave a space for them between the fan and the first branch and to put in an extra size fan.

Branch pipes should enter the main on the top or sides; never at the bottom. Two branches should never enter a main directly opposite one another.

Each branch pipe should be equipped with a shut-off damper or blast-gate as it is also called, which may be closed, if desirable, when the wheel is not in use. Not more than 25 per cent. of such blast gates should be closed at one time; otherwise, the air velocity in the main duct may drop too low and let the dust accumulate on the bottom.

The use of a trap at the junction of the hood and branch pipe is good practice, provided it is cleaned out regularly and not allowed to fill up with dust. This will catch the heavier particles and so take some wear off the fan.

All bends, turns, or elbows, whether in main or branch pipes, should be made with a radius in the throat of twice the diameter of the pipe on which they are connected, wherever space permits.

Elbows should be made of metal one or two gages heavier than the pipe on which they are connected, as the wear on them is much greater.

ECCENTRIC BLADE BENDER

BY H. T. NOWELL,

General Foreman, Boston & Maine, Concord, N. H.

An eccentric blade bender made in one piece, and one that is easy to handle, is shown in the illustration. This does away with the old fashioned two-piece bender with the bar of iron and dog that required the services of two men. It is placed over the blade and two pins are placed in the 7/8 in. holes in the legs to hold it when the set screws are applied through the 1 in. threaded

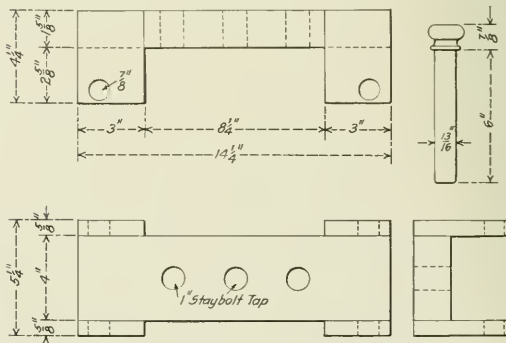

Tool for Bending Eccentric Blades.

holes in the top of the bar. There are three of these holes to allow for the proper application of the pressure. The set screws are made with a fine thread to prevent stripping. This bender has practically no spring or "come-back," and may be readily used in very restricted places.

DRY LUMBER SHED

Two papers on this subject were read at the annual meeting of the Railway Storekeepers' Association in May. J. W. Gerber of the Southern Railway said in part: The proposed shed is 32 ft. in width and of any desired length, in panels of 12 ft. each. Height from the ground line to plate is 16 ft. 5 in. The posts supporting the building are set on continuous concrete foundations which also serve to carry the stringers on which the lumber is piled. The building is divided into two stories, the lower floor having a clearance of 7 ft. 3 in., the upper floor, a clearance of 7 ft. The galleries on the second floor level are 4 ft. in width and run the entire length on either side of the building and are reached by stairways at both ends.

Both ends of the shed are enclosed, and the overhang is 7

entire room. The lumber could, under such conditions, be held ready for use, and need not be again taken to the kiln for drying.

The adoption of slate for a roofing material is to be highly recommended, not only because of the greater safety, but because of its economy.

LAYING OFF SHOES AND WEDGES

BY E. T. SPIDY,

Assistant General Locomotive Foreman, Canadian Pacific, Winnipeg, Man.

At the Winnipeg shops of the Canadian Pacific, the standard practice for lining up and laying off shoes and wedges requires the use of several special instruments. After the frame jaws are

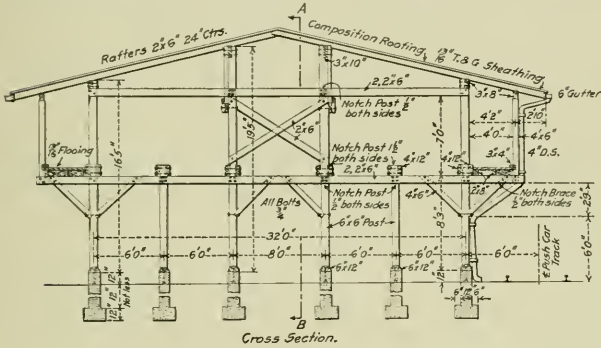

Proposed Arrangement of Dry Lumber Shed.

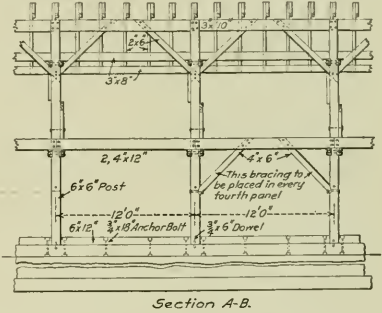

it., which, together with the galleries, which project 4 ft., gives ample protection from the weather.

Push car tracks are provided on either side of the shed, and outside of the push car tracks standard gage tracks are placed for the unloading of car lots of lumber.

W. E. Hatter, in his paper, said in part: In the erection of a dry lumber shed the most essential and primary feature to be considered is a scientific system of ventilation, which will permit of the drying and seasoning being thoroughly accomplished, without in any way endangering the quality of the material contained within the building.

This result can be brought about by using a mean between the solid sided building, and an open shed. A building of this type would be so constructed that a space of 2 1/2 in. would be left between the siding boards. They should be set at such an angle, however, that it would be impossible for either rain or snow to beat through, although it would always permit of a continuous circulation of air throughout the entire building.

The feature of next importance is that of an adequate lighting system. It is a fact generally understood, that without proper lighting, material is slow to season, and in a great many instances it becomes susceptible to such destructive elements as dry rot, mildew, etc. By the erection of a cupola or secondary roof, throughout the entire length of the building, the light would be permitted to permeate extensively through the building, which would aid materially the working facilities, and assist, as well, in the preservation of the material.

Particular stress must be placed upon the proper building of a special room, or series of rooms, in which kiln dried material may be stored, and where the conditions produced by the kiln will be retained. To properly procure this result, the room or rooms must be so constructed as to be entirely tight, permitting of a series of ventilating pipes on each side of the room, or rooms, by means of which an average temperature would be obtained, and the installation of two 2 in. steam pipes around the

squared up, the shoes and wedges, which are finished except for planing the faces, are put in place and supported by the pedestal binders. The spindle holder, shown in detail in Fig. 1, is inserted in the main pedestal, being located as near the center of

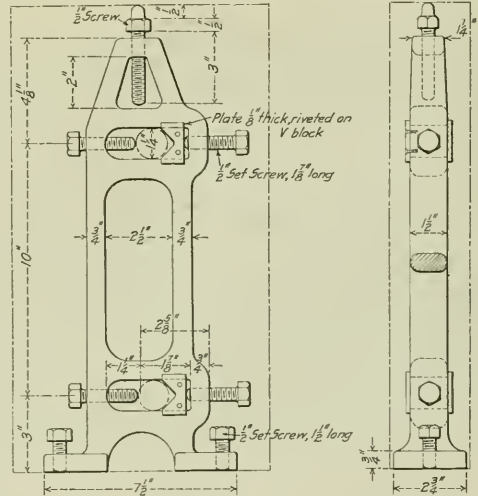

Fig. 1—Spindle Holder to be Clamped in Each Pedestal.

the jaws as possible. This rests on the pedestal binder and has set screws at the top and bottom by which it can be securely held in place. Two 1 1/4 in. diameter finished steel bars of the proper length to reach across the frames and extend a short distance be-

yond the spindle holders, are then inserted in the V-blocks in the holders, and the set screws on each side are adjusted to hold them. On the outside of the frame rail, directly over the center of the pedestal, a circle $1\frac{1}{4}$ in. in diameter is scribed. Two parallel blocks are then placed on top of the frame, about 12 in. apart, and a steel square, resting on the parallel blocks, is lined to the scribed circle. The position of the two steel spindles is then adjusted by means of the set screws until they touch the edge of the square, which places them in the exact center of the pedestal jaws and in a line perpendicular to the top of the frame. The other ends of the spindles are then set in the same manner.

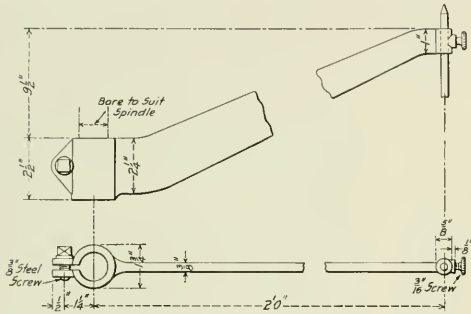

Fig. 2—Lining Up Arm Fitted on the Ends of the Spindles.

The line passing through the center of the cylinders and parallel with the frames is then put up on both sides of the locomotive. The lining up arm, Fig. 2, is placed on the projecting end of one of the spindles and is tried forward and backward for adjustment with the cylinder center line. If it is found that there is a variation, the spindles are adjusted to a position exactly perpendicular to the cylinder center line. This operation is performed for both the upper and lower spindles, and when completed for both sides insures the accuracy of their position or

reference to the main driver. The accuracy of this work is checked by means of the lining up arm on each of the other spindles.

The next operation requires the use of the instrument shown

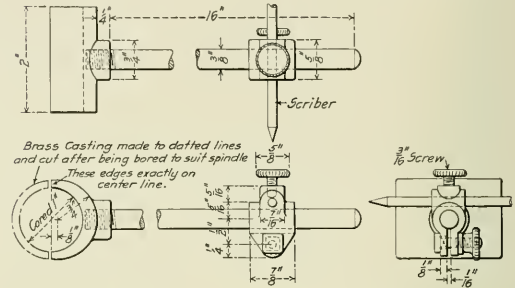

Fig. 3—Scribing Arm for Marking the Shoes and Wedges.

in Fig. 3, which is called a scribing arm. This is previously set so the distance from the center of the spindle to the marker will be 1 in. greater than the distance from the center of the driving

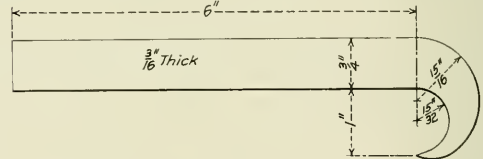

Fig. 4—Gage for Use When Facing the Shoes and Wedges.

box to the shoe or wedge face. It is then placed against each spindle in turn and the shoes and wedges are scribed on each side. The apparatus is then removed and the planer hand, in

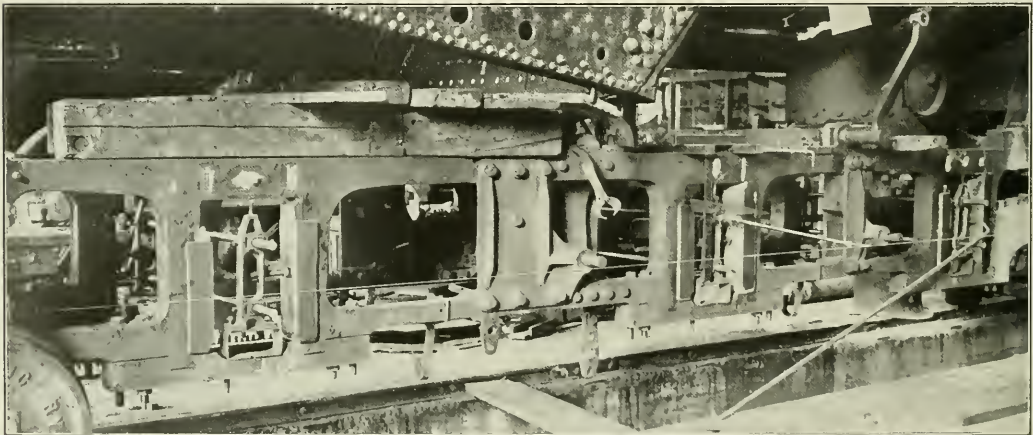

Fig. 5—Apparatus for Laying Off the Shoes and Wedges in Place on the Locomotive.

develops any inaccuracy in the setting of the cylinder center lines.

After the spindles are properly set for the main driver, other holders and spindles are inserted in the pedestals of the other drivers and standard trams are used to locate their position in

finishing the shoes and wedges, uses the gage shown in Fig. 4 for setting the machine to remove the proper amount of metal and to insure the squareness of the faces.

The whole apparatus is shown in place on the locomotive in Fig. 5.

MISCELLANEOUS SHOP KINKS

BY W. A. MCGEE

LOCOMOTIVE TIRE HEATER

A portable tire heater that is simple to operate and easily made is shown in Fig. 1. Gasolene is used for fuel, and it is driven from the tank under a pressure of 10 lbs. per sq. in. through a 1/4 in. pipe. The gasolene is mixed with air in a pipe that connects with the top of the tank, the air for the mixture being regulated by the valve A. The mixture passes through a check valve which prevents the possibility of a back

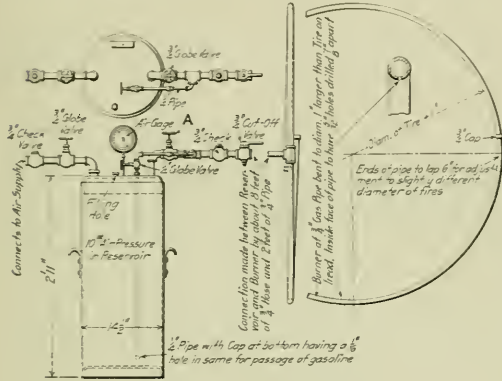

Fig. 1—Gasolene Tire Heater.

tire from the burner. The burner is made of a 3/4 in. gas pipe, which is bent to a diameter 1 in. larger than the diameter of the tire. An overlap of 6 in. is provided to allow for tires of slightly different diameters. The holes for the gas are 5/32 in. in diameter and are spaced 7/8 in. apart. Handles are pro-

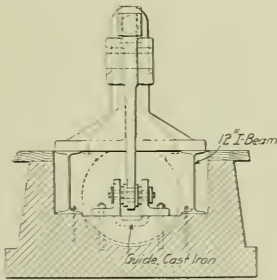

Fig. 2—Pneumatic Bulldozer for the Smith Shop.

vided on each side of the tank, so that it may be easily carried by two men. The flexible connection between the tank and the burner is made with about 8 ft. of 3/4 in. hose.

PNEUMATIC BULLDOZER.

A small bulldozer, such as is shown in Fig. 2, will be found valuable in the smith shop. It is operated from the shop air

system at a pressure of about 90 lbs., a 16 in. brake cylinder being used on a lever of 30 to 7, which will give a thrust on the plunger of approximately 98,000 lbs. The machine is simply constructed and may be easily made where there are ac-

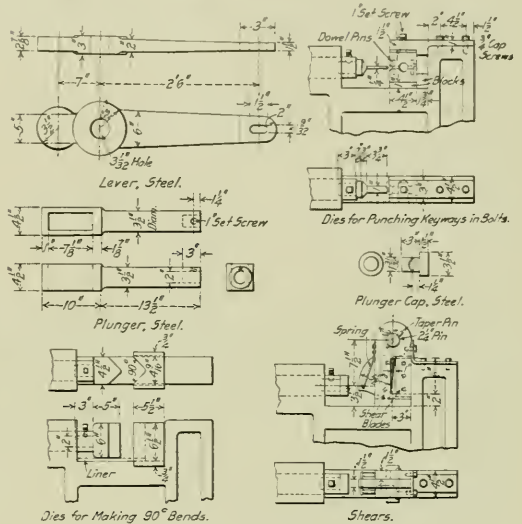
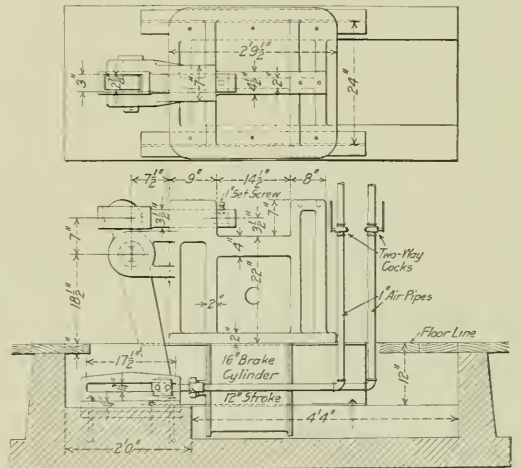

Fig. 3—Details of Pneumatic Bulldozer, with Some of the Dies Used.

commodations for making the body, which is a casting. In this particular instance the machine has found a variety of uses, such as for punching key slots in bolts, bending arch bars, body bolsters, step irons, etc., cutting iron and spring



steel, and compressing engine and tender springs while the bands are being put on or removed; a spring maker with a helper can put the bands on 10 large locomotive springs per hour with this machine. The dies for punching key slots are made in two parts, being held together by dowel pins. This machine will punch bolts up to 1 1/2 in. in diameter; they are of course heated, before punching. Fig. 3 clearly shows the

construction of a few of the dies used and the way in which they are applied to the machine.

OIL BURNER.

A crude oil burner made up almost entirely of standard gas pipe and fittings is shown in Fig. 4. It was designed for heating locomotive frames for welding, and has been found useful in other work. The oil is fed to the burner through a $\frac{3}{8}$ in. pipe, which is reduced to a $\frac{1}{8}$ in. pipe just before entering the mixer. The air is supplied through a $\frac{1}{2}$ in. pipe, which unites

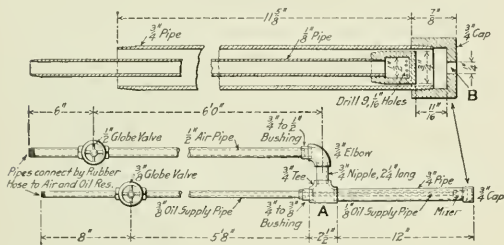

Fig. 4.—Burner for Crude Oil.

with the $\frac{3}{4}$ in. mixing pipe at the tee *A*. The $\frac{1}{8}$ in. oil pipe terminates in a blind nipple with nine $\frac{1}{16}$ in. holes drilled around its circumference. As the oil spurts from these holes it becomes mixed with the air and passes out through the hole *B*. By regulating the supply of both the oil and air a proper mixture may be obtained.

STANDARD OIL HOUSE

C. S. Doe, of the Santa Fe, presented a report on this subject before the recent meeting of the Railway Storekeepers' Association, from which the following is taken:

The Santa Fe has discarded the old time oil house maintained separate from the storehouse, which necessitated two extra employees, one each for the day and night, and instead a reinforced concrete basement has been adopted of sufficient size, according to the importance of the division point, to handle the illuminating and lubricating oils, varnishes, japs, greases, compounds, etc.

This oil basement is situated as far from the storehouse as is desired, the roof being a continuation of the storehouse concrete platform used for storage of castings and other material, the oil being drawn by the Bowser system of long distance pumps situated in one end of the storehouse. This places the issuing of oils with the store department employees the same as other materials and eliminates the employing of special oil house men.

The gasolene storage tank is placed in a pit separate from the oil basement, some distance from both the storehouse and the oil basement, and is also drawn at the storehouse with a Bowser long distance pump equipped with a series of safety check valves.

One of the most important features is the handling of oil from the general oil house to the division oil houses. To accomplish this successfully, about forty-five 10,500 gal. capacity system tank cars are especially assigned to the store department for service at the general oil house. All oils ordered from the oil companies are consigned to the general oil house and transferred to these assigned system tank cars, thus saving per diem or demurrage charges.

The state law compels us to have all cans and other receptacles for handling gasolene painted red. This promotes what on railroads is known as the safety habit, which is considered one of the first essentials of economy. Considering this an advantageous movement we have decided to adopt colors for other kinds of oils so that all employees will know at a glance what kind of oil is in a can, drum or any oil container and will also

recognize it as company material and handle it accordingly.

The colors adopted are as follows: Red for gasolene, white for mineral seal, yellow for signal oil, green for headlight oil and blue for lubricating oil. These assigned tank cars are also painted with a 24 in. stripe around each end of the tank in accordance with the above, and are stenciled for the kind of oil they are used for, boarded for store department service, and never used for any other oil unless released by our department.

All hose, pipes, valve connections and other fittings are also painted according to colors, and there is no chance of getting the oils mixed in taking a supply.

All tank cars are fitted with outlet connections exactly alike, as are all hose, pipes, connections and fittings at the division oil houses, so they do not require any special work in taking the supply, and a tank can be connected in a few minutes after being set for unloading.

These tank cars on leaving the general oil house under load are routed over the line making from five to ten points, according to the distance and the amount of oil required; they are then returned to the general oil house, reloaded, and again routed out for another trip, and are routed so each tank makes a trip about every thirty days; we have enough tanks to cover the entire road in this period. A weekly report is required giving the amounts of all oils on hand to the storekeeper in charge of the general oil house, and upon this information tank cars are handled accordingly.

Blue print calibration sheets are on file in the office of all division storehouses giving the number of gallons to every one-half inch, and as a tank car is handled at the division oil house, a report is made of the number of inches before and after taking a supply. This is a complete check and no point can take more oil than is covered by requisition.

The general oil house is of reinforced concrete throughout, including the roof, and no inflammable material is used in its construction. It has one story and a basement, and is 50 ft. wide x 160 ft. in length. The storage capacity for illuminating and lubricating oils is about 125,000 gal., and consists of a series of 10,000 gal. tanks. The storage for turpentine, varnish, japan, paints, linseed oil and similar materials consists of a battery of tanks erected in such a way that by the use of an air hoist and carrier, barrels can be raised to a track and run by gravity to any desired tank and emptied. The material is then drawn for shop use or shipment by the long distance, automatic measuring, pump system.

A sufficient space is partitioned off by a steel door where the heavy paste and compounds are kept in open stock for retail purposes; thus should fire be caused by spontaneous combustion, it will be confined to this steel compartment without danger to any other part of the building.

On the main floor are located thirty-two self measuring pumps, handling all kinds of oils from the storage tanks in the basement, except heavy paste and compound. Steel counters are used for waste and journal packing, while standard steel shelving is used for can paints and similar material. One side of this floor is used for storing of waste in bales and will be partitioned off with a fine screen wire to protect it from pieces of oily waste or anything which might cause fire.

Eleven power pumps are installed for the transferring, unloading and loading of tanks and supply cars, and for filling of drums and barrels for road shipments. These pumps have a capacity of from 8,000 to 10,000 gal. each an hour, and the maximum quantity of oil that can be transferred in a day is almost unlimited.

In connection with the facilities on this floor, attention is called to the indicating gages, in appearance similar to a steam or air gage, that register the amount of oil in the storage tanks in the basement at all times, and can be placed anywhere in the building, on the wall, or in the office, and show at a glance just what oil is on hand, thus saving the necessity of going to the basement to take measurements.

SANTA FE APPRENTICE INSTRUCTION

BY REUBEN T. PEABODY.

A few years ago the problem of where to get trained and able men for shops and factories had become a serious matter among mechanical men; every effort was made to obtain them, but few were available. Because of this condition existing on its lines, the Santa Fe established apprentice schools, first at the larger shops and then at the division points. In the beginning, these schools were experimental and in some respects crude, but the difficulties were overcome rapidly and the officers became convinced that they were solving the problem.

Under the old apprentice system a boy was taken into the shop, given a few tools and put to work by a busy foreman, who had no time to instruct him or to pay attention to his welfare. The boy was left largely to his own resources. Frequently some of the men in the shop ridiculed him and took pains to

him to accompany him with the foreman to the shop superintendent's office, and to bring with him a few of the finished packing rings. After examining the rings carefully and finding them slightly defective, the shop superintendent questioned the foreman and also the boy, and found that while both of them thought the rings were good enough, a bench hand who fitted them in the piston head was expected to square them up with a file, which took considerable time and should have been unnecessary. The lathe was equipped with proper chucks, tools and jigs, but the finished packing rings were not always faced square and sometimes were a little rough, because the apprentice boy did not know how to sharpen his tools properly. If he had been shown how to do this, he could have done more work and the rings would have required only a slight touching up with a file, thus saving several hours' time each month and making the boy a better workman.

The Santa Fe has developed a system of apprentice instruc-



Models Used in Connection with the Drawing Lessons.

make his work hard and to enjoy his mistakes. If he did not become discouraged and quit, when he had finished his four years' course he had learned what he had been able to observe, what the men had shown him, and what little his foreman had told him.

For example: an apprentice boy, turning and facing packing rings for air pump pistons, was turning out a large number each day and thought he was doing good work. One of the mechanical officers incidentally examined the rings and found them defective. He surprised the boy one morning, by asking

tion by which every movement of the boy is directed from the first hour he is in the shop, and, under able shop instructors he receives the help he needs from the beginning of his first day's work, continuing each day until he has finished his course.

Applicants for apprenticeship must pass a physical examination; be between 16 and 22 years of age, except in cases of special apprenticeship, when there is no maximum age limit; and preference is given to sons of employees. In addition to the physical examination a boy is examined and questioned closely by shop and school instructors as to his mental quali-

ficians and talent for the trade he desires to learn. After being admitted as an apprentice he is given six months to "make good," or prove his fitness.

The shop instructors are all practical mechanics, chosen care-

each detail of his work is best performed, and told why it should be performed in that particular way.

Every applicant for apprenticeship is supposed to have a common school education, but to encourage him in a desire for



Apprentice School Room at Topeka, Kan.—Atchison, Topeka & Santa Fe.

fully, and able to give instruction and to perform each detail operation in their departments. If it is a machine operation, the apprentice is shown how the work is held in place in the machine, how the cutting tools are sharpened and set in correct position, and how the machine is operated. He is shown how

additional knowledge, to broaden his mind and enable him the more easily to master his trade, schools of instruction have been established at all the principal shops and division points, and in addition to their shop training the boys attend school four hours each week. This may seem a very meager length



Apprentice Band at the Topeka Shops of the Santa Fe.

of time to allow for school room instruction, but as this time is devoted to the acquirement of the technical knowledge applicable to their trades, four hours a week of careful attention to study have been found to be sufficient to obtain the good results. School room instruction is given in railroad mechanical and free hand drawing and shop mathematics. The boys are taught the correct name and function of each part of locomotives, passenger and freight cars, how it is made, its shape or form. In this way they soon learn the uses of metals and the strength of materials. Every day during their apprenticeship they see in the shop practical illustrations of what they are learning in school. This is done to some extent in colleges; but it is not nearly so practical nor thorough, because here the boy realizes that every piece of work on which he is engaged will be put into actual use and must be done right. Before receiving his diploma as a graduate apprentice, he must pass a rigid examination covering practically every branch of his trade.

Both the shop and school room instructors must have unlimited patience; frequently it is necessary that they show and explain the same thing several times. They must also be enthusiastic about the work. It is this enthusiasm which the instructor instills that keeps up the fighting spirit of the boys and makes them determined to master the hard tasks. It is an inspiration to the boy, and, once acquired, he seldom loses it. The apprentice instructors have great opportunities to develop the character of the boy. No boy will be employed or retained who smokes cigarettes or uses intoxicating liquors. The Santa Fe wants men with steady nerves and clear brains, so it begins with the boys. While a thorough knowledge of his trade is necessary, if the boy is morally clean, is honest, truthful and loyal to his employer, if he has confidence in his ability and determination to do right, he will learn to do his work much better, and without question will be of more service to the company. Apprentice instructors have made excellent workmen out of boys that some foremen had discouraged and were ready to dismiss. By patient encouragement, the instructors gained their confidence and interested them in a determination to succeed.

The healthy amusements encouraged by the apprentice schools are of great benefit. Every year the boys have their local football and baseball teams, and play with each other in their own parks, provided by the road. Trips are often made to decide the championship between rival schools. This affords lively competition and real sport. The apprentice bands offer opportunity to the boys to acquire a considerable amount of musical skill under intelligent supervision. The road is taking cognizance of the fact that "all work and no play makes Jack a dull boy." It has come to realize that a boy is not a man, that he cannot be expected to stand all day under a steady grind, without the stimulus of school work and healthy, interesting and elevating recreation.

The Santa Fe officials have given the apprentice schools their endorsement, and have been interested in the development of the work. John Purcell, assistant to the vice-president, was the originator of the idea and has given the present school his help and loyal support. Years ago, while he was master mechanic, he organized a school for the instruction of apprentices in his shop, paying the instructor from his own pocket. It must be a source of gratification to him that seven of the boys who profited through his personal interest and generosity now occupy official positions in the mechanical department of the road.

Necessarily, such an organization as the Santa Fe apprenticeship system requires at its head a man who combines all the qualities enumerated, together with that quality of generalship and intense sympathy with the movement which is indispensable in bringing all its phases into strong co-ordination. Beginning at Topeka in 1907, Frank W. Thomas, supervisor of apprentices, organized and extended the apprentice school system until there are now thirty-four shops and roundhouses where apprentices

receive instruction under his supervision, and on February 28, 1913, there were 778 boys working at various shops and roundhouses; 223 of these were at the Topeka shops, the largest on the system. Mr. Thomas is a man who has the welfare of every boy at heart, and is constantly striving to devise new methods to improve his practical and theoretical education. The success of his efforts is proved by the large number of graduate apprentices who have become foremen and who have filled other positions more important than that of regular journeymen.

As a graduate apprentice of the Santa Fe apprentice system, and one who appreciates the benefits derived from it, I believe I am competent to say that the natural outcome of this training is a spirit of loyalty to the school and road that can be engendered in no other way. The value of the side issues is at once apparent when we consider that band and athletic practice and performances take up a large part of the boys' time outside of working hours, furnishing them companions of their own age and kind, with similar ambitions, and giving them less time to develop degrading habits and associations, all tending to supply the road with workmen, competent, highly trained and intelligent—the kind of men necessary to maintain the road on the highest plane.

STANDARD CASTING PLATFORMS

A paper on this subject was presented before the annual convention of the Railway Storekeepers' Association in May, by D. Kavanagh (C. R. I. & P.). An abstract follows:

It is desirable that the casting platform should be car floor height. In case it is not practical to have it at car floor height, there should at least be a small platform for loading and unloading cars that should be reached by a platform hoist. An elevator or hoist of this description is also very desirable when castings are stored on an elevated platform, as it is a good deal more economical than attempting to handle material to and from the shops on an inclined plane or runway.

The size of the casting platform should, of course, be governed by the volume of business that is being handled, and the space allowed for castings should be such that additional castings from new patterns can be accommodated.

The platform should be so arranged that sufficient space is allowed to pile castings of different pattern numbers separately. Each kind of castings should be located together and in numerical order of pattern numbers as far as possible; that is, all grates, piston heads, draw castings, steam pipes, etc., should be grouped separately, as this arrangement makes a neater looking casting platform and also is more economical in putting away castings or getting them out for shipment, and is in my estimation a better plan than attempting to group various castings together for any certain class of locomotives.

Finished castings should be kept under cover or out of the weather. A shed should be provided with the necessary racks to accommodate such material as cylinder packing rings, vibrating cups, etc., and the larger finished castings, such as cross-heads, piston heads, cylinder heads, etc., should be kept on the floor suitably arranged for convenient handling. The office of the casting platform foreman, or stockman, could be located in this building. The finished casting house should be heated, as this class of material deteriorates not alone in the open air, but also in the natural moisture of an unheated building. A hoist of some kind should be provided in all cases for handling heavy castings, such as locomotive cylinders, driving wheel centers, etc. The stock book records of castings should indicate the pigeon hole number in the particular rack, or the aisle number in which the castings are located. It is also very desirable that as much information as possible with reference to the particular use of each casting be shown in the stock books, indicating the particular class of locomotives on which it is used, the number of engines in the class, etc.

MASTER BOILER MAKERS' ASSOCIATION

Addresses and Abstracts of the Reports and the Discussions at the Seventh Annual Convention.

The seventh annual convention of the Master Boiler Makers' Association was opened at the Hotel Sherman, Chicago, on May 26, by President M. O'Connor, general foreman boiler maker, Chicago & North Western.

After prayer by John H. Smythe, the president called on W. L. Park, vice-president, Illinois Central, to address the meeting. Mr. Park confined his remarks largely to a discussion of the federal and state laws affecting railways, and particularly to those in connection with locomotives. It was pointed out that associations of the character of this one had a duty to perform in protecting the public from the passage of unfair and unjust legislation. He believed that while there is much to praise in some of the laws, particularly the boiler inspection law, they are not all impersonal, and some are even vicious. He advised the association to watch the proposed laws in its field, and by its activities give publicity to those which are inconsequential, unfair or intended for personal gain. He stated that there is little cause for criticism of the boiler inspection law or its enforcement, but the full crew laws are an outrage and the headlight laws are unnecessary.

John F. Ensign, chief boiler inspector, Interstate Commerce Commission, in an address, advocated that the master boiler makers have charge of all workmen making repairs to the boiler or its attachments. This to include the wash-out men, the machinists who repair or adjust safety valves, injectors, etc., as well as the boiler makers who caulk flues, put on patches or inspect the boiler. In reviewing the record of accidents as shown in the report of the department, it was pointed out that many of the causes could have been removed by a more careful inspection. Greater care in this respect was strongly urged on the members. As an example of the efficiency of the government inspectors in work which could as well have been done by the railroad inspectors, it was stated that during nine months over 4,000 locomotives were ordered out of service and not a single appeal was made to overrule the action of the inspectors.

President O'Connor in his address spoke strongly in favor of more attention to the welfare and education of apprentices.

Secretary and Treasurer's Report.—The total membership just before the convention was reported to be 313, but during the first day, 68 applications for membership were received. A balance of \$441.61 was shown by the treasurer's report.

At the opening of the second day's session, C. A. Seley, president of the American Flexible Bolt Company, and formerly chief mechanical engineer, Rock Island Lines, delivered a short address, confining his remarks largely to the subject of regulative legislation. The railways are the only corporations under government regulations that are not permitted to regulate the price of their product. He joined Mr. Park in urging the members to keep track of what their representatives in Congress are doing and to furnish them with information on subjects with which they can have had no experience and which may be under consideration for action at Washington or some of the state capitols. In this connection he disclaimed any intention of criticizing the boiler inspection law which, together with its manner of enforcement, he praised.

Mr. Seley extended a word of warning to the members in connection with the entertainment features of the convention, advising that care be taken that they should not become too elaborate and expensive.

LIMIT OF LENGTH OF TUBES WITHOUT A MIDWAY SUPPORT

The report of the committee was to the effect that 2 in. tubes, 22 ft. in length, had not proved higher in cost to maintain than shorter lengths. Tubes of longer lengths, to the limit

of 24 ft., were always 2½ in. in diameter and were provided with midway supports. The midway supports had proved a detriment in connection with removing the tubes. It is believed that 2 in. tubes up to 22 ft. in length do not require a midway support, but there is no proof available that such a support would not be of benefit. Experiments with a reinforcing sheet 8 in. from the back tube sheet, which held the tubes rigidly did not show any particular improvement in the durability of the joint or bead, but gave some advantages in other directions not mentioned. A 2 in. tube swedged to 1½ in. at the back tube sheet gives much better results than the larger tubes from a point of service and maintenance.

The report on this subject is signed by J. A. Doarnberger, chairman; E. E. Stillwell, T. J. Reddy, H. J. Raps and Martin Yale.

Discussion.—There was a general objection to the use of a midway support in the boilers due to the interference with the circulation, the difficulty of removing tubes if scale is present and the liability of the tubes being injured by vibration against the supporting plate. The general opinion was decidedly in favor of long tubes, and most of the speakers did not believe the tubes of present maximum length gave any increased trouble. A few, however, had found a greater tendency to leak with the longer tubes. This they believed to be due to the greater expansion rather than to vibration or sagging. A method of putting in flues where the tube sheets are forcibly drawn out for a distance of ½ in. before the tubes are rolled was mentioned. This forces the tubes to arch slightly when the boiler is cold. No improvement was mentioned by following this plan.

WEAK AND UNSAFE CONDITION OF BOILERS

Weakness and defect in the design, construction or workmanship, improper treatment, carelessness, neglect, or ignorance on the part of the boiler attendant; wasting from wear, tear and corrosion; over-pressure, worn out condition and overheating from lack of water; defective condition of safety valves and other mountings; exposure to conditions which cause development of defects, or a general deterioration of the boiler are the chief causes of boiler explosions. Contributory causes are in part due to rigidity of construction. This restrains the necessary movement of the parts under expansion and contraction, and may produce cracks, ripping of plates and leakage. Rigid staying neutralizes expansion and is very detrimental to the boiler. Improper disposition of the stays causes inequality in the distribution of strains, thus producing distortion, leaky seams, ruptured stays, cracks and ripping of the plates. Lack of provision for expansion is a frequent cause of trouble.

A well designed boiler should have every part of the same strength at all temperatures, and so placed that adjacent parts will expand and contract together under all conditions and will not work against each other. All material should be uniform throughout, strong enough to carry its individual load, but not so strong as to fail to give and exert an injurious force on any other member of the boiler.

A poor and careless workman may cause many defects. First, in allowing poor plates containing blisters and laminations to be used. Then by careless handling in the forge fires he may burn the material. Good metal may become burnt in flanging, bending and welding. The sheets may be scored along the seams by sharp calking tools. The rivets may be burnt or imperfectly upset, and other troubles may be brought about by poor work in the boiler shop.

Improperly made repairs with too strong or the wrong grade of material where the expansion and contraction of the patch

plate do not correspond with the old material of the boiler, may work great injury. Patching is a very important job, especially on the firebox and barrel.

Bad management is the chief source of boilers getting in a weak and unsafe condition. All troubles can be discovered before the danger line is reached by careful, painstaking and competent examinations. A well constructed boiler, properly repaired, with proper and frequent cleaning out may become weak and unsafe because it is not properly taken care of.

Committee.—E. W. Young, chairman, and J. H. King.

Discussion.—Careless workmanship in rolling the shell plates for boilers was mentioned as, in some cases, making the boiler weak before it went into service at all. This referred to the forming of the extreme edges where the butt joint is made.

That the proper procedure in case of a hot crown sheet is to put in feed water as rapidly as possible, at the same time deadening the fire by covering it with fresh coal, was explained to some of the members who still held the exploded theory of the rapid flashing into steam of cold water on a hot sheet and a large increase in the pressure.

WELDING SUPERHEATER TUBES

All safe ending should be done at the firebox end. This is brought about by the necessity of always having good and new material at that location. It is the opinion of some of the committee that there should not be more than one weld in these flues at any time.

To apply the safe end at the firebox end, it will be necessary to cut the flue as close to the front flue sheet as possible to avoid waste of the body flue, and reduce the necessity of applying long safe ends. The average life of a body flue of this dimension, in this particular service, would not exceed four safe endings. The average flue welding machines are built so they can weld a safe end 14½ in. long. This can be done by first welding on a 5 in. piece, second an 8 in. piece, third an 11 in. piece and fourth a 14 in. piece. At the expiration of this time the body flue will be about worn out. To do this it will be necessary to cut the flue close to the front flue sheet, as well as close to the old weld in the back end. In repairing in this manner there is always a new safe end at the firebox end, as well as a flue with only one weld.

The best tools for welding these flues is a debatable question. In many localities the dimensions of old welding machines, regardless of type, have been increased, and it is claimed that satisfactory results are being obtained. At some places a welding machine is used that revolves around the flue. This is reported to be successful, but some objections to it have been raised.

The question as to whether the flue should revolve on the roller in the machine, or the machine around the flue, develops a difference of opinion. To revolve the flue around on the roller requires some time for the flue to travel the distance and, being of very light material, it is likely to become cooled before the entire weld is made. It also requires more power and labor to operate and weld the flues successfully with a machine of this type.

With a machine that revolves around the flue the weld is made much quicker and with less power and labor, but this machine also has its faults. First, it is claimed that it does not make a smooth job on the inside, but leaves an obstruction in the flue that is likely to cause it to clog rapidly. This is a serious objection, as it is necessary to have these flues clean at all times. It is also claimed that it is hard to weld the safe end on these large flues and keep them straight with this type of machine.

Committee.—B. F. Sarver, chairman; J. J. Orr and J. P. Malley.

Discussion.—No especial trouble was reported by any of the members in the successful welding of the large flues. The revolving rollers were generally favored in preference to revolving

the flue while welding. The possibility of chilling the metal to be welded by the cold mandrel on the inside was mentioned. Flues are generally being safe ended at the back or small end. At some shops either end is welded as seems desirable.

EFFECT OF SUPERHEATERS ON THE LIFE OF FIREBOXES AND FLUES

The committee is unable to find any well founded claim to show that superheating of steam has a detrimental effect on the fireboxes or flues, but, to the contrary, it is shown that the life of these parts is prolonged considerably, from the fact that where steam is superheated the working pressure is generally reduced. However, there are many large engines carrying 200 lbs. working pressure with superheaters that show no ill effect on the fireboxes or flues.

Committee.—C. L. Hempel, chairman; H. M. Newgirk, E. E. Rapp, P. J. O'Malley and P. E. Cosgrove.

Discussion.—Owing to the usual decrease in pressure on superheater locomotives and the smaller amount of water evaporated, it was generally believed that the use of superheaters increased the life of the firebox and tubes. The dampers have given considerable trouble in connection with proper maintenance, and it was suggested that they be eliminated. It was explained, however, that this was not practical and that the only railway that had taken them off was again using them. Welding the back end of the flues was being successfully accomplished at some shops. A life of three years was indicated for the joint with this method of fastening.

MR. QUAYLE'S ADDRESS.

At the opening of the third session, Robert Quayle, superintendent of motive power and machinery, Chicago & North Western, addressed the meeting. He urged each man to take his share in the activities of the meeting in order that all may get the greatest benefit. A boilermaker should be familiar with chemical and physical properties of the materials he is using. In his opinion, punches would soon be taken out of boiler shops for use on boiler plates. Greater care must be used in laying out and forming the sheets and no material with the slightest defect should be used.

The boiler inspection law has been most helpful and has made for improved conditions. The inspectors generally were believed to be most efficient and, especially, if met in the proper spirit, were anxious to cause as little inconvenience as possible. Fair dealing with the federal inspectors was strongly urged by the speaker.

MR. MCNAMANY'S ADDRESS.

Frank McNamany, assistant chief inspector, Interstate Commerce Commission, was invited to address the members and spoke briefly on the subject of federal laws as applied to rolling stock. It was pointed out that, in each case, the law did not go beyond accepted good practice, but selected the best practice in use and forced its general use.

OXY-ACETYLENE AND ELECTRIC WELDING

The committee reported general success with the oxy-acetylene method of welding and cutting with the exception of vertical seams in the firebox. This difficulty is being overcome by the use of round or oval patches. The cutting and welding of superheater pipes at the bends, in place of using castings at these points was reported to be a successful practice at some shops. Electric welding is also successful, but the inability to cut with this system is an objection. Electrically welding flues in the flue sheets was mentioned.

Discussion.—Electric welding has been most successful on the Erie. There are eight machines in operation on the eastern lines and 60 per cent. of the work is on boilers. It was stated that cracks of all kinds can be welded. It is the practice to heat up the plate by means of steam on the inside of the boiler before beginning operations. The opening to be filled with

welding material must be extended clear through the sheet and leave an open space at the bottom. The weld is carried to a thickness $\frac{3}{8}$ -in. greater than the sheet. It is very important that the welding material be hammered while hot and the more promptly this is done the better the results. There are now over thirty full sets of tubes welded to the tube sheets in service on this road, in addition to many partial sets. The method followed in this operation is to set the copper ferrule $\frac{1}{32}$ -in. back from the edge of the sheet, roll it, insert the tube, having it project $\frac{3}{16}$ -in. beyond the sheet ($\frac{1}{4}$ -in. in the case of superheater tubes), roll lightly, prosser and then weld around the extension and to the sheet. After the welding is finished the work is smoothed off by a special tool and gone over lightly with a beading tool. Button head crown stays are also being welded when they become loose. Eight tubes or crown stays can be welded in an hour. The necessity of having all parts to be welded thoroughly clean was impressed on those who had not had experience with this process. The voltage and amperage must be varied to suit the condition of the work.

Both the oxy-acetylene and electric welding outfits are necessary for the best results, according to a number of the speakers. Each has its advantages and disadvantages on different classes of work. One speaker had had no success with welding cracks at the edges of the sheets, particularly those in the fire door flange. A complete ring was inserted around the door and gave good results. In welding patches on the side sheets with oxy-acetylene it appears that the longitudinal seams are generally satisfactory but the vertical seams usually fail after two or three months. Round or oval patches are satisfactory however. The advisability of welding cracks, according to this member, depended on the length of time before the engine would go to the shop. Frequently such repairs were made in order to keep the engine in service, although it was not believed they were permanent. Welding of flues is not advisable in bad water districts on account of the increased difficulty in removing them at frequent intervals.

It was stated that the federal inspectors would not permit the welding of staybolts.

It was also stated that there was no danger or inconvenience to the other workmen on a locomotive on which electric welding was being done.

BEST FORM OF GRATES

C. J. Murray, Chicago & North Western, chairman of the committee, reported on grates for burning lignite. These are a rocking table grate which is identical with the former types of wood grates and is similar to grates used on some roads for burning hard coal.

F. D. Timms, a member of the committee, favored finger grates with the fingers 6 in. in length and with dump grates at the back of the firebox, for burning bituminous coal.

Discussion.—The type of grate in use on the Chicago, Burlington & Quincy was described. This consists of a series of table grates, each of which includes a rocking finger grate. There are no dead grates and the fire is dumped by tilting the table grates, together with the finger grates. In this way the fire is emptied without opening the fire-door or turning on the blower, thus preventing a heavy draft of cold air through the tubes.

BENEFIT DERIVED FROM TREATING FEED WATER

The practice of treating feed water is not general; it is used by a number of railroads, particularly where water conditions are bad. The usual treatment consists of mixing a solution of soda ash and lime, the relative proportions having been determined by chemists.

Water is treated to prevent the formation of scale and foaming. Reports indicate good results from use of soda ash and caustic soda. There is some difference of opinion as to benefits derived from treated water as a preventive of corrosion. One member reports the use of a polarized metallic preparation,

applied direct to the boilers in bars distributed over the crown sheet and tubes before closing the boiler and after each washout. This produces an effect more mechanical than chemical; it has an affinity for the material the boiler is made of and forms an amalgam over the boiler plates and tubes which prevents scale forming, also in the case of dirty or scaly boiler the fissures in the scale render it susceptible to removal because the material gets access to the plates and tubes through them, resulting in the scale becoming rapidly loosened and removed, falling to the mud ring or to the bottom of the boiler under the tubes where it is blown or washed out.

Complete or accurate data are not available, but the reports indicate that life of the flues and fireboxes has been lengthened from 150 to 500 per cent. by using treated water. Also it shows a substantial decrease in the cost of maintenance and running repairs.

The Santa Fe reports a cost of 4 cents per thousand gallons for treating feed water; the Canadian Pacific advises that the cost ranges from 2 cents to 5 cents, according to conditions. The polarized treatment costs about 3 cents per thousand gallons.

Committee.—A. E. Shaule, chairman; Geo. Austin, T. W. Lowe and G. C. Wehling.

J. F. DE VOY'S ADDRESS.

J. F. De Voy, assistant superintendent motive power, Chicago, Milwaukee & St. Paul, addressed the convention on Thursday morning.

In speaking of the federal boiler law he expressed the opinion that it has brought about a better condition of locomotive boilers, stating further that if the many regulations were governed entirely by federal permission rather than by state laws more practical results would be obtained, inferring that state legislatures do not consider these various regulations from a practical and engineering standpoint, as does the federal government. If in preparing laws for the regulation of various conditions in railway practice the advice of associations or practical men that are thoroughly versed in the problems under discussion is taken, much better results would be obtained.

Boilers of today, with their modern improvements, are performing five times the work of boilers over 20 years ago, and while the increased size of boilers has magnified faults which were thought of minor importance in the older types of boilers they have been developed to such an extent that they are fully as safe to operate, and are 25 per cent. more efficient insofar as economy is concerned.

ELECTION OF OFFICERS.

The following officers were elected for the ensuing year: President, T. W. Lowe, Canadian Pacific; first vice-president, J. T. Johnson, Santa Fe; second vice-president, Andrew Greene, Big Four; third vice-president, D. A. Lucas, Chicago, Burlington & Quincy; fourth vice-president, J. B. Tate, Pennsylvania; fifth vice-president, C. P. Patrick, Erie; treasurer, Frank Gray, Chicago & Alton.

AVIATION RECORD.—A French aviator on May 18 flew from Hendon, England, to Calais, France, and back without landing, a total distance of 100 miles in 65 minutes, with one passenger.

TEXAS STATE RAILROAD.—Beginning on July 1, the Texas State Railroad, operating between Palestine and Rusk, Tex., will be operated under the jurisdiction of the governor instead of the State Prison Commission. Governor Colquitt has announced that he will assume the active management, and that instead of reporting a monthly loss he believes he will be able to make the road earn from \$1,000 to \$2,000 a month. The governor recently made an inspection trip over the road with President W. B. Scott, of the Sunset Central Lines, for the purpose of obtaining advice from a practical railway man. A number of improvements are contemplated.

CAR DEPARTMENT

UNDESIRE QUICK ACTION OF BRAKES

C. N. Remfry, of the Duluth, Missabe & Northern, read a paper at the recent meeting of the Air Brake Association on "Undesired Quick Action, Its Prevention and Remedy," an abstract of which follows:

We have 7,000 ore cars and 2,000 freight cars on our road. The ore equipment does not leave our system, therefore it is under observation throughout the year; when the ore season is at its height each car will average one round trip of about 190 miles every 24 to 36 hours, and is examined by air inspectors after each trip. This equipment is in service only during the time that navigation is open on the great lakes, approximately from April 15 to November 30, and at the close of the season the brakes are cleaned and lubricated, and the cars stored for the next season's work.

Prior to and including the year 1906, triple valves were cleaned on the cars. We simply removed the triple cap and the check valve case, wiped the parts as clean as possible, applied triple valve oil to the slide valve and slide valve piston, then replaced the parts, after which the brakes were tested for leaks and defects. Under this method the brakes worked in first-class condition when cars were put in service at the start of the season's work, generally during the month of April, and continued giving good service while the weather remained cold. During the latter part of May when the weather became warmer, undesired quick action developed on nearly all trains.

We worked on the theory that in warm weather the oil or grease became thinner and settled to the bottom of the triple piston cylinder carrying grit, dirt and rust with it, that this foreign substance moved back and forth with every movement of the piston, and that at times small pieces would wedge between the packing rings and bushings, holding the piston until the pressure became great enough to move the piston past the obstruction, and that when it did finally move, it went to emergency position, throwing the entire train into emergency.

To overcome the undesired quick action it was recommended that triples be cleaned in a warm place, that the highest grade of lubricant possible to secure be used, that train pipes be hammered to loosen rust, scale, etc., and that the pipes be thoroughly blown out. The suggestion was followed out to the letter. Upon starting trains in the spring the undesired quick action developed immediately and lasted throughout the season of eight months, regardless of whether weather conditions were hot or cold. Delays came in from all sides, drawbars pulled out, and in general the equipment became more or less weakened; in fact, repair tracks and storage yards were filled with bad-order cars. I do not hesitate to say 20 per cent. of our equipment was out of commission. The only explanation a train crew had to make for a break-in-two or a delay was "dynamite train."

Upon examining the triple valves at the end of the season, we found the lubricant on the triple valve slide valves and pistons in about the same condition as when the brakes were cleaned, with very little grit on the pistons or bushings. The matter was referred to the Westinghouse representative in our district, and a large number of suspicious triple valves which he selected from trains developing undesired emergency action were sent to the Westinghouse works at Wilmerding, Pa., for closer examination and test purposes.

Before the opening of the 1909 season and before any ore car brakes had been overhauled, recommendation was made not to hammer the pipes, but to simply blow them out, to give special attention to the cleaning of the triple valves, gasoline

to be used where we previously used kerosene to remove grease, gum and dirt from the parts of the valve, and for lubrication we were instructed to use a high-grade, fine dry graphite on the slide valves and a good grade of grease or oil on the triple piston. When the season opened all brakes on ore equipment had received this treatment, and at the end of the season or after running eight months, we had only six cases of undesired quick action, and in each case the triple valve causing the trouble was located and found to have oil on the slide valve.

The following tabulated list of trains handled during the last six years will give an idea of the trouble experienced while we used oil or graphite grease on slide valves and the results obtained from changing to dry graphite:

Year.	Trains south with loads.	Trains north with empties.	** Emergency trains reported.	Cause.
1907	6,878	6,672	375	
1908	4,021	3,897	4,021	
1909	5,946	5,625	6	} Found lubricant on slide valve in each case.
1910	5,929	5,653	0	
1911	3,092	2,898	1	} Mechanical defect. Wings of slide valve riveted too tight, causing graduating valve to bind.
1912	4,536	4,347	0	

* Hill trains not included.

** Trains developed undesired quick action more than once during the trip. No record kept of the number of times undesired quick action took place. No record kept of the cars in each train. It is assumed that a large percentage of the trains contained almost the same identical cars, therefore it is safe to say that the list includes trains which developed this trouble several times but on different trips.

It is safe to say the undesired quick action experienced on the hill was more severe than on the road, especially on the down trip while trains are controlled with the retaining valves. To make the down trip, including the stops at docks, about eighteen service applications are made, while in road service it is not necessary to make so many, the average being about four applications.

Even at the present time our commercial trains, those handling regular mixed freight, quite frequently show undesired quick action. This can only be explained by the fact that these trains contain a number of foreign cars, brakes of which are lubricated with oil instead of dry graphite.

It was also found that the type of triple valve had no effect one way or the other with producing or remedying the undesired quick action. The last change we made which had a bearing on this subject was in the brake cylinder lubricant. On the majority of our ore cars, the brake cylinder is located on the side of the car instead of being located under the car or under the end hopper sheets where it would be shaded in warm weather. Owing to this exposed location the brake cylinder lubricant, which was a heavy grease, became thinner, making it more penetrating, and the possibility of its working back to the slide valve through the exhaust port, thereby destroying the benefits we expected to obtain from doing away with oil or grease on this part of the valve, was a question we had to take into consideration. In 1909 a trial was made of a lubricant that does not appear to be affected by heat or cold, which has since been made the standard.

Foremen and men cleaning triple valves are compelled to observe the following instructions:

INSTRUCTIONS TO TRIPLE VALVE CLEANERS.

1. Remove triple cap, triple piston and slide valve. Place piston and slide valve in a can of gasoline, completely immersing the parts.
2. Remove check valve case and its parts.
3. Clean piston bushing with cheese cloth and gasoline, clean the slide valve bushings with cheese cloth wrapped around a

stick and used as a swab, which has been soaked in gasolene, after which wipe all parts dry and blow out all ports with air.

4. Remove triple piston and slide valve from gasolene, wipe dry and blow out all ports and blow off all parts.

5. Apply graphite to chamois skin glued to a flat stick and rub graphite well into slide valve face, bushing seat and top of slide valve bush along the place where slide valve spring bears. Triple piston is to be replaced in the triple valve, the triple piston bushing being dry, after which a few drops of oil are to be applied to the bushing and be spread with the finger and the piston worked back and forth a few times. This method of lubricating triple piston bushing is to eliminate the possibility of any surplus oil working back on the slide valve, as may occur should the triple piston bushing be lubricated before the triple piston is put in place. Then put on the triple cap.

6. Select a check valve case which has had the valve ground in, wipe all emergency parts dry and apply. Check valve case is not to be applied until triple cap has been put on and tightened up. This is to prevent any graphite which may drop off the slide valve when it is applied, from dropping into check valve case.

7. All triple valves must be tested on Westinghouse improved test rack.

In conclusion the points I wish to emphasize are (1) that with brake maintenance second to none, we had a serious epidemic of undesired quick action each year until we finally changed our method of cleaning and lubricating triple valves to the one just described; (2) that since then we have had practically no undesired quick action; and (3) that the effect on slide valves and their seats has been, as far as we can see, distinctly helpful, as indicated by less leaky slide valves.

DISCUSSION.

The members generally participated in the discussion, many stating that they had not obtained as good results by the use of dry graphite as Mr. Remfry had. This is due to the fact that dry graphite is not generally used by all the roads, the greater percentage of the trouble being experienced from foreign cars not using this material. Among other causes pointed out as giving the undesired quick action, J. P. Langan (D. L. & W.) mentioned the inability of the feed valves to keep up with excessive train pipe leakage. He also stated that when the air cylinder of the compressor was lubricated by the automatic lubricator he found that the whole air system would be liable to become flooded with oil. If this system is to be used extreme care should be taken to see that the lubricators are handled correctly. He also stated that a leak in the train line somewhere near the triple valve would often give the undesired quick action.

C. W. Martin (Pennsylvania) spoke of the difficulty many roads would experience in the use of gasolene, due to the insurance restrictions, stating that he had found kerosene to do very nicely, but in this regard it was shown that extreme care must be taken to see that the kerosene was thoroughly wiped off, as it would not evaporate as readily as gasolene.

An interesting point was mentioned by F. Von Bergen (N. C. & St. L.) who stated that he had experienced trouble with triple valve bushings that had been re-rolled; he believed all such repairs should be done by the manufacturing company to insure its being done correctly.

G. H. Wood (A. T. & S. F.) stated that although he had used dry graphite, he had not found it to wholly solve the problem; trains out of Chicago would operate satisfactorily until they got down into the hot climate of Arizona, where the undesired quick action would take place, seemingly due to moisture in the train line.

Most of the speakers could not report continued success by the use of dry graphite, stating that the oil in the brake cylinder would work back through the exhaust ports to the triple valve and that moisture from the train line would find its way to the slide valve.

Walter V. Turner (Westinghouse Air Brake Company) explained that when either water or oil found its way to the triple valve slide valve seat, the advantages of the dry graphite were wholly nullified. The purpose of the dry graphite is to allow the air to percolate under the slide valve, thereby reducing its bearing pressure on the valve seat so that it will respond to a small difference in pressure between the auxiliary reservoir and the train line. He also stated that any dirt or other substance that would tend to cause the slide valve to stick would allow the pressure to accumulate on one side of the slide valve so that when the resistance was overcome, the slide valve would not respond to the graduating spring and would move to the emergency position.

It was the consensus of opinion that while dry graphite would greatly reduce the causes of undesired quick action there were many other things to be considered as well, and so long as different roads used different methods in caring for the triple valve there could be no uniformity in its operation.

MARKING COUPLERS AND PARTS

A paper on "Couplers and Parts, Marking by Manufacturers for Identification" was read by A. H. Young, St. L. & S. F., at the annual meeting of the Railway Storekeepers' Association. An abstract follows:

At present we have about forty different types of couplers and the number is increasing, although it is several years since the Master Car Builders' Association took up the question of designing and adopting a standard M. C. B. coupler. Considerable progress has been made in this matter during the past two years, but even though a standard coupler is adopted at the next meeting of the Master Car Builders' Association, we still have the present numerous types of couplers to maintain until the bodies are either worn out or scrapped.

From an economical standpoint, the question of supplying repair parts for so many different kinds of automatic couplers should be a strong argument in favor of a single standard. The storekeepers are interested in this matter because it means not only less delay and less trouble in making repairs to foreign equipment, but will bring about a reduction of several thousand dollars in the amount of repair parts now necessary to be carried in stock.

As we must maintain the present styles of automatic couplers for several years at least, I believe we should take some action to have all coupler parts marked in such a manner that they may be quickly and correctly identified. This can no doubt be accomplished without adding any expense to the manufacturer, or much trouble to the Storekeepers' or Master Car Builders' Associations, by compiling a complete list of all couplers now in use, assigning a number to each coupler with the parts classified under the proper heading and designated alphabetically; the coupler number with the alphabetical prefix to be cast in each piece by the manufacturer.

If all coupler parts were made with this identifying mark, it would enable the storekeeper or car department foreman to use the cheaper labor on his force to handle this class of material without the assistance of experienced and higher-priced workmen, because any laborer who could read the number would be able to tell at once the coupler to which any part belonged and could assort a shipment of mixed knuckles or locks just as readily as the most experienced car repairer.

Discussion—All the members speaking on this subject recognized its importance and urged that prompt action be taken. It was believed that the Storekeepers' Association could handle it with assistance or co-operation with other associations, and a committee of three was appointed to draw up a list of all parts with recommended designating numbers, which should be in shape to be put in effect immediately on adoption at the next meeting.

WILL TRIPLE VALVES OPERATE AS INTENDED?

Effect of Different Sizes of Brake Pipe, Main Reservoir Pressures, Compressor Capacity, etc.

S. W. Dudley, of the Westinghouse Air Brake Company, prepared a paper on this subject for the annual meeting of the Air Brake Association. In his absence it was read by W. V. Turner. An abstract follows:

The triple valve is built to operate in a certain manner when the total pressure on the brake pipe side of its piston differs from that on the side next the auxiliary reservoir by a certain amount. Consequently, it will so operate whenever the predetermined condition exists, regardless of how this condition may be brought about. From this point of view and with the triple valve in proper condition, it can never operate improperly.

The successive stages in the advance of the air brake art in the direction of higher efficiency, economy and safety have received ample attention from time to time. The papers, and the discussions in connection with these papers, have necessarily involved much reference to the effect of conditions of apparatus, installation, maintenance, proper and improper manipulation and so on. But an account of the influence of these circumstances, especially on the service operations of this brake, does not appear to be available in a form convenient for reference or study. Consequently it seems both fitting and of value to the association to present for discussion and record the results of a somewhat comprehensive series of tests along these general lines which were conducted jointly by representatives of the Pennsylvania Lines and of the Westinghouse Air Brake Company.

They were made to determine, comparatively, the effect of the more common circumstances affecting the service operation of the triple valve in modern passenger train service. A primary consideration was the relative effect of 1 in., 1¼ in. and 1½ in. brake pipe on the release, the service and the emergency functions of the quick action triple valve. Other considerations were the effect of main reservoir pressure, compressor capacity, design of triple valve, kind of service brake applications, use of full release position, single and double brake equipment per car, condition of triple valve, rate of recharge of auxiliary reservoirs permitted and brake pipe leakage.

The tests were made on a 12-car train test rack of double PM-1612 equipments, including one complete No. 6 ET locomotive brake equipment, located out of doors at the plant of the Westinghouse Air Brake Company, Wilmerding, Pa. The apparatus was arranged so that any desired combination of conditions with regard to compressor capacity, size of brake pipe, arrangement of equipment or manipulation could be readily obtained. Standard (not extra heavy) pipe was used in all cases. The test rack duplicated, as nearly as possible, train service conditions. Whether or not the present service demands are in excess of the capacity of the ordinary quick action triple valve in other particulars than the releasing of the brakes was not considered at all in these tests, this being entirely foreign to the present investigations.

Previous to this series of tests the triple valves (originally taken from storeroom stock in good condition but without special attention being given them) had been operated on the rack more or less for about two weeks. Just preceding the tests each valve was tested on the triple valve testing rack. The records of these tests show that the valves were by no means in a uniform condition. Some were sensitive to application and some were not, and similarly some were sensitive to release and others required a considerable differential before releasing. No change, however, was made in any of the valves after they were tested on the triple valve test rack, as it was the opinion of all that to allow the valves to remain as they were would more nearly approach service conditions than to

have them all in the best possible condition. Preliminary tests showed that as the triple valves stood, the use of 1½ in. pipe instead of 1 in. pipe did not appreciably change the number of brakes which would apply or release.

By the use of a portable brake testing truck after these preliminary tests the triple valves were tested individually and in a number of cases were found to require an excessive pressure to cause them to apply or release. It was evident that this was not the condition necessary if the influence of different sizes of brake pipe was to be accurately determined. The triple valves not passing a predetermined minimum test were accordingly replaced by others which would pass such a test and the experiments then continued with all of the triple valves in as nearly a uniform condition as could be accomplished without taking any extraordinary pains.

But few brakes failed to release with triple valves in good condition. To have triple valves in such a condition that they would fail to release was to introduce a disturbing factor (namely, the condition of the triple valve), which made impossible a fair comparison of the effect of size of pipe, etc. In the present instance the rate of rise of brake pipe pressure on the last car in the train was chosen as a convenient and satisfactory standard of comparison because it is directly and primarily affected by the conditions which it is desired to compare, it varies through a sufficiently wide range to permit of ready and accurate observation and because, with triple valves in like condition, the more rapid the rate of rise of brake pipe pressure on the rear car, the more prompt and certain will be the release of the brakes.

SIZE OF BRAKE PIPE.

When releasing brakes and increasing the pressure in the brake pipe, a 1½ in. pipe produces no improvement, and on the whole is less satisfactory than a 1¼ in. pipe in this respect. The time to increase the brake pipe pressure 5 lbs. on the last car in the train is practically the same as with 1¼ in. pipe. The difference in brake pipe pressure at the front and rear ends of the train during release is materially less than with the smaller sizes of pipe, which tends towards a greater uniformity of release of all the brakes in the train, other conditions being equal. With the triple valves in the non-uniform conditions already mentioned it was observed that the use of 1½ in. pipe instead of 1 in. pipe did not appreciably change the number of brakes which would apply or release.

The effect of 1½ in. brake pipe in service applications is to considerably delay the time of obtaining full brake cylinder pressure corresponding to the reductions made on the train as a whole, but at the same time cause a more uniform starting of the application of all the brakes. With a 1½ in. brake pipe, the time to start the application of the brakes on the twelfth car is practically the same as for the 1 in. and 1¼ in. The average time to obtain maximum pressure in making a 20 lbs. reduction with the 1½ in. pipe is 24.6 seconds, which is 5 seconds (or 25 per cent.) longer than for the 1¼ in. pipe and 10 seconds (or 70 per cent.) longer than for the 1 in. pipe.

While the use of a 1½ in. pipe slightly increases the emergency brake cylinder pressure, it seriously interferes with the obtaining of serial quick action especially with the brake (both triple valves) on the car next behind the locomotive cut out. The brake cylinder pressure in emergency is increased 6 lbs., or 7.7 per cent. above that obtained with the 1 in. pipe and 4.5 lbs., or 5.8 per cent. above that with the 1¼ in. pipe. The time of transmission of quick action through the train is not appreciably affected. Quick action could not be obtained with a

single engine and train having one car at the head cut out, nor could it be obtained at all with a double header, no brakes being cut out. With a 1 in. pipe quick action could be obtained in all such cases. The 1½ in. pipe, therefore, offers no appreciable advantages over the 1¼ in. pipe and does introduce some distinctly undesirable features.

The record of the brakes released with the 1¼ in. brake pipe is slightly better than with the 1 in. pipe. Its advantages in this particular are so slight as to be negligible in comparison with the much more marked differences produced by the use of other means, such as heavier brake pipe reductions, higher main reservoir pressure, etc., to be referred to in detail later. The time to increase the brake pipe pressure 5 lbs. on the last car is, under all conditions, less with the 1¼ in. pipe than with the 1 in. pipe. This should result in a corresponding improvement in releasing brakes. The summary of the tests, representing conditions where some brakes are close to the "sticking point," shows that for the 1 in. pipe, out of a total of 432 possible stuck brakes 6.5 per cent. were stuck for 10 seconds and 3.7 per cent. stuck for 60 seconds. The substitution of a 1¼ in. pipe for a 1 in. pipe, other conditions remaining the same, reduced these percentages to 1.6 per cent. and 0.9 per cent. respectively. The percentages for 1½ in. pipe were 1.2 per cent. and 1.2 per cent. respectively, showing no appreciable gain over 1¼ in. pipe. However, on the whole, the difference between the effect of 1 in. and 1¼ in. pipe on the release of the brakes was not sufficient to indicate that the larger pipe would materially assist in releasing the brakes under otherwise unfavorable conditions. The difference in brake pipe pressure at the front and rear ends of the train when releasing is materially less than with the 1 in. pipe, tending towards greater uniformity in release, other conditions being equal.

The effect of a 1¼ in. brake pipe in service applications is to somewhat delay the application of the brakes on the train as a whole, but at the same time produce a more uniform starting of the application of all the brakes. With a 1¼ in. brake pipe the time to start the application of the brakes on the twelfth car is practically the same as for the 1 in. pipe. The time to obtain maximum pressure in making a 20 lbs. reduction is 19.6 seconds, which is 5 seconds (or 35 per cent.) longer than with the 1 in. pipe.

The use of the 1¼ in. pipe slightly increases the emergency brake cylinder pressure, but tends to hinder serial quick action. This interference with quick action, however, was not appreciable, except under the more severe conditions; which conditions were, however, not sufficient to affect the obtaining of quick action with the 1 in. pipe. The emergency brake cylinder pressure is increased 1.5 lbs., or 2 per cent. above that with the 1 in. pipe. The time of transmission of quick action throughout the train is not appreciably affected. Quick action could not be obtained (using one engine) with two cars (4 triple valves, two per car) cut out at the head end of the train, nor could it be obtained with a double header and one car cut out at the head end. With a 1 in. pipe quick action could be obtained in all cases.

The use of a 1¼ in. pipe would, therefore, tend toward improvement in releasing brakes, would be a distinct economic advantage (due to having but one, instead of two standard sizes of air brake hose and fittings to be kept in stock and handled) and would not be objectionable, either on account of a slower service application or its effect on quick action except under extreme conditions. However, it could not be expected to entirely eliminate the troubles heretofore experienced with double equipment cars, other conditions remaining unchanged, and is of much less benefit than a number of the other factors, such as manipulation, main reservoir pressure, and so on mentioned in this report.

General Conclusions.—As would be expected, with low main reservoir pressure and short time in full release position, there is not much difference in the results with different size pipe,

but with the higher (140 lbs.) main reservoir pressure the effect of large size pipe is marked. With 140 lbs. main reservoir pressure, for all reductions and times in full release position, the difference between the brake pipe and pressure on car 1 and on car 12 with 1¼ in. pipe is half or less than half that with 1 in. pipe. With other conditions the same, the 1¼ in. pipe permitted the brake pipe pressure on the last car to rise to a higher point than did the 1 in. during the time the brake valve handle is in full release position.

The average time to start the brakes applying varies but a few tenths of a second for all different reductions and different sizes of pipe. That there is no particular difference in this respect under extreme conditions is shown by the fact that the average time to start the application is the same (3.8 seconds) for the 6 lbs. reduction and 1 in. pipe and for the 20 lbs. reduction and 1¼ in. pipe.

The average time to obtain maximum brake cylinder pressure is materially longer, the larger the size of pipe. The time to obtain maximum pressure in making a 20 lbs. reduction with 1½ in. pipe in 24.6 seconds, which is 5 seconds (or 25 per cent.) longer than for 1¼ in. pipe and 10 seconds (or 70 per cent.) longer than for 1 in. pipe. With 1¼ in. pipe this time is 19.6 seconds, or 5 seconds (35 per cent.) longer than the time when using 1 in. pipe, viz., 14.5 seconds. The tests showed that for

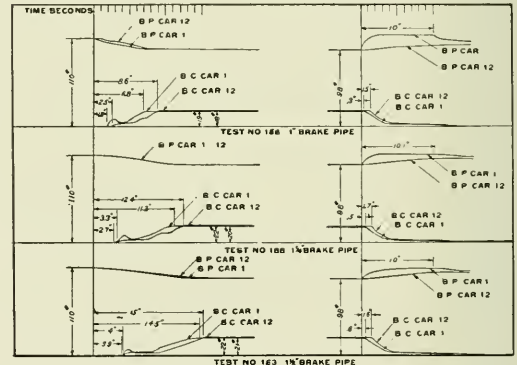

Fig. 1—Comparative Promptness, Uniformity and Rate of Fall of Brake Pipe Pressure and Rise of Brake Cylinder Pressure During Service Application and Rise of Brake Pipe Pressure and Fall of Brake Cylinder Pressure During Release.

1 in., 1¼ in., and 1½ in. brake pipe.
Equipment double, PM 1612.
Brake pipe reduction 12 lbs.
Brake valve handle in full release 10 seconds.
Main reservoir pressure 140 lbs.
Compressors—One 9½ in. M. R. volume 60,000 cu. in.

a 20 lbs. reduction the maximum time to obtain maximum cylinder pressure with 1 in. pipe (15.8 seconds) is 2.2 seconds shorter than the minimum time with 1¼ in. pipe and 7.2 seconds shorter than the minimum with 1½ in. pipe.

Figs. 1 and 2 show clearly that with a 1 in. pipe there is a greater difference between the brake pipe pressure on the head and rear end of the train during service application of the brake than with the larger size of pipe. They also enable a direct comparison to be made of the considerably increased time required to make the same brake pipe reduction with the larger size pipe. In releasing, these brake pipe cards show a much greater rise in brake pipe pressure on the first car than on the last car, the difference being less, however, as the size of pipe increases. Moreover, they show the characteristic slow rate of rise of pressure on the last car. The much slower brake application with the larger size pipe follows the slower fall in brake pipe pressure. The difference in time of obtaining brake cylinder pressure on the first and twelfth cars, all the way up until

the maximum is reached, is practically the same for the different sizes of pipe.

The brake cylinder release cards are practically identical for the different sizes of pipe. In the case of the equipments from which these cards were taken it is evident that the release was prompt under all conditions, the release on Car 1 being commenced in a half-second or less, and on Car 12 within about a second and a half or less than two seconds at the most. Evidently, where triple valves are releasing in the manner illustrated on these cards, the leaving of the brake valve handle in release for six seconds, ten seconds, or fifteen seconds, cannot possibly have any effect on the release of the brakes. That all do not always release thus, however, is also indicated by the test data previously referred to.

The time of transmission of quick action is but little affected by the size of pipe. The difference in time of transmission of quick action when the pipe is increased from 1 in. to 1½ in. is not appreciable. With 1 in. pipe three cars had to be cut out at the head end before quick action would fail. When a car brake is spoken of as being "cut out" it is understood that both equipments on the car having double equipment are cut out. With 1¼ in. pipe on cars and a single engine, with either 1 in. or 1¼ in. pipe on tender, quick action failed with two cars cut out and with double header quick action failed with one car cut out. With 1½ in. pipe on the cars quick action failed

MAIN RESERVOIR PRESSURE.

A high main reservoir pressure at the time the release is made is one of the most effective aids in overcoming troubles from stuck brakes. With 130 lbs. main reservoir pressure, 10 seconds in full release, there was a total of 20 brakes stuck for 20 seconds and 13 stuck for 60 seconds in all tests with all sizes of pipe. With 140 lbs. main reservoir pressure, all other conditions the same, not a single brake failed to release within 10 seconds. With 140 lbs. main reservoir pressure the time to increase the brake pipe pressure 5 lbs. on the last car varied from 4 to 12 seconds under conditions and methods of manipulation varying from most to least favorable. With 130 lbs. main reservoir pressure this time varied from 6 seconds to 30 seconds, the longer time being due to the recharge being incomplete at the time the brake valve handle was returned from full release to running position, requiring the latter part of the increase in brake pipe pressure to take place through the feed valve, at which time the feed valve rather than the size of pipe would be the governing factor. With 120 lbs. main reservoir pressure this time varied from 8 seconds to 68 seconds, the excessively long time being due to the still greater effect of the feed valve as just explained.

COMPRESSOR CAPACITY.

That this high main reservoir pressure must be available at the time the release is made follows as a matter of course. In carrying on such tests as these it was necessary to wait until the air compressor had raised the main reservoir pressure to the proper point before releasing. With the single 9½ in. compressor used in most of the tests this time was usually only ten seconds and never over 15 seconds, and a special test would have been required to show satisfactorily the difference between an ample and an insufficient compressor capacity. It goes without saying, however, that the maximum main reservoir pressure necessary in order to insure satisfactory releasing of the brake will be more certain the greater the compressor capacity, especially in view of the many influences that are likely to combine to prevent the utilization of the maximum compressor capacity which would otherwise be available under favorable conditions. The few tests which were made with two compressors instead of one were sufficient to show the less burden imposed on each compressor when two were used and the very desirable increase in reserve capacity to take care of abnormal conditions.

BRAKE APPLICATIONS.

One of the most impressive results of the tests was their consistency throughout with the principle that the brakes can be released with greater certainty after a heavy brake pipe reduction than after a light reduction. The differential, or "driving head," with a light reduction, is smaller and consequently cannot force the air back through the brake pipe and increase its pressure as promptly as the higher differential available when the reduction is heavier. It is the light brake pipe reductions that cause the most trouble. Few brakes stick after a 20 lb. reduction, and those that do require attention, as it is internal and not external conditions that are responsible. But it is not always feasible to make heavy service reductions. There are likely to be times when there is some doubt as to whether a reduction sufficient to insure the possibility of subsequently releasing all triple valves may not be heavier than necessary, or perhaps desirable. Judgment alone can decide what is best to be done in such cases. Considered broadly, such results indicate that whenever a low retarding force is necessary it should not be possible to obtain this with brake pipe reductions less than will permit of a reasonably certain release of the brakes under otherwise average conditions.

TIME FOR RELEASE.

The tests show that so long as the time to recharge the brake pipe sufficiently to release all normally operating triple valves

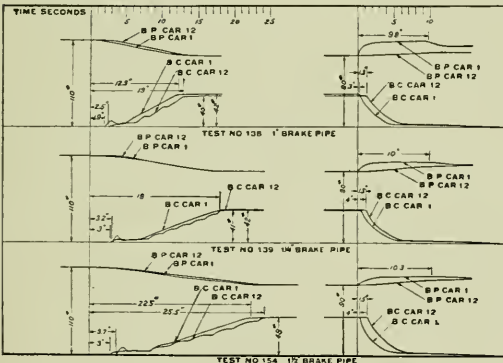

Fig. 2—Comparative Promptness, Uniformity and Rate of Fall of Brake Pipe Pressure and Rise of Brake Cylinder Pressure During Service Pressure Application and Rise of Brake Pipe Pressure and Fall of Brake Cylinder Pressure During Release.

1 in., 1¼ in. and 1½ in. brake pipe.
 Equipment double PM 1612.
 Brake pipe reduction 20 lbs.
 Brake valve handle in full release 10 seconds.
 Main reservoir pressure 130 lbs.
 Compressor—One 9½ in. main reservoir, volume 60,000 cu. in.

with the single engine and one car cut out and with the double header quick action could not be obtained at all, no brakes being cut out.

The effect of different size of pipe on the cylinder pressure obtained in emergency application is as follows: With the 1¼ in. pipe 79.5 lbs. is obtained or only 1½ lbs. higher average emergency cylinder pressure than with the 1 in. pipe (78 lbs.), and with the 1½ in. 84 lbs. is obtained, which is 6 lbs. higher than with the 1 in. pipe. This is in proportion of 1 to 1.02 to 1.08. The increase in volume of pipe is approximately 1 to 1.73 to 2.38. It is not to be expected, however, that the emergency brake cylinder pressure should increase in the same proportion as the brake pipe volume, because the emergency pressure depends in a large measure on the auxiliary reservoir volume which remains constant and is much greater than the volume of the brake pipe. The release after an emergency application is noticeably longer for the larger size of pipe.

exceeds the time that the brake valve handle is ordinarily left in release position there is a greater tendency for the less sensitive triple valves to fail to release. In such cases the longer the brake valve handle is left in full release position the quicker is an increase of 5 lbs. at the rear end obtained. Consequently, the greater is the likelihood of releasing brakes which otherwise would stick. However, they show that with the longer time in full release position there is also a greater tendency to overcharge the system and thus invite evils of a different sort.

To leave the brake valve handle in full release longer than six or eight seconds does not necessarily insure releasing brakes which would stick with a shorter time in full release position. Whether the brake valve handle is in full release position six seconds, or ten seconds, or fifteen seconds, the rate of rise of brake pipe pressure for the first six seconds is the same in each case and the great majority of triple valves that are going to release at all will have released before this time, and those that have not released usually will remain "stuck."

Furthermore, the tests in general showed that no fixed rule for the time the handle should be left in full release position can be laid down arbitrarily, with the expectation of obtaining the best results in all cases. This depends largely on a proper judgment of the influence of the various factors involved, such as length of train, amount of reduction, main reservoir pressure and volume, etc., although in some instances it will doubtless be possible for those intimately familiar with existing conditions in any particular territory to formulate general instructions which will be of considerable service.

SINGLE AND DOUBLE P-M EQUIPMENTS.

The brake pipe can be recharged much more quickly and, therefore, the triple valves released with much greater certainty when using the single equipment. This simply amounts to saying that it is harder to recharge a pipe with two outlets of a given size, each leading to a large auxiliary reservoir, than if there were only one outlet. The difference between the two cases was considerable. In no instance with the single equipment did the time to increase the brake pipe pressure on Car 12 5 lbs exceed 5.2 seconds, as compared with a maximum of over a minute when conditions with the double equipment were unfavorable. This is very clear evidence of the reason why long trains or trains having large auxiliary reservoir volumes to be recharged by P-2 triple valves give so much more trouble on the road than was experienced before the brake pipe was subjected to such an excessive drainage.

AUXILIARY RESERVOIR RECHARGE.

The difference between the results obtained with single equipment cars in short trains and with double equipment cars on long trains with large reservoirs is proportional to the difference between the amount of air which can be permitted to flow into the brake pipe and the amount which is able to flow out from the brake pipe. As the rate of inflow is fixed by many considerations the question naturally arises: Why not limit the rate at which air can leave the brake pipe to an extent which will permit of always obtaining a sufficiently rapid rate of rise of brake pipe pressure to positively insure a release of all triple valves? This is perfectly logical, and, in fact, is what is done in the more recently designed apparatus.

But with the quick action triple valve there is only one way in which this can be accomplished, viz., restrict the rate at which the auxiliary reservoir can be recharged by reducing the opening from the brake pipe to the reservoirs. For convenience in making a test to show what could be gained by such a modification, the slower rate of charging the auxiliary reservoirs was accomplished by inserting a check valve in the pipe leading from the triple valve to the auxiliary reservoir, having a small hole drilled through the check valve proper of a size suitable for the rate of recharge desired. The check valve opened

freely in the direction of the triple valve so that it offered no restriction to the flow of air from the auxiliary reservoir. When arranged to give the minimum permissible rate of recharging (viz., that of the present P-2 triple valve and the largest size auxiliary reservoir—16 in. x 42 in.—with which it is being used in regular service), it was found that the use of these check valves very materially diminished the time required to increase the brake pipe pressure on the last car 5 lbs., and thereby the condition of the single installation on a short train with small volumes to be handled is more nearly approached.

Under unfavorable conditions the charging of the brake pipe at the rear end of the train was increased nearly as much as under the most favorable conditions without the chokes and with the chokes, the use of 1¼ in. pipe instead of 1 in. pipe produced no appreciable effect, so far as the increase in brake pipe pressure on the rear was concerned.

The use of such check valves or their equivalent would, therefore, assist in obtaining a quicker recharge of the brake pipe and so tend to diminish troubles due to stuck brakes. This conclusion in itself, however, is only one side of the story. There are several other considerations involved, two of which may be mentioned briefly. Difficulty is always experienced in keeping the ordinary check valve tight, especially with relatively low differentials of air pressure, and questions of installations and maintenance then arise, which would require a trial and close observation before the service efficiency of such an expedient could be determined. The question of what improvement could be expected from such an expedient is, therefore, one of design or modification of existing apparatus, to suit specific conditions. Again, as a general proposition, any slower rate of recharging of auxiliary reservoirs in passenger service than exists at present is undesirable. It is too slow now and the tendency of service requirements and of modern equipments is all towards a quicker rather than a slower rate of recharge. A reservoir not charged is useless for braking purposes. A prompt release of the brakes, therefore, requires a prompt increase in brake pipe pressure, which in turn, cannot be accomplished if the auxiliary reservoirs are being recharged from the brake pipe at the same time that the release is being made. But the recharging of the reservoirs cannot safely be restricted. The difficulty is now that there is but little margin which will permit of making re-applications as frequently as is often necessary and to slow up the rate of recharging of the reservoirs would make this margin still less. These opposite requirements would be satisfied only by, first, preventing the recharging of the reservoirs from the brake pipe during the time the brakes are being released and by, second, recharging the reservoirs meanwhile from some source other than the brake pipe. This not only accomplishes the desired object, viz., prevents an excessive drain on the brake pipe, but also recharges the auxiliary reservoirs as quickly as the brake pipe alone can be recharged. In doing this the releasing of the brakes is insured to a maximum degree, because the brake pipe only (or with only a very small additional volume) has to be recharged in order to release. As a matter of fact, the result of this procedure is to enable the brake pipe pressure to be increased at a more rapid rate than at any other time in the history of the air brake.

Tests were made to ascertain if the use of 1¼ in. pipe on the engine in place of 1 in. pipe would have any effect on the transmission of quick action, both with a single engine and with a double header. No difference in the results could be detected.

To compare the effect of 1 in. and 1¼ in. pipe on the locomotive (1¼ in. pipe on the cars in each case) on the service operation of the brakes a series of 12 lb. brake reductions were made, the brake valve handle being left in full release position for 6, 10 and 15 seconds with both 120 lbs. and 140 lbs. main reservoir pressure. The results agreed so closely that no difference could be established one way or the other, either in the service application or release of the brakes.

The tendency of the larger size brake pipe is undoubtedly in the direction of permitting a greater amount of air loss by leakage without causing an application of the brakes. This merely amounts to saying that while a triple valve will apply on the same rate of drop of brake pipe pressure, the rate of drop with a larger brake pipe will not be as fast as with a smaller pipe for the same opening to the atmosphere.

OTHER DATA.

With the 1¼ in. pipe heaviest reductions and longest time in full release position, it was observed that during the time the brake valve handle was in full release position the brake pipe pressure at the rear of the tender was only 5 lbs. below that in the main reservoir. This showed that the H-6 brake valve opening was practically equal to the capacity of the 1¼ in. pipe and that a larger opening through the brake valve in full

GRAND TRUNK HOPPER BOTTOM BOX CAR

The Grand Trunk has had a box car in operation for about two years fitted with a hopper bottom for the rapid unloading of coal and other bulk freight. The construction of the car is similar to that of many of the steel frame box cars now in general use except that the center sills are considerably heavier. The hoppers slope from the center of the car and from both ends, the hopper doors being placed on either side of the side doors of the car. In order to determine the best type of door for the different kinds of freight handled, two different hopper doors have been tried out. One of these is a sliding door operated by a worm and gear and working against the load when opened; the other is a hinged drop door sim-



Steel Frame Box Car Equipped with a Hopper Bottom.

release position would be of no practical assistance, so long as larger than 1¼ in. pipe is not used.

DISCUSSION.

P. J. Langan (D. L. & W.) stated that he had found it impossible to make 5 lb. reductions without brakes sticking. Mr. Turner explained that that was on account of the large auxiliary reservoirs used on the D. L. & W., which allow the brake to set sufficiently to cause a stuck brake, there being enough pressure in the brake cylinder to make some appreciable brake application and too much pressure in the auxiliary reservoir to permit the triple valve to go to release position when the train line was recharged. With the smaller auxiliary reservoir this difficulty would be overcome.

COAL IN JAPAN.—The output of coal in Japan increased nearly 50 per cent. between 1905 and 1910.

ilar to those in general use on hopper bottom gondola cars; both of these doors are fitted with a specially designed grain tight joint.

When it is desired to use the car as an ordinary box car, doors are provided which are hinged to the side sill on the inside face of the hopper. When these doors are closed they are supported by the center sill and form a continuation of the car floor. When the hoppers are being used these doors are swung open and set flush against the inside face of the door posts, forming the grain doors. For oats or other light grain an extension piece is placed on the doors to enable the car to carry its full capacity.

The car was designed under the direction of James Coleman, superintendent of car department, Grand Trunk, and is being operated between Midland, Ont., and Portland, Me., carrying grain on the eastward trip and coal on the return trip. It has been found that to unload a car of grain through the hopper

does not require more than seven minutes, but it is believed that this time can be materially reduced, as when the test was made the grain elevator was found to be unable to take the grain into the receiving hoppers as fast as it was discharged from the hopper of the car, so that the latter would temporarily choke up. The following table gives some general

SELF-PROPELLED CARS*

BY S. T. DODD AND B. H. ARNOLD,
Engineering Department, General Electric Co.

The discussion is confined largely to the heavier types of independent cars, such as are suitable for steam trunk line and branch line service. The advantages of the internal combustion engine in operation, maintenance and radius of operation are so marked that the major part of the paper is devoted to this type of car.

STEAM CAR.

In summing up the position of the steam motor car, we note that of all the types which have been built, very few have been duplicated and none have been adopted as standard by operating roads in spite of the fact that they have been before the public for a length of time reasonably sufficient for their development. The objections which seem to have prevented their success are apparently: First, the cost of Maintenance. The necessity of developing a relatively high horse power in a limited space results in a special or cramped design of boiler and engine which is not economical in maintenance or repair. Next, the limited tractive power or excessive weight on drivers. The majority of cars of this type which have been built have the driving power applied to one axle only. Frequent stop service, for which the independent car should be particularly fitted, demands a high tractive effort in starting, if acceptable schedule speeds are maintained, and such tractive effort is not obtainable without a fairly high proportion of the weight upon driving axles. This results in excessive weight on the driving wheels when there is only one driving axle. Third, their limited operating radius. Tanks of 100 gal. of fuel and 1,000 gal. of water seem to be acceptable in practice. This represents a weight of fuel and water of nearly 10,000 lbs. and gives apparently an operating radius of only about 50 miles for fuel and 30 to 40 miles for water. For practical success, it appears that such a car should have an operating radius of about 100 miles without recharge.

STORAGE BATTERY CAR.

A storage battery car for branch line service, such as we have in mind, might fairly be assumed to have a weight of 40 tons and to require about 50 watts per ton mile for operation. This is equivalent to 2 k. w. per car mile, or for a run of 100 miles without recharging, would require a battery which would have a weight of about 10 tons or one-fourth the total weight of the car. These figures are presented to explain battery cars and to show that long distance operation of heavy cars without recharge of battery would entail a prohibitive weight of battery.

The writers wish to be clearly understood, however, that they believe that, on service which is within the scope of the battery, the storage battery car has a useful and economical field.

INTERNAL COMBUSTION ENGINE CAR.

Engines of the internal combustion type have been designed and built, which will use directly fuel in any of its three forms, solid, gaseous or liquid. The use of solid fuel, however, has not as yet been successful and gas fuels, while eminently satisfactory in certain cases, are practically prohibited by the conditions of motor car operation. The gas must either be carried compressed in tanks, or manufactured for immediate use in gas producers on the car. Both of these methods are subject to the same objections affecting steam and compressed air cars, as well as some additional ones.

The circumstances surrounding the use of liquid fuel are widely different. Internal combustion engines using this form of fuel are well and satisfactorily known and have reached a high degree of perfection. As an illustration of the economy of this type of fuel, it is to be noted that gasoline cars of 35 to 50

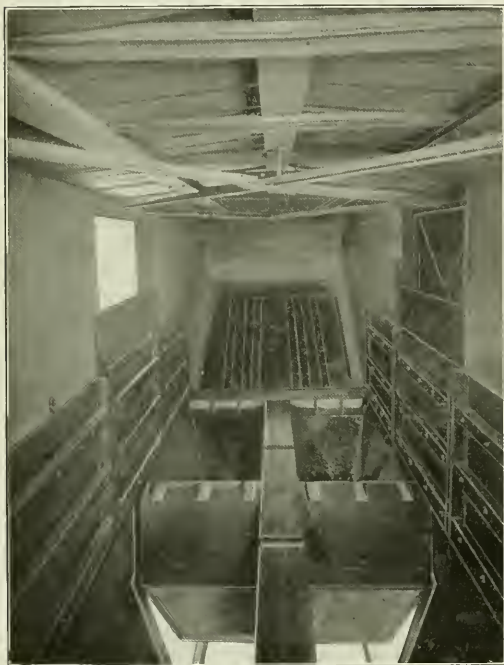

Interior of the Grand Trunk Hopper Bottom Box Car.

data of the car, as compared with the standard box car in use on the Grand Trunk:

	Hopper Bottom Box	Standard Box
Weight of car, lbs.....	48,000	37,000
Carrying capacity, lbs.....	110,000	66,000
Carrying capacity, bushels (wheat).....	1,833	1,100
Total weight, car and loading.....	158,000	103,000
Tons carrying capacity per ton weight.....	2.29	1.73
Ton miles, tare, Midland to Portland.....	16,728	12,894
Ton miles, net, Midland to Portland.....	38,335	23,001
Ton miles, total, Midland to Portland.....	55,063	35,895

COAL MINE ACCIDENTS.—During the calendar year 1912 there were 2,360 men killed in and about the coal mines of the United States.

AN EARLY LOCOMOTIVE AND TRAIN.—The locomotive steam engine constructed by David & Gartner, of York, Pa., commenced her operations on the Baltimore & Ohio Railroad under the most favorable auspices on Tuesday. It started from the Pratt street depot for Ellicott's Mills, with the entire train destined for that place, consisting of fourteen loaded cars, carrying together with the engine tender a gross weight of 50 tons. The whole train went off in fine style and was soon out of sight. A gentleman present says it was out of sight of the depot in about 6 minutes, and the rapid gliding of the immense train was one of the most imposing and beautiful spectacles he ever witnessed.—*From the American Railroad Journal, July 28, 1832.*

*Abstract of a paper read at the annual convention of the International Railway Fuel Association.

tons weight in actual operation on steam line service are carrying an amount of fuel which is equivalent to a radius of operation of 300 miles without recharging, and that including the weight of water for cooling the cylinders, the total weight of fuel and cooling medium does not exceed 2,750 lbs.

Mechanical Drive.—The best known development for passenger service has been the type of car built by the McKee Motor Car Company. The first of these cars was built in 1905. In its latest development the standard car consists of a steel body 70 ft. in length with center entrance or side doors. In this car the designer has made the side of the car assist the floor beams in strengthening and stiffening the whole structure, making of the car floor and sides a composite girder, while the shape and location of windows and doors are subordinated to the requirements of strength. The exterior of the car, having smooth sides, pointed ends and a sloping roof, gives the general impression of being suitable for high speed service. The interior of the car is divided into an engine compartment and a seating compartment, either with or without smoker, baggage or express compartments. The passenger compartment may seat as high as 100 passengers. The gasoline engine which stands on the motor truck and swivels with it, is a six cylinder engine with 10 in. x 12 in. cylinders driving a crank shaft at right angles to the center line of the car. A sprocket is carried on this crank shaft which drives the forward axle, which has 42-in. wheels, through a chain drive by means of an air operated friction clutch. Two gear ratios are supplied and the air clutch throws in one or the other of these sets of gears, thus obtaining a slow speed and heavy tractive effort for starting, or a high speed for running. With either one of these gear ratios, the variation in speed from minimum to maximum is attained entirely by variation in engine speed regulated by the throttle and spark. With low speed gearing the full engine power is ordinarily attained at about 10 to 15 m. p. h., while with the high speed gearing, the full engine power is attained at the maximum running speed of the car. Maximum speeds developed by these cars are reported as high as 60-70 m. p. h. The cars are fitted with fuel tanks of 100 gal. capacity and weigh complete approximately 35 tons.

In addition to the McKee cars, some other mechanical drive passenger cars might be mentioned, although they are less widely in use and of smaller commercial importance. Among others the Fairbanks-Morse Company, of Chicago, has built a mechanical drive gasoline car with single trucks, steel body and a seating capacity of 21. The P. H. Batten Company, of Chicago, has also built cars of this type with a seating capacity of about 30 passengers which are in operation on three roads in the central west. The Stover Motor Car Company, of Freeport, Ill., has supplied small single truck gasoline cars on the Waterloo, Cedar Falls & Northern and upon the Chicago, Rock Island & Pacific. The Hall-Scott Motor Company, of Oakland, Cal., has built double truck cars with a seating capacity of 50, and a 100-h. p. four-cylinder engine driving the rear axle through longitudinal transmission and double gears.

In Europe mechanical drive gasoline cars have been built by several companies and either are or have been in use on the Great Northern, England, the Swiss Federal Railroads, and the Wurtemberg State Railways.

Electric Drive.—The fundamental difference between these cars and those discussed in the preceding section is that the engine drives an electric generator, and power is transmitted electrically to motors, geared to the driving axles, instead of the engine being connected directly to the axle by mechanical gearing. Of this type of car, the most extensive experience has been obtained in this country with the car manufactured by the General Electric Company.

On the latest type, the car body is built of steel and is designed for the combination of the greatest lightness and strength. The front end is rounded. Either center or rear entrance is supplied. The cars are built in lengths running from 40 to 70 ft.

over-all, and weighing from 40 to 50 tons complete. The interior of the car is subdivided into passenger, smoker or second-class baggage, and engine room. The width of the car is 10 ft. over-all. The cars have a seating capacity which may run as high as 95 or 100 passengers per car, depending upon the interior arrangement.

The power plant is located in the engine room at the front end of the car and consists of an eight-cylinder, 550 r. p. m., four-cycle gas engine of the V-type, direct-connected to a 100 k. w., d. c. generator. The generator is built essentially to meet motor car service and is, therefore, designed to carry a wide range of output in current or voltage, so that the output may be varied from 400 amperes at 250 volts to 125 amperes at 800 volts.

The trucks are an equalized swing bolster type, suitable for the high speeds obtainable with this type of car. One of these trucks is a motor truck, designed for carrying two driving motors. The other is a standard light trailer truck. The motor truck is generally placed under the forward end of the car and carries the weight of the engine room equipment in addition to the motors. In such a case as this, about sixty per cent. of the weight of the car is on the driving wheels. In some cases, however, the motor truck has been placed at the rear end of the car, under the passenger compartment, and in this case, approximately fifty per cent. of the weight of the car is on the drivers.

The car is equipped with two G. E.-205 100-h. p. railway motors. This is a commutating pole motor and is suited for wide variation in operating voltage. The gearing is specially selected for the service. The gear ratio is low enough so that the highest maximum car speed will not develop excessive rotative speed of the armatures; at the same time the ratio is high enough to obtain the requisite starting effort without imposing excessive overloads on the motors.

The car is designed for operation from one end only. The engineer's seat is located at the right hand front window of the engine room, and controller and throttle handles are placed directly in front of him. The controller is a convenient combination of engine and generator control, with the different levers placed vertically above each other and operating about practically the same center line. The engine generator set is started by admitting compressed air to the cylinders. This is done automatically on the first opening of the throttle. As soon as the engine turns over, and the first charge of gasoline is exploded in the cylinder, the air is automatically shut off. This type of car has demonstrated very marked advantages, and is in operation on a number of steam roads in various parts of the country. At present 50 of these cars are in regular daily service.

In Europe the most extensive experience with electric drive gasoline cars has been on the Arad-Csanad Railway in Hungary. This road has been operating gasoline electric cars since 1905. At the present time, they are running approximately 1,000,000 car miles per annum. Their records of cost of operation and maintenance on such equipments are probably more complete and extensive than any other railroad and show an average cost of maintenance of 2.5 to 3 cents per car mile. These cars were built by the French Westinghouse Company and recently the same type of car has been introduced into this country, in the car known as the "Dracar," built by the Drake Railway Automotrice Company, of Chicago. This company has already furnished five of these cars for the Missouri, Oklahoma & Gulf. The "Dracar" is 56 ft. long over bumpers and 9 ft. 6 in. in width. The car is divided into first-class, second-class, engine and baggage room compartments and the general scheme of control and utilization of electrical energy is substantially the same as previously described in connection with the General Electric car.

The storage battery is of no real value in combination with the electric drive, as it has been developed today. The real value

of the electric drive is the possibility of working through a wide range of voltage and current. With a storage battery auxiliary this advantage would be eliminated, as the generator would be forced to work at the constant voltage of the storage battery. The weight and cost of the battery is a considerable item and the same weight and cost could be expended to greater advantage in increasing the capacity of the engine and generator if necessary.

Comparative Characteristics—Comparing the characteristics of the mechanical drive gasoline car, and the electric drive gasoline car, the fundamental difference between them lies in the method of transmission of the power between engine and axle. The comparison of the characteristics is well illustrated in the curves of Fig. 1. These curves show the speed, tractive effort, and gaso-

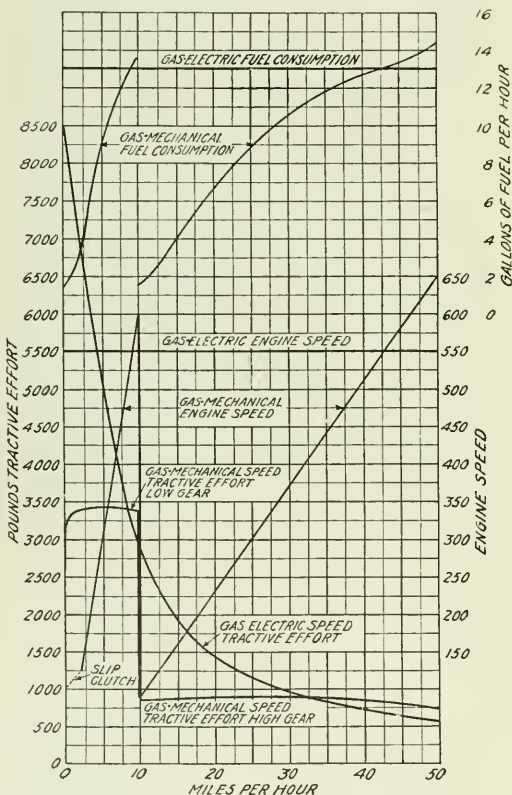

Fig. 1—Characteristics of Gasolene Car—Mechanical Transmission Compared with Electrical Transmission.

lene consumption of a car equipped with a 100-h. p. 550 r. p. m. gasolene engine, driving in the one case through electrical transmission, the motors geared to 38 in. driving wheels, and in the other case, through mechanical transmission, a single pair of driving wheels 42 in. in diameter. The slow speed gear reduction has been assumed at 7.5 to 1 and the high speed gearing at 1.6 to 1. These conditions correspond approximately to those ordinarily obtained on mechanical drive gasolene cars of this weight and capacity.

In the electric drive car the engine speed is independent of the car speed and is maintained at the normal value of 550 r. p. m. throughout the whole range of car speed. In the mechanical drive the engine speed is proportional to the car speed. It starts

at a low value with the starting of the car, and increases with the car speed up to 600 revolutions at a car speed of 10 m. p. h. At this point the change gear clutch is thrown in, the engine speed is cut down to 100 r. p. m., with the higher gearing, and is again raised with the car speed to 650 r. p. m., at a car speed of 50 m. p. h.

The engine horse power is approximately proportional to the engine speed. With the electric drive the horse power is maintained at 100 h. p. throughout the range of car speed, but with the mechanical drive the horse power varies, reaching its maximum value at the maximum speed corresponding to the two gear ratios.

The electric drive car, on account of its constant horsepower output, develops a tractive effort which varies inversely with the speed. At any point the product of speed and tractive effort is constant. The mechanical drive develops a maximum tractive effort of 3,400 lbs. up to a car speed of 10 m. p. h. At this point, where the high speed gearing is thrown in, the tractive effort drops to 900 lbs., which is maintained approximately constant through the further range of car speed. Gas electric cars will in practice develop a maximum tractive effort of 10,000 to 14,000 lbs., depending on the gearing.

Fuel—Gasolene and naphtha are the fuels ordinarily associated with the internal combustion engine for motor car service. These petroleum distillates are commercially graded and sold upon a gravity basis, using in general the Baume scale. The higher the gravity, the more volatile and desirable the distillate is assumed to be. This method of grading is inaccurate and misleading and where definite information is desired upon the characteristics of any distillate it must be superseded by a method based upon fractional distillation. If all other conditions were equal, the gravity would be a fair means of comparison, but at the present time when these distillates are obtained from petroleum of many fields and having different characteristics, it is a fact that gravity by the Baume or any other scale tells very little of the relative suitability of various gasolenes or naphthas.

Any one of the gasolenes embraces a number of compounds of different densities, and the hydrometer tells only the average density of the composition. The same gravity of a compound may be obtained either by straight distillation, or by blending very light distillates and heavy distillates in the proper proportions. While the gravity can be varied by proper blending, the boiling points of the components are unchangeable and by redistillation a blend can always be separated into its original components. In other words, by an examination by redistillation it is possible to accurately determine the composition of any gasolene or naphtha.

Utilization—In general, combustion engines utilize light distillates by means of an apparatus variously called a carburetor, vaporizer, or mixing valve. The action in this apparatus consists in breaking up the fuel into minute particles and thoroughly mixing it with air; for the best results the fuel should be so broken up as to be practically a vapor. The more volatile the fuel, the more easily it can be broken up and mixed with air. The nearer the boiling point of a compound is to its working temperature, the greater its volatility. Hence of any mixture the fractions of low boiling points are most easily volatilized and a knowledge of the boiling points of the various fractions is necessary to a knowledge of the behavior of the fuel as a whole. All of the fuel need not be of low boiling point, that is, easily vaporized; but there must be a sufficient percentage in order that starting will be assured. The remainder of the fuel must, however, be sufficiently volatile to be easily broken into a fog, or mist, and drawn into the cylinder without undue precipitation.

A knowledge of the boiling points is of much greater value in comparing relative suitability of the fuel than knowledge of the gravity. It is, therefore, recommended that the light distillates be specified and purchased by the boiling point method. By this method, the purchaser specifies the characteristics of

the fuel as determined by a fractional distillation test. Such a test consists in placing a certain quantity of liquid in a flask, vaporizing it, condensing the vapor and catching it in a graduate. The percentages of the original volume obtained at the various temperatures may then be plotted on curves as shown in Figs. 2 and 3, which are characteristic curves of gasolenes. If all conditions of petroleum composition and refining were the same the world over, gravity would then be a satisfactory means of comparison, for all curves would be of the same shape and parallel to each other as shown in Fig. 2, each curve representing a different gravity. Such, however, is not always the case, the true state of affairs frequently being as shown in Fig. 3. By the gravity method one would naturally expect a 72.5 deg. Baume gasolene to give better results than one of 63.6 deg. Baume, but in reality this particular 63.6 deg. Baume gasolene is much the better, as can be readily seen from the curves. This is contrary to the usual understanding and clearly indicates the fallacy of the gravity method of grading.

Specifications—It is a peculiar fact that all petroleum and petroleum products have practically the same heat value, 19,000 to 21,000 B. t. u. per pound, and as there is at present no suitable adulterant commercially practical, the heat value of petroleum

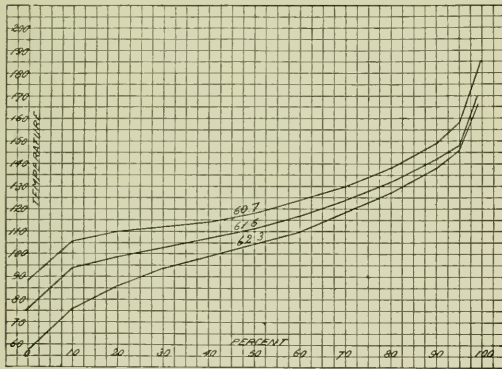

Fig. 2—Curves of Fractional Distillation of Gasolenes Prepared from the Same Crude and by Similar Refining Methods.

products can be satisfactorily assumed as above. As these products are usually purchased by the gallon and heat value specified at so much per pound, it can be easily seen that the most desirable fuel is the heaviest one that can be obtained of the specified boiling points.

Specifications for the purchase of these light distillates should give initial boiling point, that is, the point at which the liquid starts to vaporize, the final boiling point at which all liquid has disappeared from the flask and possibly two or three points in between and the percentages which should boil over at these temperatures. The initial boiling point should be the maximum temperature which will insure easy starting. Final boiling point should be set as high as possible so as to produce a fuel which will not burn too rapidly and yet this must not be so high as to cause carbon deposit. Fuel should, of course, be free from water and other impurities.

When the specifications of distillates are being prepared, it is well to consider the design of the engine and the purpose for which it is to be used. For instance, the ordinary automobile engine usually of high piston speed, working under varying loads, needs a distillate having a narrow range of boiling points, that is, quick burning fuel. Heavy duty engines of slow piston speed and fairly constant loads operate better with fuels having the initial and final boiling points a considerable way apart, as the slow burning fuel develops a higher mean effective pressure.

Automobile engines are also subject to another condition. Being required to start easily in cold weather, they must use a fuel having a larger percentage boiling at low temperatures than engines that are installed in buildings kept at a reasonable degree of warmth.

The following specification for liquid fuels will be found very satisfactory for use on gas electric cars. As a matter of fact, a considerable number of cars are operating with fuels having dry points in excess of those here specified. Fuel shall be free from impurities. The initial boiling point shall not be in excess of 185 deg. F. Dry point shall not be in excess of 356 deg. F. (Dry point will be indicated by a small puff of white vapor from residue in flask.) The fractional distillation proceeding at the rate of one drop per second should be recorded in 10 per cent. cuts. The first 10 per cent. should distill at a temperature not

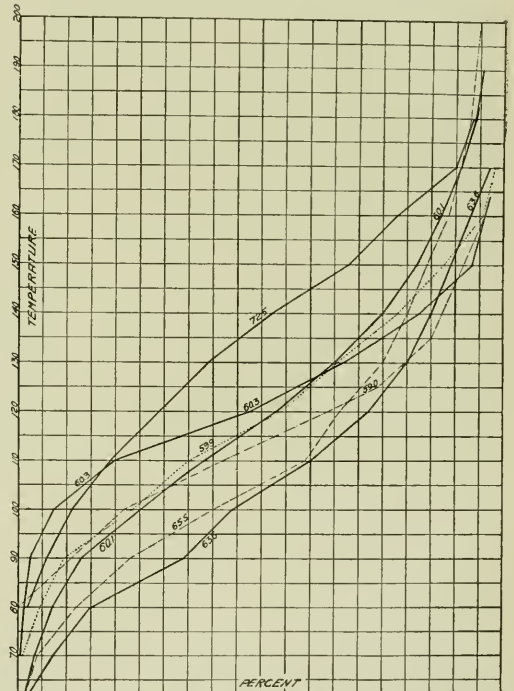

Fig. 3—Curves of Fractional Distillation for Miscellaneous Gasolenes.

in excess of 230 deg. F. Fifty per cent. should distill at a temperature not exceeding 270 deg. F. Not less than 97½ per cent. of the liquid should be recovered from the distillation.

Possibilities of Other Liquid Fuels—At present there is a widespread demand for a cheaper and more efficient fuel than gasolene and naphtha. The demand seems to have been met by a type of internal combustion engine utilizing heavy oils, generally known as the Diesel or high-compression oil engine. Much has been claimed for this apparatus, and the claims have been well substantiated in stationary and marine service, but as yet no engine of this type has been developed that is available for motor car service.

Generally speaking, alcohol, either wood, grain or denatured, is a fuel better even than gasolene, and undoubtedly will figure more prominently in the future than it has in the past. Its advantages lies in the fact that it can be obtained from any veg-

etable matter and is, therefore, available in nearly all parts of the earth. The apparatus required is simple, inexpensive and the cost of production small. Chemically, alcohol is a much more simple substance than gasolene and will be found more uniform. The one bar to its use is a legal one. The government requirements as to inspection, bonding and storing are such as to increase the price unduly. Once these restrictions are removed, alcohol should be a popular fuel. It is true that alcohol has a lesser heat value than gasolene, 14,000 B. t. u., as compared with gasolene at about 20,000, and, therefore, somewhat larger quantities will be needed for the same amount of work, but alcohol should be profitably sold for 4 or 5 cents a gallon if the legal restrictions were out of the way.

In Europe there is a gasolene substitute called benzol which is meeting with considerable success. This fuel is produced by the destructive distillation of coal. The price of benzol is against its use, however, for unless gasolene be over 25 cents a gallon, the cost of production of benzol from coal at \$1.75 a ton, even with the revenue derived from the other products of distillation, will prohibit its use.

Thus far no specifications or laboratory tests of oil have been found that are satisfactory for general use. The practical work-out test is by far the best means of determining the merits of a lubricating oil. When purchasing an oil its first cost should not be given undue importance.

Inspection and Maintenance—In order to get the best results out of any motor car it is essential that a definite scheme of inspection and maintenance be laid out. The practice of inter-urban electric roads is probably the best to follow. According to their practice, the motor cars should have a regular inspection at stated periods. This should be a combination of mileage and time. For any car, regardless of mileage, a thorough inspection should be made at least every ten days, and where long mileage is made at least every 2,000 miles. Where practical, it is desirable to have such inspection once a week. This inspection should be rigorous and requires a fairly skilled man to make it. The importance of thorough inspection of motor cars cannot be over-estimated. The man who will successfully take care of axle car lighting equipment is also well fitted to take care of the equipment on motor cars. One of the most effective ways of making inspections is to provide a list of questions for the inspector to answer.

The critical feature in caring for gasolene motor cars is the preventing of the radiators from freezing and the heating of the car. Where cold weather is encountered, a heated shelter is highly desirable.

The accompanying table shows the fuel and lubricating oil performance of a gas-electric car on the Frisco lines.

Motor car mileage	483,529
Passenger car miles	683,372
Average number cars per train	1.413
NAPHTHA.	
Gallons consumed	334,107
Cost (excluding handling)	\$22,823.51
Miles run per gallon	1.447
Cost per mile run0472
Car miles per gallon	2.045
Cost per car mile0334
Average price per gallon0683
LUBRICATION (GAS ENGINE).	
Gallons consumed	9,227
Cost (excluding handling)	\$2,779.07
Miles run per gallon	52.40
Cost per mile run0057
Car miles per gallon	74.06
Cost per car mile0041
Average price per gallon3011

DISCUSSION.

The operation of both the gas-electric and storage battery cars seems to be satisfactory at all points where they have been in service for any length of time. The men need considerable education before becoming good operators but not nearly as much as it takes to become an engineer of the steam locomotive. The subject of fuel was discussed at some length and it appears

that kerosene and lower grade distillates of petroleum are being used with success on some cars. A specification for fuel was advocated.

LOCATION OF STEAM HEAT TRAPS

In a paper on this subject, presented at the annual meeting of the Air Brake Association, C. W. Martin (Pennsylvania) included a number of illustrations showing the various locations of steam traps, and said, in part: The relation of the steam heat trap to the proper performance of the air brake equipment does not seem to be a close one, but to the air brake inspector in charge of equipment, who is called on to give an explanation of the cause of removal of wheels from passenger equipment cars which have been slid flat, the disposition of the water of condensation from the steam heat trap or drip becomes a serious problem. On postal and Pullman cars the number of steam traps has been increased from one or two with the wooden car, to six or seven with the later type of steel equipment, and these are located close to the truck, where the condensation drops on the rail directly in front of the wheel, or is blown back on the truck and brake rigging to freeze and add to the rigidity of the parts, preventing that portion of the truck which should be free to move in order to maintain an equal distribution of the weight of the car on the rail from adjusting itself to the inequalities of the track. This relieves some of the wheels of their proper proportion of the weight at the time the brake is applied, and permits them to slide.

While the introduction of the steel passenger car, with its heavy center girder, has made the proper location of the steam trap more difficult, it is still possible to place it at some point farther from the truck so that the condensation will not be carried back and freeze on the brake rigging, springs and pedestals, and far enough from the triple valve or control valve to avoid freezing up the ports. Where the traps cannot be located away from the truck or triple valve, some arrangement should be made to conduct the condensation close enough to the track to prevent its flying back under the car.

A sheet iron tube clamped to a trap of the vertical type may be used to conduct the water from the trap down close to the track and where the trap is located near the center of the car, gives very good satisfaction.

A guard placed around the trap on the side nearest the part to be protected, and fastened to the trap by a clamp held in place by a stove bolt or machine screw also gives satisfaction. The shield may be made from heavy sheet iron stiffened by a rib of half-round iron along the edge, or by flanging it over a heavy wire. While the object of this shield is to protect the truck from water and still allow the atmosphere free access to the trap, in order that any variation in temperature may affect it promptly, it has been criticized somewhat because of the water blowing around the edges of the guard because of its being wide and shallow.

Another device is made from a rubber hose, 4 in. in diameter, clamped to the trap and run as close to the track as desired. Where it is necessary to locate the traps outside the rail, this arrangement is preferable to either of those spoken of above. This is especially true when the cars are to be run in an electrified zone, where the third rail is used, as the hose is very flexible, not easily injured by striking an obstruction, and is a non-conductor. This matter is one which should be taken up by the car designers and builders, with a view to having these traps located at some point as far from the track as possible, and where this is not possible, to provide a suitable shield or guard to protect the brake rigging and equipment.

DISCUSSION.

Different members stated that they had experienced considerable trouble from slid flat wheels, caused by water from the

steam traps. It was also stated that the ice found on the trucks and brake rigging in winter would render the brakes inoperative. Mr. Martin said in reference to the use of the 4 in. hose that it was rather expensive and interfered with the changing of the trap diaphragm, but as this was only done every two years it was of no consequence. It is believed that the inconvenience and expense is well compensated for by the service rendered.

AIR HOSE FAILURES

A paper on this subject was read by T. W. Dow of the Erie at the annual convention of the Air Brake Association in Chicago. An abstract follows:

Several roads are making an accurate check of the cost of damage due to burst hose, intending to bring it before the M. C. B. Association to use as an argument for establishing a positive time limit in which to remove all hose from service. While the cost of such a practice might seem unwarranted and excessive to many, when it is compared with the cost of damage to equipment from the failure of the air hose it will be found that there will be a balance in favor of this practice. In checking several thousand 1½ in. air hose that had failed because of bursting during the year 1912, the average life was found to be less than 20 months, and a small percentage of the number had been manufactured over 24 months; and it has been suggested by a number of mechanical officials that under the existing conditions it did not appear to be unreasonable to limit the service of air hose to the latter figure, or 24 months.

In making the stretching test on 1 in. sections of various inner tubes it was found that some developed noticeably large holes which at first were very small. These were due to particles of grit which were seen in the rubber before being stretched. It is believed that such conditions account for the large number of porous hose. It is maintained by many, however, that the practice of pulling hose apart is responsible for short life, and it is possible that the pulling apart has a tendency to open up the pores in the inner tubes similar to the conditions developed in the stretching test.

During the soap suds test of the air hose on a large number of trains during the warm season of 1912, it was found that about 10 per cent. were porous. A large portion of this number were porous throughout the entire length of the tube, but many were noticed leaking only at the nipple end, having been injured probably by being bruised, and it is thought that this may be aggravated by the new recommended location of the angle cock, 11 in. back of the pulling face of the knuckle.

While a large number of air hose fail, due to the tube blowing off the fittings, a check during the year 1912 showed a lesser number than during the year 1911. This may have been due to a local condition rather than to any improvement in the make-up of the inner tube, or to the method of fastening, but it is thought that serious consideration should be given to both.

Failure through chafing, being burned, torn off and damaged couplings still continues, but all such can be eliminated by proper attention to the location of the pipes and a regard for a rule that has been many years in print, but not in force, whereby all hose should be uncoupled and not pulled apart. From examinations made, it would appear that air hose manufactured within the two years just passed fail more rapidly than those manufactured four or five years ago.

DISCUSSION.

C. W. Martin (Pennsylvania) stated that tests seemed to indicate that inner tubes with a greater tensile strength were required.

H. F. Wood (B. & M.) presented a report on the life of various grades of hose, which seemed to indicate that the service could consistently be limited to two years.

T. E. Hessenbruch (P. & R.) stated that out of 1,200 pieces of defective hose taken from the scrap pile and given a pres-

sure test of 125 lbs., 54 per cent. were porous, having been in service on an average of 18 months; 24 per cent. failed on the nipple end and 11 per cent. on the coupler end; 3 per cent. were weather beaten, being in service on an average of 48 months; 1 per cent. were cut by the trap; 1 per cent. were torn, and 6 per cent. had miscellaneous failures. Considerable trouble was experienced from rust collecting in the groove of the coupling which prevented the gasket from having a good bearing.

Many members spoke of difficulty experienced in the cold climates with frozen hose. Under such conditions it was found impossible to keep the hose connected, and the gaskets would become torn. It was reported that certain manufacturers produce a hose that will remain flexible in cold weather. Another member stated that a better grade of hose than is commonly used, together with 4-ply canvas, would give good results. The wide face hose gasket has also given very good satisfaction. C. W. Wheeler (N. Y. C. & H. R.) has found it necessary to wire hose together in extreme low temperature.

C. N. Remfry (D. M. & N.) stated that his road made a practice of limiting the life of air hose to two years—although the average life was two years and two months—and claimed a material saving had been made when considering the damage that is done to the equipment by hose failures. He also found that the hose gave better service when the distance between the coupler knuckle and angle cock key was 11 in.

It seemed to be the consensus of opinion that all air hose should be removed from service after it had been used for a certain definite time. The subject was continued for further consideration next year.

CAR WHEEL FAILURES

In a letter to the editor of the *Railway Age Gazette*, published in the issue of May 9, 1913, George W. Lyndon, secretary of the Association of Manufacturers of Chilled Car Wheels, takes exception to the following statement in the *Iron Age* of March 6, 1913:

The necessity of bringing the quality of the chilled iron car wheel to a proper basis is emphasized today as it has never been, and the makers and users should get together and try and find means of improving the quality of car wheels to make them equal to present service conditions.

The following are extracts from Mr. Lyndon's letter:

Apparently the writer of the article does not know that the Association of Manufacturers of Chilled Iron Car Wheels, representing 95 per cent. of the wheels manufactured in the United States, and the Master Car Builders' standing committee on car wheels have been closely associated since the year 1909 for the express purpose of improving the quality of the chilled iron wheel.

Previous to the year 1909, individual wheel makers had made improvement in their patterns and product, but no concerted action had been taken until the year 1909, when standard wheels for the three classes of cars of 30, 40 and 50-ton capacity were submitted by the manufacturers and approved by the Master Car Builders' Association. Before these three standards were adopted there were as many different patterns as there were manufacturers, and many railroads had standard patterns of their own. The standards recommended were not in general use until the year 1911, because the Master Car Builders' Association gave the manufacturers a sufficient time to adjust their equipment to the new standards.

In analyzing the derailments caused by broken flanges and burst wheels for the purpose of determining what progress has been made in the quality of the chilled iron wheel, we must consider the dates that the wheels were cast, and not charge all the failures during the year 1912 against the product of that year. This is the only proper basis upon which to proceed.

In determining the percentages of derailments of cars due to broken flanges and broken wheels, the number of failures in any one period cannot be consistently compared with another unless

the number of wheels in service is considered, and it is manifestly unfair to state that during the period of 1902-3-4 there were 1,070 derailments, and during the period of 1910-11-12 there were 1,827, and figure an increase of 70 per cent., as was done by the above mentioned writer. In 1902 there were 1,500,000 freight cars in service, representing 12,000,000 wheels; in 1910 there were 2,133,000 freight cars in service, representing 17,068,248 wheels—an increase of 40 per cent. in the number of wheels in service; and this increase represents wheels serving under heavy capacity cars.

The Chilled Iron Car Wheel Manufacturers, in conjunction with the Master Car Builders' Association, have made greater progress in the chilled iron wheel industry since the year 1909 than has ever before been made, and when consideration is given to the vast increases in car capacity, and the resultant increases in rail and axle during the last decade, and the slight increase in the weight of the wheel, it will be found that the chilled iron wheel has not only met every condition of service imposed for the past 52 years, but the record will show that the derailments due to broken flanges and burst wheels are actually decreasing. The following table shows the changes that have been made in developing the 10-ton car to the 50-ton car:

Weight, increase in car capacity.....	400 per cent.
Weight, increase in rail.....	100 per cent.
Weight, increase in axle.....	149 per cent.
Weight, increase in chilled iron wheel.....	38 per cent.

One part of the chilled iron wheel that has not received due consideration is the flange. In an editorial in *Harper's Weekly* (Industrial series), December 28, 1912, appears the following: "It is a curious fact that in this matter of flanges the cars of today are no better off than were the cars that carried soldiers and supplies to the battlefields of the Civil War."

This condition is not because the wheel makers have not been fully alive to the situation, but because they have been restricted in improvements due to the supposed limits of track clearance. Reviewing the improvements in the flange made since 1904 indicates a slight increase of metal in the back of the flange in 1904, as the weight of the wheel increased from 630 lbs. to 700 lbs.; also that during 1909 a further increase was made, starting at a point slightly below the base line and extending around the flange and back of the tread, producing an increase in tread thickness and increasing the weight to 725 lbs. These slight changes, together with a reduction in the height from 1½ in. to 1 in., are the only improvements made in the flange, and it must be remembered that the capacity of the cars has increased from 10 tons to 50 tons. This was all we could get, but not as much of an increase as we wished to make in order to increase the factor of safety.

We are still trying to improve the flange, but cannot go further until such a time as the railroads will approve the design for a flange for 140,000 lbs. capacity cars. When this is done flange failures will be reduced to a minimum.

Many times in looking for the cause of a derailment a wheel will be found with a broken or chipped flange, and this cause is readily assigned, whereas, as a matter of fact, the flange may have been chipped or broken after it left the track, or through poor track, faulty truck construction, etc. We know of cases where a broken flange was reported as the cause of a derailment, and upon investigation we have found that the flange had been worn beyond the condemning limit. Many derailments are reported to the Interstate Commerce Commission caused by sharp flanges climbing the rail in going around curves, or passing crossings, frogs, or switches.

Year Cast.	Broken Flanges.	Year Cast.	Broken Flanges.
1888	2	1908	12
1899	9	1909	13
1900	4	1910	16
1901	7	1911	2
1902	7	1912	2
1903	12		
1904	10		
1905	8		
1906	16	No record of year cast.....	170
1907	23		457
	34	Total reported	627

Let us examine the above record of broken flanges for the year 1912, as compiled from the Interstate Commerce reports.

As will be seen, we have a record of 170 wheels out of a total of 627 reported broken, or 27 per cent. The service is from one to twenty-four years, and the average life of all the 170 wheels is over six years.

As a flange is at its best when first put into service, it will be interesting to note the comparatively few failures for wheels cast during the years 1910-11-12. The total breakages of flanges in the three years amounted to 20 wheels. The report shows that during the year 1910 there were 16 breakages, only two in 1911 and two in 1912. As we only have a record of 27 per cent. of the broken flanges during this period, and as this record shows 16 wheels were cast in 1910, it would be reasonably fair to assume that the balance of the wheels (if tabulation could be made) would bear relatively the same proportion of breakages—therefore, we can assume that if we had a complete record, there would have been broken approximately 60 wheels cast in 1910. During the year 1910 there were in service over 2,000,000 freight cars, and there were running over 16,000,000 chilled iron wheels. This would represent one wheel broken for every 266,000 wheels in service. If we take the total breakages, which are reported as 627, and consider the number of wheels running, we will find that there is one breakage for every 25,000 wheels in service and the broken flange wheels which we have tabulated from the Interstate Commerce Commission reports show an average of six-and-a-half years' service. Surely this is not an alarming condition when we take into consideration that a very large percentage of those broken were of the old design and plainly show abuse due to sticking brakes and excessive wear.

We will now analyze the report of broken wheels. Our record, as compiled from the Interstate Commerce Commission report, shows the detail of 109 broken wheels as to years cast, name of maker, etc. There were 229 breakages for which we could obtain no record. An analysis of the 109 wheels reported is shown in the following:

Year Cast.	Broken Wheels.	Year Cast.	Broken Wheels.
1889	1	1908	5
1892	1	1909	9
1897	1	1910	14
1899	1	1911	10
1900	5	1912	7
1901	3		
1902	8		109
1903	9	Broken and loose tires on	
1904	4	engine drivers.....	19
1905	6	No record of year cast.....	229
1906	12		
1907	13	Total	357

It will be observed that the broken wheels, like the broken flanges, are distributed over a period of years, starting with the year 1889, and the average service of all wheels broken is over six years. The cause assigned for the breakage of 52 wheels out of the 109 reported by the Interstate Commerce Commission is "brakes sticking."

Fifty per cent. of the broken wheels were caused by "brakes sticking," and 90 per cent. of the broken wheels occurred in the mountainous regions of the East and West, where the maximum of brake resistance is required in descending grades. A large number of these wheels plainly show improper usage.

It is no uncommon thing to find 625 lb. wheels under cars weighing from 45,000 lbs. to 50,000 lbs.; in fact, many 60,000 lbs. capacity cars weigh light more than 100,000 lbs. capacity cars. The Master Car Builder's Assn. in its 1912 Proceedings recognized the question of establishing the maximum braking power as well as gross load for each design of wheel, and called particular attention to the trouble experienced in using 625 lb. wheels under 60,000 lbs. capacity cars, having tare weight of 40,000 lbs. to 47,000 lbs., such as refrigerator cars, etc.; if their recommendations are followed broken wheels will be practically eliminated.

If we take the entire number of chilled iron wheels broken during the year 1912 and base these breakages upon the number of wheels in service, we will find there is, comparatively, one broken wheel for every 50,000 wheels in service.

NEW DEVICES

IMPROVED THROTTLE LEVER RIGGING

The American Locomotive Company has designed and applied to a number of locomotives an improved arrangement in connection with the throttle lever and its attachments. This construction provides for the complete assembling of the lever and

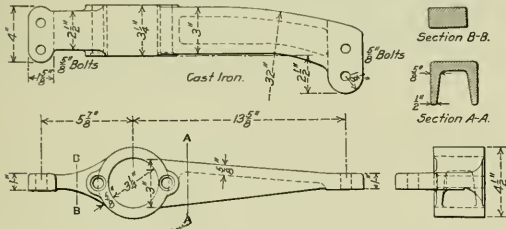

Casting Which Supports the Lever and Its Connections.

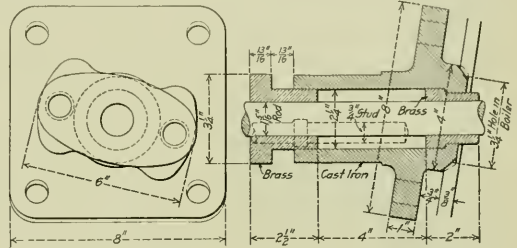

Stuffing Box Arranged to Carry the Throttle Lever Rigging.

its connections before the parts are sent to the erecting shop and requires the laying out and drilling of but two holes for applying it to the boiler. It has the further advantage of permitting an adjustment in the height of the throttle lever handle, if

at one end and the quadrant at the other. The bearing on the stuffing box in the application illustrated, which is the design as applied to Mikado locomotives for the Grand Trunk, has a length of 3/4 in. and a diameter of 3/4 in., giving a rigid support

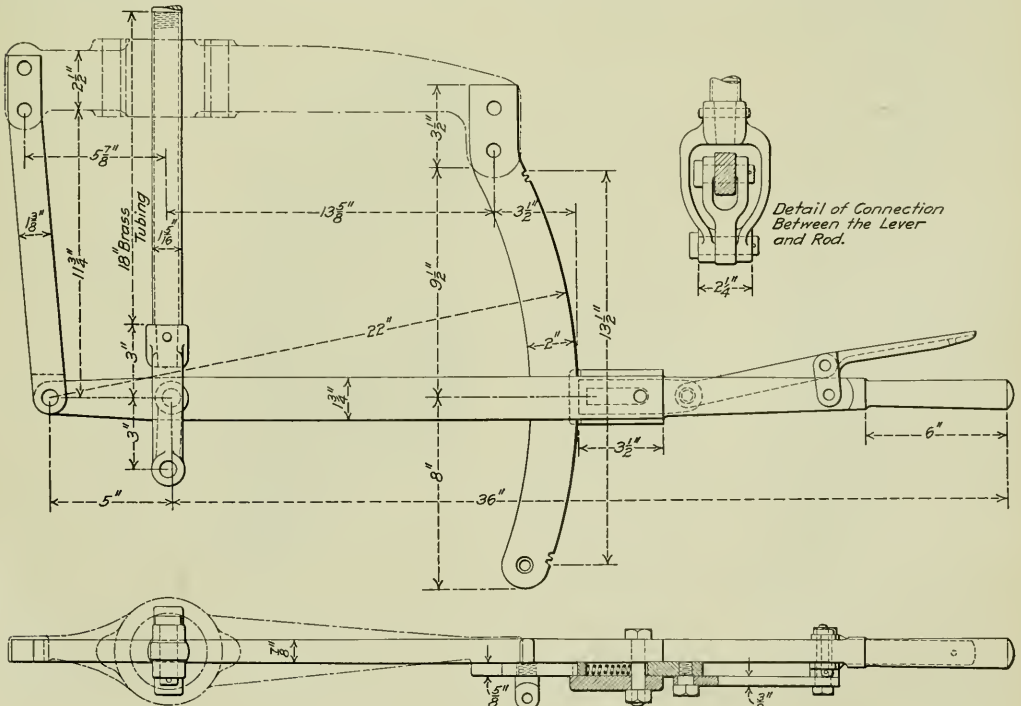

Adjustable Throttle Lever Rigging; American Locomotive Company.

desired for more convenient operation, or a change in the position of the lever if it is found that it interferes with the operation of any of the attachments on the back boiler head, which

for the whole rigging. There are two studs holding this casting in place and, by using slotted holes, it is possible to change the angle of the lever as desired. An improved yoke connecting

the lever to the rod is used in this case. It is made of malleable iron and is somewhat lighter than previous arrangements. The details of its construction are clearly shown in the illustration. In other particulars the construction does not depart from the previous standard practice of this company.

LITTLE DAVID RIVETING HAMMER

Several novel features have been incorporated in the design of a pneumatic riveting hammer recently perfected by the Ingersoll-Rand Company, New York. In these hammers, which have been given the name "Little David," the valve chamber is located at the side of the cylinder, permitting the use of pistons of different lengths without liability of valve breakage.

The cylinder and handle are both drop forged, and are held together by two bolts instead of the usual threaded connection. This permits the ready separation of the two parts for inspection or repairs without the use of a vise or bar. All of the wearing parts are hardened and the outside of the hammer is sand blasted, giving a rough surface and a better grip. These hammers are both shorter and lighter than previous designs of the same power, and are provided with a very sensitive throttle control which makes them especially suitable for drift pin work. Two sizes are being built, providing a 6 in. and an 8 in. stroke. The former is suitable for work up to 7/8 in. diameter rivets and the latter up to 1 1/4 in. diameter rivets.

Reference to the drawing will show the arrangement of the interior parts. The exhaust passage is of large volume and liberal area and a single port is used for admission. The action of the valve and piston is controlled by the variation of pressure alternately on different faces of the valve. This is accomplished by the piston opening a small port leading to the bottom of

Section Showing Arrangement of Parts and Passages in the "Little David" Air Hammer.

the valve when it is near the end of its stroke, which, in connection with the proper proportioning of the various feed ports in the valve chamber, gives the valve a reciprocating, cushioned movement, admitting air alternately through the top port for the downward stroke and through the large exhaust port for the upward stroke of the piston.

There is a small port admitting live air to the very top of the cylinder which cushions the piston after it passes the ad-

mission port. A strainer is provided through which all the air entering the hammer must pass, thus preventing the admission of dirt or other foreign matter to the working parts. This ar-



An Improved Air Hammer for Riveting.

angement of ports and passages has greatly reduced the recoil, and the hammer is very well suited for steel car work.

AIR HOSE COUPLING

At the recent convention of the Air Brake Association at St. Louis, attention was directed to the trouble experienced from rust collecting in the groove of the air hose coupling, which prevented the gasket from having a good bearing. The Sheafe coupling, which is shown herewith, was designed for overcoming

this, as well as other difficulties. This coupling has a brass bushing inserted in its face. The gasket groove is made in this bushing, so that when the gasket is inserted it touches nothing but brass, and is therefore not affected by any rust. The coupling has a smoother seat than is possible with malleable iron and it will remain smooth for many years. It is claimed to save 50 per cent. of the gaskets and to give much more efficient service. Leakage at the coupling is a large factor in air brake operation; it not only interferes with the correct manipulation of brakes, but increases the service required of the compressor. These couplings have been in service since 1909, and are now standard on two railroads. They are manufactured by the Central Engineering Company, with headquarters at

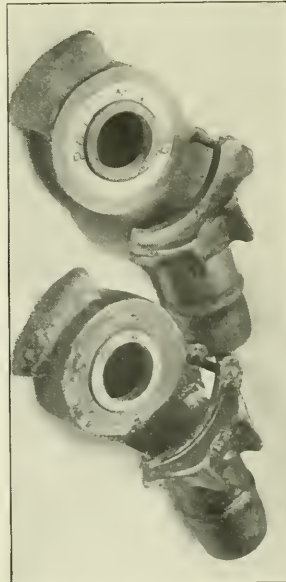

Sheafe Air Hose Coupling Compared with One of the Standard Iron Couplings.

Chicago and are sold by Guilford S. Wood, also of Chicago.

COST OF FULL CREW LAWS—The Erie estimates that the full crew laws will cost it \$447,180 yearly. The Erie works under such laws in New Jersey, Pennsylvania, Ohio and Indiana, and there will be one in New York after September 1.

SAFETY DEVICES FOR LOCOMOTIVE BOILERS

Burst Water Glasses and Defective Squirt Hose Cause Over 48 Per Cent. of the Accidents.

In an editorial on water glass shields in our issue of May, 1913, page 227, we directed attention to the importance of using a type of shield which will prevent injuries to the members of the engine crew from flying glass when the tubular glass breaks and from escaping steam and hot water. An improved water glass shield used on the new Lake Shore Mikados was illustrated on page 235 of the same issue. In the following article two improved shields are described which are reported to have given good results on the Delaware, Lackawanna & Western, and the Pittsburgh & Lake Erie.

A device was also used on the Lake Shore engines which makes it possible to use cold water from the tender tank for wetting down the coal and the engine deck, thus eliminating danger of scalding due to the bursting or forcing off of the connections of the squirt hose. Two devices are described in this article for preventing such accidents, one an armored hose with special connections, and the other an ejector which furnishes water at a comparatively low temperature.

DELCO SAFETY WATER GLASS SHIELD.

The Delco safety water gage shield, which is shown in the illustration, was devised to prevent the flying of broken glass

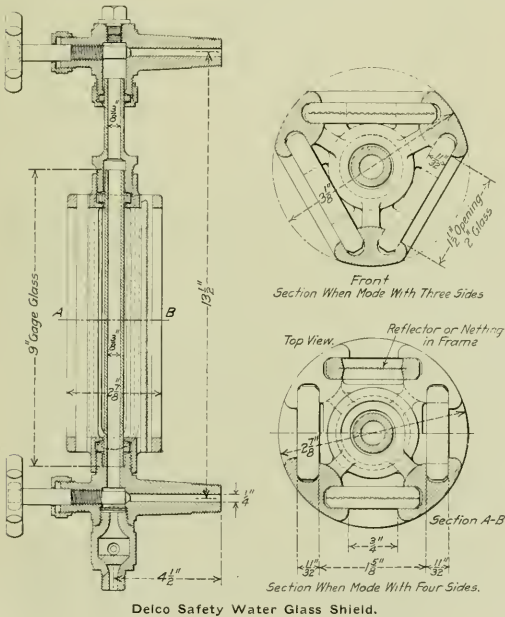

Delco Safety Water Glass Shield.

and boiling water and also the scalding of the hands of persons engaged in turning off the gage cocks after a water glass bursts. It consists of a one-piece body fitted with glands to receive the regular tubular glass, and with slots for the heavy glass protecting plates. The glass shield is omitted at the rear and a perforated plate, or netting, is inserted in its place to permit of the escape of the water and steam when a gage glass bursts; this prevents the steam and water from blowing down and scalding the hands of any one engaged in turning off the gage cocks. The shield is made in a standard length which permits the use of tubular glasses with fused ends, thus overcoming

breakages due to rough edges which frequently start progressive fractures. The one-piece construction also permits the water glass to be perfectly alined and overcomes the difficulty of the glass breaking due to a twisting action on account of one of the fittings being out of line. Tubular extensions are provided so that the shield may be assembled complete before application to the boiler, and may be applied between boiler fittings placed any distance apart. As the water glass is contained in the shield itself, it is impossible for any one in renewing a glass to forget the application of the shield. A straight passage is provided entirely through the water glass and boiler fittings so that a wire may be passed through to clean out obstructions, as is required by law.

The Delco shield is the invention of H. C. Manchester, superintendent of motive power and equipment, Delaware, Lackawanna & Western, and over 750 of them are in use on that road. It is manufactured by the American Safety Lamp & Mine Supply Company, Scranton, Pa.

BABCOCK SAFETY WATER GAGE.

In the designing of safety water gages it is most important that the passage provided for the escape of the steam and water after a water glass bursts be amply large, as otherwise pressure

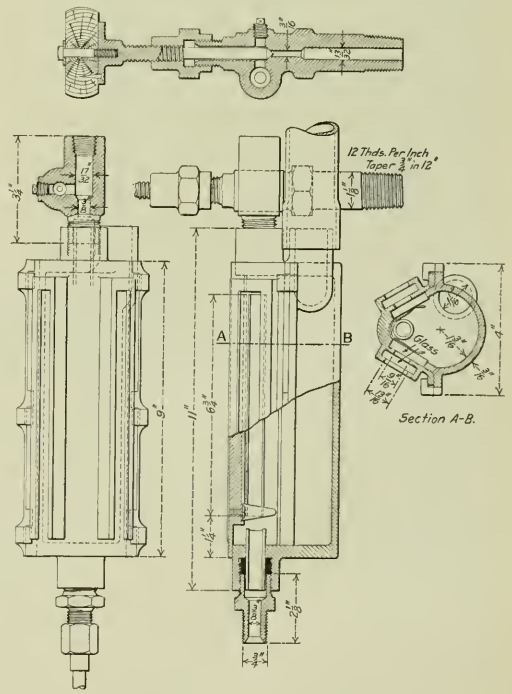

Babcock Safety Water Gage.

will accumulate and cause the breakage of the protective glass in the shield, and the steam will pass directly into the cab. In the gage which has been adopted as standard on the Pittsburgh & Lake Erie a pipe, shown in the illustrations, has been provided to carry off the broken glass, as well as the steam and water

during the interval while the gage cocks are being closed. This safety gage is provided with two sets of heavy glass plates, an outer and an inner, the latter being held in place by steel springs. The purpose of the inner plate is to absorb the shock of the explosion and in case the inner plates should break there is still left the outer set to prevent the escape of the steam and broken glass into the cab. These protecting plates are set at such an angle that both the engineman and the fireman can get a plain view of the inner tubular glass. It is further claimed that the breakage of the inner plates is very unlikely, owing to their location permitting only a glancing blow from particles of broken glass.

The safety gage is the invention of F. H. Babcock, assistant

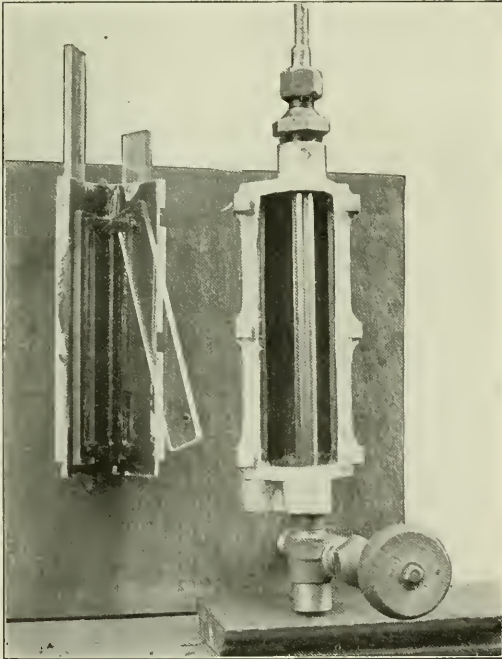

Babcock Safety Water Gage with Glass Removed.

boiler shop foreman, Pittsburgh & Lake Erie, McKees Rocks, Pa., and is manufactured by the American Car & Ship Hardware Manufacturing Company, New Castle, Pa.

EJECTOR FOR COAL SPRINKLING.

It is the general custom in wetting down the coal on locomotives to take the water supply from the delivery pipe of one of the injectors through a squirt hose and the necessary connections. The water in the injector delivery pipe is at a temperature and pressure sufficiently high to cause serious accidents in cases where the hose bursts. The device shown in the two illustrations, for the sprinkling of locomotive coal, is entirely independent of the injector, taking its steam supply from a pipe branching off from the blower pipe. The principle is the same as that of a lifting injector; steam is admitted through a $\frac{1}{2}$ in. globe valve and raises the water through the suction pipe which is connected to the main delivery pipe from the tender. A $\frac{1}{2}$ in. valve is placed in this suction pipe to prevent waste of water in case the apparatus is located below the highest water level in the tender, and also to prevent air being drawn into the suction of the injector should there be an obstruction in the suction

hose. The quantity of steam used is very small, and, although there is an ample supply of water under sufficient pressure to sprinkle the coal, the temperature is so low that no serious accident can occur and there is an absence of the steam which is very commonly seen in the cab of a locomotive when the squirt hose is being used.

This device was developed and is being manufactured by the

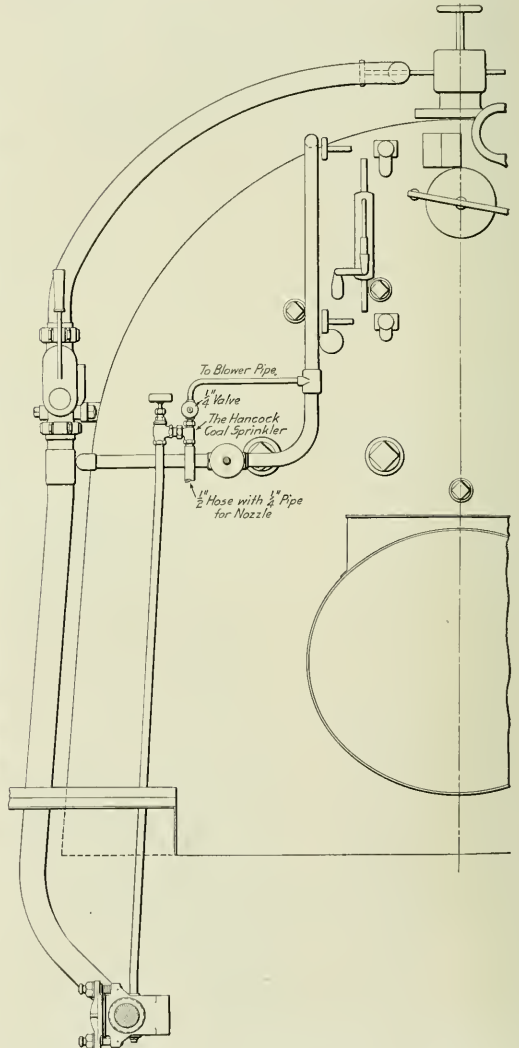

Application of Hancock Ejector for Sprinkling Coal.

Hancock Inspirator Company, Boston, Mass., and is being applied to 150 Baltimore & Ohio locomotives.

ARMORED SQUIRT HOSE.

Accidents due to defective squirt hose and connections are caused by the bursting of the hose or by the hose being forced off its connection, thus allowing the steaming hot water to scald the firemen, and in some instances the enginemen as well.

In many cases a cheap grade of garden hose is used, which soon fails under the severe service to which it is subjected and in other cases the hose is very insecurely fastened to its connection. The Woven Steel Hose & Rubber Company, of Trenton, N. J., has for a number of years been manufacturing a flexible armored hose. It was first adapted for use as a squirt hose about three years ago, and is reported to have given good results and to

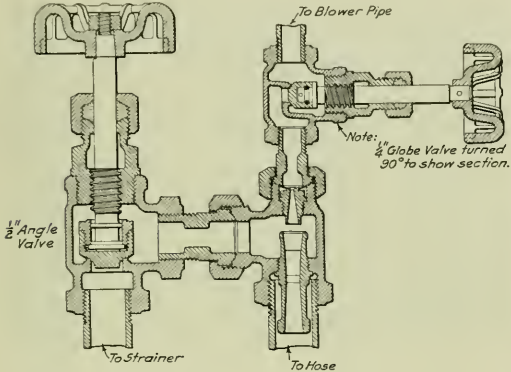

Section Through Ejector for Coal Sprinkling.

have an exceptionally long life. Five thousand locomotives are said to be equipped with it, on such roads as the Pennsylvania, Baltimore & Ohio, New York, New Haven & Hartford and the Boston & Maine.

The hose is made with a steam tube instead of a water tube, and will therefore last much longer under the action of the hot water. It is covered with a strong flexible covering of steel,



Armored Squirt Hose.

protecting it against exterior wear and the chafing caused by the constant vibration of the locomotive. Special fastenings, which are clearly shown in the illustration, have been devised to prevent it from blowing off the nipple.

Obviously the first cost will be much higher than that of the type of hose ordinarily used for this purpose, but it is said to last so much longer that its cost per unit of time is considerably less.

OFFSET BORING HEAD

An offset boring head, designed for the accurate boring of holes wherever it is more convenient to revolve the cutter than the work, has been perfected by Marvin and Casler, Canastota, N. Y. It consists of a cylindrical cast iron body which carries across its face a strong steel offsetting plate that is held from turning by a key, and is adjusted in an offset position by a ease

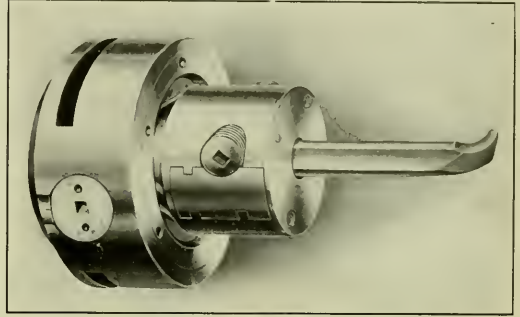

Offset Boring Head in Central Position.

hardened screw which is graduated to read to a thousandth of an inch. This plate is threaded to receive a chuck or boring bar, and is adjustably tensioned and held in place by a ring nut. Offsets from 3/16 in. to 5/8 in. are provided and the illustrations show the boring head when central and in its extreme position.

By using a boring tool having an offset cutting edge, a combination of turning the tool in the chuck and the use of the offset in the head, permits the boring of a wide range of diameters with the same tool. While these boring heads are par-

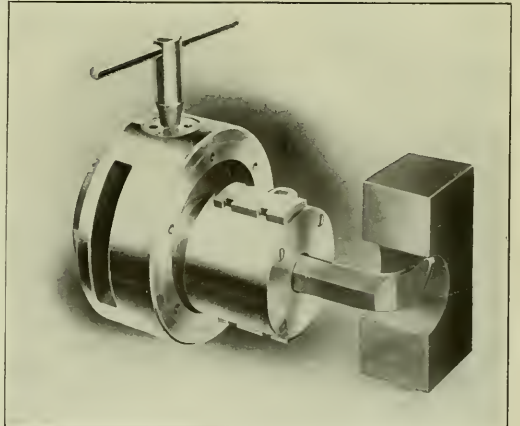

Boring Head Offset to the Limit of Its Movement.

ticularly adapted for use on milling machines, they have also been found suitable for work on a turret lathe, especially for recessing, and also on drill presses for work which may be too heavy or cumbersome for a lathe or milling machine.

DEATH RATE IN COAL MINES.—The death rate per 1,000 men employed in the coal mines of the United States in 1912 was 3.15, as against 3.73 in the previous year.

NEW MODEL DRIVING WHEEL LATHE

A set of four 56 in. driving wheels turned in 2 hours and 7 minutes is a record recently made at the Richmond, Va., shops of the Chesapeake & Ohio. This was made possible by using a new lathe which has ample power for making very heavy cuts and is provided with a number of new attachments for increasing the speed of the work when the machine is not cutting. In making this record, the average depth of cut was 5/16 in., the feed was 9/16 in. and the cutting speed varied from 15 ft. to 17 ft. per minute. This means the removal on an average of 33 3/4 cu. in. of metal a minute which, according to Mr. Pomeroy's chart, published on page 248 of our May issue, would require about a 35 h. p. motor. Inasmuch as the machine is provided with a 50 h. p. motor, which will permit the removal of 50 cu. in. per minute, it is evident that even heavier cuts could be taken and a record as good as this could be made under even more difficult conditions.

An examination of the details of this record, shown in the

Pair Number.	SET FROM FIRST ENGINE.			
	Time Putting in Lathe. Minutes.	Time Roughing and Finishing. Minutes.	Time Taking Out of Lathe. Minutes.	Time from Floor to Floor. Minutes.
1.	5	30	4	39
2	6	26	4	36
3	7	28	4	39
4	5	26	3	34

Pair Number.	SET FROM SECOND ENGINE.			
	Time Putting in Lathe. Minutes.	Time Roughing and Finishing. Minutes.	Time Taking Out of Lathe. Minutes.	Time from Floor to Floor. Minutes.
1	3	21	3	27
2	5	25	3	34
3	5	30	2	37
4	5	21	3	29

In both cases—Diameter of wheels, 56 in. Average depth of cut, 5/16 in. Average feed, 9/16 in. Cutting speed, 15 to 17 ft. per min. Total time for turning complete set, first engine, 2 hours 28 minutes. Total time for turning complete set, second engine, 2 hours 7 minutes.

table herewith, indicates that it was not so much the saving in the cutting time that made it possible, as the reduction in the

traverse for the tail-stock. This is arranged with a separate motor and controller, located in a convenient position, and a friction safety device is included to prevent damage in case the face plate is brought up too forcibly against the wheel. The grips on the outside of the tire are then set up and the clamp bolts inserted and tightened. A cam mechanism is provided for clamping the tail-stock, which is operated by a single lever.

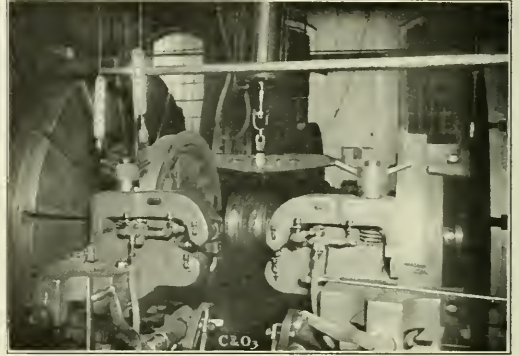

Pneumatic Tool Clamps and Motor Control Switches on New Driving Wheel Lathe.

In making this record, the following methods were followed: After the worst worn pair of wheels in the set was in place in the lathe, the smallest wheel was selected and the roughing tool was inserted in the tool post and run in to the lowest point of the tread. The tool slide was then marked and the tool drawn back, the rest moved over to the outside of the

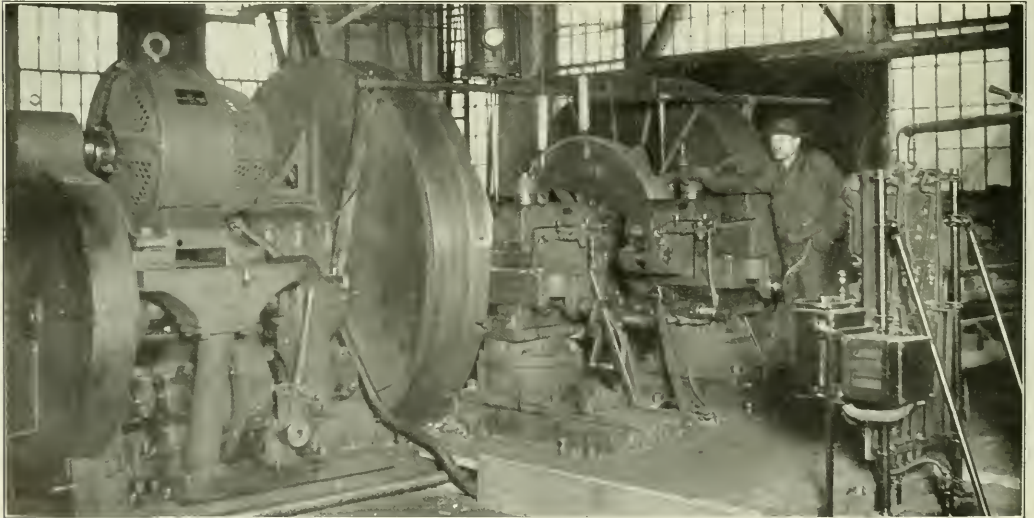

New Model Wheel Lathe Which Turned a Set of Four 56 in. Wheels in 2 Hrs., 7 Min.

time required for putting the wheels in and out of the machine and the method employed to reduce waste time in adjusting the tools and calipering the work. A power traverse for the tail-stock, a pneumatic tool clamp and a permanent calipering arrangement are provided. Putting the wheels in the lathe in from 3 min. to 7 min. is made possible largely by the power

tire, and the tool run in beyond the mark an amount sufficient to build up the flange. The cut was then started on this wheel and the calipering attachment which is part of the machine was employed to make the other wheel the same size without trial or adjustment of the tool. The roughing cut was then run across the tread, requiring from eight to eleven revolutions.

The tool was then withdrawn an amount equal to the height of the new flange. This operation was facilitated by previously determining the number of turns of the crossfeed screw that is required for this standard distance. Two or three revolutions are required for running the roughing tool across the top of the flange. This tool was then removed and the flange roughing tool—the third tool from the left side in the illustration—was inserted and formed the flange in about two revolutions. The combination flange and tread tool shown at the right of the group was next inserted and finished the flange and part of the tread in from two to three revolutions. The chamfering tool, shown as the second from the left in the illustration, was then put in the tool post and finished the tread in from two to three revolutions. Before removing the wheels, the slide was marked when the nose of the roughing tool, which was again clamped in the rest, was against the finished tread. The tool was then run back and after the following set of tires was in place, the marked slide allowed the cut to be immediately started



Tools Used in Making New Record for Turning Driving Wheel Tires.

without further adjustment or trial. Removing the clamps, running back the tail-stock and removing the wheels required from three to four minutes.

It will be noticed that a flange roughing tool is used in this case although accepted good practice does not require it. This is done because the machine has a pneumatic push clamp which permits a very prompt changing of tools. It would not be advisable to make this change if a clamp requiring a longer time was used. One of the illustrations shows this style of tool clamp and it will be seen that by the movement of the valve handle on a three-way valve, the wedge between the rollers on the outer end of the clamp is promptly forced out or drawn in by the air cylinder, located in the center. A coiled spring under the adjusting screw raises the clamp and releases the tool as the wedge is withdrawn.

Another new feature of this machine which has aided in breaking previous records for time, is the magnetic push button control that is provided when a direct current motor is used to drive the lathe. Two push button switches are suspended near the cutting tools, one for starting and stopping the motor, and the other for slowing down the speed. This gives the operator control from a convenient position and he can readily slow down the machine when hard spots are encountered or stop it at

the moment the cut is completed without moving from his post.

This new lathe is made considerably heavier and more powerful than previous designs and in a number of shops throughout the country, records practically equal to those quoted are being made. The machine is built by the Niles-Bement-Pond Company, New York.

MARK COLD DRAWN STEEL UNION

The Mark Manufacturing Company, Chicago, has placed on the market a pipe union made entirely of cold drawn steel. These unions are made from flat strip steel which provides a fitting that is seamless, free from sand holes, pin holes or other similar structural defects. The process of manufacture of the male member of the union is shown in one of the illustrations. Discs are cut from flat strips of steel and drawn to deep cups

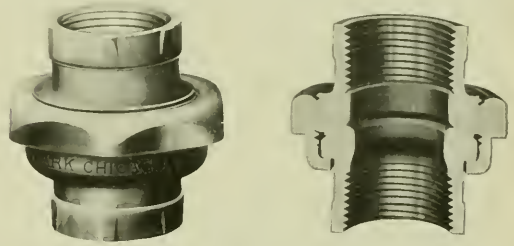

Mark Cold Drawn Steel Union.

from which the bottoms are punched. One end of the tube is then folded or rolled back on itself to form a reinforcement and later pressed to its final shape, making a dense, hard steel seat. The lower end is then upset. The brass seat ring is also drawn cold from flat soft stock and annealed after drawing to keep it soft. Both the steel seat and brass ring are formed in dies and do not require machining or grinding.

The union is threaded to the Briggs standard pipe thread

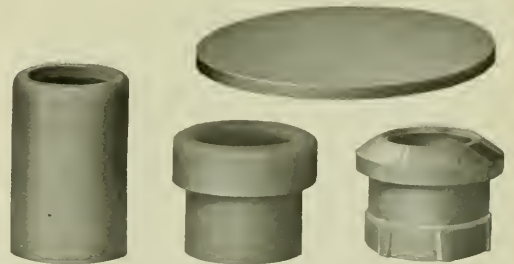

Various Steps in the Manufacture of Mark Cold Drawn Steel Unions.

and carries the same taper as the pipe. Each union is put through the Sherardizing process after the threads are cut so as to protect all surfaces from corrosion. An important feature of this union is that it has the same coefficient of expansion as the wrought-steel pipe to which it is applied and will, therefore, be less liable to leakage and will require less attention than unions made of different material. The Mark union has shown up remarkably well under tests.

LAST BROAD GAGE LOCOMOTIVE IN ENGLAND.—With the changing to standard gage of the broad gage railway, 1¼ miles long, at Holyhead, England, the last locomotive with a 7 ft. gage will be taken out of service.

HEAVY DUTY BACK GEARED SHAPER

A shaper designed to meet the heaviest requirements and embodying a number of new features is shown in the illustration. In order to protect the machine against any possibility of breakage, a new cross feed has been developed which makes it impossible to feed against the cut. A reciprocating motion is imparted to *A* through the usual type of cross feed rod and the click *B* is, in turn, moved over the internal ratchet gear *C*, giving it an

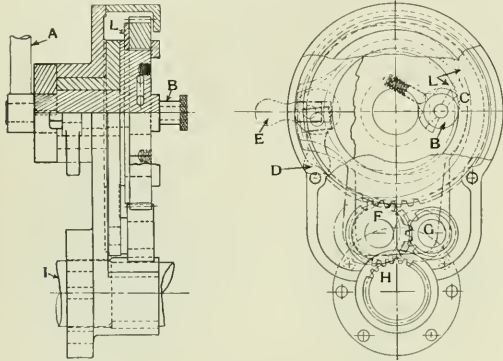

Arrangement of the Cross Feed on the New Stockbridge Shaper.

intermittent motion which is determined by the amount of feed. The motion of *C* is communicated to the cross feed screw *H*, either directly through the intermediate gear *F* or through the two intermediate gears *F* and *G*; by this means the direction of feed is changed. In order to secure these two positions in the

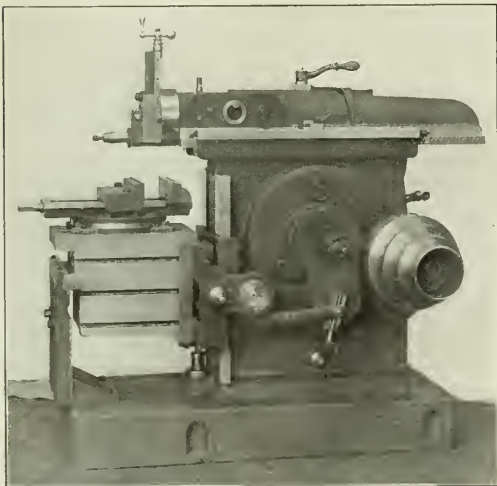

Heavy Duty Shaper; Stockbridge Machine Company.

train, the two intermediate gears are supported on a rocker which may be thrown to any one of three positions; one with the handle at *D*, when the feed is direct through the gear *F*; another by moving the handle through an arc of 180 deg. and feeding through the two intermediate gears *F* and *G*; the third with the handle in the 90 deg. position *E*, when the gears are neutral and the yoke *L* has been raised sufficiently to automatically throw the

click *B* out of engagement with the gear *C*. In this way, it is claimed, all possibility of the gears becoming caught when changing the direction of feed is eliminated and the saving of time will be appreciated by everyone who has had occasion to use a shaper on work where it was desired to feed across in one direction and then back without having each time to change the cross feed rod or the direction of feed by adjusting the screw. Another advantage claimed for this motion is that it is impossible for the operator to feed on the cut and there is thus no danger of cross feed parts being broken.

The base of the machine is heavily designed to absorb vibration and provide sufficient strength to support the weight without springing. It is slightly concaved on the outside and has a pan cast on the inside to protect the floor from becoming oil soaked, the oil being drained to a pocket from which it can be drawn off. The driving cone is supported on an independent bearing built out from the shaper column. The belt pull is carried entirely by this bearing, the driving shaft being driven by a two-jaw clutch *F* shown in another of the illustrations, and carried by an independent bearing. The cone bearing which is bolted to the column of the machine is shown at *A*; *B* is the bushing and *C* is the cone

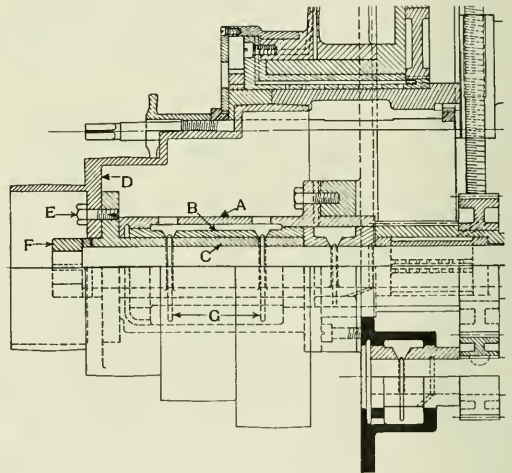

Clutch and Driving Shaft of the Stockbridge Shaper.

hub. The cone is indicated by *D* and is bolted to the cone hub by means of four bolts *E*. The oil rings *G* keep the bearing flooded with oil and all shaft bearings are bushed and self-oiling.

The shaper is equipped with the Stockbridge patented two-piece crank motion giving a 3 to 1 quick return; the crank is provided with a double bearing which eliminates all overhang and maintains alinement. A telescopic screw with ball thrust bearings is provided for raising and lowering the table; the top of the knee is made separate and hooks over the saddle. The ram can be adjusted to any length of stroke and taper packings, adjusted from either end by means of screws, are provided to take up wear. The table support automatically adjusts itself to any height and gives a bearing the entire width of the table.

This shaper has been developed by the Stockbridge Machine Company, Worcester, Mass. The following are some of the principal dimensions:

Length of stroke	20 3/4 in.
Vertical range of table	13 in.
Cross range of table	26 in.
Greatest distance, ram to table	15 1/2 in.
Diameter of head	8 1/2 in.
Feed of head	9 in.
Top of table	14 in. x 20 in.
Side of table	14 in. x 15 in.
Vise opens	13 1/2 in.
Vise jaws	13 3/4 in. x 3 in.

Number of steps on cone.....	4
Number of speeds to ram, cone drive.....	8
Number of speeds to ram, gear box drive.....	10
R. p. m. of countershaft.....	350
Total ratio of gearing, back gears.....	26.4:1
Total ratio of gearing, direct drive.....	6.6:1
Ratio of cutting and reverse strokes.....	3:1
Weight of machine and countershaft.....	3,750 lbs.

DRILL SPEEDER

It is sometimes desirable to be able to drill holes less than $\frac{5}{8}$ in. in diameter while the work is on a large radial or other type of comparatively slow operating drilling machine. These large size machines are seldom provided with the speeds necessary for small size drills. An attachment which makes it possible to use the smallest size drill on any size drilling machine has been designed by the Graham Manufacturing Company, Providence, R. I., and is shown in the illustration. It consists of a nest of gears, enclosed in a small case, which triple the speed of the spindle. It is arranged to fit the standard size shanks of ordinary drill presses and to allow the insertion of very small drills at the bottom, either by a chuck or taper socket. As will be seen, the small drill is on the same center line as the spindle of the machine and the arrangement is such that no end thrust is conveyed through the speeder. The gears and pinions within the case are arranged in pairs and side strains are entirely eliminated. The lower end of the shank, extending downward inside the hollow spindle, reaches nearly to the bottom of the case, insuring a correct alignment. A bar fastened to the case by a thumb screw prevents the attachment from turning. This is long enough to reach to the column in the case of a large upright drill, but when used on a radial drill some rigid stop must be provided, or the bar can be held by the hand, if desired. In the drill speeder shown the feeding of the drill is done by the mechanism on the machine. Other styles, however, have sensitive feed levers that permit the feeding through a racked sleeve within the speeder itself.

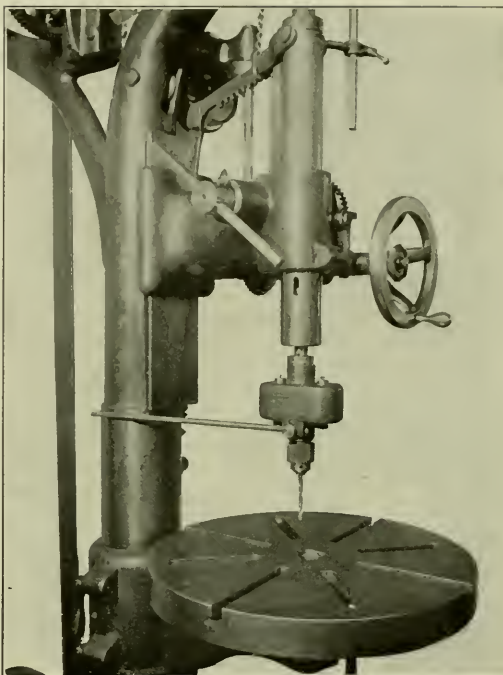

Application of Drill Speeder to Upright Drill.

HYDRAULIC FORGING AND BENDING PRESS

The illustration shows a hydraulic forging and bending press for locomotive and car shop work, such as the making of equalizer bars and other heavy bending and straightening, which is commonly done in a geared type of bulldozer. This machine will handle a wide range of work, and the application of the power is direct and positive. A further advantage claimed for it is that of being safe from breakage, due to the operator putting in work

return stroke and ample power for stripping the dies. The field for such a press in a locomotive or car shop is large, and it is claimed for this machine that it will accomplish such work at minimum cost.

This press is manufactured by the Chambersburg Engineering Company, Chambersburg, Pa.

MILL FOR GRINDING LIME.—The latest agricultural enterprise reported by a railroad is that of the New York, New Haven & Hartford in establishing a mill, at West Stockbridge, Mass., to

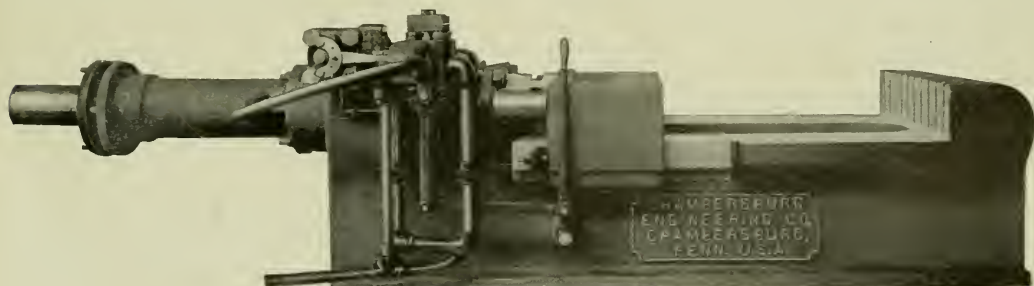

Hydraulic Press for Heavy Forging and Bending.

which has become too cold or is too large, which in a geared type of press results in stripped gears, etc. A number of these machines have been installed in locomotive building plants; the usual capacity is 100 tons, arranged so that either 40, 60 or 100 tons may be used, depending on the size of the work. This results in a saving of power. A large pullback provides a quick

grind lime for the benefit of the farmers of western Massachusetts and Connecticut. Representatives of the industrial bureau maintained by the road, learning that one of the principal needs of the soil in New England was lime, cast about for a supply of that article; and they found that the extensive deposit near West Stockbridge was of a suitable character.

NEWS DEPARTMENT

The Southern Railway has made a general increase in the pay of shop men.

The Union Pacific is now a double track road from Omaha, Neb., to Cheyenne, Wyo., 516 miles. This is the longest stretch of double track railroad west of the Missouri River.

The Minneapolis, St. Paul & Sault Ste. Marie has announced a plan for the organization of a co-operative association among employees, to be open to any who have been in the service of the company for six months or longer, under which employees will be allowed to set aside a portion of their earnings to be invested in securities of the company.

Electrical repair shops designed to handle all of the electrical equipment of the New York, New Haven & Hartford are approaching completion at Van Nest, Bronx Borough, New York City, and it is expected they will be in operation by August 1, or a short time before the electrification of the road from Stamford to New Haven is finished. The new shops represent an outlay of about \$650,000 and cover two acres of ground. They are made up of an inspection shed, repair shop proper, lye vat house, blacksmith shop, storehouse and power house. The inspection shed has four track pits 375 ft. long. The repair shop proper covers nearly an acre and a half of ground, the power house 3,000 square feet and the storehouse 7,500 square feet.

ILLINOIS CENTRAL EMPLOYEES OFFER AID TO THE COMPANY

Officers of the Illinois Central were greatly surprised recently to receive a communication signed by a large number of clerks, engineers, conductors and other employees requesting that they be permitted to give one or more days' pay to aid the company in making repairs rendered necessary by the recent floods in the south. The employees also sought permission to solicit contributions from all employees on the payroll of the company by means of the following statement: "We feel as railroad employees that we should deeply deplore these unfortunate conditions and to the end that the Illinois Central may have our assistance, co-operation and support in rebuilding and repairing bridges, track and equipment, we hereby appeal to you to join us in the contribution of the equivalent of one or more days' pay to that end." In declining the offer, Vice-president W. L. Park said in part: "In all my railroad experience, in the ranks and as an officer, I never have encountered so unselfish and loyal an offer. That these men should voluntarily tender their mite to assist their company (and I use the word 'their' advisedly, for such men are really partners in the institution) is an evidence of such patriotic loyalty and self-abnegation that I am inclined to the belief that it is unparalleled in railroad history."

DEDICATION OF NEW BUILDINGS AT UNIVERSITY OF ILLINOIS

The new transportation building and the new locomotive and mining laboratories of the engineering department of the University of Illinois were dedicated with appropriate exercises at Urbana, Ill., on May 8, 9 and 10. At the opening session on May 8, J. G. Pangborn, special representative of the president of the Baltimore & Ohio, presented an address outlining the history of the various inventions which led up to the use of steam for propulsion and the development of the various types of the steam locomotive. The program for Friday began with a railway conference in the Transportation building, at which B. A. Worthington, president of the Chicago & Alton, dis-

cussed "Modern Problems of the Steam Railway," and W. B. McKinley, president of the Illinois Traction System, "The Modern Problems of the Electric Railway."

Robert Quayle, general superintendent of motive power of the Chicago & North Western, spoke on "How Can the Technical School Help in the Solution of Railway Problems?"

Samuel O. Dunn, editor of the *Railway Age Gazette*, spoke on "Research as a Factor in Railway Administration."

The formal dedicatory exercises were held on Friday afternoon in the university auditorium. Dr. W. F. M. Goss, dean of the College of Engineering, presided and addresses were made by Dr. E. J. James, president of the university; W. L. Abbott, president of the board of trustees; and Willard A. Smith, editor of the *Railway and Engineering Review*. A "Mining Conference" was held on Thursday and Friday.

GERMAN PASSENGER CARS

In a paper on the Administration of the State Railways of Prussia-Hesse, recently delivered before the New York Railroad Club, by W. J. Cunningham, some statistics of passenger cars are given as follows:

Altogether there are 51,703 passenger, baggage and mail cars in Prussia, or 222 per 100 miles of line. In group 2 of the United States the passenger train car density is 52; in the United States as a whole, 20. Of the Prussian equipment 68 per cent. have side entrances and 32 per cent. have end doors and vestibules. The latter are used almost exclusively in through trains. More than half of the passenger cars have three axles, one under each end of the car and one under the center; 33 per cent. have but two axles; and the remaining 13 per cent. are of the modern type for the best trains and have four or six axles. Averaging all passenger train cars, the number of axles per car is 2.72. The older type of two or three axle car with side doors is very small and weighs about 20 tons. The modern corridor car, with four or six axles, is 60 ft. long, 9½ ft. wide, and weighs from 45 to 55 tons. The capacity of the car depends upon the classification of the compartments. There are four classes. First-class compartments seat four passengers (two per seat); second-class, six passengers; third-class, eight passengers. Fourth-class compartments are much larger, but only a limited number of seats are provided for the first comers—the other passengers stand. As a rule, those who stand in fourth-class compartments far outnumber the fortunate few with seats. There is little difference between first and second-class compartments except in the quality of the seat covering and in the number of passengers per compartment. The seats are of equal length (about 6 ft.). In first-class compartments, therefore, each passenger has about 3 ft. of seat space. Second-class passengers each have 2 ft. of seat space. In both cases the arm rests, which mark the seat divisions, may be pushed up out of the way, and when the compartment is not filled the seat may be used as a sofa. A party of three or four passengers traveling together very frequently have the compartment to themselves. At important stations seats in through trains may be reserved in advance without charge. Each compartment and seat is numbered and the place ticket issued by the reservation clerk gives unquestioned right to the seat reserved.

A very few of the cars are exclusively first class. About 11 per cent. are first and second-class combined. The same percentage combines second and third-class. Third-class cars comprise 40 per cent. of the total, and 29 per cent. are fourth-class. The remaining cars have various combinations of classes.

MEETINGS AND CONVENTIONS

American Railway Tool Foremen's Association.—The annual convention will be held at the Hotel Sherman, Chicago, July 22, 23 and 24, and the prospects are that there will be a record attendance.

International Railway General Foremen's Association.—The annual convention will be held at the Hotel Sherman, Chicago, July 15-18. Reports have been prepared on apprenticeship, shop schedules, engine house efficiency, maintenance of superheater locomotives and driving box work. Indications are that the meeting will be even more largely and enthusiastically attended than that of last year. Application for membership should be made to the secretary, William Hall, 829 W. Broadway, Winona, Minn.

Traveling Engineers' Association.—The twenty-first annual convention will be held at the Hotel Sherman, Chicago, Ill., commencing Tuesday, August 12, 1913, and continuing four days.

The subjects to be discussed are as follows: Uniform instruction to engineers on the handling of superheater locomotives, J. W. Hardy, chairman. Credit due the operating department for power utilization and train movement that reduces the consumption of fuel per ton mile, M. J. Howley, chairman. The care of locomotive brake equipment on line of road and at terminals, also methods of locating and reporting defects, H. A. Flynn, chairman. The following papers will be read: Advantages obtained with the brick arch in locomotives, LeGrand Parish. What can we do to eliminate the black smoke evil on locomotives? J. H. Lewis. Scientific train loading and tonnage rating; the best methods to obtain maximum tonnage haul for the engine over the entire division, taking into consideration the grades at different points on the division, O. S. Beyer, Jr.

Illuminating Engineering Society.—At a meeting of the convention committee, held in Pittsburgh Friday, May 16, it was decided to hold the next annual convention in that city during the week beginning September 22. The convention committee consists of: C. A. Littlefield, New York Edison Company, chairman; P. S. Millar, Electrical Testing Laboratories, president of the society; H. S. Evans, Macbeth Evans Glass Company, Pittsburgh; W. A. Donkin, contract manager Duquesne Light Company, Pittsburgh, Pa.; D. MacFarlan Moore, General Electric Company, Harrison, N. J.; M. C. Rypinski, Westinghouse Electric & Manufacturing Company, New York; C. J. Mundo, General Electric Company, Pittsburgh; J. C. McQuiston, Westinghouse Electric & Manufacturing Company, Pittsburgh, Pa.; W. J. Scerrill, United Gas Improvement Company, Philadelphia, Pa.; S. B. Stewart, Philadelphia Company, Pittsburgh, Pa.; T. J. Pace, Westinghouse Electric & Manufacturing Company, Pittsburgh, Pa., and Professor H. S. Hower, Carnegie Technical Schools, chairman of the local section of the society. W. A. Donkin of the Duquesne Light Company, was selected as chairman of the local committee on arrangements which will have charge of the convention. J. C. McQuiston of the Westinghouse Electric & Manufacturing Company, was appointed chairman of the publicity committee and will make all arrangements for advertising the convention.

Canadian Railway Club.—A. H. Kendall, foreman of the locomotive erecting shop, Angus shops, Canadian Pacific, presented a paper at the April meeting on the subject of "System as Applied to Shop Repairs of Locomotives." A general description of the system in use at the Angus shops formed the principal part of the paper. A number of charts and reproductions of forms used in connection with this system were included. The general master mechanic's office prepares a monthly statement for the shop, which gives the number of locomotives expected to be shopped from each division during the following month. This includes the general classification of the repairs and also shows in a general way the chief causes for shopping the engine. With this at hand, the ordering of the necessary material and other preparations can be made before the engines actually reach the

shop. The system also includes an inspector's or demonstrator's department which takes care of the standardization of the machine operations and methods. The shop works on a straight piece-work basis, the price schedule being detailed, so far as is practicable, so that when more than one operator is called on to work on the same piece, each is paid for the portion that he may do. There is a schedule department which provides each department, each day, with a list of the work required from it for that day. There are standard schedules arranged, copies of which were reproduced in the paper, and every effort is made to adhere strictly to them. A general progress sheet is supplied to the shop superintendent each day which shows where any deviation from the required schedule may have taken place and, in addition, a general operation and delay sheet is furnished, which gives the causes for any delay where it is possible to do so.

New York Railroad Club.—Frederick C. Syze, trainmaster of the Baltimore & Ohio at St. George, Staten Island, N. Y., presented a paper entitled "Thoughts on Discipline" at the May meeting. After briefly reviewing the general features that govern good discipline, Mr. Syze gave a general description of the methods in vogue on the Baltimore & Ohio which were originated by A. W. Thompson, third vice-president. In this system the practice of suspending employees in engine and train service because of infractions of the rules, or for other causes, is discontinued. A complete and accurate record of each employee is maintained and in case of infraction of the rules, after investigation, a suitable entry is made on the employee's record. A central discipline bureau has been organized and the system requires the use of printed forms, one of which is made in triplicate, giving the record of the employee after each new entry. A carbon copy of this is sent to the employee and must be signed by him and returned. W. G. Besler presented a discussion on this subject in which he reviewed the fundamental characteristics of good discipline. J. G. Dickson, division superintendent of the Erie at Jersey City, described the methods of discipline in vogue on that road. All matters that may be the proper cause for punishment are considered at a staff meeting of the division officers who have regularly stated weekly meetings for this purpose. The recommendations of the staff, acting as a discipline committee, are enforced and it is seldom that a case is carried to a higher officer on appeal. F. W. Brazier, superintendent rolling stock, New York Central & Hudson River, recommended the use of complimentary letters or oral communications whenever an occasion arises that justifies it.

The following list gives names of secretaries, dates of next or regular meetings, and places of meeting of mechanical associations.

AIR BRAKE ASSOCIATION.—E. M. Nellis, 53 State St., Boston, Mass.

AMERICAN RAILWAY MASTER MECHANICS' ASSOC.—J. W. Taylor, Old Colony building, Chicago. Convention, June 11-13, 1913, Atlantic City, N. J.

AMERICAN RAILWAY TOOL FOREMEN'S ASSOCIATION.—A. R. Davis, Central of Georgia, Macon, Ga. Convention, July 22-24, 1913, Chicago, Ill.

AMERICAN SOCIETY FOR TESTING MATERIALS.—Prof. E. Marburg, University of Pennsylvania, Philadelphia, Pa. Annual convention, June, 1913.

AMERICAN SOCIETY OF MECHANICAL ENGINEERS.—Calvin W. Rice, 29 W. Thirty-ninth St., New York. Annual meeting, December 3-6. Engineering Societies' Building, New York. Railroad session, Thursday morning, December 5.

CAR FOREMEN'S ASSOCIATION OF CHICAGO.—Aaron Kline, 841 North Fifthieth Court, Chicago, 2d Monday in month, Chicago.

INTERNATIONAL RAILWAY FUEL ASSOCIATION.—C. G. Hall, 922 McCormick building, Chicago.

INTERNATIONAL RAILWAY GENERAL FOREMEN'S ASSOCIATION.—William Hall, 829 W. Broadway, Winona, Minn. Convention, July 15-18, 1913, Chicago, Ill.

INTERNATIONAL RAILROAD MASTER BLACKSMITHS' ASSOCIATION.—A. L. Woodworth, Lima, Ohio. Convention, August 18, 1913. Richmond, Va.

MASTER BOILER MAKERS' ASSOCIATION.—Harry D. Vought, 95 Liberty St., New York.

MASTER CAR BUILDERS' ASSOCIATION.—J. W. Taylor, Old Colony building, Chicago. Convention, June 16-18, 1913, Atlantic City, N. J.

MASTER CAR AND LOCOMOTIVE PAINTERS' ASSOC. OF U. S. AND CANADA.—A. P. Darr, B. & M., Reading, Mass. Convention, Sept. 9-12, 1913, Ottawa, Can.

RAILWAY STOREKEEPERS' ASSOCIATION.—J. P. Murphy, Box C, Collinwood, Ohio.

TRAVELING ENGINEERS' ASSOCIATION.—W. O. Thompson, N. Y. C. & H. R., East Buffalo, N. Y. Convention, August 12-15, 1913, Hotel Sherman, Chicago, Ill.

PERSONALS

It is our desire to make these columns cover as completely as possible all the changes that take place in the mechanical departments of the railways of this country, and we shall greatly appreciate any assistance that our readers may give us in helping to bring this about.

GENERAL

FRANK B. BARCLAY, master mechanic of the Illinois Central, at McComb, Miss., has been appointed superintendent of motive power of the lines south of the Ohio river, and of the Yazoo & Mississippi Valley, with headquarters at Memphis, Tenn.

ROBERT W. BELL, superintendent of machinery of the Illinois Central at Chicago, has been appointed general superintendent of motive power of the Illinois Central and the Yazoo & Mississippi Valley, succeeding M. K. Barnum, resigned.

MORGAN K. BARNUM, who has resigned as general superintendent of motive power of the Illinois Central and the Yazoo & Mississippi Valley, was born April 6, 1861. He graduated from Syracuse University in 1884 with the degree of A. B. and later received the degree of A. M. He began railway work the year he graduated as a special apprentice in the shops of the New York, Lake Erie & Western, now the Erie, at Susquehanna, Pa. He was then consecutively machinist and mechanical inspector and later general foreman of the same road at Salamanca, N. Y.; general foreman of the Louisville & Nashville shops at New Decatur, Ala.; assistant master mechanic of the Atchison, Topeka & Santa Fe at Argentine, Kan.;

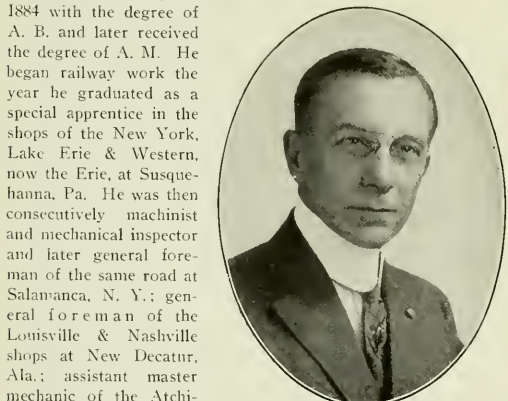

M. K. Barnum.

superintendent of shops at Cheyenne, Wyo.; district foreman at North Platte, Neb., and then division master mechanic at Omaha, Neb., on the Union Pacific; assistant mechanical superintendent on the Southern Railway. In February, 1903, he was made superintendent of motive power of the Chicago, Rock Island & Pacific, and in April of the next year was made mechanical expert of the Chicago, Burlington & Quincy; in 1907 he was appointed general inspector of machinery and equipment of the same road. He left that road in April, 1910, to become general superintendent of motive power of the Illinois Central and the Yazoo & Mississippi Valley, the position he now leaves.

J. W. G. BREWER, superintendent of the Mount Clare shops of the Baltimore & Ohio, has been appointed assistant superintendent of motive power of the main line district with headquarters at Baltimore, Md.

H. W. GARDNER has been appointed supervisor of material of the Lake Shore & Michigan Southern, with headquarters at Cleveland, Ohio, succeeding F. H. Hanson, promoted.

GEORGE O. HAMMOND has been appointed assistant mechanical superintendent of the New York, New Haven & Hartford, with headquarters at New Haven, Conn., and the position of assistant to the mechanical superintendent has been abolished.

JOSEPH H. NASH, superintendent of the Burnside shops of the Illinois Central, has been appointed superintendent of motive

power of the lines north of the Ohio river, with headquarters at Chicago.

H. C. OVIATT, general inspector of the New York, New Haven & Hartford, has been appointed assistant mechanical superintendent, with office at New Haven, Conn., and his former position has been abolished.

G. W. WILDIN, mechanical superintendent of the New York, New Haven & Hartford, has been placed in charge of the maintenance of electric locomotives and multiple unit cars and the operation and maintenance of power stations, and his jurisdiction has also been extended over the Central New England.

MASTER MECHANICS AND ROAD FOREMEN OF ENGINES

W. A. BEDELL, master mechanic of the St. Louis, Iron Mountain & Southern at Van Buren, Ark., has been transferred to Jefferson City, Mo.

W. BORRIDGE, district master mechanic, District No. 2, Eastern division and Montreal terminal of the Canadian Pacific, at Montreal, has been appointed district master mechanic, District No. 5, Eastern division, with headquarters at Smiths Falls, Ont.

J. F. BOWDEN has been appointed master mechanic of the Baltimore & Ohio at Newark, Ohio. Mr. Bowden served his apprenticeship in the Baltimore & Ohio shops at Keyser, W. Va., starting in March, 1885. He became roundhouse foreman at Grafton in September, 1895, and general foreman at Washington, D. C., November 1, 1898. He was then general foreman at Cumberland, Md., and at Benwood, W. Va., and was appointed master mechanic at Parkersburg, W. Va., in September, 1907. He was transferred in the same capacity, December 1, 1908, to Garrett, Ind., and now becomes master mechanic of the same road at Newark, Ohio, as noted above.

J. M. BURKE has been appointed district master mechanic, District No. 4, Eastern division of the Canadian Pacific, with headquarters at Ottawa, Ont.

A. L. CREW, road foreman of engines of the Atchison, Topeka & Santa Fe, at San Bernardino, Cal., has been transferred to Los Angeles, Cal.

JAMES A. CULLOM has been appointed general road foreman of engines of the Atchison, Topeka & Santa Fe, at Shopton, Ia.

W. A. CURLEY, master mechanic of the Missouri Pacific at McGehee, Ark., has been transferred to Van Buren, Ark., succeeding W. A. Bedell, transferred.

WILLIAM H. DYER has been appointed master mechanic of the Georgia & Florida, with headquarters at Douglas, Ga., succeeding E. C. Hanse, assigned to other duties.

H. F. GREWE, general foreman of the mechanical department of the Washash-Pittsburgh Terminal and the West Side Belt, at Carnegie, Pa., has been appointed master mechanic in charge of locomotive and car departments of both companies, with headquarters at Rook (Carnegie, Pa.).

JOSEPH McCABE has been appointed master mechanic of the Shore Line division of the New York, New Haven & Hartford, with headquarters at Harlem River, N. Y. Mr. McCabe was born on December 6, 1863, at New Rochelle, N. Y., and was educated in the public schools of his native town. He began railway work on August 11, 1881, with the New York, New Haven & Hartford and in 1885 was appointed fireman and later was made engineman. In December, 1902, he was promoted to road foreman of engines, and in January, 1907, was made master mechanic, and then general road foreman of engines later in the year. In April, 1912, he was appointed master mechanic of the Western division, and now becomes master mechanic of the Shore Line division of the same road, as above noted.

F. W. NELSON, road foreman of engines, Western division, New York, New Haven & Hartford, has been appointed general road foreman of engines with office at New Haven, Conn., succeeding C. H. Reid, promoted.

C. H. REID, general road foreman of engines of the New York, New Haven & Hartford, has been appointed master mechanic of the Western division, with office at Waterbury, Conn., succeeding Joseph McCabe, transferred.

F. W. RHUARK has been appointed master mechanic of the Baltimore & Ohio, at Garrett, Ind. Mr. Rhuark began railway work as a water boy with the Baltimore & Ohio in June, 1879. He was then a machinist with the Lake Shore, the Toledo & Ohio Central and the Chicago & Alton railroads. In 1893 he became road foreman of engines of the Baltimore & Ohio, and was later in the service of the Big Four, the Erie and the St. Louis & San Francisco railroads. He was appointed machine shop foreman of the Baltimore & Ohio in January, 1906, and then was successively general foreman and motive power inspector until December 1, 1910, when he was appointed master mechanic at Lorain, Ohio, the position he now leaves.

WILLIAM J. RIDLEY has been appointed road foreman of engines of the Fargo division of the Northern Pacific at Fargo, N. D.

T. R. STEWART has been appointed master mechanic of the Baltimore & Ohio, at Cumberland, Md. Mr. Stewart began railway work with the Baltimore & Ohio in September, 1886. He was consecutively boilermaker, foreman, roundhouse foreman and general foreman until February, 1904, when he was appointed master mechanic, and is now transferred in the same capacity from the Riverside shops, Baltimore, Md., to Cumberland, as above noted.

WILLIAM S. TASKER, master mechanic of the Rock Island Southern at Rock Island, Ill., has had his jurisdiction extended over the entire road.

T. M. VICKERS, formerly master mechanic of the San Pedro, Los Angeles & Salt Lake, has been appointed general foreman of the Oregon Short Line at Pocatello, Ida.

J. M. WHALEN has been appointed master mechanic of the St. Louis, Iron Mountain & Southern, at McGehee, Ark., succeeding W. A. Curley, transferred.

CAR DEPARTMENT

W. J. HALLETT, car foreman of the Grand Trunk at Allandale, Ont., has been appointed traveling car inspector of the Ontario lines and districts Nos. 8, 9 and 10 of the Eastern lines, with headquarters at London, Ont.

F. H. HANSON has been appointed assistant master car builder of the Lake Shore division of the Lake Shore & Michigan Southern, with headquarters at the Collinwood shops, Ohio.

J. S. JACKSON, general car foreman of the Canadian Northern Quebec at Joliette, Que., has been appointed foreman of the new passenger car shops at Limoilou Jct., Que.

T. MARTIN, foreman of the repair yard of the Canadian Pacific, at Winnipeg, has been appointed foreman of the freight car shop, succeeding H. N. Osborne, transferred.

H. N. OSBORNE, foreman of the freight car shop of the Canadian Pacific, at Winnipeg, has been appointed general car foreman of the Ogden shops, Calgary, Alta.

S. J. PIGGOTT, assistant foreman of the car repair yard of the Canadian Pacific, at Winnipeg, has been appointed foreman, succeeding T. Martin, promoted.

R. STANLEY has been appointed car foreman of the Grand Trunk, at Allandale, Ont., succeeding W. J. Hallett, promoted.

H. J. WHITE, general car and wrecking foreman of the Canadian Pacific, at West Toronto, Ont., has been appointed general

car foreman of the Canadian Northern Quebec, at Joliette, Que., succeeding J. S. Jackson.

P. ALQUIST has been appointed superintendent of the car department of the Missouri, Kansas & Texas, with office at Sedalia, Mo. Mr. Alquist was born in Stockholm, Sweden, in 1874, and came to this country in 1885, settling at Memphis, Tenn. He started his railroad career as car repairer for the Illinois Central at Memphis in the early part of 1895, working for the same road as car interchange inspector, repair track foreman, assistant general foreman, and general foreman of the car department of the Memphis, Mississippi and Fulton divisions until 1910, when he left to go with the Cincinnati, Hamilton & Dayton as general foreman of the car department at Lima, Ohio. He left that road after about eighteen months'

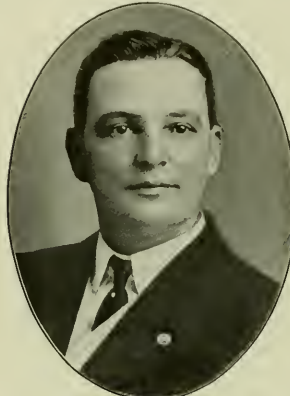

P. Alquist.

service to go to the Pere Marquette as general car foreman at Grand Rapids, Mich., and was subsequently general inspector and chief inspector of the car department until his recent appointment as superintendent of car department of the Missouri, Kansas & Texas, succeeding W. A. Mitchell, who was master car builder. The office of master car builder has been abolished.

SHOP AND ENGINE HOUSE

MATTHEW AMEY has been appointed assistant night roundhouse foreman of the Chicago & North Western at East Clinton, Ill., succeeding M. J. DeLacey, promoted.

P. CONIFF has been appointed superintendent of shops of the Baltimore & Ohio, at Mount Clare, Baltimore, Md. Mr. Coniff began railroad work in 1888. He was a machinist on the Pitts-

burgh & Lake Erie, the Pittsburgh, Fort Wayne & Chicago and the St. Louis, Iron Mountain & Southern railroads until December, 1902, when he entered the service of the Baltimore & Ohio as a roundhouse foreman. He later became general shop foreman, and was promoted to master mechanic at Cumberland, Md., on May 1, 1911, which position he held at the time of his recent appointment as superintendent of shops. He succeeds J. W. G. Brewer, who has been appointed assistant district superintendent of motive power of the main line



P. Coniff.

district, with headquarters at Baltimore.

CHARLES BOERTMAN has been appointed superintendent of shops of the Pere Marquette at Saginaw, Mich., in place of George Hilfrink.

C. C. COLLEY has been appointed purchasing agent of the Louisiana Railway & Navigation Company, with headquarters at Shreveport, La., succeeding G. E. Smith, resigned.

J. L. CROUSE has been appointed superintendent of shops, electric division, New York, New Haven & Hartford, at Van Nest, N. Y.

J. KIRKPATRICK has been appointed master mechanic of the Baltimore & Ohio, at the Riverside shops, Baltimore, Md. Mr. Kirkpatrick served his machinist apprenticeship with the Kings-ton (Ontario) Locomotive Works from 1878 to 1882, and was later connected with the Canadian Pacific, the South Eastern and the Grand Trunk railways. He entered the service of the Baltimore & Ohio in March, 1903, and was promoted to master mechanic in the New Castle, Pa., shops in August, 1903, remaining in that position until 1905, when he was transferred to Cumberland in the same capacity. In February, 1907, he went to the Newark, Ohio, shops as master mechanic, and now goes to the Riverside shops of the same road as master mechanic, as noted above.



J. Kirkpatrick.

H. E. MYERS has been appointed shop superintendent of the Lehigh Valley at Packerton, Pa. Mr. Myers was born March 12, 1880, at St. Joseph, Mo., and was educated in the public schools. He entered railroad service in 1897 on the Kansas City, St. Joseph & Council Bluffs, now a part of the Burlington system. After serving the regular machinist's apprenticeship he was employed as a machinist for the Burlington at La Crosse, Wis., for two years, going from there to the Hannibal & St. Joseph at Hannibal, Mo., in the same capacity. On February 17, 1903, he entered the service of the Union Pacific at Omaha, Neb., as piece-work inspector in the locomotive shops and was later gang foreman and assistant to the general foreman. On August 1, 1905, he entered the service of the Atchison, Topeka & Santa Fe at Fort Madison, Ia., as general machine foreman, leaving December 1, 1906, to go to the Lehigh Valley as shop inspector at Sayre, Pa. In October, 1912, he was promoted to the position of assistant master mechanic of the New York, New Jersey and Lehigh division of the same road, which position he held at the time of his recent appointment as superintendent of shops at Packerton, Pa., as noted above.



H. E. Myers.

H. DARLING has been appointed acting locomotive foreman at Nicholl, B. C., succeeding J. Lambie, assigned to other duties.

MARTIN J. DE LACEY, assistant roundhouse foreman of the Chicago & North Western, has been promoted to the position of night roundhouse foreman at East Clinton, Ill., succeeding F. G. Clark, resigned.

P. J. DONOHUE has been appointed foreman boilermaker of the Chicago, Rock Island & Pacific, at Biddle, Ark.

F. C. HAMILTON has been appointed general foreman of the mechanical department of the Atchison, Topeka & Santa Fe, at Argentine, Kan.

H. HITCHENS, erecting shop foreman of the Atchison, Topeka & Santa Fe, at Albuquerque, has been appointed general roundhouse foreman, with headquarters at Winslow, Ariz.

E. J. McMAHON has been appointed machine foreman of the Houston & Texas Central at Ennis, Tex.

J. P. MOORE has been appointed assistant roundhouse foreman of the St. Louis & San Francisco, at Monett, Mo.

W. J. PAUL, roundhouse foreman of the Chesapeake & Ohio at Hinton, W. Va., has been appointed erecting shop foreman of the Atchison, Topeka & Santa Fe, at Albuquerque, N. M., succeeding H. Hitchens, promoted.

H. L. TURTON has been appointed general foreman of the Houston & Texas Central at Ennis, Tex.

NEW SHOPS

CANADIAN PACIFIC.—An officer writes that the company is building large extensions to the Angus shops, Montreal, Que., including the following: steel passenger and freight car shops, locomotive shop extension, new bolt and nut shop, power house extension, upholstering shop extension, general office building extension, pattern storage building extension, and maintenance building. The cost of the improvements will be about \$500,000.

CHICAGO & ALTON.—This company has appropriated \$987,000 for the erection of new shops at Bloomington, Ill. This is in connection with an extensive program of improvements at Bloomington, a part of which has already been completed.

MINNEAPOLIS, ST. PAUL & SAULT STE. MARIE.—It is announced that the roundhouse at Duluth, Minn., is to be enlarged from a 12-stall to a 20-stall structure.

NEW YORK, NEW HAVEN & HARTFORD.—The repair shops at Van Nest, N. Y., for electrical equipment, are nearing completion, and it is expected will be in operation by August 1.

PHILADELPHIA & READING.—This company has given contracts to Irwin & Leighton, Philadelphia, for two new car repair shops to be built at St. Clair, Pa. The buildings are to be one story, and will be 45 ft. high. One will be 83 ft. 10 in. wide x 604 ft. 8 in. long, and the other 53 ft. 9 in. wide x 464 ft. 8 in. long. They will be of steel, concrete and brick construction, with steel sashes. Work was started on the improvements on May 13.

CHANGE OF GAGE IN AUSTRALIA.—A report from Melbourne states that a conference of the chief engineers of the Commonwealth and State railway departments has urged the immediate adoption of a uniform 4 ft. 8½ in. gage throughout Australia.—*The Engineer.*

COPPER IN RAILS.—The Chicago, Milwaukee & St. Paul is having 10,000 tons of rails rolled containing .5 per cent. copper. This follows an order of 5,000 tons of the same composition rolled last year, which went through the past winter without a single broken rail.

SUPPLY TRADE NOTES

Charles R. Westcott has been elected secretary and treasurer of the M-C-B Company, Chicago.

The Railway Utility Company has removed its office from the Monadnock building to 226 South LaSalle street, Chicago.

The Standard Coupler Company, 2 Rector street, New York, has moved its general offices to 30 Church street, New York.

The Pilliod Company, New York, has moved its offices from room 1823, 30 Church street, to room 829 in the same building, where larger floor space has been secured.

The offices of Burton W. Mudge & Co. have been moved from the Peoples Gas building to the Railway Exchange, Chicago, and the firm name has been changed to Mudge & Company.

The Baldwin Locomotive Works is preparing to begin construction on the first unit of its new plant at East Chicago, Ind., for which approximately 370 acres of land was purchased last year.

George D. Rosenthal, manager of the St. Louis, Mo., office of the General Electric Company, Schenectady, N. Y., died in New York on May 19. Mr. Rosenthal had been with the company for over 20 years.

The Hon. William C. Redfield, having been appointed a member of President Wilson's cabinet, has resigned as vice-president and a member of the board of directors of the American Blower Company, Detroit.

George W. Craven, manager of the Chicago office of the C. & C. Electric Company, New York, has been made manager of the welding department of that company, with headquarters at Garwood, N. J., succeeding George A. Hills, resigned.

W. P. Hawley has been elected vice-president of the United States Light & Heating Company, New York. Mr. Hawley was born in Chatham, N. Y., August 1, 1883. He received a high

school education at that place, and after graduation worked in the state bank for five years. In September, 1904, he left Chatham and came to New York. He entered the service of the Manhattan Lighterage Transportation Company, which was sold to the Central Railroad of New Jersey on January 1, 1905. On that date Mr. Hawley took a position with the United States Light & Heating Company of New Jersey. Upon the consolidation of the United States Light & Heating Company of New Jersey, the Bliss Car Lighting Company,

Milwaukee, Wis., and the National Battery Company, Buffalo, N. Y., under the name of the United States Light & Heating Company, of Maine, Mr. Hawley was made manager of the New York office, which position he still holds in addition to his duties as vice-president.

The Buda Company, Chicago, Ill., has announced the establishment of a headlight department for the manufacture and sale of the Buda-Ross electric headlight. Mark A. Ross will

be in charge of the department, and Harry P. Bayley and John Eberhart will be associated with him.

G. E. Stoy has resigned as general foreman of the Trinity & Brazos Valley at Galveston, Tex., to take charge of the locomotive department of the Vandaveer Clay Products Company, Houston, Tex. He will have charge of all installations of their patent locomotive firebox liners and oil burners.

J. W. Cleary, one of the oldest electric headlight men in the country, who joined the forces of the National Electric Headlight Company in Indianapolis in 1891, and in 1899 became associated with the Pyle-National Electric Headlight Company, Chicago, as traveling engineer, has resigned his position and will go abroad for several months.

W. S. Murray has resigned as electrical engineer of the New York, New Haven & Hartford, and has formed a partnership with E. H. McHenry, who recently resigned as vice-president of the New Haven, under the firm name of McHenry & Murray, engineers. The firm will specialize in railway electrification work, including plans, estimates, construction and operation, and will handle work of this character for the New Haven.

The Forsyth Brothers Company, Chicago, has transferred all right and title in the Forsyth draft gear, buffing device, radial device, truck actuating device and yoke, and the Chaffee centering device to the Waugh Draft Gear Company, Chicago, and all future negotiations and correspondence relating to these devices should be carried on with Wendel & MacDuffie Company, general sales agents, 165 Broadway, New York.

BLOCK SIGNALS IN THE UNITED STATES.—The length of road operated under the automatic block system January 1, 1913, was 22,218.8 miles, and under the manual system 61,751 miles, a total of 83,949.8 miles.

BRAZILIAN RAILWAY.—The President of Brazil has signed a decree approving definite plans and estimates amounting to \$1,100,000 for the railway line between kilometer 0 and 105 of the Coroa to Tocantins Railway.

NEW LINE FOR NORWAY.—A short railway is to be constructed connecting Aalgaard with the present Stavanger-Egersund Railroad. It will be the first branch line to penetrate the mountainous region, although requiring no difficult engineering feat, for its roadbed will lie in one of the valleys. According to the estimates announced on April 9 by the engineer who has made the preliminary survey, the line will be 8¼ miles in length, have a maximum grade of 2 per cent., and will cost approximately \$275,000.

COMPARISON BETWEEN RAILROAD STOCK AND REAL ESTATE.—A man who bought 100 shares of Pennsylvania Railroad stock 50 years ago—say the first day of the battle of Gettysburg—paid approximately \$6,000 for it. If he kept it until today he would have received about 6 per cent. on his money all that time, but his capital would now be only \$5,600.

Had a man on the same day bought a piece of real estate for \$6,000 in the central part of Philadelphia or in any direction around it or in almost any other thriving town, the increase in his capital now would be very great, in almost every case. One man who 24 years ago paid \$30,000 for a Chestnut street property recently refused \$460,000 for it. His capital has multiplied by more than 15.

It is a curious thing that there is such a general impression that those who own railroads have grown rich with amazing rapidity. The truth is that a dollar invested half a century ago in America's largest railroad and the one where traffic is densest and the people richest, and where business has grown the fastest, is worth a little less than a dollar today. Similar comparisons might be made with the other standard lines of the East.—*Philadelphia Public Ledger.*



W. P. Hawley.

CATALOGS

VERTICAL WATER TUBE BOILERS.—A series of leaflets is being sent out by the Wickes Boiler Company, Saginaw, Mich., which covers the important features of the design of its boilers.

STEAM TURBINE DRIVEN GENERATORS.—Bulletin 152 from Crocker-Wheeler Company, Amper, N. J., is devoted to a description and discussion of the steam turbine driven generators for both alternating and direct current manufactured by that company.

LAMPS FOR CAR LIGHTING.—The advantages of the Edison Mazda lamp for car lighting are fully set forth in a 14-page catalog issued by the General Electric Company, Schenectady, N. Y. Illustrations showing the interior of artificially lighted cars, demonstrating the advantages of this type of light, are freely used.

BLACKSMITHING AND DROP FORGING.—Bulletin 2 of a series published by Tate-Jones and Company, Pittsburgh, Pa., is devoted to the subject of heavy forging. Its twenty-four pages include a brief and concise technical discussion of the subject. It is well illustrated throughout. The first bulletin of this series was on the subject of welding.

THERMO-ELECTRIC PYROMETERS.—A comprehensive discussion of the theory, design and construction of thermo-electric pyrometers is included in Bulletin No. 3 from the Hoskins Manufacturing Company, 453 Lawton avenue, Detroit, Mich. It contains 47 pages devoted entirely to this subject and illustrates the Hoskins pyrometer in several forms, both portable and stationary.

BOYER SPEED RECORDER.—Catalog 42 of the Chicago Pneumatic Tool Company, Fisher building, Chicago, gives an illustrated description, together with instructions for applying and operating the Boyer railway speed recorder. Several pages of the catalog are devoted to a list, with prices, of the supply parts. The illustration shows the recommended method of applying the recorder to both cars and locomotives.

TRAVERSE SHAPERS.—The Cincinnati Shaper Company, Cincinnati, Ohio, is issuing a new catalog of traverse shapers and crank planers. The former are shown in three strokes—18 in., 22 in. and 26 in.—with one or two heads and in lengths of bed from 8 ft. to 20 ft. The crank planers are shown in two sizes; the catalog also includes some descriptive matter of other types of shapers manufactured by this company.

ROLLED STEEL WHEELS.—The Standard Steel Works Company, Philadelphia, Pa., has issued a new catalog on rolled steel wheels. An interesting feature is the application of a number to each wheel, covering all standard dimensions except the bore. The process of manufacture is fully described and illustrated, and the standard sized axles for steam and electric service are also shown. The book should be of great assistance in the purchasing of wheels.

TEXT BOOK ON CORROSION.—The Stark Rolling Mill Company, Canton, Ohio, producers of Toncan metal, have prepared a 70-page catalog which is divided into three parts. Part one includes interesting technical information in connection with the corrosion of metals. Part two is devoted to illustrations and a discussion of the advantages of Toncan metal as a corrosion and rust resisting material, and part 3 lists the sheets and other forms of this material that are available, giving the prices of each.

ELECTRIC CAR LIGHTING.—Details showing the design and construction of the important features of the axle driven generator system of car lighting manufactured by the Safety Car Heating and Lighting Company, New York, are given in a pamphlet recently issued. It discusses the construction of the commutator on the generator, the generator suspension, the pole changing devices, the bearings of the generator, as well as the dynamo regulator and lamp regulator. Line and photographic illustrations are freely used.

NOISELESS GEAR DRIVING.—A 56-page booklet from the New Process Gear Corporation, Syracuse, N. Y., contains engineering arguments in connection with the use of raw hide gears, showing that they are of important economic value where high speed gears are required. The catalog contains much interesting and valuable data on gear transmission and is illustrated with photographs of actual installations. Eleven types of raw hide gears are shown in section and over two thousand sizes of pinions are given in a table that includes the prices.

GAS WELDING AND CUTTING APPARATUS.—Oxy-acetylene welding and cutting apparatus in several sizes and types is fully illustrated and described in a catalog being issued by the Davis-Bournonville Company, 90 West street, New York. In addition to the gas producing equipment, the catalog also shows various types of welding torches and includes a number of illustrations of machine welding and cutting devices that have been recently developed by this company. Both oxygen and acetylene pressure regulators are illustrated and other accessories and supplies are listed.

AUTOMATIC AIR DUMP CARS.—Four excellent photographs showing the operation of automatic air dump cars, are included in a recent folder sent out by Kilbourne & Jacobs, Columbus, Ohio. With this type of car the entire train is unloaded from one point and it requires but 15 seconds for dumping and less than 30 seconds for the whole operation of unloading the train and having it ready to start. These cars have an elevated body, supported on steel trunnions mounted on the center sills of the independent underframe. In dumping, the side toward which the load is to be discharged automatically lifts as the hopper is inclined.

METAL WINDOW SASH AND FRAME.—Catalog No. 7 from David Lupton's Sons Company, Allegheny avenue and Janney street, Philadelphia, includes a complete description of the design of steel window sash and frames and window operating devices, as well as steel louvres, skylights, etc., manufactured by this company. The principle of design of this frame and sash is based on the use of large solid sections made of the least practicable number of pieces welded together by the oxy-acetylene process. The catalog covers various types of steel sash for side walls, steel partitions and doors, the Pond continuous sash and operating device, the Pond truss, rolled steel skylights, hollow metal windows and Waldmire louvres. The illustrations show installations in railroad shops, roundhouses and other buildings, as well as in commercial structures.

POSTAL CAR LIGHTING.—The specifications issued by the United States Post Office Department governing the lighting of postal cars are explicit in the matter of illumination values to be obtained in different parts of the car, but leave to the discretion of the railways the means to be used in providing the light. A pamphlet prepared by the Safety Car Heating and Lighting Company, 2 Rector street, New York, gives a clear understanding of the requirements of the specifications and suggestions as to suitable means for satisfying them. It interprets the specifications and gives the recommendations of this company regarding the best spacing of the lighting units, the most efficient lamps and reflectors to be used, and the various essentials of suitable and economical lighting of postal cars. This company was actively engaged in the tests from which the government obtained its knowledge of what was required to satisfactorily illuminate postal cars and furnished lighting fixtures and engineers to assist in the conducting of the tests. The information given in the pamphlet is, therefore, reliable and the result of first hand knowledge. A complete copy of the specifications revised to December 28, 1912, is included and diagrams are shown for various arrangements of full and half postal cars with the location of the various types of lighting units shown in red. These diagrams are fully dimensioned. Both gas and electric fixtures are considered.

Railway Age Gazette

MECHANICAL EDITION
INCLUDING THE
AMERICAN ENGINEER

PUBLISHED ON THE FIRST THURSDAY OF EVERY MONTH, BY THE
SIMMONS-BOARDMAN PUBLISHING COMPANY,
WOOLWORTH BLDG., NEW YORK, N. Y.

CHICAGO: Transportation Bldg. CLEVELAND: Citizen's Bldg.
LONDON: Queen Anne's Chambers, Westminster.

EDWARD A. SIMMONS, *President* L. B. SHERMAN, *Vice-President*,
HENRY LEE, *Secretary*.
The address of the company is the address of the officers.

ROY V. WRIGHT, *Editor*. R. E. THAYER, *Associate Editor*.
E. A. AVERILL, *Managing Editor*. A. C. LOUDON, *Associate Editor*.
GEORGE L. FOWLER, *Associate Editor*.

Subscriptions, including the eight daily editions of the *Railway Age Gazette* published in June in connection with the annual conventions of the Master Car Builders' and American Railway Master Mechanics' associations, payable in advance and postage free:

United States, Canada and Mexico.....	\$2.00 a year
Foreign Countries (excepting daily editions).....	3.00 a year
Single Copy	20 cents

Entered at the Post Office at New York, N. Y., as mail matter of the second class.

WE GUARANTEE that of this issue 4,500 copies were printed; that of those 4,500 copies, 3,780 were mailed to regular paid subscribers and 125 were provided for counter and news companies' sales; that the total copies printed this year to date were 33,126—an average of 4,732 copies a month.

Statement of the ownership, management, etc., of the *Railway Age Gazette*, *Mechanical Edition*, published monthly at New York, N. Y.:

Editor, ROY V. WRIGHT, New York, N. Y.
Managing Editor, E. A. AVERILL, New York, N. Y.
Business Manager, A. E. HOOVER, New York, N. Y.
Publisher, SIMMONS-BOARDMAN PUBLISHING CO., New York, N. Y.

STOCKHOLDERS:

EDWARD A. SIMMONS, New York.	ROY V. WRIGHT, New York.
LUCIUS B. SHERMAN, Chicago, Ill.	ELMER T. HOWSON, Chicago, Ill.
HENRY LEE, New York.	A. C. BOARDMAN, Riverdale, N. Y.
I. B. RINES, New York.	FRANCIS BOARDMAN, Riverdale, N. Y.
SAMUEL O. DUNN, Chicago, Ill.	B. BOARDMAN, New York.
	RAY MORRIS, New York.

BONDHOLDERS:

S. W. DUNNING, New York.	CHARLES M. PRATT, New York.
FRANCIS BOARDMAN, Committee, N. Y.	A. B. HENSZKY, Philadelphia, Pa.
JACQUES L. VAUCLAIN, Phila., Pa.	C. W. WALTON, Ridgewood, N. Y.
S. E. KILGUS, Newton, Mass.	C. C. NEWCOMB, Brooklyn, N. Y.
W. H. SHUEY, Chicago, Ill.	M. D. HORTON, Brooklyn, N. Y.

SIMMONS-BOARDMAN PUBLISHING COMPANY,
By E. A. SIMMONS, President.

Sworn to and subscribed before Jno. H. Carr, Notary Public for Kings County, N. Y. (No. 133), whose certificate is filed with the County Clerk of New York (No. 9), on April 2, 1913.

VOLUME 87. JULY, 1913. NUMBER 7.

CONTENTS

EDITORIALS:

Tests of Superheater Locomotives.....	347
Unwise Economy in the Drafting Room.....	347
Heat Treatment of Case-Hardened Steel.....	347
Training Apprentices.....	348
Car Construction.....	348
Subjects for Master Mechanics' Association.....	348
Steam Consumption from Indicator Cards.....	349
New Books.....	349

COMMUNICATIONS:

Truck Equalizer Design.....	350
Care of Superheater Tubes.....	350

GENERAL:

You Have Received, What Will You Give?.....	351
Mechanical Terminal for Illinois Central.....	353
False Economy in Drafting.....	361
Gaines Firebox on the Illinois Central.....	362
Oil and Grease Cups for Reds.....	366

SHOP PRACTICE:

Installation and Maintenance of Electric Headlight Equipment.....	367
The Manufacture of Brake Beam Hangers.....	368
Shop Kinks.....	369
Wrench for Removing Lubricator Choke Plugs.....	371
Power Required for Punching.....	372
Shop Kinks from the Frisco.....	373

CAR DEPARTMENT:

Making Stock Cars from Scrapped Box Cars.....	379
Developing Efficient Car Inspectors.....	380
Method of Designing a Steel Gondola Car.....	381
Box Car for Grain and Coal Traffic.....	386
Special 75-Ton Flat Car.....	388
Unloading Car Wheels.....	390

NEW DEVICES:

Electric Arc Welding.....	391
Axle Lighting System.....	392
Hervey Stoker.....	393
Crane-Grinder.....	393
Electric Riveting.....	394
Indirect Lighting on New Haven Trains.....	395
Grease Plug.....	396
Sharpening Curved Tooth Files.....	396
Double Journal Bearing Boring Machine.....	396
Equalized Swing-Motion Tender Truck.....	397
Drop Test of Vanadium Cast Steel Frame.....	397

NEWS DEPARTMENT:

Notes.....	398
Meetings and Conventions.....	399
Personals.....	400
New Shops.....	402
Supply Trade Notes.....	402
Catalogs.....	403

Tests of Superheater Locomotives

The appendix to the report of the Committee on Superheater Locomotives, presented at the last Master Mechanics' convention, which, it was mentioned on page 1373 of the June 14 issue of the *Daily Railway Age Gazette*, would be reproduced in the regular weekly and mechanical editions, is so voluminous and important that no effort has been made to include any of it in this edition. In later issues the various sections of this report will be considered at some length and presented in a form which will make them readily available for the use of our readers.

Unwise Economy in the Drafting Room

The importance of considering all allied departments when making changes of any kind in any department of a railroad, is well illustrated by a recent example of some improvements in drawing room practice. It was decided at one large drafting room that considerable saving could be made if the practice of making drawings to scale was abandoned. It is quite possible that the expected result was accomplished. The effect on the shop, however, will be readily appreciated by examining the illustrations given by Mr. Morrison in his article in this issue. The dollars lost by a workman trying to make something of these drawings will be easily imagined. It is a very excellent thing to try, in every way, to save as much money as possible in the drafting room, but only when it is known beyond doubt that this will not directly result in a loss of far more in some other department.

Heat Treatment of Case-Hardened Steel

There is no doubt but what a better knowledge of the effect of proper heat treatment of case-hardened steel would be of considerable value in most railroad shops. The success or failure of these parts in service is almost entirely dependent on the method of handling after they leave the case-hardening furnace. At the recent convention of the American Society for Testing Materials, a committee proposed for adoption a recommended practice for the heat treatment of case-hardened carbon steel objects, in which the proper method of handling to obtain different desired results is very concisely and accurately set forth. There were four different conditions selected for discussion, starting with the hardest surface and the least strength, and following through four variations to the greatest strength with the least hardness.

Where the hardness of the case only is required and lack of toughness, or even brittleness, is unimportant, the articles may be quenched by emptying the contents of the case-hardening

boxes directly into cold water or oil. In this way both the core and the case are very coarsely crystallized and of course the strength is very low. If the articles are allowed to cool to a temperature slightly exceeding the critical range of the case-hardening, usually from 800 deg. to 825 deg. C., (1472 deg. to 1517 deg. F.) and then quenched, the core and case still remain crystalline, but the danger of distortion or cracking in the quenching bath is reduced and the strength is somewhat increased. The next recommended method is to give a result which will increase the toughness and strength of the article and refine the case, and for this the articles are allowed to cool slowly in the carbonizing pot to a temperature of about 650 deg. C. (1200 deg. F.), are then reheated to a temperature slightly exceeding the lower critical point of the case, which in most cases will be 775 deg. to 825 deg. C. (1427 deg. to 1517 deg. F.) and are then quenched in water or oil. They should be removed from the quenching bath before their temperature has fallen below 100 deg. C. (212 deg. F.). By allowing them to cool slowly to a temperature of about 650 deg. C. (1200 deg. F.) and then reheating to a temperature of about 900 deg. to 950 deg. C. (1652 deg. to 1740 deg. F.), followed by quenching in oil, from which they are removed before they have dropped below a temperature of 100 deg. C. (212 deg. F.) then reheating to about 800 deg. C. (1472 deg. F.) and again quenching in water or oil, both the case and the core will be thoroughly refined and their toughness greatly increased.

The report also points out that in order to reduce the hardening stress created by quenching, the objects, as a final treatment, may be tempered by reheating them to a temperature not exceeding 200 deg. C. (392 deg. F.). A more thorough understanding of these critical temperatures and the proper way of handling them by shop foremen is a matter which the various foremen's associations would do well to consider.

Training Apprentices

Initiative, self-reliance and resourcefulness are qualities which are usually best developed by necessity. Furthermore, they are among the most important and valuable qualities that a successful railroad man can possess. It was recently pointed out by a motive power official that the general practice of training apprentices, and more particularly special apprentices, or those who have graduated from a university, in the large shops of the system, while of great value in teaching the best practice and methods, has a decided tendency in reducing their effectiveness in the case of emergency, and makes them practically helpless when complete facilities are not immediately at hand. To overcome this it is suggested that, as part of their course, the apprentices be required to spend some time at an outlying point where the facilities are extremely meager. It is believed that experience of this kind will greatly strengthen their resourcefulness and self-reliance.

Car Construction

The report of the special committee on car construction made at the convention of the Master Car Builders' Association is to be referred to letter ballot for adoption as recommended practice. It is one of the most important that was presented before the convention and if adopted, and fully followed, will have a far reaching effect on the cost of car maintenance. It requires that, for new cars, the area of center sills shall not be less than 24 sq. in., and that the ratio of stress to end strain shall not be more than .06. It further recommends that existing steel or steel underframe cars which have less than 16 sq. in. area of center sills and a ratio of stress to end strain of more than .09, shall be classified with wooden cars and be subject to the same rules for combination defects. The recommendations further require that the length of center or draft sill members, or part of a member between braces, is not to be more than twenty times the depth of the member meas-

ured in the direction in which buckling might take place.

Where the proper distribution of the metal is made in connection with this area requirement, there is little doubt but what these requirements will force the building of equipment which will not develop weakness under the most severe conditions of ordinary service. The earlier steel cars are now generally admitted to have been too light, but on the other hand, traffic conditions during the past ten years are found to have increased the stress to cars due to end shock by at least 50 per cent. If these conditions continue to become more severe in the same ratio, ten years from now cars of a strength recommended by this committee will be as much too weak as the earlier steel cars are at the present time. It is, however, neither possible nor advisable to build present day cars for unknown future requirements, but there is no doubt but what all cars now being built should at least fully meet the most difficult conditions now existing. If the recommendations of this committee are adopted it is not at all improbable that they will have to be increased within the next five years.

Next to the underframe requirement, the recommendations of the committee in regard to box car ends are of the greatest importance. After careful consideration it was decided that either all-steel or heavily wooden reinforced ends are the only construction that will meet the requirements satisfactorily. It is recommended that for cars with wooden ends, a reinforcement consisting of a 3/16 in. steel plate extending for the full width of the end and for about two-thirds of the height, be installed beneath the lining, and further, that there be applied two pressed steel horizontal braces reaching around the corners and being well secured to the side frames. When complete new ends are required in wooden superstructure cars, it is recommended that the all-steel end be used and the committee submitted recommended designs for both cases. Cars with ends of the type recommended are known to be capable of withstanding the effects of the heavy shifting load in the hump yard, which, experience has shown, practically any design of all wood end will not do. In view of this it is difficult to conceive of the association refusing to adopt the report of this committee as recommended practice.

Subjects for Master Mechanics' Association

In a review of the work of the American Railway Master Mechanics' Association at its convention last month, the address of President D. F. Crawford should occupy a prominent position. It has been too frequently the custom in the past to applaud and commend the suggestions made in the president's address for the future work and the improvement of the association, and then promptly proceed to overlook them in the preparation of the next year's program. It is to be sincerely hoped that that will not prove to be the case this year, for the advice and recommendations made by Mr. Crawford are of vital importance if the association is to continue to occupy the place and standing it deserves.

It is pointed out by Mr. Crawford that too much attention has been devoted in the past to material and consideration of the locomotive as a mechanical device rather than as an instrument of transportation. The study of the general proportions, the hauling capacity, the adaptability of the machine to specific work, the obtaining of a maximum output with minimum expense is of far more importance to the railways and to the public than the study of the smaller details of the machine, and the minute variations in the composition of the materials used in its construction. The full realization of this fact must come to the members of the Master Mechanics' Association or their field will be pre-empted by some other body. Criticism has been heard that the American Society of Mechanical Engineers has organized a Railway Session and is undertaking work which logically should come before the Master Mechanics' Association. The fact remains, however, that the Master Me-

chanics' Association has not undertaken this work in the past and its members certainly have no ground for objections to another nationally organized body undertaking it. It is very largely left to this association to decide for itself what work it cares to undertake and if it is not considered advisable to consider the larger problems of design and operation in the thorough, serious manner they deserve, wherein lies a cause for criticism of another society for doing it?

Mr. Crawford made but three definite suggestions for future subjects, and gave very convincing reasons why these should be undertaken immediately. One was the determination of a train resistance formula of sufficient accuracy to be of practical application and value and take the place of the thirty or forty formulas that now are in more or less general use. The single instance mentioned where one of the most generally accepted and frequently used formulas gave a drawbar pull which was over twice the actual amount as shown by the dynamometer car, is sufficient to show the importance of this matter.

The determination of an accurate method of indicating the hauling capacity of locomotives and train loading that would be suitable for all kinds of locomotives under the various conditions of service was the second subject suggested. While more activity has been shown by the association on this subject than on the other and the data available is much more reliable and practical, still it behooves the Master Mechanics' Association to keep strictly in the forefront and occupy the place as an authority on the subject which, by virtue of the quality of its membership, it should hold.

As a third suggestion, Mr. Crawford points out that some more logical unit than lading or gross ton-miles should be considered for making comparison of operating costs and the performance of equipment and he suggests that a committee be appointed to devise such forms for statistics as would meet the requirements of the railways and others interested in their application. In these days of increasing government activities along the lines of railway regulation, reliable statistics of the cost of operation and of the maintenance of equipment are of the greatest importance and value. To whom should we look for the determination of the proper basis of comparison of locomotive costs if not to the American Railway Master Mechanics' Association?

Steam Consumption from Indicator Cards

Some remarkably interesting information has been developed by J. Hall Clayton, assistant in the mechanical engineering department, Engineering Experiment Station of the University of Illinois, in connection with the development of a method whereby the steam consumption of a locomotive can be accurately obtained directly from the indicator cards. The amount of steam consumed for each indicated horse power is the measure of success of the design of any steam engine, and is of particular importance on a locomotive where the steam making capacity is the controlling factor of the power. While by far the largest number of locomotive tests are made while the machine is in operation on the road, and in each case the amount of steam required for each horse power per hour is carefully figured on the basis of the amount of water evaporated, with corrections for that used by the auxiliaries and wasted through the safety valves, it is known that there are indeterminable errors always entering in the problem and that the result is, at the best, but a fair approximation.

It has heretofore been considered impossible to obtain a reliable estimate of the steam consumption from the indicator diagram because of the lack of knowledge as to the amount of initial condensation of the steam up to the point of cut-off, and the amount of the piston or valve leakage, as well as the great difficulty in correctly locating the events of the cycle on the diagram, particularly those taken at high speeds. Tests made on a testing plant are of course subject to control in every par-

ticular and the amount of steam for each indicated horse power can be obtained with accuracy. Mr. Clayton checks his method of analysis by applying it to indicator cards made on a testing plant and, in every case, obtained a result that varied from the actual figures but by a very small percentage. In addition to obtaining the amount of steam consumption, this method of analysis permits the discovery of leakage into or out of cylinders while the engine is in normal operation and also allows the amount of clearance displacement to be found as well as an accurate determination of the location of the event of the cycle. The development of these methods in detail is described in Bulletin No. 58, and their application to indicator diagrams of locomotives in Bulletin No. 65 of the Engineering Experiment Station of the University of Illinois.

The method developed consists of transferring the indicator diagrams to logarithmic cross section paper. When the diagrams are plotted in this way, it is found that the expansion and compression lines closely approximate a straight line, and it is possible to ascertain the value of the power to which the product of the pressure and the volume is raised to equal a constant, *i. e.*, the value of n in the formula, $P V^n = C$. It has been discovered that the value of this power is controlled largely by the quality of the mixture which is present in the cylinder at the point of cut-off and that the relation of this quality, and the power is practically independent of the cylinder size and of the engine speed for the same class of locomotive or other steam engine. This enables the determination of the actual amount of steam and water present in the cylinder at the point of cut-off, and thus gives, from the diagram, the actual steam consumed.

It has been found that by the use of this method in connection with road tests, it will be possible to obtain reliable information as to the amount of steam used by auxiliaries and the amount wasted. Furthermore, the existence, and in some cases the amount of leakage, due to leaky valves into or out of the cylinders, may be ascertained. The amount of spring in the valve gears is shown in the logarithmic diagrams by the change in location of the cyclic events under various conditions. The amount of clearance may also be found from the diagram with a fair degree of accuracy at the same time.

The development of this new method by Mr. Clayton will greatly increase the value and importance of locomotive road tests and permit the obtaining of reliable data which it has heretofore been considered was impossible except by the use of an expensive locomotive testing plant. Greater refinement in valve gear and cylinder design is needed on American locomotives, and it is possible that the use of this method may make the shortcomings so prominent that energetic steps will be promptly taken to correct them.

NEW BOOKS

Resuscitation. By Dr. Chas. A. Lauffer, Medical Director, Westinghouse Electric & Manufacturing Company. Bound in cloth. 47 pages, 4 in. x 6½ in. Illustrated. Published by John Wiley & Sons, New York. Price 50 cents.

This book includes a reprint of a paper on this subject delivered by the author before the Philadelphia section of the National Electric Light Association. After explaining a number of successful results which have been obtained by employing resuscitation methods on men who were supposedly dead, the book gives a clear description of the mechanism of respiration, illustrating it by a number of views of the various parts of the anatomy. The prone pressure or Schafer method of resuscitation, which has been adopted by the National Electric Light Association, and a number of other engineering societies, is described in detail. It brings out in a clear, concise manner the necessity of people in general being versed in the principles of resuscitation, and clearly shows how they can be learned so as to prove valuable to persons in ordinary walks of life.

COMMUNICATIONS

TRUCK EQUALIZER DESIGN

ST. CHARLES, MO., May 29, 1913.

TO THE EDITOR:

On page 96 of the February, 1913, issue of the AMERICAN ENGINEER, there appeared an article entitled "Truck Equalizer Design," by L. V. Curran. In studying over this article carefully, I find that Mr. Curran has overlooked a very important force that should enter in the computation. This is the vertical component of the pull on the brake shoe and is greater than the frictional force included in the formulas given.

Referring to the diagram the forces there shown are as follows:

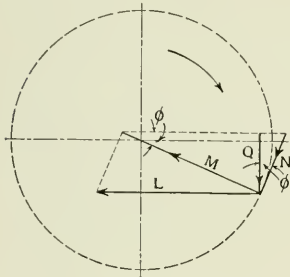

- L = Horizontal pull on the brake shoe.
- M = Radial component of L.
- N = Tangential component of L.
- Q = Vertical component of N.

Disregarding the friction for the moment, it is seen that there is a radial force and a tangential force resulting from the horizontal pull on the brake shoe. The radial force, $M = L \cos \phi$. The tangential force $N = L \sin \phi$. The vertical component of $N = Q = N \cos \phi$. Substituting for N we have $Q = L \sin \phi \times \cos \phi$. This is the force that has been omitted by Mr. Curran.

For the frictional force between the shoe and the wheel, the formula given by Mr. Curran is correct; this is $P = fL \cos^2 \phi$.

In designing an equalizer we should therefore deal with $P + Q$ instead of P only.

I think the coefficient of friction, 0.25, as given by Mr. Curran is somewhat too high. In the Master Car Builders' Proceedings of 1910, the report of the tests on the Lake Shore & Michigan Southern during 1909 showed a coefficient of friction of 0.10, which I believe is the better figure to use.

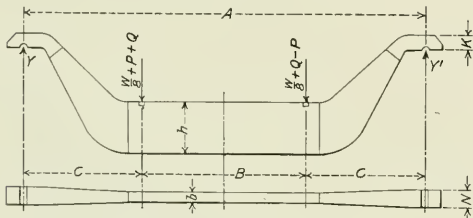

Equalizer for Four-Wheel Truck.

Referring to the illustration of an equalizer for a four-wheel truck and using the same notation as in Fig. 2 in Mr. Curran's article, we have the load on the two springs

$$\frac{W}{8} + P + Q \quad \text{and} \quad \frac{W}{8} + Q - P$$

and the reaction at Y:

$$Y = \left(\frac{W}{8} + P + Q \right) \left(\frac{B+C}{A} \right) + \left(\frac{W}{8} + Q - P \right) \left(\frac{C}{A} \right)$$

$$Y = \frac{BW + 8PB + 8QB = 2CW + 16CQ}{8A}$$

If $P + Q = K$

$$Y = \frac{AW + 8BK + 16CQ}{8A}$$

The maximum bending moment will therefore be

$$M = C \cdot Y = \frac{C(AW + 8BK + 16CQ)}{8A}$$

The force Q will also enter in the calculations of the equalizer for a six-wheel truck.

SIGURD HOLM,
American Car & Foundry Company.

CARE OF SUPERHEATER TUBES.

ST. LOUIS, MO., May 31, 1913.

TO THE EDITOR:

It is to be regretted that more time could not be allowed for the discussion of the care of superheater tubes at the recent convention of the Master Boilermakers' Association. Because of the heavy rush of business it was almost impossible to get the floor to bring out questions, which, in my opinion, would be beneficial to all master boilermakers. I therefore wish to describe the methods we use in the care of the large 4½-inch tubes in the superheater engines on the Missouri Pacific Lines. We have experienced some trouble with the large tubes leaking, and while it is contrary to the instructions of our superintendent of machinery for the boilermakers to use the flue rollers, in some cases those instructions have been disregarded and the flue rollers have been used to such an extent that some of the large tubes have been rolled until they are from ¼ in. to 5/16 in. larger in diameter than the original size. I happened to be at a certain point on the system when one of the large passenger engines had an engine failure due to the 4½-in. tubes leaking. On making an inspection of the firebox and tubes I found that the expanders that were intended to be used on this class of work were entirely too small because of the heavy rolling that the tubes had had. In applying the rollers in the large tubes it was found that they would not make the flues tight as the flues had become hard from the constant rolling. To overcome this I made a casing of scrap tank steel, rolled it around the seam of rivets of the flanges on the flue sheet and packed magnesia lagging between this casing and the rivet heads. The large flues as well as the small ones were then plugged up with magnesia, which was pushed back into the flue about 4 or 5 in. A plate of ¼-in. scrap tank steel, 12 in. wide, was placed across the face of the tube sheet, two rows of flues below the large flues, a couple of bolts on each side being used to hold it. We then lent a piece of our standard netting around the edge of this plate, forming a basket, which was filled with charcoal. A fire was started in this charcoal and in about two hours' time the flues all became a cherry red. The expansion forced all of the tubes into the firebox about 1/16 in. This annealed the tubes so that they could be expanded and beaded satisfactorily. The engine was put in service and has been running constantly for the past 60 days without giving any further trouble. We have had such good results from this engine that we have adopted this practice on the system.

T. P. MADDEN,
General Traveling Boiler Inspector.

TRANSPORTATION IN MADRAS.—It is suggested that the needs of better transportation facilities in the Madras presidency might be met, in the absence of railway extensions, by putting industrial motors on the roads. A Madras correspondent of an Indian contemporary remarks that the leap from railways to motor traffic is easy and that the increased utilization of road traction would be justifiable, if only from the point of view of not putting all your traffic eggs in one basket. The demand for more ample traveling and freight car facilities forms one of the principal themes at the meetings of the District Boards. It is constantly coming under the consideration of trades people and of their Chambers of Commerce. The need is universal and insistent.

YOU HAVE RECEIVED, WHAT WILL YOU GIVE?

Address Made at the Commencement Exercises of
the Casino Technical Night School, East Pittsburgh.*

BY G. M. BASFORD.

If I am able to place clearly before you a thought that is in my mind, perhaps my presence here may be not in vain. This thought centers in what the present moment means to me. Perhaps I may make it mean a little more to you.

Some years ago it fell to the lot of the speaker to work in a railroad machine shop beside a boy who was mis-called an apprentice. What was his name? What has become of him? He went into the stream of working humanity. He is one of the mass to whom hopeless ambitionless toil has become second nature and for whom life holds little joy and no sunshine. His intelligent inquiry about his work was met by a gruff answer, or rather a refusal to answer. He was taught nothing, but was allowed to find his own niche, the one easiest for him to crawl into. He found it, and in it he remained.

At that time the speaker had a vision. He dreamed of an apprenticeship, real apprenticeship with trade training, educational in itself and co-ordinated with technical school opportunities which would reveal to the mind the reasons for the work of the hands. A dozen years passed and right in this spot this dream became a reality. I do not believe a member of this community, not even the presiding officers of these great manufacturing organizations and those who are responsible for the development of this school are able to realize what this means as I do. I do not believe even the unselfish, self-forgetful, devoted instructors of this school appreciate this moment as I do.

It is impossible to forget the searching inquiry, the painstaking study of the needs of those for whom the school was founded and the careful planning that preceded its inauguration. Following this was the plunge into the school enterprise itself. You who receive your parchments this evening can know little of this, or of what it meant to those who started this work. You perhaps do not know how some of your devoted instructors kept the school going in times when there was no money for the school or for their salaries. They worked for their ideal, for your good, for your happiness. If they had not done so you would not be here tonight. All honor to them for this devotion. If you have acquired even a small portion of the spirit that inspired them you will devote your lives to lending the helping hand to others who need it. You cannot justify your presence here this evening if you do not do this. You can not repay your teachers in any other way.

In years to come you will remember this school. If you have learned its lesson you will understand what education means. You will find within yourselves resources, resources to enable you to find your niche in life and to enable you to fill it. If you have the spirit of this school you will be the better worker because a thoughtful worker. You are not educated unless you can think. Your diploma is of no value if it marks merely the completion of a course, if it means merely that you are an expert passer of examinations. It is of greater value if it shows that you have thought your way through four years. It is quite possible to complete a college course of four years and acquire a degree without learning to think. I know, for I did this very thing. It would be impossible for you to spend four years here without learning to reason.

If you have done your part in the past four years you are already educated young men, not men with education. There is a vast difference between the two. The first is like the development of a beautiful flower; the second is like the filling of a glass from a pitcher. The beautiful flower grows, develops from the bud. It develops from within, it opens its petals, unfolds. Real education is like this, but bear in mind that this school is only the beginning of your education and that the methods of this course are to be followed all through life, if you are to make the most of this wonderful opportunity.

Perhaps some of you may think that you would prize the diploma from a college more than you will prize that which you are to receive tonight. Without under-estimating in any way the value of the college parchment, I believe that should any of you later on pursue your studies and attain the college degree, you will look upon the award of this evening as of the greater value. You are perhaps more fortunate than you know, to have the opportunity which this school has given you. In many respects it offers advantages which the college does not. In case you do not appreciate this fact, and in order to be sure that you understand the value of the methods here employed, let me tell you what it means to me.

In coming here you knew what you wanted. Many college students do not have this advantage. Then your teachers knew what you wanted, whereas many college professors do not know what their students want and do not understand the life into which their graduates go. Your teachers are men who are actually holding their own in the strenuous game of life. They are not men who are merely teaching subjects for the sake of those subjects themselves. For example, your teachers do not present to you so-called pure science or pure mathematics, or pure anything else, pure in the sense of being entirely removed from practical application. Your instructors have presented science in a way possible of direct application to the problems of your lives. Your instructors know how to educate, because they know how to do. They are doing. Furthermore you are working while studying and studying while working, your studies being an interpretation of the meaning of the things you do in your work.

Note the fact that you are members of a working organization fitting yourselves the better for higher places in that organization. You are not removed for four long years from actual contact with life and placed for that long period in artificial surroundings, depending upon someone else to pay your bills. You are doing work that counts, that helps you today and will help you later on. Those who work their way through college can't always do that. Education always means more to one who pays his own way while securing it, because the responsibilities of life are constantly in mind. It is not necessary for you to find your life work after graduation, for you are already in your life work. How many of our college graduates are stranded in the world after four years of their artificial life, with no definite idea of what they are fitted for and what they want to do. Think a moment of the advantages you have over them.

On the other hand, your study here has been narrow—it could not be otherwise. All technical schools are necessarily narrow. You have not had time for something that the college student acquires and that you must have. I mean culture of the mind, development of good taste in literature, history, art or music. I mean mental resources and inspirations which will prepare you to be interesting companions, which will enable

*The Casino Technical Night School at East Pittsburgh, Pa., is supported by the Westinghouse interests, but is open to any member of the community. Tuition is free. It has an engineering department with thirteen instructors in charge of the following subjects: Electricity, steam, chemistry, English, physics, machine shop, foundry, pattern shop, mechanical drawing, mathematics, preparatory, foreign and health. There is also a woman's department having five instructors in charge of cooking, sewing, music, commercial and preparatory work. The president of the school is C. R. Doolley, who is also in charge of the educational work of the Westinghouse Electric & Manufacturing Company.

you to interpret and discuss progress of the times, and will put you in position to grow in every other way as you have grown in knowledge of your work. A man should know all he can about his work, but if he knows nothing else he handicaps himself. He is a dreadful bore and he shuts out from himself some of the brightest and best things of life. By devoting thought to the use of your leisure time you may do much to acquire these attributes that the colleges give so well.

Concerning the practical character of your education and the value of studying while working—let me tell a story of a new technical school graduate. He entered railroad service in the motive power department and was given the problem of designing steel tanks for compressed air. These tanks were 30 in. in diameter by 7 ft. long. The designer, who had never had the advantage of shop experience, showed on his drawings bumped heads, turned outward, bringing the rivet heads at both ends on the inside of the tank. The practical master mechanic, who had the order to make these tanks, called the youth's attention to the fact that in order to build the tanks it was necessary to leave inside the man whose duty it was to hold on to the heads of the rivets. He said he would not raise the point of leaving a man permanently inside of the steel tanks if he had only one or two to make, but as the order called for thirty he drew the line at losing so many men. The young draftsman there and then learned a lesson of great importance. He turned the heads about, leaving the rivets on the outside. He learned the lesson too late, because by that time the story was all over the shop. Chances for promotion are sometimes seriously affected by such mistakes, which your education would not permit you to make.

And here is one on the college boy: "I thought your father wasn't going to send you back to college," said a friend. "That's so, Dad did kick on the expense, but I threatened to stay at home and help run the business. Then he decided that a college course would be a lot cheaper."

I would like to speak of the matter of greatest importance in education. I refer to the development of character. If education is not reflected in character it is worse than useless. There never was a time when such great opportunities presented themselves to those who are prepared to take advantage of them. Every official in a large organization is more troubled with problems of personnel than by any other problems. Character is even more important than ability in the eyes of your employers and the traits of character most sought for are thoroughness and reliability. If your education does not develop these traits it has fallen far short of what it ought to do.

A word about ambition. You greatly need ambition, but ambition of the right kind. The right kind is that which inspires you to do the work that lies before you more perfectly than anyone else has ever done it. It should also be done quickly and efficiently. This ambition is sure to lead to success of the best kind and is the best assurance of the attainment of the highest position anyone is qualified to fill. That ambition which leads one insanely to desire a position far beyond his capacity to fill and leads him to attempt to omit vitally important intermediate steps in progress is the wrong kind and leads to failure and discontent, and to never ending complaints of the coldness of the world and its lack of appreciation. The men who are most wanted today are the men who can do something that someone else wants done and do it quickly and do it right. "He does much who does a little well." This is really covered by my understanding of the words character and ambition in this connection.

"Remember that promotion is the result of growth, not of time serving, and that the oak outlives the mushroom."

Hugh Chalmers, famous in the automobile world, has said: "There are three kinds of men.

1. "Those you tell once and the thing is done.
2. "Those you tell and the thing is never done.

3. "Those you don't tell at all and they beat you to it."

I am reminded of the fact that this school undoubtedly owes its existence chiefly to an inspiration which came to Edwin M. Herr 18 years ago while journeying in Europe, where he observed the German shop schools in operation. Many years passed before he found the opportunity to build this educational structure. You should pay tribute to those who have conceived, planned and executed to give you these opportunities. You are wonderfully fortunate. It should not be possible for you to forget for a moment that much is expected of you because of these opportunities, and I do not believe you will forget.

In New York City, Sunday, March 30, last, Miss Helen Keller made the most remarkable address in the history of the world. She said—"I was deaf, and I hear; I was blind, and I see; I was dumb, and I speak." Mastery of speech by one completely deaf, dumb and blind is truly the "greatest individual achievement in the history of education."

Think for a moment of the use this young woman has made of her opportunities. Think of the degree won by her at Radcliffe College. Think of the significance of the word "opportunities" as applied to Miss Keller. Think of the possibilities of education of others similarly afflicted which are revealed by this remarkable case. No greater inspiration than this is to be found for doing our best with our opportunities. The world owes a tribute to Mrs. Macy, Miss Keller's teacher, for the emancipation of this imprisoned soul. We likewise owe tributes to our teachers, and we owe debts to them which we can pay only by making proper use of the opportunities they have placed in our hands.

You have inherited. What will you bequeath? Give serious thought to this question. We may receive for a time, but we must also give. Without making an end of receiving we must do our share in reaching out the helping hand.

What do you desire? Do you desire success? What is success? Is it riches? Is it position? Is it power? In my way of thinking there is no success like that of making the greatest possible number of people glad that you have lived. Let me suggest that you so order your lives that some day someone will be grateful to you as you are grateful to those who have placed before you this magnificent opportunity.

PASSENGER ALARMS IN VICTORIA.—During the last few years the Victorian Railways have been equipping the passenger cars on express trains with communication alarms. The apparatus, which is similar in principle to that adopted by the English railways, is operated by means of a chain running through pipes under the roof of the car with openings opposite each compartment. The chain is connected to a rod fixed outside one end of the carriage and when pulled by a passenger it turns the rod and causes the application of the brakes sufficiently to attract the attention of the guard and driver but at the same time without enough force to stop the train suddenly. The chain also turns a red disc which is provided outside the end of the carriage to indicate the compartment from which the alarm has been given.

NEW STEAM CARRIAGE.—A steam carriage constructed by Col. Macrone and J. Squire, Paddington-wharf, and which professes to be by the superiority of its peculiar boiler, and the simplification of its machinery, a decided improvement on all former vehicles of that description, has been exhibited for some time past in the neighborhood of Paddington. We drove out in it a few days ago along the Harrow-road with, in all, 11 persons. The utmost velocity on level ground was near 10 miles an hour; a part of the road covered with a coating of loose wet pebbles was crossed at a rate of about eight miles; and the bridge over the Grand Junction Canal, where the steep is rather a smart one, at four or five miles an hour.—Quotation from the *London Times* in the *American Railroad Journal*, January 19, 1833.

MECHANICAL TERMINAL FOR ILLINOIS CENTRAL

The One at Centralia, Ill., Represents the Latest Practice in Car and Locomotive Repair Plants.

BY WILLARD DOUD.*

The Illinois Central recently completed and put into operation at Centralia, Ill., a large locomotive terminal and car repair plant. Centralia is located about 250 miles south of Chicago, on the main line, in the midst of a large bituminous coal producing section, and at a point where all northbound traffic is separated for northern and western points. It is one of the most important freight terminals on the Illinois Central system. Formerly there were located at Centralia a 24-stall roundhouse, an 8-pit locomotive repair shop, and small freight car repair yards. These were all on a small tract of land practically in the center of the city and in a position which would not admit of any satisfactory alterations to the old plant to render it suitable for handling heavy locomotives rapidly and making repairs to about 250 freight cars a day. The original shops on this location were built about 1850.

The decision to locate new and larger distribution yards about

hours. This is believed by the mechanical department of the railroad to be quite conservative, and sufficient to allow for the ready handling of 150 engines every 24 hours.

The portion of the terminal concerned in the handling of locomotives consists of the following facilities: A 48-stall roundhouse; machine, boiler and smith shops; storehouse and offices; 600-ton coal chutes and sand drying plant; inspection pit, with office for engine inspectors; cinder pit, with shelter for cinder pit laborers; roundhouse office and enginemen's locker room and lavatory and power house.

ROUNDHOUSE.

The roundhouse is laid out on a 50-stall circle having one opening accommodating two tracks on the south side. The outside wall and the partitions are constructed of brick and the timber roof is covered with composite board. The building is



General View of Locomotive Group.

two miles south of Centralia carried with it the building of a new roundhouse with light repair facilities, and a freight car repair yard suitable for handling repairs to about 300 cars per day. The work was started on the mechanical terminal during July, 1912. The freight car repair yards were put into operation December 10, 1912, and the locomotive portion of the terminal one month later.

Because of the shape of the ground available it was necessary to make the locomotive and car departments practically independent of each other as far as the common use of the buildings was concerned, and in the design of the plant and the location of the various buildings the roundhouse and car repair yards are entirely separate, being some 2,000 ft. apart.

Practically 100 locomotives are handled in and out of the Centralia terminal each 24 hours, and the determination of the number of stalls for the new house was based on this figure, one stall being provided for every two engines handled per 24

especially noteworthy for the lighting and ventilating effects obtained. The roof is somewhat higher than is usually found with roundhouses of like section. A ridge ventilator is provided around the roof of the entire house for ventilation, and the experience gained during the past winter has demonstrated that this type of ventilator is very effective in removing smoke and fog from the interior of the house.

The roundhouse has 39 stalls designed for the storing and the handling of running repairs to the locomotives, each of the stalls being equipped with the usual pit. Nine of the 48 stalls, or one section of the roundhouse, is designed for drop pit work, and the general overhauling of such engines as are generally given heavy repairs at this shop. A drop pit for handling driving wheels serves seven of the nine stalls, the pit being provided with two 30-ton Watson-Stillman hydro-pneumatic drop pit jacks. An engine truck drop pit serves the remaining two tracks; it is equipped with a Watson-Stillman 15-ton hydro-pneumatic jack.

The floor in the heavy repair section, as well as in the remainder of the house, is of vitrified paving blocks, laid on a

*Mr. Doud was formerly shop engineer of the Illinois Central and handled the mechanical details of this new terminal.

foundation of rolled sand, with a generous crowning to provide good drainage to the pits. The bricks, after being laid and tamped, were slushed with cement grout, and after setting make a very satisfactory roundhouse floor.

The cross section of the stalls devoted to heavy repairs differs from the remainder of the house, sufficient variation being made to permit of the installation of a 7½-ton electrically operated girder crane. This crane, which is operated on 3 phase, 60 cycle, 440 volt, alternating current, was made by the Whiting Foundry Equipment Company and is of their special compensated gearing type for operating on circular runways. Extending around the outer ends of the 48 engine pits, is a 24 in. gage material track, for handling material on special push cars to and from the machine, smith and boiler shops. The running repair portion of the roundhouse is equipped with cast iron smoke jacks, 12 ft. long, made by the Paul Dickinson Company.

Fuel oil for kindling fires is furnished by two Bowser long distance rotary oil pumps, placed in the first and third sections of the roundhouse from the heavy repair shop end. The fuel oil handled by these pumps is stored in the basement of the



Typical Engine Pit.

oil house in a 12,000 gal. tank, about 800 ft. away, and there is no trouble experienced in drawing the oil from such a distance.

An innovation in the heating of roundhouses is presented in the use of cast iron wall radiators in the engine pits and on the outer circle wall pilasters, instead of the usual iron pipe coil radiators. Each pit has 432 sq. ft. of radiating surface and the total for the house, including the wall radiation, is 26,000 sq. ft. During the past winter the cast iron radiation has given entire satisfaction, and it is believed the experience gained in this roundhouse, which is the first in which cast iron radiation has been used, will warrant its further use in roundhouses where the corrosive action of smoke and water is very severe on steel and iron pipe. Exhaust steam from the power house is used for heating in all of the buildings in the locomotive department.

The engine house is lighted by high intensity Tungsten lamps, three of 250 c. p. being placed between the engine pits. This gives a very good light for night work. Supplementing the

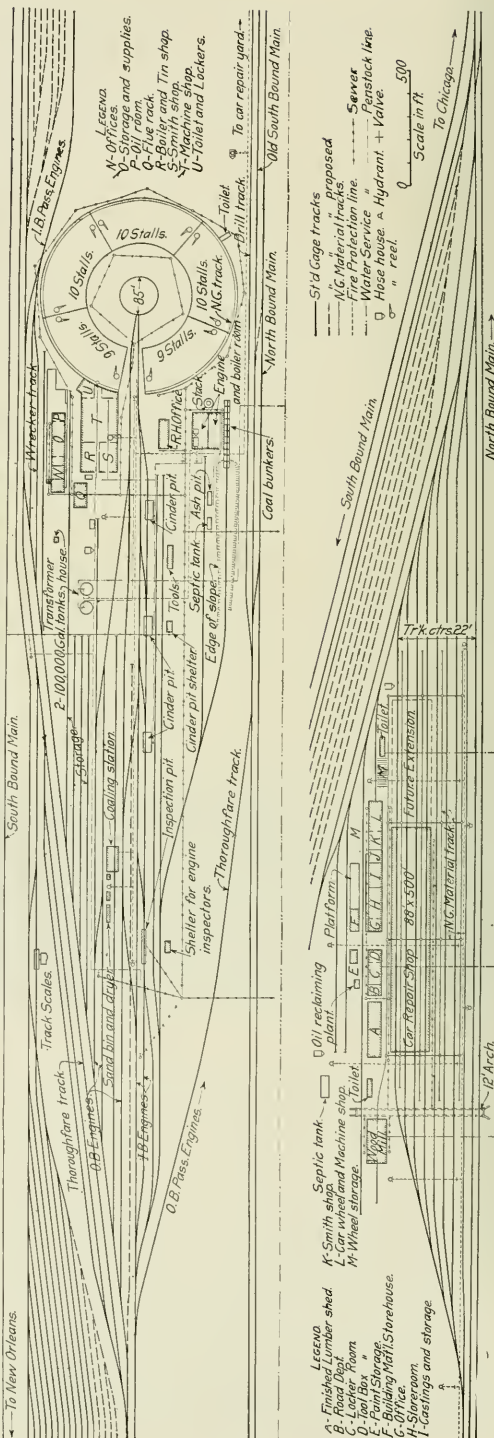

General Arrangement of Mechanical Terminal at Centrailla, Ill.

60-cycle, 440-volt alternating current circuit. Westinghouse motors were used on all new tool equipment and General Electric motors for group drive and application to all old tools. In the purchase of new tool equipment for these shops special attention was given to the selecting of tools which would give the desired speed variations with the use of constant speed alternating current motors. On some of the old tools two-speed motors are used to get the proper operating speeds for the class of work handled.

The lighting of the shops is by means of high intensity tung-

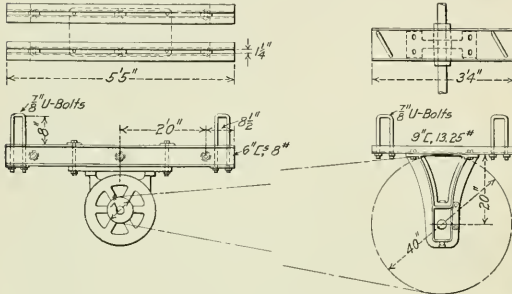

Shafting and Motor Supports.

sten units, varying from 100 to 250 watts capacity. A generous distribution of extension cord receptacles is provided for emergency use when general illumination will not suffice. Exhaust steam is used for heating this building, as well as all others in the locomotive department, cast iron wall radiation being used throughout in connection with a vacuum system and Webster vacuum valves.

OTHER BUILDINGS IN LOCOMOTIVE GROUP.

The roundhouse office is a brick structure 65 ft. x 20 ft., located just south of the roundhouse and across the entrance

ginger, the boiler foreman, the roundhouse foreman and a registry room are also included in the building.

Coal Chute.—The coal handling plant for supplying locomotives is a timber chute having a capacity of 600 tons. It was built complete by the T. W. Snow Construction Company, Chicago, and is of the double bucket or semi-balanced skip-hoist type, in which coal is unloaded into a depressed hopper from

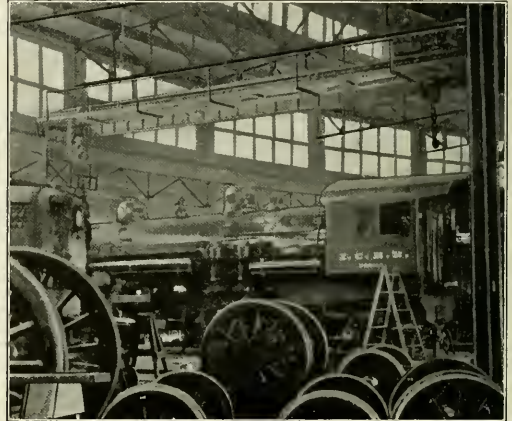

Interior of the Erecting Shop Section of the Roundhouse.

which it is delivered and elevated automatically to the storage bins above. The coal-hoisting apparatus of the plant is operated by a 10 h. p. General Electric induction motor.

Combined with and adjacent to the coaling plant are facilities for storing and drying engine sand. Storage capacity for 12 cars of sand is provided and one stove drier is used. After drying the sand is elevated by compressed air in the usual manner, the

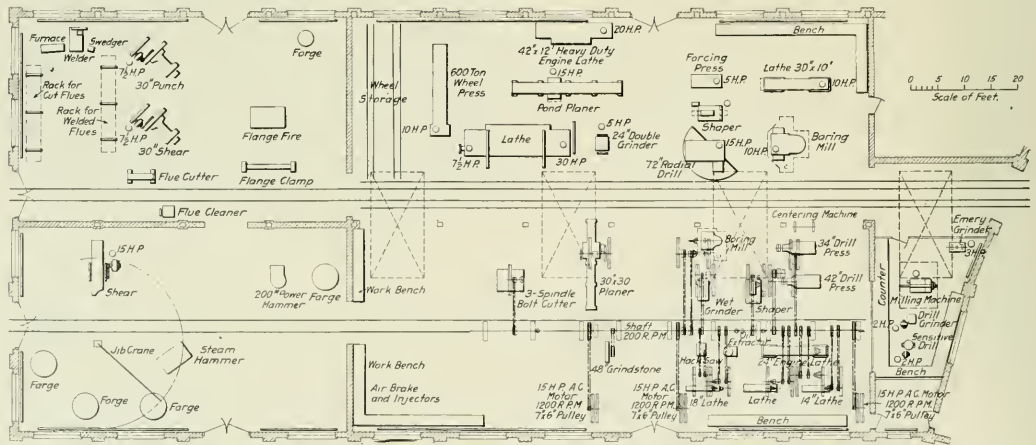

Arrangement of Tools in the Machine, Smith and Boiler Shops.

tracks from the machine shop. This building, which also contains the lavatory and lockers for the enginemen, is very complete and has all modern conveniences for the use of road employees. About 300 well-ventilated all-steel clothing lockers of generous size are provided in a separate room, which is adjacent to the lavatory, containing shower baths and other first-class toilet facilities for use of the enginemen. Offices for the traveling en-

delivery pipe to the storage bins in the coal chute being fitted with removable back ells, made by the Green Engineering Company, Chicago, where changes in direction are made. These fittings have been found to practically eliminate the troubles from wearing through of sand discharge piping at bends.

Inspection and Cinder Pits.—An inspection pit is provided on the incoming engine track near the coal chutes, with an office

and shelter for inspectors located convenient to it. The intention of the management is to develop the use of the inspection pit as much as possible and attempt to handle as many of the minor repairs to locomotives as can conveniently be done at this place, instead of in the roundhouse.

There are three single engine cinder pits from which the cinders are removed by a locomotive crane using a clam-shell bucket. This type of cinder pit might be considered as the standard of the Illinois Central and according to the officers of the motive power department gives entire satisfaction. Adjacent to the cinder pits a frame shelter building is located containing provisions for drying clothing, and lockers for the use of the men working on the pits. Located north of the cinder pit shelter is a building for the storage of tools used by enginemen while on the road. Scoop shovels, picks, water jugs, water pails, lanterns and oil cans are cared for in this building in a systematic manner, the equipment being gathered, cleaned and cared for by an attendant, who delivers it to enginemen.

Storehouse and Office.—This is located close to the machine,

Hand pumps of the self-measuring type are provided for handling all of these oils. Hand pumps are also used in the roundhouse and boiler and smith shops for handling fuel oil for kindling fires and for use in oil furnaces. Adjacent to the oil room is a waste storage space of sufficient size to carry a 30 days' stock of waste. The entire oil house equipment was installed under contract by S. F. Bowser & Company, and the pump tanks and piping represent this company's latest efforts in modern oil-house equipment. Lighting of the building is by tungsten clusters, with the exception of the oil rooms, where single tungsten lamps are encased in vaporproof globes and receptacles.

POWER HOUSE.

One of the most important buildings of the locomotive group is the power house, which is a fire-proof structure made of brick and concrete. On account of the extensive area over which the railroad company's operations in Centralia are scattered, and the general use of electricity throughout the various plants, and the lack of dependable central station service, it was decided to

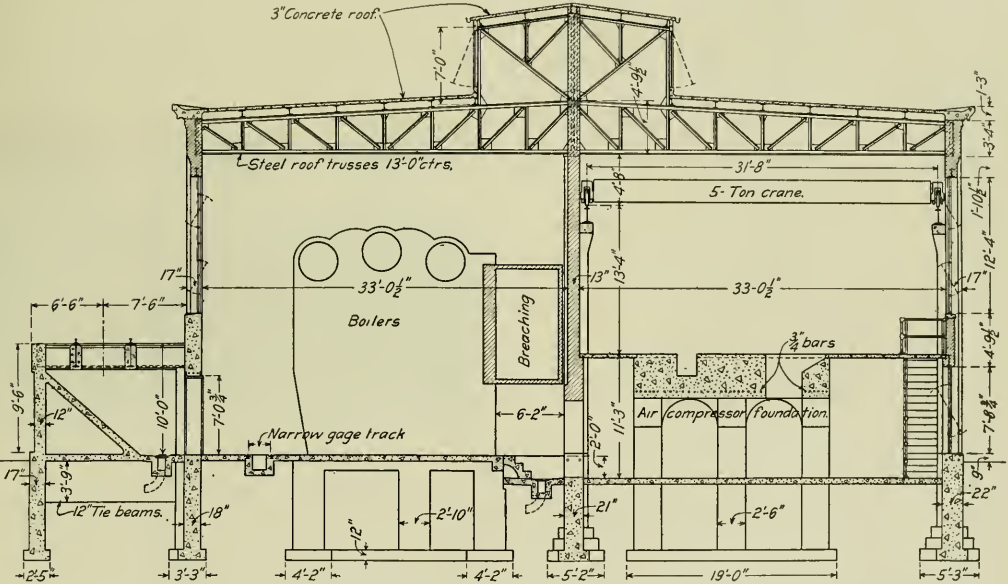

Section Through Power House.

boiler and smith shops, and roundhouse. The building is 175 ft. long by 30 ft. wide. A second story extends over 75 ft. of the building, the space being utilized for the storage of records, class room for apprentices, telephone exchange and rest room for enginemen. The rest room is equipped with 20 comfortable steel bunks and lounging facilities for use of enginemen off duty. On the first floor of the building are located the offices of the division master mechanic and storkeeper, the storeroom and the oil and waste rooms. The oil room possesses some unique features in the apparatus for handling oil, power pumps being provided for the handling of fuel, car and kerosene oils from the storage tanks in the basement to faucets for filling barrels on the platform. This arrangement has been found to work satisfactorily, as barrels need not be brought into the small pump room for filling. Separate tanks are provided for storing the following kinds and quantities of oils:

Fuel	12,000 gals.	Valve, superheated	1,600 gals.
Kerosene	3,500 gals.	Signal	1,200 gals.
Car, summer	3,500 gals.	Mineral seal	500 gals.
Car, winter	3,500 gals.	Black	500 gals.
Valve, saturated	1,600 gals.		

install an up-to-date electric plant for producing current at a minimum cost. Considerable expense was incurred and much thought was given to the design of the plant.

The equipment of the boiler room consists of four 250 h. p. Stirling water-tube boilers (hand fired) operating at 150 lbs. steam pressure; a Cochrane horizontal feed water heater of 2,000 h. p. capacity, and two 10 in. x 8 in. x 10 in. Blake-Knowles duplex boiler-feed pumps of the outside center packed, plunger type fitted with Fisher governors.

A reinforced concrete chimney 200 ft. high, having an internal diameter of 7 1/2 ft., disposes of the gases of combustion from the boilers. It is provided with a fire clay tile lining 70 ft. high, and the breaching connection between the boilers and stack is made of selected common brick, laid in cement mortar. The chimney was designed to allow of the operation of the four 250 h. p. boilers at a 50 per cent. overload, the grate surface in the boilers being proportioned accordingly. While the requirements of the plant probably never will call for the operation of the boilers under the above circumstances, conditions are obtained

for the burning of a very low grade of fuel with assurance of plenty of steam at all times.

The engine room is provided with two 250 k. v. a. 3-phase, 60-cycle, 440-volt, 3,600 r. p. m. General Electric turbo-generators running non-condensing; two 14 in. x 24 in. steam x 22 in. x 13 in. air by 18 in. stroke, cross compound, two stage, Laidlaw-Dunn-Gordon air compressors, providing an air pressure of 110 lbs., and having a capacity of 1,030 cu. ft. of free air per minute at 130 r. p. m.; a 1,000 gallon Alberger centrifugal fire pump, direct connected to a 100 h. p. General Electric induction motor; a 15 k. w. General Electric motor generator exciter operating at 125 volts, and a 15 k. w. General Electric turbo generator exciter operating at 125 volts; a 10 panel black marine slate switchboard, Westinghouse Electric & Manufacturing Company; an exhaust steam hot water heater for the car depart-

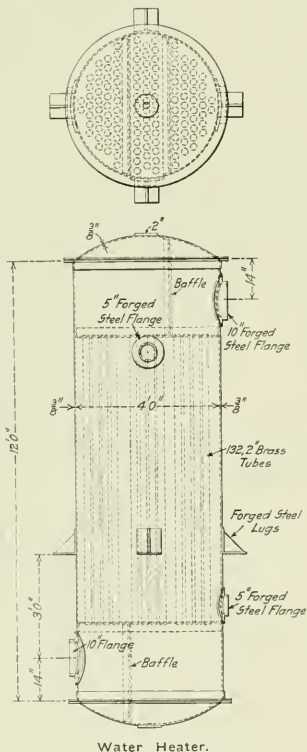

Water Heater.

ment heating system; a 5 in. Jeanesville Iron Works centrifugal circulating pump operated by a Terry turbine; two Marsh vacuum pumps for handling the heating system returns; two Adams Bagnall series arc light transformers, and a McFell fire alarm system controlling switchboard and recording apparatus.

In addition to the above equipment the engine room is fitted with a 5 ton Whiting hand operated crane for handling repairs to machinery. A Richardson-Phoenix automatic oil storage and filtering system is also installed to handle all oil used by the turbines, air compressors and pumps. All drains containing any oil are run through the filtering system and the oil recovered. Space has been reserved in the north part of the engine room for the installation of modern locomotive boiler washing and refilling equipment.

Special attention has been given to the handling of compressed air, thermometers being applied to the first stage dis-

charge and the second stage intake and discharge of the compressors for observation at all times of the temperature of the air. A cast iron after-cooler of unique design is placed north of the power house in connection with the air reservoirs, to effect a separation of contained moisture and reduce the temperature of the air. It is believed that this is the first instance where cast iron has been used for the purpose of cooling compressed air.

Electric power, in addition to being used for the operation of the motors and lighting in the locomotive and car departments, also operates motor driven air compressors at the hump and departure yards. Current also is used for lighting the freight yards and adjacent buildings, charging storage batteries, and is transmitted to Centralia for the lighting of the company property. In a general way the power house represents very advanced ideas in the economical production of electricity, steam and compressed air, and with the class of apparatus installed, and with its well planned arrangement, the hopes of the designers to be able to produce power at the lowest possible figure should be realized.

CAR DEPARTMENT.

The car department is located directly north of the locomotive group, the arrangement of the facilities being a double ended yard consisting of six active repair tracks and two stor-

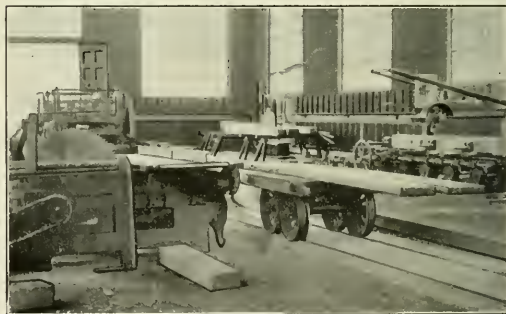

A Corner of the Wood Mill Showing Hot Water Radiators.

age tracks. Situated to one side of the repair tracks are the service buildings in which the necessary material used in the repairing of freight cars is stored and prepared ready for use.

The scheme of operation followed in designing the car department was to have a double ended yard to eliminate dead track space as much as possible, to provide a complete system of tracks for handling material to all parts of the yard, allow sufficient space for the storage of material, and make the operations of finishing material follow progressive sequence. That these conditions have been met is shown by the smooth operation and large output of repaired cars from the yard since the first day of its operation.

The following buildings are included in the car department group: Car repair shop; wood mill; oil recovery plant; dressed lumber shed; road department locker and lavatory, and tool room building; paint and oil storage building; and office, store, air brake, smith shop and car wheel shop building.

The car repair shop, which is 500 ft. long and 88 ft. wide, spans four repair tracks. It is an open ended structure, built entirely of wood and having a pitch and gravel roof. Skylights are spaced at frequent intervals, which makes the building very acceptable for working on dark and stormy days. Compressed air connections are provided on every fourth post of the shop.

The wood mill, in which all the wood making machinery is installed, is a fireproof structure built with brick walls, concrete and steel roof, and steel window sash. The machinery was placed in the building to allow of a progressive movement of material from

the lumber yard, located south of the mill, to the finished lumber shed and the repair yards on the north. The interior of the building presents a pleasing appearance with its large window areas and unobstructed overhead space. All machines are motor driven, and there is no belting of any nature extending above the tops of the machines.

The machine equipment of the woodmill, together with the horse power rating of the driving motor, is as follows:

Fay & Egan 4 sided dimension planer.....	50 h. p.	900 r. p. m.
Fay & Egan smoother.....	7½ h. p.	1,800 r. p. m.
Fay & Egan 5 in. x 24 in. planer.....	7½ h. p.	1,800 r. p. m.
Fay & Egan hand feed 24 in. rip saw.....	7½ h. p.	1,800 r. p. m.
Fay & Egan automatic cut-off saw.....	15 h. p.	1,600 r. p. m.
Fay & Egan 36 in. band saw.....	5 h. p.	1,200 r. p. m.
48 in. grindstone.....	3 h. p.	1,200 r. p. m.
Covel saw gummer.....	2 h. p.	1,200 r. p. m.
Covel knife grinder.....	2 h. p.	1,200 r. p. m.
Reciprocating vertical mortiser.....	3 h. p.	1,200 r. p. m.
20 in. turning lathe.....	2 h. p.	1,200 r. p. m.
Greenlee hollow chisel mortiser.....	15 h. p.	1,200 r. p. m.
Greenlee 4 spindle horizontal boring machine.....	10 h. p.	900 r. p. m.
Greenlee car gainer.....	15 h. p.	900 r. p. m.

The above machines, except for the Greenlee gainer, which is new, formed the equipment of the wood mill at the old shops, and required application of individual motors. Allis-Chalmers induction motors are used on all the machines except the gainer, which is driven by a Westinghouse motor. In applying the motors to the machines the Electric Controller & Supply Company

The oil is taken from the tank by a Bowser self-measuring plunger pump located in the oil recovery plant.

The north service building contains the office of the car department general foreman, store room for small material, an open space for the storage of heavy castings, an air brake and pipe shop, smith, and car wheel and machine shop. The store-room has the usual complement of material cases, well arranged. The air brake and pipe shop is equipped with pipe threading and bending machines, and a new Westinghouse triple valve testing rack.

Located in the smith shop are three forges, equipped with individual motor-driven blowers, and a Beaudry 100-lb. power hammer operated by a 3 h. p. induction motor; also a pneumatic forging machine. The car wheel and machine shop contains the following equipment, all of which was removed from the old shops, and to which individual motor drive has been applied:

Double head holt cutter.....	3 h. p.	1,200 r. p. m.
48 in. grindstone.....	3 h. p.	1,200 r. p. m.
36 in. vertical drill.....	3 h. p.	1,200 r. p. m.
Double head emery grinder.....	3 h. p.	1,200 r. p. m.
42 in. journal truing lathe.....	5 h. p.	900 r. p. m.
300 ton car wheel press.....	7½ h. p.	900 r. p. m.
Double head axle lathe.....	15 h. p.	900 r. p. m.
Car wheel boring machine.....	10 h. p.	900 r. p. m.

All motors used in the smith and car wheel shop were made by the General Electric Company.

The entire car department is well supplied with compressed

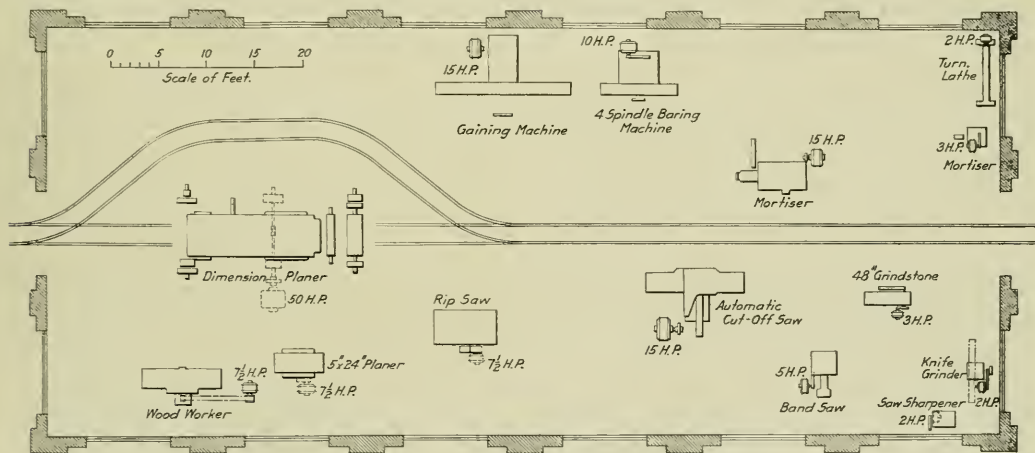

Layout of Machine Tools in the Wood Mill.

Baehr flexible couplings were used. When auto starters are located at some distance from the motors, push button devices in series with the no-voltage release coils of the starters are provided for quick stopping of the motors.

The oil recovery plant is located in a small brick building south of the paint storage house. All old journal box "dope" is worked over and the excess oil removed and reused. The waste tanks are heated in the winter by connection to the heating system and during the summer by a small hot water heating plant located in a separate room of the building.

All lumber, which is purchased finished, and the surplus output of the wood mill are kept in a finished lumber shed located adjacent to the repair tracks. A brick building north of the finished lumber shed contains a shop for the handling of repairs to hand cars, baggage trucks, and other roadway material, a lavatory room for the car department employees, and a storage room for tool chests, jacks and other tools used by the car repairers. A separate fireproof building is provided for the storage of car paint and car oil. The oil storage tank is located in the basement of the building, and has a capacity of 3,500 gals.

air from the power house through a 4-in. line located above the ground in an accessible position for inspecting and repairing leaks. Air outlets located 75 ft. apart connected to an underground piping system are provided throughout the entire repair yards, excepting the portion under the shop, where the air outlets are located on building posts. Underground drainage tanks are located at several points to avoid as far as possible troubles with contained moisture in the air. The outlet boxes are made of cast iron, and were designed especially for this installation.

A very complete system of 24-in. gage material tracks and turntables is provided, the layout of the tracks allowing the handling of material from all shops on roller bearing cars to any point in the repair yards without carrying it over 25 ft.

No attempt has been made to provide any illumination of the car repair yards except in and around the service buildings and wood mill. In the various shops 300-watt tungsten lamps are used, while in the remainder of the rooms tungsten clusters using 60-watt lamps and 60-watt single tungsten units furnish the light which is entirely in the nature of general illumination.

Heating.—An innovation in railroad shop practice is the use

of hot water for heating all buildings of the car department. Heat for the system is obtained from a heater located in the engine room of the power house, which utilizes exhaust steam for heating the water. The circulation of the water is effected through two 5 in. pipe lines connected to a 5 in. Jeanesville centrifugal pump driven by a Terry steam turbine operating at 1,800 r. p. m. and located in the engine room basement.

From the power house to the various buildings of the car department the two 5 in. circulating lines of the system are con-

GENERAL.

Electrical Distribution.—All current produced in the power house is of three-phase 440 volts. All the wires from the switch-board are run in conduit to a steel distributing tower located adjacent to the power house. Practically all transformers used for the locomotive department service are located on a concrete platform in the tower, about 7 ft. above the ground. By adopting this plan all voltage circuits above 440 volts, with the exception of two series arc circuits, are kept out of the power house switch-

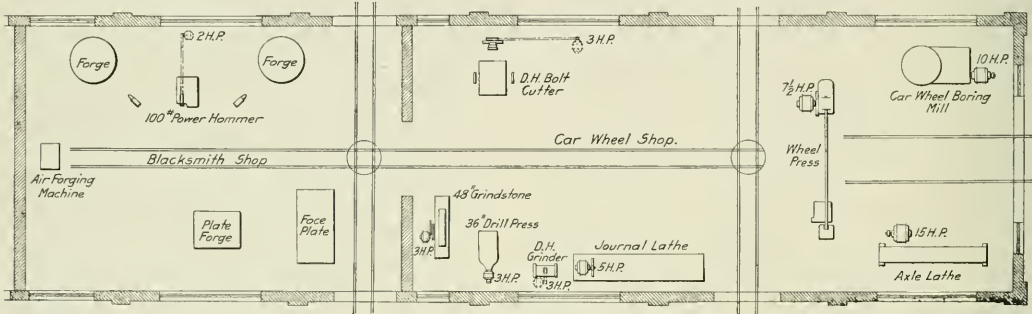

Arrangement of Equipment in the Car Department Wheel and Smith Shops.

tained in a concrete conduit. The radiation in all of the buildings is of the cast iron wall type and from observations taken during the past winter the hot water system has proved to be a decided success, satisfactory temperatures being maintained in the various buildings even under extreme low temperature conditions.

The maximum distance through which the hot water is transmitted in one direction in the heating system is 2,635 ft., the extreme building being the toilet located north of the service

board. The circuits in the vicinity of the locomotive department are carried on structural steel towers so placed as to not interfere with building extensions or operation of the various terminal facilities.

Power is transmitted to the car department for light and power at 440 volts, a suitable transforming arrangement for obtaining low voltage for lighting being placed close to the center of distribution. Power is also transmitted to Centralia from the car

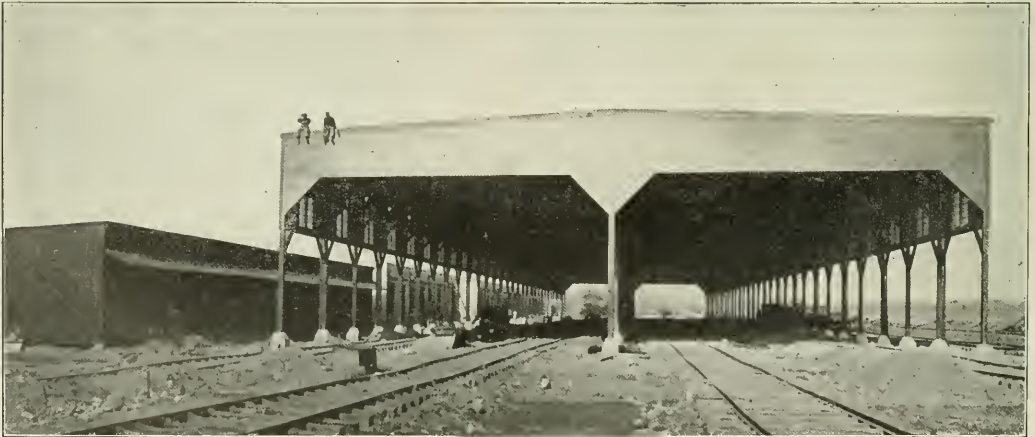

Open Car Repair Shed Before the Yard Was Surfaced.

buildings in the car repair yards. The obtaining of satisfactory heat in buildings located at this distance from the source of heat supply is practically impossible with the use of low pressure steam under the ground conditions prevailing at Centralia, and the results obtained have fully justified the judgment of the engineers in departing from the usual practice of either using high pressure steam or providing a separate boiler plant conveniently located to furnish the required amount of steam.

department circuit, being transformed up to 2,300 volts. Electricity for light and power at the freight yards leaves the main distribution tower at 2,300 volts and is stepped down through transformers to the proper voltage at the various points where it is used.

Lighting of the entire terminal property, with exception of the freight yards, is by means of 500-watt tungsten units. The freight yards are lighted with series arc lamps, the transformers

for which are placed in the power house. The use of high intensity tungsten units for yard lighting service has proved entirely satisfactory, the volume and intensity of the light appearing to be better than that obtained from the ordinary arc lamp.

Telephone System.—An automatic telephone system provides intercommunication between all departments of the railroad company at Centralia. A 30-circuit switchboard of the Automatic Electric Company is installed in the second floor of the storehouse and office building. The decided success with the Automatic telephone system installed at the Burns shops prompted the telegraph department officers to place a similar system at Centralia. The distribution of telephones is quite complete, an instrument being placed at every point where it could be used to advantage.

Water Supply.—Water for use in locomotives and for drinking purposes is obtained from the municipal water plant of the city of Centralia, through an 8 in. wood stave pipe, connection being made to the city mains at the city limits. Water storage is provided for at the terminal in two 1,000 gal. tanks of timber construction, located just south of the machine shop. On account of the water supply being of uncertain quality and at times unfit for drinking purposes during the late summer months, it was necessary to install a filter and purifier in connection with a separate piping system for distributing drinking water to various points around the plant, where bubbling fountains are provided. Alum is used as the purifying reagent when necessary, and as the filter and purifier is located in the roundhouse where plenty of steam is available for sterilizing, drinking water obtained from the filter and purifier should be of uniformly good quality.

On account of the close proximity of the terminal to large farming interests, some treatment of the sanitary sewage was necessary to render it suitable for discharging into drainage ditches. This condition is obtained through the use of concrete septic tanks, one each being located in the car and locomotive departments. These tanks are designed to retain the sewage for a period of 24 hours, which will allow sufficient time for partial disposal by bacteriological means of the objectionable contents.

All engineering incidental to the design and construction of the entire plant, including the freight yards, was handled by the engineering and mechanical departments of the railroad. The mechanical details were handled by the office of the shop engineer, under the supervision of M. K. Barnum, general superintendent motive power. The design and construction of the buildings was executed under the supervision of F. L. Thompson, engineer of bridges and buildings, and J. A. Taggart, reporting to A. S. Baldwin, chief engineer. T. S. Leake & Company, of Chicago, were the general contractors for all masonry and building work excepting the coal chutes. Kehm Bros. Company, of Chicago, installed all steam and hot water heating and steam and compressed air piping throughout the entire plant.

LONG DISTANCE FLIGHT.—A French aviator, Marcel G. Brindejonc des Moulineaux, recently flew from Paris to Warsaw, by way of Berlin, a distance of 932 miles, in thirteen hours, and excluding stops, obtained an average speed of 93 miles an hour. He accomplished this in the competition for the Pommery cup for the longest flight across the country from sunrise to sunset in one day. He landed at Wanne, in Prussia, at 8 a. m. and in Berlin at noon.

SUNDAY TRAINS IN SCOTLAND.—An influential deputation of Scottish religious bodies waited upon the Caledonian Railway board of directors to press home the public outcry against the Sunday railway service which is to be inaugurated immediately. Sir Charles Renshaw, refusing the prayer of the petition, said the Scottish railways had not by any means moved rapidly in the direction of developing Sunday traveling. The public demanded it, and, as Glasgow cars had long since given these facilities and citizens had not objected, there was no reason why railways should not share in the traffic.

FALSE ECONOMY IN DRAFTING

BY C. J. MORRISON.*

Frequently much pressure is brought to bear on the drafting room to effect economies, and many methods have been suggested whereby the desired savings could be secured. Much money can be made or lost by the methods followed in the drafting room, but possible economies in this department must be considered from all standpoints. A few dollars saved on

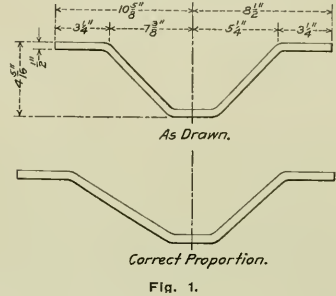

Fig. 1.

drawings may lose many dollars in the manufacturing departments.

Recently a large concern, as a matter of economy, stopped making drawings to scale. This step may save a trifle on the first cost of drawings, but is liable to lose many dollars in the course of manufacture. Even the economy in the drafting

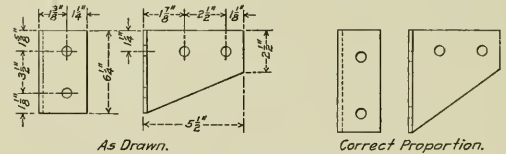

Fig. 2.

room is doubtful, as it takes nearly as long to make a haphazard drawing as to prepare one to scale. Furthermore a drawing is supposed to represent an article so that it will be recognized by one familiar with drawings, and drawings fail in this essential unless made to scale.

A few actual examples are shown which will illustrate the

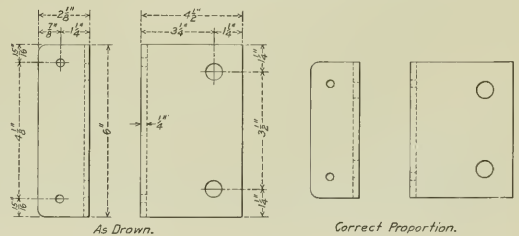

Fig. 3.

difficulty in using drawings which are not to scale. In each case the drawing is shown as actually made, and also as it would appear if drawn to scale. Some of the illustrations give only one view, as the other views would add no information.

In the drawings reproduced in Figs. 1 and 2 entirely wrong

*Chief Engineer, Froggatt, Morrison & Co., New York.

impressions are given as to the shapes and sizes of the pieces represented and a continual, careful check is necessary to avoid mistakes. Not only this, but both drawings fail to give a single over-all dimension. A checker is liable to fail to recognize the

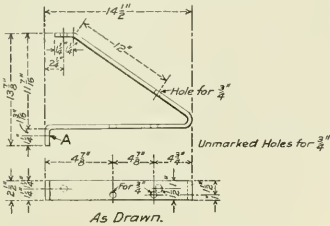
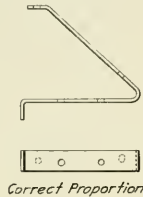

Fig. 4.



pieces in the shop. Fig. 3 shows an example which is so dangerous as to scarcely need comment. Fig. 4 illustrates how a saving at one point will give a loss at another. Care has been taken to mark the size for every hole except one, then the in-

the drawing. In case the drawing is made to scale a dimension may be omitted, but when not to scale every dimension must be shown.

Figures 6 and 7 simply show the impossibility of getting correct ideas from the drawings as originally made.

Drawings such as these are a continual source of trouble in the shop and the little saving made in the drafting room is lost over and over again.

GAINES FIREBOX ON THE ILLINOIS CENTRAL

After an experience of several months with a six-wheel switching locomotive fitted with a Gaines combustion chamber, a high degree superheater and a Ragonnet power reverse gear, the Illinois Central ordered 40 more of the same design which are now being delivered by the American Locomotive Company. A similar design of firebox was also specified on one of the last order of Mikado type locomotives built by the Baldwin Locomotive Works for this railway.

When the Lake Shore & Michigan Southern fitted a high degree superheater to a switch engine, a little over a year ago, considerable doubt was expressed as to the chances for the success of the experiment. The results, however, were even better than had been anticipated by the officials responsible for the trial and later experience on this and other roads has shown that in no service does the superheater give as great an improvement in operation or percentage saving in fuel and water as in switching. Coal savings as large as 50 per cent. have been reported in some instances. This greatly reduces, and in some cases is said to practically eliminate the smoke, due not only to less coal being fired, but also to the opportunity for more efficient work on the part of the fireman.

Reduction of the smoke from switch engines is an important feature at many yards, and particularly so at some of the yards on the Illinois Central. In an effort to make even further improvement in this particular, as well as to obtain greater economy of coal and cost of boiler maintenance, a Gaines combustion chamber was also applied to the experimental engine. This combination is reported to have been as successful as it is known to be on road engines. As a still further improvement, a power reverse gear was specified for the purpose of reducing the labor of the engineman, particularly on those engines operating in the warmer climate at the southern end of the system.

The service of the first engine in the yards on the lake front in Chicago has been very satisfactory. The yardmaster reports that it is capable of much more work than others of the usual design due to quicker action and a smaller loss of time for getting water or fuel. No difficulty has been experienced with delayed stopping after the throttle is closed, or with slow action with the reverse gear. The engine crews have equally favorable comments to make.

Outside steam pipes, arranged the same as for a superheater road engine are used. A connection is made to the superheater damper so that it is closed when the blower is put in action. This is in addition to the usual small cylinder and counterweight working in conjunction with the pressure in the steam chest and has been applied as a positive insurance that this damper is closed when the blower is open.

There is a manhole in the boiler shell under the base of the bell. This is for the inspection of the tubes and firebox and will permit the entrance of a man without removing other parts as is generally necessary when entrance is made through the steam dome.

In other respects the design follows common practice for this type of locomotive when fitted with Walschaert valve gear. The features of the design are clearly shown in the illustration and the dimensions will be found in the table at the end of this article.

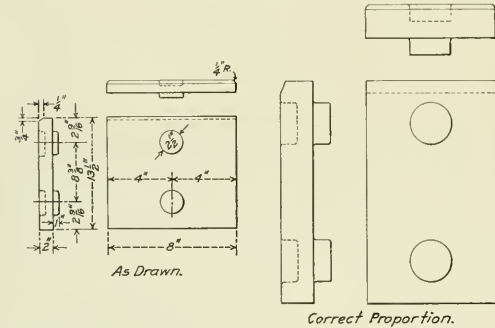

Fig. 5.

formation is added, "Unmarked holes for 3/4 in." There is all probability a hole at the point A, but the drawing does not show it. If economy is desired, why should the holes be drawn when the location of the centers and a statement, "All holes

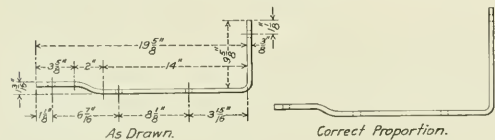

Fig. 6.

for 3/4 in." gives all necessary information? It seems particularly unnecessary to mark hole B, and then show its elliptical projection.

Considerable trouble was caused by the drawing shown in

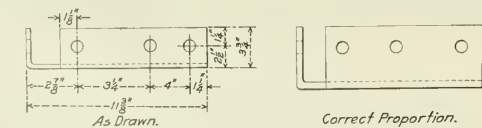

Fig. 7.

Fig. 5, as no idea of the piece could be obtained from the drawing. This drawing is particularly inconsistent, as several dimensions are lacking and must be judged from the appearance of

Mikado type locomotives have proved most satisfactory on the Illinois Central, and during the past two years 150 engines of this type have been received from the Baldwin Locomotive Works. All of these have cylinders 27 in. x 30 in., 63 in. drivers and a steam pressure of 175 lbs. The tractive effort is 51,700 lbs. A typical example was illustrated and described on page 346 of the September, 1911, issue of this journal. One of the locomotives in the last order differs from the others in that it has been fitted with a Gaines combustion chamber. This has required considerable change in the boiler but in other respects the engine is the same as the others of this class.

The boilers of the locomotives with the normal firebox are 82 in. in diameter at the front ring, have tubes 20 ft. 6 in. in length and a total evaporative heating surface of 4,068 sq. ft.

is considered, there seems little doubt but that this design of boiler will have an equal or greater capacity than the others. The fact that a larger increase in the amount of firebox heating surface does not result from the much larger mud ring is explained by the practical elimination of the throat of the boiler and the raising of the grate level throughout. The depth of the firebox is about 73¼ in. at the front and 64 in. at the back and the distance from the grate level to the crown sheet at the front end of the grate is but 66 in.

The brick wall is set 36 in. from the back flue sheet and is 13 in. thick. The top of the wall is 20 in. from the crown sheet at the center. There are six air inlets discharging underneath a deflecting brick arranged as shown in one of the illustrations. The grate area of this firebox is 67.5 sq. ft. The ratio of firebox heating surface to grate area is 3.77, while on the other loco-

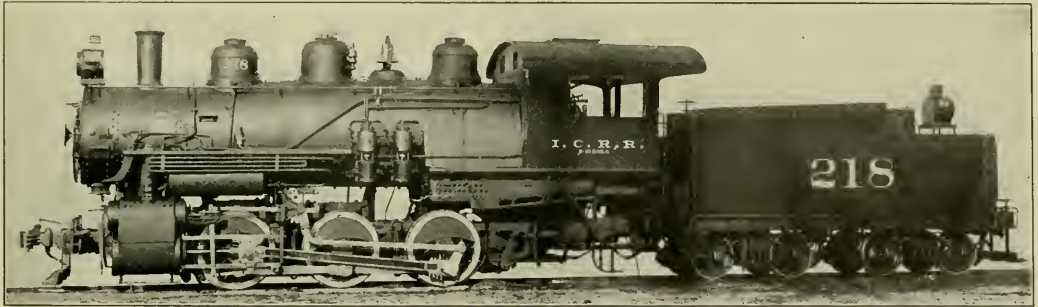

Superheater Switch Engine with Gaines Combustion Chamber; Illinois Central.

The grate area is 70 sq. ft., and the firebox is 120¼ in. long by 84 in. wide. On locomotive No. 1600, which is fitted with a Gaines combustion chamber, the firebox is 198 in. long by 90 in. wide and the tubes have been shortened to 18 ft. 3 in. This has resulted in a loss of 421 sq. ft. of heating surface in the tubes which is slightly offset, so far as actual area is concerned, by a gain of 19 sq. ft. in the firebox, leaving a net loss of 402

sq. ft. in spite of the fact that they are considerably deeper, the ratio is but 3.36. The grate is of the usual finger type, rocking in four sections and with a dump grate at the rear.

It will be seen that the advantages offered by the Gaines arrangement in connection with the location of the firebox in relation to the driving wheels have proved valuable in this case and the front mud ring is located almost directly over the rear

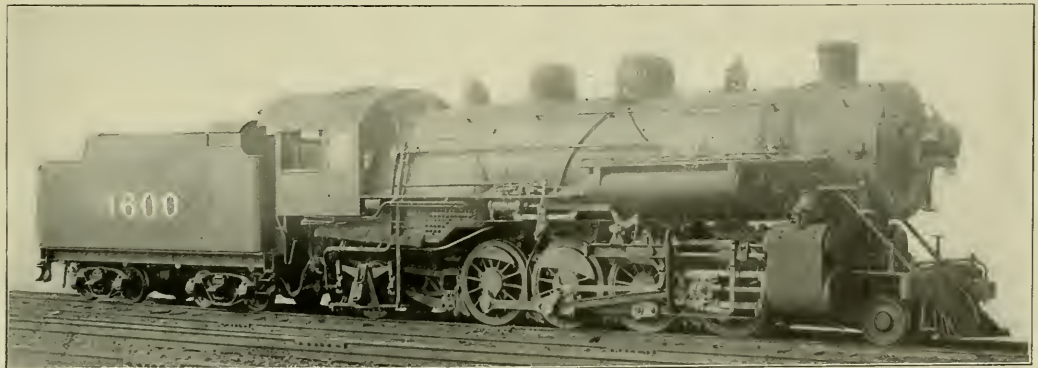

Mikado Type Superheater Locomotive with Gaines Combustion Chamber.

driving axle. In order to give the necessary clearance the mud ring is inclined sharply upward on the sides, at the point of connection of the steel casting supporting the brick wall, and reaches practically the level of the bottom of the barrel. The lowest point is 8 in. below the level of the front corners. Flexible staybolts are used throughout the combustion chamber section

sq. ft. As a steam maker, however, it is probable that this boiler will prove even better than the others. It is known that on the contrary, a gain in firebox heating surface is of very decided value and especially when the improved combustion given by the Gaines arrangement of brick arch and air inlets

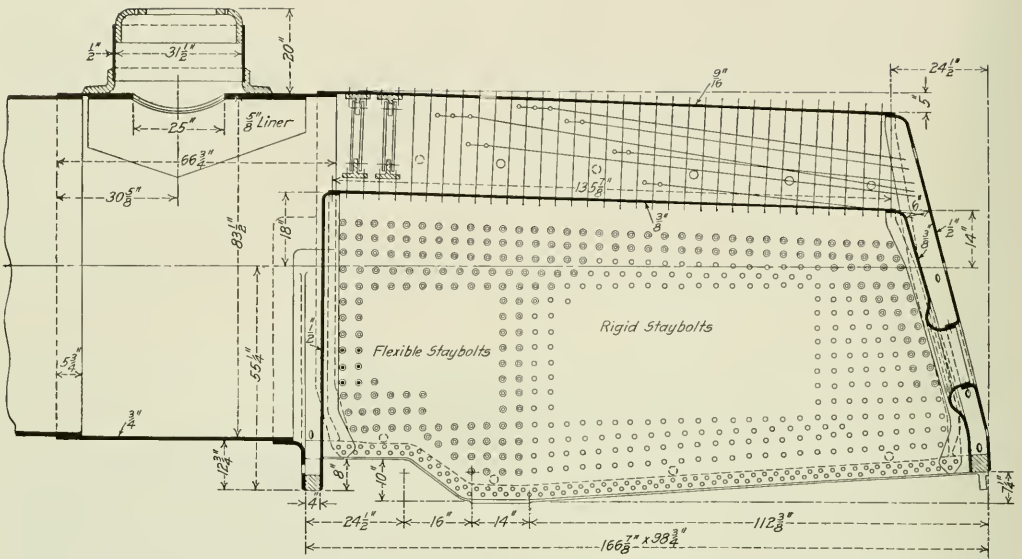

Longitudinal Section of Back End of the Boiler on the Mikado Type; Illinois Central.

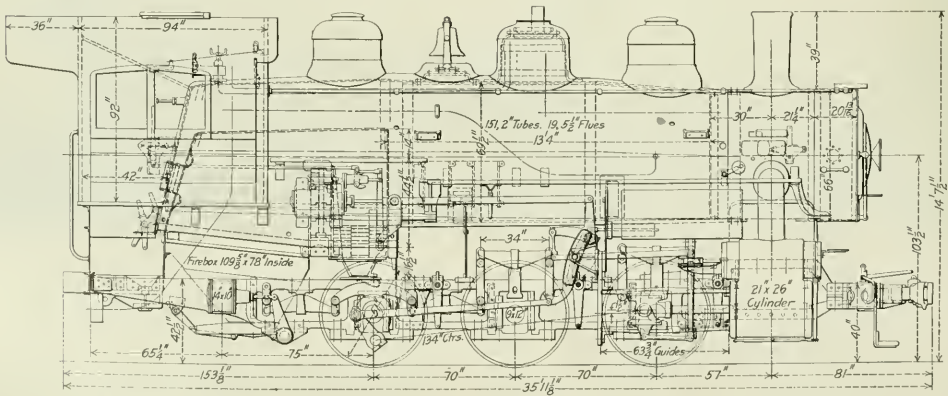
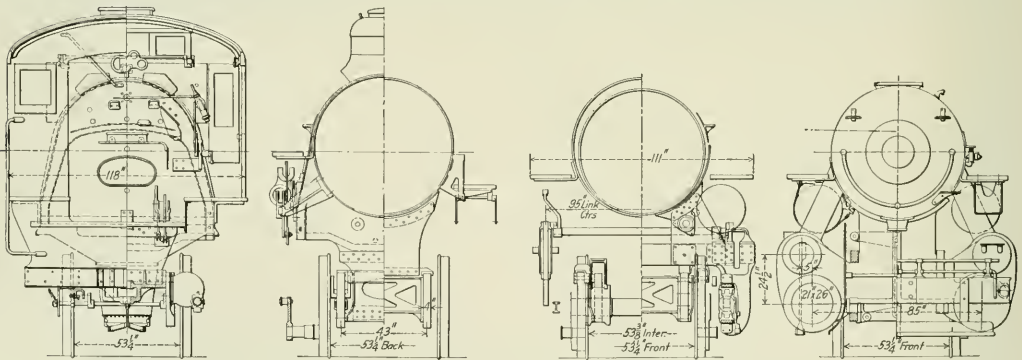

Six-Wheel Switcher with Superheater, Galnç Combustion Chamber and Ragonnet Power Reverse Gear; Illinois Central.

and also in the top two rows and down the back of the side sheets. The firebox is radial stayed except for the customary two rows of sling stays at the front end of the crown sheet.

These locomotives are provided with superheaters having 36

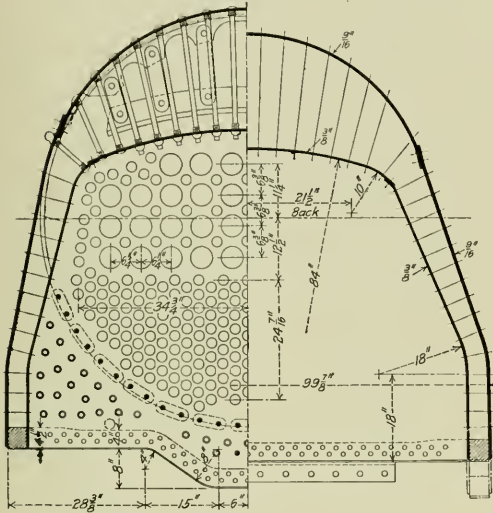

Sections Through the Firebox of the Mikado.

elements and are fitted with outside steam pipes. The general dimensions, weights and ratios are given in the following table:

Traction effort	51,700 lbs.	32,450 lbs.
Weight in working order	280,000 lbs.	166,000 lbs.
Weight on drivers	217,000 lbs.	166,000 lbs.
Weight on leading truck	28,000 lbs.
Weight on trailing truck	35,000 lbs.
Weight of engine and tender in working order	450,000 lbs.
Wheel base, driving	16 ft. 6 in.	11 ft. 8 in.
Wheel base, total	35 ft. 2 in.	11 ft. 8 in.
Wheel base, engine and tender	65 ft. 7 in.

Ratios.

Weight on drivers ÷ traction effort	4.20	5.12
Total weight ÷ traction effort	5.42	5.12
Traction effort × diam. drivers ÷ heating surface	880.00	1,061.00
Total heating surface ÷ grate area	54.20	40.20
Firebox heating surface ÷ total heating surface, per cent.	6.93	9.70
Weight on drivers ÷ total heating surface	59.10	106.50
Total weight ÷ total heating surface	76.20	106.50
Volume both cylinders, cu. ft.	20.00	10.40
Total heating surface ÷ vol. cylinders	183.30	149.60
Grate area ÷ vol. cylinders	3.38	3.74

Cylinders.

Kind	Simple	Simple
Diameter and stroke, in.	27 x 30 in.	21 x 26 in.

Valves.

Kind	Piston	Piston
Diameter	15 in.

Wheels.

Driving, diameter over tires	63 in.	51 in.
Driving, thickness of tires	3 1/4 in.
Driving journals, diameter and length	11 x 12 in.	9 x 12 in.
Engine truck wheels, diameter	30 1/2 in.
Engine truck journals	6 x 10 in.
Trailing truck wheels, diameter	45 in.
Trailing truck journals	8 x 14 in.

Boiler.

Style	Straight	E. W. T.
Working pressure	175 lbs.	170 lbs.
Outside diameter of first ring	82 in.	63 in.
Firebox, length and width	158 x 90 in.	109 3/4 x 78 in.
Firebox plates, thickness	3/8 & 1/2 in.
Firebox, water space	4 in.
Tubes, number and outside diameter	262—2 in.	151—2 in.
Flues, number and outside diameter	36—5 1/2 in.	19—5 1/2 in.
Tubes and flues, length	18 ft. 3 in.	13 ft. 4 in.
Heating surface, tubes	3,412 sq. ft.	1,409 sq. ft.
Heating surface, firebox	254 sq. ft.	150.5 sq. ft.
Heating surface, total	3,666 sq. ft.	1,559.5 sq. ft.
Superheater heating surface	752 sq. ft.	366.6 sq. ft.

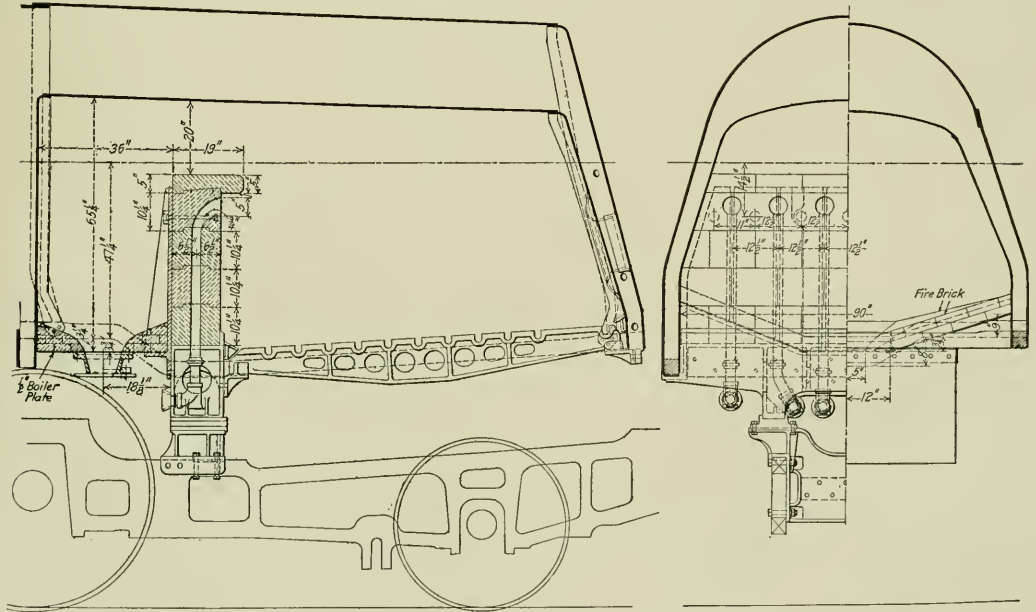

Arrangement of Gaines Combustion Chamber on Illinois Central Mikado.

Type	2-8-2	0-6-0	Grate area	67.5 sq. ft.	38.8 sq. ft.
Gauge	4 ft. 8 1/2 in.	4 ft. 8 1/2 in.	<i>Tender.</i>		
Service	Freight	Switching	Journals, diameter and length	6 x 11 in.
Fuel	Bit. coal	Bit. coal	Water capacity	9,000 gals.	5,500 gals.
			Coal capacity	15 tons	6 1/2 tons

OIL AND GREASE CUPS FOR RODS

BY ROBERT C. MORTON.

Grease and oil cups, especially those on the main and side rods, are small locomotive details that give an excellent return from careful study to discover the best design. On a road having more than 2000 locomotives, close attention was given to this feature and, after a period of development, a design which appears to be practically perfect is now being used.

Originally detachable or independent oil cups of various designs, usually, however, made of brass, were used on the rods, but a number of years ago this road, together with practically all others, started using the solid cup formed as an integral part of the rod. At first these were made round in imitation of the detachable cups, but later the rectangular design was substituted. One of the illustrations shows a section of this type of cup arranged for using grease, the design shown being one of the first to be tried. Inasmuch as the plunger is frequently removed and reapplied and its normal use soon wears the threads enough to give a very loose fit it is necessary to use a sleeve to protect the threads in the solid oil cup. This sleeve was first made of brass with a hexagon shaped top. This was later changed to the spanner nut type, shown in the illustration, to prevent their easy removal with an ordinary wrench. At the bottom of the cup is a stud bolt or rod bushing keeper which secures the rod bushing at the top and is drilled for feeding the oil or grease to the pin. It has been found that the most suitable thread, both for these bolts and for the cap where it passes through the sleeve, is ten threads per inch.

A brass sleeve arranged as shown weighs about 1½ lbs. and costs about 23 cents for material and labor, and while it was intended that the sleeve should not be removed except when the locomotive came in the shop for general repairs, it developed that they frequently disappeared, and to overcome this a steel or wrought iron bushing without wrench fit was substituted. This has completely removed the difficulty from loss by theft and at the same time has reduced the cost of these bushings from 23 cents to 10 cents each.

The rod with this type of sleeve and the present arrangement of cap and stud is also illustrated. The sleeves are forged in the blacksmith shop and are threaded with a slight taper on the outside. They are inserted with a stud nut and are screwed in as tightly as possible and can be considered part of the solid cup. They are removed only when it is found that the wear is sufficient to necessitate the application of a new one. By means of these sleeves or bushings, a standard type and size of cap or plunger may be used on all the cups.

While this type of bushing together with the stud bolt illustrated in connection with it gave a cup body that was thoroughly satisfactory, considerable difficulty was experienced in finding the best type of cap and grease plunger. After a trial of various combinations of grease and oil, the method of lubrication on this road has finally settled down to the use of grease on the main pins and oil on all others. The arrangement of the cups for oil is, of course, comparatively simple, but considerable trouble was found in getting the proper cap or plunger for grease. At first a hollow cast iron plunger 2¼ in. in diameter was used with a lock nut. This arrangement is shown in the first illustration. A small wrought iron plug was then tried as it was thought too much grease was wasted by the larger size. This, however, was soon discarded and return was made to the larger size wherever possible. Malleable iron plugs were next offered and a design having a teat on the bottom which engaged in the grease and prevented the plug from becoming unscrewed was tried. With this arrangement no lock nut was needed. Finally, however, the grease plunger was entirely discarded and a grease cap was adopted, as it was found that if the cups were properly filled and the caps were screwed down tight enough to start the grease feeding, it would continue to feed in sufficient quantities to insure the proper lubrication of the journal. This cap, as it

is now used, is shown in the second illustration. The oil cup cap is identical with the one used for grease with the exception that it is drilled and countersunk through the top. The oil cups are filled with curled hair and wool waste, which prevents the oil holes from becoming clogged and acts as a strainer.

These grease and oil cup caps are drop forged and cost about 7½ cents a piece, completely finished. There are only three styles of caps used for the entire locomotive crank pin equipment, and these are all made from the same drop forging. Of these, two are identical except that one is drilled for oil while the other is used for grease. The third type is a smaller size.

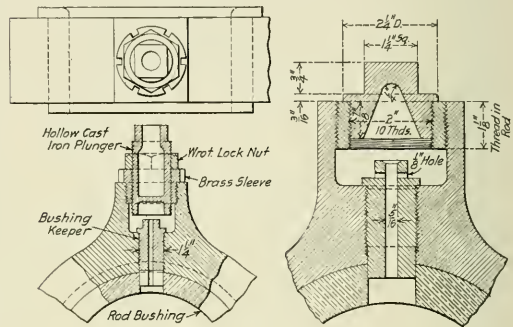

Old and New Types of Grease Cups on Main Rods.

When independent cups have to be used, a design of malleable iron cup is used, which takes the same cap as the solid cup. These cups do not have the wrought iron sleeves. They are held to the rods by a collar stud and also have a ¼-in. dowel pin driven in the bottom of the cup which enters a hole in the rod and prevents the cup from turning.

This arrangement for rod lubrication has now been in use for some time and appears to be thoroughly satisfactory. The number of parts required for renewals are very few. A minimum amount of capital is tied up in the equipment and the arrangement throughout appears to be thoroughly durable and efficient.

RECORD FOR STRAIGHTAWAY FLIGHT.—Maurice Prevost, a French aviator, on June 19, flew 217 miles at the rate of 117 miles an hour. This was a straightaway flight. The previous record made by Prevost was made on a circular course.

HOURS OF LABOR IN NEW YORK.—Chapter 462 of the Laws of New York, passed this year, makes 10 hours' labor within 12 consecutive hours a legal day's labor in the operation of railroads and street railroads, except where the mileage system of [paying men engaged in] running trains is in operation. This law applies to all roads 30 miles long or longer.

EARLY RAPID TRANSIT.—The Camden & Amboy Railroad is, we learn, partly completed and in use. This road will probably be the most traveled in this country. Passengers who leave Philadelphia at half-past six in the morning may dine in New York at 4 p. m., as they are landed at half-past three o'clock. The time is not far distant when six hours will be ample time to perform the journey.—From the *American Railroad Journal*, October 6, 1832.

WARNING FOR RAILWAY TRAINS.—A pressure tube anemometer has been placed at an exposed station of the West & South Clare Railway Ireland, to give notice of the terrific ocean gales which sometimes derail trains. A special electrical signaling device has been added by the British meteorological office and this transmits an alarm when the wind reaches 65 miles an hour, and another if 85 miles is attained. Trains are ballasted after the first signal, and all traffic is suspended on the second alarm.—*Newark News*.

SHOP PRACTICE

INSTALLATION AND MAINTENANCE OF ELECTRIC HEADLIGHT EQUIPMENT

BY V. T. KROPIDLOWSKI.

I.

The enactments of the legislatures of a number of states requiring that railroads operating within their borders provide their locomotives with headlights of a certain candle power or intensity practically compel the use of the electric headlight. This accessory of the locomotive is comparatively new on some of the western roads, or at least on the greater number of their divisions, and especially to those to whom the task of installing and maintenance is intrusted; moreover the time allowed for the equipment of all locomotives has been so short that little consideration could be given to the selection of a

It is intended in this article, which is the first of a series dealing with the installation and care of electric headlight equipment, to describe a method of wiring which has flexibility as one of its main features and which can be applied with any existing type of electric headlight equipment. By referring to the wiring diagram, Fig. 1, it will be seen that only three wires are required from the switch in the locomotive cab to the lamp, two of which should be, throughout their entire length, of sufficient capacity to carry the whole load, and one (number three) should be, from the negative lead of the generator to the lamp, of a capacity to carry the current necessary for the incandescent lamps at the front end of the locomotive. By tracing out the connections it will be found that when the switch in the cab is thrown into contact 3, the current flows from the positive lead of the dynamo through wire 1 and the arc lamp, returning to the negative lead of the dynamo by way of wire 2,

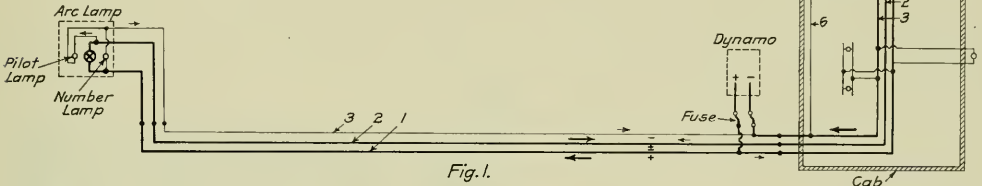

Fig. 1.

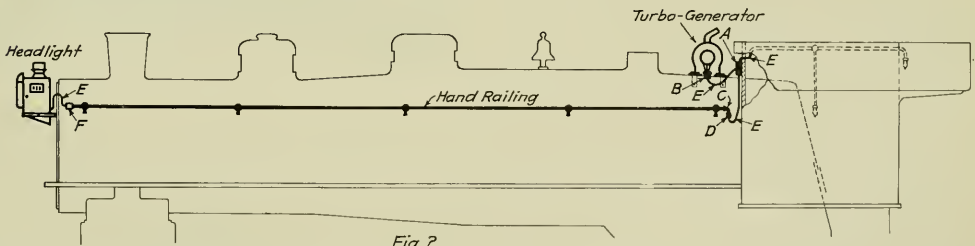

Fig. 2.

suitable system of wiring and details of sufficient flexibility to permit its application to all classes of locomotives and headlight equipment.

The electric headlight equipment is a complete power plant in itself and demands the attention of men trained along that line, but its care is frequently intrusted to men who do not thoroughly understand it, with the result that much unnecessary expense is incurred, the apparatus is damaged and the blame laid to imperfections in construction. In order to make the electric headlight a successful and economical addition to the locomotive, it must be given the attention of trained men; the work of installation and maintenance should be placed in the hands of a capable man who should select intelligent and preferably young men as his assistants at various points on the system, instruct them in the work and retain them expressly for it. It would also be a move in the right direction to install an electric headlight in the air brake instruction car and give lectures on its care and operation similar to those given on the subject of air brakes.

through the switch to contact 1, the circuit is broken, the arc lamp then goes out and the pilot lamp lights, receiving current from the dynamo through wire 1, contact 1 and wire 2, and returning it over the wire 3 to the dynamo; the large arrows represent the current of the arc lamp and the small ones that of the pilot lamp. The number lamp burns continuously, as it is connected across wires 1 and 3, which lead directly from the generator. The classification lamps are not shown, as some roads are not in favor of electrifying them because of the possibility of the enginemmen forgetting to put in the right markers when they do not have to go to the lamps to light them. The writer believes, however, that this difficulty can be overcome.

The arrangement consisting of the extra contact 4, attached to the switch, the resistance 5, and the wire 6, is employed only in connection with a series wound generator, such as the American, manufactured by the Remy Electric Company, but when a compound wound generator is used, such as the Pyle or

Schroeder, the resistance 5 must be removed or the connections broken, leaving a blank space between the contact 4 and the wire 6; this is important as with the circuit unbroken in that branch it would cause the generator to develop too high a voltage and possibly burn out the incandescent lamps or the fuses, if they were used.

Fig. 2 shows the method employed to conceal the wiring, and the fittings required in connection with it. A weatherproof, cast iron junction box *A*, in which is fastened a triple-to-double plug cut-out, is fastened to the front of the cab. The leads from the dynamo are led into a type "F" conduit as shown at *B*, and through a Greenfield flexible steel conduit *E* to the junction box, which they enter from the side, and are connected to the two terminals of the cut-out which make connection with the plug fuses. The main circuit wires are run through the hand rail of the locomotive and at the cab end a Greenfield combination coupling, *C* and *D*, is used to connect a flexible steel conduit *E* to the railing, the flexible conduit being of sufficient length to reach to the junction box *A*, entering it from the bottom, and the circuit wires are then clamped to the cut-out block. The main circuit wires are continued from the junction box *A* into the cab and to the switch. The wiring in the cab can be open and cleated to the ceiling of the cab, but in the long run it pays to have it in a flexible steel conduit, as in case the wiring needs to be removed for any reason, it is much simpler to unfasten a few conduit fasteners and remove it in a unit than to have a tangled group of loose wires.

At the head end of the locomotive a junction box *F* is attached to the end of the hand rail and the main circuit wires lead into it and are connected to a triple pole cut-out. The circuit is continued to the headlight in a flexible steel conduit *E*, which is led into the lamp and connected to the proper binding posts.

Most of the later wiring is concealed in a separate conduit, the reason given being that it prevents the possibility of injury to anyone walking on the running board and holding to the hand rail. It is not believed that it is dangerous to use the hand rail as a conduit, nor that it increases the difficulty of dismantling the locomotive. The conditions are unlike those in a power plant; the potential carried is so low that even though a ground were purposely established, with the return circuit constituting a man grasping the hand rail and his bare feet placed on any metal part of the locomotive, it is doubtful whether the low electromotive force of thirty volts could cause any current to flow through the painted hand rail. Moreover, the dynamo is grounded to the boiler and, consequently, to every metal part of the locomotive. Supposing a ground did develop in the winding of the generator; one ground is of no consequence and two grounds, one on each wire of opposite polarity, are necessary to complete a path for the current. Should another ground develop by the insulation wearing off one of the wires in the hand rail, there would be no more shock than one would experience by submerging a piece of pipe, with both ends open, in a small stream of water. As to the wiring strung through the hand rail hindering its removal, the hand rail is seldom removed between shoppings, and at those times, if the proper fittings are selected, it will take very little longer to disconnect the wires in the junction box in the cab, unfasten the fitting from the cab end of the hand rail, and disconnect the wires in the junction box at the front end than it does to remove the finishing knobs on the ends of the rail.

EXPERIMENTAL RAILROAD.—The Railroad Company of this city (Raleigh, N. C.) expect to have their road between the Capitol Square and the Stone Quarry completed by New Year's Day if not prevented by inclement weather, and a handsome car upon it for the accommodation of such ladies and gentlemen as may desire to take the exercise of a railroad airing.—From a despatch dated December 28, 1832, to the *American Railroad Journal*.

THE MANUFACTURE OF BRAKE BEAM HANGERS

BY ISAIAH S. WESTLEY.

Erecting Foreman, Philadelphia & Reading, Reading, Pa.

All the hammer and forging machine work for the Philadelphia & Reading is done at the Reading, Pa., shops and it has been the aim to keep the number of operations and heats down

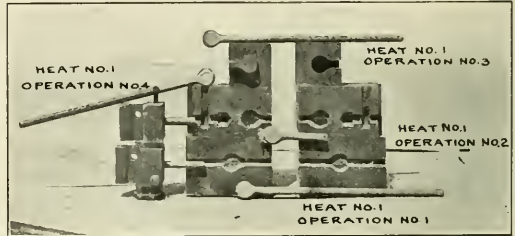

Operations in Making Brake Beam Hangers at the Reading Shops.

to the lowest possible number in order to lower the cost of production and increase the output.

The method of manufacturing brake beam hangers is shown in the illustrations. After the stock is cut to the required length and the first heat taken, the following is the order of

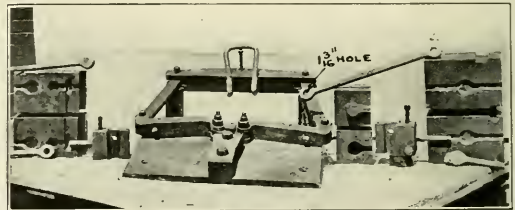

Former and Dies for Making Brake Beam Hangers.

the operations: Operation 1, heat 1, upsetting end; operation 2, heat 1, squeezing in forming die; operation 3, heat 1, trimming fin in trimming die; operation 4, heat 1, punching hole for hanger pin. One end of the hanger is then complete and heat

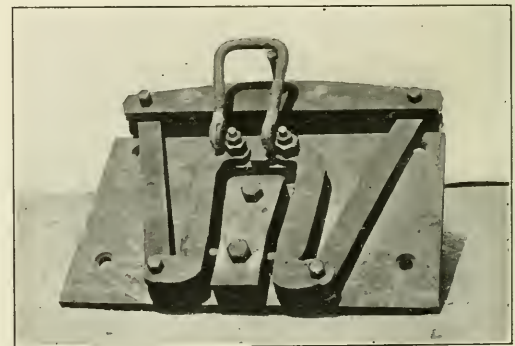

Former for Brake Beam Hangers, in Closed Position.

2 with the same operations completes the other end; the hanger is then ready for the forming machine. The final operation of forming the hanger in the die is made with the third heat;

the forming machine is of a hinge type, operated by a 14 in. x 12 in. brake cylinder. It is controlled by a single valve and is therefore easy to operate. The dowel pins engage with the holes in the hanger; this does away with the necessity for centering and insures the holes being in line and the hanger the correct length. With four men, two working on an Ajax forging machine and two on the forming machine, the total output for ten hours is 650 hangers; it can readily be seen that a considerable saving in fuel will result from reducing the number of heats.

SHOP KINKS

BY W. H. WOLFGANG,
Draftsman, Wheeling & Lake Erie, Toledo, Ohio.

SAFETY GATES.

In a great many shops where railway tracks pass very close to the doors and corners of the buildings, accidents may be easily eliminated by the use of gates, such as shown in Fig. 1. These can only be used where no regular traffic is carried on, and they

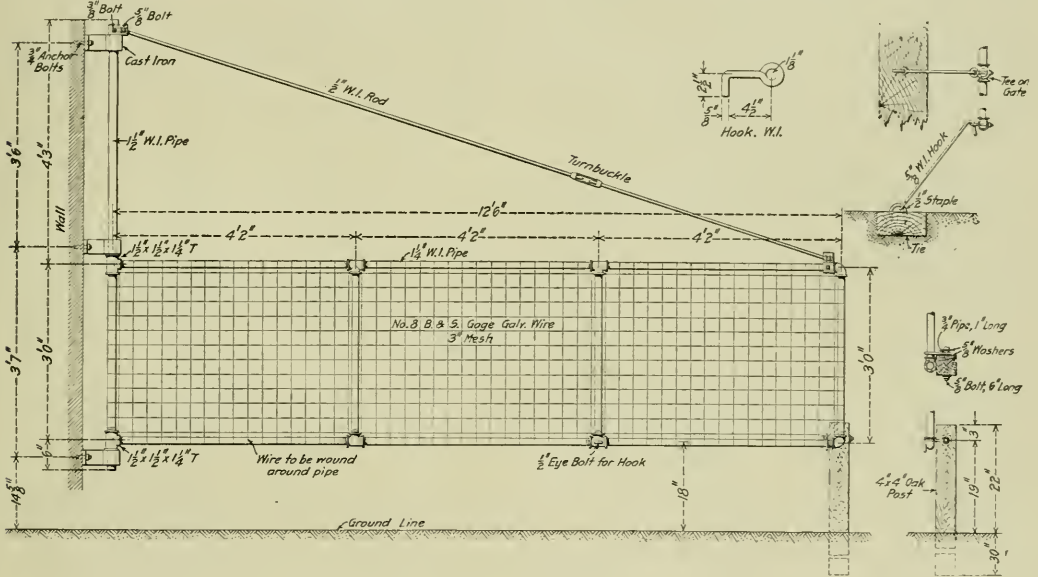

Fig. 1—Safety Gates for Use in Shop Yards.

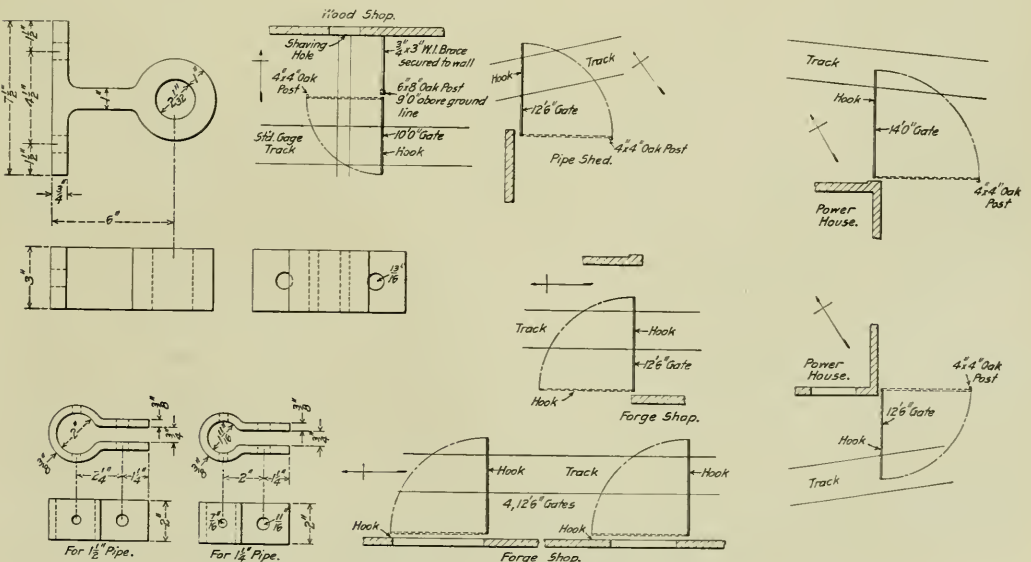

Fig. 2—Various Methods of Locating Safety Gates to Prevent Accidents.

are operated as follows: When a train is shifting past the doors or corners of the buildings, the gates are swung back off the track and secured so as to close the passageway. The different methods by which the gates may be applied are shown in Fig. 2. The gate post is made from a 1½ in. standard pipe, which revolves in three cast iron brackets as shown in Fig. 2. These are bolted to the walls or posts as may be convenient. The gate is made from 1¼ in. standard pipe and fittings. The length of the gate can be made to suit. Galvanized iron wire netting of 3 in. mesh and No. 8 Brown & Sharp gage is secured to the 1¼ in. pipe by wrapping the strands of wire around the pipe. The method of locking the gate when swung across the tracks, and the method of securing it when swung across the passageway is shown in Fig. 1.

BALL BEARING JIB CRANE FOR GENERAL USE.

Usually jib cranes that are not ball bearing are hard to swing when carrying a load, especially when it is applied near the

riveted to the mast by two web angles and supported by two 1¼-in. guy rods. Ball bearings 1½ in. in diameter are used at the bottom of the crane and 7/16-in. steel roller bearings at the top. The top support can be made to suit the conditions of the buildings.

MACHINERY BELT RECORD.

The chart shown in Fig. 4 has been found to be a good scheme for keeping an accurate record of the belting on machinery. These diagrams can be made for various types of machines and each belt and pulley marked as shown. The belt man can keep the records up to date so that whenever a belt breaks he can readily refer to his diagrams for its length and size and can immediately set about getting another to replace it. In this way he will save both his own time and that of the workmen. The speed and direction of rotation of the pulleys is also shown so that if it is desired to change the speed of any machine a study of the conditions may be made directly from the chart.

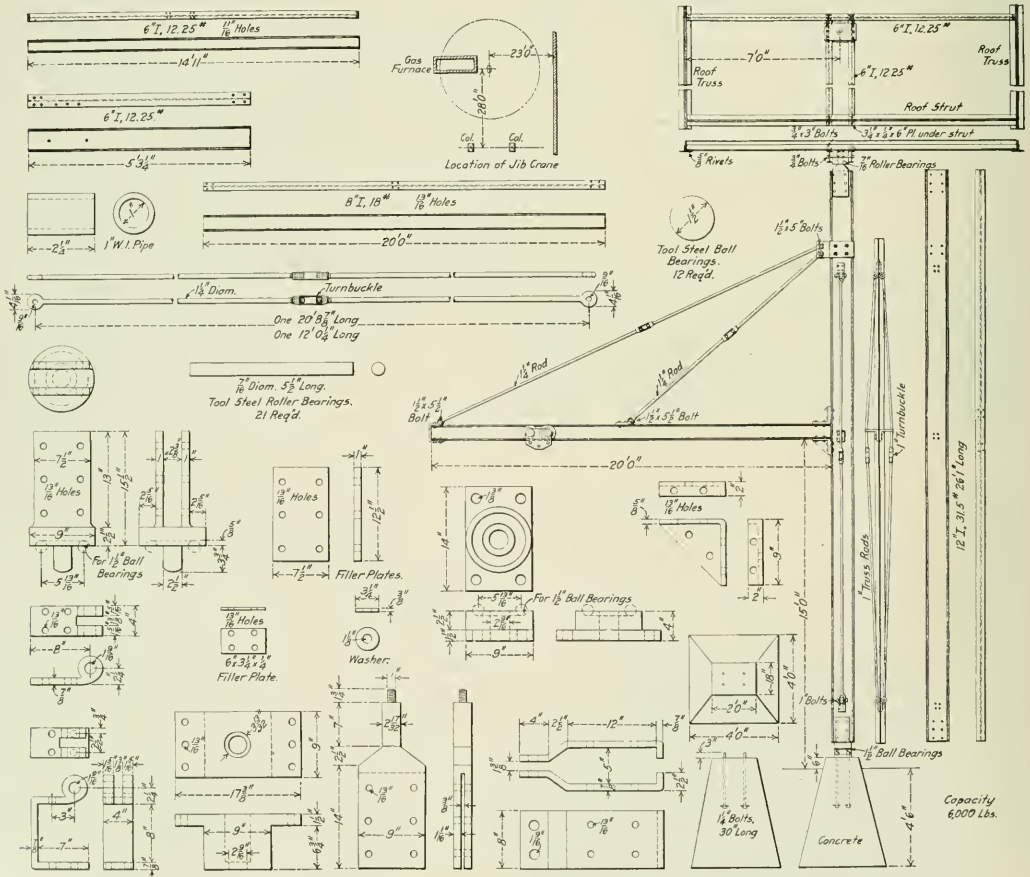

Fig. 3—Ball-Bearing Jib Crane of Three Tons' Capacity.

mast. The crane shown in Fig. 3 is provided with ball bearings and was designed to carry a load of 3 tons. As one man can easily swing the loaded crane, it will be found that the additional cost will soon be paid for by the time and labor saved. A 12-in., 31.5-lb. I-beam is used for the mast, and is reinforced by two 1-in. truss rods as shown. The boom is an 8-in., 18-lb., I-beam

The illustration shows the belting record for a 4½-in. surfacer, and is typical of the records for other machines.

REINFORCING A STEEL BUILDING COLUMN FOR A 2,500 LB. CAPACITY JIB CRANE.

The reinforcement shown in Fig. 5 was applied to a roof supporting column to prevent it buckling when a 2,500 lb. jib crane

was applied to it. A $\frac{3}{8}$ in. x 12 in. wrought iron plate was riveted the full length on the face of the column, and another shorter $\frac{3}{8}$ in. x 12 in. plate was riveted on top of this plate.

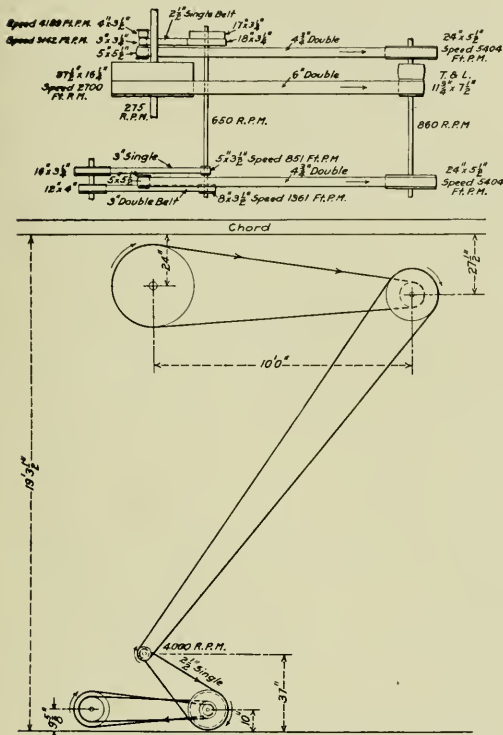

Fig. 4—Belt Record Diagram.

Some $2\frac{1}{2}$ in. x $2\frac{1}{2}$ in. x $\frac{1}{4}$ in. angles were riveted on the back of the plates as shown. Three sets of $\frac{1}{4}$ in. x 6 in. wrought iron braces were riveted to the plates and the column flange, and

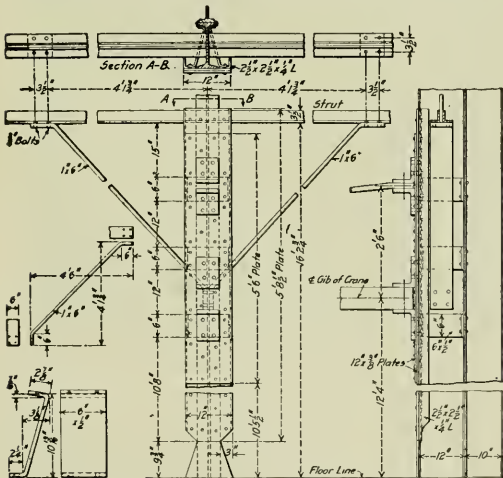

Fig. 5—Roof Column Reinforced to Provide for Jib Crane.

two 1 in. x 6 in. wrought iron braces were riveted to the column and roof strut. The brackets were then bolted to the column, as shown. The crane boom was secured to the lower brackets and the tension rod to the upper ones.

WRENCH FOR REMOVING LUBRICATOR CHOKE PLUGS

BY F. W. BENTLEY, JR.,
Butler Shops, Chicago & North Western, Milwaukee, Wis.

The greater percentage of lubricator troubles is caused by the obstruction of the choked end of the reducing plugs. It is an easy task for the engineer or shop man to uncouple the delivery nut and remove the plug if the lubricator is accessible for the application of a common monkey wrench and the squared end of the choke plug has not been rounded by other applications of the wrench; however, in many instances, owing to the cramped location of the lubricator and to the condition of the end of the plug it is almost impossible to remove it, and failures are often the result.

The illustration shows a wrench that can be easily forged

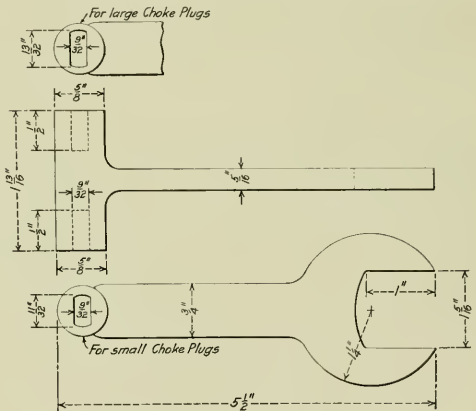

Wrench for Removing the Choke Plugs from Lubricators.

and which it is believed will eliminate all difficulties in connection with the hurried cleaning of choke plugs. The delivery nuts on all Nathan locomotive lubricators are of the same size, and are easily uncoupled by the forked end of the wrench. The two sizes of reducing plugs used in this lubricator are easily removed by the socket on the other end of the wrench no matter how badly they are rounded at the ends, or twisted. One of these wrenches can be kept in the roundhouse office where it is promptly available when failures of this nature are discovered over the "going out" pit, and one can be easily carried in the engineman's tool box.

HOT AIR BLAST.—It is stated that the weekly consumption of coals at the Clyde Iron Works has been reduced by the adoption of the heated blast from 1,800 tons to 600 tons, while, at the same time, a greater quantity of iron has been manufactured.—*American Railroad Journal*, February 9, 1833.

RAILROAD NEWS.—The steam car South Carolina arrived at Charleston at half-past seven p. m. on the 15th from Branchville, 62½ miles, in 7 hrs. 15 min., all stoppages included. Eighteen passengers; cargo 70 bales of cotton. Stopped at Summerville 30 min. to discharge freight cars.—*American Railroad Journal*, January 5, 1833.

POWER REQUIRED FOR PUNCHING

BY L. R. POMEROY.

In punching a hole in a plate, the total area of shearing is that of a curved surface—of a cylinder of a length equal to the thickness of the plate (*t*) and a diameter equal to the diameter of the hole (*d*). Assuming a plate of 60,000 lbs. tensile strength, the resistance due to shearing is

$$\pi \times t \times d \times 60,000 \dots\dots\dots 1$$

It has been found, experimentally, that in punching plates,

This value multiplied by the number of holes punched a minute and divided by 33,000 gives the horsepower for the punching alone. To this must be added the friction of the machine and the efficiency of driving.

- Let *S* = Tensile strength of the plate = 60,000 lbs.
- d* = Diameter of the hole.
- t* = Thickness of the plate.
- E* = Effective depth of entrance of punch to shear the plate = $\frac{1}{3}$.
- N* = Number of holes punched a minute.
- C* = Efficiency of punch (assumed to be 75 per cent.).
- C_m* = Efficiency of motor or drive (assumed to be 80 per cent.).

Combining (1) and (2) and allowing for the efficiency of the machine and driving mechanism we have

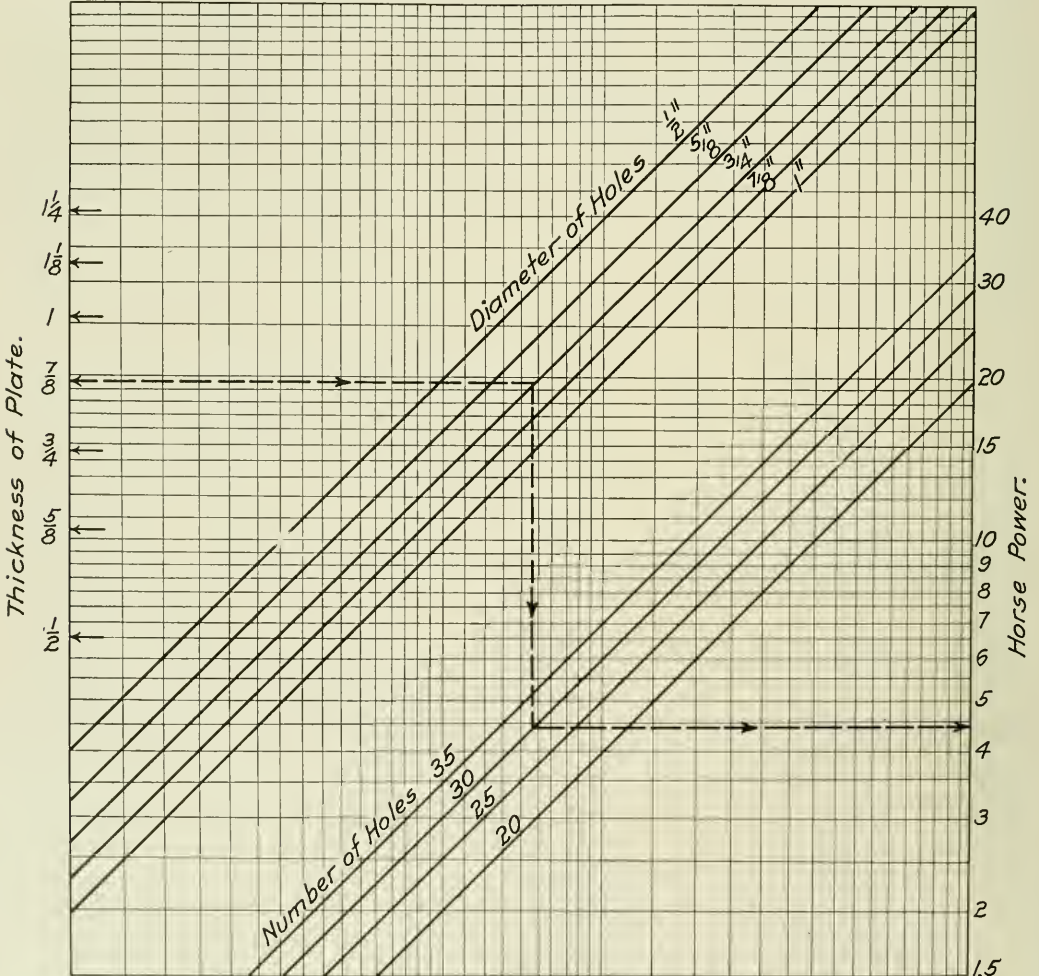

Horse Power Required to Punch Holes in a Steel Plate of 60,000 Lbs. Tensile Strength.

of the tensile strength given, when the punch has passed one-third the distance through, the material is all sheared off.

Assuming the resistance to be constant during the process of punching, the work in foot pounds necessary to punch one hole equals the resistance in pounds per square inch times $\frac{1}{3}$ the thickness of the plate, divided by 12, or as given above,

$$t \times \frac{1}{12} \times \frac{1}{3} \dots\dots\dots 2$$

$$\frac{\pi \times t \times d \times 60,000 \times t \times N \times E}{33,000 \times 12 \times .75 \times 80}$$

Cancelling and reducing, we have

$$\frac{t^2 \times d \times N}{3.78} \dots\dots\dots 3$$

This formula is the basis on which the accompanying diagram is constructed.

When using the diagram the required thickness of the plate is taken on the scale at the left, and the line is followed horizontally to the right, to its intersection with the diagonal for diameter of hole; thence vertically downward to the diagonal for number of holes punched a minute, and then horizontally to the right where the required horsepower is found.

SHOP KINKS FROM THE FRISCO*

BY J. C. BREKENFELD,

Assistant Machine Shop Foreman, St. Louis & San Francisco, Springfield, Mo.
CLAMPS FOR HOLDING DRIVING BOXES.

The angle and T-shaped castings, shown in Figs. 1 and 2, are used for clamping driving boxes to the bed of the planer for machining the shoe and wedge faces. They are so arranged

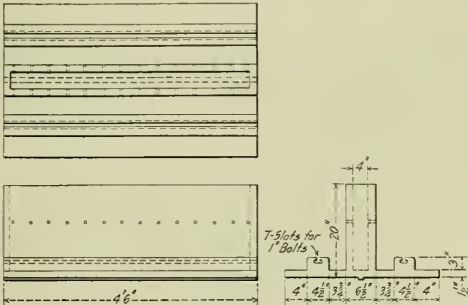

Fig. 1—Clamps Used for Planing Driving Boxes.

that the faces rest directly on the projection, which is 4½ in. wide. The T-slot extending through it is for clamping the box to the casting. This device insures the two faces being planed parallel. The lug on the bottom of the casting fits into the slot of the planer, and the casting is held in position by ordinary

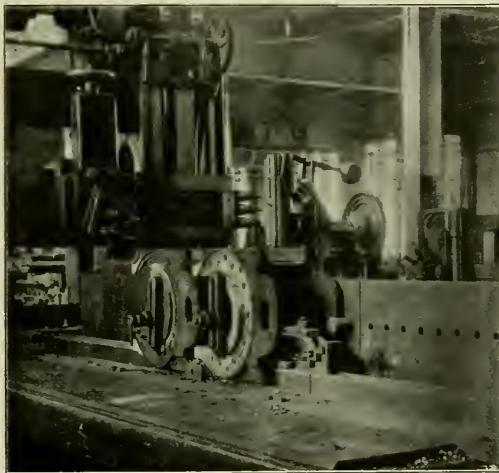

Fig. 2—Angle Clamp for Planing Driving Boxes.

extension clamps. The T-shaped casting is used where the planer has two tool heads. Fig. 2 shows the application of the angle clamp, which is similar to the T-clamp, ribs being cast on the outside to give additional strength.

CLAMP FOR LIFTING TIRES.

A simple arrangement for lifting tires in and out of a boring mill is shown in Figs. 3 and 4. It holds the tire in a horizontal position, making it easy to handle and convenient to place on

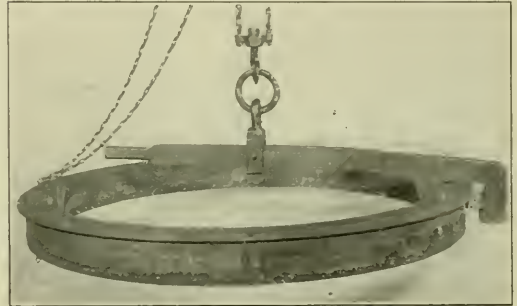

Fig. 3—Lifting Clamp for Tires.

the machine. By shifting the sliding block, which carries the hoisting ring, the different sizes of tires are balanced. This block is held in position by a set screw. The clamp is fastened

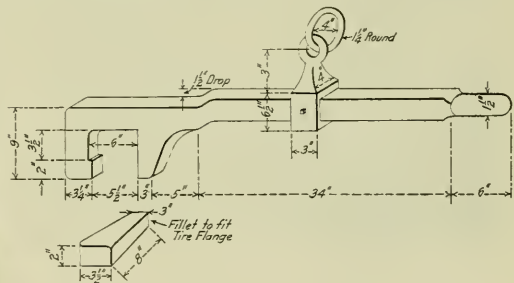

Fig. 4—Details of Tire Lifting Clamp.

to the tire by a wedge driven in between the jaw and the tire face just under the flange, making a secure fastening as well as a quick one.

RADIUS PLANER ATTACHMENT.

With the arrangement shown in Figs. 5 and 6, cylinder saddles may be planed in a much shorter time than it takes to

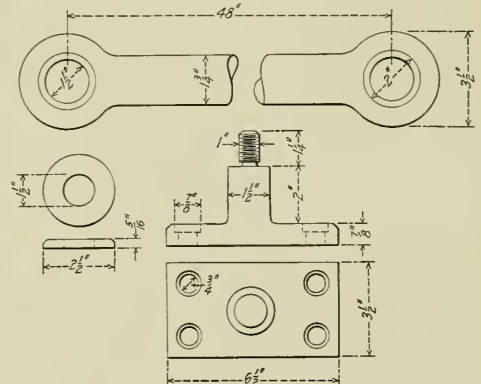

Fig. 5—Radius Arm and Bearing for Planer Radius Attachment.

*Awarded first prize in March 15, 1912, Shop Kink Competition.

chip them. In the case of a double head planer the arrangement is very simple. The left hand head, as shown in Fig. 6, is fixed at a point which is approximately the center of the arc to be planed on the cylinder saddle. The four bolts that control the swinging movement of the head are released and a 4-ft. rod extends, as shown, from the top of the tool slide to the top of the tool slide on the right hand head. As the right hand head is moved along the cross-bar, it will swing the other head

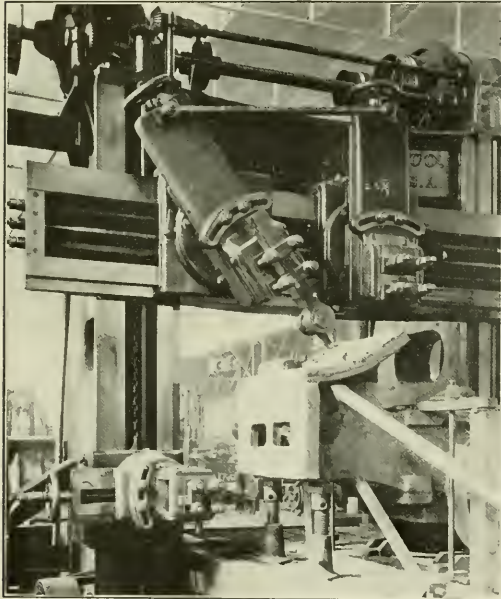

Fig. 6—Radius Attachment for Planing Cylinder Saddles.

with its tool in the arc of a circle. With the proper radius the saddle can be planed automatically, the right hand head being moved by the automatic cross feed. Where there is only one head, the other end of the radius arm may be fastened to a vertical upright, bolted to the face of the cross slide. In this case, however, the tool will have to be fed by hand. Fig. 5 shows the detail of the radius arm and its center bearing.

DRIVING WHEEL SHACKLE.

The shackle shown in Figs. 7 and 8 is used with an electric traveling crane for transferring mounted driving wheels from

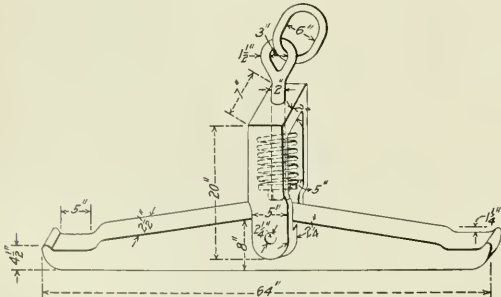

Fig. 7—Details of Driving Wheel Shackle.

one part of the shop to another, and for moving the wheels in and out of journal and tire turning lathes. The wheels always

hang level and are easily placed on the centers of the machine. The large coil spring in the yoke of the shackle relieves the strain on the lathe centers, should the crane operator lift too heavily with the cables when taking the wheels out of the machine. This method of carrying wheels eliminates the danger

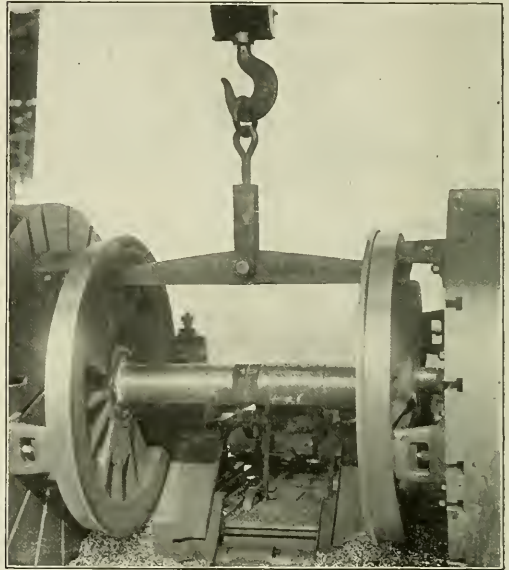

Fig. 8—Shackle for Lifting Driving Wheels.

of chains and hooks coming undone and breaking, which might injure the workmen.

HEAVY LATHE DOG.

The dog shown in Fig. 9 was made primarily for turning crank pins and driving axles. It grips the work at four points and has greater leverage for making this grip than the ordinary set screw dog. It consists of two angle plates, as shown,

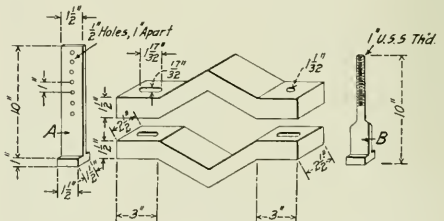

Fig. 9—Heavy Lathe Dog.

which are held on one side by the T-rod A, which has a series of 1/2-in. holes for a pin, to allow for adjustment. The other side is held by the T-bolt B, which is tightened by a 1-in. nut.

DRILL PRESS CHUCK.

A convenient chuck for a drill press, especially on locomotive work, is shown in Fig. 10. It consists of the base A, with a fixed jaw, and the sliding piece B with the movable jaw, which is operated by a lead screw. A drill press with one of these chucks will easily produce 50 per cent. more work than with the ordinary clamping methods, as no time is lost by the operator looking for bolts, clamps or blocks. There are very few

compressed air may be made use of throughout the shop. With these stands, considerable unnecessary handling of the pumps

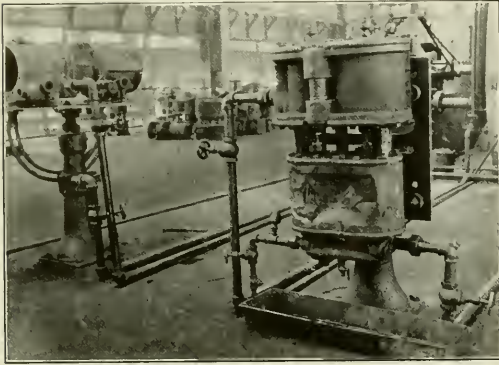

Fig. 13—Stands for Testing and Repairing Air Pumps.

is done away with, making the work of the repair man a great deal easier.

SMALL PNEUMATIC PRESS.

The small press shown in Fig. 14 was constructed for the purpose of pressing valve chamber bushings in air pump cylinder heads, thereby eliminating the loss of bushings due to break-



Fig. 14—Pneumatic Press for Bushing Work.

age caused by driving them in with a hammer. It is operated by two valves, one for the upper end of the cylinder and one for the lower end. When the upper one is open the pet cock on the under side should be open to allow for the exhaust of air from below the piston, and for the same reason the upper

pet cock should be open when air is admitted on the under side of the piston. This press may also be used for pressing in bushings on motion work, etc.

ECCENTRIC DRILLING JIG.

The jig shown in Figs. 15 and 16 is used on a radial drill for drilling eccentrics and eccentric straps. It is composed of an angle casting which is bolted to the table of the machine. This casting in turn supports a smaller angle clamping plate

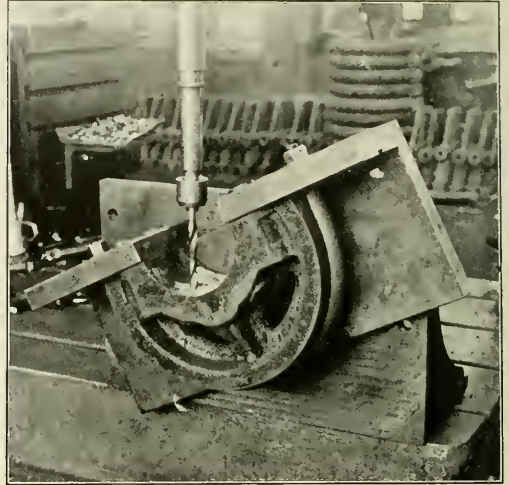

Fig. 15—Eccentric Drilling Jig.

by a pin, which allows the plate to be swung to any angle. The eccentric is fastened to the under side of the angle by a semi-circular yoke which is threaded on the ends and held

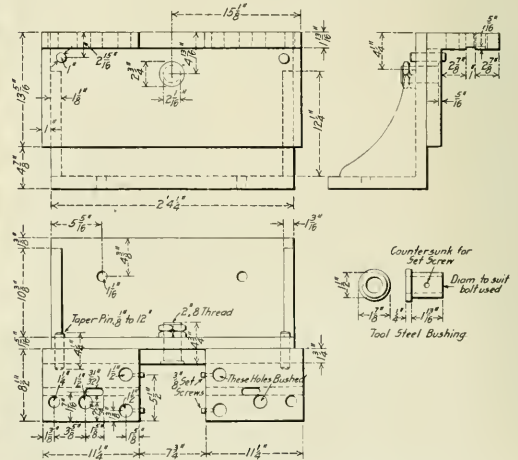

Fig. 16—Details of Eccentric Drilling Jig.

in the plate by two nuts. As will be seen in Fig. 16, the under side of the angle has a slot by which the eccentric may be centered. With this device the set screw holes may be drilled and tapped. When drilling for the stud bolt holes, the angle plate is swung around to a horizontal position and is held there

by two taper pins extending through the plate and the casting. Eccentric straps are drilled on the same jig in a similar manner.

LATHE CHUCK CRANE.

A small crane that may be attached to the back of an engine lathe bed convenient to the spindle is shown in Fig. 17.



Fig. 17—Crane for Removing Heavy Lathe Chucks.

It is used for taking off and putting on heavy chucks, making it possible for one man to handle the chuck easily. The crane post is 2½ in. in diameter and 6 ft. high, the lower end resting

in a box imbedded in the concrete foundation of the machine. It is supported by a bearing which is fastened to the bed of the lathe by means of cap screws. The arm, or runway, is made of two pieces of 1½-in x 2½-in. iron, bolted to the top of the post with sufficient space between them to allow for a four-wheel trolley. The carriage of this trolley contains a screw hoist on the end of which is a yoke to which the chucks are fastened. When the chuck is not in use on the lathe, it is held suspended out of the way of dirt and injury from passing trucks by this yoke.

CLAMPS FOR CROSSHEAD.

The device shown in Fig. 18 is used for clamping a crosshead to a planer while the guide faces are being planed; in

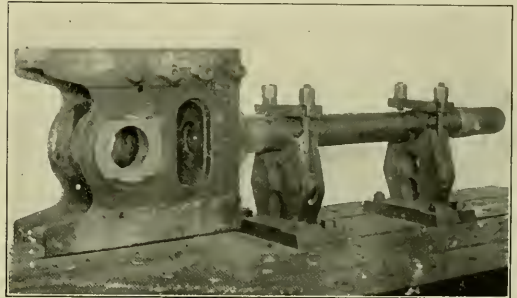

Fig. 18—Clamps Used for Planing Crossheads.

this way the faces will be parallel to the piston rod. A series of mandrels having the various piston rod fits are kept in a metal rack so that it is unnecessary to have each crosshead fitted with its own piston rod for planing.

RADIUS ATTACHMENT FOR SLOTTING MACHINE.

The apparatus shown in Fig. 19 is used for slotting quadrants, links and other radius work. It consists of an arm which is rigidly fastened to the bed of the slotter. The sliding

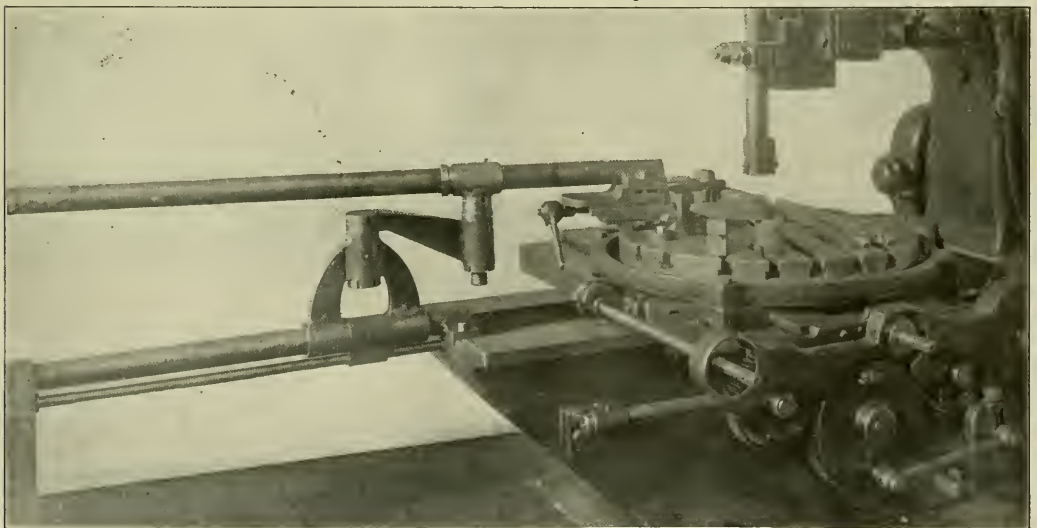

Fig. 19—Radius Attachment for Slotting Quadrants, Links, etc.

head, or support for the radius arm, is moved by an adjusting screw underneath the bar which is held at the front of the slotter bed. The bar is graduated in half inches, and when being set to any required radius, the sliding head is moved back to the nearest graduation to give the required radius. The exact radius is then found by means of a tram, one point of which is placed in the center of the sliding head and the other at the work. The exact distance and adjustments are made by a smaller adjustment screw at the end of the radius bar. When using this attachment, the screw to the lower table of the machine is disconnected, allowing the table to be guided by the radius arm.

SAFETY VALVE TESTER.

The arrangement shown in Fig. 20 was devised to quickly test safety valves and thus save time over the old method of waiting until the boiler had developed sufficient pressure to do

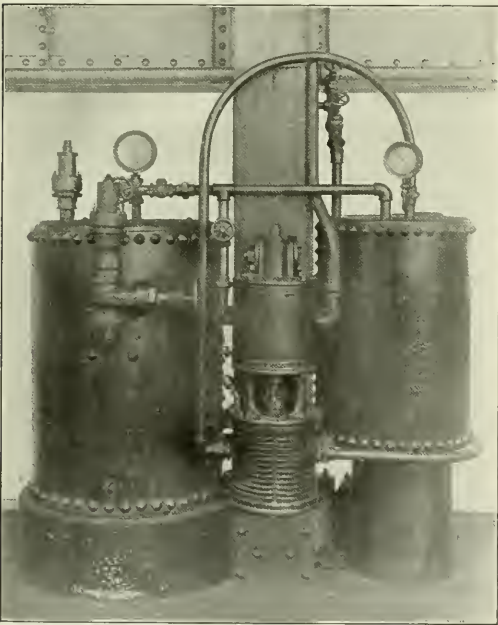

Fig. 20—Air Tanks for Testing Safety Valves.

the work. The reservoir on the right is connected to the shop air line and is always charged to a pressure of about 90 lbs. The left-hand reservoir is also connected to the shop line and after being charged the connection is closed and a connection is opened to the air pump which raises the pressure to that desired for testing. The safety valve is connected to this reservoir through the gate valve that is directly in front of it. The connection is made by nipples so that various sizes of safety valves may be tested. The safety valves are set from 3 to 5 lbs. higher than the required engine rating, according to the size of the valve and to whether it is set at a high or low pressure.

TIRE GAGE.

A convenient and light weight tire thickness gage is shown in Fig. 21. It is made of 1/16-in. sheet steel and has a scale marked on it which is divided into sixteenths of an inch. Being light and small, it is easily carried around in a pocket, where one will always have it handy. The illustration shows the method in which the gage is used.

METAL TOOL CABINETS.

A tool cabinet that is made of cast iron angles and sheet iron is shown in Fig. 22. The supports are 2 in. x 2 in. x 12 in.,

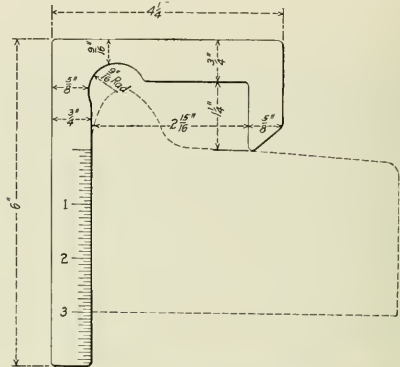

Fig. 21—Tire Thickness Gage.

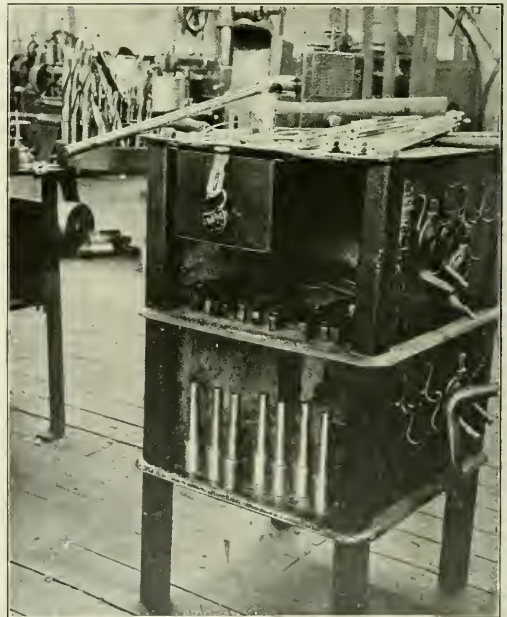

Fig. 22—Metal Tool Cabinet.

and are made hollow to reduce the weight, having recesses cast in one end for receiving the bolt head and bottom supports.

ZINC PRODUCTION.—The production of zinc in Europe during 1912 was 650,670 tons, which is 27,750 tons more than the production of 1911.

RAPID TRAVELING.—From New York to Burlington, Vt., a distance of about 300 miles, which thirty years since was a ten days' journey, may now be performed with great ease (if the steamboat were to leave Whitehall at 5 p. m.) in thirty hours.—From the *American Railroad Journal*, October 6, 1832.

CAR DEPARTMENT

MAKING STOCK CARS FROM SCRAPPED BOX CARS

BY WM. QUEENAN,

Assistant Shop Superintendent, Chicago, Burlington & Quincy, Aurora, Ill.

Some years ago the Burlington appointed a committee to inspect and report on the general condition of a lot of old low capacity freight cars. The committee made a careful inspection of a great many of the different classes of these cars and recommended that a maximum limit of expenditure be placed on them, the age and class of car to determine the amount of money to be spent. The recommendation was approved and affected cars of from 18 to 23 years of age. When one of these cars comes on the repair tracks, it is carefully checked over, and if it is found that it will cost more money to put it in condition to give service for at least three years, barring accident, than the limit allows, the car is stenciled "condemned." A blank form is then filled out, showing in detail all the repairs necessary to put it in good condition and the estimated cost. This form is sent to the general officers. If the recommendation is approved the car is destroyed.

The practice of destroying cars is very interesting. If carefully followed up, an immense amount of good, usable material can be recovered and used on other cars of a like capacity. After we had been destroying cars in this manner for some time we accumulated a very large amount of good material that we had no use for—we were getting more than we needed to make repairs to the same class of equipment. A large number of the cars destroyed in the last two years were of 60,000 lbs. capacity, and they had very good trucks of the arch bar type, and metal bolsters. With this and other material it was found that we could build a stock car of 60,000 lbs. capacity and use up this material, which would be putting it to much better use than selling it for scrap.

The stock car decided upon is of the following dimensions:

Length over end sills.....	36 ft. 11 in.
Width over side sills.....	8 ft. 9½ in.
Width over end sills.....	9 ft. 8 in.
Width over roof.....	9 ft. 9¼ in.
Height from top of rail to top of running board.....	12 ft. 5 11/16 in.
Height from top of rail to top of brake shaft.....	13 ft. 8¼ in.
Length inside.....	36 ft. 1½ in.
Width inside.....	8 ft. 6½ in.
Height inside.....	7 ft. 4½ in.

The framing of the car is what is known as outside framing, the post pockets being bolted into the side sills in the same way as on a coal car, but having a flange resting on top of the side sill. The side sills and the intermediate sills are 5-in. x 9-in. fir. The center sills consist of two 9-in. 25-lb. channels. The draft arms are flanged plates 5/16 in. in thickness. The cars are fitted with metal brake beams, tandem spring draft gear, and what are known as 13-B trucks. The total weight of the car is 30,500 lbs. The wooden sills and the flooring are treated with creosote.

From such material we have built 1,275 new stock cars. The first 250 were double deck sheep cars; the balance were single deck 60,000-lb. capacity cars, with steel center sills. We are now working on an order on which we have 175 more cars to build. We have another order, on which we have not commenced work, for 100 double deck sheep cars. These cars are equal to any low capacity stock car being built, either at railroad shops or at contract shops, notwithstanding the fact that a large portion of the material that goes into their construction was

released from destroyed cars and recovered from the scrap yard. The average cost for labor on all the above-mentioned cars is 14 per cent. of the total value, making the material value 86 per cent. of the total. Forty-six per cent. of the material was recovered from destroyed cars and the scrap yard.

The following is a list of the principal material that was released from destroyed cars and used on these cars. All material used we considered equally as good as new:

- Top and bottom arch bars and tie straps.
- Metal truck bolsters.
- Metal spring planks.
- Springs, nested.
- Column guides.
- Journal boxes.
- Journal box wedges.
- Axles, with journals 4¼ in. x 8 in.
- Air brake equipment complete.
- MCB couplers, including the yokes, followers, springs, and follower guide straps.
- Draft castings suitable for tandem spring.
- End door staples, brackets and B back stops.
- Side door Climax hangers, and Z-bar door tracks.
- Brake shaft roof brackets.
- Truss rod washers.
- Door handles.
- Needle beam truss rod struts.
- Truss rod turnbuckles.
- Body bolster truss rod struts.
- Body bolsters.
- Truss rods.

The wheels and the journal brasses were bought new, as we do not get any surplus of wheels that we cannot use in repairs.

The journal box bolts and column bolts are made of old bolts pieced out by welding to the required length. The box bolts are 1½ in. in diameter, the column bolts 1¼ in. The bolt to be welded is first cut a suitable length, one piece having a head and the other being a straight piece of iron. The ends to be welded are then upset on a forging machine, the upset being ¾ in. larger than the original diameter of the bolt. They are then moved to a Bradley hammer and welded. We have made several laboratory tests of the strength, which proved very satisfactory. A large number of the bolts have been in service for over two years and we have had no complaints. We are welding bolts from ¾ in. to 1½ in. diameter and are saving at least 35 per cent. by doing so.

The body bolster top member is ¾-in. x 8-in. iron, and the bottom member 1-in. x 8-in. iron. By working over old body bolsters the cost is only about one-half of what it would be if made of new iron, and the old bolsters are as good and answer the purpose. The same is true of the truss rods. The truss rods from old cars are too short, as they were originally used on 34-ft. cars. We cut up the old rods to suitable lengths and piece them out by welding. The truss rods made of old rods cost about 30 per cent. of what they would of new iron. The cars are equipped with four truss rods, 1¾ in. in diameter, with the ends upset to 1¼ in. All the forgings, including the brake rods and brake levers, used on the new stock cars are recovered from destroyed cars. All the vertical tie rods used in the construction of the new stock cars are of new iron. We also recover about \$25 worth of good, usable lumber from the old box cars, and while none of this lumber goes into the construction of the stock cars, we are making good use of it on other cars. One item is parts of good 5-in. x 9-in. car sills, which are long enough to make sill splices. Parts of this lumber that are not defective are well seasoned and are just as good as new. Last year we recovered over 2,300 pieces of timber about 12 ft. in length for making sill splices.

DEVELOPING EFFICIENT CAR INSPECTORS*

BY C. J. WYMER,

General Car Foreman, Chicago & Western Indiana.

Car inspectors may be classified as terminal and interchange inspectors. Their duties in many respects are the same, and in others so different that an inspector thoroughly capable on terminal work might prove very incapable on interchange work. The most important duty of a terminal inspector is to discover defects in equipment and be qualified to pass judgment as to whether the defects are of such a nature as to make the movement of the equipment hazardous to life and property. Ideal interchange inspectors must possess all the qualifications of a terminal inspector, as well as additional qualifications, and are the most difficult to obtain.

An inspector must be a careful workman and should possess a practical knowledge of car construction. He must interchange cars and place responsibility according to M. C. B. rules and other regulations. He must have definite knowledge of both state and federal safety appliance laws and their regulations relative to handling explosives and inflammable material. He must determine if the lading is properly loaded and protected, and in some instances record seal records. He must avoid excessive delays to traffic due to inspection or be a subject to criticism. Accuracy and activity meet this requirement. He must perform long hours of toil, endure the inclemencies of weather and be regular in service. To do this, he must be of good physique and of exemplary habits. He must record and transmit intelligently to his superiors his various performance of duties. This requires a good average education. He must be of strong moral character. Thousands of lives and millions of dollars in property are daily entrusted to his judgment and he must not meet such responsibilities with a clouded brain through dissipation and irregular habits.

The ideal car inspector must, therefore, be a mechanic, a student, a scholar and a gentleman. After having reached this conclusion, our minds are instinctively turned to our shops from which source our supply should naturally come; they are rapidly filling up with employees who can neither speak nor write English. However, we do not regard the process of development so difficult; the real problem is the acquiring of suitable material to develop.

In indicating that our shops are filling up with a class of labor which cannot be developed into successful car inspectors, we do not mean to convey the impression that they make incompetent car men, for in fact many of them become very proficient in their work, but the fact remains that comparatively few can be developed into efficient car inspectors and, therefore, the effect is harmful so far as it affects the subject under discussion.

What cause has produced this effect and how can it be replaced with one producing the desired effect? The progress of the country has been so rapid during the past few years, that many positions have been created free from physical exertion and endurance which seem to have proved more attractive to a large percentage of young men than the shop. They have chosen to accept these even at a financial sacrifice on account of the future opportunities offered, or a desire to be free from physical exertion.

The other class who look upon toil as honorable and constructive to both body and brain have opportunities offering them greater financial returns and frequently with less responsibility and they naturally accept them. What the car department most needs is to secure the recognition it deserves among other branches of railroad service. It needs to be understood that just anything is not good enough for the car department, but that it is an important department and its efficiency very largely affects the earning capacity of the railroad. When this is understood

and the car department has been given a setting in the railroad organization equal to its share of responsibility, there will be no scarcity of suitable material to develop.

There is a decided waste of talent and labor due to rules and regulations which require duplication of work without any corresponding return. Car inspectors were originally created to inspect cars for safety of life and property, but their work has so degenerated into a system of bookkeeping, that it actually causes neglect of their real duty. We mean the system of one inspector after another recording the same defects and taking copies of the same defect cards until the operation has been repeated many times without repairs being made, while as a matter of fact more important defects are neglected. If the practice of carding cars were abolished in its entirety, there would be a decided reduction of car inspectors required, a great conservation of labor and better inspection would be insured for really dangerous defects. It would seem that no thoughtful person can fail to see this waste and should be ready to co-operate in arranging regulations, having equitable results without carrying with it what may be termed a willful waste.

A good car inspector should have a practical knowledge of car construction so as to reinforce his judgment as to the need of repairs to certain defects. This knowledge can best be obtained in actual shop experience, yet we have known of very capable car inspectors being developed through yard work, such as light repairman, oiler or inspector's helper.

Interested yard men when associated with inspectors possessing a definite knowledge of their work, develop into efficient car inspectors quite rapidly, but unless so associated their progress is much slower and their success less certain.

He must be a student, for there are many regulations to master and these are undergoing constant change and he must keep himself fully informed as to changes. He must be kept supplied with current literature affecting his work and must be encouraged in its study. He must interpret rules, regulations and laws which are capable of various interpretations by men of high education, and he must be proficient in making records and handling correspondence.

SUMMARY.

Do what you can to get the car department on an equal footing with other departments of no greater importance. When this can be accomplished as a general proposition, there will be plenty of available material.

Be careful in the selection of men and select only such men as are capable of developing the qualifications we have suggested.

Provide your inspector, and those you seek to develop, with all current literature affecting their work.

Arrange occasional meetings for the exchange of opinions and the imparting of instructions, and do your part in educating your men to be honest, industrious and of good habits. Show them that you can appreciate honest effort as much as you can censure neglect of duty.

TRAFFIC THROUGH CANADIAN CANALS.—The traffic passing through the canals of the Dominion of Canada in the year 1912 was 47,587,245 tons, an increase of 9,556,892 tons over 1911.

SHIP BUILDING IN SCOTLAND.—The total output of the Scotch ship yards for the month of May, last, was 62,006 tons, of which 56,836 tons, comprising 37 vessels, was produced on the Clyde.

THE HIGHEST SMOKE STACK.—The smoke stack at the smelter of the Boston & Montana Consolidated Copper & Silver Mining Company, Great Falls, Mont., which is 506 ft. high, is said to be the tallest in the world.

ONE HUNDRETH ANNIVERSARY OF THE LOCOMOTIVE.—In June, 1813, 100 years ago, the first practical locomotive propelled by steam power was produced by William Hedley and Timothy Hackworth. This locomotive, which was for use on a colliery railroad, was named the "Puffing Billy," and is still to be seen in the South Kensington Museum.

*Abstract of a paper presented before the Car Foremen's Association of Chicago at the May meeting.

METHOD OF DESIGNING A STEEL GONDOLA CAR

Awarded the Second Prize in the Car Department Competition Which Closed February 15.

BY L. W. WALLACE,
Assistant Professor Car and Locomotive Design, Purdue University.

The purpose of this article is to show the method of designing those parts of a steel gondola freight car that are usually given theoretical consideration. These will include the axle, the truck bolster, the truck side frame and the steel underframe consisting of the body bolster, the center sills and the side sills.

Before beginning the design, it is necessary to make certain assumptions as to the capacity and weight of the car, and also as to its general dimensions. We shall assume the capacity to be 100,000 lbs.; light weight, 40,000 lbs.; general dimensions, inside length, 42 ft.; inside width, 9 ft. 6 in.; distance between truck centers, 32 ft.

AXLE DESIGN.

The axle will be designed by the graphical method authorized by the M. C. B. Association and published in the proceedings for 1856. The loading on each axle embraces the loads on the two journals, and is determined as follows:

Weight of car body and trucks.....	40,000 lbs.
Capacity of car plus 10 per cent. overload.....	110,000 lbs.
Total.....	150,000 lbs.
Add 20 per cent. for oscillation.....	30,000 lbs.
Total.....	180,000 lbs.
Deduct weight of wheels and axles.....	9,000 lbs.
Weight on all axles.....	171,000 lbs.
Weight on each axle.....	42,750 lbs.
Weight on each journal.....	21,375 lbs.
	21,400 lbs. used

In designing the journal of the axle, the load may be assumed to be at the center of the journal, but in designing the remainder of the axle allowance is made for the wear of the parts, which permits the brass to move towards the end of the journal, applying the load beyond the center. The amount of this movement is estimated as follows:

Wear on bearing.....	$\frac{3}{4}$ in.
Wear on flange of axle.....	$\frac{3}{4}$ in.
Play between brass and bearing.....	$\frac{1}{8}$ in.
Total.....	1 $\frac{1}{8}$ in.

Taking this outward movement into account, the distance between the two forces P_1 and P_2 for the 100,000 lb. car would be 6 ft. 5 in. + $(2 \times 1 \frac{1}{8}$ in.) = 6 ft. 7 $\frac{3}{4}$ in. as shown on Fig. 1. The track gage and center of the axle were located according to standard dimensions as shown.

The center of gravity of the car was then assumed to be 72 in above the rails. This, of course, is not presumed to be the center of gravity of all cars, but it is thought to be the maximum height attainable for any car with any class of loading. With the relative location of the rails, center of axle and center of gravity of the car established, the graphical determination of the stresses in the axle becomes the next step. Accordingly there was laid off to a scale of 20,000 lbs. to the inch, the weight W of 42,750 lbs., which is the load on each axle. The horizontal component due to curves, wind, etc., was laid off as H , which is usually considered as $.11W$. Complete the parallelogram with the center of gravity as one corner and the two forces, H and W forming two sides. The resultant R is drawn, letting it strike the rail where it will, cutting the axle AB at Q . With a load line $1-2$ equal to W , divide the former so that $1-3 : 3-2 :: AQ : QB$, which in this particular case is $1-3 : 3-2 :: 16.87$ in. : 61.87 in., making $1-3$ equal to 2.12 in. Take the pole distance, h , out from 3 any convenient distance, as $1 \frac{1}{2}$ in., and complete the triangle 102 .

low the axle was constructed by drawing $a-d$ parallel to $o-2$ and $d-o$ parallel to $o-1$. The moment diagram now being completed the moment at any point in the axle may be obtained by multiplying the ordinate at the corresponding point in the moment diagram by the pole distance h , each being taken at its proper scale. The ordinate cd scales 380,000 lbs., which multiplied by $1 \frac{1}{2}$ in., the pole distance h , gives a moment of 570,000 inch pounds. In like manner the moments at ef and gh were found to be 483,750 and 386,250 inch pounds, respectively. To find the required diameter, use the formula $M = fZ$, in which

M = the bending moment in inch pounds.

f = the allowable fibre stress, which is generally taken as 22,000 lbs. for all of the axle, except the journals which are figured for 10,000 lbs.

$$Z = \text{section modulus} = \frac{\pi d^3}{32}, \text{ for a round section.}$$

$$\text{Therefore } M = \frac{32}{\pi d^3} \times 22,000 \times \pi d^3 = 2,160.4 d^3$$

By substituting in the above formula the bending moment of 570,000 in. lbs., which occurs at CD , and solving

$$d^3 = 264, \text{ or } d = 6.41 \text{ in., } 6 \frac{1}{2} \text{ in. was used.}$$

In like manner the diameter at EF and GH was found.

The axle back of the wheel fit was accordingly drawn to conform to the diameters obtained by the graphical method just

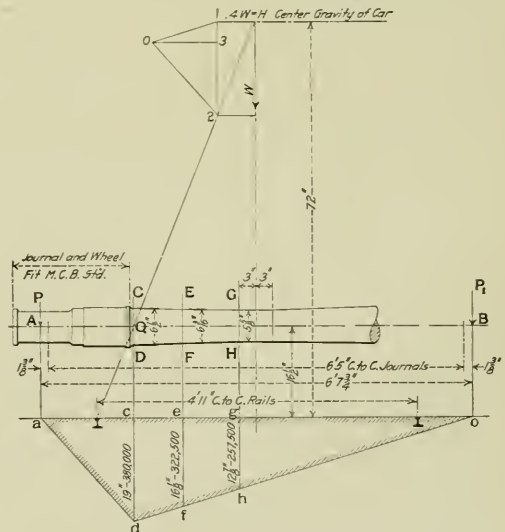

Fig. 1—Graphical Method of Designing an Axle for a 50-Ton Gondola Car.

described. The drawing shows the moment diagram for only one journal, but since the loading is symmetrical, both ends of the axle from the center out would be the same, hence it is not necessary to show the diagram for the right journal. The axle drawing was completed by making the wheel fit and journal conform to M. C. B. standard dimensions.

TRUCK BOLSTER.

The weight carried by each bolster was obtained in the fol-

lowing manner: The total weight of the car, loading and over-load was found to be 180,000 lbs.; from this deduct 10,800 lbs., the estimated weight of the wheels, axles and side frames, which leaves 169,200 lbs., the load to be carried by the two bolsters. Therefore the load on each bolster is 84,600 lbs., or approximately 85,000 lbs.

In designing a truck bolster, two different loadings must be considered. One is the direct vertical load just found, and the other a transverse load received when the car is stopped by brakes, or otherwise. The amount of this transverse load is variously estimated. It is thought that the maximum amount will be equivalent to the force required to slip the wheels of the truck with the brakes applied, which amount will be the weight on the wheels multiplied by .22, the coefficient of friction between wheels and rails. For the car under consideration, this gives 85,000 × .22, or approximately 19,000 lbs.

The vertical loading may be applied in two ways. First, all of it may be at the center of the bolster, which of course would be the normal condition when the car is on a level track. Second, one-half of the load may be assumed to be at the center, and the other half on one side bearing, which occurs when the car is rounding curves or on an uneven track. The bolster should, therefore, be designed to take care of both of these conditions

moment obtained at each point and for which the section was designed was as follows:

At side bearing (Sec. A—A).....	474,200 in. lbs.
At B ₁	541,300 in. lbs.
At C.....	786,200 in. lbs.
At D.....	892,500 in. lbs.
At E.....	1,190,000 in. lbs.
At F.....	1,445,000 in. lbs.
At G.....	1,615,000 in. lbs.

Using the common formula $M = fZ$, in which
 M = bending moment,
 f = safe fibre stress, which is 10,000 lbs. for cast steel, of which the bolster is to be made,
 Z = section modulus.

From the above $Z = M/f$. Therefore the required section modulus at any point, as A , may be found by substituting the proper values, as follows: $Z_A = 474,000 \div 10,000 = 47.4$. In which manner the other required Z 's were found to be

$Z_A = 47.4$	$Z_D = 89.2$	
$Z_B = 54.1$	$Z_E = 119.0$	$Z_G = 161.5$
$Z_C = 78.6$	$Z_F = 144.0$	

These values were plotted as shown in Fig. 2, and the resulting curve marked M/f curve.

Having found the required section modulus for each section, as above outlined, the next step is to design a section to satisfy the required section modulus or Z at each point. As an illustration of how this is done two sections as $G—G$, and $A—A$ will be worked out. The required section modulus Z at the center, and which is for section $G—G$, may be expressed by the following formula

$$Z_{G-G} = \frac{M}{f} = \frac{1,615,000}{10,000} = 161.5.$$

Assume a section as shown at the lower part of Fig. 2. This is composed of rectangles; therefore, the section modulus of the entire section may be easily obtained. An inspection of one-half of this section about the vertical axis shows that it is composed of seven small rectangles, designated as a, b, c, etc. In order to find the section modulus Z of the entire section, it becomes necessary to find the center of gravity of the section. This may be expressed by the following formula:

$$C. G. = \frac{a_1 x_1 + a_2 x_2 + a_3 x_3}{A}$$

in which a_1, a_2 , etc., is the area of each separate divisional unit and x_1, x_2 , etc., is the distance from the center of gravity of each divisional unit to some arbitrary reference line taken as $X—Y$. A = the sum of all the small areas, or the total area of that portion of the section considered. Substituting the values,

$$C. G. = \frac{(4.26 \times 12.12) + (14.06 \times 6\frac{1}{2})}{26.45} = 6.89 \text{ in.}$$

That is, the center of gravity of the section is 6.89 in. above the reference line $X—Y$.

The moment of inertia for the entire section may be expressed as

$$I = (I_a + A_1 R_1^2) + (I_b + A_2 R_2^2), \text{ etc.}$$

In which I_a, I_b , etc., equal the moments of inertia of each small section about its own gravity axis and for a rectangular section

is equal to $\frac{bh^3}{12}$. In which b is the thickness in inches and h

the height in inches. a_1, a_2 , etc., equals the area of each unit, R_1, R_2 , etc., the distance from the center of gravity of each divisional unit to the center of gravity of the entire section.

Since the value of $\frac{bh^3}{12}$ for each of the divisional units is very small, it will be dropped for all of the subdivisions except b , wherein it has material value, but in this subdivision the AR^2 becomes insignificant, hence will be dropped. Then the equation for I becomes

$$A_1 R_1^2 + \frac{bh^3}{12} + A_2 R_2^2, \text{ etc.}$$

Substituting the correct values

$$I = (4.26 \times 5.67^2) + \frac{.625 \times 11.25^3}{12} + \text{etc.} = 632.17$$

$Z = \frac{I}{C}$, in which C = distance from outermost fiber to center

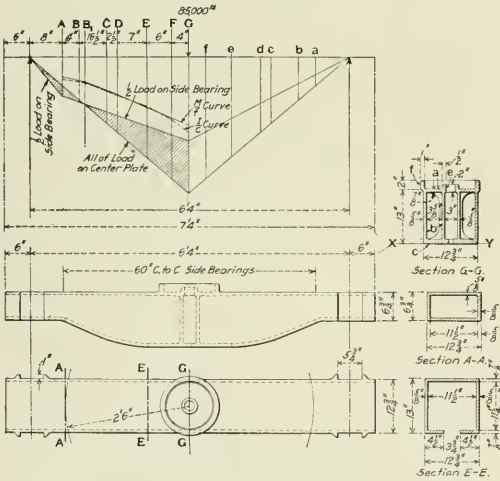

Fig. 2—Graphical Method of Designing a Truck Bolster.

of loading. In accordance with this, there have been drawn two moment diagrams on Fig. 2. One represents the bending moment that comes on the bolster when all the load is carried at the center and the other shows the moment diagram when one-half of the load is on the side bearing, and the other half on the center plate. From the diagram it is obvious that from the point of the support to B_1 , which is approximately 6 in. from the side bearing, the greatest moment occurs when one-half of the load is carried at the side bearing, and that from B_1 to the center, the maximum moment is produced when all the load is at the center. Therefore from B_1 to the center, the bolster should be designed for the latter loading and from B_1 out to the end of the bolster, the moment due to the loading at the side bearing should be considered.

The moment diagrams were constructed by finding the value of the moments at the several points indicated. The bolster is considered as a simple beam supported at each end and having, first a concentrated load at the center, and second one concentrated load at the center and one at the side bearing. The maxi-

of gravity of the section, which as found above is 6.89 in. Therefore $Z = 632.17 \div 6.89 = 91$. But since only one-half of the section $G-G$ was taken for convenience of calculation, the total $Z = 91 \times 2 = 182$, which compared with the required Z of 161.5, shows the section to be amply large, but not too large, as the actual fiber stress would then be only 8,873 lbs., which is not too small for steel castings.

The required section modulus for all other sections between $G-G$ and $A-A$ may be calculated in the same manner as was that for section $G-G$. But a much easier and shorter method may be used for section $H-H$, as it is a hollow rectangle and there has been devised a universal expression for the section modulus of a hollow rectangle, which is

$$Z = \frac{bh^3 - b_1h_1^3}{6h}$$

In which b = outside width, h = outside height, b_1 = inside width, h_1 = inside height. Substituting the values assumed for section $H-H$,

$$Z = \frac{12.75 \times 6.75^3 - 11.5 \times 5.5^3}{6 \times 6.75} = 52.0$$

which is slightly larger than 47.4 the required amount. By the methods above described, the sections at A, B, C, D , etc., were found and the bolster drawn to conform to those sections as shown in Fig. 2.

In making an actual working drawing such fillets and beads as it is deemed necessary to have for good foundry practice should be added, which would only increase the strength of the bolster to that extent, but not to a sufficient amount to justify

complicating the calculations by considering them. The $\frac{M}{f}$ as found for each section was plotted as shown in Fig. 2. It is evident from the relative position of the $\frac{M}{f}$ curve and the $\frac{W}{A}$ curve that the bolster as designed fully meets the requirements for strength.

The bolster must be investigated for one other force, however, and that is for the transverse load of 19,000 lbs., which is assumed to be taken by the top section of the bolster. The bolster will be considered as a simple beam with a concentrated load of 19,000 lbs. applied at the center. The maximum moment will occur at the center and is expressed thus, $M = \frac{WL}{4}$, in which $W = 19,000$ and $L = 76$ in., and $M = 361,000$.

Using a fiber stress of 12,000 lbs., the required $Z = 30$. The section modulus of the top section of the bolster just to one side of the king pin hole is 28.6, which is slightly smaller than required, but the extra metal due to the center plate and flanges will more than compensate for this, so the bolster is deemed entirely strong enough for the transverse load.

The bolster having thus been designed, to meet the requirements put upon it by the loads mentioned, all that now remains to be done is to put on the center plate, side bearings, etc., as needed, so as to conform to good practice, as shown on the drawing.

TRUCK SIDE FRAME.

The cast steel side frame was designed to carry one-half the load on the bolster, which amount was 42,500 lbs. This load is transmitted to the side frames through the bolster springs. The side frame was considered as a truss receiving the load at the two columns.

An assumed side frame, as shown in Fig. 3, was drawn and the centers of gravity of its several sections were found. Through the centers of gravity of the sections, lines $r-s$, $O-p$ and $m-n$ were drawn, thus giving the theoretical outline of the side frame. The truss diagram was then constructed by drawing lines AF, GF, BF , etc., parallel to op ,

rs , and mn respectively, thus forming the closed truss diagram as shown. The arrow heads indicate the character of the stress in each member of the truss.

In constructing the stress diagram, it was assumed that each support would at times take two-thirds of the load on the side frame due to disarrangement of the bolster or the springs. For the side frame in question, this would amount to approximately 28,000 lbs., hence on ag and ad , 28,000 lbs. were laid off to a scale of 10,000 lbs. to the inch. Then gf was drawn parallel to $r-G$, aj to $A'1$, etc., thus completing the stress diagram. The stress in each member was then obtained by measuring the several lines in the stress diagram and making the proper deductions. The values thus found are shown in the

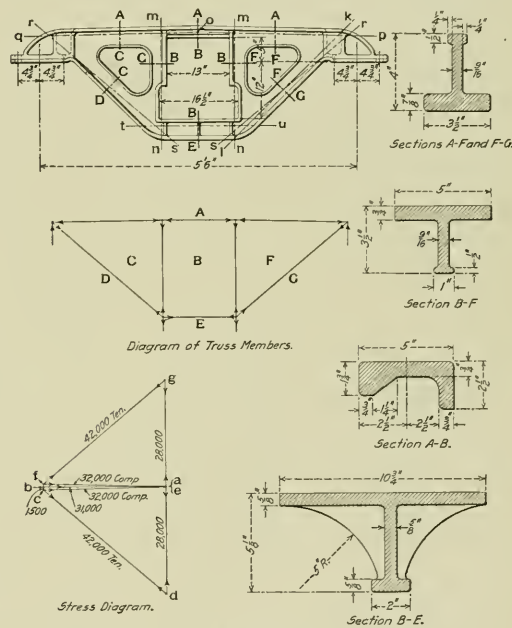

Fig. 3—Cast Steel Truck Side Frame and Graphical Method of Designing.

diagram. The sections were determined by making use of the formula: $W = f \cdot A$, in which

- W = the load in pounds on the members.
- f = fiber stress, which should not exceed 10,000 lbs.
- A = area of section in square inches.

Apply the above to section $A-B$. From stress diagram $W = 31,000$ lbs. $A = 6.31$ sq. in. from the assumed section shown in Fig. 3. Therefore,

$$f = \frac{W}{A} = \frac{31,000}{6.31} = 4,900$$

which indicates that the area of section AB is too large, which would be true, if the direct loading were all that came upon it, but the side frame gets a transverse load similar to the bolster and it is usually assumed that the top section will take this load, hence by the time this is considered, the section AB will not be too heavy. In like manner, sections AF, AC, CD and FG were found.

In designing sections BF and BC of the columns, an additional force other than the direct tensional force must be considered. In the bolster design, it was found that there was a transverse load of 19,000 lbs., one-half of which amount one column on each side of the truck will take. This load of 9,500 lbs. is assumed to be applied at the vertical center of the col-

umn, the column being considered as a free beam with a concentrated load at the center. Use the bending moment formula,

$$M = \frac{WL}{8}, \text{ in which } W = 9,500 \text{ lbs.}$$

$$L = 16 \text{ in., the distance between supports.}$$

Substituting and solving, a moment of 19,000 lbs. is obtained. By use of the formula $M = fZ$, the desired section modulus was found to be 2.8, giving a fiber stress of 6,785 lbs. per square inch. Since the tensional stress obtained from the stress diagram is so small, it may be disregarded.

The member *BE* which forms a seat for the springs and receives the load directly from the springs must be designed as a beam. Some designers consider it a free beam, uniformly loaded; others, a fixed beam with two concentrated loads 5½ in. apart; but the writer has always designed it as a fixed beam with a uniform load. The member figured by the latter assumption gives a slightly larger section than the second method men-

makes a total fiber stress on the section of 9,477 inch pounds.

The value of the area of each section and the fiber stress imposed by the load on the side frame is given in the following table:

Section.....	AB	AF	AC	FG	BF	DE	BC	DC
Area	6.31	4.33	4.33	4.33	5.37	10.3	5.37	4.33
Fiber stress.	4,900	7,400	7,400	9,700	6,785	9,477	6,785	9,700

UNDERFRAME.

The underframe of an ordinary steel gondola car may be either of two general types, one having two side sills and a center sill, and the other having only a center sill, the load being transmitted thereto by heavy cross-carriers. As the majority of cars have both side and center sills, that type will be used in this design.

It will be assumed that the load will be uniformly distributed over the floor of the car. The uniformly distributed load for the 100,000 lb. car may be taken as follows: Light

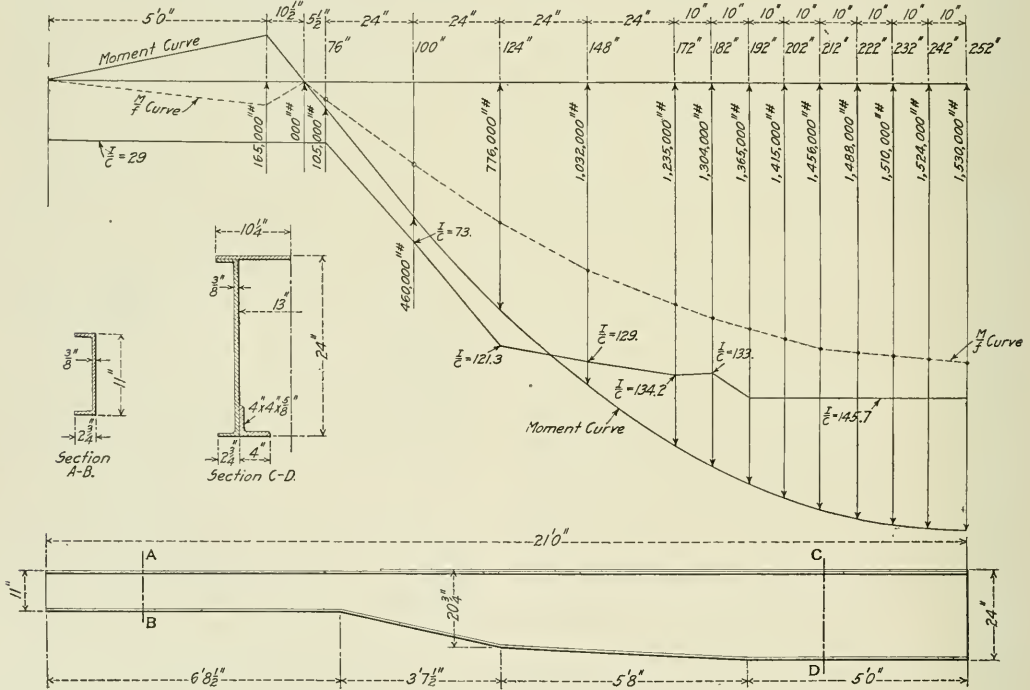

Fig. 4—Graphical Method of Designing a Center Sill for a 50-Ton Gondola Car.

tioned and somewhat smaller when figured by the first method. As a fixed beam uniformly loaded the moment

$$M = \frac{WL}{12}, \text{ in which } W = \text{the load in lbs.} = 42,500$$

$$L = \text{length of span in inches} = 16 \text{ in.}$$

Substituting and solving, a moment of 57,000 in. lbs. is obtained.

The modulus of the section was found to be 8.8. This was obtained in the same manner as was the section modulus for the bolster, so no explanation is necessary here.

Substituting the values for *M* and *Z* in the formula $M = fZ$, and solving for *f*, it was found to be 6,477. In addition to the stress due to the bending moment, this member has a tensional force of 31,000 lbs. acting upon it, as obtained from the stress diagram. This tensional force divided by the area of the section 10.3 in., gives a fiber stress of 3,000 inch pounds, which when added to the fiber stress due to the bending moment

weight of car body without trucks, 28,000 lbs.; 100,000 lbs. the rated capacity plus 10 per cent. for overloading gives a total of 110,000 lbs. For the car body and the loading there is 138,000 lbs., to which add 20 per cent. for oscillation, making the total uniformly distributed load 165,600 lbs. This divided by the square inches of floor space (the floor being 9½ ft. x 42 ft.) gives 2.88 lbs. per square inch of floor space. Each side sill will support one-half the floor width between it and the adjacent member of the center sill, which for the car in question is 25¼ in. Each member of the center sill will also support 25¼ in. width of floor space plus one-half of that between the two members, which is 6½ in. The width of floor space carried by each member of the center sill is therefore 31¾ in.

Center Sill.—The center sill must be designed to provide for two different stresses, that due to the uniformly distributed

load and that due to buffing, which will be taken as 200,000 lbs. The stress in the sill due to buffing is $\frac{B}{A}$, where B is the buffing force, and A is the area of the section. The stress due to the bending moment is $\frac{M}{Z}$, where M is the bending moment and Z the section modulus. Then if from 12,000 lbs. to 15,000 lbs. be taken as the minimum and maximum allowable fiber stress $\frac{B}{A} + \frac{M}{Z}$ must come within these limits. The proper section can then be determined by trial.

By using the following two formulae, the bending moments at the several points indicated on the stress diagram, Fig. 4, were determined. The moment at the bolster is expressed thus:

$$M_b = \frac{WL^2}{2}, \text{ where } W = \text{load per lineal inch on the member.}$$

$$L = \text{distance from the end of the beam to the point of support at the bolster, which is 60 in.}$$

The moment at any point between the supports is expressed thus,

$$M_x = R(x-b) - \frac{WX^2}{2}, \text{ in which } M_x = \text{the moment at any point, } X.$$

R = the reaction in pounds.
 X = Distance in inches from the end of the beam to the point under consideration.
 L = Distance from end of the beam to the point of support.
 W = Load per lineal inch of the beam.

Since there are 2.88 lbs. per square inch of floor area, and

The moment at any point as:

$$M_{222} = R(x-b) - \frac{WX^2}{2}$$

Since the beam is symmetrically loaded, the reactions at the points of support are equal, and equal to one-half the total load on the member, or 23,184 lbs. All of the factors in the above formula being known, the moment becomes

$$M_{222} = 23,184(232 - 60) - \frac{92 \times 232^2}{2} = 1,510,244$$

In this manner all of the moments shown on the diagram, Fig. 4, were obtained.

Using a fiber stress of 12,000 lbs. per square inch, the required section modulus for each point was obtained and the result plotted as the $\frac{M}{f}$ curve.

A section, as C—D, Fig. 4, was assumed and its center of gravity and section modulus determined in the same manner as was the center of gravity and section modulus of the various sections of the truck bolster, which was fully explained. As the principles involved here are identical with those of the bolster, no detailed explanation is necessary. In order to show the application of the formula $\frac{B}{A} + \frac{M}{Z} = f$, one set of calculations is

here shown. Take a section 148 in. from the end of the sill having a bending moment of 1,032,000 inch pounds. This section is identical in make up to section C—D on Fig. 4, with the exception that the height had to be only 22 in., since the mo-

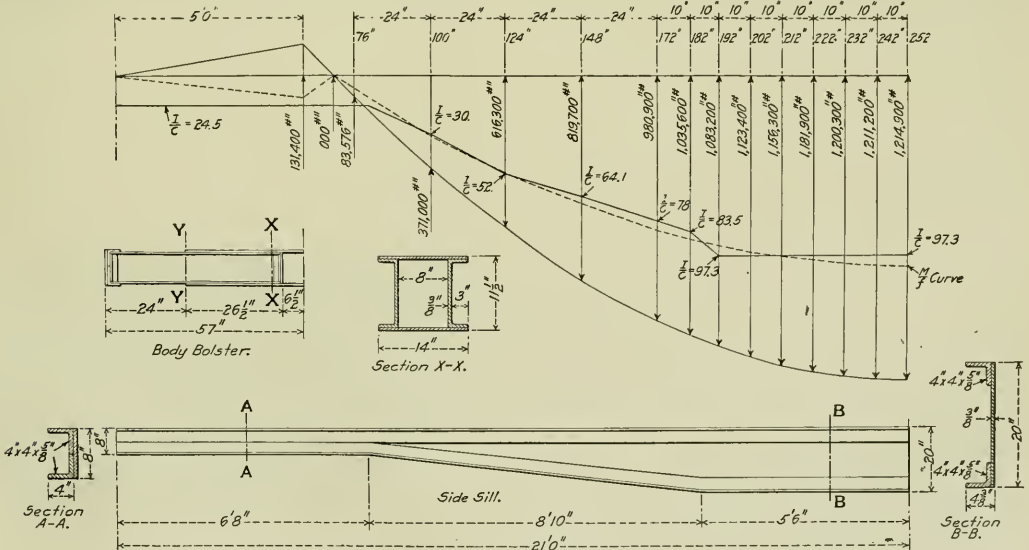

Fig. 5—Graphical Method of Designing a Side Sill for a 50-Ton Gondola Car.

since each member of the center sill supports a floor width of 31 3/4 in., therefore, for each inch of length, there will be a load of 2.88 x 31 3/4 = 92 lbs. per lineal inch.

For convenience of calculation only one-half of the center section about the vertical axis will be considered. (Section is symmetrical.) The different moments may now be found. At the bolster

$$M_b = \frac{WL^2}{2} = \frac{92 \times 60^2}{2} = 165,600$$

ment was less than at C—D. The section modulus of the 22 in. section was found to be 131, and the area 18.35 sq. in. Therefore,

$$f = \frac{100,000}{18.35} + \frac{1,032,000}{131} = 13,400$$

In like manner each of the other sections was designed. Near section 76, it was found that the cover plate could be omitted. From the center 5 ft. towards the bolster, the sill was made straight, as there was only a comparatively small change in the bending

moment, and also to allow for any concentration of the load that may occur at the center. The sill was also made straight a distance of 6 ft. 8½ in. from the end back towards the center. This was determined by locating a point on the moment curve, to the right of the bolster, which had the same value for the moment as required at the bolster. Thus the sill outline was determined. The section modulus or $\frac{I}{C}$ for each section as plotted was obtained by dividing the bending moment by the d -determined fiber stress due to the moment, which varied both above and below 12,000, that assumed for the $\frac{M}{f}$ curve.

The rather large distance between the $\frac{I}{C}$ and $\frac{M}{f}$ curves indicates

to what extent the actual section modulus had to be increased in order to provide for the buffing force.

Side Sill.—The stress diagram and sill design shown in Fig. 5, were determined and constructed in the same manner as they were for the center sill, there being only one exception, and that is, no buffing force was considered as coming directly on the side sills. The load per lineal inch for the side sill was 73 lbs. Since the side sill takes no buffing and carries less uniform load than either member of the center sill, it is considerably smaller in section.

The $\frac{M}{f}$ curve and the $\frac{I}{C}$ curve in Fig. 5 almost coincide. In a few instances, the $\frac{I}{C}$ curve falls above the $\frac{M}{f}$ curve, but in no instance is the fiber stress greater than 13,000 inch pounds, hence each section of the sill is sufficiently large. The construction of the side sill and its cross section is shown in detail in Fig. 5.

BODY BOLSTER.

The load of 85,000 lbs. on the body bolster was considered as uniformly distributed. The bolster acts as a cantilever beam and the distance of 48 in. between the side sill and the center sill was taken as its length. That portion between the members of the center sill being amply provided for by the cover and center plates, the greatest moment occurs at the center sill and is expressed by the following formula:

$M = \frac{WL}{2}$, in which, M = the bending moment, W = the load in pounds and L = the span in inches = 48 in. By substituting and solving, a moment of 1,009,375 inch pounds was obtained.

The moment at any other section as $Y'-Y'$ is equal to $\frac{WX^2}{2l}$ in which W and l are the same as in the above formula and X , the distance from the end of the bolster to the section $Y'-Y'$ = 24 in. The moment at $Y'-Y'$ was found to be 255,000.

The section modulus at $Y'-Y'$ is 22.3, the cover plates being omitted just to the right of the section. The fiber stress for this section is 11,400 inch pounds. The construction of the bolster in detail is clearly shown in Fig. 5. The bolster is securely fastened to the side and center sills by means of suitable angles and the top and bottom cover plates add considerably to the strength of the connection to the center sill.

OTHER DETAILS.

Having designed the principal members of the underframe as outlined, there remain a few other details that require attention. These are cross carriers, braces, side bearings, center plates and riveting. As the side and center sills have been designed of sufficient strength to take all of the loading, only such cross-carriers and braces need to be added as, in the dis-

cretion of the designer, are necessary for transverse and lateral stiffening.

The proper selection of side bearings and center plates is largely a matter of judgment and expediency, hence no particular problem of theoretical design is involved.

Spacing of Rivets.—When plates are needed in addition to the sills to carry the bending moment these must be riveted to the latter and the rivets properly spaced to receive the load coming to them. With strengthening parts riveted to both top and bottom of the sill, the spacing of the rivets can be determined by the well known formula

$$p = \frac{Rh}{J}, \text{ where}$$

p = pitch of the rivets in inches.

R = resistance of one rivet in pounds.

h = height between centers of top and bottom rows of rivets.

J = vertical shear in pounds at the point under discussion.

In case a single strengthening part is riveted either to the top or bottom of a sill, a different method must be employed to determine the rivet spacing.

From the method given, the theoretical spacing of the rivets can be found, but a rule in practice provides that the maximum spacing of rivets, to prevent buckling of the plate, be not more than 16 times the thickness of the plate. In case the formulae referred to give a greater spacing than 16 times the thickness of the plate, then the thickness of the plate must determine the pitch. These considerations will determine the spacing of the rivets, excepting at the extreme end of plate where two or three rivets are placed as close as practicable to take the initial stress in the plate.

BOX CAR FOR GRAIN AND COAL TRAFFIC

The construction of a suitable grain door has always been one of the most difficult problems in car design. A grain door should hold grain as securely as any other part of the car body, should be immediately available when required, should not be demolished in unloading, nor obstruct or decrease the lading room when not in use, and should be of reasonable first cost and low cost of maintenance.

With the end in view of meeting these requirements the Canadian Pacific has built 200 Burnett hopper bottom grain cars,



Exterior of Hopper with Door Closed; Canadian Pacific Box Car.

similar to the one shown in the illustrations, which embody several new features. The hinge of the hopper door is made by interlocking the edge of the door and the car floor, making a continuous hinge which, instead of weakening the edge, strengthens it as would the application of an angle, and the load always has a tendency to tighten the joint. The hopper door also differs from previous designs in that it is hinged at the bottom and is almost vertical; it has no closing shaft but is closed by hand and secured by a shaft having projections which engage the edge of the door at different points. The ends of the doors

have flanges which enter pockets or grooves formed by plates on the ends of the hopper. The grain doors are formed by sections of the floor at the doorway folding against the door posts. These doors are thoroughly reinforced and should be easily maintained in good condition. The whole construction is

the cars, each hopper is filled with flaxseed, which is then hammered and each hopper is made absolutely tight under this test; it is claimed that this is the most severe test possible with the exception of water.

One of the principal reasons for the development of this car

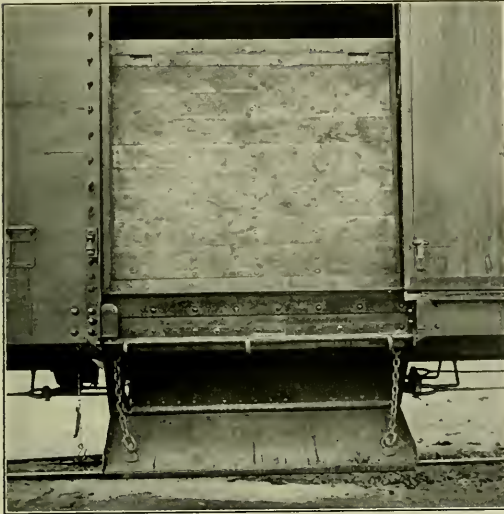

Exterior of Canadian Pacific Box Car with Hopper Open and Grain Door in Place.



Interior of Canadian Pacific Box Car Showing Grain Door and One Open Hopper.

simple and strong, and as the hoppers are not subject to corrosion to the same extent as those of open coal cars, they should, excluding damage in wrecks, last the life of the car. In building

was to secure one which would be suitable for carrying coal in one direction and grain in the other, avoiding to a large extent empty mileage and the hauling of other cars for coal, particularly



Hopper Bottom Box Car for Grain and Coal Traffic.

anthracite. In dumping grain the same elevator arrangement is used as with the ordinary car. To unload a car of grain, the pin which holds the clamping shaft handle is driven out, which allows the hopper door to open and about 50 per cent. of the load runs out almost as fast as the elevator can take it away; the floor door is then unlatched and pushed down and the remainder of the load is taken out through the side doors in the usual manner. It has been found that the employment of this method saves about one-third of the time which it ordinarily takes to unload a box car.

The hopper door arrangement increases the weight of the car about 800 lbs. compared with a car not fitted with grain door equipment, but when compared with a car fitted in the ordinary way for grain traffic this difference is reduced by the weight of the grain door and fittings. The cost of maintenance of the ordinary door and fittings, including the usual nailing strips on the door posts, has been estimated at from \$6 per car per year upward, which is eliminated in the hopper bottom car. The additional cost of applying the hopper bottom and folding grain

SPECIAL 75-TON FLAT CAR

BY R. S. MOUNCE.

During the summer of 1911 the Erie Railroad was called upon to construct a special flat car, to be used by the Wellman-Seaver-Morgan Company, Cleveland, Ohio, for shipping several very large water turbine wheels from their plant at Akron, Ohio, to Keokuk, Iowa, where a power plant of over 230,000 k. w. capacity, obtaining its energy from the Mississippi river, is being constructed.

The problem was of a most unusual nature and required much careful study; first, because of the great weight of the load to be carried; and second, because its size and shape were such that it was very difficult to keep within the clearance limits, both for height and width of the roads over which it would have to be carried, namely, the Erie, E. J. & E., C. B. & Q., and T. P. & W. The turbine wheels are 11 ft. 2½ in. long, 16 ft. 2 in. in diameter at the large end, 12 ft. 8 in. in diameter at the

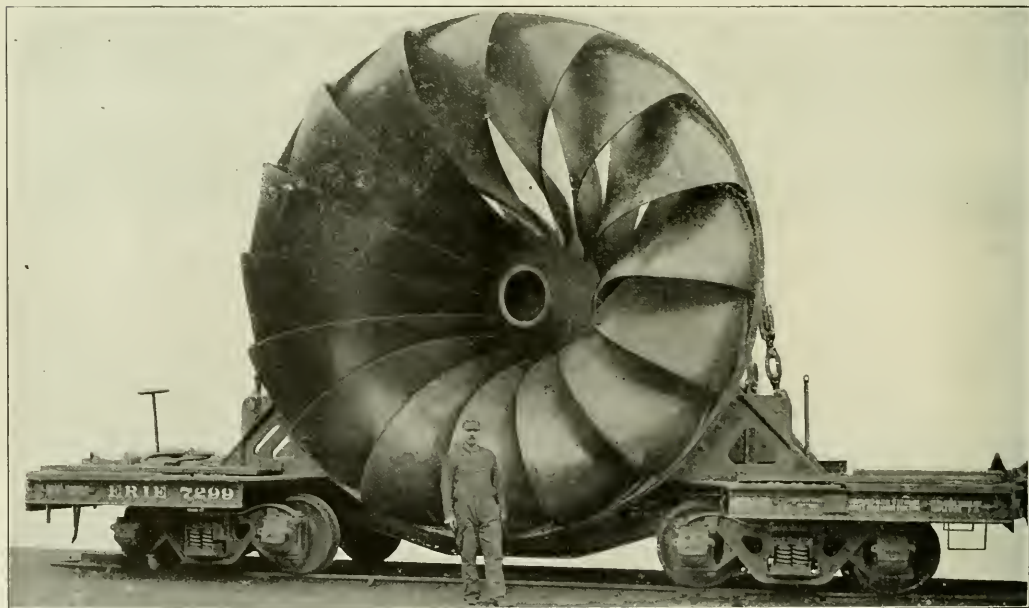

75-Ton Flat Car for Transporting Turbine Wheels 16 ft. 2 in. in Diameter.

doors is approximately \$50.00 per car. Where ordinary grain doors are used a force of men is engaged at elevators in removing nails from the door posts and inside lining and getting the cars ready for load, while with the hopper bottom car this force, as well as the shipping of temporary grain doors back to the point of loading, is almost entirely done away with, thus effecting an additional saving.

Short sections of Z-bars are applied on the inside of the door posts above the folding grain doors so that when the lading extends to a point higher than the folding doors, boards can be dropped into the slots thus formed and the load carried to any desired height.

These cars are giving excellent satisfaction in service and are sought by the elevator men in preference to other cars. The hopper and grain door arrangement is the invention of R. W. Burnett, general master car builder, Canadian Pacific, and is being patented by him.

small end and weigh about 130,000 lbs. The clearances on C. B. & Q. bridge gussets required the lowest point of the turbine wheel to be 16 in. above the rail, which brought the highest point 17 ft. 6 in. above the rail. The clearances at the sides were not over 1¾ in., and at the top and bottom not more than 1 in., so it can be seen that the utmost care had to be exercised in designing the car in order that no trouble would be encountered during transit.

A special flat car, all-steel with the exception of a few floor boards, was designed to meet the conditions imposed. In order to locate the turbine wheel supporting saddles comparatively low, it was also necessary to have the floor of the car quite low, which required the use of wheels 30 in. in diameter. The car was made as short as possible, in order to bring the point of application of the load very close to the body bolsters. It is 30 ft. long over end sills, with four-wheeled steel side frame trucks, having 6½ in. x 12 in. journals and Davis cast steel wheels;

NEW DEVICES

ELECTRIC ARC WELDING

Both the oxy-acetylene and electric welding systems are now in quite general use in railroad shops, the gas system being

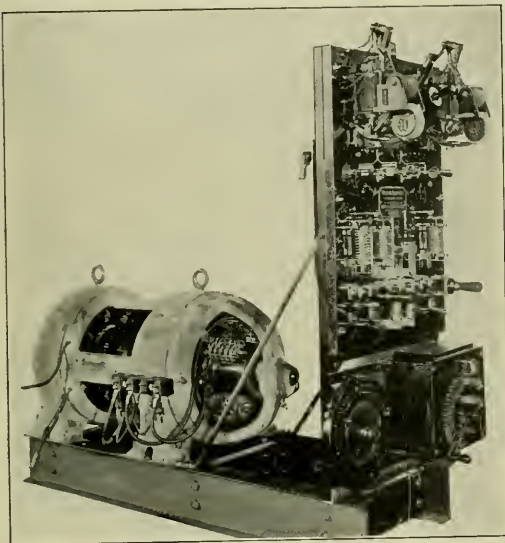

Portable 300 Ampere Multiple Unit Welding Outfit.

preferred for certain work while for other work the electric system is preferred.

Among the important features which are claimed for the electric arc system are its intense heat, which is about 4,000 deg. C., ease of manipulation, cheapness and safety. The operation of the electric arc for producing high temperature is quite simple and it has been in use for many years. The work which is to be repaired is generally connected with one wire from the electric circuit while the other wire is connected to an electrode in the



Operator Using Metallic Electrode.

hands of the operator. The electrode is then brought into contact with the work and the circuit established, when it is removed a slight distance and forms an arc. The operator then moves the electrode over the work wherever it may be necessary



Graphite Electrode Holder and Hand Shield.

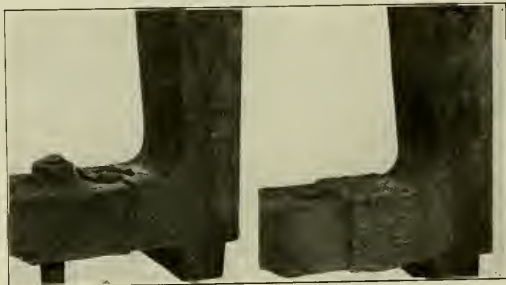

Broken Lower Frame Rail Before and After Welding.

and the arc follows, so that the heat may be concentrated or spread over an area, whichever is desired. A potential of from 10 to 60 volts is required at the arc, and if this voltage is obtained by the introduction of resistance in series with the existing shop circuits there will be considerable waste; and further, unless means are provided for maintaining the proper

potential and protecting the line against short circuits, it is impracticable to do electric welding from the regular shop circuit.

In order to overcome these difficulties the C. & C. Electric & Manufacturing Company, Garwood, N. J., has developed a special motor-generator set for electric welding. This set, with its automatic controlling apparatus, provides a means of readily changing the shop circuit, whether it is alternating or direct current, to the voltage necessary for welding and at the same time guards against short circuiting.

In using the graphite electrode method of electric arc welding a potential of from 50 to 60 volts is required at the arc and a current of about 300 amperes. This method is applicable to

AXLE LIGHTING SYSTEM

The Atchison, Topeka & Santa Fe is introducing, after a test, an axle lighting system, which has been in process of development by the Electric Storage Battery Company, Philadelphia, Pa., for a number of years. It automatically adjusts the output of the dynamo to the requirements of the service, and gives the battery the slight amount of overcharge required to keep it practically full and in good condition, but no more, producing conditions of operation ideal for maximum battery life. Should the battery become discharged by a prolonged stop with the lamp load on, its charge will be rapidly restored during the subsequent run. Should the car be transferred from a daylight run to one requiring considerable artificial lighting, the output of the dynamo will increase to meet the changed conditions of service. This is all accomplished automatically without manual adjustment of any kind.

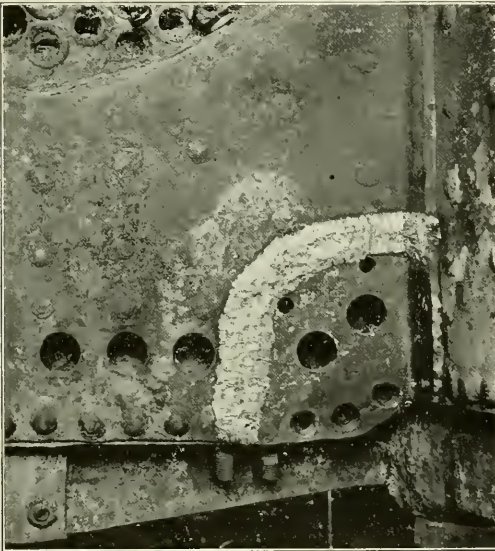

Piece Welded into Throat Sheet of Firebox.

welding, filling in, building up, cutting, etc., the metal for filling in or welding being supplied from an outside source, generally either a rod of soft iron or scrap metal which is fused by the arc. A lower potential is generally used with the metallic electrode. With this process the metallic electrode is itself consumed and forms the metal which is deposited on the work, so that the process has to be interrupted from time to time to permit of the operator's inserting a new electrode. This system is very generally used for side and overhead work, such as repairing cracks in locomotive fireboxes, as the metal is entirely used up and therefore does not drop on the operator. The full capacity of the machine can be used for either graphite or metallic welding.

NEW BRANCH LINE FOR INDIA.—A branch line, 8.58 miles long of the 3 ft. 3 in. gage has been sanctioned from Nidamangalam, on the South Indian Railway, to Mannargudi; to be constructed on behalf of the District Board of Tanjore.

HOLD-UP ON THE ILLINOIS CENTRAL.—The "Diamond Special" Express of the Illinois Central, northbound, was stopped by robbers about 13 miles south of Springfield, Ill., on the night of June 17, and the engineman was compelled to pull the express car some distance away from the passenger cars, where a stop was made and the express messenger was overpowered and the safe blown open.

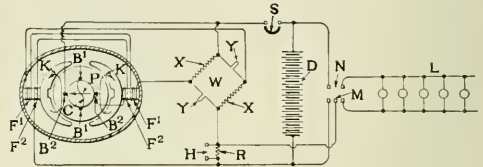

Wiring Diagram for Electric Storage Battery Axle Lighting System.

The dynamo is of the Rosenberg type, which has been used abroad in axle lighting for a number of years, but has been redesigned to operate in connection with a constant voltage regulator. Current in the primary field winding F^1 produces a small primary field flux represented by the arrow P , which induces a small electromotive force between the short circuited brushes B^1 and a flow of current through the short circuit connection C . This current, flowing through the armature winding, produces by armature reaction the secondary or principal field flux, which does not pass through the frame of the machine, but is confined to the heavy pole shoes and the armature as shown by the arrows K . This latter flux produces the electromotive force at the principal brushes B^2 , which are connected to the external circuit, a series field winding F^2 in this circuit serving to balance the armature reaction due to load. An important advan-

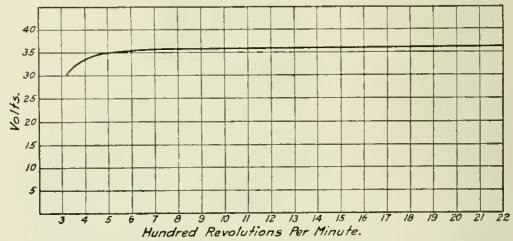

Speed-Voltage Characteristics of Axle Lighting Dynamo.

tage of this type of machine lies in the fact that it generates the same polarity with either direction of rotation, thus requiring no pole changer.

The primary field winding F^1 is connected across opposite junction points of the Wheatstone bridge W , the other two junction points being connected respectively to the positive and negative terminals of the machine. This bridge is designed to give the constant voltage characteristics above mentioned. It includes fixed resistances X in opposite branches and iron wire ballasts Y in the other two branches. The latter, on account of their high temperature coefficient, have a practically constant

current characteristic under operating conditions. This combination of circuits produces a field excitation continually diminishing with increase of speed. The resulting speed voltage characteristic of the dynamo is shown in one of the illustrations.

An automatic switch *S* connects the dynamo to the battery *D* when the voltage of the former is slightly above that of the latter and opens when the output of the dynamo drops to zero. The knife switch *N* connects the lamp circuit *L* to the battery.

The voltage of the dynamo is fixed at a point slightly above the floating voltage of the cells, thus insuring that the battery is always fully charged. The difference between this voltage and that of the battery on discharge is, however, so small and the change from one to the other so gradual that no lamp regulator is required.

Should it ever be found necessary to give the battery a high voltage charge, this may be done during a daylight run by means of the fixed resistance *R*, normally short circuited by the switch *H* and also by the clip *M* on the main lamp switch. When both of these switches are open, the voltage of the dynamo is raised by an amount determined by the value of the resistance *R*. Whenever lights are required, the closing of the lamp switch *N* short circuits the resistance *R*, reducing the voltage to normal, and eliminating the possibility of excessive voltage at the lamps. During five months of continuous operation of a demonstration equipment, no occasion for such a high voltage charge has arisen.

HERVEY STOKER

The Hervey stoker, which is of the top feed or scatter type, has been in use on a Mikado type locomotive on the Baltimore & Ohio between Philadelphia and Baltimore, making a total of

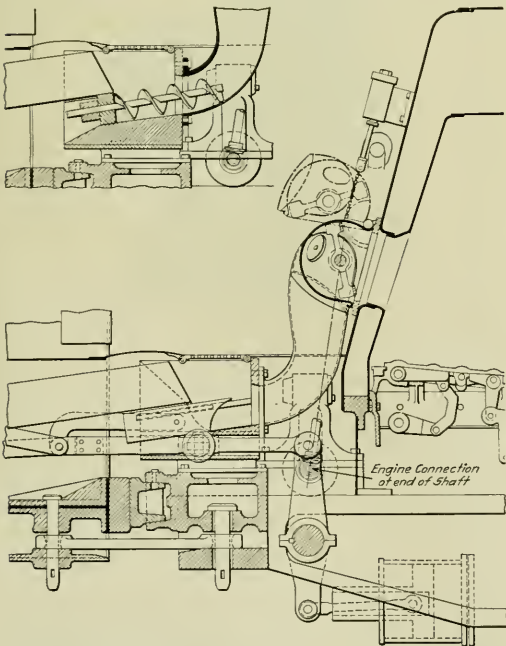

Application of the Hervey Locomotive Stoker with the Crawford Conveyor.

6,500 miles. The most noticeable feature about it is the distributor, which is constructed like a fan. In order to properly distribute the coal to all parts of the firebox the blades of the

distributor are so deflected as to deliver the fuel first to one side and then to the other. This distributor is so arranged in its casings that it may be swung out of the way in case it is necessary to resort to hand firing.

The coal may be delivered to the distributor either from above or below. The illustration shows an application of the Hervey stoker to a Pennsylvania Lines locomotive in connection with the Crawford tender feed arrangement. A special type of screw conveyor is employed in this case and is shown in the small view. A seven horse power steam engine is used to drive both the conveyor and the distributor, this being accomplished through the use of bevel gears. In this application the screw conveyor passes the coal up through the feed passage to the distributor. This stoker was invented and patented by D. F. Hervey, Logansport, Indiana.

CRANE-GRINDER

It is frequently necessary to do more or less grinding on large castings, forgings or plates and it is not an uncommon sight to see two or three men holding a piece that is being ground. For such cases, a moderate size crane or hoist over a grinder has very evident advantages and the Mummert-Dixon Company, Hanover, Pa., has designed a machine of this kind.

This tool is shown in the illustration and has a substantial base, at one end of which is mounted a double grinding wheel driven by a pulley between the wheels. At the rear of the base is a suitable frame consisting of channels properly formed and

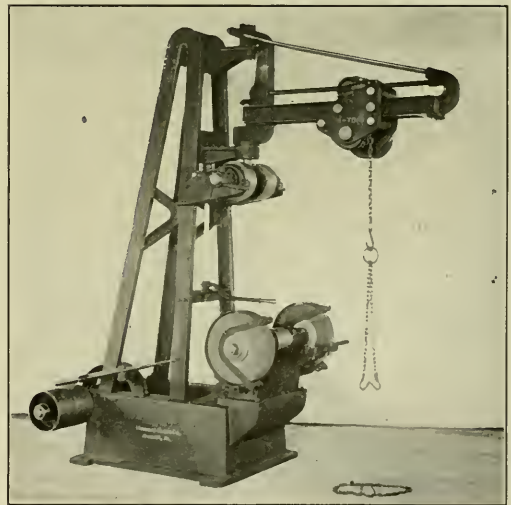

Grinder with One-Ton Crane and Power Hoist.

braced, to which are secured the brackets carrying the swinging arm. The crane arm itself swings on two trunnions and is free to move for more than a half circle. The one-ton trolley has a free movement in and out on the jib and the hoist is driven through the medium of the square shaft seen just over the runway. Connection is made by bevel gears, through the lower trunnion to a shaft which carries two pulleys. These are belted to the main driving shaft, one belt being straight and the other crossed. Between the two pulleys is a clutch operated by a lever handle near the wheels. When this lever is thrown in one direction it engages the lifting clutch and when thrown in the other it engages the lowering clutch. In the central position it is neutral. Provision is also made for operating the hoist by

hand, if desired, by means of a crank handle on the end of the clutch shaft.

With this machine, castings or forgings of any weight up to one ton may be conveniently handled and properly ground by one man. Detachable rests are provided which may be used with the grinding wheels when lighter castings are being ground. The wheels are protected with substantial steel guards. The countershaft runs in self-oiling bearings and is so located that all belts are out of the way.

ELECTRIC RIVETING

Rivets form a most important part of the structure of locomotives and steel cars and any process that will improve the method of using them will be of interest to railroad mechanical men. The electric riveting machines which are illustrated here are suitable for riveting car and locomotive truck frames, ash pans, tool boxes, structural work, etc., and are manufactured by the Eveland Engineering & Manufacturing Company, Philadelphia, Pa.

Riveting by electric current, by heating and heading the rivets

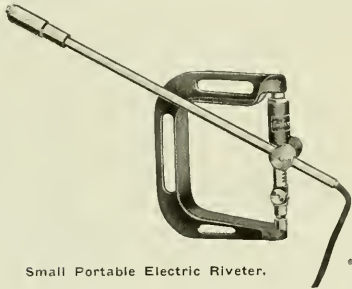

Small Portable Electric Riveter.

when in place, has been in successful operation in a number of factories for several years. A cold rivet is placed in position, and by pressing a lever, it is heated by electric current to any degree required, while by a suitable arrangement of levers pressure is exerted either by power or by hand and the head is formed, both the heating and heading being done in one operation. The Eveland electric riveters are made in various types and sizes, from small bench and portable machines to power driven ma-

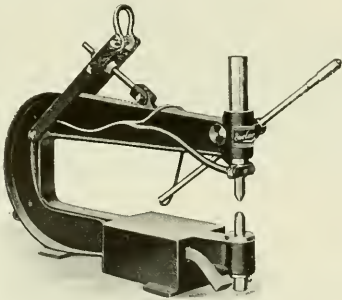

Large Type of Portable Electric Riveter.

chines, and are capable of heating and heading rivets of any material and from 1/16 in. to 2 in. in diameter.

The machines are capable of developing a temperature in excess of 2,000 deg. F., but it is claimed they are absolutely safe and that there is no possibility of an electric arc forming, nor of any danger from electric shock. The use of this pro-

cess eliminates the necessity of having gas, oil, coal or coke forges to heat rivets, which makes the riveting easier and it is claimed gives better results, as a cold rivet may be handled more easily than a hot one and may be placed in position without fear that it may become cold and the head chip off. A uniform heat is obtained, expansion is uniform and when the proper degree of temperature is secured for the rivet it is headed, so that the fibers are not injured by overheating, stretching, too rapid cooling, etc. It is also claimed that the difficulty experienced when rivets are hammered until they are cold is entirely eliminated, as there is no necessity of forming the head until the rivet is at exactly the right temperature, when it is automatically headed. Calking is seldom required in this process, because the method produces a gradual heating of the rivet which swells and fills the rivet hole uniformly and fully when headed, so that inequalities in the plates are filled with the hot metal. The manufacturers state, however, that where calking is required it may be done more safely and easily if the electrically heated rivet is used on account of there being

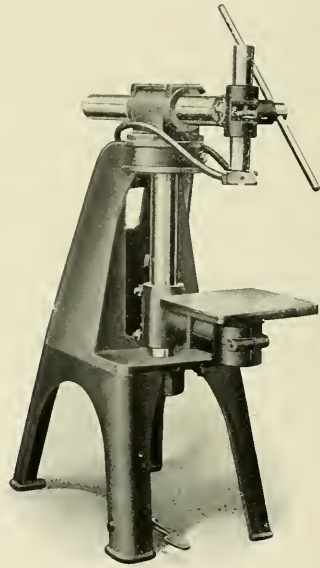

Universal Electric Riveter.

no brittleness to the rivet or head because it has not been hammered while cold, or nearly so.

The difficulties of giving a proper heat to the rivet are also overcome because the temperature may be completely controlled. If desired, the machines are arranged so that they cannot heat the rivets above 1,300 deg., or if a higher temperature is needed 1,450 deg. to 1,500 deg. may be given. The machines are made with a series of heats known as variable speeds, so that by moving a small hand switch from one point to another a greater or less degree of temperature may be instantly secured; on one heat or speed they will rivet a small rivet, while on the next speed a larger rivet may be used, each speed having a maximum size of rivet which it will handle properly. Another point upon which stress is laid is that the rivets do not become chilled by being brought into contact with the cold plates while cooling.

There is no necessity to anneal cold made rivets, as they are heated and headed in the same manner as hot made rivets. Rivet makers urge users never to leave rivets in the fire during the

dinner hour or for any long period, but the electric riveting machine may be used up to the last minute and started again instantly when the dinner hour is over, as each rivet is heated separately.

No air compressor is needed with these riveters, and it is stated that a fair average cost per 1,000 rivets for ordinary work, the cost of electric current being taken at 10 cents per k. w. hour, is from 8 cents to 10 cents per 1,000 for 5/16-in. rivets; 12 cents to 14 cents for 3/8-in. rivets; 20 cents to 25 cents for 1/2-in. and 5/8-in. rivets, and larger sizes in proportion. It is also claimed that a man and a boy will do at least four times as many rivets per day as a man, a helper and a forge boy will do with the older process; if the work is such that it can be done on bench machines one man can do it alone. The cheapest type

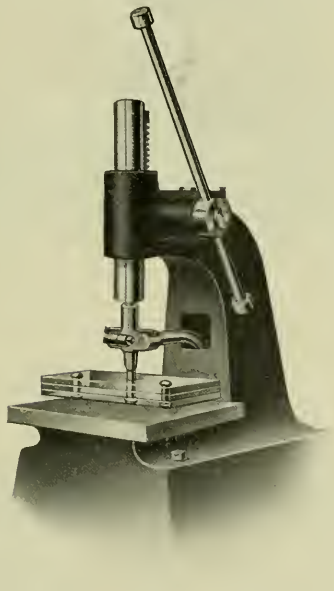

Base Type of Electric Riveter.

of labor can be used as there is no particular skill required.

Among the various types of these machines is a small bench machine for rivets up to 1/4 in. in diameter; a base machine for larger and heavier work and rivets up to 1/2 in. diameter; and a universal machine which will rivet at any angle and will cover a large range of sizes and shapes. The portable machines are used for boilers, etc., and are applicable to a large range of rivet diameters. The power-driven riveters are automatic in operation, being made with a motor driven, special, variable speed attachment by means of which the operator may regulate the pressure as well as the speed of operation, rapidity of heating, etc., by pressing a button. The machines may also be adapted for tempering and hardening and for heating metal for bending, etc.

RAILWAY ACCIDENT IN MACEDONIA.—On May 23 a collision occurred at a junction of the railway between Poroi and Andjista as the result of which two engines were completely ruined. The accident is said to have been due to an error either of the Bulgarian military station master at Poroi or the station master at Andjista, and it is reported that the one who was held to be responsible has been shot by order of Colonel Ivanoff, the inspector of Bulgarian railways.

INDIRECT LIGHTING ON NEW HAVEN TRAINS

Indirect electric illumination was made a feature of the two new Pullman trains recently put in service between New York City and Boston, on the New York, New Haven & Hartford. This type of illumination has previously been used in a few of the more modern private cars, but never before in a solid train. The "Alexalite" type of indirect lighting units was chosen. The exterior bowl of the fixtures is adaptable to any artistic design. The design of the three distinctive car lighting fixtures installed in the New Haven trains was a Colonial or an Adam-Colonial type, and the cars were built to harmonize with the fixtures, whereas the fixtures are usually fitted to the car. Features of the decoration are the fan shaped windows, the spindle legged chairs in the dining room, the harmonious de-



Alexalite Indirect Lighting Units.

sign of the ventilator windows and the delicate inlaid pattern in the woodwork. The floor is covered with a heavy Brussels carpet instead of the conventional green.

Three different exterior designs are carried out in the fixtures for the observation, dining and chair cars. The casing is of wrought brass cast in one piece, and the entire fixture is made solid and rigid. The diffuser basin is made of steel, coated with a durable, white porcelain enamel. The fixtures are hung so that the diffusing bowl is about 12 in. below the monitor ceiling, being spaced 6.5 ft. apart on centers and installed in a single row. No side lighting is required.

The fixtures in the observation car are equipped with three 50-watt tungsten lamps, suspended vertically above a white porcelain reflecting bowl. The other fixtures are "Monelux" and contain one 100-watt lamp. The illumination is equivalent to more than 4 ft. candles on a plane 6 in. above the arm of the chairs. The lighting fixtures used in this installation were supplied by the Central Electric Company, Chicago.

GREASE PLUG

Trouble is very commonly experienced by the grease plugs used in side rods being lost when the locomotive is in motion; lock nuts easily slack off due to the motion of the rods and the plugs then work out and drop off. The device shown in the illustration is intended to prevent this. It consists of a T-shaped piece of metal, the ends of the lower arms of which are ball shaped to fit into notches in the bushing of the plug or the top of the side rod. This T is held down by a spring in the body of the plug and when the ends of the lower arm drop into the notches

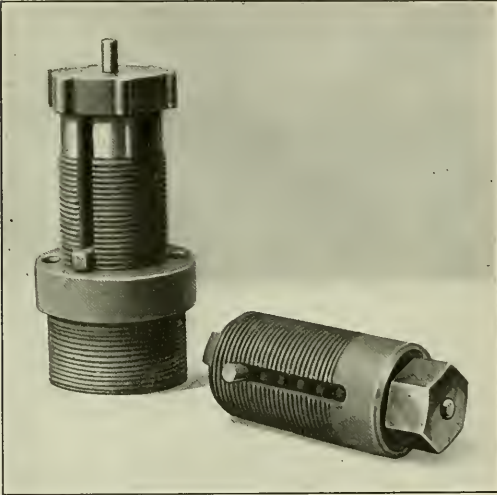

Grease Plugs Fitted with Locking Device.

the tension of the spring holds the plug firmly in place. The main arm of the T passes through a hole in the top of the plug and acts as an indicator of the amount of grease in the cup.

The device is in use on a Pennsylvania Lines consolidation type locomotive, and the one on the right in the illustration shows an application to the Pennsylvania standard grease plug. It may be applied to any plug now in use and is patented by D. F. Hervey, Logansport, Ind.

SHARPENING CURVED TOOTH FILES

Alexis Vernas, of Switzerland, invented the milled, curved tooth file in 1900, and was awarded the Elliott Cresson gold medal by the Franklin Institute of Philadelphia for his invention. This type of file has shown itself to be a decided improvement over the usual type, and it is stated that it will remove from three to five times as much metal, when compared with an ordinary bastard file.

In manufacturing these files, the teeth are cut one at a time on a milling machine; it takes about 25 minutes to mill the teeth on one 12 in. Vixen file, while an ordinary bastard file requires less than a minute for making the teeth. In as much as each tooth is separately milled, it is possible to sharpen the curved tooth file in the same manner that a milling cutter is sharpened and a machine has been developed for this purpose.

This machine employs a fine grinding wheel, held in a frame pivoted at the proper point to give the wheel the correct arc for grinding the teeth. The moving of the wheel across the file is performed by hand, as is also the change in the position of the file for grinding the different teeth. The operation is so

simple, however, that boys or even girls can run the sharpener satisfactorily.

It is stated that one of these files can be sharpened from four to six times, and in each case the file is equal to a new

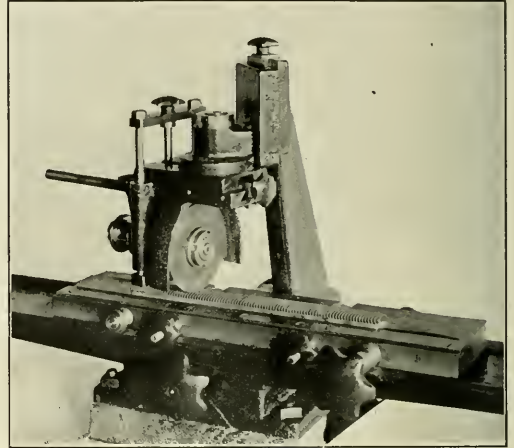

Machine for Regrinding the Teeth of a Curved Tooth File.

one. The machine was developed by the Vixen Tool Company, Philadelphia, Pa., who manufacture the Vixen file.

DOUBLE JOURNAL BEARING BORING MACHINE

The ordinary boring machines for journal bearings of the average size are too light for efficient work on the large size bearings which are now coming into more general use. Recog-

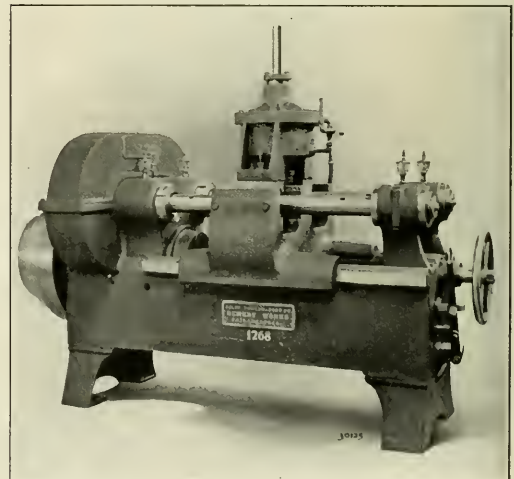

Boring Machine for Journal Bearings up to 8 in. x 15 in.

nizing the probable future demand for a more powerful machine, the Niles-Bement-Pond Company, Bement Works, Philadelphia, Pa., has perfected a double boring machine which has a capacity

for journal bearings up to 8 in. x 15 in. in size. In this machine the journals are clamped in position by a pneumatic cylinder which is so designed as to allow for a slight difference in the size of the journals on either side, and provides for very convenient and rapid removal and application of the work in the machine.

The saddle is provided with hand adjustment, automatic feed and a quick return by power. The change from power feed to rapid traverse in the reverse direction is made by one lever. A set of chucks for standard M. C. B. journal bearings is provided with the machine, but special size chucks can be used if desired. The boring mandrels are 3 3/4 in. in diameter and are separate from the spindle. Other sizes of mandrels may be substituted if required. The machine can be driven either by a direct connected motor or by a belt through a three-step cone pulley. Its construction is heavy throughout and the gearing is unusually large and powerful.

EQUALIZED SWING-MOTION TENDER TRUCK

A locomotive tender truck that has already proved itself to be satisfactory in service when used on high speed locomotives, has recently been perfected by the Commonwealth Steel Company, St. Louis, Mo. It is provided with a swing-motion bolster carried on three-point hangers which are so designed as to support the tender in a stable manner without responding laterally to slight track imperfections, such as low joints, etc. The truck frame, in many respects, follows the design which has been previously used by this company for four wheel passenger car trucks and combines the cross transoms and the wheel pieces in one steel casting. It is claimed that with the three-point hanger for the bolster, the impact between the wheel

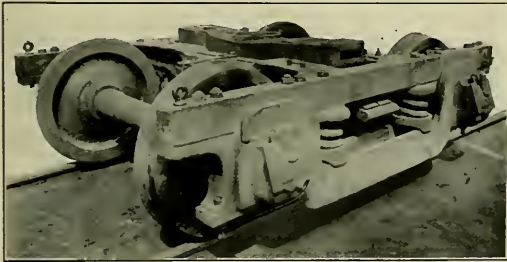

Equalized Tender Truck with Swing-Motion Bolster.

flange and the rail when entering a curve at high speed is greatly reduced, this due to the fact that the cistern is lifted by the side swing of the bolster and thus tends to throw the whole truck away from the rail. This truck is equalized in practically the same manner as a passenger car truck, the wheel pieces being supported on the equalizers by large single coil springs placed as close as possible to the boxes. It will be noted that the springs supporting the bolsters are set well in toward the center, thus tending to keep all weight well inside the gage limit and defeating any tendency to lift the wheels from the rail.

FLOOD DAMAGE IN NATAL.—It is estimated that the total cost of repairing the damage done to the railways in the province of Natal by the recent floods, and of effecting certain improvements with a view to reducing the possibility of similar damage occurring in future, would be \$276,250, all of which will probably be charged to capital account.

DROP TEST OF VANADIUM CAST STEEL FRAME

The photograph of the vanadium cast steel locomotive frame bent cold into the form of a semi-circle under a drop, without a sign of fracture, graphically illustrates the remarkable strength and toughness of the material. It is a rear frame made by the Union Steel Casting Company, Pittsburgh, Pa., for a Pacific type locomotive for the Southern Railway and was subjected to the following treatment in the cold: The frame was first laid on supports 6 ft. apart and subjected to the following blows from a drop-ball weighing 1,400 lbs., without breaking:

- 1 blow at 8 ft.
- 3 blows at 16 1/2 ft.
- 3 blows at 16 ft.
- 1 blow at 15 ft.
- 3 blows at 18 ft.

A heavier ball weighing 4,765 lbs. was then substituted and the following blows given:

- 5 blows at 14 1/2 ft.
- 1 blow at 14 ft.
- 1 blow at 13 ft.

Then the frame was stood on end and subjected to three more blows with the 4,765-lb. ball falling from heights of 6, 9 and 12



Vanadium Cast Steel Locomotive Frame After Drop Test.

ft. respectively. At the end of the test, there was not the least sign of a crack or fracture of any kind in the frame.

Physical tests and chemical analysis showed the material to have the following properties and composition:

PHYSICAL PROPERTIES			
Elastic limit, lbs. per sq. in.	47,500		
Tensile strength, lbs. per sq. in.	80,000		
Elongation in 2 ins.	24 per cent.		
Reduction of area.	39 per cent.		
CHEMICAL COMPOSITION			
Carbon	.26 per cent	Vanadium	.203 per cent
Manganese	.516 per cent	Phosphorus	.033 per cent
Silicon	.26 per cent	Sulphur	.028 per cent

ELEVATED RAILROAD FOR CALIFORNIA.—An elevated railroad is being built in California at the Oakland terminal of the Southern Pacific—the only elevated railroad west of Chicago. The elevated line will be a double track structure with ballasted floor, 12 blocks (3,844 ft.) long, and will accommodate the suburban electric passenger trains.

NEWS DEPARTMENT

The Governor of Massachusetts has vetoed the bill passed by the legislature, permitting the New York, New Haven & Hartford to acquire all the electric railways in that state west of Worcester.

The anti-noise campaign in Chicago is receiving the co-operation of the railways, several of which have promised their assistance by eliminating some of the whistling of locomotives and the ringing of bells, which the city council committee deems unnecessary.

A press despatch from Seward, Alaska, says that the rolling stock and rights of the Alaska Northern have been turned over to a committee of business men to be operated for the benefit of the community. This action was taken by Chief Engineer Swanitz, because of a demand by the United States for payment of \$67,000 mileage tax.

The shops of the Denver & Rio Grande at Salt Lake City were mostly destroyed by fire on the night of June 18; estimated loss \$200,000. The paint shop, blacksmith shop, planing mill, engine room and wheel shop were destroyed, together with 25 freight cars, 6 passenger cars and 3 cabooses. Officers of the road announce that the shops will be replaced by much larger ones, but the exact location has not yet been announced.

The monorail line, extending from Barrow station on the New York, New Haven & Hartford, New York City, to Belden's Point, about two miles, has been abandoned. The company operating it, which is controlled by the Interborough Rapid Transit Company, has been reorganized and a standard gage surface electric railroad will be put in operation over this route. The monorail was operated for passenger business for a considerable time, but it has not given satisfaction.

THE NEW HAVEN'S ACCIDENT RECORD

The New York, New Haven & Hartford, because of what it characterizes as the many erroneous statements and false reports placed before the public in the Brandeis campaign, which has been almost continuous now for six years, and which finds its opportunity in accidents as well as labor and political agitation, has issued an abstract of its record of passenger train accidents for ten years from June 30, 1903, to June 15, 1913. In that time the company ran 5,078,750 trains a distance aggregating 158,531,541 miles, and in these trains carried 755,678,338 passengers paying fare. In these ten years there were 6 accidents to trains in which persons traveling on them were killed, and the number of passengers killed was 29.

In six of these ten years not a single passenger was killed in a train accident. To correct the many erroneous statements that have appeared in print, the figures by years are here given:

Years.	Passengers carried.	Train accidents in which passengers were killed.	Passengers killed in train accidents.
1903 (Last six months).....	34,090,448	0	0
1904	63,234,687	0	0
1905	66,507,138	0	0
1906	72,521,069	0	0
1907	75,453,778	0	0
1908	74,382,023	1	1
1909	79,849,297	0	0
1910	83,860,031	0	0
1911	83,768,348	2	12
1912	83,350,409	2	10
1913 (to June 15).....	36,661,110	1	6
Total	755,678,338	6	29

The statement continues: "In the five accidents preceding 1913 no coroner's verdict or investigation by state or national authorities found any defect in the construction of roadbed, the condi-

tion of motive power, or equipment, or in condition or operation of signals. It is because of this record for safety and because of the superior roadbed and equipment that the public is shocked over every accident, of any character, from any cause, that takes place on this road."

ENGINEERS WANTED FOR VALUATION WORK

The United States Civil Service Commission, Washington, has issued its announcements of examinations to be held for filling positions in the Interstate Commerce Commission under the act providing for the valuation of the property of railroads. The examinations will be held July 23, at the usual places in different parts of the country, and the places to be filled are as follows:

Senior structural draftsman	Salary	\$1,800 to \$4,000
Senior mechanical engineer		1,800 to 4,800
Senior railway signal engineer		1,800 to 4,800
Senior electrical engineer		1,800 to 4,800
Senior inspector of car equipment.....		1,800 to 3,600
Senior civil engineer		1,800 to 4,800
Senior inspector of motive power.....		1,800 to 3,600
Senior architect		1,800 to 4,800
Architect		1,080 to 1,500
Inspector of motive power.....		1,200 to 1,500
Civil engineer		720 to 1,500
Inspector of car equipment.....		1,200 to 1,500
Electrical engineer.....		1,080 to 1,500
Railway signal engineer.....		1,080 to 1,500
Mechanical engineer.....		1,080 to 1,500
Structural engineer		1,080 to 1,500

In the case of positions for which the salaries are \$1,800 or more the applicants are not required to assemble at any place for examination, but are rated according to the documentary evidence presented.

Persons desiring to enter an examination should at once apply for blank form 2039 to the United States Civil Service Commission at Washington, D. C.; or to the secretary of the Board of Examiners, at Boston, Philadelphia, Atlanta, Cincinnati, Chicago, St. Paul, Seattle, San Francisco, New York, New Orleans, Honolulu, St. Louis, or to the chairman of the Porto Rican Civil Service Commission, San Juan.

RAILWAY TERMINAL DISCUSSION IN CHICAGO

New plans for the solution of the terminal problem in Chicago continue to be presented to the committee on terminals of the city council. The latest is that of William Drummond, of the architectural firm of Guenzel & Drummond, who suggests a main trunk line at Englewood to be used by all through traffic entering from the south, and a three-sided loop with connections to handle the traffic from the west and north.

Following the Pennsylvania's recent ultimatum to the effect that unless the road's plan for a west side terminal is approved the present inadequate facilities will be continued indefinitely, the council committee has held several meetings at which the various plans were discussed by interested parties. Architect A. J. Graham presented arguments for the Pennsylvania plan, and F. O. Butler, of the J. W. Butler Paper Company—whose opinion is probably representative of that of the business men in localities embraced in the various plans—supported Mr. Graham's contentions.

On Saturday, June 14, Jarvis Hunt, sponsor of one of the plans, gave the committee of councilmen a long address.

The Chicago Association of Commerce, on June 11, addressed an open letter to the mayor, the city council and the citizens of Chicago urging delay in passing the proposed smoke abatement and electrification ordinance which would demand electrification of all railroad terminals by June, 1915, and which has received the recommendation of the council committee on terminals. The association denies vigorously the accusation that it

has attempted to thwart electrification or smoke abatement in the city, and says that its report, which has been in course of preparation for three years, will be ready in 1914, and will come nearer the desired solution of the problem than any haphazard action which may be taken by the council without a comprehensive investigation.

At a recent meeting of the Council Committee, Robert C. Sattley, valuation engineer for the Rock Island Lines, presented a scheme for a union station to include all the railways entering the city, even the Illinois Central, and to be located west of the river at a distance from the loop district not much greater than the new North Western terminal. Mr. Sattley's plan is the one that was originally presented in 1901 before the Western Society of Engineers and published in proceedings of that organization, but with revisions to bring it up to date.

SUBSTITUTE FOR THE CAR REPAIRER'S BLUE FLAG

The Railway Commissioners of Canada, following an investigation of certain complaints, have recommended to the railways of the Dominion that a metal or wooden disc be used as a signal for the protection of cars which are being repaired instead of the flag, "which is subject to the caprices of the wind." The commissioners recommend the use of a disc the shape of a semaphore arm to be hung on the ladder at the end of a car and so fixed as to project 18 in. beyond the side of the car. In this position it would be visible the length of an ordinary train. The horizontal arm would be fastened to a vertical board fitted with hooks by which it could be supported on the rounds of the ladder. At night a blue lantern could be hung from the projecting arm. The railways are requested to send to the commission their views on this suggestion.

THE VIEWS OF PRESIDENT REA ON THE SITUATION

I can take no gloomy view of this great country and its possibilities, notwithstanding the present unfavorable outlook. I have unbounded confidence in the business men of this country that nothing approaching confiscation or unfair dealing to lower the standards of service will ultimately be permitted, provided the railroads themselves will put their cases in the hands of the business public and clearly emphasize their needs; it is for that purpose that we are in conference with you.

So far as the Pennsylvania Railroad itself is concerned, and stripping it of all obligations connected with the lines in its system which act as feeders, it perhaps cannot be said that at present it absolutely needs an increase in transportation rates for the ordinary maintenance of its property, the payment of its present fixed charges on the outstanding capital, or to maintain the present rate of dividend.

This is the result of the conservative management I have already alluded to, which has conserved its capital account and applied all above a fair dividend to the betterment of the property; but the company itself cannot ignore the other companies in its system upon which it relies to be fed with traffic, and upon their investment and its own, as above stated, it received the low return of 4.83 per cent. in 1912.

One railroad, as you know, cannot be favored in this wise and the others excluded. If the position of the Pennsylvania system, as above stated, leaves it in need of the moderate advance in freight rates now requested, it is clear that such an advance is urgently needed on sound business reasons, by all other railroad companies, not to pay for inefficient management or undue capitalization of the past, but after exercising the best ability and foresight that can be obtained in the administration of the property the railroads are not receiving just compensation under present rates.

Unless this reasonable treatment is accorded to the railroad companies and a fair return can be earned upon the money invested in railroad facilities, the railroads will come to a standstill because capital cannot be exacted from the public unless it is suitably rewarded. Therefore, is it not time for business

men of your experience to take a hand and see that only fair-minded and impartial men are sent to legislatures and regulative bodies who will co-operate with these governmental agencies of transportation—for that is what they have become in fact, although privately owned—to the end that continued good service and facilities may be assured, necessary improvements made, protection secured for the capital already invested, and the new capital raised on a basis that shall yield a fair return to the owners of the properties.

And, furthermore, can you not also do something to guard against the unwise acts of organized labor when directed to securing what might be termed coercive and class legislation as illustrated in the extra crew laws? Railroads, like other corporations, are now generally prohibited from contributing to political parties, and rightfully, but without apologizing for what existed in the past, I do believe that such contributions were made oftener for the purpose of preventing unjust legislation than to influence legislation favorable to the railroad companies.

What, however, is the difference in morals between railroads currying favor with political parties through contributions to the party purse, and so-called labor committees sitting in almost every capital and in many cases, as we are informed, promising votes in return for such unnecessary legislation as the extra crew laws? I say there is no difference, and such action should also be prohibited, and you business men can do much in this direction, if you believe the railroad position just and will make your power effective.

Such action will also be in the most enlightened interest of the employees, and encourage those who intrust their capital to us. We must all work and advance together on a mutually fair basis if we desire our country to progress.—*From an address before the Shippers of Boston, June 12, 1913.*

MEETINGS AND CONVENTIONS

American Railway Tool Foremen's Association.—The fourth annual convention will be held at the Hotel Sherman, Chicago, July 22, 23 and 24. All foremen in charge of the tool departments of machine and electric railway shops are eligible and all railway foremen are invited to the convention whether members or not. There will be elaborate exhibitions of tools and machinery in the exhibition hall adjoining the convention room, in charge of A. H. Ackerman.

It is expected that there will be a number of the higher railway officers present as speakers, and the program is as follows: 1. Reclaiming of Scrap Tool Steel; J. J. Sheehan, chairman. 2. Making of Thread Cutting Dies; A. W. Meitz, chairman. 3. Making of Forging Machine Dies; B. Hendrickson, chairman. 4. The Electric Furnace for Tempering Tool Steel; Method of Operation, Cost of Maintenance and Results Obtained; C. A. Schaffer, chairman. 5. Superheater Tools and Their Care; H. Otto, chairman. 6. The Form of Thread and Degree of Taper for Boiler Studs and Plugs; A. M. Roberts, chairman.

New England Railroad Club.—The paper presented at the April meeting was on "Modern Air Brake Equipment as Applied to Steam Roads," by Charles U. Joy, general air brake inspector, New York, New Haven & Hartford. It briefly described the air brake equipment that was in use a few years ago, discussed the changes in conditions that made improvements necessary and briefly covered the essential points of the present equipment. The paper made no mention of the electro-pneumatic brake and but briefly touched on the subject of clasp brake. The discussion was active and very largely in the nature of additional information on the successful performance of the modern equipment. Mr. Joy stated that there had been a very large reduction in the number of slid-flat wheels since the application of the P C brake to passenger cars. On the New Haven system from December, 1911, to February, 1912, there were but 77 pairs of

slid-flat wheels removed and over 50 per cent. of these were removed from cars using 70 lbs. pressure. The records show that during that period there was on an average of one pair of slid-flat wheels removed for 326,530 passenger car miles.

International Engineering Congress, 1915.—In connection with the Panama-Pacific International Exposition which will be held in San Francisco in 1915, there will be an International Engineering Congress, in which engineers throughout the world will be invited to participate. The congress is to be conducted under the auspices of the following five national engineering societies: American Society of Civil Engineers, American Institute of Mining Engineers, The American Society of Mechanical Engineers, American Institute of Electrical Engineers, and The Society of Naval Architects and Marine Engineers. These societies, acting in co-operation, have appointed a permanent committee of management, consisting of the presidents and secretaries of each of these societies, and eighteen members resident in San Francisco.

International Railway General Foremen's Association.—Indications are that the ninth annual convention, which will be held in Chicago, July 15-18, will be the most successful in the history of the organization. Greater interest is being manifested this year than at any previous time, applications are coming in in a very gratifying manner, and from roads not previously represented. This is due largely to the hearty co-operation of the superintendents of motive power, who are encouraging their general foremen to become members of the association. A number of application blanks were sent to the superintendents of motive power of every important road in the United States and Canada, who have placed them in the hands of the foremen, and in several cases repeat orders have been received.

The following is the program for the convention: July 15, 10 a. m., opening prayer by Rev. E. C. Armstrong, Chicago; address of welcome, Hon. Carter H. Harrison, mayor of Chicago; response, W. W. Scott; address, President F. C. Pickard; report of secretary-treasurer.

July 16, 9:30 a. m., Maintenance of Superheater Locomotives, R. C. Linck, chairman; address, R. Quayle, superintendent motive power and machinery, Chicago & North Western; election of officers.

July 17, 9:30 a. m., Engine House Efficiency, W. Smith, chairman; address; Shop Schedules, L. A. North, chairman.

July 18, 9:30 a. m., Driving Box Work, Geo. H. Logan, chairman; address; The Apprentice Question, F. W. Thomas.

The following list gives names of secretaries, dates of next or regular meetings, and places of meeting of mechanical associations.

- AIR BRAKE ASSOCIATION.—F. M. Nellis, 53 State St., Boston, Mass.
 AMERICAN RAILWAY MASTER MECHANICS' ASSOC.—J. W. Taylor, Old Colony building, Chicago.
 AMERICAN RAILWAY TOOL FOREMEN'S ASSOCIATION.—A. R. Davis, Central of Georgia, Macon, Ga. Convention, July 22-24, 1913, Chicago, Ill.
 AMERICAN SOCIETY FOR TESTING MATERIALS.—Prof. E. Marburg, University of Pennsylvania, Philadelphia, Pa.
 AMERICAN SOCIETY OF MECHANICAL ENGINEERS.—Calvin W. Rice, 29 W. Thirty-ninth St., New York. Annual meeting, December 3-6, Engineering Societies' Building, New York Railroad session, Thursday morning, December 5.
 CAR FOREMEN'S ASSOCIATION OF CHICAGO.—Aaron Kline, 841 North Fifthth Court, Chicago; 2d Monday in month, Chicago.
 INTERNATIONAL RAILWAY FUEL ASSOCIATION.—C. G. Hall, 922 McCormick building, Chicago.
 INTERNATIONAL RAILWAY GENERAL FOREMEN'S ASSOCIATION.—William Hall, 829 W. Broadway, Winona, Minn. Convention, July 15-18, 1913, Chicago, Ill.
 INTERNATIONAL RAILROAD MASTER BLACKSMITHS' ASSOCIATION.—A. L. Woodworth, Lima, Ohio. Convention, August 18, 1913. Richmond, Va.
 MASTER BOILER MAKERS' ASSOCIATION.—Harry D. Vought, 95 Liberty St., New York.
 MASTER CAR BUILDERS' ASSOCIATION.—J. W. Taylor, Old Colony building, Chicago.
 MASTER CAR AND LOCOMOTIVE PAINTERS' ASSOC. OF U. S. AND CANADA.—A. P. Dane, B. & M., Reading, Mass. Convention, Sept. 9-12, 1913.
 RAILWAY STOREKEEPERS' ASSOCIATION.—J. P. Murphy, Box C. Collinwood, East Buffalo, N. Y. Convention, August 12-15, 1913, Hotel Sherman, Ottawa, Ohio.
 TRAVELING ENGINEERS' ASSOCIATION.—W. O. Thompson, N. Y. C. & H. R., Chicago, Ill.

PERSONALS

It is our desire to make these columns cover as completely as possible all the changes that take place in the mechanical departments of the railways of this country, and we shall greatly appreciate any assistance that our readers may give us in helping to bring this about.

GENERAL

M. K. BARNUM has been appointed general mechanical inspector of the Baltimore & Ohio, with headquarters at Baltimore, Md.

EDWIN G. CHENOWETH has been appointed mechanical engineer in charge of car design of the Rock Island Lines, with headquarters at Chicago. Mr. Chenoweth



Edwin G. Chenoweth.

was born December 18, 1873, at Union City, Ind. He was graduated from Purdue University in 1895, and entered the service of the Erie as a special apprentice, serving later as a machinist. During this time he took a post graduate course at Purdue University and later was air brake instructor and foreman of the air brake department of the Erie at Huntington, Ind. In 1901 he went to the Pennsylvania as draftsman and later held similar positions with the Pere Marquette, Lake Shore & Michigan Southern and the Philadelphia & Reading. He returned to the Erie in 1906 as mechanical engineer, with office at Meadville, Pa., and was appointed assistant superintendent of the car department of the Rock Island Lines in July, 1912, which position he held at the time of his recent appointment.

GEORGE S. GOODWIN has been appointed mechanical engineer of the Rock Island Lines, in charge of locomotive design, with headquarters at Chicago. Mr. Goodwin was born November 29, 1876, at Corinth, Me., and was graduated from Cornell University in mechanical engineering in 1899, having spent his summers in railway shop work and specialized in railway engineering during the final year. In June, 1899, he entered the service of the Chicago, Milwaukee & St. Paul, as a special apprentice at West Milwaukee, Wis., and was later engaged in special test work, etc. He had charge of the company's dynamometer car while engaged in test work, both on the Chicago, Milwaukee & St. Paul and other roads. In May, 1904, he entered the mechanical engineer's office of the Great Northern, at St. Paul, Minn., where he was engaged in work connected with the standardization of locomotive and car details, and also the design of new equipment. In January, 1906, he was appointed chief draftsman of the Chicago, Rock Island & Pacific, at Chicago, and was appointed assistant mechanical engineer at Silvis, Ill., in May, 1910, which position he held at the time of his recent appointment as mechanical engineer.

F. T. HYNDMAN has been appointed superintendent of motive power and cars of the Wheeling & Lake Erie, with headquarters at Cleveland, Ohio.

G. W. LILLIE has been appointed assistant mechanical engineer of the Rock Island Lines at Silvis, Ill., succeeding G. S. Goodwin, promoted.

D. A. MACMILLAN has been appointed assistant general air brake inspector of the Northern Pacific, with headquarters at St. Paul, Minn., succeeding J. M. Boyd, promoted.

WILLIAM M. MITCHELL has been appointed fuel supervisor of the Chicago Great Western, with office at Chicago.

GEORGE S. MCKEE has been appointed superintendent of motive power of the San Antonio & Aransas Pass, with headquarters at San Antonio, Texas.

GEORGE THOMPSON, superintendent of motive power of the Denver, North Western & Pacific, with headquarters at Denver, Colo., remains in the same position with that road's successor, the Denver & Salt Lake.

JOHN H. TINKER, acting superintendent of motive power of the Chicago & Eastern Illinois, at Danville, Ill., has been appointed superintendent of motive power and machinery, with



John H. Tinker.

headquarters at Danville. He was born in August, 1864, at Altoona, Pa., and received a high school education at Altoona and began railway work in July, 1881, as machinist apprentice with the Pennsylvania Railroad. He was made vise shop foreman of the Meadows shops in June, 1896, and in December of the following year was appointed roundhouse foreman at Jersey City, N. J. He again returned to the Meadows shops in December, 1898, as erecting shop foreman, and in January, 1900, was promoted to master mechanic at South Amboy, N. J. He resigned the latter position in November, 1902, to go to the Baltimore & Ohio as master mechanic of the Chicago division, leaving in November, 1903, to become connected with the Model Gas Engine Works as machine foreman. In May, 1904, Mr. Tinker went to the Illinois Central as general foreman at Mounds, Ill., and in May, 1906, left that road to accept the position of assistant master mechanic of the Louisville & Nashville at South Louisville, Ky. Four months later he returned to the Illinois Central as master mechanic at Danville, Ill., and on February 1 of this year he was appointed acting superintendent of motive power. He now becomes superintendent of motive power and machinery, as above noted.

MASTER MECHANICS AND ROAD FOREMEN OF ENGINES

G. O. HUCKETT, road foreman of engines of the Chicago, Burlington & Quincy at Wymore, Neb., has been appointed master mechanic of the Sterling division of that road, with headquarters at Sterling, Colo., succeeding H. M. Barr, resigned.

CAR DEPARTMENT

JOSEPH ACKER, general car foreman of the Rock Island Lines at Horton, Kan., has been appointed superintendent of the car department of the Chicago Terminal division, with headquarters at Blue Island, Ill.

P. H. COSGRAVE has been appointed general car foreman of the Oregon Short Line, with headquarters at Salt Lake City, Utah.

G. A. HULL, chief clerk to the mechanical engineer of the Rock Island Lines, has been appointed assistant superintendent of the car department of the Chicago Terminal division, with headquarters at Blue Island, Ill.

F. H. HANSON, whose appointment as assistant master car builder of the Lake Shore division of the Lake Shore & Michigan Southern was announced in the June issue of the *Railway Age Gazette, Mechanical Edition*, commenced



F. H. Hanson.

railway work with the Lake Shore & Michigan Southern in August, 1891, as a transfer man at Elkhart, Ind., becoming a fireman in October, 1892. In September, 1893, he was made baggageman at Elkhart, and in December, 1894, was appointed car inspector at that point, remaining in that position until March, 1903, when he was appointed night foreman, becoming general foreman at Elkhart in December, 1904. In September, 1908, he was appointed division general

foreman at Collinwood, Ohio, remaining in that position until January, 1912, when he was appointed supervisor of material at Cleveland, Ohio, the position he held at the time of his recent appointment as assistant master car builder of the Lake Shore division.

SHOP AND ENGINE HOUSE

J. W. ACKER has been appointed a gang foreman in the Cedar Rapids roundhouse of the Rock Island Lines, succeeding J. L. Braley.

MILTON E. AMEY, assistant night roundhouse foreman of the Chicago & North Western at East Clinton, Ill., has been appointed night roundhouse foreman at that point, succeeding M. J. DeLacey, promoted.

J. C. BONESTEEL, roundhouse foreman of the St. Louis & San Francisco at Cherokee, Kan., has been transferred in the same capacity to Fort Scott, Kan.

J. A. CARNEY, superintendent of shops of the Chicago, Burlington & Quincy at West Burlington, Iowa, has been appointed superintendent of shops of that road at Aurora, Ill., succeeding A. Forsyth, deceased. Mr. Carney was educated at the Massachusetts Institute of Technology and his entire railway service has been with the Chicago, Burlington & Quincy. He commenced work in October, 1891, as laboratory assistant, and from December, 1894, to April, 1897, was engineer of tests. For four years he was master mechanic of the St. Louis division and in April, 1901, was appointed superintendent of the West Burlington shops, the position he held at the time of his recent appointment.

MARTIN J. DELACEY, night roundhouse foreman of the Chicago & North Western, at East Clinton, Ill., has been appointed assistant day roundhouse foreman at that point, succeeding M. E. Sargent, promoted.

C. A. HENRY, erecting shop foreman of the Chicago, Burlington & Quincy, at Aurora, Ill., has been appointed superintendent of shops at West Burlington, Iowa, succeeding J. A. Carney.

J. R. MORTON has been appointed locomotive foreman of the Grand Trunk Pacific at Melville, Sask., succeeding A. McTavish, transferred.

A. McTAVISH has been appointed locomotive foreman of the Grand Trunk Pacific at McBride, B. C., with temporary headquarters at Tete Jaune, B. C.

A. J. ROBERTS has been appointed locomotive foreman of the Grand Trunk Pacific at Redditt, Ont., succeeding J. R. Morton, transferred.

MERTON E. SARGENT, assistant day roundhouse foreman of the Chicago & North Western at East Clinton, Ill., has been appointed night roundhouse foreman at Clinton, Ia.

S. C. STEWART, acting machine foreman of the Rock Island Lines at Cedar Rapids, Ia., has been appointed machine foreman at that point.

F. S. SCHORNDOFFER, general foreman of the Cincinnati, Hamilton & Dayton, at Ivorydale, Ohio, has been appointed general foreman of the Baltimore & Ohio Southwestern shops at Chillicothe, Ohio, succeeding J. G. Hyson, resigned.

EDGAR E. WHITEHEAD, night roundhouse foreman of the Chicago & North Western at Clinton, Iowa, has been appointed day roundhouse foreman at East Clinton, Ill., succeeding T. A. Slattery, resigned.

PURCHASING AND STOREKEEPING

C. C. ANTHONY, purchasing agent of the Denver, Northwestern & Pacific, with office at Denver, Colorado, retains the same position with that road's successor, the Denver & Salt Lake.

J. H. BIGGS has been appointed purchasing agent of the Chicago & Eastern Illinois, with headquarters at Chicago.

A. E. BUSHNELL, assistant purchasing agent of the Great Northern, has been appointed purchasing agent, with office at St. Paul, Minn.

NEW SHOPS

KANAWHA & MICHIGAN.—A contract has been let for the construction of a wood working shop, 100 ft. x 200 ft., at Hobson, Ohio. The building will be of structural steel and corrugated iron.

YAZOO & MISSISSIPPI VALLEY.—Work will begin at once on the construction of two roundhouses at Nonconnah, Tenn., in connection with plans that provide for later construction of car and machine shops at that point.

RAILWAY EXTENSION IN WESTERN AUSTRALIA.—One of the most important features of the policy of the enterprising government of Western Australia is that of railway extension, by which the new settlers and producers are enabled to get their goods on the markets of the world. At the present time this policy is being pursued. There are now authorized and under construction in Western Australia nine new railways, totaling in length 631 miles. This is in addition to the Trans-Continental Railway, 1,030 miles in length, which the federal government is building to connect the famous mining center of Kalgoorlie with Port Augusta in South Australia, and thereby linking Perth, the chief center of Western Australia, with all the capitals of the eastern states. One of the lines under construction by the state government, that from Wickiepin to Merridin, is a part of the new state railway which is to connect with the Transcontinental Railway at Kalgoorlie. Another important line is that from Wengan Hills to Mullewa, which traverses 83 miles of country, much of it admirably suited for wheat growing; it connects the Murchison Railway with the Eastern Goldfields Railway. The other lines under construction are being taken into new agricultural districts with the object of promoting settlement and development.

SUPPLY TRADE NOTES

G. Haven Peabody has been appointed a western representative of the Lima Locomotive Corporation, with headquarters at 520 McCormick building, Chicago.

The Star Brass Manufacturing Company, Boston, Mass., has opened an office at 6 East Lake street, Chicago, in charge of Arthur F. Mundy, western representative.

John U. Higinbotham, formerly assistant treasurer of the National Biscuit Company, has been appointed assistant treasurer of the Detroit Lubricator Company, Detroit, Mich.

The Baldwin Locomotive Works has awarded a contract to the H. A. Strauss Company, Chicago, for the heavy concrete construction work on the new locomotive plant at East Chicago, Ind.

J. G. Bower has resigned as sales manager of the Hale & Kilburn Company, at Chicago, to become manager of the New York office of the Buckeye Steel Castings Company, Columbus, Ohio.

W. E. Jenkinson has been appointed railroad representative for S. F. Bowser & Co., Incorporated, covering the territory vacated by E. F. G. Meisinger, and in addition, the southwestern and Pacific coast territory.

A. C. Moore, general manager of the Safety Car Heating & Lighting Company, New York, has been made vice-president of that company, with office in Chicago. He will have entire charge of the western business of the company.

Judge Snediker, on June 23, appointed Charles L. Harrison receiver and H. M. Estabrook co-receiver for the Barney & Smith Car Company, Dayton, Ohio. Mr. Estabrook is president of the company. The receivers were appointed on the application of Joseph Brothers & Co., Cincinnati, Ohio, creditors to the extent of \$11,139. E. F. Platt, a stockholder of the Barney & Smith company, gave out a statement that the company was perfectly solvent and that the trouble had been caused by the recent floods.

The Canadian General Electric Company, Ltd., which owns and controls as subsidiary companies the Canada Foundry Company, Ltd., and the Canadian Allis-Chalmers, has decided to consolidate the selling organizations of the two latter companies, dropping the name Canada Foundry Company, Ltd., and conducting the selling organizations of both companies under the name of Canadian Allis-Chalmers, Ltd. Hereafter all sales of electrical apparatus and supplies will be in the name of the Canadian General Electric Company, Ltd., and all general engineering contracts and sales of mechanical appliances in the name of Canadian Allis-Chalmers, Ltd.

John L. Nicholson has been elected director, vice-president and general sales manager of the Locomotive Arch Brick Company, with headquarters at 1201 Chamber of Commerce building, Chicago. Mr. Nicholson was connected with the Chicago & North Western for 13 years as fireman, engineer and roadforeman of engines. He entered the employ of the American Locomotive Equipment Company in 1904, after that company had purchased the Wade-Nicholson Hall Arch, of which he was one of the inventors, and he has had a great deal of experience in the development of the brick arch to its present state of efficiency. When the American Arch Company was formed and took over the business of the American Locomotive Equipment Company, he was appointed southern sales manager, which position he held to May 1, this year.

C. A. Coffin has resigned his position as president of the General Electric Company, Schenectady, N. Y., and has been made chairman of the board of directors. Edwin Wilbur Rice, Jr.,

senior vice-president and a director of the company, has been made president, succeeding Mr. Coffin. Mr. Coffin was one of a group, who, in 1882, bought control of the American Electric Company, New Britain, Conn., which had been founded in 1880 by Professor Elihu Thomson. This company made arc-lighting apparatus under the Thomson-Houston patents. The plant was moved to Lynn, Mass., and the name of the company was changed to the Thomson-Houston Company. The company grew rapidly under the administration of Mr. Coffin. In 1892, the Thomson-Houston Company was consolidated with the Edison General Electric Company under the name of the General Electric Company, with Mr. Coffin as president. It was he who brought about the agreement between the Westinghouse Electric & Manufacturing Company, Pittsburgh, Pa., and the General Electric Company in regard to the exchange of licenses under their respective patents, by which a long struggle over patents was avoided and large sums of money saved. Mr. Coffin foresaw that a large amount of capital would be necessary for the growth and expansion of electrical undertakings and was largely responsible for the education of investors to a correct appreciation of the value of securities of electrical enterprises. For this reason the present development of electrical public utilities is largely due to the efforts of Mr. Coffin.

E. W. Rice, Jr., who has just been elected president of the General Electric Company, Schenectady, N. Y., as mentioned above, was born at La Crosse, Wis., May 6, 1862. After gradu-

ating from the Central High School of Philadelphia Mr. Rice became associated with Professor Thomson as assistant and confidant in the American Electric Company, New Britain. When this company was moved to Lynn in 1882, Mr. Rice went with it. In 1884 he was made superintendent and soon after technical director in charge of manufacturing. Shortly after the organization of the General Electric Company Mr. Rice was promoted to the position of chief engineer of that company. He was made third vice-president in



E. W. Rice, Jr.

1896, having charge of the technical and manufacturing departments. In 1903 he was made a director and subsequently became senior vice-president of the company. Over one hundred patents have been issued in his name. Mr. Rice was instrumental in the development of high tension apparatus, the successful transmission of power at extra high voltages, and did much to improve the design of the rotary convertor and the revolving field generator, as well as electric traction equipment. Mr. Rice is a member of the American Institute of Electrical Engineers, the Institute of Civil Engineers, the Institution of Electrical Engineers of Great Britain, and a member of the Engineers' Club of New York. After the Paris exposition in 1900 he was created Chevalier of the Legion of Honor. In 1903 the degree of A. M. was conferred on him by Harvard University, and in 1906 he was given the degree of D.Sc. by Union College, Schenectady.

RUSSIA'S PURCHASE OF RAILWAYS.—The Budget Committee of the Duma has agreed to the early purchase of the Moscow-Kasan Railway, and has expressed a wish that a bill for the purchase of the Lodz-Raisan-Ural Railway be drafted.

CATALOGS

GAS ENGINE.—A new design of horizontal, single cylinder, gas engine that is built in sizes from 10 to 30 horsepower is described in a leaflet issued by the Producers' Supply Company, Franklin, Pa.

FOUNTAIN DRAWING PEN.—The Smith fountain drawing pen is described in a leaflet prepared by Keniff & Esser Company, New York. The ink in this pen is contained in a rubber reservoir within the handle and is fed to the blade in any desired quantity by a slight pressure of the finger on a conveniently placed lever.

WRECKING FROGS.—Fewings wrecking frogs are briefly illustrated and described in a leaflet issued by the Railway Appliances Company, Chicago. These frogs are made of open hearth cast steel, which is well annealed, and are formed to lines that a long service has shown to be satisfactory for rerailling cars and locomotives under difficult conditions.

TOBIN BRONZE.—When a material is desired that combines great strength with ability to resist corrosion and rusting, Tobin bronze has many advantages. Some of the purposes for which it can be used to good advantage and tables showing the physical and chemical properties of the material are given in a booklet being issued by the American Brass Company, Ansonia, Conn.

BRUSHES FOR DYNAMOS AND MOTORS.—Joseph Dixon Crucible Company, Jersey City, N. J., is issuing a booklet devoted to a discussion of the advantages of graphite brushes for dynamos and motors. These brushes are composed almost entirely of a high grade graphite, and have the advantage that they do not require lubrication, nor do they gum up the commutator. The booklet includes a price list.

LUBRICATORS.—A 56-page, fully illustrated catalog, issued by the Detroit Lubricator Company, Detroit, Mich., is devoted exclusively to the Bullseye locomotive lubricators and other locomotive specialties. The subject is presented in an interesting and complete manner and the different designs and sizes of lubricators manufactured by this company are fully illustrated and described. The latest developments in locomotive lubricator practice are discussed.

INDUSTRIAL LIGHTING.—The first twenty-five pages of Bulletin No. 47 from the Cooper-Hewitt Electric Company, Hoboken, N. J., are devoted to a comprehensive survey of the basic facts concerning artificial lighting and its application to industrial illumination. This treatise is well illustrated and consists quite largely of extracts from the works of recognized authorities on the subject. In the last chapter the advantages of the Cooper-Hewitt lamp for this purpose are discussed.

STEEL ARMORED HOSE.—Catalog No. 521 of the Sprague Electric Works of the General Electric Company, New York, is devoted to the Sprague flexible steel-armored hose for railroad service. Its advantages for air brake hose are given particular attention. The same material has decided advantages for use as a tank or a tender hose and for a washout or blower hose in the roundhouse. The catalog includes a full description of the methods of manufacture and the application of the armor.

BOILER MAKERS' TOOLS.—Several types of hand operated and power driven roller expanders, sectional expanders, and flue cutting machines for either boiler tubes or flues are described in the latest catalog from the J. Faessler Manufacturing Company, Moberly, Mo. This company has made a specialty of tools of this kind for the past thirty years and has developed designs of decided merit. One of the features of this catalog is the description of a safety sectional expander with a quick acting knockout.

FUEL COSTS.—An interesting discussion of the comparative cost of burning fuel oil, producer gas, natural gas and powdered coal in furnaces is included in a leaflet issued by Tate, Jones & Com-

pany, Pittsburgh, Pa. The items considered in this comparison are the cost of the fuel, cost of plant, cost of erection, floor space required, interest on investment, taxes, depreciation and repairs, labor needed to operate, power needed, cost of water and reliability. Each is considered at some length and for different sizes of plants.

PNEUMATIC DRILL.—Some slight improvements have recently been made in the "Little Giant," pneumatic drill manufactured by the Chicago Pneumatic Tool Company, Chicago. The improved machines are very fully illustrated in bulletin No. 127 now being issued by that company. In the forty pages of this bulletin is shown a complete line of pneumatic drills for either metal or wood working. Many of them are reversible. Tables are given showing the general dimensions, speed, air consumption and capacity of each different design illustrated.

EFFECT OF SOOT.—While it is generally understood that a coating of soot considerably reduces the evaporative qualities of a boiler, it is doubtful if it is fully appreciated that a coating 1/16 in. thick will decrease the heat conductivity of a boiler plate over 26 per cent. The amount of loss due to various thicknesses of soot coating, together with a full discussion of the whole subject in all its phases, is contained in a paper by Dr. S. J. Herman, which is being reprinted and issued by the Diamond Specialty Company, 80 First street, Detroit, Mich.

CURTAIN WINDOW VENTILATOR.—A device for closing the opening at the bottom of an open window in passenger or sleeping cars is described in a leaflet being issued by the Gold Car Heating & Lighting Company, New York. It consists of a narrow heavy curtain mounted on a spring roller inclosed in a metal case. This case is secured in a vertical position at one side of the window frame at the bottom and the curtain is drawn across and hooked on a peg at the opposite side, closing the opening at the bottom from direct drafts but allowing the air to pass up behind it. It is also suited for use in offices and dwelling houses.

ECONOMY UNCOUPLING DEVICE.—Spencer Otis Company, Chicago, Ill., is issuing a leaflet illustrating and describing the Economy uncoupling device which consists of the fewest possible number of parts for a satisfactory uncoupling arrangement. It has a single rod in one piece and two malleable iron brackets for each end of the car. The rod is slipped through the brackets and pin before they are bolted or riveted to the car. It couples direct to the coupler lock and the effect of the movement of the coupler head is taken care of by a telescopic bracket which allows a total horizontal movement of seven inches without causing any strain on the lock.

WEATHER TEST OF PAINT.—In 1906 the Pennsylvania completed a steel, double track, deck-bridge across the Susquehanna River near where it joins the Chesapeake Bay. This bridge has a length of nearly a mile and when it was ready for painting, it was recognized by certain engineers of the American Society for Testing Materials that the convenience of location offered an unusual opportunity for a time test of different formulas of metal protective paint. These tests were carried out with the utmost care and in addition to the bridge structure itself, sample steel plates were also exposed on the bridge. A booklet issued by the Lowe Brothers Company, Dayton, Ohio, fully describes these tests and includes the reports of the experts who had them in charge.

CASE-HARDENING AND HEAT-TREATING.—An unusually good selection of useful information and practical rules on the case-hardening and heat-treating of steel is found in the fifth edition of a bulletin being issued by the Ideal Case-Hardening Compound Company, New York. This book discusses some of the most interesting properties of iron and steel, explains fully the theory of case-hardening operations, describes the best equipment in use; fully explains how to pack the material to be hardened, the time it should be heated, the depth of the penetration, how to reheat, anneal, etc. One of the sections is devoted to alloys and impuri-

ties and their effects on the steel. Each is discussed separately and at some length. A section is also devoted to a discussion of the best substitutes for costly alloy steels.

WATER WEIGHER.—The Kennicott Company was recently awarded the John Scott legacy medal by the City of Philadelphia, on the recommendation of the Franklin Institute, for its water weigher or measuring device. This weigher consists of a shell, the lower part of which is divided in two measuring or weighing compartments and a tipping box composed of two halves which alternately fill with water and serve the double purpose of furnishing a sufficient quantity of water to start the siphon in the weighing compartment and to shift the supply from one compartment to the other. This tipping box is balanced on steel pivots, or knife edges, is mounted directly above the weighing compartment and is operated by floats, one in either compartment. A counter is provided for registering each double unit charge delivered by the weigher, and in this way the record is maintained. The weigher is fully illustrated and described in bulletin No. 38 from the Kennicott Company, Chicago Heights, Ill.

MIKADO LOCOMOTIVES.—Bulletin No. 1013 from the American Locomotive Company, New York, is devoted to a discussion of the Mikado type locomotive. The advantages of this type for freight transportation are briefly considered on the first page and a table is included giving the results of comparative service tests made on seven different railways between Mikado and consolidation type locomotives. This shows the increase in the amount of train load and the decrease in coal and water consumption that has been made possible by the introduction of this type. A full list of dimensions of twenty-four different designs of these locomotives, built by this company for various railways, is given in the next two pages of the pamphlet. Following are illustrations of sixteen different Mikado type locomotives, each accompanied by a table showing the amount of tonnage behind the tender it is able to pull at various speeds from 5 miles to 30 miles per hour and at various grades up to one per cent. These figures are based on the maximum tractive effort at different speeds with cars of 70 tons gross lading and a frictional resistance of three pounds per ton on the level.

RAILWAY DIFFICULTIES IN ARGENTINA.—Notwithstanding the remarkable progress which is manifested year by year by the great majority of Argentine railways, some of the troubles from which they have suffered, almost from the beginning of their successful career, have still to be faced. Among these difficulties may be included the native jealousy which exists in regard to foreign enterprises and which it would appear is most difficult to overcome. This jealousy manifests itself in particular in the relations existing between the companies and the municipalities; so acute is this at times that several important improvements had to be abandoned, and as a consequence the public suffers and the companies sustain financial losses. A case in point is the dispute which of late has raged between the Central Argentine Railway and the Cordoba municipality. It had been the wish of the company to erect a handsome station in the city of Cordoba. From the commencement, however, the company has met with scant consideration from the municipality; on the contrary, a spirit of opposition has been displayed even in regard to the most simple matters. At length the patience of the company has been exhausted and the board of directors in London, acting upon information sent to them from Cordoba, have telegraphed instructions to their local representatives in Cordoba, to suspend all work upon the new station building, to sell the materials already received and to dismiss all the workmen employed. The directors' action was precipitated by the persistent and unreasoning difficulties placed in the way of progress by the municipality, especially in regard to the matter of approaches to the new station building. While the interests of the company are bound to suffer by this drastic decision, those of the traveling public will be more seriously affected still.

Railway Age Gazette

MECHANICAL EDITION
INCLUDING THE
AMERICAN ENGINEER

PUBLISHED ON THE FIRST THURSDAY OF EVERY MONTH BY THE
SIMMONS-BOARDMAN PUBLISHING COMPANY,
WOOLWORTH BLDG., NEW YORK, N. Y.

CHICAGO: Transportation Bldg. CLEVELAND: Citizen's Bldg.
LONDON: Queen Anne's Chambers, Westminster.

EDWARD A. SIMMONS, *President.* L. B. SHERMAN, *Vice-President.*
HENRY LEE, *Secretary.*
The address of the company is the address of the officers.

ROY V. WRIGHT, *Editor.* R. E. THAYER, *Associate Editor.*
E. A. AVERILL, *Managing Editor.* A. C. LONDON, *Associate Editor.*
GEORGE L. FOWLER, *Associate Editor.*

Subscriptions, including the eight daily editions of the *Railway Age Gazette* published in June in connection with the annual conventions of the Master Car Builders' and American Railway Master Mechanics' associations, payable in advance and postage free:

United States, Canada and Mexico.....	\$2.00 a year
Foreign Countries (excepting daily editions).....	3.00 a year
Single Copy	20 cents

Entered at the Post Office at New York, N. Y., as mail matter of the second class.

WE GUARANTEE, that of this issue 4,400 copies were printed; that of those 4,400 copies, 3,800 were mailed to regular paid subscribers and 125 were provided for counter and news companies' sales; that the total copies printed this year to date were 37,526—an average of 4,691 copies a month.

VOLUME 87. AUGUST, 1913. NUMBER 8.

CONTENTS

EDITORIALS:

The Tool Foremen's Convention.....	405
A Competition on Grinding.....	405
Traveling Safety Exhibit.....	405
Railway Storekeepers' Association.....	406
The General Foreman's Convention.....	406
New Books.....	408

COMMUNICATIONS:

Underpowered Machine Tools.....	408
Truck Equalizer Design.....	408

GENERAL AND SHOP PRACTICE:

Powerful Mikado on the Reading.....	411
Planioz Taper Flanges on Driving Boxes.....	414
General Foremen's Convention.....	415
Bronze Liners for Crossheads.....	428
Installation and Maintenance of Electric Headlight Equipment.....	429
Railway Tool Foremen's Convention.....	431
Tractive Effort Chart.....	436

CAR DEPARTMENT:

Improved Methods of Freight Car Construction.....	437
Fifty-Ton Steel Hopper Car.....	439
Tests of Alcohol Heater Car.....	441
Car Repair Notes from the Norfolk & Western.....	442
Tables for Designing Center Sills.....	444
Tank Car Design.....	445

NEW DEVICES:

Wheel Press Recording Gage.....	447
Convertible Seat for Compartment Cars.....	447
Turntable Tractor.....	448
Safety Squirt Hose.....	449
Automatic Shut-Off Valve.....	450
New Locomotive Driving Wheel.....	450
Baxter Charcoal Car Heaters.....	451
Welding and Cutting with Oxygen and Illuminating Gas.....	452
Quadruple Combination Machine.....	452
Universal Blow Torch.....	453
Ball Bearings in Axle Lighting Generators.....	453
Automatic Train Pipe Connector.....	454
Compensating Quadrant Crane.....	455
Safety Axle Generator Suspension.....	456
Osman Boiler Check.....	456

NEWS DEPARTMENT:

Notes.....	457
Meetings and Conventions.....	457
Personals.....	458
New Shops.....	460
Supply Trade Notes.....	460
Catalogs.....	461

The Tool Foremen's Convention

The Railway Tool Foremen's Association is proving to be more of a success than was generally anticipated when it was first organized. It is doubtful if there is a single member who attended the last convention that went home without feeling amply repaid for the time and expense of the trip. The discussion on every paper was lively, ideas were freely exchanged, and close attention was given directly to the subject at hand. While the field of interest of the tool foremen is comparatively limited when viewed from the standpoint of some other railway officers, still subjects of considerable importance that are entirely within their province can be found in sufficient numbers to furnish subjects for discussion for this association for a long time to come.

As an evidence of the intention of this association to occupy an influential position in its field, the action in adopting a definite recommendation for the form of thread and the taper for the boiler studs is an example. After thoroughly discussing the subject at two different conventions, the members at the last meeting unanimously recommended the adoption of the U. S. standard thread, 12 threads per inch, for all studs and plugs in a boiler with the exception of the staybolts. It further recommended a standard taper of 3/4 in. in 12 in. for all studs.

The other subjects on which papers were presented, together with an outline of the discussion will be found in the report of this convention elsewhere in this issue.

A Competition on Grinding

Grinding processes have grown more and more important in railway shops in recent years, and in order that our readers may be fully informed as to the best practices and latest developments we have decided to announce a competition on that subject to close October 1. Those wishing to compete have a wide range of subjects to select from. What developments have been made in your shop in improving the efficiency of the various grinding machines and what new classes of work are being finished by grinding which were finished otherwise a few years ago? Have you been able to get better results by adding to the number of ordinary grinding wheels, or rearranging them so that they are placed more conveniently for the workmen who have use for them? What classes of work are done on your gap grinders and how does it compare with machine work? Do you use a grinding machine for smoothing off car wheels and with what results? Is it a paying proposition? How about grinding the journals on car and locomotive axles? Is it productive of better results and longer life to the axle? What measures have you taken to safeguard the grinding wheels? Do you use the best type of grinding wheel for each of the different classes of work, and what tests or experiments have you made to determine the best wheel for each job? Are you doing any special work in the way of surface grinding? These are only a few suggestions as to possible subjects upon which articles might be written. You may know of others that are possibly of even greater interest. A prize of \$35 will be given for the best article and such others as are accepted for publication will be paid for at our regular rates.

Traveling Safety Exhibit

As part of the campaign it is pursuing with splendid results, the safety department of the New York Central & Hudson River has prepared a safety exhibit car which is modeled somewhat on the plan of the air brake instruction cars and will be used in a similar manner. The exhibit car consists of a standard baggage car which has been furnished in white enamel on the inside and fitted with improved lighting facilities. Running along each side, about 3 ft. from the floor, is a mahogany shelf on which are mounted a large number of models. Above these are a double row

of photographs. On one side of the car there are over 100 photographs which show unsafe practices which commonly cause accidents that result in the injury of employees, and alongside of each picture is another showing the safe practice which, if followed, would have prevented the accident. This collection of photographs is based on those causes which statistics, covering the past two years, show to have been the most prolific sources of accident. Other photographs show how trespassers are killed and injured and it is the intention, as the car is taken over the road, to call the attention of the various magistrates, who will be invited to visit it, to these photographs in particular. The models show the construction of safeguards to shop machinery, locomotives, turntables, transfer tables, stairways, etc.

Accompanying this car will be another special car arranged with seats and a platform for lectures. These two cars will be taken over the entire New York Central System, visiting first the more important division and terminal points and later going to the smaller places. Every employee will be required to visit this car and lectures will be given at regular intervals. It is thought that the plan of giving the lectures in these cars is preferable to presenting them in a hall hired for the purpose, as in this case the men will feel free to attend in their working clothes and without special preparation.

During the first four months of 1913 on the New York Central & Hudson River and the Lake Shore & Michigan Southern there were 35 fewer employees killed on duty than during the same period of 1912. When it is understood that the locomotive mileage increased 2 per cent. on the New York Central and 8 per cent. on the Lake Shore in this period, the work of the safety department can be well appreciated. There are at present over 60 division safety committees on the New York Central Lines, with a membership of about 900 men. Each member serves six months.

Railway Storekeepers' Association

In the June issue of the Mechanical Edition of the *Railway Age Gazette* appeared an editorial concerning the recent convention of the Railway Storekeepers' Association.

The Railway Storekeeper, the official journal of that association, reprinted this in its July issue, with the following comment:

"The article will no doubt prove interesting reading to any member of the association, many of whom unconsciously divert their remarks when on the floor of the convention from the regular topic under discussion, which means a considerable loss of time and in many instances, men who should speak on the subject and would confine themselves to the matter immediately under discussion are deprived of sufficient privilege.

"It is difficult for the presiding officer of a convention consisting of several hundred representatives, to call a speaker to order, and every member should make it a special feature, when arising to discuss any topic, to confine himself to the subject under discussion. Many times we go from the subject because we are too much wrapped up in our individual organization. We should learn that at the annual conventions, we are discussing the subjects at large and not as any individual road or individual methods.

"Many of our speakers arise to discuss a paper and begin with the practices on their railroads. This is entirely irrelevant on the floor of a convention, because after the paper is distributed and discussed, any members desiring to obtain the methods as to individual lines has the privilege, but it should not involve the association as a whole on the convention floor. Matter during that period embraces the territory represented, which means the entire country and not any individual line or system.

"We, as storekeepers, should appreciate this editorial and criticism, which it is intended to be, and is absolutely for the good of the association. We can well afford to profit by it. It is a severe lesson, but, were the association not worthy of such notice, it is entirely possible the editor of the mechanical edition of the *Gazette* would not take the trouble to so criticize.

"Every member should procure a copy of the June issue of this paper, as well as the *Railway Age Gazette* [May 23, 1913], and notice the amount of comment that these two prominent railroad papers have devoted to the storekeepers' work, as a result of the matter discussed at the last meeting."

The Railway Storekeeper is right in its statement that we do consider the Storekeepers' Association an organization of importance to the railways of this country, and that it is our aim

to further its best interests in any way we can, as we do any other similar association that is working toward the solution of the problems confronting the railways today. The storekeepers', however, is not the only association to which this criticism can be justly applied, and nearly all of the so-called minor mechanical associations offer opportunities for a large improvement in many directions, if they are to accomplish the results that should be fairly expected of them.

The General Foremen's Convention

It is seldom that an association has better and more timely papers on subjects of especial interest and importance than was the case at the convention of the General Foremen's Association held last month in Chicago. In view of this, it was a distinct disappointment that the members did not make more of their opportunity for a thorough discussion of these papers. This was particularly true in connection with the two most important subjects that were presented, *viz.*, Shop Schedules and Apprenticeship. There are probably no two features of a general nature that should be of more interest to a progressive general foreman than these, and it would have been reasonable to expect that extra sessions would be required to give time for their discussion. They, however, were allowed to pass with but little comment, especially the former. Although the excellent lantern slides which accompanied the paper on apprenticeship, were repeated, they appeared to arouse but little interest and did not even bring out any questions. This unsatisfactory result can not in any way be blamed on the presiding officers, who did everything in their power to enliven and broaden the discussions, but seemed to be the result of a desire on the part of the majority of the members to listen rather than to talk. The subjects of a less general nature and of decidedly less importance to the railroad company were not subject to the same criticism, and the discussions on driving box work and repairs to superheater locomotives were lively and prolonged. The same would probably also have been true on the subject of engine house efficiency if an opportunity had been given for its discussion. All this would indicate that the most successful conventions of this association will occur when subjects of a specific rather than a general nature are presented. It is probable that the program for next year will take cognizance of this fact.

* * * *

Although the discussion on the subject of Shop Schedules may have been disappointing, the paper by Henry Gardner of the New York Central & Hudson River was most satisfactory and forms a valuable addition to the proceedings of the association. Mr. Gardner points out that the scheduling and routing of work in a railroad repair shop is not by any means a new idea; and also that his system does not differ from previous ones in its general principles, but that it is distinctly different in its design and application. The transportation department of a railroad depends on the exact adherence of a train to its schedule and it is strange that with this perfection of system in one department of a railroad, another department has been allowed to use inexact and guess work methods. A railroad shop cannot be operated to realize the maximum efficiency without some form of clearly defined scheduling and routing plans. In devising his system, Mr. Gardner has carefully arranged so that it will not displace any portion of the arrangement of the existing organization in the shop, and, further, that it will be maintained by the regular shop force.

This system, in general, provides first for the routing, or the determination of the path over which the material will travel in its natural course through the shop, and then scheduling it or listing the order of dates for each stop and start of any part from the time it leaves the erecting shop until it is again returned for completing the engine. The

problem of scheduling and routing finally resolves itself into the very simple result or object of providing a proper pre-determined date or day of the month when each part or group of parts will arrive at and leave the various departments comprising the path over which it is to travel and finally arrive at the erecting shop when wanted. In the same manner the principal operations necessary to assemble the engine in the erecting shop are also subdivided and given dates in the proper order for their completion. Naturally a very careful investigation must be made to allow sufficient, but not excessive, time for the work on each part, but the records already maintained in most shops will allow this to be done with sufficient accuracy to introduce the system. One of the advantages of the whole plan is its flexibility and it is a simple matter to correct mistakes and continue to perfect the time allowances as experience is gained.

Mr. Gardner states that after a trial of 15 months in the West Albany shops of the New York Central & Hudson River this system has helped to bring about many beneficial results. The shops are now more equalized; departments under or over supplied with men have been reorganized so that they are in harmony with the entire plant. A better feeling prevails in all departments; men are not unexpectedly called on to work at night and the friction between departments is reduced to a minimum. The system is as successful under piece work as with day work. In fact, the piece workers are strongly in favor of it, as their work is laid out ahead and they know exactly what they have to do and what their compensation will be for several days ahead. The foremen praise the system since it relieves them of unexpected censure and when the blame is placed, it hits the right man and he always knows it is coming. The general foreman's duties are now much less complex. Under the older methods he might go from one department to another trying to fix the responsibility for delay and receive all sorts of explanations, but under the present system the daily delay sheet gives him the exact information as to just what is holding up the engine and which department is to blame. The foreman's duties now become not so much a matter of seeing personally that each man is provided with work and that no work is delayed, as that of passing on the quality of the work and giving instructions as to the best and quickest way of doing it. In answer to the usual argument raised against systems of this kind, that the cost of clerical or non-productive labor is much greater than the benefits derived and the money saved, it is pointed out by Mr. Gardner that one competent man with shop experience and an assistant for office work and checking is all the force required with this system to route and schedule successfully all the principal operations and material for repairing 90 engines a month. In a small shop it would not require the full time of the special man, as most of the forms could be made out by the foremen or sub-foremen.

* * * *

The reason for the general interest throughout the country in the proper training of apprentices was well explained by F. W. Thomas when he stated, in an individual paper, that the modern shop offers little advantage for a boy without someone to guide and direct him. A boy floundering around in a big modern shop for four years with no kindly hand to help or direct is what caused the failure of the old apprenticeship system. The apprentice in a great majority of cases, was a failure, and at the end of four years he knew next to nothing of the trade. The modern methods have changed all of this, and on the Santa Fe it is found that a boy, with the assistance of his shop instructor, will become productive even at the beginning of his course. Quoting Mr. Basford the speaker said that, "the present shop needs more instructors and fewer inspectors." In spite of these well known facts, there are comparatively few railroads seriously undertaking the comprehensive training of their ap-

prentices. Properly trained apprentices is one of the most valuable assets a general foreman can have, and it is to be hoped that, even if they did not care to say anything on the subject, sufficient thought was given it to start a broader movement toward real apprenticeship.

In its report, the committee presented eleven more or less well known principles of successful apprenticeship, and in addition it strongly urged the necessity of having adequate instructors for the shop and not confusing this part of the boy's education with the schoolroom work. This is undoubtedly one of the most important features of the whole course. It must be remembered that you are teaching a boy a trade, not giving him a liberal education. Thorough shop instruction without any schoolroom work is preferable to schoolroom work without any shop instruction, and it is only by the proper balancing of the two that the best results can be obtained.

* * * *

One of the most comprehensive discussions of the engine-house problem that has ever appeared, was the paper presented by Walter Smith which, unfortunately, was not opened for discussion. The paper discusses the organization, operation, equipment and facilities of enginehouses in a most thorough manner, and includes many excellent suggestions and ideas. It deals with so important a subject and is so carefully prepared that it has not been found possible to bring it down to a length which will permit it to be included in the space limits of this issue, and therefore it will appear in almost its complete form, in the September issue of this journal.

* * * *

There were very few new ideas brought out in the comparatively lengthy discussion on repairs to driving boxes. There are evidently a number of different ways of doing this work which give successful results and are satisfactory to their users. In view of the many evident advantages where a solid brass is used, it is rather surprising to find how few roads are using a crown brass and hubplate cast in place in the box, a practice which has had a thorough trial with splendid results on the Lake Shore & Michigan Southern. But one speaker—and he a representative of the Lake Shore—mentioned using this practice. The decided reduction in the amount of machine work and the opportunity to use a better material for the bearing metal would seem to strongly recommend this method and design to a general foreman.

Success is reported by the few roads that have had experience with driving boxes with removable brasses. There are now several designs of this type of driving box available and it is quite probable that the future will see many more of them put in service. The opportunity to reduce the delay in the engine-house is a very appealing feature of this design.

* * * *

It is quite evident that the ingenuity of the foreman and workmen in the railway shop is fully capable of coping with any difficulties that may arise in connection with the maintenance of superheater locomotives. On the whole it is rather surprising that so few difficult problems have arisen in this connection and while trouble has been found with some of the features of design, comparatively little difficulty was reported in solving the problems of maintenance. It has been found advisable to use greater care in the machining and fitting of both the valve and piston packing rings and in insuring the accuracy of the circle on the inside of the cylinder and valve chamber bushings and the insurance of the freedom of the flow in the oil pipes and passages. Beyond this, however, comparatively little change has been necessary in the method of repairs to the machinery. In the boiler the proper method of safe ending and applying the large superheater tubes is now pretty well understood and the problems arising with the superheater itself have been comparatively minor, although the damper has given some trouble.

NEW BOOKS

Entropy-Temperature and Transmission Diagrams for Air. By C. R. Richards. Bulletin No. 63, Engineering Experiment Station, University of Illinois. Illustrated. Bound in paper, 6 in. x 9 in. Published by the University of Illinois, Urbana, Ill. Price, 25 cents.

This bulletin presents the theory and use of an entropy-temperature and an entropy-log temperature diagram, by the aid of which all problems pertaining to the expansion and compression of air may be solved graphically; and an air transmission diagram for determining graphically the size of pipe required to transmit a given quantity of air through a given distance with any assumed loss of pressure. It further discusses the conditions affecting the maximum power which may be transmitted through pipe lines carrying compressed air, and the general efficiencies of power and pressure transmission.

Calculus, An Elementary Treatise on. By W. S. Franklin, Barry MacNutt and Rollin L. Charles of Lehigh University. Bound in cloth, 273 pages. 5½ in. x 8 in. Illustrated. Published by the authors at South Bethlehem, Pa. Price \$2.00.

This book is intended as a text book for colleges and technical schools and the authors have endeavored to develop the subject as simply and as directly as possible in order to lead the students to a clear understanding of its principles. The importance of extensive practice in the handling of algebraic transformations has not been overlooked and an adequate collection of formal problems in differentiation and integration are included. These however are, in the most part, collected in the appendix in order not to break the thread of the discussion in the text by unnecessary algebraic developments. No claim is made for the completeness of this book, and throughout the text references to more complete treatises have been introduced, and an appendix is included which gives a carefully selected list of such works on mathematics and mathematical physics. The authors point out that they have used the idea of infinitesimals throughout the text because of their belief that this method contributes very greatly to directness and simplicity of speech in the discussion of physical problems and not because they are convinced of its accuracy.

Diesel Engines for Land and Marine Work. By A. P. Chalkley. Second edition. Bound in cloth, 226 pages. Illustrated. 5½ in. x 8½ in. Published by D. Van Nostrand Co., 25 Park Place, New York. Price, \$3.00.

There are already some three hundred vessels in service propelled by Diesel engines, and the indications are that this number will soon be materially increased. On land, this type of prime mover has already attained a great popularity, particularly in Europe, and it is probable that its use in this country will be considerably extended within the next few years. This book, the first to deal exclusively with this subject, is therefore of especial interest at this time. In view of the commercial importance of the subject, the author has endeavored to prepare the book so as to render it suitable for all those who, for widely differing reasons, find it necessary to become acquainted with this type of gas engine. While this necessitated the including of a certain amount of elementary matter for the aid of the non-technical reader, technical discussion has by no means been eliminated and the engineer of experience will find that it will completely answer his requirements. In the first chapter the general theory of gas and oil engines, with special reference to Diesel engines, is fully discussed. The second chapter deals with the action and working of the Diesel engine, while the third considers its construction. In the fourth chapter the installing and running of these engines is given considerable space, and the fifth chapter deals with testing. A general discussion of the marine type of Diesel engine is given in chapter six, and chapter seven considers the construction of this special arrangement. The future of the Diesel engine is considered in the last chapter.

COMMUNICATIONS

UNDERPOWERED MACHINE TOOLS

NEW YORK, July 11, 1913.

TO THE EDITOR:

In our endeavor to secure the maximum possible output at a minimum cost, we are continually hampered with underpowered and poorly designed tools. To secure the maximum product from a machine tool, it is extremely important in selecting it to be sure that there is sufficient rigidity of construction and adequate provision for power. The advances in steels have been so rapid that the machine tool builders have had great difficulty keeping pace with the progress. This is particularly true of drilling machines, which are run at speeds and feeds unheard of a few years ago.

A mistake that for some reason is often repeated is that of failing to supply sufficient power to drive a machine tool to its utmost capacity. This mistake very often takes the form of a cone pulley entirely too small to transmit the required power. Frequently the driving pulley on the countershaft and the largest step on the cone are the same width and the same diameter. As the drive belts are never found to be too large this means a shortage of power on all steps of the cone except the largest. In some cases the pulleys are the same diameter and the face of the cone is narrower than the drive pulley, which means lack of power throughout.

It is seldom that as many mistakes are found in one machine as were recently noted on a radial drilling machine. As improvements are made by correcting mistakes, there may be some gain in calling attention to these. Although this machine was manufactured in 1912 by a well known firm it is entirely unsuited to modern machine shop practice. The speeds are as follows: 207, 129, 83, 53.8, 51.8, 32, 20.8, 13.4 r. p. m., while the feeds are: 0.0128, 0.0081, 0.0066 in. per revolution.

Just what purpose the maker expected this machine to serve is hard to tell. The speeds are about right for high-speed drills, ranging in size from 1 in. to 9 in., or for carbon drills from ½ in. to 6 in. Even then most of the drills would be running at improper speeds on account of the peculiar ratio and the fact that there are practically only seven speeds, the difference between 51.8 and 53.8 being too slight to be useful.

The largest possible drill that can be taken by the machine is 2 in. and it lacks power to drive that size up to full capacity. The driving pulley is 14 x 3½ in. and the largest step on the cone pulley is 14 x 2½ in., thus making the available power that which can be transmitted by a 2½ in. belt. Trouble does not end here for the reason that the entire machine is of very light construction and the back gears are ordinary cast iron with 1¼ in. face.

A careful study of the situation has determined that the only way to make this machine serviceable is to practically re-construct it for high-speed light work.

C. J. MORRISON,

Chief Engineer, Froggatt, Morrison & Company, Inc.

TRUCK EQUALIZER DESIGN

BERWICK, Pa., July 22, 1913.

TO THE EDITOR:

Regarding the articles on truck equalizing bars by L. V. Curran and Sigurd Holm in the February and July issues, respectively. One who designs an equalizer and only considers the car weight has much to learn about equalizers.

Mr. Curran's discussion is very interesting as far as it goes, also Mr. Holm's, but in the latter's effort to cover all the forces, he failed to consider the direct tensile stress in the bent portion, which varies according to the angularity of the section; this stress should be added to the maximum tensile stress due to bending.

We will consider an equalizer supported at both ends and loaded symmetrically at two points between the supports as shown in Fig. 1, and it should be so considered in figuring the fiber stress for a given load, except as the calculations are modified by the curved shape. The maximum bending moment and

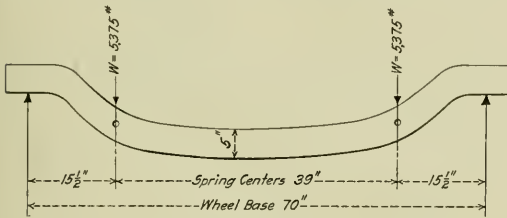

Fig. 1.

fiber stress will occur at the points where the springs are attached, and at all sections between these two points.

Fig. 2 shows the method of finding the bending moment at section X—Y through the point of spring suspension, or at any other point X₁—Y₁ between the spring and the support. The

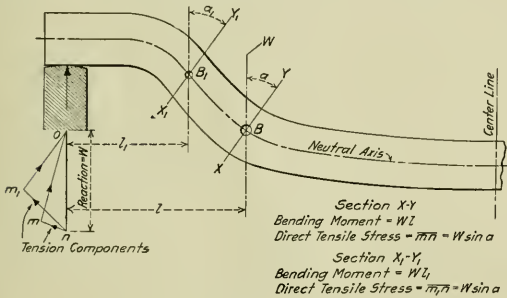

Fig. 2.

section must be taken at right angles to the neutral axis, and the distance *l* is measured from the neutral point of the section perpendicular to the line of reaction. The bending moment at all points between *B* and the corresponding point on the opposite side of the center line is the same as at *B*. Between *B*

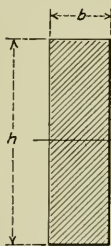

Fig. 3.

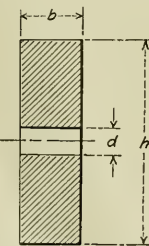

Fig. 4.

and the point of support when the sections are at different angles from the reaction, as in Fig. 2, there is a direct tensile stress to be added to the maximum tensile stress due to bending. The greater the angle, the greater the stress. In this calculation we will consider that the hole for the spring supporting pin is located on the neutral axis. The section will be the strongest if this is the case, and there seems to be no good reason why it should not be so located.

In the formulae and calculations these reference letters will be used, in addition to those given in Figs. 2, 3 and 4:

- A —Area of section.
- W —Reaction.
- M —Bending moment.
- Z —Section modulus.
- Sb —Fiber stress due to bending.
- St —Stress due to direct tension.
- S —Total tensile stress.

The maximum tensile stress at any section between *B* and the point of support is found by the following formulae:

$$(1) S_b = \frac{M}{Z}$$

$$(2) S_t = \frac{W \sin \alpha}{A}$$

$$(3) S = S_b + S_t$$

To find *M*, see Fig. 2; to find *Z*, see Figs. 3 and 4. The section at X—Y, which is the weakest, sustains the maximum fiber stress. Assuming that *b* equals 1½ inch and *d* equals 1¼ inch (Fig. 4), the maximum stress is found by the following calculations:

$$M = 5,375 \times 15.5 = 83,312.5 \text{ inch pounds. (See Fig. 2.)}$$

$$Z = \frac{1.5}{6 \times 5} (5^3 - 1.125^3) = \frac{123.577}{20} = 6.1788. \text{ (See Fig. 4.)}$$

$$S_b = \frac{83,312.5}{6.1788} = 13,500 \text{ lbs. per sq. in. (about). (See Fig. 1.)}$$

This section seems to have an inclination of about 12 degrees, on which the sine is about 0.208.

$$S_t = \frac{5,375 \times 0.208}{3.875 \times 1.5} = 192 \text{ lbs. per sq. in. (about). (See Fig. 2.)}$$

$$S = 13,500 + 192 = 13,692 \text{ lbs. per sq. in. (See Fig. 4.)}$$

If we take any other section to the left of *B*, such as X—Y, we will find the maximum fiber stress considerably less than at X—Y. This section has an inclination of about 43 degrees.

$$M = 5,375 \times 7.5 = 40,312.5 \text{ inch pounds.}$$

$$Z = \frac{1.5 \times 5^2}{6} = \frac{25}{4} = 6.25. \text{ (See Fig. 3.)}$$

$$S_b = \frac{40,312.5}{6.25} = 6,450 \text{ lbs. per sq. in.}$$

$$S_t = \frac{5,375 \times 0.682}{5 \times 1.5} = 490 \text{ lbs. per sq. in.}$$

$$S = 6,450 + 490 = 6,940 \text{ lbs. per sq. in. (See Fig. 5.)}$$

In these calculations, I have assumed a thickness *b* of 1½ inch. This gives (see Fig. 4) a maximum fiber stress of 13,692 lbs. This is a reasonable value for wrought iron. The thickness is greater than usual, and it would be better, perhaps, to make the bar somewhat wider and so reduce its thickness.

H. E. PARSONS.

ORE SHIPMENT ON THE GREAT LAKES.—The shipments of ore on the Great Lakes during the month of June, 1913, amounted to 7,974,444 gross tons, an increase of 406,889 tons over June, 1912.

FIRST BALDWIN LOCOMOTIVE.—The extraordinary speed and power of the locomotive on the Germantown Railroad should excite more attention than it has obtained from the enlightened community in which it has been made. It is the more remarkable because it is in many points original and because it is the very first working engine of the locomotive kind made by Mr. Baldwin. In the trials recently made the road was muddy, so as to impair the grip and to lessen the smoothness, and she was used immediately after her return from her afternoon trip to Germantown. For the experiment a space of two miles and a quarter was selected, in which there are four curves and several very muddy crossways. In passing through this space the steam was cut off at each curve so as to visibly lessen the speed and yet the whole distance was passed over in 3 minutes and ¾ths. It was therefore done at the rate of 40 miles per hour.—From the American Railroad Journal, January 19, 1833.

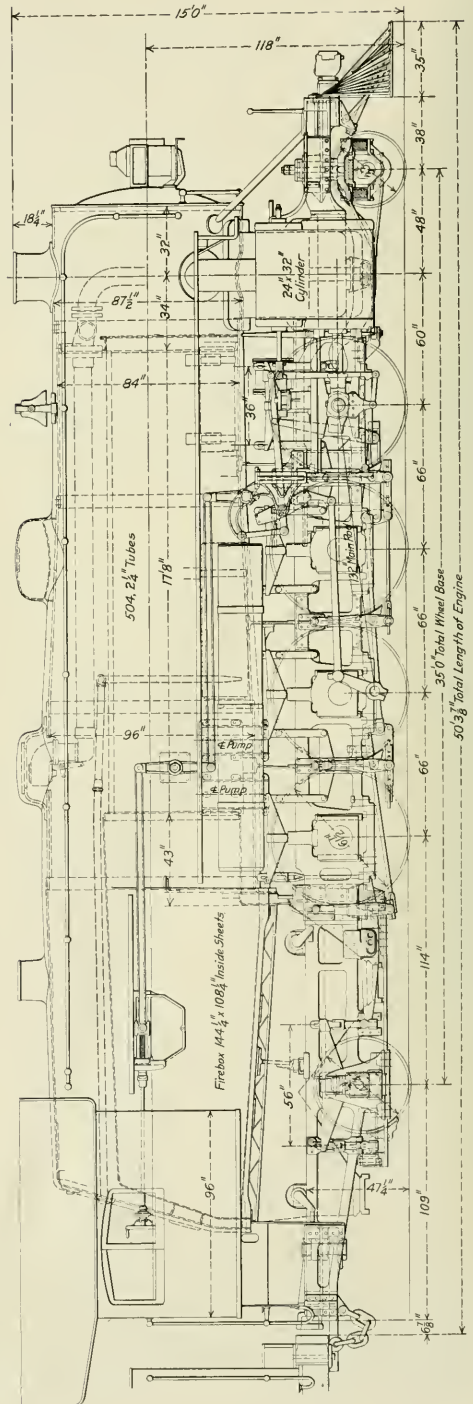
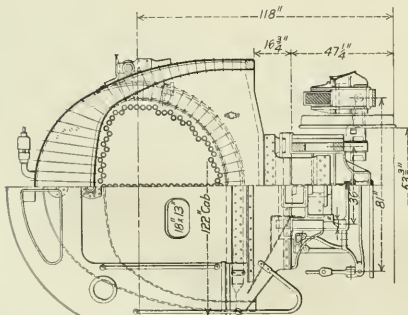
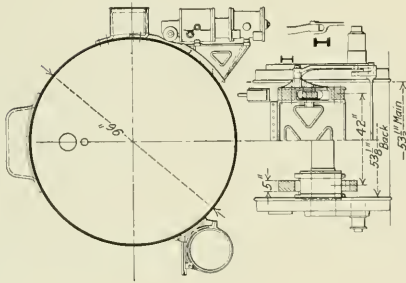
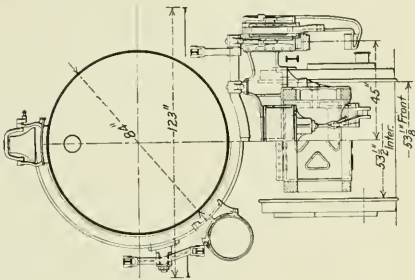
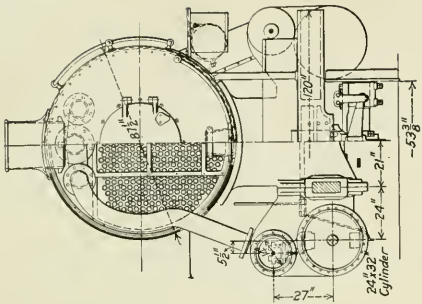

2-8-2 Type Locomotive Using Saturated Steam at 225 Lbs. Pressure; Philadelphia & Reading.

POWERFUL MIKADO ON THE READING

Largest of This Type. Exceptional Frame Bracing and Absence of Superheater Notable Features.

It has been the practice of the Philadelphia & Reading to design most of its own locomotives and also to build as many as possible in its own shops. The latest result of this policy is a series of locomotives of the Mikado type which have a total weight, in working order, of 331,000 lbs., of which 249,000 lbs. is on the drivers. This makes them the heaviest of their type on our records, both as regards total weight and weight on drivers.

has been provided. It is stated by the designer that a proportion of 30 to 1 between heating surface and grate area is considered good practice for burning low grades of fine anthracite coal. The grate area is 108 sq. ft., and with this proportion the boiler should have 3240 sq. ft. of heating surface. As a matter of fact 2268 sq. ft. of heating surface has been added to this, making the total 5508 sq. ft. It is necessary to burn buckwheat coal at comparatively low furnace temperatures which requires a very large grate surface to get the best results. On this account the extra heating surface is added in order to approximate the same fuel economy as might be obtained by the superheater without the extra complications incident to its use. Thus far in the operation, the smokebox temperatures seem to be comparatively low and the amount of coal burned for the work done is rela-

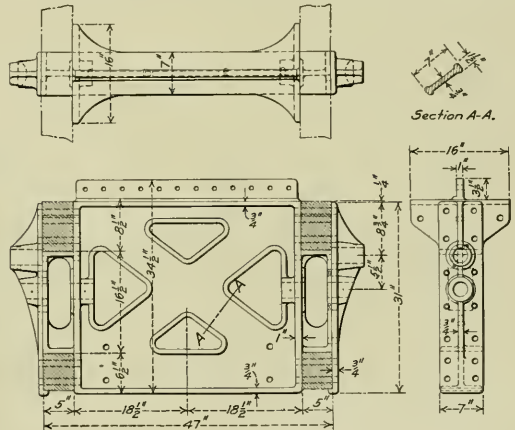
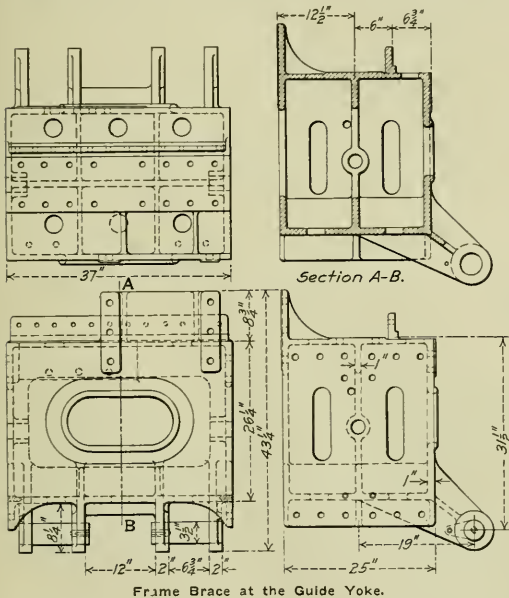

They have an unusually large firebox of the Wooten type and are arranged for burning a mixture of anthracite and bituminous coal. Eight months' service has shown that the combination of 24 in. x 32 in. cylinders, 225 lbs. steam pressure and 61½ in. diameter of drivers has produced a locomotive which is very well adapted for fast, heavy road service, as well as for slow, heavy grade work.

One of the most interesting features of the design is the fact that a superheater is not used. To make up for its absence, however, an extra large amount of evaporative heating surface

tively smaller than is required in other types of locomotives on this road.

Since a combustion chamber 43 in. in length has been installed ahead of the firebox, the tubes are but 17 ft. 8 in. long. In order to get this very large amount of evaporative heating surface with the 2¼ in. diameter tubes used, it is necessary to have a very large diameter boiler. The barrel is made up of three sections, the forward one being 84 in. in diameter and the third one 96 in. in diameter, the intermediate course being made conical to connect the two. The thickness of the sheets of the first



Largest Mikado; Designed and Built by the Philadelphia & Reading.

course is $\frac{7}{8}$ in., and it is $\frac{15}{16}$ in. in the second and third courses. The dome is flanged from a single piece of $1\frac{1}{8}$ in. steel plate and is but $10\frac{1}{2}$ in. in height.

This is probably the largest grate that was ever applied to a

each is in two sections for shaking. There is a wide dump plate at the front and rear of the center row of grates. There are two fire doors, elliptical in shape and measuring about 12 in. x 18 in. The grates have a slope toward the front in a straight line in order to make it possible to fire this length of firebox. The usual brick wall used in the Wooten type of firebox is found in this design and flexible staybolts are used in the corners of the sides and in the roof sheets. The combustion chamber is supported by sling stays.

In order to reduce trouble with frame breakage as much as possible, the matter of substantial bracing has been given particular attention. The frames are in two parts, the main section being 5 in. in width and $7\frac{1}{2}$ in. in depth over the pedestal. The trailer frame is spliced to it and is 4 in. in width. In addition to the cylinders and the firebox supports, these frames are braced by a heavy casting at the guide yoke and but slightly less heavy braces between the other pairs of drivers. An inspection of the illustrations of two of these braces will give a good idea of the care this feature has been given.

The cylinders are cast separate from the saddle, and the front frame extension, which measures 5 in. x 13 in. at this point, is completely housed between the castings for a length of about 52 in. Fifty-nine $1\frac{1}{8}$ in. bolts are used to form the connection between the cylinders and saddle, and ten of these pass through

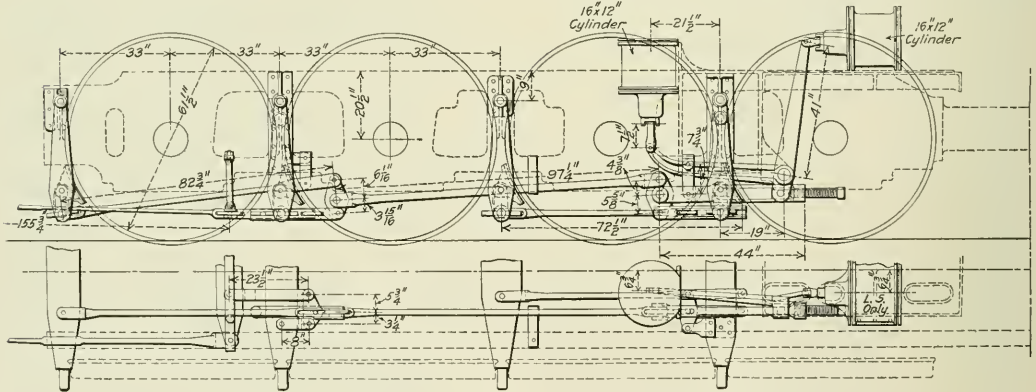
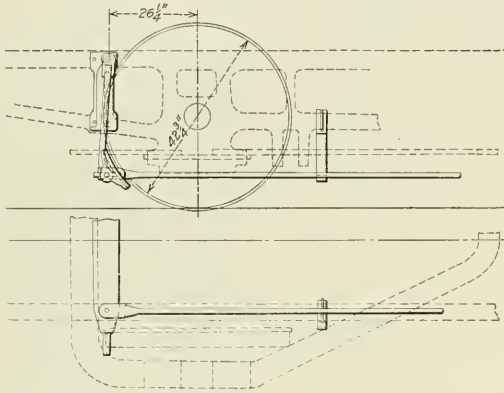

Arrangement of Brake Rigging Which Includes a Connection to the Trailing Truck.

locomotive and measures 9 ft. in width by 12 ft. in length. The grates are of the rocking type with short fingers and narrow openings in the center, suitable for the fine grade fuel to be burned. They are installed in three sets across the firebox and

the frame. Exceptionally large exhaust ports are provided through the cylinder castings, and large outside steam pipes connecting at the top center of the valve chest are used. It is stated that these large steam passages have made a very free moving

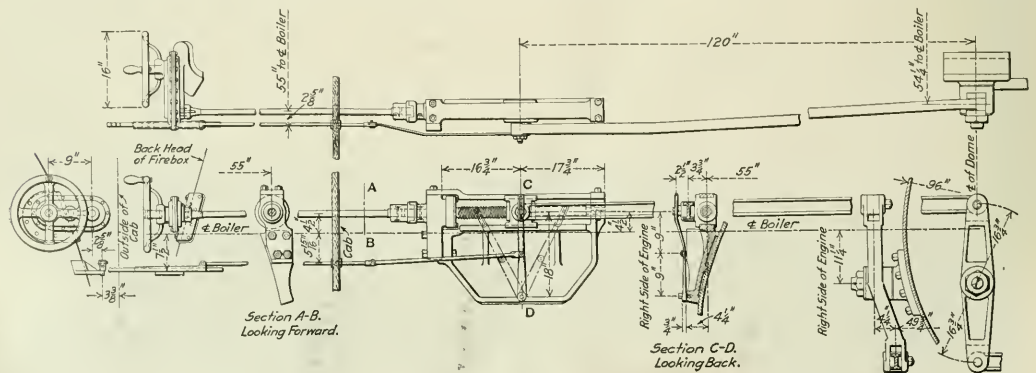

General Arrangement of the Screw Reverse Gear; Philadelphia & Reading Mikado.

locomotive with little back pressure. The engine will move itself with 30 lbs. steam pressure.

The 14 in. piston valves are arranged for inside admission and the valve gear gives a maximum travel of 6 in. An original

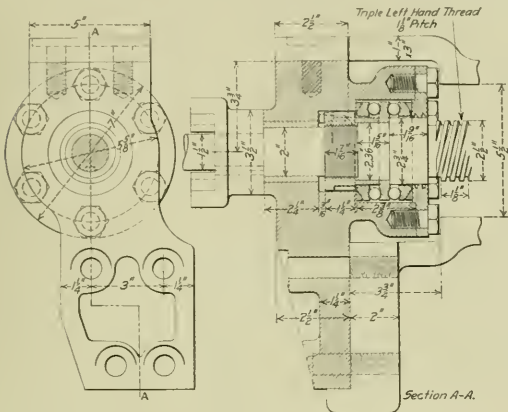

Ball Thrust Bearing in the Screw Reverse Gear.

arrangement of screw reverse gear has been used and is shown in detail in one of the illustrations. The limited clearance between the sides of the cab and the firebox made it necessary to place the screw and the crosshead outside of the cab, and it was also necessary to offset the center of the hand wheel from

the center of the shaft, bringing it on the back of the boiler head. This was done by introducing a train of gears contained within a case secured to the boiler head. A cut-off indicator is arranged just below the reverse wheel; by means of a pointer connected to an inverted pendulum working with the crosshead of the reverse gear. To obtain the desired offset in the center line of the screw reverse shaft and the connection to the arm of the lift shaft, a central rocker has been introduced in the reach rod. This is pivoted at the center and reverses the movement of the reach rod. One of the detail illustrations shows the arrangement of the ball bearings on the main screw. It will be seen that these are arranged to take the thrust in either direction.

Two 16 in. x 12 in. air brake cylinders are used on either side of the locomotive and operate the brake shoes on all four of the drivers, as well as the shoes on the trailer truck. The arrangement of this rigging and location of the cylinders is clearly shown in one of the illustrations. The locomotive is provided with two 11 in. air pumps and the main reservoirs are located in a vertical position underneath the cab.

The general dimensions, weights and ratios are shown in the following table:

General Data.	
Gage	4 ft. 8 1/2 in.
Service	Freight
Fuel	Mixture
Tractive effort	57,319 lbs.
Weight in working order	331,000 lbs.
Weight on drivers	249,000 lbs.
Weight on leading truck	25,100 lbs.
Weight on trailing truck	56,900 lbs.
Weight of engine and tender in working order	491,000 lbs.
Wheel base, driving	16 ft. 6 in.
Wheel base, engine and tender	26 ft. 4 1/2 in.

Ratios.	
Weight on drivers ÷ tractive effort	4.34
Total weight ÷ tractive effort	5.77
Tractive effort ÷ diam. drivers ÷ heating surface	640.00
Total heating surface ÷ grate area	48.24
Firebox heating surface ÷ total heating surface, per cent.	5.41
Weight on drivers ÷ total heating surface	45.20
Total weight ÷ total heating surface	60.10
Volume both cylinders, cu. ft.	16.75
Total heating surface ÷ vol. cylinders	3.29
Grate area ÷ vol. cylinders	6.45

Cylinders.	
Kind	Simple
Diameter and stroke	24 in. x 32 in.

Valves.	
Kind	Piston
Diameter	14 in.
Greatest travel	6 in.
Outside lap	1 in.
Inside clearance	1 1/6 in.
Lead	1/4 in.

Wheels.	
Driving, diameter over tires	61 1/2 in.
Driving journals, diameter and length	11 in. x 13 in.
Engine truck wheels, diameter	33 in.
Engine truck journals	7 in. x 11 in.
Trailing truck wheels, diameter	42 3/4 in.
Trailing truck journals	8 in. x 14 in.

Boiler.	
Style	Wooten
Working pressure	225 lbs.
Outside diameter of first ring	84 in.
Firebox, length and width	144 in. x 108 in.
Firebox plates, thickness	3/8 in.
Firebox, water space	F, 5 in.; S, & B, 4 in.
Tubes, number and outside diameter	504-2 1/2 in.
Tubes, length	17 ft. 8 in.
Heating surface, tubes	5,210 sq. ft.
Heating surface, firebox	298 sq. ft.
Heating surface, total	5,508 sq. ft.
Grate area	108 sq. ft.
Smokestack, height above rail	180 in.

Tender.	
Frame	12 in. channel
Wheels, diameter	36 in.
Journals, diameter and length	5 1/4 in. x 10 1/2 in.
Water capacity	8,000 gals.
Coal capacity	12.85 tons

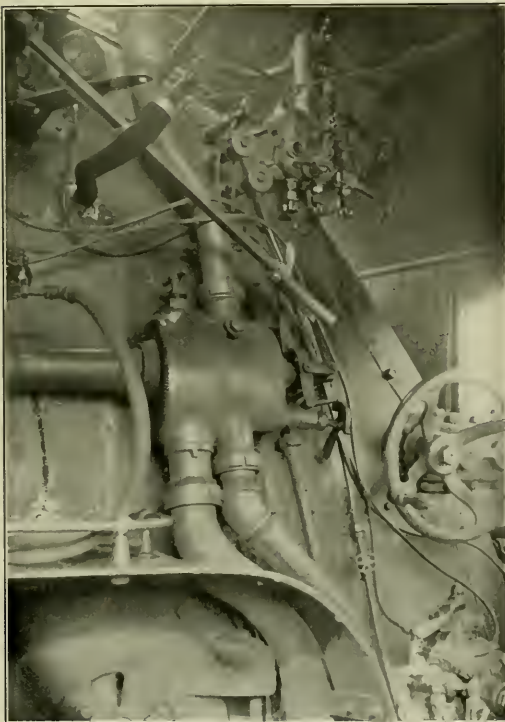

Interior of Cab Showing Position of Reverse Wheel.

PLANING TAPER FLANGES ON DRIVING BOXES

BY C. L. DICKERT,

Assistant Master Mechanic, Central of Georgia, Macon, Ga.

It is the general practice on most roads to taper the inside of the flanges of driving boxes from the center in both directions. In this way the rocking of the engine will not tend to break the flanges of the box or the shoes or wedges, nor will the box bind in the pedestal as the locomotive sways. In order

on the plate, which provides for running out the taper at the proper place. In the center of the plate is a guide or slot which gives a movement, varying up to 1/2 in. either side of the center line, to the bottom of a lever supported from the cross rail of the planer. This lever is fulcrumed around a pin secured at the center of the lever and carries a roller at its lower end which fits in the slot. On this lever or rocker arm are two connecting links spaced a suitable distance from the center of the fulcrum to give the required travel to the tool heads. These links are connected by pins to the rocker arm

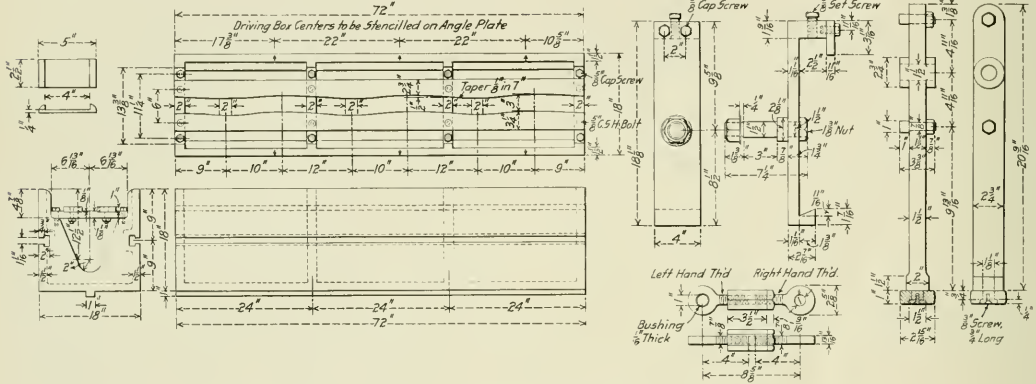

Angle Plate, Guiding Slot and Details of the Lever.

to properly plane these taper flanges it is generally necessary to have six separate chuckings of the box while on the planer. The general practice in this respect, is, first to plane the boxes straight in the shoe and wedge face, then line out one end of the box for the required taper and plane one side. The tool is then swung over and planes the opposite side of the channel,

and to the tool head, and are provided with turnbuckles so that the tool head can be adjusted.

When planing a set of boxes, the first operation is to plane out the shoe and wedge face. When this is done on one side, the links are connected as shown in the illustration, and the feed screw nuts are removed, allowing the heads to move freely

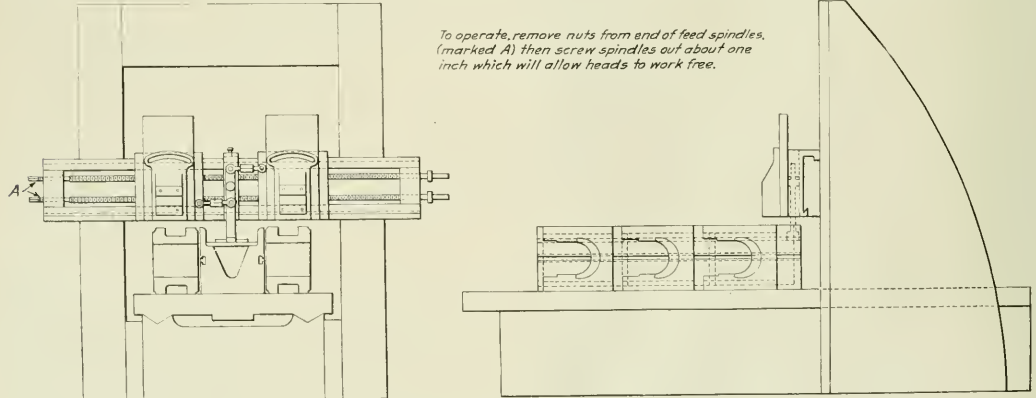

Arrangement of the Apparatus on the Planer for Planing Taper Flanges.

and the same operation is performed for planing the other two tapers on this side of the box. The boxes are then turned over and the other side is planed in the same manner, requiring six separate chuckings.

With the device shown in the illustration, which is used at the Macon shops of the Central of Georgia, the operation can be finished complete with but two chuckings. It consists of a large angle plate, which is clamped to the planer bed in the usual manner. The driving boxes are placed on either side of this plate, the center of the box being set to a center line marked

on the cross-rail. The side tools are placed in heads and adjusted by means of the turnbuckle on the connecting links. When one side of the flange has been planed, the links are reversed, changing the motion for planing the opposite flange.

After finishing the first side of the boxes, the cross feed is again required, and all that it is necessary to do is to remove the connecting links and place the nuts on the feed screws. It is not necessary to remove the rigging. All the boxes are planed alike, and the attachment can be made to plane any taper, leaving as much straight at the center as desired.

GENERAL FOREMEN'S CONVENTION

Apprenticeship, Scheduling and Routing Work in the Shop, Repairs to Superheaters, Driving Boxes.

The ninth annual convention of the International Railway General Foremen's Association was opened at the Hotel Sherman, Chicago, on July 15, 1913, by President F. C. Pickard. After a prayer by Rev. Bishop Fallows, the association was welcomed to the city by Leon Hornstein, assistant city attorney.

PRESIDENT PICKARD'S ADDRESS.

F. C. Pickard in his presidential address spoke, in part, as follows:

The work of the General Foremen's Association has been far-reaching, well defined and its benefits have been appreciated by all. By a mutual discussion of the many subjects that come before the convention and the benefits gained by convention work, your attendance is profitable to yourself and to your company. The man who tries to keep all his own trade knowledge to himself should remember that he has no right to the ideas of others.

As general foremen we should be able to make an analysis of our local conditions and surround ourselves with the proper organization to meet the requirements of shop management. Organization is recognized as an economical necessity to effective control and co-operation in human effort. Organization deals with men, and industrial organization includes the elements of production and transportation.

We should consider carefully the recommendations that are placed before us and let us not lend the prestige of the association to anything that may increase the cost of maintenance in shop operation. The conclusions we may arrive at as recorded in the minutes of our convention are the harvest we reap. The improvement so derived in shop practice means necessarily an increase in output which is always appreciated by our superiors. Be sure you are right and then command the courage to carry out your convictions and you will win.

I have been particularly impressed during my connection with this organization with the probabilities of promotion from the ranks of the general foreman to one carrying higher responsibilities in the mechanical field. Many men who have so risen have been active in the work of this body and owe their promotion to their activity in promoting the welfare of their companies by close attention to the subjects brought before them. You will find that the men doing the big things today are those who were yesterday doing the little things the best they knew how.

I wish to recommend that the subjects to be presented for discussion continue to be on shop operation, methods, etc., and that standing committees be appointed on machine work, creating work and roundhouse practices.

MR. QUAYLE'S ADDRESS.

Robert Quayle, superintendent of motive power and machinery of the Chicago & North Western, addressed the meeting and spoke of the value of the meetings of mechanical men having the same interests, of which there are now a large number each year. He pointed out that it is not only the intelligence of one man that counts, but much greater is the combined intelligence of all men. If each man will take back a single idea or kink from each of the others, his value to his company would be increased enormously.

It is not so much the idea that somebody will notice you and put you in some other position that makes you put forth your best efforts, but because you think it was right to do it, and because you love to do it, and because your self-pride and your ambition compels you to do it; and when you do that without any thought of anybody else, somebody comes along without even touching your shoulder, and you are moved to a higher position, and then you see what did it. There were other eyes

that were looking around for men to fill the position, and they found you right there and took you. Keep going on this line and it will be your turn next.

How about the progress of the man? We talk about the progress of machinery. We are building ponderous locomotives; we are putting on superheaters and other devices. But we are not considering very much about the man. There are certain lines along which men can develop and become better men; they can be more useful in the community in which they live, more useful in their own homes. They can be more useful in the field of labor in which they are exerting their efforts.

General foremen hold an important position. You are the leader. Your influence means a good deal. Your intelligence ought to mean a good deal. Sometimes we think that as one man we cannot do much, but one man can do a whole lot and we ought to determine that we will do the best we can and have things coming our way.

Are you a good instructor?

You have had some teachers in your time that could say something to you, or ask you a question in a cynical manner that would stir up all the ire in you and you would resent it. They made an impression, but it was not a good one. They did not know your disposition. If you have foremen under you, you ought to know their dispositions. You ought to be able to teach them without touching under the lower rib, and you are not a good instructor if you cannot do it. You may have some men that you cannot treat that way, and if you have the best thing is to relegate them to the rear, because you must have harmony, and you must be the leader to work with them and get them to work with you. If you do that you will have a very good knowledge of the men who are associated with you in each department. By and by somebody higher up will look for a man to take some important job. You may be the fellow he has his mind's eye on, but you are filling such an important position that the fellow next to you in the shop—he is not as good a man as you, not nearly—cannot succeed you. He says: "I can't take a chance on that. I am not going to take a man out of that position and lift him up a notch higher until we have somebody in the ranks that will take his place." Some of us sometimes feel that it is not a good thing to have that kind of a man right next to us. We get jealous and afraid that he will get our job. Jealousy has no place in a workshop, nor anywhere else. I want to tell you that the man who succeeds in getting men who are in every particular better men than he is, will succeed, and if I cannot get a man for my associate who is a better man than I am, I won't have him. He must be a better man than I am in every way. At least I must think so, and when I have got him there, what does he do with me. I get a force around me then and support that is as staunch as the very heavens above. Let us get men about us that we know are our superiors. That is not reflecting on you either when I say it. If I have a man who has good men about him I know he has the fellows that are doing the work.

Have you got your eye on good material all the time to fill the positions that are becoming vacant by men who are being moved up or leaving the service? You ought to have, and I have no doubt you do have. Don't you know it is the hardest thing in the world for men to pick out men to fill the positions higher up. A good deal of training is necessary and you men ought to have these men down at the beginning that have the intelligence, that have the moral fitness, that have the mechanical fitness. I said, moral fitness, and I want to tell you that you do not want to put any man into a position of trust who is over a lot of other men, unless he is a clean man.

If a young man were to come to me and ask me how to succeed, do you know what I would tell him was the first essential to success? You might say a good technical education. I would not. That is a splendid thing. You might say a fine physique and good health. That would be a good thing, and I might name a good many other things, but the greatest thing for us to cultivate is character, and I want you to spell it with capital letters. Character goes out from you in every word that you speak and indicates the kind of man you are. It will be reflected today in the work that you do. It is reflected in your conversation; it is reflected in your home; it is reflected in the community in which you live—the kind of character you have, the kind of man you are—and don't we all like to be the best kind of man we can be.

Secretary-Treasurer Report.—The total membership at the opening of the convention was 214, and the balance in the treasury was \$620.

SUPERHEATER LOCOMOTIVES

BY P. C. LINCK, C. & E. I.

One of the most important items in maintaining superheater locomotives for successful operation, is to keep the flues and superheater units clean. To obtain the best results a special man should be appointed to clean the flues, remove the clinkers or honey-comb that may form on the return bends at the firebox end, the crown sheet and the brick arch. He should be held responsible if the engine is allowed to go out without being thoroughly cleaned. For cleaning the flues a $\frac{3}{8}$ -in. gas pipe long enough to extend entirely through the flue should be used. This pipe to be inserted at the firebox end and gradually worked forward to the front end of the flue under the superheater unit, blowing the dirt off the front end of flue.

The flues should be given close attention, if leaking or in need of re-working. The prosser expander only should be used. If some of the beads are away from the sheet, a standard beading tool should be used to tighten them to sheet. Rolling has a tendency to stretch flue sheet holes and put a strain on the bridges between flue holes.

At stated intervals, the superheaters should be given a test with warm water at a pressure of about 100 lbs. The boiler, seams and flues in front flue sheet, all joints in the superheater steam pipes, rings, exhaust pipe, all joints to the steam header should be carefully examined for leaks; also for cracks or break in header, and the unit pipes just below the ball joint. I understand on some roads this is where the most trouble is experienced. The return bends at firebox end should be thoroughly inspected and the slightest leak repaired before the engine goes into service.

On one type of superheater we have had trouble with the steam pipes leaking. Considerable of the trouble was due to the rings being made of brass. They seemed to deteriorate very fast, and we have changed these to a good grade of cast iron. We also found the joints were not made perfectly. By seeing that joints are perfect and by using cast iron rings we have overcome most of this trouble.

We have experienced some trouble with both types of superheater unit pipes and return U's leaking where fitted together, generally at the back end, but a few at the front end. To make temporary repairs on one type we plug the front end, but if left plugged too long, the back end will burn off on account of having no circulation through the pipes. As soon as practicable we remove the pipes that are leaking, repair, and test before replacing.

We had considerable trouble with the valve bushings, valve packing and cylinder packing on the first superheater engines. They were Pacific type passenger engines equipped with Emerson superheaters. Part of this trouble was on account of the men not being familiar with the best way of handling the lubrication, and a great part was due to the metal used in these castings. The best quality of cast iron should be used for these parts. We have very little trouble with valve packing since, we make

the valve packing $\frac{1}{8}$ in. large, cut out the proper amount, then have a jig for compressing together and turning off to the exact diameter of the valve chamber. The later superheater engines were equipped with a semi-plug piston valve.

The piston heads seem to wear very fast, partly due to the weight of the head riding on the cylinder. We have none equipped with the extension piston and it is a question if it would be economical to apply the extension piston and maintain it or to renew the heads every eight or nine months. We experimented by trying a composition of copper, lead, tin, zinc and antimony, applied to the bottom of piston head. It has been running on some of the engines for five or six months and is giving good service. On one engine that had worn the cylinder and piston head $\frac{5}{16}$ in. we applied this composition to the piston head. Three months afterward it showed $\frac{1}{16}$ in. wear of the metal applied.

The question of lubrication of superheater engines is one of the most important items. There is considerable discussion on using a high grade of valve oil, that would withstand the heat before burning, or carbonizing. It has been recommended that a special grade of oil be used for superheater engines. We have made a few experiments and tested out different theories. One test was to attach a long copper pipe to the lubricator on a test rack, coil the pipe, and put the coil in a forge, heating to a red hot heat, letting the lubricator feed regular valve oil through the hot pipe. The oil came through the heat in as good condition as it did when the pipe was not hot, the oil being kept from burning by the steam as they both flowed through the pipe.

The oil should enter the steam as far away as possible in order that it may atomize and be thoroughly mixed with the steam before reaching the parts to be lubricated. On this theory we removed the oil pipes leading to the cylinders, and only used the feed to each valve. All the new engines purchased since have been ordered with only a three feed lubricator, with booster valve attached. We have had but comparatively little trouble with these engines.

On receiving general repairs, flues or steam pipe work on one type of superheater we remove the steam pipes and superheater unit pipes together; a boiler plate bracket is used to hold the pipes in proper position. They are handled with the electric crane, and after being repaired and joints made on the steam pipes they are given a hydrostatic test of 250 lbs. They are then handled with the crane and replaced in the engine. After all joints are tightened we apply a water test to see that joints and connections are tight. The other type we handle one unit at a time; each unit is tested separately; we have a tool that we connect to the unit pipes and apply a water and air pressure of 200 lbs. Where one or two unit pipes are broken below the ball joint, it is the practice at some places to splice the pipe with a steel coupling, making the ball on the short piece of the unit pipe in the smith shop, on a die similar to a bolt header die; it is afterwards finished to proper size. We have applied the ball end to new unit pipes in this way, finishing on a turret lathe to a standard former for ball joint. We are also trying welding a set of return bends on the firebox end with acetylene.

The units should be provided with supports and bands to replace any that have been lost or damaged; units 18 ft. long or over should have two supports, the first 6 in. from the back end and the second midway between the first and the end of the straight portion of the unit. Unit bolts should be examined and replaced if not in good condition. Whenever units are removed from the boiler, the tube supports and bands should be inspected and replaced by new ones if not in good condition.

We have made quite a number of small special tools. The formers for grinding the superheater header and unit pipe ball joints give the best service when made of copper. We have reamers for these, so when they are worn or not standard, all that is necessary is to use a reamer to keep the formers standard. We made a cutter for cutting large holes in flue sheet, a ball reamer for removing the sharp edge after cutting the holes, a

roller for copper ferrules in the back flue sheet, rolls for applying unit pipes on the Emerson superheater, rolls and Prosser expanders, for working the large flues, a machine for cutting all size of flues, jig to hold the steam pipe rings to be ground with an air motor, one for drilling and reaming the holes on the superheater header, standard gages to keep all beading tools, Prosser expanders and ball joints to a standard. These should be carefully checked as an odd size beading tool or Prosser may do considerable damage to the flue or flue sheet.

DISCUSSION.

Difficulty in making a tight joint between the units and the header has been overcome in a number of instances by heating the bolt holding the clamp to the header when putting it in place. It is only given a black heat, or approximately the same temperature it attains in service. Copper gaskets under the ball joints are successful for temporary repairs, but should not be used for permanent work.

Piston heads and rings wear much more rapidly on superheater engines and the extension piston rods were generally favored on this account. Graphite lubrication has been very successful on several roads, although if too much graphite is fed to the cylinder it will cake around the rings with disastrous results.

The expander should always be used in tightening the superheater tubes. A tight fitting ball on the end of a rod has been successfully used for removing dents in these tubes when they are being repaired.

The practice of plugging superheater units that leak was generally condemned. Repairs should be made immediately. Broken unit pipes have been repaired by joining on a new piece by means of a connection made of seamless steel tubing and threaded or welded.

The importance of greater care and accuracy in the general repairs to the motion work was mentioned by one member. Packing on piston and valves should be fitted with great care. Cylinder and valve bushings should always be bored after they are in place. The valves should be very carefully lined in the chamber. Lubricating connections should always be free and clean.

While the damper has been taken out of some engines it is not considered good practice. On European roads where the idea had been given a careful trial the dampers were all restored. It appears that no particular trouble has been found in keeping the dampers in good condition with the exception of the steam cylinder and its attachment to the rod. The vertical cylinder and heavier attachments now being used will probably overcome this.

One case of the cutting of the tube by the feet on the bottom of the return bends was mentioned. This is probably due to an ingredient in the fuel which forms a cutting compound and when combined with a loose unit permits these small projections to wear through the tube. The remedy is to keep the units tight in the tube and use sufficient supports properly spaced.

Difficulties with rod packing have been overcome by the use of better material.

APPRENTICESHIP

The committee prepared a list of questions regarding apprenticeship and sent them to forty-five representative concerns in the United States, asking for replies to the several questions. Twenty-five of these letters were addressed to railroad companies, and twenty to other corporations, such as engine builders, electrical manufacturers, etc., etc. The following is a condensed abstract of the information received in reply to the questions:

Number apprentices employed? Railroads, 4,925; other corporations, 3,004.

Age limit? Railroads from 15 to 22 years; other corporations, from 16 to 21.

Educational qualifications of applicants? Common school education.

Number shops employing apprentices? Railroads, 168; other corporations, 38.

Are apprentices given any educational advantages? Yes.

Number apprentice school instructors? Railroads, 96; other corporations, 51.

Number apprentice shop instructors? Railroads, 61, other corporations, 48.

Hours apprentices attend school per week? Railroads, average 3.61—vary from 1 to 6; other corporations, vary from 2½ to 8, average 5 hours.

Are apprentices paid while attending school? Railroads: Out of 18 replies, 16 pay while attending school; other corporations, 17 out of 20 pay regular rate while attending school.

Subjects taught in school? Railroads: Spelling, letter writing, arithmetic, elementary mechanics, materials, drawing, trigonometry, physics. Other corporations, subjects vary according to needs of different corporations, much attention being given to character building, courtesy, civility, etc., the practical subjects relating directly to needs of each company.

Is instruction during daylight working hours? Railroads, out of 18 replies, 16 give instructions during daylight working hours. Other corporations, 17 out of 20 give instruction during daylight working hours.

Length of apprenticeship? Railroads, 2 from 3 to 4 years; 3 from 4 to 5 years; 13, 4 years. Other corporations; 12 require an apprenticeship of 4 years, the other 8 vary from 2 to 7 years.

Per cent. of boys entering who complete apprenticeship? Railroads, 71 per cent.; other corporations, 65 per cent.

Per cent. of graduates remaining in the service? Railroads, 77 per cent.; other corporations, 56 per cent.

Do you encourage graduates to remain? Railroads, yes; other corporations, yes.

Is any bonus or prize offered boys to complete apprenticeship? Railroads, yes, 3; no, 15; other corporations, yes, 13; no, 7.

Have results obtained justified your trouble, expense, etc., of educating and training your apprentices? Railroads, yes; other corporations, yes.

From the information received it is evident that the subject of apprenticeship is attracting considerable attention, and that there has been a substantial development in the work. In addition to the larger and more prosperous railroads in the country, nearly all of the large industrial concerns have instituted educational courses; some of these have regular apprentices schools, others co-operate with the public schools in the continuation schools or part-time system and still others have made arrangements whereby the men whom they are training may receive instruction through the correspondence schools or Y. M. C. A. schools. These courses are offered to their employees not only by the large corporations making railway supplies, but by the large department stores, etc.; even large banking concerns organizing schools to train men to handle their auxiliary organizations such as gas and electric power companies, street railways, etc. Many of the men trained by the large supply companies go out and work for the companies purchasing their supplies. In addition to teaching these men subjects relating directly to the needs of their respective organizations, they also teach character building, politeness, and the ability to "get along." Probably some 200 corporations are now offering their employees educational advantages, paying them for the time spent in school. They would not be doing this if it did not pay them in dollars and cents.

The committee unhesitatingly recommend to the association that the question of apprenticeship is worthy of consideration by the officers of railroads, and manufacturing concerns, and submit the following reasons:

First: Apprentices have proven satisfactory from a commercial standpoint.

Second: Graduate apprentices have been advanced to positions of authority in many shops. The apprenticeship system is harmonious in a shop employing either the day work or piece work system. The committee, recognizing the fact that there is a wide difference in organization and local conditions as to available material and facilities for instruction, considers that a hard-and-fast general apprenticeship code is impracticable, and, therefore, suggests the substitution of basic principles rather than a formal code.

To assure the success of the apprenticeship system, the following principles seem to be vital, whether the organization is large or small:—

First: To develop from the ranks in the shortest possible time, carefully selected young men for the purpose of supplying leading workmen for future needs, with the expectation that those capable of advancement will reveal their ability and take the places in the organization for which they are qualified.

Second: A competent person must be given the responsibility of the apprenticeship scheme. He must be given adequate authority, and he must have sufficient attention from the head of the department. He should conduct thorough shop training of the apprentices, and in close connection therewith, should develop a scheme of mental training, having necessary assistance in both. The mental training should be compulsory and conducted during working hours, at the expense of the company.

Third: Apprentices should be accepted after careful examination by the apprentice instructor.

Fourth: There should be a probationary period before apprentices are finally accepted; this period to apply to the apprentice term if the candidate is accepted. The scheme should provide for those candidates for apprenticeship who may be better prepared as to education and experience than is expected of the usual candidate.

Fifth: Suitable records should be kept of the work and standing of apprentices.

Sixth: Certificates or diplomas should be awarded to those successfully completing the apprentice course. The entire scheme should be planned and administered to give these diplomas the highest possible value.

Seventh: Rewards in the form of additional education, both manual and mental, should be given apprentices of the highest standing.

Eighth: It is of the greatest importance that those in charge of apprentices should be most carefully selected. They have the responsibility of preparing the men on whom the roads are to rely in the future. They must be men possessing the necessary ability, coupled with appreciation of their responsibilities.

Ninth: Interest in the scheme must begin at the top, and it must be enthusiastically supported by the management.

Tenth: Apprenticeship should be considered as a recruiting system and greatest care should be taken to retain graduate apprentices in the service of the company.

Eleventh: Organization should be such as graduate apprentices can afford to enter the service for their life work.

In addition to the principles set forth above the committee urges the necessity of having adequate instructions for the shop and not confusing this part of the boy's education with the school room work. While we recognize the great value of the school room instruction, we believe the one should supplement the other. The principal objection offered by foremen to apprentices in the shops is the time which must be spent with beginners. With adequate shop instruction the foreman is relieved of this. The boy is given assistance as soon as he enters the shop and is made productive at once. It has been demonstrated that where you have twenty apprentices in one trade in a shop the increased output of the boys brought about by a

practical instructor, will amply justify the employment of a shop instructor.

Committee: F. W. Thomas (A. T. & S. F.), chairman; C. W. Cross (N. Y. C. Lines) & E. V. Lea.

DISCUSSION.

After presenting the report, Mr. Thomas spoke on the general subject stating in part:

While all of the railroads included in the report, and also the manufacturing or commercial concerns, show a determined spirit to give the boys in their employ the best opportunity possible to learn the trade, it is a further evidence of a necessity which the times have demanded. The modern shop offers little chance for a boy without some one to guide and direct him. The foreman, and the gang foreman are too busy and have too many other duties to perform to be bothered with green boys. A boy floundering around a big modern shop for four years with no kindly hand to help or direct him is what gave the old apprentice system a black eye from 1890 to 1905. He was a failure, and at the end of four years he knew next to nothing of the trade. The old mechanic passed away, and there were no trained men to take his place. That is why you suffered such a dearth of first class mechanics. That is what drove you to the specialist, the handy man, the man who could successfully run one machine, but no other.

The Santa Fe Railway said to the general foreman and foremen: "We know you haven't the time to pay much attention to these boys; you look out for the output of the shop and your other duties, and we will put a man there whose sole duty will be to look out for the apprentices, and be responsible to you for the boys' progress and work. He will move them from machine to machine, job to job, showing them step by step, and then we will have a school room; the boy will be taught by another instructor on such subjects as he needs in his trade, receiving the mental training along with the practical." With the present system we have found that the boy, with the assistance of his shop instructor, becomes productive at once. No time lost experimenting and finding his place or getting over his stage fright. In the absence of a regular man on any machine, our foremen simply ask the shop instructor to put one of the boys on the machine while the regular man is off. He does it and stays with him enough to insure a reasonable day's output. The success we have attained with our apprentices has been due to the full, ample shop instruction. We appoint the best men we have and enough of them to insure the boys' complete instruction. I believe, with Mr. Basford, that the present shops need more instructors and fewer inspectors.

We are not trying to make mechanical engineers; the colleges furnish these. We are not trying to make draftsmen; the schools furnish these. We want to make first class skilled mechanics to operate our machines, men who are trained and educated in our ways, our methods, our standards; whose home and family ties are within our midst. We are making them the equal of any on earth, good mechanics, good citizens, proud of their work, and their road, and the apprentice system which has made their present condition possible.

C. W. Cross, supervisor of apprentices, New York Central Lines West of Buffalo, stated that the purpose of the apprentice system is to provide the motive power department of railroads with an adequate recruiting system which will eventually produce from the ranks a large number of skilled workmen, a number of foremen, a sufficient number of good draftsmen, a few master mechanics and an occasional superintendent of motive power. The general plan is twofold, and provides for shop instruction of the apprentice in the trades and also for his instruction in mechanical drawing, practical mathematics and shop problems during working hours while under pay.

It seems to me at the present time there is no more serious problem confronting the railroads and manufacturing concerns, especially the mechanical department, than the future relation-

ship between the employees in the mechanical department and the companies. We find that probably as much of the time of motive power officers is taken up in considering the difficulties of the labor problem as is devoted to the strictly technical subjects of the department. The growing tendency to specialization seems to have led to a lack of general all-around mechanics in the shops, and it has been noticed in probably every shop in the country that there is a great dearth of suitable men. When a good man is desired for a foreman, the man in charge of the shops, or of the department, looks about to find a man of the right caliber and a man who has enough general information about his department work to be put in charge of men. That problem has to be faced, and it seems to me that the step that has been taken by the several roads which have established apprentice schools on a comprehensive and broad scale, is one of the most important moves that has been made by the railroads and manufacturing concerns in this country for a long time.

There has been a tendency lately, in connection with various organizations, to seemingly lower the standard of efficiency of the men. I believe that an apprenticeship system will offset that tendency and raise the standard permanently for the future, as it should be raised, so that instead of going through our shops and comparing the present class of men with those of fifteen or twenty years ago, and commenting as we do now that they are not up to the old standard, that we may in a few years from now look through the shops and find the standard constantly improving, and so that others may look to the railroads as an example of the best methods of raising the caliber and the general standard of mechanics. There is a common tendency in shops for foremen to feel that they, in taking young men into the shops as apprentices to become mechanics must get all they can out of them—to get all the value possible at the first from their services, forgetting that one of the desirable features in training apprentices is to make them first-class workmen. The value cannot always come in the first year of their apprenticeship, but just as surely as they are properly trained, the value will come to the company and to the community at large from their services after they have been properly trained, and I think we should not forget to make the proper training of the young men the first consideration, and the getting of the value of their services in the first year of their apprenticeship secondary. Surely the best results will come in the end by carrying out this principle.

The apprentice school of the Central of Georgia at Macon, Ga., was described by C. L. Dickert. This school was organized August 1, 1912, under the direction of D. C. Buell. It, as well as several others similarly designed and operated under the same management on the Illinois Central, developed from the fact that there was a shortage in available mechanics competent to take responsible and well paying positions, and a principal object was to train men in accordance with shop ideals and standards so that when vacancies did occur competent men could be taken from the ranks to fill them.

The total enrollment is 75. Several of these included in the total enrollment are messengers used in the shops and several others are rivet heaters in the boiler shop. One-half hour each day is devoted to class room work, the apprentice being paid for that time and his attendance made compulsory. The subjects, mathematics and reading working drawings, are taught on alternate days. The enrollment is divided into nine classes, each class reporting every thirty minutes, from 7 to 9, and from 9:30 to 12.

This half hour period every day is contrary to the practice of most apprentice schools, most of them having two hour periods two or three times a week. It was not adopted, however, for convenience. Consider the fact that nearly all grammar schools have only thirty minute periods, and the class periods of the universities are not over one hour. Thirty minutes is about as long as a boy can be kept well interested on one

subject. Other advantages of the half hour period are that the instructor can see the boy every day, keeping fresh in his mind the thought of improving every opportunity, and the classes can be made small, allowing the instructor to give each boy almost individual attention.

As to the subjects taught, the first thing necessary for the boy to know, after he learns the use of his machine and tools, is to learn to read a drawing; therefore, we give him the subject of "reading working drawings." Mechanical drawing is nothing he can use in the shop, and while it teaches him after a while to read a drawing, it is rather a roundabout way to get at it. In teaching "reading working drawings," the instructor makes use of a straight-edge, triangle and compasses on the blackboard, showing some of the principles of geometrical construction, also requiring the boys to use these instruments frequently. It is also necessary in teaching "reading working drawings," to have the student make many sketches on the boards and on paper. After completing this course a thorough study on shop sketching is taken up. When completing these two subjects, without the boy knowing it, he has really learned the biggest part of mechanical drawing, except the use of the instruments and lettering. It has been planned that in the last six months of a boy's apprenticeship, he can, if he wishes, take mechanical drawing and learn the use of the instruments, lettering, etc., so when he finishes his apprenticeship, he will not only have a knowledge of reading drawings, but he will know enough of actual drafting, so that if at any time he should want to start in drafting, he will have the knowledge to enable him to get started and make some progress with it.

It takes a year, or a little more, to complete the drawing and sketching; after that on the drawing day, work is given that might be classed as specific shop instruction; that is, instruction relating directly to the work in the shop. At that time, the various crafts which have been mixed in classes, are divided and the boys are given specific instructions relating to their particular trades.

On mathematics day the beginner in the shop is started at the very beginning of arithmetic with addition, and is so instructed that at the time he has finished the drawing and sketching he will have gone through addition, subtraction, multiplication, division, fractions and decimals, which are so essential to a man in the shop.

Applications for employment are rejected unless the boy has gone practically through the grammar school, but even then he is not as thorough as he should be in this part of mathematics, and a review is necessary. Shop arithmetic is carried practically through the four years as far as trigonometry.

In addition to the work already mentioned, from time to time lessons in spelling, composition and penmanship are given. Also matters of general information, so that when the boy finishes his apprenticeship he has gotten something which he can use whether he becomes a mechanic, business man, or anything else. On the other hand, he will have something that will be a definite dividend-bearing asset to the shop. Half the time the generous thing is done by him, and the other half of the time he is specialized for railroad work.

With this apprentice school the instructor has nothing to do with the boy in the shop; therefore, not interfering with that organization at all. In some cases where the apprentice instructor is responsible for the boy in the shop, the men in the shop seem prone to shift the responsibility of the boy and of course lost interest in him. It is the desire of the apprentice school to have the whole shop organization work in sympathy with it, and to take a more active interest in the welfare of the apprentice, and to feel that they are responsible for him.

The cost of this apprentice school is made very low on account of the educational bureau having charge. The educational bureau can do all the text book writing and work of that kind without putting on any extra force and without much other ad-

ditional expense. The cost for each apprentice per year is \$20.

A large number of lantern slides showing apprentice schools, methods and apparatus used both in industrial plants as well as railroads were thrown on the screen and described by Mr. Cross.

Henry Gardner, supervisor of apprentices, New York Central & Hudson River, drew attention to the probable accidental elimination of the subject of shop practice under railroad schools. He pointed out that this was one of the most important subjects to be considered. The value of studying the personal character and habits of each apprentice was also mentioned. It is the practice on the New York Central to require a report on the qualifications and character of each graduate two weeks before his time is up. A copy is furnished each shop that may require his service. The general foremen are urged to visit the apprentice schools at their shops at least once a week and thereby indicate their support.

DRIVING BOXES

Three papers were presented on this subject, abstracts of which follow.

MR. LOGAN'S PAPER.

George H. Logan, general foreman, Chicago & North Western, Missouri Valley, Iowa, said in part:

The driving box and its component parts, viz., binders or pedestal braces, shoes and wedges, form one of the most essential parts of a locomotive and when properly machined, assembled and taken care of, give the engine crew and roundhouse foreman but little trouble and prolong the period in which engine may be kept in service between shoppings to a considerable extent.

The combination mentioned is valueless, however, if any of the three stipulated conditions—proper machining, proper assembling, and proper care—are not carried out. If wedges are not properly set up and if the engine is allowed to make a few trips with loose main wedges, due to carelessness or indifference, the setting up of these wedges will not eliminate the pound, and particularly is this true of a left main box on a right lead engine, or vice versa. The pound is still there—the box does not pound in the jaws but the journal pounds in the brass and unless the wheels are dropped and the brass rebored or renewed, any or all of the following troubles are invited: The breaking of frames, rods, rod straps, crank pins, crosshead keys, pedestal, binder, frame, deck and cylinder bolts; excessive wear on the rod bushings and brasses, the loosening of the wrist pin bearing in the crosshead, the crosshead and spider fit on the piston rod, and, if a Stephenson valve motion is used, distortion of valve gear. In fact, we do not believe any one can estimate the resultant damage of a main driving box pound, with any degree of accuracy, as many of the breakages and defects mentioned above do not occur or become evident until after the pound has been eliminated, but were nevertheless due to straining of the metal or the starting of indiscernible cracks while under the stress of a pound.

The importance of keeping binders tight in frame, jaws and wedges set up so as to preclude possibility of any other than the intended vertical movement cannot be too greatly emphasized.

Special attention should be given left main driving boxes on right lead road engines, as this box is subjected to a harsher shock from the piston thrust than the right. To make this point clear, let us assume the wedge to be at the back of the jaw and the shoe to the front on a right lead engine working in forward motion, and we find that these conditions exist at the time of steam admission to the front of left cylinder, and the left main driving box is against the shoe. At the time of steam admission to front of right cylinder the right main driving box is against the wedge. At time of steam admission to back of the left cylinder, the left main box is against the wedge. At the time of steam admission to the back of the right cylinder, the right main box is against the shoe. It is now apparent that the right box is in position to receive the shock of the piston thrust while the left must be forced from the shoe to the wedge and the wedge to the shoe for each revolution while engine is working steam.

This accounts largely for the excessive worn flat spot on the left main tires due to a slight slip of the wheel necessary to change the position of the box from the shoe to the wedge, or vice versa. Slip will also be perceptible if the brass is slightly larger than the journal. While the Chicago & North Western have no left lead engines we will guarantee that where they are in use, the right main box pound is as much a source of trouble as the left on other systems.

Driving box troubles are more frequent on engines having underhung springs than those with springs on top of frames, not because the difference in suspension causes excess wear or strain, but because the wedges and wedge bolts of an underhung spring engine are neglected in service. Where one of two wedge bolts is broken a block is substituted.

The correct adjustment of wedges is an important factor; on the road the average engineer takes advantage of the time at a meeting point or a stop of a few minutes for any reason and spotting his engine with the right crank pin slightly in advance of the top quarter, he loosens the nuts on the wedge to be adjusted, gives the engine enough steam to pull the drivers against the front jaws, or if the brakes are back of drivers, sets his drivers, and pries up wedge with small bar, then tightens the wedge nuts and if the parts are properly machined he has set the wedges up under ideal conditions, and it should give him no further trouble.

We use babbitt metal on the hub side of our driving boxes and in addition to a dovetail recess we use a number of brass plugs, which are cast a trifle full, of $\frac{3}{8}$ in. diameter, are $1\frac{1}{2}$ in. long with three grooves $\frac{3}{8}$ in. wide and about $\frac{3}{32}$ in. deep at one end. These plugs are driven in the box and serve a double purpose: To help hold the babbitt to the face, and in addition the plugs are spaced so that in case the babbitt breaks and loses off, the plugs cover the wearing surface on the driving wheel hub and keep the box itself from the hub temporarily. In addition to the brass plugs on the hub face of our boxes, we have woven copper wire criss-cross around these plugs and have found it very helpful in retaining the babbitt.

We have a large number of our engines equipped with the Markel removable hub plates, a very ingenious device which makes lateral troubles on these engines a matter of small import.

Another source of trouble we experience is the breaking of shoe and wedge flanges on some classes of our power. Of course, there is a logical reason for this and in the majority of cases it will be found that the driving box is of insufficient width and does not have flange bearing enough on the frame jaws and the thrust of the box tends to force the shoe and wedge through the jaw, breaking off the flanges.

Our road is making what we call the flangeless shoe and wedge installation on all of its modern power, and on the engines so equipped broken flange trouble is a thing of the past, as there are no flanges to break. This installation, however, is not faultless, as it transfers wear from the shoe and wedge flanges to the driving box flange and will decrease its life to some extent, while, on the other hand, plates applied to the sides of the frame jaws will prevent any possible frame wear at this point, and is, therefore, a point in favor of flangeless shoes and wedges. If you have broken flange trouble from insufficient box flange bearing, you can overcome or reduce breakages to a minimum by the use of a generous fillet in your shoes and wedges and by planing the side surface of both shoe and wedge on the hub side $\frac{3}{64}$ in. lower on the part that extends beyond the jaw faces. This takes all torsion from the box thrust and overcomes the tendency to force the box against the jaw, as the impact is entirely on the flange, which in turn is forced fairly against the side of the jaw.

If correctly designed and provisions made for bronze, not brass, liners on shoe and wedge faces, cast steel boxes are practically indestructible and should last a life time.

Driving boxes finished, except for boring of the journal and the facing of hub side, shoes and wedges finished, except the

face, should be carried in the storehouse stock. This practice is followed on the Chicago & North Western.

Boxes for stock are usually machined in lots of 12; they are first placed on a double head planer and the sides are surfaced. Next they are delivered to a large slotter and slotted two or three at a time, for the brass and cellar fit. From the slotter they go to the hydraulic press, close to which is located the lathe, where brasses are turned to fit the boxes. As soon as the brass is turned it is placed on the box and end bearing marked by gage, taken to shaper, shaped, pressed in the box by a hydraulic press at a pressure ranging from ten tons on small cast iron boxes to twenty tons on large cast steel boxes. The boxes are then taken to a double head planer, clamped six to each side of form or parallel block and planed. In planing the insides of the flanges a double tool is used. From the planer, the boxes are taken to a four spindle drill press and drilled for the oil retaining plug and cellar bolt holes. They are then coated with an anti-rust compound and placed in the storehouse stock. The draw-cut shaper is being given preference by most railroads in machining the boxes for the brass fit and is also used extens-

sought for have been very fully attained, and from the time a driving box, piston, crosshead, or rod arrives for repairs, it is never placed on a truck or any other conveyance, unless it is necessary to send it to the blacksmith shop or in case it needs some unusual repairs.

The movements of the different parts are as follows:

Driving boxes, if old, when taken from the wheels, are taken to the lye vat, returning by way of the transfer table, engine hoist track, and track in the center of the shop, and placed alongside the planer near the slotter, from which point they are handled by the crane; first to hydraulic press, to have the brass removed; second to the planer; third to the babbitt fire and are then (if old) picked up with the hoist on runway and drilled on a 36 in. drill press. If the boxes are new, they are removed from the planer with the crane attached to the wall and drilled on a gang drill press, and then placed for babbitting by use of the two cranes. After babbitting the boxes are bored, the saddles and cellars are fitted and are ready to be taken to the wheels for fitting on the axles. A groove is turned in the outside of the brass for a shoulder, after which the brass is slotted on the out-

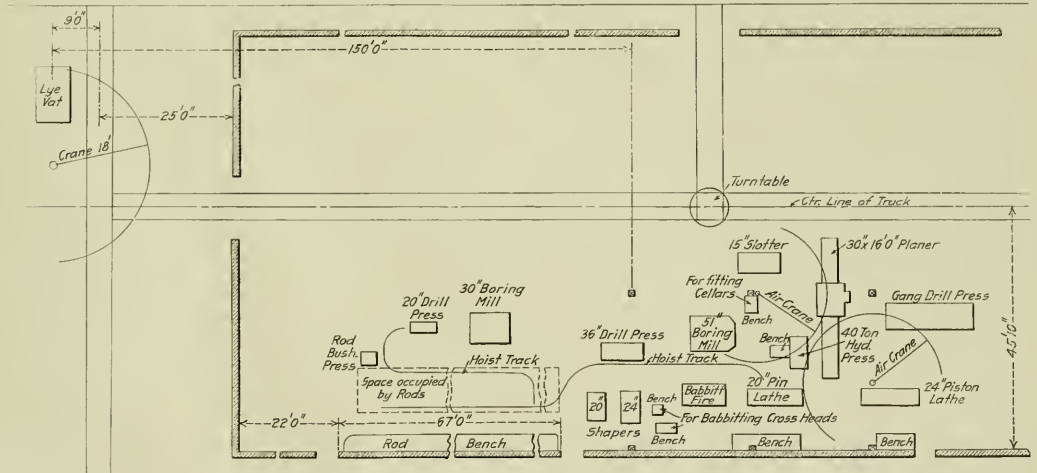

Arrangement of Tools for Driving Box, Piston and Rod Work at the Winona Shops, C. & N. W.

ively in machining the brass for the box fit. I prefer a lathe in spite of another handling at the shaper for this reason.

Most of our boxes are chamber cored or recessed for babbitt, averaging in depth about $\frac{3}{8}$ in. The boxes are so designed that the babbitt sets out beyond the box face at least $\frac{1}{8}$ in. This leaves at least $\frac{1}{2}$ in. of brass not necessary to turn in fitting, and we turn up to it, face off square and then have a shoulder averaging $\frac{3}{16}$ in. to press against the face of the box. It is a big factor in the maintenance of tight brasses.

A shop of any considerable size should have the machine tools grouped for repairing driving boxes, with suitable cranes or air hoists to make moves for different operations in as short a space of time as possible. If babbitt is used for hub faces, the turner's bench and fires, preferably gas, should be close to the boring mill.

At the Winona shops of the Chicago & North Western there is an ideal lay-out for driving box work. This was planned and carried out under the supervision of Chas. Coleman, master mechanic at that point. The principal item taken into consideration in locating these machines, in addition to having them convenient for the work, was to eliminate all the trucking possible, and the experience of ten years demonstrates that the objects

side for the box fit ready for pressing in, special tools for caliper-ing being used.

Lathes for fitting the crosshead pins and turning pistons and rods are located closely together near the babbitting machines, so no trucking is necessary. All crossheads are babbitted on machines and no planing is necessary.

Shapers are located handy to the rod benches and the brasses can be planed and babbitted without trucking; when ready to have the bushings pressed in, they are lifted by an air hoist on the runway and pressed in on an air press and taken to the 20 in. press for drilling; the job is completed and they can be returned to horses until wanted or be removed to the engine.

Brasses should be pressed out at once and new brasses fitted and pressed in. Prior to this, cellars have been examined, defective ones scraped and new ones ordered and they are now fitted to the boxes, care being taken that the box is not spread in so doing. I believe time is well spent in close and substantial fitting of cellars. Babbitting to build out loose fitting cellars is radically wrong. Cellars should be of heavy cross section capable of withstanding the closing tendency of boxes, thus maintaining the shoe and wedge faces parallel.

MR. DICKERT'S PAPER.

C. S. Dickert, assistant master mechanic, Central Railroad of Georgia, said in part:

The first and most important step is to perfect your organization. Get a good man lined out on this class of work, get him interested in the work, and you will get results. Have a system of handling the work from one machine to another; keep regular men on the machines if possible, and if this cannot be done, always use the same man on the job, that he may become efficient in this particular class of work; keep in touch with your men, go around and talk to them and see that they have the proper tools and that the machines are kept in good order.

Begin with a shop order covering, say, sixteen driving boxes, to be machined for a certain class of engine. A copy of this order is furnished the machine foreman, who issues a storehouse order for so many pounds of castings. This ticket is given to the material clerk who delivers the boxes to the floating gang, to be transferred to the machine shop and placed at a 52 in. boring mill, where the first operation begins. They are faced both sides and counterbored on the hub side for the liner, all boxes being made of the same thickness. They are handled from the mill to a 15 in. slotter by a jib crane, and are slotted for the brass and cellar fit. When this operation is completed, the brasses are fitted to the boxes on the same slotter. The slotter is equipped with a special chuck and tools for machining brasses, they being finished ready to press in the box in one chucking. The man machining brasses drives them in the box with a hammer to about one inch, to know he has the proper fit. They are then handled with the jib crane from the slotter to a 100-ton hydraulic press, where they are pressed in. The drill press is located just a few feet from the press, where the boxes are next handled for drilling the holes in the hub face for copper plugs, holding the hub liner. Pouring on brass for hub liner is the next operation, and is done in the copper shop in easy reach of the same jib crane. We have a tilting furnace and use scrap brass for pouring on all hub liners; and find it much more economical than bolting the liners on the box. After liners have been poured on, they are placed at the planer, where they are clamped down to the bed, hub face up, and a rough cut is taken off the hub face with head on cross rail, and the flanges are cut down with the side head. This operation may seem useless, but I find by having a true face to bolt up to the angle plate, and flanges true to clamp down to the planer bed, there is some time saved in chucking, as well as there being no danger of boxes moving under heavy cuts and feed, as there is when built up on liners. I have a double angle plate, or sections of angle plate the full length of the planer bed, thereby enabling me to machine a double row of boxes, using two heads on the cross rail at same time. I have, in connection with angle plates, a device attached to the cross rail of the planer and angle plates for flaring the flanges, not having to unchuck the boxes and line behind them to throw them out of line for flaring.*

The boxes are next placed on a draw cut shaper and the cellars are fitted; then they are moved to a drill press for the cellar bolt holes and plug holes to be drilled. The plug holes are all drilled the same size; all plugs are made and driven in.

The boxes are placed in stock to be issued on a storehouse order and charged direct to the engine.

MR. NEWMAN'S PAPER.

C. M. Newman, general foreman, Atlantic Coast Line, Rocky Mount, N. C., said in part:

The data I have is based on the information I have gathered from twenty of the largest railroads of this country, representing about 21,353 locomotives.

The first operation in machining new driving boxes is to strike off the hub side and the opposite side. This is generally done on a heavy planer, requiring from 30 minutes to one hour for steel boxes. This time only represents a few shops.

The next operation is the cutting of the crown bearing fit and the cellar fit; this in some places is done on a planer or shaper, but usually on a slotter or draw cut shaper. The times on the machines most generally used are as follows: From one to three hours on the slotter and from fifty minutes to one hour and thirty-five minutes on the draw cut shaper. The draw cut shaper shows the best results.

The machining of the crown bearing is the next operation. There seems to be a variety of ways of performing this operation. Some shops turn the circle on a lathe or boring mill and plane the edges on a shaper or slotter; others do the whole operation on slotter, crank or draw cut shaper. The best times given are in favor of the draw cut shaper with special chuck and gage. This is from seventeen to fifty minutes from the start of the operation to the time the brass is ready to press into the box. On the draw cut shaper, one chucking and one tool completes the operation. The brass is then pressed in the box, preferably by a hydraulic press.

The box is now ready for the machining of the shoe and wedge fits. This is generally done on a heavy planer by clamping a number of boxes to an angle plate. The time for this operation per box ranges from one to three and one-half hours.

The cellars are then fitted to the boxes; they are next delivered to the drill press to have the cellar bolt holes, plug holes and oil holes drilled. One road, I find, uses a cutter in the drill press to cut the oil grooves for the shoe and wedge face instead of the hand or pneumatic hammer, which makes quite a saving. At this point, if there are any crown brass retainer plugs to be applied they are put in and then the box is delivered to the machine for crown boring. This is generally done on a horizontal or vertical boring mill. The best time given is on a horizontal boring mill on which the facing of the hub bearing and boring of the brass is done in twenty-five minutes.

The machining of second hand boxes is practically the same, except that the new work has some additional operations.

From the above it will be seen that for economical handling of this work we should have a slab miller for shoes and wedges, a heavy planer, a small powerful quick return planer, a draw cut shaper with attachments, a horizontal or vertical boring mill, a drill press, at least a fifty-ton hydraulic press and sufficient crane service to handle the parts from one machine to the other. With these machines so located as to have the work on the parts a continuous operation, there is no reason why a maximum output could not be obtained at a minimum cost.

Of the shops I have heard from, fourteen have a special machine grouping for driving box work.

On most roads that are using cast steel boxes, brass inserts or liners are applied to the shoe and wedge fits to keep them to a standard. These liners are held secure by the boxes when being molded, having dovetailed recesses or cavities left in the shoe and wedge fits, extending across them. In some cases, on second hand boxes, these cavities are machined diagonally across the shoe and wedge fit, making two cavities diagonally the entire length of the box. The metal is poured on the box, using a mold to give the required thickness to allow for machining. By this method the life of a cast steel box is almost unlimited as far as getting too small across the shoe and wedge fit is concerned.

The hub or lateral wear is taken care of in a number of ways and by numerous applications. In some cases, brass is applied to the boxes or to the wheel hubs; in some cases babbitt is used; one road has made a test of brass on the wheel hubs and removable fiber plates applied to the boxes. The road which has used the fiber plate on the box gave it a three year test on heavy power with good results. It is claimed that the lateral on a ten-wheel locomotive can be taken up in from five to seven hours. These fiber plates are $\frac{5}{8}$ in. thick and are held in place by a recess on the box, $\frac{5}{16}$ in. deep; this taking care of a $\frac{5}{8}$ in. wear.

A test is being made by one road of applying a removable collar to the axle next to the inside of the box, and applying

*See page 414.

brass liners to take up the wear. This is being done without disturbing any other parts. I do not think this device has had a very long service test as yet.

The method generally practiced is to apply metal to the hub side of the box or the wheel hub. When applied to the box, it is held in place by a counterbored cavity on the box and is made secure by the application of pins. I have a record of one road which has the boxes cast with this cavity, and it is claimed that its roughness assists in holding the metal secure.

When pouring the metal on the boxes, on the hub or on the side for shoe and wedge face, some difficulty has been experienced in locating the oil holes. A method for preserving the holes has been suggested by applying a pin to the holes and placing around it a piece of small copper pipe. After the metal is applied, remove the pin and let the pipe remain in place.

In building up the hub of the wheel, the hub is bored out and a brass plate is applied, being held in place by countersunk rivets or bolts. Another scheme is to have these plates cast in halves, with dovetail ends, and fit them up and then machine to fit the cavity, securing them to the hub by countersunk bolts. Another method is to pour babbitt in the hubs to the proper width and thickness, using molds, which will require no machining to the hubs. Another method is to give the wheel a double dovetail counterbore and brake or make a nick in the sharp edges in several places to prevent the liner from turning and stand the wheels on end and pour brass on the hubs, building up to the required amount to allow for machining.

Of the roads I have heard from, fourteen use brass on the boxes or wheel hubs for taking up the lateral, four use babbitt, two use cast iron on the wheel hub and brass on the box.

DISCUSSION.

The method that has proved so successful on the Lake Shore & Michigan Southern of casting the brass and hub liner in place in the box was described by one of the members.* This practice is also being tried by some other roads.

The cast brass hub liner on the wheel centers, held in place by patch bolts previously applied, was favored by one of the speakers. The necessity for providing good lubrication of the hub liners was mentioned by several speakers.

Because of the cost of keeping up the cutters, the practice of using milling cutters for machining the shoe and wedge channel in the driving boxes has been generally abandoned.

The long main driving box which has been applied by the American Locomotive Company to a few large locomotives† is reported as being fully successful. It appeared to be the general belief that all brasses should be bored as near to a journal fit as possible.

Cleaning the perforated plate used in grease cellars at frequent intervals is necessary. This should be done with steam and never by heating the plate in the firebox or forge. The latter method distorts it and prevents proper lubrication. It seems that old grease can be forced through a fine strainer which will clean it and make it fit for further use.

The practice of using a cast steel box with a cast iron wedge was condemned. The liners should be poured on the shoe and wedge faces of the driving boxes in such cases; brass liners were favored. While the horizontal boring mill was admitted to have some advantages for boring and facing driving boxes, one speaker favored the vertical turret lathe for this work. The Lucas forcing press was also reported to be fully successful for pressing in the brasses.

Air hoists on trolleys, spaced the proper distance apart to handle the boxes to and from the journals and to the various machines, have shown a decided saving. The importance of properly selecting and locating the machines for this work was mentioned by several members.

SHOP SCHEDULE*

By HENRY GARDNER.

Scheduling and routing work in a railway repair shop is not new. These methods have been and are used successfully on the Chicago & North Western, Atchison, Topeka & Santa Fe, New York Central, Lake Shore & Michigan Southern, Boston & Maine, Canadian Pacific, and in a more or less modified form on many other roads. The system described in this paper is the same as all others in principle but quite different in design and application. It was introduced in the West Albany locomotive repair shops of the New York Central in January, 1912.

This scheduling system is simple and flexible and maintained by the regular shop force and does not displace any portion of or the arrangement of the existing organization and does not antagonize it in any respect. Every feature of the work is fully under the jurisdiction of the local shop management and is not subservient to any outside agency. The whole scheme must be supported generously and enthusiastically by the management; not only the foreman and the shop superintendent, but the superintendent of motive power and the general manager must give it their endorsement and approval.

The fundamental principles of this system have been very extensively and profitably used in manufacturing and industrial plants and there is no tenable reason why these selfsame methods cannot be applied to railroad repair shops. The usual argument made by the railroad officials against the adoption of these up-to-date principles is that the cost of clerical or non-productive labor is much greater than the benefits derived and money saved. These objections have been entirely disproved and overruled at West Albany on account of the low cost of clerical help and the simple and practical nature of the work. It has been further argued that repaired material cannot be successfully scheduled, especially when manufacturing work is done in quantities for outside shops and engine houses, but this can all be provided for by setting aside certain machines and men, if necessary, for this work. At West Albany a leading man is detailed to supervise the manufacture and delivery of all material to outside points. Such work is not dated or scheduled and it can be run through a shop using the scheduling system just as easily as an extra or special train may be run over a division without altering existing time tables. This whole matter does not present an obstacle of any weight if the spirit is ever present to make the new system a success.

"Scheduling" means listing in order of dates or naming in consecutive order. "Routing" means determining the path or route over which material will travel in its natural course through the shops. After determining the route of a part it is scheduled; that is, dates are set for each stop and start that the part makes from the time it leaves the erecting shop until it returns again ready for completing the engine. The problem of scheduling and routing then resolves itself into providing a proper predetermined date or day of the month when each part, or group of parts, will arrive at and leave the various departments comprising the path over which it is to travel and finally arrive at the erecting shop when wanted for completing the engine. In the same manner the principal operations necessary to assemble the engine in the erecting shop are also subdivided and given dates in proper order for its completion.

In most railroad repair shops the date for the delivery of the entire engine is all that is planned ahead, but why is it not just as necessary to plan ahead a date for the cab or the wheels? Will not the same principles of foresight and preparedness hold good in either case? When this planning ahead is not done more or less confusion must exist, especially in the large shop. Frequent delays occur and a delay in one department will usually counteract all the good work of every other department. Parts are misplaced, side-tracked or forgotten, for days and sometimes weeks; suddenly when the engine is nearly finished someone

*For full description see *American Engineer*, April, 1913, page 199.
†See *American Engineer*, August, 1912, page 393.

*See also *American Engineer*, October, 1912, page 539.

discovers that one or another piece is missing and the result is a general hunt, oftentimes unsuccessful, to locate this part and rush it through in order to deliver the engine on the promised date.

The schedule office should be centrally located, preferably in the center of the machine shop and close to the foreman's office. One competent man with shop experience and an assistant for office work and checking is all the force required with this system to route and schedule successfully all the principal operations and material for repairing 90 engines a month. If the shop is a small one, not requiring the full time of a special man for this work, the forms used may be made out by the foreman or sub-foreman.

The first step in introducing this system is to prepare route sheets showing the course of all the material to be scheduled through the various departments. The second step is to determine the number of days to allow engines to remain on pits while undergoing each class of repairs. For example, a Pacific type engine may be given 24 days on pit for a class A, B or C repairs and if it is to get a normal "D general" repair 18 days are allowed; if "E" repairs, 14 days; if "EF" repairs, 10 days and "F" repairs, 6 days. Another engine, a switcher, may be

West Albany. For each engine scheduled there are 15 repair cards, three check lists, two delay sheets and one tickler sheet. Besides these there are three or four other forms of minor importance.

Fig. 1 shows the headings and a few lines of a schedule or constant sheet for erecting shop operations. It is plain that since but very few engines will carry the same dates we must have

N. Y. C. & H. R. R. Co.
M. F. DEPT.
SCHEDULE OFFICE

ERECTING SHOP REPAIR CARD
OPERATIONS

ISSUED TO SCHEDULE SHEET FOREMAN

SCHEDULE NO. 2
ENGINE NO. _____
CLASS OF REPAIR D
DATE TAKEN IN _____ (P)
DATE TO LEAVE _____ (P)
TIME ALLOWED 18 DAYS
SERIES 7-1-12

CLASS OF WORK	DATE WANTED	DATE FINISHED	REMARKS—CAUSE OF DELAY, ETC.
ENGINE IN SHOP UNWHEELED	0		
ROLLER IN SHOP MOUNTED	—		
ENGINE STRIPPED	2		
MATERIAL DELIVERED	2		
ROLLER MOUNTED WATER	2		
VALVE BUSHINGS OUT BUSH IN M. S.	3		
ROLLER FITTINGS APPLIED	9		
ROLLER TEST (TANK ROLLER WORK IN M. S.)	—		
CAB AND PUMP UP	—		

MAIN RODS UP VALVES SET	15		
BRAKE RIGGING O. K.	16		
SMOKE BOX WORK O. K.	17		
PIPE WORK O. K. SIDE RODS UP	17		
ENGINE OUT	18		

GENERAL FOREMAN

Fig. 1—Schedule Sheet for the Erecting Shop.

given but 14 days for a D-general repair since there are less and lighter parts to handle. These figures are generally used at West Albany, but cases may arise when an allowance of 20, 16, 12 or 8 days will better suit the conditions.

Schedules must necessarily be flexible, but once a schedule is made out for an engine it should not be revised unless there is a complete change in the nature of the repairs. The condition of the shop and the demand for the power will, of course, influence the selection of a proper schedule. The best way to determine the number of days allowed is to average the days on pits for each class of repairs for several years back; then, to start with, take off two or three days from these figures to represent the increase in efficiency due to the improved methods. In some shops the time on pits is based upon guesswork or upon a date which may be set to conform to the needs of the division superintendent or some other official. Often we find the number of repairs fixed by the amount of money allowed the shop for the month; such practices are very inaccurate.

About 25 forms are at present used by this new system at

N. Y. C. & H. R. R. Co.
M. F. DEPT.
SCHEDULE OFFICE

MACHINE SHOP REPAIR CARD

ISSUED TO E. Shaw FOREMAN

ENGINE NO. 1965
CLASS OF REPAIR D
DATE TAKEN IN 7-17 (P)
DATE TO LEAVE 8-7 (P)
TIME ALLOWED 18 DAYS

CLASS OF WORK	WANTED FROM ERECTING SHOP	WANTED IN FACTORY SHOP	WANTED IN TANK SHOP	WANTED FROM TANK SHOP	WANTED IN TANK SHOP	REMARKS
MAIN RODS	7-18	8-1	7-30	7-31		
TANK RODS	7-18	8-3	7-30	7-31		
VALVE BUSHINGS MOUNTED	—	7-24				
STEAM (MULTI PRESSURE) VALVES	7-19	7-26				
ROCKER BOLTS	7-19	7-30				
LINKS	7-19	7-30				
MOTION WORK COMPLETE	7-19	7-30				
DRIVING WHEELS AND BOILERS	7-18	7-31				
TANKER WHEELS AND BOILERS	7-18	7-31				
ENGINE TRUCK BUILT	7-19	7-30				

SPRING RIGGING	7-19	7-29	7-20	7-23		
VALVES	7-19	7-24	7-20	7-22		
PIPE (TANKER TRUCK BUILT)	7-26					
DRIVING BELT RUN	—	7-26				
ENGINE FRAME	—					

E. B. Williams
GENERAL FOREMAN

Fig. 2—Machine Shop Repair Card.

a key or master sheet which does not give actual dates but instead numbers representing the number of days allowed for each operation. For example, the O at the top of the second column means that the engine is wanted in the shop and unwheeled O days after arriving on the pit, which is, of course, always that same day. The number 16 after "brake rigging O. K." means that 16 working days after the engine is placed

N. Y. C. & H. R. R. Co.
M. F. DEPT.
SCHEDULE OFFICE

SMITH, BOILER, TANK & CAB SHOPS
MATERIAL CHECK LIST

191

SHEET

ENGINE NO.	DATE LATE	MATERIAL	WHERE DUE	REMARKS
		VALVE YOKES	M. S.	
		MAIN & SIDE RODS	M. S.	
		ENGINE BRAKE RIGGING	M. S.	
		SPRING RIGGING	M. S.	

Fig. 3—Check List for Blacksmith, Boiler, Tank and Cab Shops.

on the pit the brake rigging must be up and finished. This is for an 18 day schedule; for a 10 day schedule the 16 would be 13 which is proportionately less since shortening the whole time of the engine will almost always shorten the time allowed for its material and operations.

Before making out the constant sheets it is often convenient to write out the schedule in diary form stating each day what

is to be done. This form is given below for the first three days of the 18 day schedule:

First day.—Engine in shop—unwheeled.

Second day.—Main and side rods, driving and trailer wheels and boxes delivered to machine shop.

Third day.—Engine stripped complete. Boiler hydrostatic test O. K. valves, links, motion work complete, engine truck boxes, brake rigging, engine brake cylinders and valves, air pump, engine truck wheels, boiler fittings, eccentrics and straps, cross-heads and gibs, pistons and rods, shoes and wedges, steam chests, covers, valve yokes, parts of spring rigging and some guides all sent from erecting shop to machine shop. Frame binders, engine springs and some guides sent from erecting shop to smith shop. Ash pan delivered to boiler shop, etc., to 18th day engine out.

Fig. 2 shows part of a machine shop repair card used to route and date all material from the erecting shop to the machine shop and back again when finished and ready for the engine. Material routed by way of the smith or tank shop, such as brake rigging parts and tender brake cylinders and valves are also carried on this form. To better explain it let us refer to the "side rods" shown in the second row from the top. Since we

N. Y. C. & H. R. R. Co.
M. P. DEPT.
SCHEDULE OFFICE

MR. *E. V. Williams* *July 28th 1912*
GENERAL FOREMAN

PLEASE NOTE STATEMENT OF FINISHED MATERIAL
LATE IN DELIVERY TO DATE.

ENGINE NO.	MATERIAL	DATE	DATE LATE	REMARKS
352	Side Rods	16	X XXX	no brass in stock
500	Main	..	XXX	now in Smith shop
1276		..	XX	waiting for key furnished 7-27
	Piston Valves	..	XX	waiting for rings furnished 7-25
3474	Motion work complete	..	XX	promised 7-26
132	Driving Wheel Boxes	..	X	one not yet furnished 7-27
188	Tender	..	XX	waiting for each day 25
742	R. Engine frame	5	X	now in Smith shop promised 7-25
150	Side Rods	25	XXX	now from erecting shop promised 7-27
1001	Side Rods for Engine	7	XX	if used to be by hand

Fig. 4—Material Delay Sheet.

are now in the machine shop these rods are first dated over from the erecting shop on July 18, next they go to the smith shop on the 30th, on the 31st day they return from the smith shop and on August 3 they are delivered to the erecting shop. The date that these rods should be up on the engine on the erecting shop operation repair card is August 6, so that this date, the third, allows two days leeway for unexpected delays. If a delay occurred anywhere along the route the daily delay report, to be described later, would state that fact and explain the cause. Each department gets a repair card similar to the one just described and carrying all of the material or operations with which it is concerned.

In many cases small repair cards are used for still further extending the dates to gang bosses and job foremen. These are made out in the foreman's office and copied from the large repair card issued to that shop. All repair cards are made out by the schedule clerk from the constant sheets already described and each repair card has its corresponding constant sheet; the only difference between the constant sheet and the repair card is that the former carries simply numbers, as already explained, and the latter carries the actual dates. All repair cards should be returned to the schedule office for record and file after the engine goes into service.

Fig. 3 shows the headings for a material check list as used in the smith, boiler, tank and cab shops. Each department has one of these lists since it is imperative to check every piece of

material or operation which is scheduled. The assistant in the schedule office takes the list sheet each day and visits all departments, marking the engine number and days late, if any, against the items printed on the sheet. The shop where the part is due is also noted in the fourth column. In the "Remarks" column the checker writes the cause for the delay, if any, and the date promised for delivery.

Fig. 4 shows a material delay sheet which is printed on pink paper to accentuate its importance and to distinguish it quickly from the repair cards which are printed on yellow paper. This sheet, with its mate, the operation delay sheet, is filled out from the check list by the schedule clerk each morning and sent at once to the office of the superintendent and general foreman. The delay sheet tells the whole story in a nutshell; what ma-

N. Y. C. & H. R. R. Co.
M. P. DEPT.
SCHEDULE OFFICE _____ 101 _____

MR. _____
GENERAL FOREMAN

PLEASE NOTE STATEMENT OF MATERIAL AND OPERATIONS DUE TODAY

ENGINE NO.	ERECTING SHOP OPERATION	ENGINE	MACHINE SHOP MATERIAL	DATE	ENGINE NO.	SMITH, BOILER, TANK AND CAB SHOP MATERIAL	WHERE DUE
	ENGINE IN SHOP UNWHEELED		MAIN RODS			VALVE YOKES	M. S.
	BOILER IN SHOP MOUNTED		SIDE RODS			MAIN AND SIDE RODS	M. S.
	ENGINE STRIPPED MATERIAL DELIVERED		VALVE BURNING MACHINED			ENGINE BRAKE RIGGING	M. S.
	COLLECTED PARTS		STEAM CHEST OR PISTON VALVES			SPRING RIGGING	M. S.
	VALVE BURNING OUT		ROCKER BOXES			GUIDES	M. S.
	ROCKERS IN PLACE		LINKS			ENGINE FRAME	M. S.
	ROCKER KEYS FITTED		ROCKER WORK COMPLETE			ENGINE SPRINGS	M. S.
	CAB AND PIPE UP		DRIVING WHEEL JOBBED			FRAME BINDERS	M. S.
	VALVE BURNING IN AND BORED		TRAILER WHEELS AND BOXES			TENDER BRAKE RIGGING	T. S.
	PISTON BOLTED TO FRAME AND BOLLER		ENGINE TRUCK BOXES			TENDER SPRINGS	T. S.
	FRAME BOLLER BOLTED TO MOTION ENDS UP		ENGINE BRAKE RIGGING			ASH PAN	M. S.
	GUIDES LINED		ENGINE BRAKE CYLINDERS			STEEL CAB AND STEEL BURNING BOARDS	T. S.
	VALVES IN		AIR PUMPS			NEW PIPE BOX OR BOLLS	M. S.
	MOTION WORK UP		ENGINE BRASS CYLINDERS AND VALVES			NEW SIDE SHEET	M. S.
	SPRING RIGGING UP		ENGINE TRUCK WHEELS			TENDER BARR	T. S.
	ENGINE WATER FLY		TENDER WHEELS			TENDER BOX FOR ENGINE OR FRAME	M. S.
	PLUES SET		COLLECTOR PITTING			CAB NUMBER AND PILOT	M. S.
	GET PIPE IN BOILER HEAT WATER		ECCENTRICS AND STRAPS				
	BOILER WORK O. K.		CROSS-HEADS AND GIBS				
	STEAM PIPES IN		PISTONS AND RODS				
	ROILER LASHED		PISTON AND VALVE PACKING				
	ROILER JACKS O. K.		ENDER AND WEDGES				
	MAIN RODS UP		STEAM CHESTS AND COVERS				
	TRUCK SET		VALVE YOKES				
	BRASS RIGGING UP		ENGINE BOILER O. K.				
	ENGINE BOILER O. K.		SPRING RIGGING				
	PIPE WORK O. K.		GUIDES				
	ENGINE BOILER UP						

Fig. 5—Daily Reminder of Operations and Material Due.

terial or operation is late, to date, where it is delayed and how many days; giving the cause of the delay and the promised delivery date. The general foreman with this report in his hand can visit each department and locate all delays in an incredibly short time; after this he can devote his time to supervision and minor duties.

Fig. 5 shows the "ticker" or daily reminder of all operations and material due. This is a very important sheet since it conveys to the superintendent and general foreman each morning an exact list of what should be finished or delivered upon that day, according to schedule, on all the scheduled engines in the shop. This sheet does not of course always tell what will happen on that day but it reminds the foreman of what should happen according to schedule.

In routing parts under this system it is important to have a

cross check on two or more departments. For example, parts of the spring rigging may be sent direct from the erecting shop to the smith shop, next to the machine shop and then back to the erecting shop. In this case the three foremen interested know the dates assigned for the whole route and can therefore check one another if mistakes occur in transit. All of these forms must necessarily be different for each repair shop, since no two shops will route their material exactly alike, but the principles involved will always remain unchanged.

Too much importance cannot be attached to the proper supervision of the engine when stripped since the list of scheduled material depends upon the report made by the stripping gang foreman who should see that no unnecessary parts are removed and should make careful notes as the work progresses, stating which parts should be repaired or renewed. This record should be sent to the schedule office and from it the repair cards will be made out. No repair card can have the full confidence of all concerned unless it is based upon exact conditions. The master mechanic's report of repairs necessary should be made out and sent to the shop superintendent as usual and while the engine is still in service. An elaborate detailed report is not necessary since the full extent of the repairs to be made can only be accurately determined after the engine has been stripped.

The Despatch Board and Calendar Rule.—The despatch board is the key to the whole situation in the schedule office. It is simply a board, about $3\frac{1}{2}$ ft. x $4\frac{1}{2}$ ft. carrying a T-square slider. On the back of this slider is pasted a paper strip carrying the names of all the materials and operations scheduled. On the slider at West Albany there are 73 items listed under the several departments concerned. The board proper is covered with paper ruled into small squares which contain the numbers of the engines scheduled. There are about 30 rows of horizontal squares, one for each day in the month, and 73 rows of vertical squares corresponding to each item or group of material or operation as listed on the slider. It is now plain that we can readily stamp up the engine numbers in whatever little square comes in line with the date a certain piece or operation is required to be finished or delivered. When all the engine numbers are stamped upon the board in their proper squares the schedule clerk can see at a glance just where each part should be each day, when it should leave and where it should go. He can also tell when

placed on the line for the day in question and by reading along the whole length of the line, first the engine number and then the material or operation, the entire report can be made out in a few minutes. Since all of the delays are posted conspicuously on the board in red ink, a preponderance of red shows at once which department, if any, is weak. The total time required to stamp upon the board all the operations and material for one engine is, for two persons working together, about eight minutes.

1274	1270	242	845	137	157	248
913	213	213	213	1567	1567	1568
3689	3689	3689	3689	3689	3689	3689
34	2168	2168	2168	2168	341	2177
2154	325	325	325	325	192	248
1709	214	214	214	214	214	214
214	214	214	214	214	214	214
1709	1709	1709	1709	1709	1709	1709
214	214	214	214	214	214	214
1893	1893	1893	1893	1893	1893	1893
1893	1893	1893	1893	1893	1893	1893
945	347	347	347	347	942	214
331	3277	3277	3277	3277	1709	1709
314	314	314	314	314	314	314
104	343	343	343	343	341	2135
3475	3454	3454	3454	3454	3454	3454
2475	104	104	3852	3852	3852	3852
2774	3475	3475	3475	3475	3475	3475
1943	1943	1943	1943	1943	1943	1943
1893	1893	1893	1893	1893	1893	1893

Detail Corner of the Dispatch Board.

The question is frequently asked: "How about the apparently large amount of clerical work required to find and assign all of the many dates required?" In reply we say that the "system" is worked out in the office as well as in the shop; all of the forms and the methods of filling them out are carefully systematized so as to make a minimum amount of writing and figuring.

A simple slide rule is used for finding the dates. This calendar rule carries on its back the days of the month for a six months' period, Sundays and holidays omitted. The slider car-

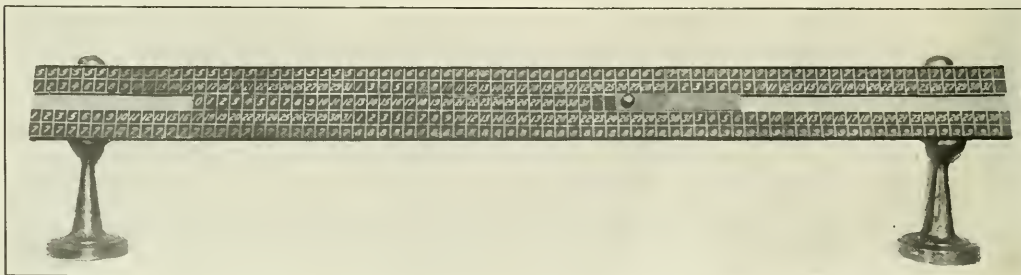

Slide Rule Used In Obtaining the Dates.

a piece is delayed in any department and how many days it is late according to schedule.

There is no information on the despatch board which is not carried somewhere on all of the printed forms, but the board record is a great time-saver through its ability to present quickly all of the data in a convenient form; it is also of great service in apportioning the work so as not to overload any one department. The schedule clerk can optionally throw the dates ahead or back to better suit the congested conditions. The board record is also valuable when drawing off data for plating curves showing the progress of the work.

When making out the daily delay reports the T-slider is

ries the consecutive numbers from 0 to 31 which represent the constants found on the schedule sheets and already described. When once examined this little rule is found to be very easy to understand and operate and by its use the time for writing on the repair cards all of the 278 dates required for one engine has been cut to 18 minutes for two persons working together; one to read the rule and the other to write down the dates. Every six months the rule must be recovered with the paper strips carrying the dates; the slider always remains the same.

Shop Blackboards.—Blackboards are used in the shop in nearly every department for conveying the dates directly to the workmen interested; about 30 are now in use. These boards are

ruled into columns and horizontal spaces having the words "Engine No." and "Date Wanted" at the top of the columns. On some boards it has been found convenient to put on the letter indicating the erecting shop wing where the engine is located and also the initials of the man to whom that particular job is assigned. The dates and engine numbers are all chalked up on the board by the shop foreman or his clerk as fast as they are received from the schedule office.

The men work to the blackboard dates, they are not at all interested in the date the engine leaves the shop; it is sufficient for them to know when their particular product is wanted. When the work is finished the workman or job foreman is only too willing to cross off the dates on the board.

The blackboard is simply an added convenience and a time-saver so that a workman can see instantly just what jobs are ahead and can figure so as to apportion them to the best advantage. It is a great incentive to the men to be constantly confronted with their dates and an engine number not crossed off on the date when the part is due is apparent to all foremen and inspectors.

Benefits and Results.—After a trial of 15 months this system has helped bring about many beneficial results. The shops are now more equalized; departments under or over supplied with men have been reorganized so that they are in harmony with the entire plant. A better feeling prevails in all departments; men are not unexpectedly called up to work at night, their work is laid out for them each day and they see that it is done on schedule time if they wish to avoid delay marks and consequent censure. Friction between departments is reduced to a minimum. An erecting shop foreman when trying to hurry some part in the machine shop is told to get out and come back on the day when it is due and he can have it; there is no other argument unless by special order from the general foreman. A workman can no longer say to his foreman, "You didn't tell me you wanted this done on a certain day," because the date fixes the job and stands for the foreman's written order to the man to perform it.

This system may be used as successfully under piece work as with day work compensation. In fact the piece workers like the "system" because they now get more work and it comes in proper order; for days ahead they know about how much they can make and this regularity is gratifying. The fast workers make more money because they get more work and the slow ones earn more because the incentive of meeting the dates stimulates them beyond their normal output. In some cases it was found, under the old methods, that a man would select a high-priced job for an engine going out much later than the low-priced job at hand. The reason for this was that he might be sick or lay off the next week and the other fellow would get the high price. This condition is automatically corrected by the dating system, since the work must be finished on time regardless of its price.

Another surprising benefit comes from the effect on the men of having the work laid out for them each day. The dates represent jobs and any man will work to the best advantage when he is given a specified job or task to finish within a stated time. A man who is constantly "jacked-up" by a foreman cannot do his best work and is not in the humor to do it if he wants to and the days of relying upon the energy and force of any one man to get results by constant driving are past. The daily appearance of the delay sheet with another "X" added each day that the piece remains unfinished stimulates a workman more than can be estimated.

The foremen praise the system since it relieves them of unexpected censure and when the blame is placed it hits the right man and he always knows it is coming. The general foreman's duties are now much less complex. No system can take the place of foremen, but this system can take the place of endless questioning and running about, allowing the foremen to get in touch with their men and answer questions kindly and patiently. The foremen's duties now become not so much a matter of seeing personally that each man is provided with a job and that

no work is delayed, but of passing upon the quality of the work and giving instructions as to the best and quickest ways of doing it.

COMMITTEE REPORT.

In addition to Mr. Gardner's paper the committee consisting of L. A. North, general foreman, Illinois Central; Geo. C. Bingham, general foreman, Chicago & North Western, and Mr. Gardner presented the following report:

This schedule must not only deal with one part of the engine or machine, but must cover every part so that the completion of the work will not be delayed by the lack of an important item, which will necessarily hold back constant progress. As an example, in a locomotive shop, that is not equipped with a separate manufacturing department, giving an average output of 44 engines per month of which 11 engines are for thorough, 11 are for general and 22 are light, as well as 15 additional engines that are undergoing repairs for the following month, a shop schedule is of the greatest importance. In the Illinois Central, C. & N. W. and other shops the method used in arriving at the proposed figures is as follows: A meeting is held in the office of general foreman once a week. This meeting is attended by the boiler, the machine side and erecting side foremen. Each has the necessary information ready as to about what he can do with the force he has employed. The engines are marked down on a sheet of paper in numerical order as follows: 16 - 46 - 47 - 96 - 109. The first engine is then called off and the boiler foreman asked when he can furnish the boiler for delivery to the machine shop, provided the boiler has been sent to the boiler shop; after this, the date the boiler will be ready for pressure is obtained. The object of this is to give both the machine and erecting side foremen an idea of what date it will be necessary for them to have the cab fittings and boiler studs as well as the dry pipe and other necessary fixtures mounted on the engine. After this date is set both the machine shop foremen are requested to give figures showing just how much time will be necessary to complete the engine for a trial trip.

The information given on this sheet is then sent to the main office, similar information being furnished from all other points on the system from which a general itemized sheet is made up showing just how many engines are held awaiting repairs, how many engines in shop (date in and date out). This sheet is furnished all the general officers. From the first or original sheet both the machine shop foremen on the day following make up the shop schedule which roughly outlined is as follows:

Pit	Engine	Date in Shop	Boiler Over	Ready for Pressure	Wheels for and boxes	Engine on Wheels	Valves set	Date on Trial
-----	--------	--------------	-------------	--------------------	----------------------	------------------	------------	---------------

This sheet is furnished each shop foreman and gang foreman in the locomotive department as well as the shop and gang foreman in the cab department and is usually tacked up in some prominent place in each gang where the men will have access to it. This relieves the gang foreman to some extent, as all understand that the figures must be met or a reasonable explanation given for not doing so. In the Illinois Central there is no given time for any of the work such as fire boxes, flue sheets, light or general repairs as they do not think that a special time limit on work of this kind is successful for various reasons.

The C. & N. W., however, and others have a time limit, which works very successfully, as follows: Light repairs, 64 hours; heavy repairs, 114 hours; general repairs, 144 hours; general and new fire box, 200 hours.

The aim of the largest percentage of the railroad shops today is to turn out the largest output of good work in the shortest possible time. This can be done by the use of a schedule that can be altered by the shop management as the conditions require and by not being held to first figures submitted. Quite often to give any special engine preference means the loss of two or more deliveries that could have been completed had the work been allowed to go along the regular channels.

We are of the opinion that a shop schedule worked out along

these lines will increase the output very materially, conditions, however, at various places will necessarily be met with and changes made to suit.

DISCUSSION.

The difficulty caused by men laying off and thus defeating the prearranged plans was the principal subject of discussion. Mr. Gardner explained that this was the greatest source of annoyance that had developed but that its effect was counteracted by the extra allowance of time provided in each schedule. Apprentices that have been properly trained can sometimes be used to supply the deficiency of men on certain important jobs.

ELECTION OF OFFICERS.

The following officers were elected for the ensuing year: President, W. W. Scott, general foreman, D., L. & W., Buffalo, N. Y.; first vice-president, T. F. Griffin, general foreman, C., C. & St. L., Indianapolis, Ind.; second vice-president, L. A. North, shop superintendent, Illinois Central, Chicago, Ill.; third vice-president, Wm. Smith, C. & N. W.; fourth vice-president, W. T. Gale, machine shop foreman, C. & N. W.; secretary-treasurer, Wm. Hall, C. & N. W., Winona, Minn. Executive committee: C. L. Dickert, assistant master mechanic, Central of Georgia, Macon, Ga.; J. S. Sheafe, engineer of tests, I. C., Chicago, Ill.; W. G. Ryer, general foreman, N. C. & St. L., Nashville, Tenn., and G. H. Logan, general foreman, C. & N. W., Missouri Valley, Iowa.

BRONZE LINERS FOR CROSSHEADS

The Norfolk & Western is using bronze for lining the wearing surfaces of locomotive crossheads, in place of babbitt metal. When the crossheads are removed from the locomotive the babbitt metal bearing is melted off by the use of an oil heater made from iron pipe. The method of doing this is shown in one of the illustrations. Two cast iron formers are attached

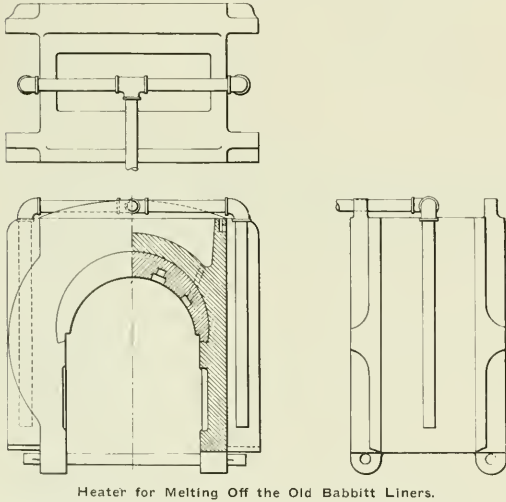

Heater for Melting Off the Old Babbitt Liners.

to each crosshead and lined up so that the difference between the inner surfaces equals the distance between the guides. These formers have a taper on the side of 1/64 in. in order to make their removal easy after the metal has been poured. One of the illustrations shows the crude oil burner for melting the metal. The material required for lining two crossheads is 196 lbs. of scrap brass (old side rod bushings, etc.), and one pound of phosphor copper (1/2 lb. added with the brass and 1/2 lb.

added before pouring). Three pounds of lead may be added, if desired, after the metal is melted, but this is not considered essential. In heating, the metal should be kept well covered with powdered charcoal after it begins to melt and until it is ready for pouring.

Two men, one at 27 cents an hour and the other at 15 cents an

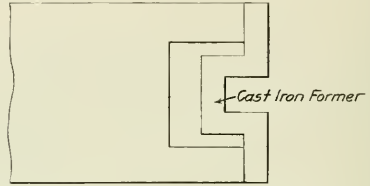

Former Used for Casting Bronze Crosshead Liner.

hour, handle this work quite readily with the assistance of a laborer for a few minutes during the pouring. When the furnace is cold it requires about one hour and fifteen minutes to make the heat, but after it has once been heated up, two crossheads may be finished complete in 55 minutes. No finishing is done

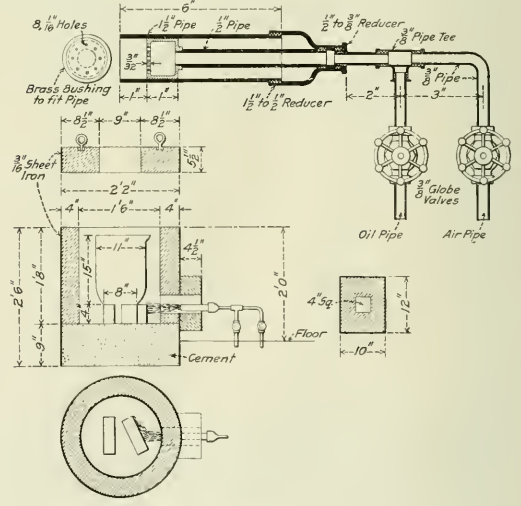

Furnace Used for Heating Bronze for Lining Crossheads.

on the crosshead other than to remove the rough edges by passing a motor driven emery wheel quickly over the bronze surface. Crossheads finished in this way are giving excellent satisfaction and have caused no trouble from not having the surfaces planed.

CHESAPEAKE AND OHIO CANAL.—Five thousand men and boys, assisted by 850 horses, oxen and mules, and a weekly consumption of 9,000 lbs. of gunpowder, are now urging to a completion 102 miles of the Chesapeake and Ohio canal. Sixty-four miles are to be in use on the first of June, and 102 miles on the fifth of October.—From the American Railroad Journal, April 6, 1833.

HARLEM RAILROAD.—It is the intention of the company to have one mile of this road completed and in use by the 1st of October, when those who have apprehended danger from its passing through the streets may satisfy themselves to the contrary. We have no hesitation in saying that it will be found altogether more safe than stages.—From the American Railroad Journal, September 1, 1832.

INSTALLATION AND MAINTENANCE OF ELECTRIC HEADLIGHT EQUIPMENT

BY V. T. KROPIDLOWSKI.

II.

WIRING DETAILS.

In considering any project, every effort should be made to determine the course which, if followed, will give the cheapest cost of installation and at the same time the lowest cost of maintenance. This has been carefully considered in adopting the system of wiring a locomotive for electric headlight equipment which is described in this article. It is first necessary to procure the fixtures and fittings necessary for the work of wiring, which are as follows:

- 1 Crouse-Hinds Y-333.603-S junction box.
- 1 Paiste 88042 enclosed fuse cut-out.
- 2 Type "B," 40 ampere, 250 volt refillable cartridge fuses
- 2 Greenfield box connectors, No. 6131.
- 1 Combination coupling, No. 6075 (Greenfield).
- 1 Combination coupling, No. 6073 (Greenfield).
- 2 Greenfield lead bushings, No. 6042.
- 1 1½ in. Street elbow.
- 1 ¾ in. Street elbow.
- 1 Pipe nipple, ¾ in. x 3 in.
- 1 Crouse-Hinds type F. P., ¾ in. splice box.
- 1 Crouse-Hinds C. C. 1 splice box.
- 1 Crouse-Hinds porcelain cover, No. 23.
- Greenfield flexible steel conduit, D. S., ¾ in. (one coil to start with).

In ordering the above material, a better idea of the appearance and construction of the fixtures and fittings may be obtained by referring to any of the general catalogs of the large electrical jobbing houses, as well as to those of the manufacturers of electrical supplies. The other fixtures that are shown in the illustrations are either furnished by the manufacturers of the headlights or are home-made. Okonite wire with mace braid is a good heat resisting insulated wire, a quality which on a locomotive is very essential.

The first step is to place the junction box on the front face of the cab, locating it high enough so that the flexible steel conduit that leads into the cab will be near the roof, as shown in Fig. 1; the cut-out block should then be fastened in the junction box, Y-333603-s; the assembled junction box, cut-out, connectors, etc., with the cover off, are shown in Fig. 2. Next string the wires through the flexible steel conduit that goes in the cab, and complete the wiring connections in the cab as follows: Insert in the conduit line, so that it will come about opposite the gage and water glass lamps, the type CC splice box, which has a porcelain cover with three holes, and connect the two flexible lamp cords to the proper wires in the junction box, leading them out through the two outer holes of the cover. Connect two No. 14 rubber insulated wires to the same wires to which are connected the two lamps and which are marked + and - in the diagram of wiring shown in the first article of this series (*Railway Age Gazette, Mechanical Edition, July, 1913, page 367*), and lead these two wires through the middle hole of the cover and out to the lamp at the gangway. Next mount the switch on the right side of the cab in a convenient place, connect the positive wire to the switch connection marked +, the negative wire to the one marked -, and the neutral to the one marked ÷. The resistance coil should be mounted right over the switch, as shown in Fig. 4, connecting one terminal of the coil to the positive connection of the switch and leaving the other terminal disconnected, if a Pyle-National or Schroeder generator is used; if the American generator is used, connect the other terminal to the extra contact A. These resistance coils can be purchased from the Remy Electric Company, or can be made by the railroad company. The size and quantity of wire required cannot be determined definitely unless certain details of the generator are known, but in the absence of such data 30 ft. of No. 14 B. and S. gage nickeline-II resistor wire, wound on a suitably proportioned and insulated spool,

will be about right; in case it does not allow quite enough current to pass to the generator a piece can be cut off and another trial made. After having one rightly proportioned, all others can be made like it.

String three wires through the handrail, two size No. 8 and one size No. 14, the latter from the negative terminal of the cut-out to the headlight; the wires from the terminals of the cut-out to the cab switch should all be No. 8. Be sure that the wires strung through the hand-rail are long enough to reach from the junction box on the front face of the cab to the inside of the headlight. Cut a piece of flexible conduit the right length to reach from the end of the hand-rail nearest the cab to the junction box and string the wires that project from the hand-rail through this conduit; then connect the conduit to the hand-rail, as shown in Fig. 5, pass the wires into the junction box Y-333.603-s, shown in Fig. 2, and connect them to the terminals of the fuse block marked +, ÷ and -; after doing this, fasten the flexible conduit to the junction box with connector No. 6131, Fig. 2.

In connecting the generator to the system, take two No. 8 wires of the length required to reach from the generator to the junction box and string them through a piece of ¾-in. flexible steel conduit of the same length. Use a PF2 entrance hood at the generator and set it on a plate C, Fig. 6, pass the wires through it and fasten them to the correct terminals of the generator, as explained in the manufacturer's book of instructions; insert the conduit in the PF2 entrance hood and clamp the latter tight over the conduit by means of screws and a galvanized iron clamp under plate C.

The headlight will then be connected. Next string the wires that are projecting from the hand-rail at the front end through a ¾-in. flexible steel conduit of sufficient length to reach from the front end of the hand-rail to the headlight and fasten the conduit to the headlight case by a galvanized iron clamp, as shown in Fig. 8. Pass the wires through into the headlight, fastening the two No. 8 wires according to the instructions given in the book issued by the manufacturers, only in this case treat the neutral wire, marked ÷, as the minus wire referred to in the books. Special care is necessary at this point, as the Pyle and Remy have the large hole in the positive binding post and the Schroeder in the negative. The writer has known cases where the workman has not looked up the instructions and has cross-connected the arc lamp, resulting in the fusing of the copper electrode. Lead the No. 14 wire through to the incandescent lamps 9 and 10, baring the wires and connecting them to one terminal of the lamps. Take a piece of No. 14 wire of sufficient length, connect one end to the plus binding post of the lamp and the other end to the second contact of lamp No. 9. Take another short piece of the same size wire and connect the second contact of lamp No. 10 with this wire to the minus binding post of the arc lamp, clamping the wires to the lamp cage with cleats, as shown in Fig. 8. The construction of the sockets of lamps 9 and 10 is shown in Figs. 9 and 10, as is also the method of fastening them to the lamp cage; these are the sockets furnished by the headlight manufacturers. The same kind of socket is used for the incandescent lamp at the gangway as shown in Fig. 9.

The incandescent lamps for the gage and water glass illumination are shown in Fig. 11. This shows the outer casing removed to indicate the method of connecting the lamp cord. Fig. 12 shows the arrangement of the gage and water glass lamps. The tin cage previously used with the oil lamp may be utilized by soldering a tin ferrule to the incandescent lamp, as shown in Fig. 12. The ferrule is inserted in the hole in the top of the reflector cage, bringing the bulb inside the cage; the cord should be sufficiently long to allow for the jarring of the locomotive.

The idea of protecting the generator by fuses, and consequently the arc lamp and the entire system, was developed from the writer's experience and observation. Almost without

exception, cases of headlight failure and damaged parts in the electrical equipment are directly due to its not being protected by fuses. Cases of dead generators can invariably be traced to an open circuit somewhere in the generator winding, caused by the abnormal heat created by an excessive current melting the solder off of a soldered connection. Poor regulation of the arc lamp, as well as complete failure of it to strike an arc, is caused by excessive current overheating the regulating mechanism, warping and distorting the parts. The writer has found, in one or two instances, the solenoid of the arc lamp and the fields of generators overheated to such an extent that the insulating varnish, which is baked on at a fairly high tem-

The writer strongly recommends the use of flexible steel conduit in place of rubber hose, and particularly the "D. S." conduit, as the "S. S." is not as flexible and moisture proof.

Referring again to Fig. 4, the contact *A* is not provided with the switch, but must be made up. The wire terminal can be bought, and a No. 1578 (Central Electric Company's catalog, page 110), can be used. The offset strip that connects to the blade can be made of sheet copper.

In connecting the flexible steel conduit to the rear end of the hand-rail, as shown in Fig. 5, a 1/4 in. sheet rubber gasket should be wrapped around the conduit as the hand-rail is 1 1/4 in. pipe and the conduit is 3/4 in.

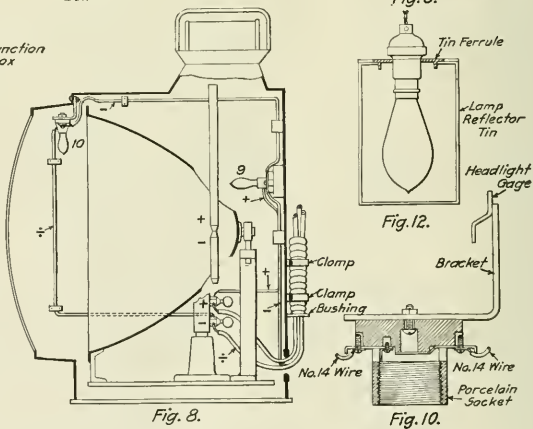
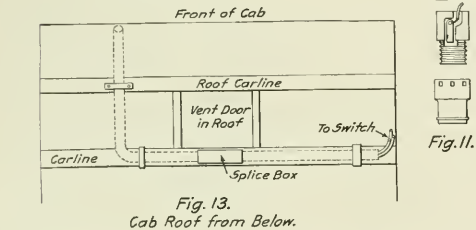
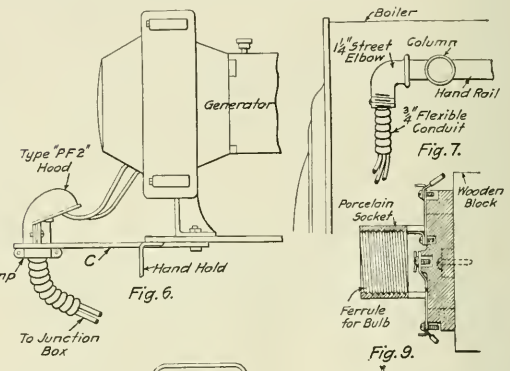
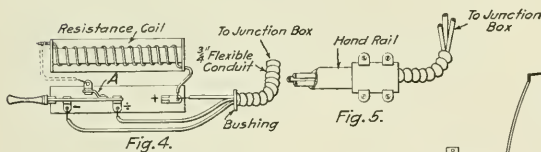
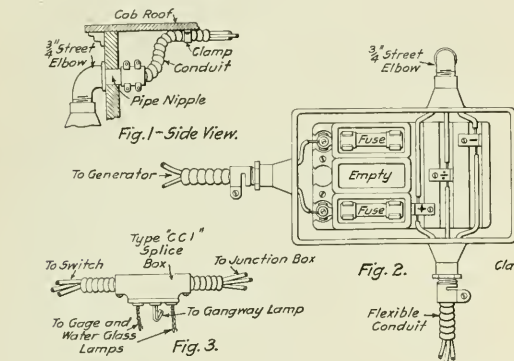

Details of Electric Wiring Installation for Headlights.

perature, was dripping off. All the cases of fused copper electrodes can be practically eliminated by the equipment being protected by fuses. The cut-out block recommended herein is of 60 ampere capacity, and as the manufacturers guarantee their equipments for a 50 per cent. overload, a 40 ampere fuse is about right; it will blow at a point between 110 and 125 per cent. of its rating, which means somewhere between 45 and 50 amperes. This capacity cut-out block also has very sturdy contact clips, which are very essential, as one can tighten down the wires securely and thereby eliminate the disconnecting of wires on the road.

It is not absolutely necessary to employ the junction box Y-333.603-s in this system of wiring; a galvanized iron box can be used but it will not withstand the weather and service as well, and is not as convenient for connecting and disconnecting.

FLYWHEEL BREAKAGE.—Overload is a cause of flywheel rupture when the engine is belt connected. Generally the rim of the wheel is made thin and is, therefore, likely to fail, not only from centrifugal force, but from a short circuit of the electric generator, if used, a sudden stoppage of the engine, or the sudden throwing on of heavy machines in the mill. The greater the velocity of the rim of a flywheel the lighter it can be constructed and still prevent fluctuations in engine speed. There is a tendency on the part of the engineer to run an engine to high rim speed in order to obtain additional power from an engine and wheel designed to do less work. Such a wheel is more likely to rupture from overload than if it had been designed with a heavier rim. When speeding up an engine to obtain more work the engineer should not neglect to take the strength of the rim of the flywheel into consideration.—Power.

RAILWAY TOOL FOREMEN'S CONVENTION

Scrap Tool Steel, Forging Dies and Form of Thread for Boiler Studs Were Principal Topics.

The fifth annual convention of the American Railway Tool Foremen's Association was opened at the Hotel Sherman, Chicago, on July 22, by President J. Martin, machine shop foreman, Beech Grove shops, Cleveland, Cincinnati, Chicago & St. Louis.

E. W. Pratt, assistant superintendent of motive power, Chicago & North Western, delivered the opening address, taking optimism as his theme. He urged the members to look on the bright side of things and to search for the best. He believed that conventions of men occupying subordinate positions on railroads were of especial benefit. As illustrating the value of a good tool foreman he drew attention to what some of the older shops were doing in repairing modern locomotives. In many cases this excellent work is performed without the advantage of many modern machine tools and is largely due to the development of original devices, methods and tools in which work the tool foreman is prominent. In mentioning the requirements of a modern tool room, it was suggested that a good turret lathe might be of considerable value.

RECLAMATION OF SCRAP TOOL STEEL

By J. J. SHEEHAN (N. & W.).

In common parlance, any tool steel which is no longer serviceable for the purpose for which it was originally intended, falls within the accepted meaning of scrap tool steel. We have scrap lumber, which is material that can ordinarily be used for stove or kindling wood, or perhaps for other purposes. We have scrap iron, which is one of the supplies for the cupola or furnace, the material being transformed into castings and articles quite different from their original form; but in scrap tool steel we have a material which, at least as far as the average shop is prepared to handle, cannot be remelted, but can be transformed into shapes and sizes of other tools without altering its original characteristics and value as a tool steel.

A better appreciation of what may be done is illustrated by what has been realized in one plant in the way of reclaiming discarded tool steel, and utilizing it step by step in the various ways and opportunities offered, until the ultimate loss has been reduced to what would apparently seem to be a minimum.

For example, 6,500 lbs. of tool steel was purchased during a certain period, and the average cost was, say, 50 cents per lb. All of this material was worked into tools, and having served the desired purpose, it was found that the sum of the parts turned in as scrap amounted to 2,600 lbs., or 40 per cent. of the original quantity purchased, or taken at the value of the purchase price, represented \$1,300. The process by which the recovery was made was as follows:

The material is separated and classified as follows:

Grade No. 1. This grade embraced all high speed steel, and was identified by a line of red paint the entire length of each bar, and was stored in a section painted red on the outside. After this steel was worked into tools, which included all turning, boring and planing tools, a number was stamped on the body of each individual tool ranging from 1 to 30, from which the name of the steel, the maker and the grade could at all times be traced.

Grade No. 2 embraced all the higher grade 120-point carbon steel, from which taps, reamers and formed tools are made, and was identified by a line of white paint; the section in which it was stored was painted white on the outside. Tools made from this steel were likewise stamped with a number when completed, ranging from 30 to 60, from which the name of the steel, maker, and grade could be traced.

Grade No. 3. This is a 105-point carbon steel, from which chisels, punches, punch dies, rivet sets, and shear blades are made.

This grade was identified by a line of blue paint and the section in which it was stored was painted blue on the outside. Tools made from this grade were also stamped with a number, when completed, ranging from 60 to 90.

Grade No. 4. This was a grade of 90-point carbon steel from which tools for boilermakers, blacksmiths and track purposes are made; it was identified by a line of yellow paint and was stored in a section painted yellow on the outside. Tools from this grade were stamped with a number ranging from 90 to 120.

All tools are issued from the tool room, and returned there when requiring attention. All lathe and planer tools are made from bars having the following dimensions: $1\frac{1}{2}$ in. x 3 in., $1\frac{1}{4}$ in. x $2\frac{1}{2}$ in., 1 in. x 2 in., $\frac{3}{8}$ in. x 1 in., $\frac{1}{2}$ in. x $\frac{1}{2}$ in., and $\frac{3}{8}$ in. x $\frac{3}{8}$ in.

As tools become too short or unfit for further service, they are placed in the scrap bin provided for the purpose, and corresponding to the number on the tool. When a sufficient quantity of scrap tools has been accumulated, it is sent to the smith shop, weighed, receipted for and placed in bins in the steel workers' section, labeled Grade 1, 2, etc., corresponding to the grade of the scrap. This department is equipped with a furnace that will maintain a heat of 2,500 deg. F. with a preheating chamber attached suitable for annealing purposes. There is also a 1,200-lb. steam hammer. This work should be handled by an experienced steel worker, otherwise the results will not be satisfactory.

When a sufficient quantity of scrap grade No. 1 has accumulated, it is placed in the preheating chamber of the furnace, and allowed to heat slowly and uniformly to a dark red, 1,000 deg. F.; the steel is then transferred, at the convenience of the tool smith, to the other chamber and brought to a bright red heat, 1,550 deg. F., and forged to the required size. Pieces $1\frac{1}{2}$ in. x 3 in. are forged to $1\frac{1}{4}$ in. x $2\frac{1}{2}$ in.; $1\frac{1}{4}$ in. x $2\frac{1}{2}$ in. to 1 in. x 2 in.; 1 in. x 2 in. to $\frac{3}{8}$ in. x 1 in.; $\frac{3}{8}$ in. x 1 in. to $\frac{1}{2}$ in. x $\frac{1}{2}$ in. and $\frac{3}{8}$ in. x $\frac{3}{8}$ in. sizes. After forging and dressing for service and given the grade number, the steel is placed in the annealing box and allowed to cool before hardening to relieve the forging strains. From 600 lbs. of scrap steel thus treated there were 500 lbs. of serviceable tools delivered to the tool room, at a reclamation cost of 5 cents per pound; from the service rendered they were the equal of tools made from the original bar; hence the reclamation value of the steel after deducting the cost of reclaiming, 5 cents a pound, was 45 cents a pound, or \$225.

Of grade No. 1, 315 lbs. were worked into cutters for Davis boring bars, to bore 7-in. After these cutters had served to the limit, there were 250 lbs. of scrap steel annealed and redressed for $6\frac{1}{2}$ -in. cutters for boring bars of the same make at a reclamation cost of 5 cents per pound, representing a reclaimed value of \$12.50. After having served to the limit for the $6\frac{1}{2}$ -in. there was 180 lbs. of scrap which was again redressed and used for 6-in. cutters, with a reclaimed value of \$81. After the limit of boring tools was reached, there were on hand 150 lbs. of pieces $\frac{3}{8}$ in. x 2 in. x $2\frac{1}{2}$ in., which were sent to the smith shop and forged into turning tools $\frac{1}{2}$ in. x 1 in. x 7 in. long, with a reclaimed value of \$56.25.

Chaser Dies for $1\frac{1}{2}$ -in. head measured $\frac{3}{8}$ in. x $1\frac{3}{8}$ in. x 3 in. After a number of re-cuttings for the $1\frac{1}{4}$ -in. machine, there were on hand 200 lbs. of scrap dies, which quantity was annealed and reworked for the 1-in. machine at a reclamation cost of 2 cents per pound, with a reclaimed value of \$95. After this service, there were on hand 150 lbs. of scrap dies, which were then worked into tool holder bits, of which there were 50 lbs. $\frac{3}{8}$ in. x $\frac{3}{8}$ in. x 4 in. at a reclamation cost of 5 cents per pound, or with a reclaimed value of \$22.50.

Grade No. 2. From 786 lbs. placed in service at an original cost of 17 cents per pound there were 437 lbs. of scrap annealed for reworking at a reclamation cost of 2 cents per pound, with a reclaimed value of \$65.55, the tools consisting chiefly of taps and reamers; taps ranging in size from 4 in. diameter down. Four-inch taps were reworked to the next smaller size, say 3½-in., and so on down the line. On 1¼-in. taps for flexible staybolts, 1¼-in. diameter, the threads were removed and they were used for reamers for the same purpose. In like manner, after having the threads removed, staybolt taps were used as reamers on boiler work preliminary to tapping for staybolts.

Grade No. 3. From 1,147 lbs. put in service at 12 cents per pound, there were reclaimed 534 lbs. at 2 cents per pound, with a reclaimed value of \$53.40, consisting of punches, punch dies, rivet sets, and flue expander pins. These were handled as follows: By the use of a punch post and nut to fit the spindle of the lathe, all punches were dressed to a smaller size on the point. All punch dies of standard and uniform dimensions were re-bored and faced to any convenient size needed. Expander pins were re-turned to the next smaller size. Rivet sets due to drawing of temper and losing shape in cup were redressed again, hardened and placed in service, with satisfactory results.

By E. R. PURCHASE,
Boston & Albany.

The largest wheel lathe tools of high speed steel we keep drawing down until they reach ⅝-in. or ½-in. square, and then use them in the tool holders.

We have a bench in the tool room for all the different kinds of steel. This bench is partitioned off and a boy paints the scrap tool steel the same as the bar stock and places it on the bench in its proper place. The tool makers go to the scrap bench for stock before going to the rack for new stock and in this manner we utilize the bulk of the scrap steel.

We use a bench for short pieces of bar stock, that is, less than 24 in. long, and by doing this we keep the tool steel rack clean and free from short lengths which are liable to fall among other classes of steel.

We keep a separate shelf for all steel that is to be annealed. All broken pieces of tool steel that cannot be reclaimed are placed in a barrel to accumulate and are sold as scrap to the steel mill. We have tried to use tire steel for rivet snaps with indifferent success, some working nicely and some giving no service. We have used some machinery steel for forging dies but find that a carbon steel for forging dies is economy.

By G. W. NUTT,
Chicago Great Western.

The various tools made from carbon steel which have become worn and unserviceable should be annealed and placed in some convenient place. We have placed a long shallow trough on top of our tool rack in the tool room into which this sort of material is placed. It is really surprising the use to which these pieces can be put. It is a great saver of the bar stock.

DISCUSSION.

It appeared that in most shops there is very little tool steel that needs to be scrapped, especially in the case of tools that are made in the shops where the tool foreman fully understands the quality of material. When the pieces of steel are too small to be used for other purposes they are worked over for use in tool holders or for inserted blade cutters. Several members mentioned the advantage of making worn staybolt taps into reamers for boiler work. In some cases this was done without annealing. It was stated that good equipment is necessary if the best uses are to be made of worn out or damaged tools. In one shop, 319 lbs. of high speed tool steel was reclaimed at a cost of but 5.5 cents a pound. Often it is necessary to design new tools in order to make the best use of the scrap.

The electric welding outfit can sometimes be used to repair broken tools. It is especially good for building new tangs on

twist drills. One member mentioned the fact that the original design of the tool often had a controlling influence on the success of reclaiming it.

How to properly anneal high speed tool steel was discussed at length. Heating slowly in a gas furnace to about 1800 degrees and then slowly cooling was reported as being successful. Packing in cast iron cuttings or in charcoal and then heating are both successful.

It was reported that when the Santa Fe adopted high speed steel, it shipped over thirty tons of scrap carbon tool steel to the manufacturers.

SUPERHEATER TOOLS AND THEIR CARE

By FRED PETERSON,
Colorado & Southern.

We have the Emerson superheater in our engines, which has 24 flues 5½ in. in diameter. These flues are swaged to 4½ in., eighteen inches from the back flue sheet and the 1¼-in. superheater pipes run from the steam pipes back within eighteen inches of the back flue sheet. When we first received these engines we experienced some trouble in keeping those flues tight at the front end. We found that the flues were not beaded at the front flue sheet and this was the cause of some of the leaks. We turned the flues over, beaded and expanded them and the trouble disappeared. Later on instead of removing the steam pipes to get the tubes out, we sawed the superheater tubes off and then pulled them out, thereby causing us to put a coupling between the steam pipe and the tubes; this makes it easier for us to remove the superheater pipes inside the large tubes.

We found again that the check valves in the boilers were close to the front flue sheet and the water striking the superheater tubes seemed to cause them to leak at different times. It would be better to have the check valve placed back further—30 or 36 inches from the front flue sheet.

In putting in the tubes we swage the firebox end to fit a No. 30 copper ferrule. We roll them with a roller, with five rolls, and after turning over we expand with a sectional leaf expander, and the flue is worked practically the same as the standard two-inch flues in locomotives. We find that in using these rollers, it is not necessary, after the engine has been in service for some time, to roll the flues very hard, and merely the weight of the rollers will make the flue tight and give better results than heavy rolling. The front end is also rolled, and we also use a Prosser or sectional leaf expander after the flue has been turned over. By this means we have no trouble in keeping these flues tight.

After removing the flues the first time, we welded on the large end of the flue. This weld is made by the O'Neill rapid tube welding machine. The flue is scarfed and also the safe end; they are then put together and welded. This machine we are now running by a three-horsepower electric motor and it is doing fine work on our large superheater tubes. The piece that we weld on is generally from 10 to 12 in. long, and the scarf made by this machine is superior to any that can be made in a lathe or in any other machine.

By A. R. DAVIS,
Central of Georgia.

The tools used to install and maintain the superheaters are divided into two classes, the tools for the tubes, and tools for the header and other accessories. In the header are many brass ball joints for the pipes in the tubes which must make a tight joint. To maintain these joints they should be a true radius, as it is impossible to bend the pipes so that any but a true radius joint can be depended upon. The tools shown in the sketch were made as recommended by the Locomotive Superheater Company and will produce a true radius for repairs. These tools may be used with an air motor or under the drill press.

Thin socket wrenches of three lengths will be found most convenient to tighten the header pipe joints.

We have made no special tools for the damper control valves so far and any tools necessary will be of the type regularly used on air brake equipment work.

The various designs of oil spreaders in the steam passage require reamers of the design regularly used in the brass department on general work.

We have made but one set of new tube sheets for the super-heater tubes and have had good results from the type of pilot cutter regularly used on bridge work for the large pin holes where the requirements are much closer. The pilot cutter is made with a 1 1/4-in. pilot of tool steel fitted in a machine steel body with a No. 6 Morse shank. There are three cutting tools of high speed steel, 5/8-in. square stock, the tools set with 1-32-in.

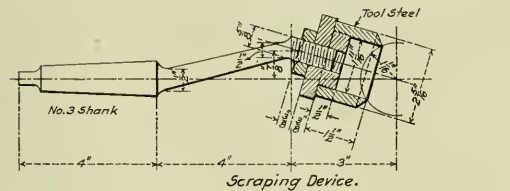
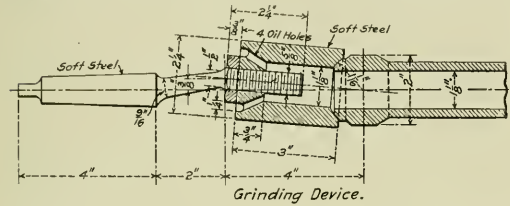

Successful Tool for Finishing the Ball Joint on Unit Pipes.

lead in length and 1-16-in. lead in width. The lead tool is ground as a round nose lathe tool with a rake.

As yet we have not had to enlarge any tube holes to allow tubes that are badly scaled to be removed from the boiler, but in anticipation of this I have made a reamer to enlarge the hole 1/4-in., a bushing to be applied when the tubes are replaced.

The reamer is made with a soft steel body, No. 5 Morse shank, with high speed steel blades, eight in number. The pilot acts as a binding plate for the blades, being fastened by six 3/8-in. cap screws. The blades enter the work at an angle of thirty degrees.

In handling the tube work the tools are similar to the regular tools for flue work. We have no special tool for cutting the tube loose from the sheet.

After the tubes are removed they are cut off and scarfed in the turret lathe. The safe-ends are scarfed to suit and when the tube is heated and the safe-end driven in there is about 1/8-in. overlap, which gives plenty of stock for welding; this is done on a large Draper pneumatic welding machine with good results. The tubes are swaged as usually done on the regular flues, the amount left for the bead being the same. They are cut to length in the turret lathe.

In applying, the tubes are rolled, Prossered and beaded at both ends. The tools for these operations are the same as for flue work except that they are of larger size to suit the diameter of the tube. The beading tool has the radius in the throat increased from 3-16-in. to 1/4-in. and is 1-32-in. deeper in the throat.

We have not had enough experience in handling the super-heater tubes to state what the expense is apt to be in maintaining the tools for this class of work, but from present indications I do not believe that it will be any heavier in proportion than the regular flue working tools

DISCUSSION.

In connection with the proper design of tools for fitting the large boiler tubes, rollers are generally used and the straight type seem to be preferable to the self-feeding design. Considerable discussion arose in connection with the grinding of the balls on the units and the seats in the header. The design of grinder shown in the paper is successfully used at many shops. No grinding at all on these parts had been found satisfactory by some of the speakers. Cast babbitt cups used with emery were reported good, as were also copper cups. These cups are not faced but are used as they come from the mold.

MAKING THREAD CUTTING DIES

By AUGUST METZ,

Pere Marquette.

Select the steel for the chaser as near the size as possible to avoid unnecessary machining. Cut the chaser from the bar, square one end, and drill a hole as required on the machine in which it is to be used. Place the chaser in the holder and remove all excess stock on the heel or the back face. It is best to remove the metal to the center line. The angle or rake of the front face or cutting edge of the die is important and depends on the grade of stock which the die is to cut.

If the chaser is to be used for cutting copper, brass or the like, this angle should be zero, or coincide with a line passing through the axis of the work. For cutting bar iron the angle should be six degrees; for steel or steel pipe the angle increases to twenty-two or twenty-three degrees, making a hooked die. The chaser is now stamped for size and numbered to designate the relative position in the cases and the die head and is secured ready to be hobbled or threaded. Before hobbing, a reamer of proper size is passed through the blank chaser removing all surplus metal by concaving the cutting edge of the blank and leaving but one or two thousandths of an inch to be removed by the bottom of the hob or tap.

After being reamed a hob or master tap is placed in the vise of the machine and is run through the dies from two to five times, depending on the size of the tap. With the larger size taps the dies are cut with two or three passes; but with the smaller taps, which cannot be subjected to such a heavy strain, a light cut is taken and after each pass the dies are set in a trifle by adjusting the die head. After the dies are hobbled, the chasers are removed from the cases and all burrs are carefully removed and the chaser is ready to be tempered, the method depending on the grade of tool steel used.

After tempering, the throat or entrance of the die should be ground to the proper rake or clearance. This should be done by a special machine for this purpose, or by hand.

In threading a die of this type the cutting is all performed in the throat and the thread is completed by the first full thread encountered by the work, the remaining teeth only serving to feed the work and maintain the lead. From this it can readily be seen that the grinding of the chaser is very important in order to obtain the correct angle and the proper clearance.

When the chasers become dull, they are resharpened by grinding the throat; the average set of chasers can be ground or resharpened from 15 to 30 times, depending largely on the method of grinding. It is possible to resharpen the die until but a full thread or two remain, after which it is generally annealed and reholed to a larger size.

By J. B. HASTY,

Santa Fe.

Dies, like all other cutting tools, must be made and kept in good condition to produce good threads. It is safe to say that one-fourth of all the bolt cutters in operation at present do not cut a clean chip. Most threads are only ridges squeezed on the iron, which ruin the dies, and in fact the whole machine.

Bolt cutter dies can be made to cut free when re-cutting dies by seeing that the spindle and vise jaws, or grip, are in line and

true. Then take a reamer and true them up to the proper size, ready for hobbing.

If the dies are placed on the center the hob should be from one thirty-second to one-sixteenth inch smaller in diameter than the size of the bolt you wish to cut. Grip the shank or hob in a vise and thread the dies in three or four cuts. Each time the hob runs through, close the dies down and let the last, or finishing cut, be a light one. See that the carriage does not drag. It is a good plan when the hob is half way through the dies on the finishing cut to let the vise off and finish by hand with a wrench. Let the hob remain in the dies and run the head at a fast speed and see that the hob runs true and central; if the dies are not tapped true and in line, they will not do good work.

After the dies are threaded, take a short taper reamer and ream the entrance not over three threads. In filing the face of dies, they must be proportioned to the size of bolt they cut. Use lard oil when cutting dies, as mineral oil spoils the hob. In tempering the dies, care must be taken not to overheat them. Harden in the same manner as chisels, or lathe tools. Draw temper to a dark straw or copper color.

By G. W. SMITH,
Chesapeake & Ohio.

We are using the hobbled dies without relief on some of our bolt cutters, if a fair quality of iron is used. The back is milled off to the center of the blanks, and face the angle to the center line to suit the diameter of the dies. We find that on soft material a slight lip works very well with a sharp rake; with ordinary speed good bolt-cutting compound or good oil is very essential.

We also use the Landis dies and die-heads on machines which formerly used other style heads. The Landis dies and die-heads gave good service when other forms of dies failed. When cutting soft steel bolts, we ground our dies in every conceivable way without good results, until we got the Landis. Our make of dies would cut splendid threads on good iron bolts, but made a very ragged thread on soft steel.

We use the Hartness automatic die heads on turret lathes, with good results. This is a relieved die, being cut with $2\frac{1}{4}$ mill, regardless of the diameter of the bolt, hardened on the cutting teeth, and relieved in the center bearing on the back of the thread, which prevents wasting of the finished thread by the drag of the carriage where no lead screw is used. We also use solid square dies 6 in. x 6 in. x $1\frac{1}{8}$ in. of high speed steel, split on one side, with an adjusting bolt through the side for making cast iron plugs for side rods. We also use many solid split dies on brass turret lathes, with good results. On stay-bolt work we use the Lassiter dies for cutting and relieving stay-bolts. A patent chaser grinder is used to grind these dies, making a very uniform throat and cutting edge.

We believe that when the bolt cutters and other thread cutting machines are so widely separated and under so many different foremen as is the case in many plants, and when the tool foreman is only appealed to when the dies fail to work or are ruined, it will be hard to get the maximum output.

DISCUSSION.

In making the cutters for the heads of bolt cutters, it is the practice in some shops to use high speed steel stock $1/16$ in. larger in size than the finished cutters. This surplus stock is machined off. This practice is justified on the basis that the stock runs very uneven in size and that better tempering can be obtained after the scale is removed. Several members, however, claimed that stock of exact size could be obtained if special efforts were made, and that so far as tempering is concerned they could see no advantage in the machining of the sides. Some are using over-sized stock, but are not machining it, preferring to grind it to the desired thickness. One member questioned the advantage of using high speed steel for dies on the ground of

economy. He had experimented with both high speed and carbon steel dies on the same machine and had found that with the rough usage the dies receive in the ordinary bolt cutter, the high speed steel dies did not pay. Some difficulty was also reported with high speed steel dies, in that, with the small sizes, after tempering, the threads would not follow.

One member reported using a hob which is slightly larger at the outer end, and that by closing down the dies as the hob is run through, he is able to obtain a back clearance as well as a side clearance, the latter being obtained by using a hob somewhat smaller than the size of the material which is to be cut by the die.

Considerable discussion arose as to the proper practice for making dies. Some speakers claimed that the dies should be cut only on the machines on which they are to be used, while others make it a practice to cut them to accurate size on a standard head. It appears that if the die-heads are maintained in the proper condition, it is the best practice to make the dies on a standard new head in the main tool-room, while, if the heads on the various bolt cutters are allowed to get in a very poor condition, this would not give as good results as to cut the dies directly on the machine that is to use them.

It was explained that the trouble with warped dies is frequently due to an uneven heat and can be overcome by slower heating. One member has secured excellent results with carbon steel dies in which the temper had been drawn in hot sand.

In one shop, at least, it is the practice to require the bolt cutters to turn in their dies each night and to draw new ones each morning. In this way the tool-room foreman has an opportunity to see that the dies are kept in good condition at all times.

FORGING MACHINE DIES

By B. HENDRICKSON,
Chicago & North Western.

The process of making wrought iron and steel forgings by the use of a powerful machine and dies consists of four operations, viz.: A gathering of stock from the bar, molding into shape, welding, and punching. Oftentimes one operation only is necessary to form a piece, and again all four may be required. The dies for doing this work have two functions to perform. They must be able to grip the stock and must contain recesses of such a shape that the desired forging may be produced in one or more operations, as the case may be. In conjunction with the dies, a plunger is used whose function is to upset the stock and force it into the recess of the die.

The nature of the work to which they are put determines the material of which the dies shall be made. Cast iron, being the cheapest and most easily worked, is very desirable, but can only be used where the demand for its product is not very great. Where many forgings are required, standard dies are cast steel. Oftentimes the forgings may be done in such a way that more wear takes place on one part of a die than on another. In such a case, what are called sectional dies are used. The main body of such dies is made of cast iron and is so designed that where the excess wear comes, there are inserts of tool steel. These inserts may be removed when worn beyond a certain limit and replaced by a standard size, so the entire die does not have to be scrapped.

The material of which plungers are made depends both on their size and the nature of their work. Nickel steel is the material to be used for heavy work, while common tool steel or special plunger steel will do for lighter work. Where a punching operation is required, the brunt of the work should be borne by inserts made of air hardening steel or plunger steel. Provision must be made in the design of dies for the overflow of excess metal when the die recess is full. A vent should be made varying in size according to the weight of the forging. This vent, of course, becomes unnecessary when enough pieces have been made to enable the foreman to calculate the exact amount

of material required. Wherever upsetting is done by means of a hollow plunger, a vent should be placed at the bottom of the recess, to allow the air to escape. Heating of dies from the hot stock does not affect their design. On large work, so much time is consumed in heating stock that the die cools itself. This practice will not do in the case of small dies, however, as they work too rapidly. There are two ways of cooling, either with a jet of water or swabbing off the surface with oil. The former method should be avoided wherever possible as it causes the die face and plunger to check.

DISCUSSION.

Consideration of the proper material to use for making dies of this character formed the principal part of discussion. It seems that in many cases dies made of tire steel, or even of cast iron, give fully as good service as those made of the higher-priced materials. In some cases, for punches or similar dies, nickel steel has given very good results. It is also often used for inserts on cast iron or cast steel dies where the wear is excessive. Where water is to be used for cooling, it has been found that high speed steel is not at all suitable for a die material, but where air is used, this expensive steel is satisfactory so far as service is concerned. Some of the members used high speed steel where the dies have to withstand an intense heat, claiming that it is the best material for use under these conditions.

As to the different parts which can be made on a forging machine, it appears that the opportunity is almost unlimited. On the Santa Fe, it was reported that about 50,000 grease cups are being made each year from old files. The dies are made of tire steel, and it is stated that one set of dies will run for over a year. Other members mentioned various unusual parts that were made on these machines.

In connection with the advisability of punching the tell-tale holes in staybolts, the discussion showed the members to be generally opposed to the practice on the basis that the metal would crystallize and harden in the center, causing the bolts to become less flexible and more liable to breakage.

FORM OF THREAD AND DEGREE OF TAPER FOR BOILER STUDS AND PLUGS.

The committee on "The form of thread and degree of taper for boiler studs and plugs" presented several reports as the members could not agree. Abstracts of these individual reports follow:

By A. M. ROBERTS,
Bessemer & Lake Erie.

I believe the U. S. standard, 12 threads per inch, is preferable for the following reasons: For the convenience of the manufacturing of the studs; the simplicity of applying it; stronger and more durable stud; because of its standardization; the maintenance of the taps and dies; holes can be changed from "V" thread to "U. S." without any difficulty.

I would recommend a 1 1/4-in. taper in 12-in. for standard mud plugs.

By JAS. E. DOSSER,
Southern Railway.

Many of the leading roads have investigated the superiority of the new form, or U. S. standard thread, and are using it exclusively. Some roads that have adopted the U. S. standard thread exclusively for boiler work are the Pennsylvania, Louisville & Nashville, Norfolk & Western, Southern, Central of Georgia, Delaware, Lackawanna & Western, Chicago, Rock Island & Pacific, and the International & Great Northern.

The U. S. standard thread gives much greater strength and life to taps and dies in use than that of the old "V" forms. There is also the advantage of re-tapping the old "V" form holes with the U. S. tap and replacing studs with the U. S. thread without changing the size of the stud.

I believe that the 3/4-in. taper for studs is the most practical.

By DANIEL FREYLER,
Illinois Central.

I recommend the "V" thread for boiler studs and plugs. It has a greater cross-section than the U. S. standard, with flat top and root of thread, for an equal number of threads per inch. The depth of the U. S. standard thread is not as great as the V thread and is narrower at the base. However slight the difference may be, it is sufficient to reduce the area of the cross-section of the thread and as a result, the shearing strength. It may be objected that by reducing the depth of the thread the area of the screw at the root of the thread is correspondingly increased, hence the tensile strength of the stud is increased. This is true, but this objection is met when it is remembered that as the thickness of the boiler plate ordinarily is less than the diameter of the screw, the principal strain is on the thread, not on the core of the screw. The result is that if the cross-section of the threads engaged is reduced, the efficiency of screw or plug is reduced; therefore, since the cross-section of the U. S. standard thread is less than the V thread for the same number of threads per inch, or pitch, then the V thread is the thread to be used as it offers the greater resistance to the shearing strength on the thread.

I would adopt the V thread also because it adapts itself more readily to the slight variations in the angle of the thread and still makes a tight joint.

I believe 3/4-in. taper per foot to be the correct taper, because as the angle of the taper recedes from the perpendicular, the shearing strength of the thread, which is perpendicular to the diameter of the screw, is decreased owing to the difference in the area of the threads in contact in the line drawn parallel with the center of the screw. I have found in practice that a taper bolt is stripped easier than a straight bolt of equal length of thread and the greater the taper the more readily it gives away, especially if it exceeds 3/4-in. taper.

On the 3/4-in. taper or less the friction produced by drawing up the stud or plug acts as a grip, tending to still further secure it, whereas, on a greater taper, this is largely neutralized since the line of pressure is nearest the apex of the thread.

By H. C. WILSON,
Southern Railway.

I am in favor of the United States standard form of thread, because it, not having a sharp point, will not wear so fast, and, therefore, will retain its size and form much longer.

I have found that a V form of tap or die will soon wear off at the point of the thread losing its size and form, causing trouble from tight or loose bolts. We have used many tapers and find that 3/4-in. taper in 12-in. gives the best service.

By W. J. EDDY,
Rock Island Lines.

My recommendations for a standard form of thread and degree of taper for boiler studs and plugs are as follows:

Number of threads per inch for all boiler work.....	12
Form of thread.....	U. S. Standard
Taper, plugs and fittings.....	3/4-in. per ft.
Wash-out plugs.....	1 1/4-in. per ft.

DISCUSSION.

After a thorough discussion of the subject a motion was unanimously passed that it was the opinion of the association that all holes in a boiler and all studs and bolts, with the exception of staybolts, should be made with a 3/4 in. taper to the foot and twelve U. S. standard threads per inch. This decision was made on the basis that it was practically impossible to cut an exact V thread in boiler steel and that when in an imperfect condition they were frequently the source of considerable leakage. A. R. Davis (Central of Georgia) presented some interesting figures in connection with the result of some tests he had made between the two types of threads. In tapping 25 holes with a V tap he found the tap to wear .008 in., while the standard tap with the same number of holes under same conditions wore only

.0013/4 in. With 50 holes the V tap wore away .011 in., while the U. S. standard tap only wore .003 in. It was found that 20 per cent. of the holes tapped by the U. S. standard tap were better than those with the V tap. It was further found that the U. S. standard thread tap required but 76 per cent. of the power required to operate the V thread tap.

All the members were agreed on the desirability of the standard taper, and it was stated that there were cases where three different tapers were used on one road. This naturally leads to the possibility of putting a stud of one taper into a hole of another with disastrous results so far as tightness is concerned. It was stated that one road uses straight taps only and finds no difficulty, but it was pointed out that the opportunity of getting tapering studs in a straight tapped hole was always present.

ELECTION OF OFFICERS.

The following officers were elected for the ensuing year. President, A. M. Roberts, Bessemer & Lake Erie, Greenville, Pa.; first vice-president, Henry Otto, Atchison, Topeka & Santa Fe, Topeka, Kan.; second vice-president, J. J. Sheehan, Norfolk & Western, Roanoke, Va.; third vice-president, E. R. Purchase, Boston & Albany, Springfield, Mass.; secretary-treasurer, A. R. Davis, Central of Georgia, Macon, Ga.; chairman of executive committee, C. A. Shaffer, Illinois Central, Chicago, Ill. The following four men were also elected to the executive committee: J. Martin, Cleveland, Cincinnati, Chicago & St. Louis, Indianapolis, Ind.; O. D. Kinsey, Illinois Central, Chicago, Ill.; C. Helm, Chicago, Milwaukee & St. Paul, Milwaukee, Wis.; A. Williams, Pennsylvania Railroad, Ft. Wayne, Ind. There were 56 members registered.

TRACTIVE EFFORT CHART

BY L. R. POMEROY.

The accompanying chart for obtaining the tractive effort of locomotives is very largely self-explanatory. It is arranged to include locomotives having cylinders between 15 in. and 30 in. in diameter and 20 in. and 30 in. stroke, combined with wheels

from 56 in. to 84 in. in diameter and steam pressure which, with the proportion of boiler pressure that is selected as the proper mean effective pressure, will give either 150 lbs., 160 lbs. or 170 lbs. mean effective pressure. Scales are provided for giving the tractive effort per pound of mean effective pressure, if that is desired, or to give the total amount of tractive effort when using one of the three mean effective pressures given.

The method of using the table is simple and is well illustrated by the dotted line. The diameter of the cylinder is found on the left-hand scale and the line is followed horizontally to the intersection of the diagonal giving the diameter of the driving wheels. From this intersection, continue vertically downward to the intersection with the line corresponding to the length of the stroke and then horizontally to the right, continuing to the right-hand scale for the tractive effort per pound of mean effective pressure. From the intersection of this last horizontal line with the diagonals showing the mean effective pressure, continuing vertically downward will give the total tractive effort on the bottom scale of the right-hand part of the chart.

RAILWAY BUSINESS FOR MAY.—During May the railways of the United States received for their services to the public an average of \$8,230,000 a day; it cost to run their trains and for other expenses of operation \$5,920,000 a day; their taxes were \$341,500 a day; their operating income \$1,972,322 a day for the 220,897 miles of line reporting, or at the rate of \$8.93 for each mile of line for each day. Thus for every six dollars of their earnings which remained available for rentals, interest on bonds, appropriations for betterments, improvements and new construction, and for dividends, the railways had to pay more than one dollar in taxes. All of these amounts are substantially greater than the similar returns for May, 1912. They are from the summary of the earnings and expenses compiled by the Bureau of Railway Economics from the monthly reports of the steam railways of the United States to the Interstate Commerce Commission. They include over 95 per cent. of the mileage and earnings of all of the railways of the country.

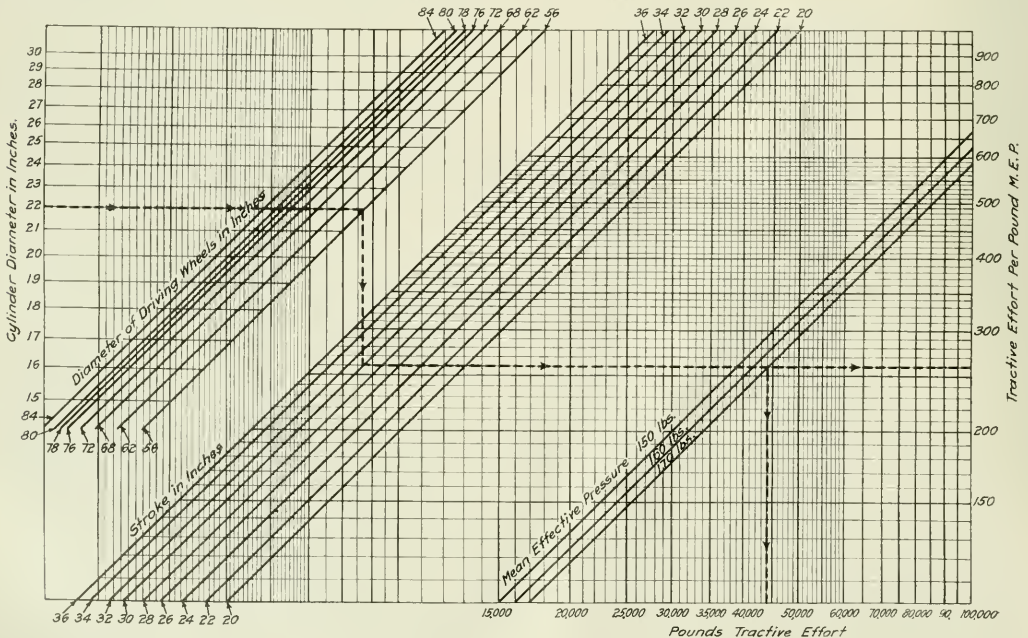

Tractive Effort Chart Giving the Pounds Pull for Any Size of Locomotive.

CAR DEPARTMENT

IMPROVED METHODS OF FREIGHT CAR CONSTRUCTION*

BY R. W. SCHULZE,

General Foreman Car Department, Gulf, Colorado & Santa Fe, Cleburne, Texas

The cost of freight car maintenance has been steadily advancing month by month and year by year. The desire for larger cars, the demand for greater capacity, and the effort to handle more tonnage are adding continually to the cost of maintaining the car body and the draft rigging. The car designer and the repairmen have not complained. They welcome the opportunity to increase the railroad's handling capacity. They see the improvement in locomotive tractive effort and strive to keep the freight car abreast of the engine.

The designer, with various data before him, endeavors to build a strong, durable car; one that will stand the drawbar stress over heavy mountain grades, the speed of the fast freight and the buffs of the "hump" yard. He lives with the car until it leaves the builder and joins the flow of commerce. Then the repairmen step in and begin the endless renewing of damaged, broken and worn out parts. Does the designer always consider the repairmen? Often, Yes! Often also, No! The purpose of this article is to note different features that have been overlooked.

Every new type of car as it joins its fellows is inspected, dis-

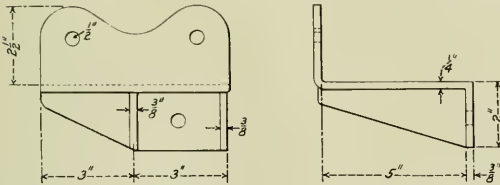

Fig. 1—Top End Post Casting for Use when End Posts are Removed from the Inside.

ussed and debated; sometimes optimistically, and sometimes, I am sorry to say, pessimistically. Not that its increased size or capacity are questioned, but all too frequently the designer has revelled in the great strength of his design and has forgotten the little kinks, ideas and possibilities of making the new type accessible to and economical of repair. It has often seemed that if the designer could listen to these "switch shanty" talks of car men and inspectors, many good ideas could be introduced into the design of the thousands of new cars being built every month.

There is the one big question of end braces and posts—wooden ones that are broken, and iron ones that are bent. What should be done to make their renewal as economical as possible? It should not be necessary to tear out an entire end to renew one of the posts, or to tear off part of the roof to release a tie rod that is run through the post when it should have run clear or have been placed to one side. A little forethought on the part of the designer would allow an end post to be so applied that its renewal would only be a question of a foot of siding renewed or an end of lining removed and replaced—and not an entire end renewed.

The trouble usually lies in the pattern of the post top casting, or the tie rod being too close to, or too much a part of the post. Why not make the top casting with a lip extending up on the inside of the end plate and bolt it securely through this lip to the

plate? Then let the designer decide whether he wishes the posts removed from the inside or the outside. Suppose that he decides to remove them from the inside, on account of the construction of the car. Then why not extend a lip down on the outside of the post casting, leaving the inside clear, and bolt the post and braces to this lower lip of the casting, as the upper lip is bolted to the end plate? Figs. 1 and 2 show a post casting which includes these ideas. By such construction a post or brace can

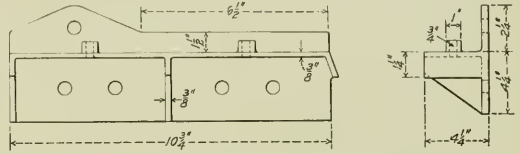

Fig. 2—Top End Post Casting with Top and Bottom Lips on the Same Side.

be renewed by simply removing the siding or lining attached to the post or brace. The rigidity of the end is not affected, much material is saved, and the actual labor of renewing the post or brace is small as compared to the cost of renewing a post with a post pocket casting.

Another post and brace casting which requires careful design, is the lower casting on stock cars. Owing to the many shocks and blows incident to cattle swaying or moving in these cars, the posts, braces and castings must be rigidly fastened at both the top and the bottom. In some cars of recent design, these castings have been well designed; but in others it has been found practically impossible to remove the side sills, posts or braces without a considerable amount of extra work due to improper design of the casting. These improper castings have the vertical bolt so applied that the bolts cannot be removed without destroy-

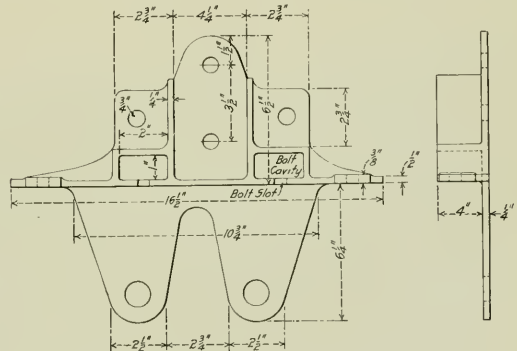

Fig. 3—Stock Car Bottom Side Post Casting Showing Method of Applying Vertical Bolts.

ing the posts and braces. A slight modification in the design of the casting, so that the vertical bolts can be removed without interfering with the posts or braces would greatly simplify the work in making repairs. The most practical design of stock car side post and brace casting is the one which sets flat on the sill, with lips on the sides, and which is so designed that the lips extend down inside the side sill and are bolted to it with horizontal as well as vertical bolts, which bolts can be removed

*Entered in the Car Department competition which closed February 15.

without interference with the posts or braces. Fig. 3 shows a post casting of this design.

Much labor and material are wasted in removing tie rods. These must be removed before broken parts can be renewed, as they are often run through posts, post castings and braces, when the same results could be attained if they were applied free of the posts and castings. It may often be difficult to confine these rods to their limited and proper places, but it would be far more economical and advisable for the designer to study all phases of the car construction and apply the rod in such a way that it would not be necessary to remove it when broken parts are removed. Much money is spent removing roofing, tearing off siding, and removing good material which is destroyed while being removed, in order to get at some particular tie rod which should have been entirely free from parts needing repairs.

The light tongue and groove lining should be abandoned and replaced by material $1\frac{1}{8}$ in. thick, with a ship lap. In spite of all the efforts to securely pack cars to keep the load from shifting, it will no doubt never be entirely eliminated. When a heavy blow strikes the light lining, the boards break and splinter, the sides of the grooves split and break off, and it is only a question of a short time until car lining is damaged to such an extent that it must be renewed or the car will be unfit for bulk grain loading. Where the lining is increased to a $1\frac{1}{8}$ in. thickness, a blow of extra heavy force would be required to break it, such a blow as would almost pierce the siding. Furthermore, the lap of the ship lap is so much heavier than the sides of the groove of the tongue and groove, that it will stand a heavier blow and will seldom split and break. Bulk grain leakage with ship lap lumber would be greatly reduced; and in renewing posts and



Fig. 4.—Carline and Method of Applying It to Side Plates.

braces, the lining could be reapplied with less waste of good material.

Probably less consideration and thought have been given to the car repairmen in the design and application of roof carlines than to any other part of the car. Seldom can a design of metal carline be found that can be removed without first practically removing the entire roof. The desire has been to tie the top of the car together and brace the roof without thought of the many cars which are so damaged that light repairs to the roof and body would place them in service with a proper design of metal carline, whereas with the present carline the entire roof must practically be removed in order to remove and repair one which is bent or damaged. They should be so designed and constructed that a bent or damaged one could be removed from the inside of the car without disturbing or loosening any part of the roof. In addition, the carline should be designed to securely brace and tie the car. In place of the ends extending on the top and over the outside of the side plate, they should extend down on the inside of the plates and be bolted through them. A reinforcement may be applied at each end of the carline in the shape of an "L." This can extend over the top of the plate, be bolted to the carline with two vertical bolts and be held to the plate with the same bolts that hold the inside lip of the carline to the plates. Such a carline can be removed by simply taking out the plate and carline bolt. The roof would not be disturbed, and would be just as securely braced and the cost of renewing or repairing a damaged metal carline would be exceedingly small as compared with the present expensive methods. Fig. 4 shows the arrangement of such a carline.

Many designers have built the steel underframe cars with short steel channel center sill extensions, extending from the end sill to the body bolster and riveted to the body bolster, while the center sills proper extend from one body bolster to the other.

This design may be likened to the old short draft timbers as compared with more durable and efficient long timbers. The short steel channel center sill extensions should rightly extend from the end sill to a point beyond the body bolster. At this point there should be a standard sill splice. Such construction will strengthen the end of the car; will more equally distribute the load or shock on the body bolster; will have the same effect as a continuous sill, and will be more readily accessible for repairs.

A check of the design of steel underframe cars in any repair yard will demonstrate that even in the latest cars this feature has been almost entirely overlooked. The majority have a one-piece continuous center sill; very few have the ends spliced. The result is that where the steel center sills of a car are damaged, they must either be straightened by crude methods or must be entirely removed from the car and be cut and spliced at a heavy cost. Had these sills been spliced behind the bolster, as noted above, the ends could be removed and repaired at a small cost and with little delay.

Every year many thousands of dollars are spent paying bulk grain leakage claims, and placing cars in condition to prevent such leakage. The usual precautionary method is to prevent leaks around the sides and ends of the car along the siding by the triangular grain strip. This is applied on the floor of the car, between the siding and the lining, and also serves as an incline to empty grain lodged behind the lining. The strip fits closely against the siding of a new or newly sided car, but after it has been in service for some time and the sheathing has worked loose, the grain works down behind the grain strip pressing the siding further away from the car and finally finds its way through the opening to the ground. The shape of the strip should rather be that of an obtuse angle of about 105 deg. Such a strip clings to and follows the siding as it works away from the sill and holds the grain securely in the car. This change could be made at no cost, and yet the saving in the loss of grain can hardly be estimated.

Another wise precaution against loosened siding is the application of a light angle iron strip with bolts through the strip, sheathing and sill with nuts on the outside. It can easily be applied to even those cars already in service. It stiffens the car and its cost of application is almost nothing.

The entire hope of the car repairmen for future lightening of their labors is centered in the efficient design of new cars. The old car of obsolete construction will slowly but surely disappear. The strong and durable reinforced car will take its place. Cost of repairs must not increase. The tendency must be to decrease gradually and surely; but always the idea should not be overlooked that strength and durability are not everything. Easy repairs of seldom thought of parts and a minimum amount of work for small repair points should be the chief aim and desire of the car designer and car man. A number of these easy repairs have been noted in this article. Too much stress cannot be laid on the necessity of reducing repairs, so that small repair points can handle quickly and efficiently at low cost wrecked or damaged cars without the necessity of maintaining large forces of men where work should be of the lightest nature. We are getting the strong car. Sometimes we get the easily repaired car, and this is the car that must come into general use so that car maintenance costs will descend to the low level that should and can be attained.

NEW YORK CANALS.—We perceive by the Albany *Evening Journal* that the New York Canal Commissioners have reduced the tolls upon the Erie Canal. The *Journal* says that "This reduction was demanded by considerations which deeply affected the prosperity of the state. Rival channels of communication are opening which threaten to divert the trade of the far west from our great commercial emporium."—From the *American Railroad Journal*, March 23, 1933.

FIFTY-TON STEEL HOPPER CAR

The Central Railroad of New Jersey has in operation about 7,000 steel hopper cars, of which nearly 3,000 are 100,000 lbs. capacity. The remainder have a capacity of 80,000 lbs. These cars have been ordered in lots of about 1,000 each, during the past 10

years. The present cars have a light weight of 39,200 lbs. while those of the previous series weighed 37,300 lbs. This increased weight is accounted for largely by stronger center sills and a more substantial end sill construction. In other respects the changes did not make a material increase in the weight.

While the illustrations show the details of the construction

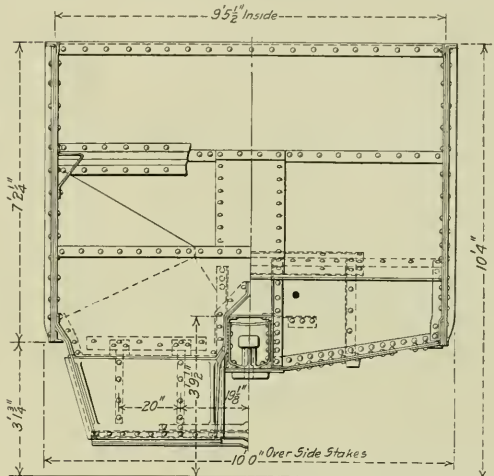
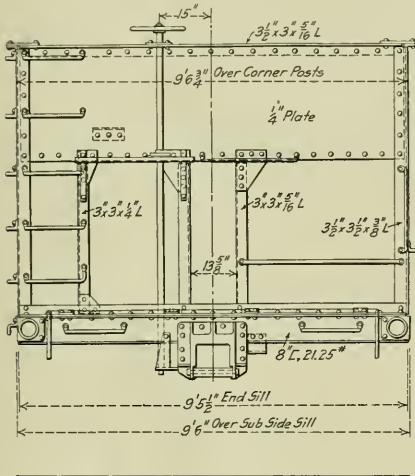

End Elevation and Sections of C. R. R. of N. J. 50-Ton Hopper Car.

years, and in each case the design has been somewhat revised on the basis of the service of the previous order. Various parts have been made heavier, the design of details has been revised and improved attachments have been applied, until it is believed that the latest cars meet the present conditions as perfectly as is possible. These changes in the last order of cars have increased the weight somewhat over the previous order which, in turn, were about 200 lbs. lighter than the first 50-ton cars ordered.

quite clearly, attention will be drawn to a few of the more important features. The center sills are formed of two 15 in., 50 lb. channels with the flanges facing in. No cover plates are used, but suitable spacing pieces have been incorporated at various points. These heavy channels extend but a short distance beyond the bolster at each end, and to these extensions, the draft sills, which consist of $\frac{3}{8}$ in. plate pressed in Z section, $15\frac{3}{4}$ in. deep, are secured. The draft sills are on the outside of the center sills



Latest Design of Steel Hopper Car on the Central Railroad of New Jersey.

and are held by 3/4 in. rivets arranged as shown. They have a 5/16 in. top cover plate 24 in. in length. The side sills proper extend only from the end sills to the bolster and are formed of 8 in. 21 1/4 lb. channels. The end sills are of the same size channel and include a 5/16 in. cover plate, bent to angle section. It will be noticed that this cover plate is of sufficient width in a horizontal plane to add greatly to the stiffness of the end of the underframe. The bolster is formed of a 1/4 in. vertical plate of the very deep section made possible on this type of car. The arrangement of the reinforcing angles is clearly shown in the illustrations.

The sheets forming the car body are 1/4 in. thick and the top reinforcing angle is 3 1/2 in. x 3 in. x 5/16 in. The corner posts are 3 1/2 in. x 3 1/2 in. x 3/8 in. angles and the intermediate angle supports from the end sills to the body of the car are 3 in. x 3 in. x 5/16 in. The side stakes are of pressed steel in the usual form.

These cars are equipped with Miner friction draft gear, class A-18, with yoke attachment and Simplex couplers. The trucks are of the Andrews cast steel side frame type with 33 in., 725 lb. cast iron wheels. The truck bolster is of the American Steel Foundry Company's design and the springs were furnished by the Simplex Railway Appliance Company. Gould 5 1/2 in. x 10 in. malleable iron journal boxes and Waycott brake beams are used. These cars, built by the Standard Steel Car Company, have following general dimensions:

Length over end sills.....	31 ft. 6 in.
Width of car over side stakes.....	10 ft.
Width of car inside of body.....	9 ft. 5 1/2 in.
Height from top of rail to top of body.....	10 ft. 4 in.
Length of hopper opening at the bottom.....	2 ft. 11 in.
Width of hopper opening.....	2 ft. 3 1/2 in.
Height from top of rail to under side of hopper.....	9 3/4 in.
Distance from center to center of truck.....	121 ft. 9 in.
Wheel base of truck.....	5 ft. 6 in.

TESTS OF ALCOHOL HEATER CAR

In shipping perishable products during the winter months some precaution must necessarily be taken to prevent freezing, and the practice commonly followed is to line box cars with building paper and equip them with false floor racks and small stoves.

The objections urged against this practice are the initial cost for equipping the cars, which are not always returned for repeat loads, and the cost of attendance along the road, as well as the risk from damage by fire. Specially fitted heater cars are in use to some extent for such traffic, but the objection commonly raised against this type of car is that it is necessarily non-revenue producing for about nine months of the year, unless used as an ordinary box car during that time, and the heater car necessarily costs more than the ordinary box car.

A solution of the problem would seem to be a combination heater and refrigerator car that would be available for use the year round. There are several types of this car in existence, one of which has been developed by the Alcohol Heating & Lighting Company, Chicago. After making tests with a number of fuels, it was concluded that denatured alcohol was the best adapted to the purpose in hand, as it does not vitiate the air to the same extent as other fuels, and it can be used as a heating agent without any detrimental effects on food products. Considerable time was spent in developing an automatic alcohol burner, and one was finally produced that could be safely operated for from eight to fifteen days without any attention other than an inspection made at divisional points.

These cars have now been in service during three winters, and the illustrations accompanying this article show the result of a temperature test made on one of them in use on the Canadian Pacific. The recording thermometer was placed in the car at 11 a. m., March 2, at which time the doors were closed and sealed, the car remaining in this condition until 8:30 p. m., March 11. The full line on the diagram represents the temperature inside the car, and it will be noted that it was maintained almost constantly between 40 and 45 deg., a variation of less than 5 deg., while the temperature outside varied 58 deg., as shown by the dotted line on the diagram. During this time the car traveled a distance of 1,475 miles.

The test was conducted under the direction of A. W. Whiting, inspector of refrigeration of the Canadian Pacific, and was run between West St. John, N. B., and Fort William, Ont. The car was equipped with what is termed the double unit system, there

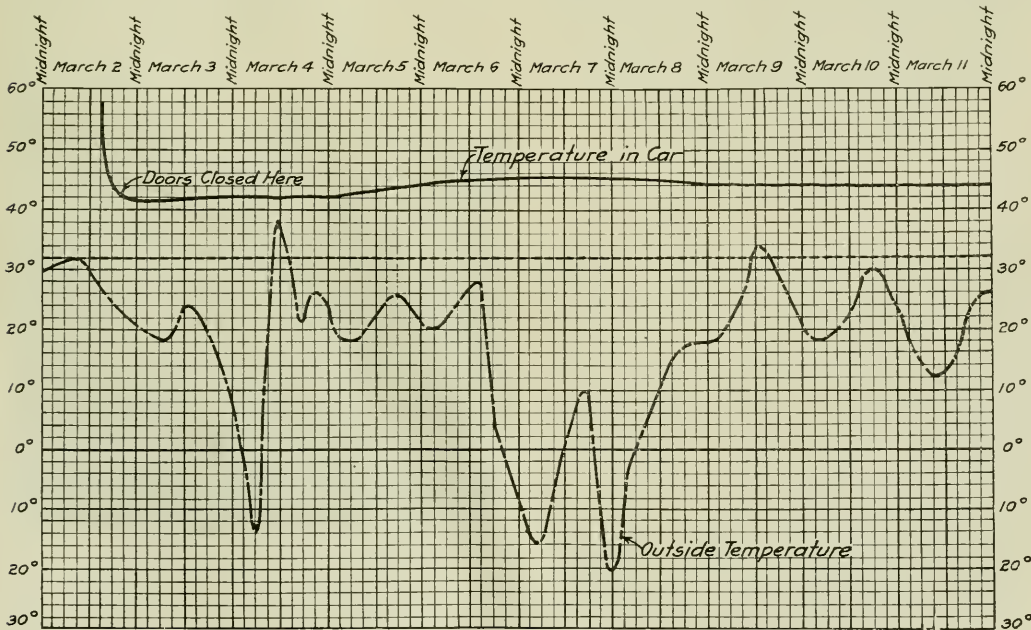

Diagram Made from Record of Recording Thermometer in Alcohol Heater Car Test.

being four burners, two on each side of the car. These burners are exactly the same, but for convenience in conducting the test were numbered 1 and 2. By using four burners the maximum amount of heat can be applied quickly at the point of loading, and when the car and contents have been thoroughly warmed two of the burners are extinguished, the two remaining ones being sufficient to protect the lading. The duplicate system insures a longer run without the necessity of cleaning the burners; each burner will burn continuously for seven days without cleaning, and if the car is reconsigned it is only necessary to extinguish one burner and light the other.

The car was loaded with boxed merchandise to a height of about 4 ft., there being no space between the boxes or at the doors. Both the No. 1 burners were lighted at 11 a. m., March 2, 1913, and a self-recording thermometer was placed inside of the car, 6 ft. back from the door, 2 ft. above the floor and 2 ft. from the side wall. The thermometer was surrounded entirely by freight in order to determine the temperature of the freight rather than the temperature of the air inside the car. The car left West St. John at 8:45 p. m. March 3, with the two No. 1

CAR REPAIR NOTES FROM THE NORFOLK & WESTERN

SAFETY APPLIANCE MODELS.

It is frequently difficult to obtain men to work at car repairs who are familiar with the reading of blue prints. The re-



Models of Freight Car Ends for Reference in Applying Safety Appliances.

quirements of the government in the application of safety appliances to cars are such as to necessitate blue prints or some other standards for the men's guidance. At the car repair yards of the Norfolk & Western at West Roanoke, Va., it was found

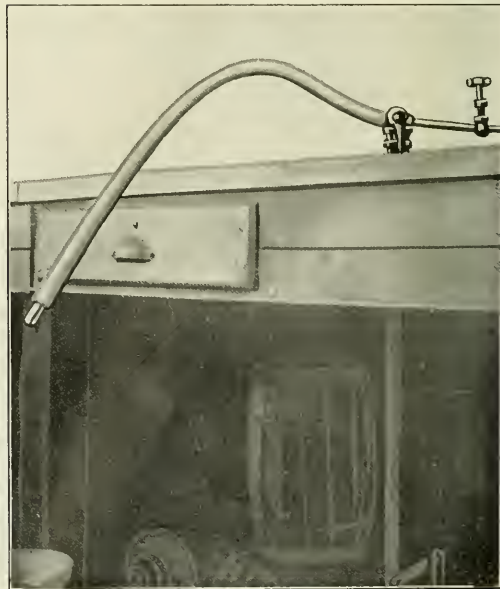

Valve and Treadle to Prevent Waste of Compressed Air.

Record of Temperature Test of Alcohol Heater Car.

burners in use; the No. 2 burners were lighted at 8:45 p. m., March 4, at Megantic. The burners were inspected at each divisional terminal and were found to be operating satisfactorily in every case. The reservoirs were refilled once during the test, each box being supplied with 7½ gal. of alcohol at Smith's Falls, Ont., at 10:30 p. m., March 6, at which time the two No. 1 burners were extinguished and the car continued to its destination with the two No. 2 burners operating. The fuel reservoir can be made of any desired size, but it has been found in practice that four days' supply is the most economical and satisfactory on account of the character of the train schedules and the length of time that the perishable freight must be protected. On account of the location of the thermometer it is not probable that it could have been greatly influenced by the warm air entering the car at either end, but instead received only the benefit of the warm air rising from the floor of the car. High winds and snowstorms prevailed at several points during the trip. The car arrived at Fort William, Ont., at 8:30 p. m., March 11, and the thermometer was then removed and the test closed. The burners were operated a total of nine days, ten hours, the actual running time of the test being eight days.

that much time was lost by the men in trying to read the blue prints; in order to simplify matters, full size models of the ends of a box, gondola and flat car were built and set up in a convenient position near the repair tracks. These models are

equipped with the United States safety appliances, and when a man desires information regarding these he may readily obtain it direct from one of the models.

PREVENTING WASTE OF COMPRESSED AIR.

In using compressed air for blowing out repaired triple valves, etc., considerable air is lost during the time that the globe valve is being opened and the hose picked up, etc. This waste of air is avoided at West Roanoke by the use of the device shown in one of the illustrations. An additional globe valve is placed in the air pipe beyond the main valve; this valve is closed by a spring and the spindle is connected through the bench to a treadle below. When it is desired to use the air hose for any purpose the main globe valve is first opened, after which the air used is controlled by the second valve through the treadle.

PIPE BENDING DEVICE.

It is necessary in car repair work to do a great deal of pipe bending, and it is very common to see a repairman insert a piece of a train pipe between truss rods or in a truck in order to

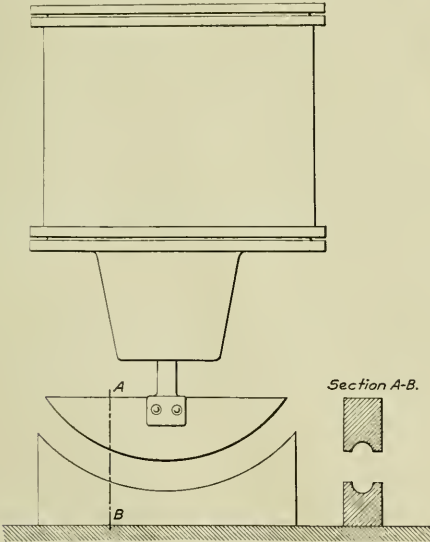

Brake Cylinder Fitted for Bending Pipe.

bend it to the desired angle. The pipe bender illustrated is made from a 14-in. brake cylinder and two castings. Almost any angle can be obtained with this device by regulating the amount of air admitted to the cylinder.

PREPARING DOPE FOR JOURNAL BOXES.

The mixing of dope for car journal boxes is taken care of at West Roanoke in the following manner: The car oil is held in a large tank raised several feet above the floor and is passed from this tank to a smaller tank resting on the floor in which the waste and oil are mixed. Above this mixing tank is placed vertically an 8 in. brake cylinder with an additional piston connected to the outer end of the piston rod. This piston is a loose fit in a 12-in. brake cylinder, which is drilled with a number of holes about $\frac{3}{8}$ in. or $\frac{1}{2}$ in. in diameter. After the waste is mixed with the oil, a quantity of it is placed in the 12-in. cylinder and the air is turned on in the 8-in. cylinder. The piston squeezes out the excess oil, which runs back through the perforations into the mixing tank. The dope is then placed in a storage tank from which it is supplied for use in cars.

CUT-OFF SAW.

The swing cut-off saw shown in another of the illustrations has been developed at West Roanoke for the cutting off of sheathing, etc., to required lengths. The swing arrangement is quite simple, being very similar to the link grinding apparatus used in locomotive repair shops. Three standard lengths of sheathing are used, and when the material is unloaded from the car it passes directly in front of the saw and is cut to the desired length, which is governed by a block placed on the bench.



Swing Cut-off Saw for Car Sheathing.

The prepared sheathing is then piled at the other end of the bench, as shown in the illustration, where it is available for the car men at any time.

STRAIGHTENING SPRING PLANKS.

Another handy device in use at West Roanoke is a crude oil burner for straightening spring planks, etc. This furnace has directly in front of it a heavy slab of cast iron about 4 ft. x 8 ft. Such pieces as spring planks are very readily straightened on this plate after being heated in the furnace and a great deal of material which would otherwise have been scrapped has been made available for use again. The furnace also frequently makes it possible to save the time required in transferring bent pieces from the repair yards to the shops and back again.

A CARELESS TRAVELER.—A few days since as the train was passing on the Newcastle & Frenchtown Railroad, the baggage car took fire, as is supposed, from a spark from the engine, by which a great proportion of the baggage was destroyed, and amongst the rest a bag belonging to one of the passengers containing United States Bank notes to a large amount, designed for the Fayetteville, N. C., branch, was considerably burned. One package of \$60,000 in hundred dollar notes was lost, and another package much burned. The guardian of such a bag should never lose sight of it when traveling.—*From the American Railroad Journal, January 19, 1833.*

CLEARING SNOW IN 1833.—We have another proof of the promptness with which the obstruction caused by deep fall or drifting of snow is removed from the Baltimore & Ohio Railroad. The snow which fell on Friday last was thrown on the railroad in drifts, in many instances from two to three feet deep during that night and the next morning, yet it was so promptly cleared off the whole distance of sixty miles between Baltimore & Frederick, that not a single trip of the cars was omitted and the passenger cars on Saturday were only detained about six hours beyond the usual time. This has been at all times the case since the first opening of the road for travel, and furnishes most gratifying evidence of the energy with which the business of the company is prosecuted.—*From the American Railroad Journal, March 16, 1833.*

TABLES FOR DESIGNING CENTER SILLS

BY C. H. FARIS.

The accompanying tables giving the section moduli of the various members of a center sill girder, have been found most convenient in designing steel underframes. They cover sills built up of standard angles and flat plates, and give the section modulus separately for the different angles, web and cover plates, for depths of sill from 12 in. to 40 in. The section modulus for any combination of parts is found by taking the sum of the values, as given in the tables, for each of the parts.

The table for cover plates is computed for one cover plate, I in.

the central axis to the axis through the center of gravity by the formula

I = I' - Ad^2

where I' is the moment of inertia about an axis that does not pass through the center of gravity, I is the moment of inertia about a parallel axis through the center of gravity, A is the area of the section in sq. in., and d is the distance between the axes. The adjusted moment of inertia thus found divided by the distance from the neutral axis to the outermost edge of the section gives the true section modulus sought.

This adjustment is usually small in amount, so that the tabular values closely approximate the true section modulus and trial sections can usually be determined without compu-

SECTION MODULI FOR ONE COVER PLATE ONE INCH WIDE.

Table with 13 columns for thickness (1/4 in. to 1/2 in.) and 13 columns for depth of girder (12 in. to 40 in.).

SECTION MODULI FOR TWO WEB PLATES.

Table with 13 columns for thickness (1/4 in. to 3/8 in.) and 13 columns for depth of girder (12 in. to 40 in.).

SECTION MODULI FOR TWO ANGLES 3 IN. x 3 IN.

Table with 13 columns for thickness (1/4 in. to 1/2 in.) and 13 columns for depth of girder (12 in. to 40 in.).

x = Distance of center of gravity from base.

SECTION MODULI FOR TWO 3 IN. x 4 IN. ANGLES.

Table with 13 columns for thickness (1/2 in. to 3/8 in.) and 13 columns for depth of girder (12 in. to 40 in.).

x = Distance of center of gravity from longer base.

SECTION MODULI FOR TWO 3 1/2 IN. x 5 IN. ANGLES.

Table with 13 columns for thickness (3/8 in. to 3/4 in.) and 13 columns for depth of girder (12 in. to 40 in.).

SECTION MODULI FOR RIVET HOLES THROUGH ONE INCH OF METAL.

Table with 13 columns for diameter (3/8 in. to 7/8 in.) and 13 columns for depth of girder (12 in. to 40 in.).

wide and the section modulus for any desired width is found by multiplying the value for the required depth of girder and thickness of plate, by the width. The section moduli for rivet holes are computed on the same principle. The column headings in the tables are depths of girder over angles. The values for web plates are computed for plates one-half inch less than the nominal depth. The tables are computed for an assumed axis at the center of depth. The moment of inertia about this axis is equal to the section modulus multiplied by one-half the depth for which the value is taken.

For sections made symmetrical about the horizontal axis, the assumed axis will also be the neutral axis through the center of gravity of the section, but for sections not symmetrical, which is the most usual case for this class of girders, the center of gravity will not fall at the center of depth, and it will be necessary to adjust the values taken from the tables from

tation. The final section should always be corrected unless it is symmetrical.

An example will illustrate the use of the tables. Given a maximum bending moment of 5,000,000 in. lbs., and an allowable fiber stress of 16,000 lbs. per sq. in., it is required to find the necessary section. The required section modulus is

5,000,000 / 16,000 = 312.5

Assume a depth of 26 in.

Summary table showing section moduli and areas for various configurations: From the table for web plates, 2 web plates 3/8 in. thick (79.6), From tables for angles, 2 - 3 in. x 4 in. x 3/8 in. angles (top) (57.2), 2 - 3 in. x 4 in. x 7/16 in. angles (bottom) (132.0), For cover plate (top) 22 in. wide x 5/16 in. (91.3), Total (360.1), 3/4 in. rivet holes (bottom) 2 1/2 x 8.5 (21.2), Net (338.9), 40.23 sq. in.

The total depth of the assumed section is 26. in. + .31 in. (thickness of the cover plate) = 26.31 in.

The section of gravity of the section (found by rule given in "Cambria," page 157, 1912 edition, or graphically, as explained in *American Engineer*, March, 1912, page 112) is 13.88 in. from the bottom, or 12.43 in. from the top. This makes $d = .88$ in.

$$I^1 = \frac{338.9 \times 13}{4} = 4,405.7$$

$$I = 4,405.7 - 40.23 \times .88^2 = 4,374.6$$

The true section modulus (bottom) is then found to be

$$\frac{4,374.6}{13.88} = 315.1$$

TANK CAR DESIGN*

BY H. E. PARSONS,
Berwick, Pa.

The problem of tank car design is comparatively simple, and is therefore considered a side line by most car companies; for this reason the draftsman does not give the shop and repair end of the work proper consideration. For several years the writer has been observing the various tank car designs, some of which were without defects, and others with very serious ones. For instance, one car equipped with end anchor blocks had such a weak underframe from the holster to the end sill that the buffing force of the tank against the blocks forced the end sill down about 3 in. This underframe had 12 in. channel center sills, with cover plates between the bolsters. Had the cover plates extended to the end sills, the center sills would have been very much strengthened, perhaps sufficiently to properly resist the force.

Another car had 15 in. channel center sills, with top and bottom cover plates, the top plate running from some distance back of the bolster to the end sill, and the bottom plate from the bolster

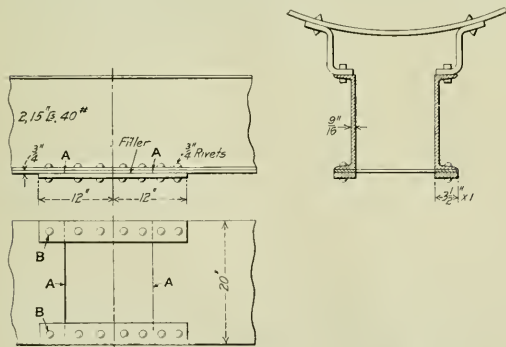

Fig. 1—A Useless Attempt at Reinforcement.

to A, Fig. 1. The net area of the plate was about 7.1 sq. in., and at 12,500 lbs. per sq. in., it would resist a force of 88,750 lbs., which is the force the designer tried to carry across the valve opening through the two 3/2 in. x 1 in. bars, which are good for about 67,000 lbs.; he should have used about 20 rivets on each side of the opening instead of two shown at B. This underframe has sufficient strength without the cover plates, yet the designer through carelessness or insufficient knowledge of strength of materials, wasted much material.

There are a number of tank car underframes built of channel section center sills with cover plates between the bolsters. The reason for using the cover plates I cannot understand, as they are nearly severed at the center to make an opening for the valve chamber; surely they are not there to resist bending moment, for if the bending moment necessitates cover plates, undoubtedly their full section should run through the center where the bending moment is a maximum.

There are a considerable number of pressed shapes used on some cars which are not only expensive, but at times are very difficult to get; furthermore, there are very few owners equipped to make repairs to these parts, and for these reasons each detail should be made as simple as possible. Details are sometimes made complicated by careless designers adding a bend here and there without considering that it might necessitate the mak-

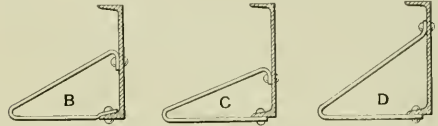

Fig. 2—Wrong and Right Ways of Applying Cylinder Plates.

ing of a set of dies, and of heating the metal to repair the part or make a new one.

I saw a cylinder plate on a car made as shown at B in Fig. 2, the designer failing to see that it would be easier to make it as shown at C, which takes one heat and two operations. If made like D one operation and one heat would be sufficient.

When a draftsman designs a lever guide and applies it as shown by E, Fig. 3, he does not consider the strength of the sill or the labor required; the guide is unnecessarily bent and

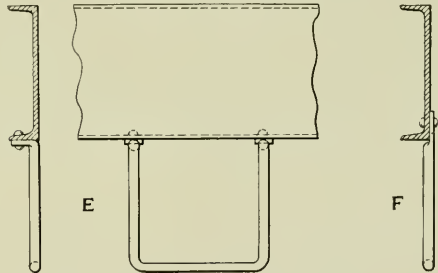

Fig. 3—Bad and Good Applications of a Lever Guide.

the moment of inertia of the sill, or its strength to resist bending, is reduced more than if applied as at F.

On a certain car it was necessary to use a sill step similar to the one shown at G, Fig. 4, as there was very little clearance for the truck while rounding curves; for some unknown reason

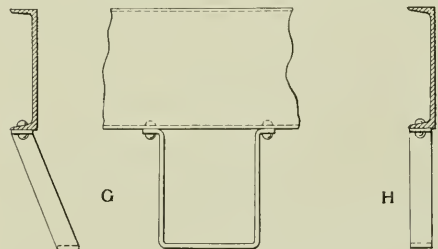

Fig. 4—Sill Step Applications.

this step was used on other cars where there was sufficient clearance with no necessity whatever for not using the step H, which requires one less operation to form it.

Shop men know what would happen to the lever guide, Fig. 5, when it gets in the shop. I am sure they would not make those fancy reverse bends; it should be made in accordance with the dotted lines at the right, unless there is a fancy for this curve of beauty. The draftsman who designed it was very much in need of shop experience.

*Entered in the Car Department competition which closed February 15.

The guide in Fig. 6 was designed to carry a cylinder lever and a push rod having a total weight of less than 100 lbs. Can you see any reason for not making it in the shape of the dotted lines at the right? Surely, two $\frac{5}{8}$ in. rivets, though in tension, are good for more than the load it is likely to carry. These are

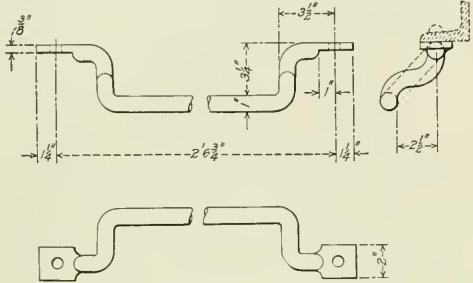

Fig. 5—Lever Guide.

and bolster casting to the tank that about 50 per cent. of the tanks leak.

The high center of gravity is not only dangerous because of the possibility of derailment, but also because it is destructive to the underframe. I have in mind a design in which the oscillating and centrifugal forces were so great that it was extremely dangerous to operate the car. There is a way to correct these defects, and therefore, I would suggest an end construction as per Fig. 7, whereby we get the lowest possible center of gravity.

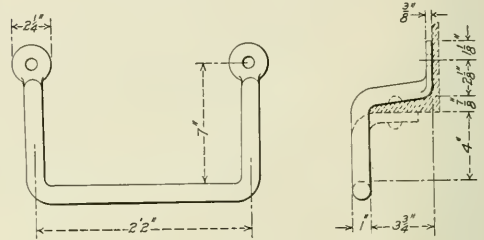

Fig. 6—Cylinder Lever Guide.

minor details which, if carefully watched, would save a surprising sum of money on a 1,000 car order, not to say anything about the repair end of it.

While in conversation with a conductor of one of the Penn-

sylvania work trains, I asked if he had ever experienced any trouble with tank cars. He said he had, and that one had left the track at a curve not far from that place, the investigating committee reporting the same old cause, surging of the oil and the high center of gravity.

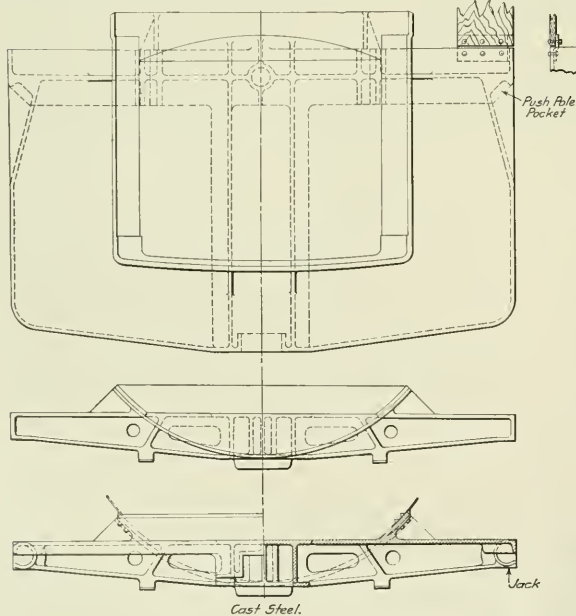

Fig. 7—End Construction Providing for a Low Center of Gravity.

There are a number of tank cars in service that have no underframe, but have a continuous bottom sheet of sufficient area to meet the M. C. B. requirements. These cars have the lowest center of gravity of any in service, yet the distance from the center of the coupler to the center of gravity of the bottom sheet causes such a leverage on the rivets which connect the draft

Another good feature about this construction is that the center of gravity of the continuous bottom sheet and the center line of the coupler are practically in a line. This casting is provided with push pole pockets and a place for jacking, and above all, it meets the M. C. B. requirements throughout. The tanks are of the same diameter from end to end, the only difference being a small portion cut out of each end to fit the castings which form the bottom of the tank.

This article is submitted for publication with the hope that it may arouse interest enough to bring forth a more complete discussion on tank car construction.

NEW DEVICES

WHEEL PRESS RECORDING GAGE

One of the important items in mounting wheels on their axles is to know exactly how much pressure it takes to force them on, and that this record may be obtained automatically and without any interference of the operator. J. W. Motherwell has invented the automatic recording gage shown herewith, which is sold by the Ashton Valve Company, Boston, Mass. This gage not only shows on a dial the hydrostatic pres-

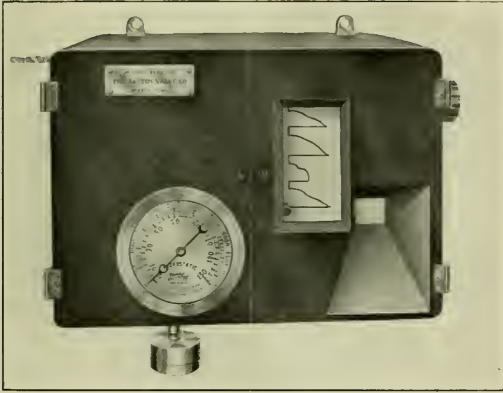

Ashton Wheel Press Recording Gage.

sure acting on the ram, but is arranged for operating a pencil which records the pressure on a sheet of paper that travels in a direction at right angles to the recording pencil, and at a speed proportional to the travel of the ram. By this device a complete record of the pressure required to force the wheel to its required position is obtained. If the record shows a straight diagonal line terminating at a point which measures the proper

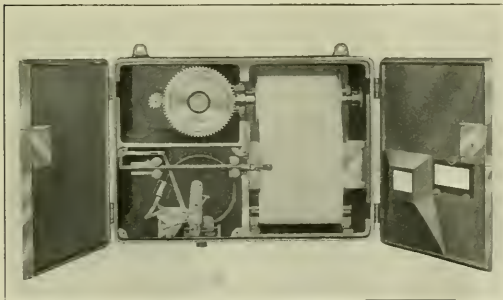

Interior Arrangement of Wheel Press Recording Gage.

pressure, it will be known that a proper wheel fit has been obtained. A hollow spot in the axle or the bore of the hub will be shown in the diagram by a dip in the diagonal line, and vice versa, a high spot will be shown by a hump in the diagonal line.

One of the important features of the recording gage is that it is inaccessible to the operator and represents the true story of the wheel fit. An opening is provided at the right of the

diagram for the signatures of the wheel fitter and the press man, and the recording of the wheel number. Each record roll has a capacity of 300 diagrams or 150 pairs of wheels. The recorder is protected from over pressure by a $\frac{3}{8}$ in. hydraulic relief valve set at about 150 tons. A $\frac{1}{2}$ in. pulsating check valve protects the movement, the registering and the recording hands from sudden fluctuations in pressure. The recording gage is cut in or out by a $\frac{1}{2}$ in. stop cock which may be locked in the open position so that it will be impossible for the operator to cut out the gage if it is found that an imperfect fit is being made. When dismantling wheels the recording gage can be cut out of service.

The gage is so designed that the paper travels in one direction and only when the ram is on its outward stroke. The winding drum is operated through a train of gears and a pawl and ratchet which are in turn operated by a chain running over a sprocket wheel and connected to the ram, the other end of the chain being weighted, as shown, to pull it back to the starting position. On the advance stroke of the plunger the pawl engages in the ratchet and turns the paper, while on the return stroke it slips back over the ratchet without moving the paper; in this way one continuous record of wheel fits is obtained. A special scale is provided with each recording gage with which to measure the pressure and travel of the wheel from the diagrams.

CONVERTIBLE SEAT FOR COMPARTMENT CARS

Sleeping car berths are not as wide as could be desired because of the limitations placed on the width of the cars, and the necessity of providing sufficient aisle space. In compart-



Lower Berth Showing Convertible Seat End.

ment cars, however, where there is a separate passageway through the car outside the compartments, there is no objection to using the aisle for extending the berths, and some of the compart-

ment sleeping cars running in the Twentieth Century Limited are equipped with a device for this purpose. The seat ends are hinged so that they can be swung down and supported by an angle brace and form a horizontal extension of the seat. When the two seats are pulled out, as is ordinarily done in making up a lower berth, a filler is placed between the two ends after they



Seat End in Extended Position.

have been lowered, thus forming a full size bed. In traveling long distances passengers frequently become tired and wish to rest during the day, and with this type of seat the end may be swung down at any time and a comfortable couch provided on which a person may stretch out at full length. This extension seat was invented by Mrs. R. C. Smith, Chicago, Ill., and the patents are controlled by the Pullman Company.

TURNTABLE TRACTOR

A type of turntable tractor which is made by the Weir & Craig Manufacturing Company, Chicago, is shown in the illustrations.

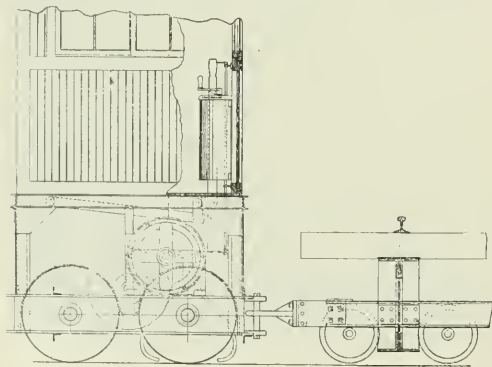

Fig. 1—Turntable Balanced, with Truck Wheels Slightly Above Rail.

It is designed to readily move the largest turntables when loaded with Mallet or other heavy locomotives and also to stand prac-

tically as an independent unit on the pit rail, so that no shock or vibration will be communicated to it or any of its parts when the locomotive is placed on the table; this is obtained by connecting the main frame to the table by sliding links.

Trouble has been experienced in some designs because the entire machine was pivoted on one wheel and had a comparatively rigid connection to the table. Considerable shock and vibration was thus communicated to the tractor, causing trouble with the wiring to the motor and the controller, as well as with the bearings and other parts, and this method of eliminating the vibration should reduce the cost of maintenance and increase the efficiency of the device. The tractor is designed, primarily, for electric power but may be equipped with a compressed air motor if electricity is not available, in which event the air motor may be replaced by an electric motor at any later time without alterations to the remainder of the machine.

By reference to the diagrams it will be seen that the tractor remains on the rail in its normal position, regardless of any vertical movement of the table. Fig. 1 shows the table balanced with the truck wheels slightly above the rail; in this position the sliding link connection is in line with the main portion of the frame. Fig. 2 shows the table in the highest position, caused by a locomotive passing on at the opposite end, the sliding connection in this case being at the upper portion of the frame. It will be noticed that whatever the position of the table, the tractor remains stationary.

The machine with the housing removed and part of the cab cut away is shown in Fig. 3. This view shows the location of the tractor wheels, gearing, sanding device, brake lever, motor, etc. The cab is furnished with sliding windows and is 4 ft. 6 in.

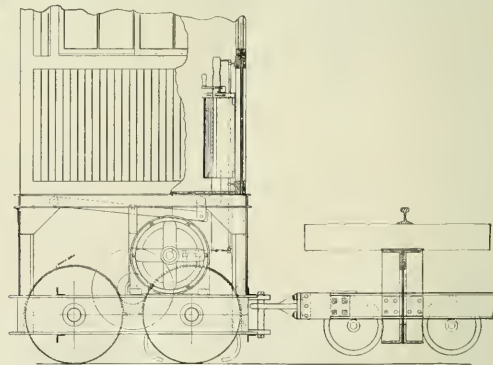

Fig. 2—Turntable in Its Highest Position Relative to the Tractor.

x 5 ft. 6 in., providing abundant room for the operator after the installation of the apparatus. The traction wheels are 30 in. double plate, with flat chilled treads, and each is furnished with a steel driving gear, securely bolted to a faced shoulder on the inside of the wheel; all the gears and pinions are steel, carefully machined and accurately cut. The electrical equipment may be furnished according to the railroad's specification.

Steel band brakes, controlled by a hand lever in the cab, are applied to each of the wheels and have a positive action, avoiding the danger of stripping the gears as may be the case when brakes are applied to a drum on the motor or intermediate shafts. The positive action of the brake removes the temptation or the necessity on the part of the operator to reverse the motor in order to stop at a given point, thereby materially reducing maintenance charges on the electrical equipment.

The sanding device consists of a cast iron hopper which is tapered at the bottom and contains about 1½ cu. ft. of sand; it is furnished with a cast iron cap set level with the floor of the

cab and the hopper can be filled from the inside of the cab, so that there is no opportunity for the sand to get wet; the plug valve in the bottom of the hopper is controlled by a lever in the cab.

The frame, which carries all the equipment, is of a heavy design and is cast in one piece; a structural steel frame, on which

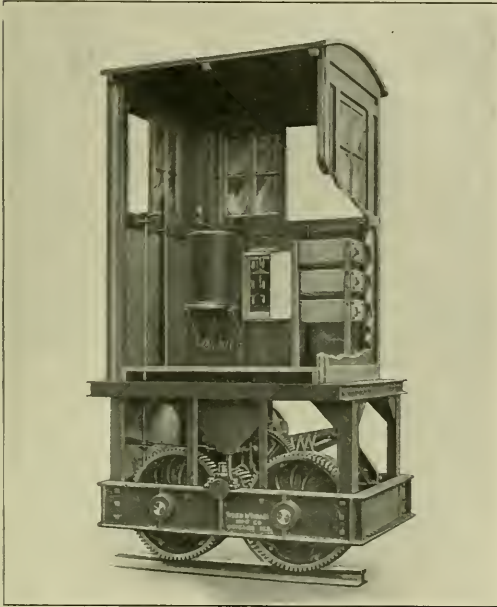

Fig. 3—Arrangement of Apparatus on Turntable Tractor.

the cab rests, is riveted to it. The sliding link which connects the tractor to the table is fastened to this frame. As shown in Fig. 4, this frame is supplemented by a structural steel A-shaped frame which extends toward the center of the table and is also

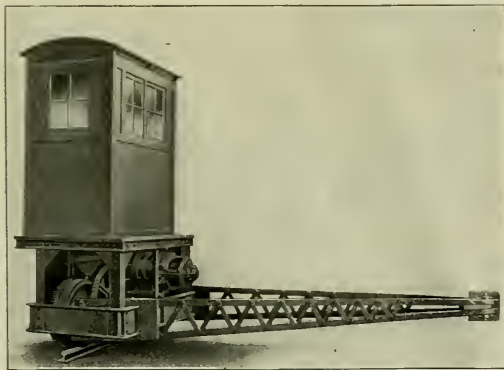

Fig. 4—Turntable Tractor.

connected to the girder by a sliding link. The motor and all the working parts are enclosed by sheet steel plates in which are provided doors of ample size; all the working parts are thus easily accessible for inspection and repairs.

SAFETY SQUIRT HOSE

The necessity for a substitute for the common squirt hose used by firemen in wetting down coal, and operated with hot water from the injector, is shown by the fact that out of a total of 856 accidents in 1912, the chief inspector of locomotive boilers reported to the Interstate Commerce Commission that 243 were due to defective squirt hose and connections. As long as hot water is used the danger of scalding will be present and to avoid this the Watertown Specialty Company, Watertown, N. Y., has placed on the market a device for supplying cold water direct from the tender.

The apparatus consists of a steel cylindrical tank *A*, an automatic water inlet valve *B*, and a combination air and water cock *C*. The tank is flanged at the top so that it may be secured to the tender by bolts or studs, and is 10 in. in diameter while

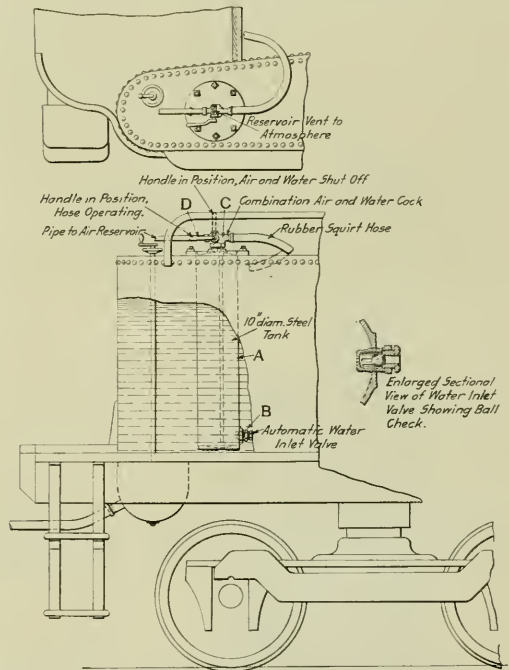

Application of Watertown Safety Squirt Hose to Locomotive Tender.

the length is made equal to the inside depth of the tender. At the bottom of the tank is the bronze ball check valve *B*, which is of simple construction; when the hose is inoperative this valve is open, allowing the tank to fill to the same height as the water in the tender. The tank is connected by means of a 1/2-in. pipe to the main air reservoir and a three-way air port in the combination air and water valve *C* allows air to enter the tank or shuts it off and vents the tank to the atmosphere. A water port in the valve carries a pipe that runs to the bottom of the tank, and on the other end another pipe to which is attached the squirt hose *C*.

With the air shut off by means of the handle *D*, the tank is vented to the atmosphere, the ball check in *B* opens and the tank fills ready for use. When it is desired to operate the hose all that is necessary is to throw down the handle *D*, which admits air to the reservoir and closes the vent to the atmosphere; the air pressure then closes the check valve *B* and the water in *A*

is forced up through the pipe and out through the hose. To shut off the hose the handle *D* is thrown up, the air in the tank escapes through the vent and the tank immediately starts to refill. The tank is never under pressure except when the hose is in use and always fills automatically when the hose is not in use.

This squirt hose may very easily be installed on any locomotive by cutting a 10-in. hole in the top of the tender tank where it is desired to locate the operating valve. The device is extremely simple in construction and should the bottom check valve become clogged with mud or refuse it may easily be cleaned by disconnecting the air line and fastening bolts and lifting the entire apparatus out of the tender. No part is built into the tender or located in such a way as to be inaccessible for cleaning or inspection.

AUTOMATIC SHUT-OFF VALVE

The valve which is shown in the illustrations, is so designed that when used as an outlet fitting on a holder or main containing gas or other fluid under pressure, a free passage of the fluid is permitted; if, however, the pressure in the distributing line

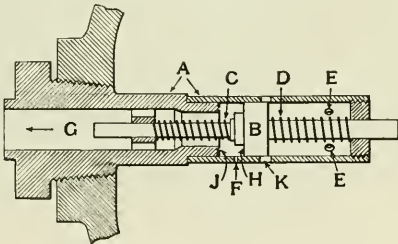

Automatic Shut-Off Valve Applied to a Gas Holder.

falls due to a leak or break in the line, the valve automatically closes off the flow and remains closed until the pressure is restored on the outlet side of the valve, when it at once readjusts itself to its normal position. It is also suitable for a charging fitting, as the excess charging pressure forces back the valve piston and uncovers a series of ports in the cylinder, permitting a free flow of fluid into the holder. The illustrations indicate the construction of the valve, one of them showing a type for use in

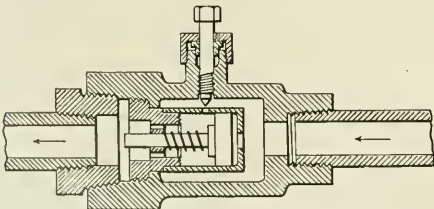

Automatic Shut-Off Valve with Adjusting Screw for Varying the Flow of Gas.

a holder and the other a type designed for use in a distributing system where the flow of fluid is always in one direction.

Within the body *A* of the valve is a piston *B* constrained in its normal position by two springs *C* and *D*; the pressure within the holder is always free to act upon one side of this piston, having access through the ports *E*. The orifice or port *F* is of such a size that it will permit a flow of fluid sufficient to retain a pressure in the outlet passage *G* practically equal to that in the holder itself. It is evident that if the pressure in the passage *G* is materially reduced below that in the holder, as would result from a leak or break in the distributing piping, the full

holder pressure acting upon the inner face of the piston *B* will force the piston out, cutting off further flow of fluid through the port *F* by pressing the seat *H* of the piston against the surface *J* of the casing; upon restoring the pressure in the passage *G*, the piston is returned to its normal position. An excess of pressure in passage *G*, such as occurs during the process of charging the holder, acts upon piston *B*, pushing it back against the resistance of spring *D* and uncovering a series of ports *K* which are of sufficient area to provide for unrestricted flow into the holder.

The operation of the other form of the valve is similar to this except that no provision is made for its use as a filling device. The illustration shows a means of varying the flow by the use of an adjusting screw; by a modification of design this adjustable feature may be applied equally well to the other type. This valve was invented and patented by M. P. Stevens, manager of the Edward Schroeder Lamp Works, Jersey City, N. J.

NEW LOCOMOTIVE DRIVING WHEEL

The increase in the weight of locomotives has made it necessary to add to the weight of rails, and the high-carbon rail is, it would seem, a step in the right direction. Undoubtedly a large amount of rail destruction is due to vertical bending under the weight imposed by the driving wheel, but few have

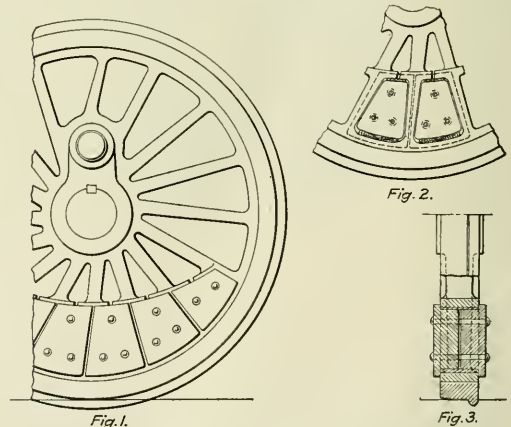

Fig. 1.

Fig. 2.

Fig. 3.

A New Type of Locomotive Driving Wheel.

seriously thought of solving the problem by changing the construction of the wheel. This is perhaps due to a realization that the weights of locomotives are more likely to increase than decrease; however, the damage to the rail is not all caused by the weight alone. Another factor which enters is the passage of the counterbalance over the point of support. Because of rigidity it is possible to concentrate an enormous mechanical effect upon a restricted area, an instance of which is furnished by the Shore hardness tester, an instrument employed in testing and comparing the hardness of metals. A kind of hammer is permitted to fall freely in a vertical glass tube and to strike a blow upon the surface whose hardness is being investigated; the height of the rebound is taken as the measure of the hardness. The steel hammer has a length of about $\frac{3}{4}$ in., a diameter of less than $\frac{1}{4}$ in. and a weight of 40 grains and is pointed on the lower end so that the area of impact is very small. Because of the rigidity of its material, a very large percentage of the force of the drop is concentrated upon this small surface and it has been found that the existence of a flaw in the hammer is sufficient to interfere seriously with the rebound. Further, it has

been learned that the work which is under test must be well supported and these facts suggested that if it were possible to break up the continuity of the counterweight of a driving wheel, or reduce its rigidity to a minimum, it would result in less damage to track and equipment.

The wheel shown in the illustration was devised and patented by A. F. Shore, the inventor of the instrument for testing hardness, working along these lines. The counterbalance is broken up into a number of units, and it is claimed that it is impossible for it to deliver to the rail as severe a blow as is given by a rigid one of equal weight. There is, it is claimed, a dissipation of shock because of the interruptions to the continuity in the mass of the counterbalance. A still further dissipation is effected by means of wooden blocks interposed between the metal blocks and the rim of the wheel. This construction is shown in Figs. 2 and 3.

The inventor has also sought to dissipate the shock by angularly displacing the spokes. From Fig. 1 it will be seen that the spokes are arranged in such a way that their axes pass off to the side of the center point of the wheel, each becoming tangent to a small circle concentric with the wheel itself. The spokes are, therefore, not radii of the wheel, and it is claimed by the inventor that this splits up the impact force into local and lateral vibrations within the wheel itself, and diminishes the force on the rail.

BAXTER CHARCOAL CAR HEATERS

A charcoal heater that is inexpensive to operate, and one that has given efficient service in extremely low temperature, is shown in the illustrations. The outside shell is made of corrugated metal and forms the body of the heater, supporting the magazine at the top and creating a radiating surface around the fire pot of such area as will insure boxes and packages not catching fire should they fall against it. A positive lock on the base secures the fire pot to the shell, preventing the hot coals from being emptied from the heater into the car in the event of ac-

cidental damage. The magazine is then replaced and the supply slide opened. The heater is then in full operation.

A report on one of these heaters in use on a Canadian road tells of a carload of potatoes, passing through temperatures of 38 to 42 deg. below zero, being received in perfectly good condition when the outside temperature was 38 deg. below. A carload of beer, passing through temperatures of from 28 to 36 deg. below, was received with an inside temperature of 60 deg. above with the thermometer registering 35 deg. below outside of the car.

These heaters are manufactured in three sizes; the No. 1 or the large size is designed for use in protecting less than carload business, in which service the car door on local trains is not only opened often, but is frequently allowed to remain so for many minutes, thus requiring the generation of considerable heat in a short time to again raise the temperature in the car to the proper degree. The No. 2 heater is designed to fit into the ice bunkers of refrigerator cars, and is provided with an automatic brace, as shown in one of the illustrations, which locks it fast in the center of the bunker. Two of these heaters are used with each car, one in each bunker. The No. 3 is a heater designed to meet the requirements of breweries where a suspended heater is preferable. These heaters are in a size between the No. 1 and No. 2, and are provided with heavy hooks which fasten into the screw-eyes applied to the carlines, thus suspending the heater out of the way of the kegs which are rolled on the floor of the car. The No. 2 heater will operate 36 hours without refilling, at a cost of 15 cents for the charcoal; the other heaters will operate up to 96 hours without refilling. It will be noted from the drawing that briquettes may also be used. An additional feature of the charcoal heater is the giving

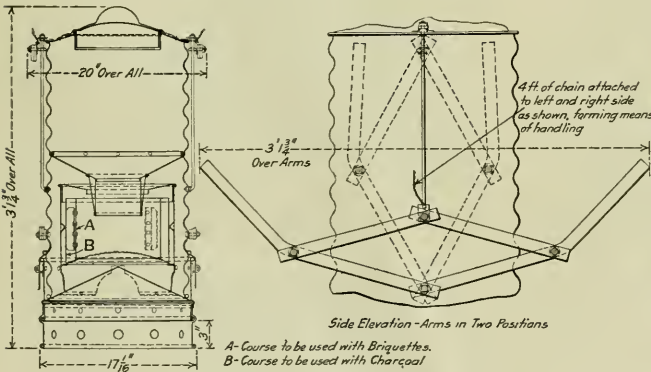

Baxter Charcoal Car Heater for Perishable Freight.

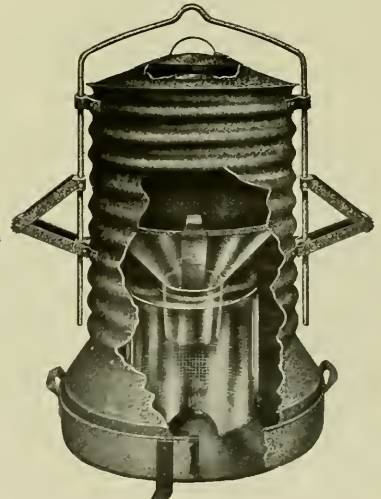

cidental. The hasp on this lock is provided with slots for two positions, permitting the fire pot and its grate to be varied in its distance from the feed spout of the magazine, thus creating a simple means of regulating the rate of combustion by changing the thickness of fire without altering the inlet draft passage areas.

The heaters are started by means of an igniter or "starter," which is made of blotting paper saturated in a solution of potassium nitrate and then pressed into the shape of a pie plate, being provided with a hole in the center. These starters are placed on the grate and a lighted match is applied to the edge of the hole in the center of the igniter, which burns without a flame;

off of the carbon monoxide gas which not only helps to preserve any fruit or vegetable freight carried, but also kills any animal life that may be confined in the car, such as rats, mice, tarantulas, etc. For this reason the car should be opened a few minutes before any person is allowed to enter.

These heaters are in service on 15 railroads; they are made by the Klauer Manufacturing Company, Dubuque, Iowa.

FORESTRY IN FRANCE.—France has spent \$35,000,000 in planting trees on the watersheds of important streams.

WELDING AND CUTTING WITH OXYGEN AND ILLUMINATING GAS

The success that has attended the use of high temperature gases and electricity for the welding and cutting of metals has been so marked that any development of these systems is of interest. The system described in this article uses a combination of oxygen and illuminating gas taken from the city mains. One of the illustrations shows the apparatus as set up in a permanent installation, although, by the use of flexible connections a portable outfit may easily be constructed. The illuminating gas passes from the meters to a water jacketed booster *K* which is driven by a small electric motor; this booster is used to raise the pressure of the gas, its maximum capacity being 30 lbs. per sq. in., although more than 14 lbs. is never required for even the heaviest cutting, as this pressure has proved sufficient when cutting steel bars 8 in. square. From the booster the gas passes upward through the pressure regulating waterseal *L*, then through the pipe *M* to the pressure gage and the specially constructed reducing valve *N*, which

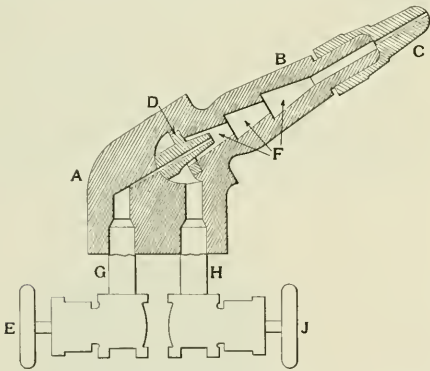

Burner for Welding and Cutting with Oxygen and Illuminating Gas.

reduces the pressure to that required for whatever class of work is being done. From the reducing valve the gas passes directly through the pipe *O* to the burner where it is combined with the oxygen.

The use of tanked oxygen, as in other welding processes, is recommended. The oxygen is stored in the tanks *P* and passes through the small coil pipe to the reducing valve *Q*, from which it passes through the pipe *R* to the burner. The maximum pressure used in the oxygen for welding is 25 lbs. per sq. in., and for heavy cutting up to 50 and 100 lbs. The illustration shows a two-torch outfit, but they may be built to any required size and there is one 14-torch outfit in successful operation.

The other illustration shows the construction of the burner or torch. This burner insures the complete mixture of the gases by means of the multiple stage system of mixing chambers and has been approved by the New York Municipal Explosives Commission. It will be seen that the two gases are separated until they enter the mixing chamber through the parallel ports of the transformer. Each torch is equipped with 10 tips, which are numbered and permit a full range of work, and the ground joints facilitate the changing of the tips. Referring to the illustration, *A* is the head piece, *B* the stationary nozzle, *C* the tip, *D* the transformer, *F* expansion mixers, *G* the oxygen conduit, *H* the illuminating gas conduit, and *E* and *J* are needle valves.

It has not yet been found possible with this system to weld

either wrought iron or steel, but the welding of cast iron in medium thicknesses has proved successful and economical. Steel and wrought iron may be readily cut and steel bars up to 8 in. square have been cut with great success. The process is especially adapted for the smaller sizes of iron castings and is most economical and efficient on brass and aluminum work. It is quite applicable to such work as the repairing of brass castings, the filling in of blow holes and in boiler shops, particularly, for the cutting of plates; there are also many opportunities for its use in electric railroad repair shops as well

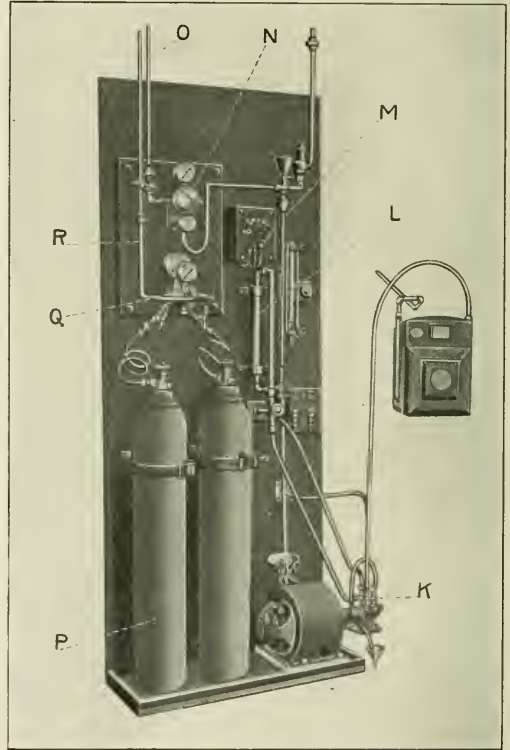

Apparatus for Welding and Cutting with Oxygen and Illuminating Gas

as in signal work. The process has been developed by E. Raven Rosen-Baum, consulting engineer on high temperature gases, 607 West Forty-third street, New York, and all the apparatus has been patented by him.

QUADRUPLE COMBINATION MACHINE

The design of this machine was the result of the experience with the Oeking solid steel frame triple combination machines. It is a quadruple combination machine, which the manufacturers term the "Imperator" type, and is being placed on the market by the Wiener Machinery Company, New York, as managers for the Oeking Company, Dusseldorf, Germany. The machine is the result of careful study and contains in one frame, ready for work, all the tools for a large variety of cutting, shearing, coping, mitering and notching. It is claimed that it is the only machine of the kind that is in actual operation. The frame is made of steel in one piece and the machine is sufficiently com-

pect to make it suitable for use in crowded shops; it can also be used in plants where driving power is limited. It will, without changing tools, split plates of unlimited length; cut flat bars; shear off rounds and squares; cut and miter angles and tees, right and left, at any degree; and punch plates and structural

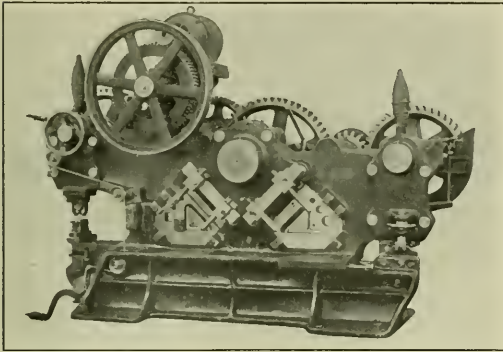

Imperator Quadruple Combination Machine.

material, both webs and flanges. With interchangeable tools, beams, channels, etc., can be cut. The punching tools may be interchanged for coping, mitering, etc. The machines are built in three sizes and are furnished with tight and loose pulleys for belt drive or can be arranged for direct motor drive; if desired they can be equipped with a turntable to facilitate the mitering of long angles. It is claimed that these machines do not cost more than the equivalent in single machines.

UNIVERSAL BLOW TORCH

The gasolene blow torch shown in the illustration embodies a number of improvements which, it is claimed, adapt it to all

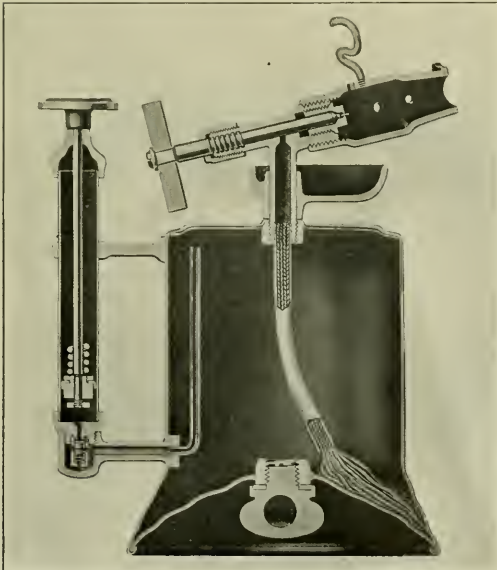

Section Through Universal Blow Torch.

conditions of service. The burner is made particularly heavy so that it will retain its heat and keep the torch burning in cold or windy weather, while the drip cup is made especially deep so that it will start the torch under bad weather conditions. The burner valve is self-cleaning, the needle at the end of the valve stem cleaning the hole automatically when the valve handle is turned. This avoids injury to the valve seat caused by picking at the opening to clean it. The valve seat is a separate replaceable plug and the handle of the valve is of fibre which will not burn or become hot. It is claimed that the tank is made of the heaviest gage brass ever used for this purpose; it is reinforced with an extra corrugated brass disc covering the entire inner surface of the tank pot, which insures the tank keeping its shape under very rough handling. The pump valve works in a cylindrical guide which assures perfect seating and it can be taken apart and any part replaced separately.

The illustration shows the quart size of the torch; a pint size is also made, differing only in the shape and size of the tank. These torches are being placed in the market by the Westinghouse Electric & Manufacturing Company, East Pittsburgh, Pa.

BALL BEARINGS IN AXLE LIGHTING GENERATORS

It has been found that in automobiles, electric motors, etc., ball bearings provide a solution of the costly and annoying troubles oftentimes caused by plain bearings. Large numbers of passenger equipment cars are being fitted with electric light-

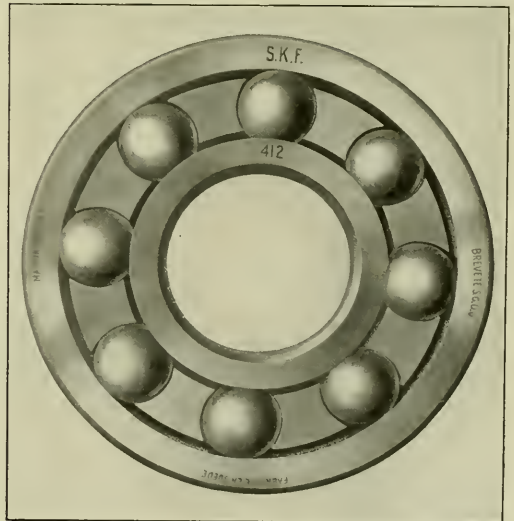

S. K. F. Railway Type Ball Bearing.

ing systems, and it is claimed that considering the saving in attention required and in the amount of lubrication, the prevention of the danger of dropping armatures as a result of worn bearings of the plain type, and the consequent expense, that it would be economical to discard the old type bearings and use ball bearings on the axle generators. The S. K. F. Ball Bearing Company, New York, has had a pair of its railway type double row self-aligning ball bearings, similar to that shown in the illustration and fitted with 16 1-in. balls, applied to an axle lighting generator in constant service for over 19 months on a car running between New York and Chicago, during which time over 170,000 miles were run. These bearings were re-

moved for inspection June 20, 1913, and were found to be in such good condition that they have been put back in service in the same generator.

AUTOMATIC TRAIN PIPE CONNECTOR

The Blue Grass Special of the Queen & Crescent has been equipped with the Durbin automatic train pipe connectors, which automatically couple the air, steam and signal lines, and also pro-

vide for telephone communication between all of the cars and the locomotive. The connector is attached to the car independent of the coupler. It is of the butt-face type and all the connections are arranged in a vertical line coincident with the center line of the car. With the butt-faced coupler the ports will register accurately when coupling, and the gaskets will not be subjected to such severe treatment as in the side-face type; it is also

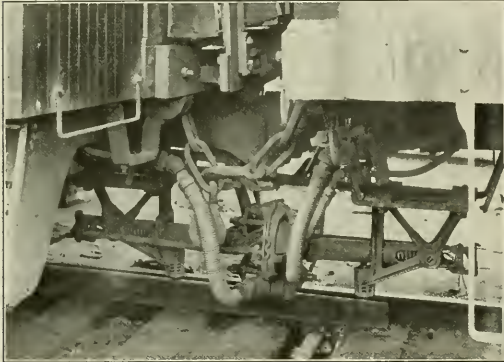

Durbin Automatic Train Pipe Connector as Connected in Service.

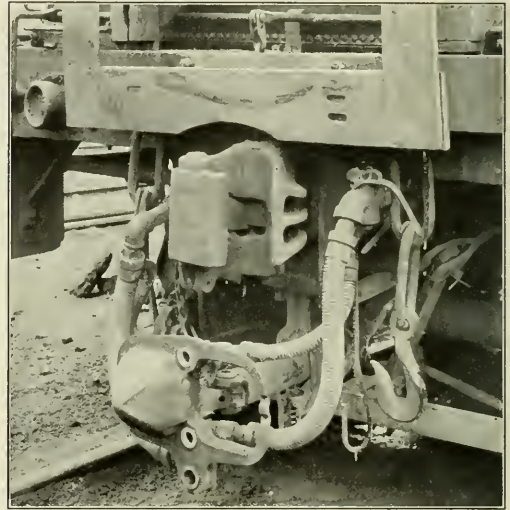

Durbin Automatic Train Pipe Connector Applied to a Locomotive Tender.

vide for telephone communication between all of the cars and the locomotive. The connector is attached to the car independent of the coupler. It is of the butt-face type and all the connections are arranged in a vertical line coincident with the center line of the car. With the butt-faced coupler the ports will register accurately when coupling, and the gaskets will not be subjected to such severe treatment as in the side-face type; it is also

possible to keep a more perfect joint between the gaskets without relying on springs to keep the heads together. The gaskets can also be replaced without separating the cars. Having the connections in a vertical line has been found to be an improvement over having them in a horizontal line, for there is less liability

of the connections springing apart and creating a leak when the train is passing around a curve. The design of the connector is clearly shown in the illustrations. It is made of malleable iron and is pivoted 6 in. behind

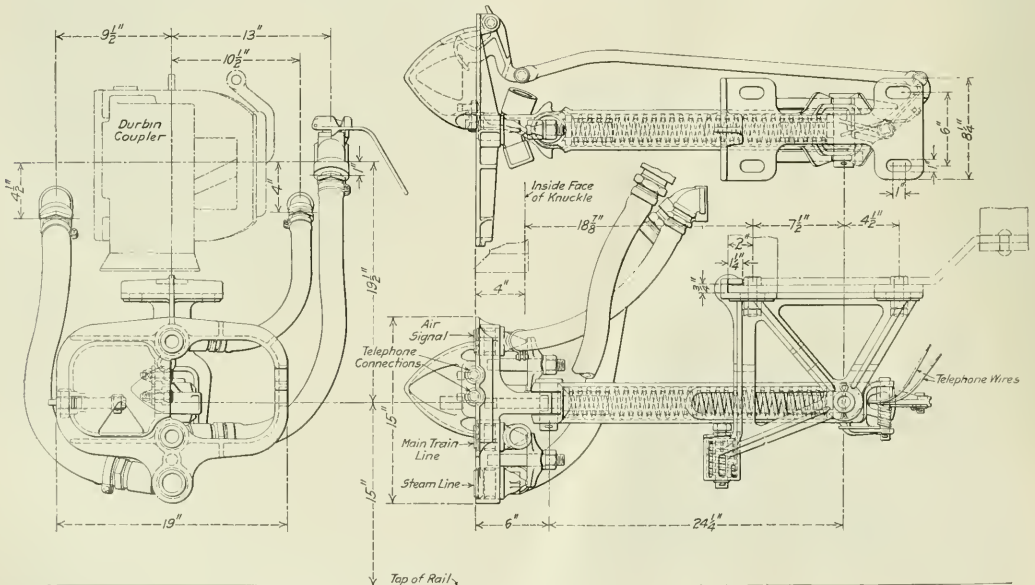

Durbin Automatic Train Pipe Connector for the Queen & Crescent.

the face of the connector to allow for the curvature of the track. It is free to move 30 deg. each side of the center, and has a vertical travel of 10 in., which is sufficient to allow for uneven track. The coupler has a gathering range of 4½ in. in a vertical direction and 5 in. in a horizontal direction, which insures its engagement on any curve. It has a horizontal travel of 10 in., and is forced out by a spring made of vanadium steel. Even though the connectors are forced together by these springs when the cars are coupled, they also are automatically locked so that there is no possibility of their jarring open while on the road. This lock will only trip when the cars have been uncoupled and have started to separate. The hose couplings are held in the coupler head by a bridge bolt as shown in the drawing. This makes it possible for the hose coupling to be removed from the connector head for a new gasket without it being necessary to uncouple the cars. A metal gasket is used on the steam line. The plugs for the telephone connection are located between the signal line and air brake line couplings.

One of the greatest advantages of this connector is that it obviates the necessity of men going between the cars to couple the hose. It keeps the hose in an almost rigid position which will tend to reduce the hose failures due to abrasion, and on account of its construction it will practically eliminate torn hose. This device will also save considerable time in connecting up a train of cars. It is sold by the Durbin Automatic Train Pipe Connector Company, St. Louis, Mo.

COMPENSATING QUADRANT CRANE

In the ordinary derrick type of crane, when the jib is raised to bring the load inward, the load itself is also lifted and any movement of the jib results in a change of level of the load. This is particularly inconvenient when the headroom is small or where the possible height of the lift in any position is limited. A crane which overcomes these objections and is designed

plate, a frame work being built on the latter. The actuating screws work in bearings in the top connecting piece of the crane, this piece also holding the bearing at the top of the post; the bearing at the bottom of the post is a part of the bottom



Truck Crane of One Ton Capacity.

plate. The actuating screw swings the quadrant by means of a nut which slides on a guide on the top part of the frame. For

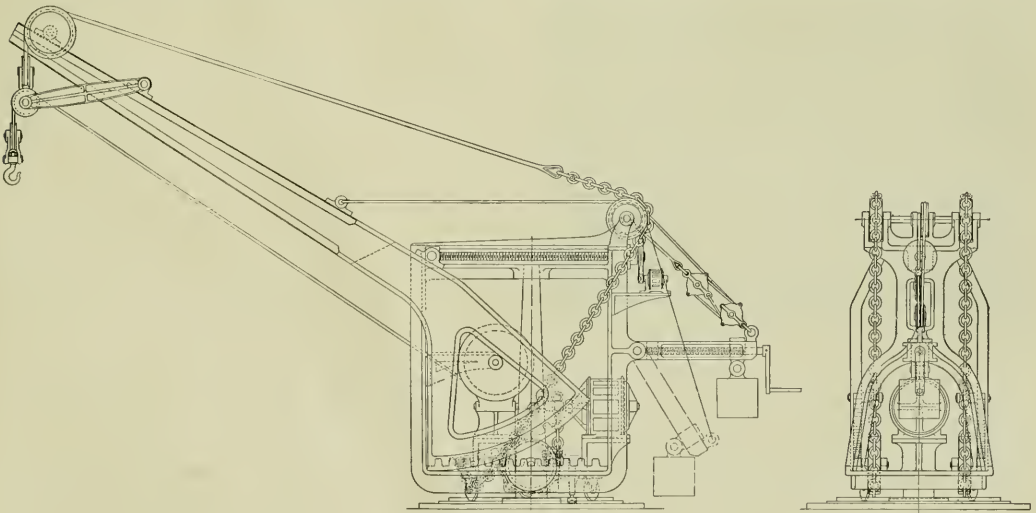

Compensating Quadrant Crane.

to allow the load to be swung in and out without change in its level is illustrated herewith.

The compensating quadrant crane is of the derrick type, with the jib securely fastened at its lower end to two quadrants; in the smaller cranes the jib and the quadrant are cast in one piece. The quadrant is provided with a finished rolling surface and teeth that engage in a rack and roll in a slot on the bottom

slewing, the bottom plate is provided with four rollers that roll on a beveled flange on the post plate.

There are two different compensating devices. The first is obtained by the use of two parallel links pivoted at one end near the top of the jib, and at the other end holding two sheaves over which the hoisting ropes run. This end of the links is held by a chain that runs over the sheave at the top of the jib, and is

connected by means of a rod with a three-arm dog pivoted at the top of the back frame. The other two arms of the dog are connected with the lower back end of the quadrants by means of two chains running over sheaves on the bottom plate. In the second device for compensation, the fixed end of the hoisting rope is fastened to the jib at a suitable point near the top, and from this point runs back and forth over sheaves on the back part of the frame and on the top of the jib.

The hoisting machinery is of the usual kind, made of dimensions suitable for the purpose for which the crane is to be used. The slewing is done by a system of gears under the bottom plate, which engage an annular rack in the post plate. The derriking is accomplished by means of the actuating screw, which is provided with a worm or spur gear drive; the necessary counterbalancing is accomplished by a weight. The driving power can be of any desired kind, but the cranes are generally provided with electric motors.

This type of crane is readily adaptable for use about scrap yards and also as a wrecking or locomotive crane. It is manufactured by the Welin Marine Equipment Company, Long Island City, N. Y.

SAFETY AXLE GENERATOR SUSPENSION

Owing to the many designs of car trucks in use it has been necessary to design a special suspension for axle lighting generators to meet the requirements of each type. The suspension used by the Safety Car Heating & Lighting Company, New York, is designed for application to any car truck, without losing the advantages of parallel suspension. With the exception of the few supporting irons, which have to be adapted to the various trucks, all the parts of this suspension are standard. The elimination of links as part of the suspension produce an open construction, giving easy access to the generator and permitting of

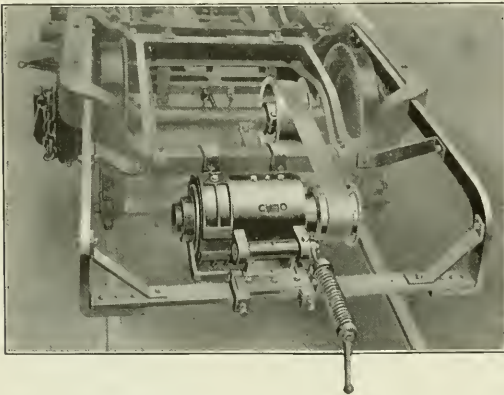

Safety System of Generator Suspension.

thorough inspection, while the generator may also be easily aligned with the pulley on the truck axle. Wear is confined to a few inexpensive pieces with large surfaces and these are protected with felt gaskets and lubrication to insure maximum durability. Constant belt tension is provided throughout the range of belt stretch and the natural movement of the axle in the truck. Only one tension spring is required to maintain the required belt tension and a stop is provided which it is claimed prevents the application of excessive tension either through error or accident.

INDO-CYLON RAILWAY CONNECTION.—Work on the Indo-Ceylon connection, South Indian Railway, is proceeding steadily. More than two-thirds of the earthwork is finished.

OSMAN BOILER CHECK

The boiler check is one of the most important accessories of the locomotive, and one which, if not given proper attention, may cause a great deal of trouble. The Osman boiler check, which is shown in the illustration, has been developed after a number of years' experience with different types of checks, and it is claimed that it will reduce difficulties from this source to a minimum.

The valve is constructed with a spindle and four wings at the top acting as guides. The main spindle, to which is attached the hand wheel, has on the lower end a clutch which engages

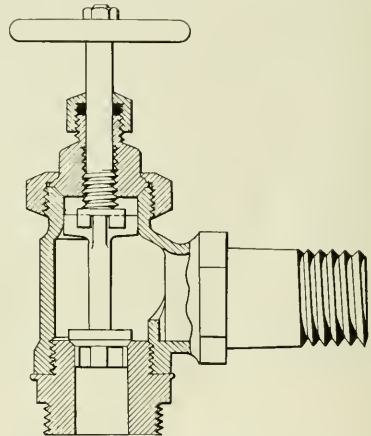

Osman Boiler Check with Removable Valve Seat.

with these wings so that in case the valve sticks in an open position due to scale, etc., it can be closed by simply screwing down the main spindle, the clutch then forcing the valve to its seat. The cap through which the main spindle enters is made with a ball joint on the lower side, which can be reground in position by turning the spindle. This ball joint prevents steam getting at the threads of the union nut which holds the cap in place, thus preventing corrosion. The clutch also serves as a means of regrinding the check valve. The valve seat is made in a piece separate from the casing of the valve so that it is easily removable for repairs and may be replaced when worn out without the necessity of scrapping the entire casing. At the entrance to the boiler a bridge, or baffle, is provided in the casing which, it is claimed, prevents oscillation in the valve with consequent one-sided wear. This valve is manufactured by the Swenson Valve Company, Decorah, Iowa.

MOTOR BUSES IN LONDON.—In 1903 there were 3,500 horse omnibuses in use in the streets of London. There are now only 100 in use and it is expected that by the beginning of 1914 this type of vehicle will have been entirely done away with.—*The Engineer*.

NEW PORT RAILWAY IN URUGUAY.—The Montevideo Port railway, inaugurated on May 16, runs from the main station of the Central Uruguay Railway around the port to the docks where the steamers tie up. The road is only a few miles long, but by establishing direct communication between the sea and land carriers, it represents a commercial link of the utmost importance. The docks are provided with traveling electric cranes of high power, and now that steamers are berthed at the docks and railway cars may be run to the water's edge alongside the steamers, the transshipment of cargo from railway car to steamer and vice versa may be effected without loss of time and at a minimum of cost.

NEWS DEPARTMENT

According to the Canadian forestry association 50 per cent. of Canada is capable of growing nothing but timber crops.

The Mobile & Ohio has increased the pay of locomotive engineers, the average rate of increase being somewhat less than 5 per cent.

The Delaware, Lackawanna & Western has ordered the abolition of pens and inkstands in telegraph offices and the use of indelible pencils instead.

The two-cent passenger fare became effective on the principal Missouri lines on July 1. The freight rates fixed by the state law will go into effect on July 15.

CASINO TECHNICAL NIGHT SCHOOL

In a footnote concerning the Casino Technical Night School of East Pittsburgh, Pa., used in connection with the article entitled "You Have Received, What Will You Give" in our July issue, page 351, two errors were made. Tuition is not free. A complete year costs each student between \$25 and \$30. This pays about half of the expenses, the Westinghouse Electric & Manufacturing Company paying the balance. There are 40 teachers on the faculty and not 13, as stated in the footnote.

RECEPTION TO R. H. BRIGGS

A surprise reception was tendered to R. H. Briggs, retiring master mechanic of the St. Louis & San Francisco at Memphis, Tenn., July 29, by officers and employees of the road. Mr. Briggs was born in Schenectady, N. Y., February 2, 1833, and at the age of 16 entered the Schenectady Locomotive Works as machinist apprentice, remaining in their employ until their liquidation, when he moved to New York, securing employment in the Morgan Iron Works. Here he remained until August 6, 1852, when he decided to go south, where he worked as a marine engineer, running on a steamer from Little Washington, N. C., to Buford and Newborn; he later procured the same position on a steamship operating between Wilmington and Charleston. Upon the completion of the Wilmington and Manchester, in 1854, he gave up the marine service and first entered railroad service as a locomotive engineer for that road. In 1856 he went to the Montgomery and West Point in the same capacity, and in 1859 was appointed master mechanic of the Mobile and Girard, which position he retained until 1863, when he was made supervising engineer for the United States government, having charge of repairs to government steamers at New Orleans, La. In 1865, at the close of the civil war, he secured employment as a machinist in the shops of the Mobile & Ohio at Whistler, Ala. One year later he was made roundhouse foreman and was later promoted to general foreman of shops at that point. In 1872 he was appointed master mechanic, with headquarters at Jackson, Tenn., and in 1877 was appointed general master mechanic, with office at Whistler, Ala. It was during this period, in the yellow fever epidemic of 1878, that he took charge of the local situation, distributing provisions, caring for the sick and providing burial for those who had met death through the terrible scourge. In 1883 he was appointed superintendent of motive power of the Chesapeake & Ohio Southwestern, and in the latter part of 1886 went to the Atchison, Topeka & Santa Fe as master mechanic at Argentine, Kan., remaining there until February 2, 1888, when he accepted the position of master mechanic at Memphis for the K. C., M. & B., now the St. Louis & San Francisco Railroad, which position he retained until the date of his retirement, July 1, 1913.

DR. GOSS APPOINTED TO CHICAGO SMOKE ABATEMENT COMMITTEE

W. F. M. Goss, dean and director of the College of Engineering, University of Illinois, has been elected chief engineer of the Chicago Association of Commerce committee for the investigation of smoke abatement and electrification of railway terminals, to succeed the late Horace G. Burt. Dr. Goss will be granted leave of absence from the university for one year, during which time it is believed that the investigation will be completed and a report of the committee's conclusions issued. He has been a member of the committee since its organization three years ago. Dr. Goss was born at Barnstable, Mass., in 1859, and was educated at the Massachusetts Institute of Technology, at Wabash College and at the University of Illinois. He organized the department of practical mechanics at Purdue University in 1879, and was professor of experimental engineering, dean of the schools of engineering and director of the engineering laboratory at Purdue from 1890 to 1907. He has held his present position at the University of Illinois since September, 1907.

ANNIVERSARY OF OPENING OF THE WEST SHORE

At a dinner at the Hotel Astor, New York City, July 9, about 150 railroad men celebrated the thirtieth anniversary of the opening of the first division of the New York, West Shore & Buffalo, now the River division of the New York Central. Representative railroad men from Maine to the Missouri Valley and from the South were in attendance. The guest of honor was Charles W. Bradley, seventy-five years old, who was the first of the minor employees to be made a general officer of the company. He is now the superintendent of telegraph of the Chesapeake & Ohio. Among those who made speeches were: John B. Kerr, vice-president of the New York, Ontario & Western; J. McCulloch, of the New York Telephone Company; F. E. Harriman, local traffic manager of the New York Central; J. H. Hustis, vice-president of the New York Central; C. D. McKelvey, inspector for the New Jersey Public Utility Commission; Ira A. Place, vice-president of the New York Central; Walter E. Pollock, manager marine department, New York Central, and Percy R. Todd, president of the Bangor & Aroostook.

MEETINGS AND CONVENTIONS

The following list gives names of secretaries, dates of next or regular meetings, and places of meeting of mechanical associations.

AIR BRAKE ASSOCIATION.—F. M. Nellis, 53 State St., Boston, Mass.

AMERICAN RAILWAY MASTER MECHANICS' ASSOC.—J. W. Taylor, Old Colony building, Chicago.

AMERICAN RAILWAY TOOL FOREMEN'S ASSOCIATION.—A. R. Davis, Central of Georgia, Macon, Ga.

AMERICAN SOCIETY FOR TESTING MATERIALS.—Prof. E. Marburg, University of Pennsylvania, Philadelphia, Pa.

AMERICAN SOCIETY OF MECHANICAL ENGINEERS.—Calvin W. Rice, 29 W. Thirty-ninth St., New York. Annual meeting, December 3-6, Engineering Societies' Building, New York. Railroad session, Thursday morning, December 5.

CAR FOREMEN'S ASSOCIATION OF CHICAGO.—Aaron Kline, 841 North Fifth St., Chicago; 2d Monday in month, Chicago.

INTERNATIONAL RAILWAY FUEL ASSOCIATION.—C. G. Hall, 922 McCormick building, Chicago.

INTERNATIONAL RAILWAY GENERAL FOREMEN'S ASSOCIATION.—William Hall, 829 W. Broadway, Winona, Minn.

INTERNATIONAL RAILWAY MASTER BLACKSMITHS' ASSOCIATION.—A. L. Woodworth, Lima, Ohio. CONVENTION, August 18, 1913. Richmond, Va.

MASTER BOILER MAKERS' ASSOCIATION.—Harry D. Vought, 95 Liberty St., New York.

MASTER CAR BUILDERS' ASSOCIATION.—J. W. Taylor, Old Colony building, Chicago.

MASTER CAR AND LOCOMOTIVE PAINTERS' ASSOC. OF U. S. AND CANADA.—A. P. Dane, B. & M., Reading, Mass. Convention, Sept. 9-12, 1913, Ottawa, Can.

RAILWAY STOREKEEPERS' ASSOCIATION.—J. P. Murphy, Box C, Collinwood, Ohio.

TRAVELING ENGINEERS' ASSOCIATION.—W. O. Thompson, N. Y. C. & H. K., East Buffalo, N. Y. Convention, August 12-15, 1913, Hotel Sherman, Chicago, Ill.

PERSONALS

It is our desire to make these columns cover as completely as possible all the changes that take place in the mechanical departments of the railways of this country, and we shall greatly appreciate any assistance that our readers may give us in helping to bring this about.

GENERAL

HENRY B. BROWN has been appointed general fuel inspector of the Illinois Central, with headquarters at Chicago, Ill.

P. T. DUNLOP, mechanical superintendent of the Gulf, Colorado & Santa Fe, has been appointed general superintendent of motive power of the St. Louis & San Francisco, with headquarters at Springfield, Mo., succeeding George A. Hancock, resigned on account of ill health.

J. F. GRAHAM, assistant general manager of the Oregon-Washington Railroad & Navigation Company, has been appointed superintendent of motive power with headquarters at Albina shops, Portland, Ore.

WILLIAM P. HAWKINS has been appointed assistant fuel agent of the Missouri Pacific and the St. Louis, Iron Mountain & Southern, with headquarters at St. Louis, succeeding W. J. Jenkins, resigned. Mr. Hawkins heretofore has been claims assistant in the office of Vice-President E. J. Pearson.

FRANK TAYLOR HYNDMAN, formerly mechanical superintendent of the New York, New Haven & Hartford, whose appointment as superintendent of motive power and cars of the Wheeling & Lake Erie, with headquarters at Cleveland, Ohio, was announced in the July issue of the *Railway Age Gazette, Mechanical Edition*, was born September 29, 1858, and began railway work in 1872, as machinist apprentice on the Central of New Jersey at Ashley, Pa. From 1874 to 1877 he was an apprentice in the shops of the Lehigh Valley at Wilkesbarre and then, for about three years, was brakeman and fireman on the Central of New Jersey. From March to November, 1880, he was a machinist on the Atchison, Topeka & Santa Fe



F. T. Hyndman

at Raton, New Mexico, and from March, 1881, to August, 1883, was machinist on the Pittsburgh & Western and at the Pittsburgh Locomotive Works, becoming engine man on the Pittsburgh & Western in August, 1883. He remained in that position until September, 1895, when he was made trainmaster, and from April, 1896, to November, 1902, was master mechanic of the same road at Allegheny. He was then, for one month, master mechanic on the Baltimore & Ohio at Pittsburgh, and from December, 1902, to July, 1904, was master mechanic on the Buffalo, Rochester & Pittsburgh. In July, 1904, he was appointed superintendent of motive power of the same road at Dubois, Pa., and the following November went to the New York, New Haven & Hartford as general master mechanic at New Haven, Conn. He became mechanical superintendent of the same road in May, 1906, resigning from that position on July 15, 1907, to enter the railway supply business, and at the time of his recent appointment as superintendent of motive power and cars of the Wheel-

ing & Lake Erie, was the Philadelphia, Pa., representative of S. F. Bowser & Co., Inc., Fort Wayne, Ind.

J. T. LANGLEY, assistant general manager of the Oregon-Washington Railroad & Navigation Company, has been appointed assistant superintendent of motive power with headquarters at Albina shops, Portland, Ore.

G. W. LILLIE has been appointed acting mechanical superintendent of the second district of the Rock Island Lines with headquarters at Topeka, Kan., in place of C. M. Taylor, who has been granted leave of absence on account of ill health.

W. N. MITCHELL, formerly at the head of the railway department of the International Correspondence Schools at Chicago, has been appointed fuel supervisor of the Chicago Great Western, with office at Chicago.

H. J. OSBORNE has been appointed superintendent of motive power of the South Dakota Central, with headquarters at Sioux Falls, S. D.

R. Q. PRENDERGAST has been appointed mechanical superintendent of the Bangor & Aroostook, with headquarters at Milo Junction, Maine, succeeding H. Montgomery, and the position of superintendent of motive power and equipment is abolished. Mr. Prendergast was educated in the high schools and at a business college. After serving his apprenticeship as machinist on the Baltimore & Ohio, at Benwood, W. Va., he was promoted to division foreman at Cameron, and then for a number of years was general foreman at various shops of the same road, including the Mount Clare shops at Baltimore. He then went to the Cumberland Valley as general foreman at Chambersburg, Pa., and three years later was appointed general foreman of the Delaware & Hudson at Carbondale, Pa. He remained in that position for two years, and then for five years was division master mechanic on the Denver & Rio Grande at Pueblo, Colo. He left that road to go to the Cincinnati, Hamilton & Dayton as division master mechanic at Indianapolis, Ind., where he remained for one year, leaving that position to become mechanical superintendent of the Bangor & Aroostook, as above noted.



R. Q. Prendergast

W. H. SCRIBNER has been appointed supervisor of mechanical examinations of the Lake Shore & Michigan Southern, the Dunkirk, Allegheny Valley & Pittsburgh, the Chicago, Indiana & Southern and the Indiana Harbor Belt, with headquarters at Cleveland, Ohio, having direct assignment of duties in the examination of locomotive firemen for promotion, also for instruction of locomotive firemen at times not conflicting with examinations.

MASTER MECHANICS AND ROAD FOREMEN OF ENGINES

A. G. ARMSTRONG has been appointed master mechanic of the Atchison, Topeka & Santa Fe at Needles, Cal., succeeding M. P. Cheney, granted leave of absence.

H. W. CULVER has been appointed road foreman of engines of

the Canadian Northern at Winnipeg, Man., succeeding J. A. Carroll, transferred.

W. C. GROENING has been appointed master mechanic of the Pere Marquette, with office at Wyoming, Mich., succeeding J. E. Hickey, resigned.

C. B. DAILY, assistant superintendent of shops of the Rock Island Lines at Silvis, Ill., has been appointed master mechanic of the Cedar Rapids division with headquarters at Cedar Rapids, Iowa, succeeding F. W. Williams, transferred.

JAMES M. FORD has been appointed assistant road foreman of engines for temporary service on the St. Paul division of the Northern Pacific.

S. F. HANCHETT has been appointed road foreman of equipment of the Rock Island Lines at Trenton, Mo., with jurisdiction over Missouri division territory, Trenton and west, succeeding J. E. MOURNE, transferred.

W. T. LEYDEN, master mechanic of the Minneapolis & St. Louis, with headquarters at Marshalltown, Iowa, has resigned.

F. S. ROBBINS, assistant general foreman at the Pitcairn, Pa., car shops of the Pennsylvania Railroad, has been appointed assistant master mechanic, Pittsburgh division, with headquarters at Pittsburgh, succeeding C. D. Porter, promoted.

HUGO SCHAEFER has been appointed master mechanic of the Atchison, Topeka & Santa Fe at Clovis, New Mexico, succeeding James Kieley, resigned.

H. H. STEPHENS has been appointed master mechanic of the Atchison, Topeka & Santa Fe at Wellington, Kan., succeeding Hugo Schaefer, transferred.

F. W. WILLIAMS, division master mechanic of the Rock Island Lines at Cedar Rapids, Iowa, has been transferred in that capacity to the Minnesota division, with headquarters at Manly, Iowa.

CAR DEPARTMENT

J. DEANE has been appointed general car foreman of the Rock Island Lines at Horton, Kan., succeeding J. J. Acker, promoted.

IRA W. FLEMING has been appointed general car foreman of the Atchison, Topeka & Santa Fe at La Junta, Colo., succeeding William Stapp.

J. H. MILTON has been appointed superintendent of the car department of the Rock Island Lines with headquarters at Chicago, Ill.

J. H. THOMAS, foreman of the Mifflin shop of the Pennsylvania, has been appointed assistant general foreman of the car shop at Pitcairn, Pa., succeeding F. S. Robbins, promoted.

GEORGE THOMSON, division general foreman in the car department of the Lake Shore & Michigan Southern at Englewood, Ill., has been appointed assistant master car builder, Michigan Southern division of that road, also of the Chicago, Indiana & Southern and the Indiana Harbor Belt, with headquarters at Englewood.

SHOP AND ENGINE HOUSE

O. S. BEYER, JR., has been appointed general foreman of the Rock Island Lines at Horton, Kan., succeeding P. Linthicum, promoted.

THOS. BOOTH has been appointed general foreman of the Atchison, Topeka & Santa Fe at Clovis, N. M., succeeding J. R. Cook.

JOHN H. CLARK has been appointed night roundhouse foreman of the Atchison, Topeka & Santa Fe at Dodge City, Kan.

J. W. FLICKWIR has been appointed division foreman of the Atchison, Topeka & Santa Fe at Los Angeles, Cal., succeeding A. G. Armstrong, promoted.

RUFUS H. FLINN has been appointed general foreman for the Louisville division of the Pittsburgh, Cincinnati, Chicago & St. Louis (Pennsylvania Lines), and the Pennsylvania Terminal Railway Company, with headquarters at Louisville, Ky.

T. P. JONES has been appointed general foreman of the Rock Island Lines at Manly, Iowa.

L. H. HAHN has been appointed boiler foreman of the Atchison, Topeka & Santa Fe at Albuquerque, N. M., succeeding D. A. Eddleston.

P. LINTHICUM, general foreman of the Rock Island Lines at Horton, Kan., has been appointed assistant superintendent of shops at Silvis, Ill., succeeding C. B. Daily, promoted.

S. LOGAN has been appointed general foreman of the Grand Trunk at Toronto, Ont., succeeding G. M. Wilson, assigned to other duties.

C. C. RHINEHART has been appointed acting night roundhouse foreman of the Rock Island Lines at Manly, Iowa.

F. E. SHAFFER has been appointed foreman of the locomotive and car department of the Rock Island Lines at Inver Grove, succeeding H. Tatum, resigned.

W. B. TROW has been appointed roundhouse foreman of the Rock Island Lines at Armourdale, Kans., succeeding E. P. Eich, promoted.

PURCHASING AND STOREKEEPING

H. G. COOK has been appointed general storekeeper of the Southern Pacific, with headquarters at San Francisco, Cal., to succeed H. C. Pearce, resigned.

W. L. COOPER, division storekeeper of the Mobile & Ohio at Murphysboro, Ill., has been appointed division storekeeper at Jackson, Tenn., succeeding W. C. Blake, transferred.

A. A. GOODCHILD, auditor of stores and mechanical accounts of the Canadian Pacific at Montreal, Que., has been appointed general storekeeper for lines east of Fort William, Ont., with office at Montreal, succeeding M. J. Power, deceased.

J. F. MARSHALL, purchasing agent of the Wheeling & Lake Erie, has been appointed manager of purchases and supplies of the Chicago & Alton, with headquarters at Chicago, succeeding E. S. Wortham, assigned to other duties.

D. E. MCODIE has been appointed division storekeeper of the Mobile & Ohio at Meridian, Miss., succeeding R. O. Woods, transferred.

H. C. PEARCE, general storekeeper of the Southern Pacific at San Francisco, Cal., has been appointed to the new position of general purchasing agent of the Seaboard Air Line, with headquarters at Norfolk, Va., in charge of both purchases and stores.

SAMUEL PORCHER, assistant purchasing agent of the Pennsylvania Railroad, with office in Philadelphia, Pa., has been appointed purchasing agent, with office in Philadelphia, succeeding Daniel S. Newhall, deceased.

R. O. WOODS, division storekeeper of the Mobile & Ohio at Meridian, Miss., has been transferred in the same capacity to Murphysboro, Ill., succeeding W. L. Cooper.

OBITUARY

G. MCROBERTS, division foreman of the St. Louis & San Francisco at Salem, Mo., died on July 10, aged 56 years.

DANIEL SMITH NEWHALL, purchasing agent of the Pennsylvania Railroad, died on July 13 in a hospital at Philadelphia. He was born on April 7, 1849, at Germantown, Philadelphia. On February 21, 1882, he was elected assistant secretary of the Pennsylvania Railroad, and since June 1, 1898, was purchasing agent of the same road, with office at Philadelphia.

NEW SHOPS

ALABAMA, TENNESSEE & NORTHERN.—A steel and galvanized iron general repair shop 110 ft. x 165 ft., with concrete foundations, is being built at York, Ala. The Decatur Bridge Company has been given a contract for the superstructure, and the foundation work is being carried out by the railway company's forces.

CANADIAN PACIFIC.—A contract has been given to Henry Post, Woodstock, N. B., at \$100,000, it is said, for putting up new concrete and steel shops at McAdam Junction, N. B.

DENVER & RIO GRANDE.—This road has announced that new shops will be erected as soon as possible on the site of the shops destroyed by fire on June 18, at Salt Lake City, Utah. Work has already been started on temporary shops.

GULF, COLORADO & SANTA FE.—Contracts have been let to H. D. McCoy, of Cleburne, Tex., for a 12-stall brick and concrete roundhouse, a machine shop 60 x 80 ft., and a power house 37 x 80 ft. at Brownwood, Tex.

HOUSTON & TEXAS CENTRAL.—This company has purchased a tract of 260 acres near Mexia, Tex., on which will be erected a 12-stall roundhouse, car sheds and shops to handle running repairs. Plans for the improvement are now being prepared by the engineering department.

ILLINOIS CENTRAL.—This company will double the capacity of its shops at Paducah, Ky. Details are not yet available, but new buildings will be erected and new machinery installed.

INTERCOLONIAL RAILWAY.—This road will build extensions, it is said, to the present freight car shops at Moncton, N. B.

LAKE SHORE & MICHIGAN SOUTHERN.—This company will open bids shortly for the car shop which is to be built at Ashtabula, Ohio. The shop will be 200 ft. x 450 ft. and will cost about \$40,000.

NEW YORK, NEW HAVEN & HARTFORD.—This company has just completed at Readville, Mass., an extension to its locomotive repair shop. This addition, which is 200 ft. x 150 ft., is designed as a boiler repair shop and cost \$200,000. It will be opened August 1. The boiler repair work has previously been done chiefly at New Haven, but hereafter all of it will be done at Readville.

WESTERN MARYLAND.—This company has completed the construction of a roundhouse, a power plant, a machine shop and engine terminals at Maryland Junction, near Cumberland. The roundhouse has 20 stalls and is of steel and concrete construction. The contract for furnishing the structural steel for this building was awarded to the McClintic-Marshall Construction Company. The machine shop is equipped for light repairs to engines and cars but particularly to engines. The engine terminals will be of sufficient size to meet the needs of the company at that point. These improvements are a part of the general terminal development at Cumberland.

EARLY TRIAL OF FIRST BALDWIN LOCOMOTIVE.—On a subsequent day, when Dr. Patterson, of the University of Virginia, was in the tender, the mile on a straight line was run through in 58 seconds, according to the estimate of one computer, whilst another observer of time counted 52 seconds. That the distance might have been run in less time was obvious to all, for Mr. Baldwin made the engineer cut off the steam entirely to check a career which he feared might be too great for the strength of the road or the tenacity of the parts of the locomotive. At 58 seconds the speed was more than 62 miles per hour. From this rapid movement no inconvenience was felt by the passengers but a stiff breeze was produced by the quick motion through the air so as to endanger the security of the hats.—From the *American Railroad Journal*, January 19, 1833.

SUPPLY TRADE NOTES

The General Electric Company, Schenectady, N. Y., has opened a branch office at Madison, Wis.

F. J. Lepreau has been made assistant western sales manager for the primary battery department of Thomas A. Edison, Inc., Orange, N. J., for Central Western territory, with office in Chicago.

The U. S. Metal & Manufacturing Company, New York, has recently added to its line of railway specialties the sale of the Lincoln arc welding and cutting machines, made by the Welding Materials Company.

The H. W. Johns-Manville Company, New York, has opened a branch office in the Commercial Bank building, Charlotte, N. C., in charge of E. U. Heslop as manager. P. J. McCusker and Paul W. Whitlock are also located at that office.

HARRISON G. THOMPSON, manager of the railway department of the Edison Storage Battery Company, Orange, N. J., has been made a vice-president of that company. Mr. Thompson

was born in Weston, Mass., in 1875. His railroad experience began with the Pullman Company in 1896. When he had been with that company for two years he was made foreman of electricians. In 1900 he resigned to become foreman of the battery department of the Riker Motor Vehicle Company. Leaving this concern at the time of its absorption by the General Vehicle Company of Hartford, Conn., Mr. Thompson became associated with W. L. Bliss, one of the pioneers in electric car lighting development.

He resigned from the Bliss Company in 1905 and went to the Pennsylvania Railroad, where he was in charge of electric car lighting, with headquarters at Jersey City, N. J. In 1906 he went to the Safety Car Heating & Lighting Company, New York, as electrical superintendent. He was in charge of this company's electrical laboratories during the development of its first electric car lighting system. In December, 1909, he was appointed manager of the railroad department of the Westinghouse Storage Battery Company. He was later with the United States Light & Heating Company, New York, for a short time. On July 1, 1910, he was made manager of the railway department of the Edison Storage Battery Company, which position he held until his appointment as a vice-president, as mentioned above. He is a member of the executive committee of the Telephone and Telegraph Appliance Association, and for three years was vice-president of the Association of Railway Electrical Engineers.

W. E. Jenkinson has been made railroad representative for S. F. Bowser & Company, Inc., Fort Wayne, Ind., covering that territory vacated by E. F. G. Meisinger. In addition, he will take over the Southwestern and Pacific coast territory. He will cover the states from Texas to Oregon.

Ground was broken on July 23, for the new plant of the Baldwin Locomotive Works in East Chicago. The plant is to be built in several units, the first unit to occupy a building 1,400 x 600 ft. of concrete and steel. The H. A. Strauss Company,



H. G. Thompson

of Chicago, has the contract for the construction of the concrete work on the first unit.

W. F. Girten, representative of the railroad department of the Garlock Packing Company in Eastern territory, and formerly general storekeeper of the Central of New Jersey and of the Delaware, Lackawanna & Western, died at the Presbyterian Hospital, Newark, N. J., on July 27, of a complication of intestinal and stomach troubles.

Samuel S. Eveland, owner of the Eveland Engineering & Manufacturing Company, Philadelphia, has sold the entire production of electric riveters of his factory for the first year, approximating in value \$1,500,000, to Manning, Maxwell & Moore, New York. The Eveland company is installing a large amount of new machinery to increase its output, and will manufacture transformers and electric tempering and hardening machines as well as Eveland electric riveters.

The employees of Wells Brothers Company, Wiley & Russell Manufacturing Company and A. J. Smart Manufacturing Company, of Greenfield, Mass., which are the firms forming the Greenfield Tap & Die Company, held their annual joint outing at Island Park, Brattleboro, Vt., Saturday, July 26. A special train of fourteen coaches was provided to accommodate the 726 men and women who attended. The day was occupied in the competition by teams and individuals from the different shops in athletic events.

The Stark Rolling Mill Company, Canton, Ohio, have made an arrangement with The Pedlar People, Ltd., Oshawa, Ont., whereby the latter become general distributors of Toncan metal sheets and products for the Dominion of Canada. The Pedlar People have branches at Montreal, Toronto and Winnipeg, and are equipped to distribute rapidly and efficiently. A. T. Enlow, formerly sales manager of the Stark Rolling Mill Company, is now engaged as manager of sales of The Pedlar People, Ltd., and is also a director.

The Locomotive Arch Brick Company has taken over the patents and business of the Fire Clay Development Company, 1201 Chamber of Commerce building, Chicago. The company has recently been organized with the following officers: President, J. W. Moulding; vice-president, E. P. Stevens; vice-president and general manager, John L. Nicholson; secretary, T. C. Moulding. The Moulding family has been in the fire brick business since 1861, and now owns five large modern plants, for which the Locomotive Arch Brick Company will be the selling agents.

Manning, Maxwell & Moore, Inc., New York, together with their subsidiary companies, will move their general offices on or about October 1, from 85-89 Liberty street to the new Levisohn Building, 113-119 West 40th street. This change is being made to meet the demand for a more convenient and central location, as well as larger space to handle material increases in their various lines. They will occupy the twentieth and twenty-first floors of the building, which will give them 28,000 square feet of space. This space will be exclusively for offices and is almost double that at present occupied for offices on Liberty street.

The annual report of the American Car & Foundry Company, New York, for the fiscal year ended April 30, 1913, shows gross earnings of \$5,539,000, an increase of \$1,346,000 over the preceding year. The net earnings were \$3,328,592, an increase of \$489,360, and after the deduction of \$250,000 for maintenance and improvements the balance available for dividends was \$3,078,592. Dividends of 7 per cent. were paid on the \$30,000,000 of preferred stock, and of 2 per cent. on the \$30,000,000 of common stock, leaving a surplus for the year of \$378,592. Added to the previous surplus this makes a total surplus at the close of the fiscal year of \$25,255,168. At the annual meeting of the stockholders on June 26, the retiring directors were re-elected.

CATALOGS

THE OTTO CYCLE.—An interesting, brief history of the development of the internal combustion engine, with illustrations of the earlier types issued by the Otto Gas Engine Works, Thirty-third and Walnut streets, Philadelphia.

CLING-SURFACE IN RAILROAD SHOPS.—An eight page booklet issued by the Cling-Surface Company, Buffalo, N. Y., illustrates some of the advantages that have resulted from the use of this compound in five different railroad shops.

FORGING BOLT HEADS.—National Header Talk No. 10, issued by the National Machinery Company, Tiffin, Ohio, is devoted to a discussion of the features of design of the National Wedge Grip Header, which allows it to make a perfect bolt head in one blow.

DRILL PRESSES.—Heavy duty drill presses of various sizes are illustrated and very fully described in several leaflets issued by the Colburn Machine Tool Company, Franklin, Pa. The 24-in. and 36-in. swing machines are shown in bulletins Nos. 49, 50 and 51.

DRILLS AND REAMERS.—A new catalog from the Celfor Tool Company, Buchanan, Mich., gives illustrations, a brief description and table of the complete range of sizes, with the price of the types of drills, reamers, flue cutters, countersinks, chucks, tool holders, milling cutters, and boring tools manufactured by it.

STREET LOCOMOTIVE STOKERS.—Illustrations, together with a list of the general dimensions, of a number of the largest locomotives in service in this country, which are now being fired by the Street locomotive stoker, form the principal part of a booklet being issued by the Locomotive Stoker Company, 30 Church street, New York.

FUEL OIL DATA.—Circular No. 142, prepared by Tate, Jones & Company, Inc., Pittsburgh, Pa., is devoted to the discussion of fuel oil and presents much interesting data in connection with the use of this fuel in both boilers and furnaces. Many tables giving the results of actual tests with both oil and coal of various grades are included.

DIRECT CURRENT MOTORS.—The General Electric Company, Schenectady, N. Y., has issued bulletin No. A-4121, describing direct current motors, type CVC, which is a revision of previous bulletins on direct current motors of the commutating pole design. The bulletin is thoroughly illustrated and contains information on the proper method of handling.

STARETT TOOLS.—Catalog No. 20, issued by the L. S. Starett Company, Athol, Mass., contains 320 pages of interesting descriptions, illustrations and prices of all kinds of tools for machinists, carpenters, draftsmen, engineers, and other mechanics. In addition there are many convenient tables, such as metric conversion tables, decimal equivalents, wire gage tables, etc.

MORE CHIPS.—An illustrated pamphlet is being issued by The Electric Controller & Manufacturing Company, Cleveland, Ohio, which consists very largely of an article by H. F. Stratton, entitled "The Automatic Control of Machine Tools," which appeared in the May 29, 1913, issue of the *American Machinist*. This article is an interesting discussion of the advantages that have actually been obtained by the use of the automatic control on motor driven machine tools.

BOLT CUTTERS.—The National Machinery Company, Tiffin, Ohio, had on exhibition at the mechanical conventions at Atlantic City several designs of bolt cutters, some of which were in operation. Unusually satisfactory results were obtained under the most adverse conditions of shape and size of the stock used, and this company is now issuing a catalog descriptive of the work performed at that time. The machine itself is also fully illustrated and described.

MOST POWERFUL LOCOMOTIVE.—Bulletin No. 1014 from the American Locomotive Company, New York, is devoted to an illustrated description of the Mallet type locomotives built by that company for the Virginian Railway, which are the heaviest and most powerful ever built. The bulletin discusses the design in general, and also gives a very complete description of the more interesting details. Comparative tests made between these and some Mikado locomotives on fuel and water consumption are briefly referred to and the general results are presented.

FILE PHILOSOPHY.—The eighth revised edition of the interesting booklet prepared by the Nicholson File Company, Providence, R. I., and entitled "File Philosophy," is now being issued. It contains 45 pages and is fully illustrated. To a certain degree it is a text book on files and contains much valuable information in connection with the proper methods of using the various styles. A section is devoted to the definition of the various terms used in connection with files and instructions are given as to the best practice in cleaning and taking care of these tools.

ELECTRIC RIVETER.—Standard and portable electric riveting machines of various sizes are fully illustrated and described in a catalog issued by the Eveland Engineering & Manufacturing Company, Philadelphia, Pa. These riveters are suitable for any size or length of rivet of iron, steel, brass, copper, or other metal, and are claimed to be absolutely safe to use, there being no possibility of an electric arc forming, nor of any danger from shock from the electric current used. It is stated that the two contact points may be held in the hand without producing any sensation whatever.

THE KEYSTONE DRIVING BOX.—Comprehensive illustrations are depended on very largely for the information presented in a pamphlet being issued by the Keystone Lubricating Company, Twenty-first, Clearfield and Lippincott streets, Philadelphia, Pa. This box is designed to permit the brass to be readily removed when the box is in its place in the pedestal and the weight has been removed from the top of the journal. Also to permit the lateral being taken up without dropping wheels and to allow taking up the shoe and wedge wear without lining down the wedges. The illustration in each case shows exactly how these desired results have been accomplished.

MARKET DEVICES.—Several of the devices designed by Charles Markel, shop foreman of the Chicago & North Western, at Clinton, Iowa, including a removable driving-box brass, flangeless shoes and wedges, lateral motion plates, and a solid end main rod, all of which designs have been illustrated in these columns, are now being furnished by the Equipment Improvement Company, 30 Church street, New York. This company has issued a catalog which contains illustrations and descriptions of these various parts, and also substantiates its claims for saving in maintenance expense by actual figures that have been obtained from the service on the Chicago & North Western.

LOCOMOTIVES.—Three new records of construction have recently been issued by the Baldwin Locomotive Works. Record 73 contains a reprint of a paper presented by George R. Henderson, consulting engineer of the Baldwin Locomotive Works before the Franklin Institute, Philadelphia. This paper is entitled "The Recent Development of the Locomotive," and discusses the subject at considerable length. It is thoroughly illustrated, giving many interesting details of some of the larger modern locomotives. Record No. 74 discusses gasolene locomotives, which are manufactured in sizes suitable for industrial purposes. Different examples are illustrated and the book contains a discussion and illustrations of the various important details of the machine. Record No. 75 is devoted to illustrations, a brief description and a complete list of specifications of Mikado locomotives that have recently been built by this com-

pany. These are shown in practically all sizes, and include some of the most powerful simple locomotives now being used in freight service in this country.

COMPRESSED AIR MACHINERY.—"Ingersoll-Rand Products," is the title of a 140-page catalog now being issued by the Ingersoll Rand Company, 11 Broadway, New York. This book fully illustrates the entire line of this company's productions, and includes in each case, dimensions and capacity tables which are of decided assistance in selecting machines to meet certain specified requirements. Compressed air in a wide range of adaptability is covered by the machines shown in this book. Practically twenty pages are devoted exclusively to tables of horse power required to compress air from atmospheric pressure to various gage pressures, as well as efficiency tables of air compression at different altitudes, drill capacity tables and indicator charts.

BORING AND TURNING MILLS.—Colburn new model boring and turning mills are very thoroughly illustrated and described in an attractive catalog being issued by the Colburn Machine Tool Company, Franklin, Pa. These machines are built to withstand the heaviest cuts with high speed steel and are claimed to embody every known improvement for the rapid production of work. The catalog gives a thorough description of the mechanical construction of the mills, and includes clear and concise instructions pertaining to their operation. An extensive use of illustrations is found throughout the catalog, each showing some important detail of the machine. The machines are shown in five sizes, from 42 in. to 72 in., and are fitted with two regular swivel heads. Arrangement is also made for applying a turret head on one side, if desired. A thread cutting attachment which can be applied to any of these machines is illustrated and its method of application and use is described.

GLYCO METAL.—Glyco is a scientifically made bearing metal that has been manufactured in Europe for nearly fifteen years and is used there in large quantities. The American rights for its manufacture and sale have recently been secured by Joseph T. Ryerson & Son, Chicago, who are issuing a 70-page pamphlet, descriptive of its qualities and uses. This booklet is No. 13 in the Technical Library Series, being prepared by this company, and discusses the subject from a strictly technical standpoint. Tests that have been made indicate that it is the cheapest substitute for a high-priced alloy, and also that it possesses important technical advantages over other lead base alloys. The last twenty pages of the booklet are devoted to useful information, being a reprint of the conclusions of accepted authorities on the various subjects selected. These include lubrication, the laws of friction, physical characteristics of lubricants, crank pin calculations, length of shaft bearings, specific gravity of alloys, the horse power per pound of mean effective pressure, and various other similar tables and data.

FLEXIBLE COUPLINGS FOR SHAFTS.—A shaft coupling which will permit misalignment of a line of shafting, to a reasonable degree, without causing damage to the bearings or machinery is fully illustrated and described in catalog from The Francke Company, New Brunswick, N. J. The Smith-Serrell Company, Inc., 90 West street, New York, are general sales agents for this company. In general appearance this coupling is very similar to an ordinary flange coupling and the flexibility is obtained by using flexible instead of rigid bolts to connect the flanges. These flexible pins are made of tempered steel leaves held at each end by a keeper. The keepers are slotted at the outer end and a spring ring fitting in a groove in the flanges holds them in place and keeps the leaves in a radial position for driving. The holes in the ends of the tempered leaves where they are joined to the keepers are slotted to allow a considerable movement longitudinally, and the coupling will permit the shafts to run when the center lines are at an angle, or, when the center lines are in the same plane, but not in alignment.

Railway Age Gazette

MECHANICAL EDITION
INCLUDING THE
AMERICAN ENGINEER

PUBLISHED ON THE FIRST THURSDAY OF EVERY MONTH BY THE
SIMMONS-BOARDMAN PUBLISHING COMPANY,
WOOLWORTH BLDG., NEW YORK, N. Y.

CHICAGO: Transportation Bldg. CLEVELAND: Citizen's Bldg.
LONDON: Queen Anne's Chambers, Westminster.

EDWARD A. SIMMONS, *President*. L. B. SHERMAN, *Vice-President*.
HENRY LEE, *Secretary*.

The address of the company is the address of the officers.

ROY V. WRIGHT, *Editor*. R. E. THAYER, *Associate Editor*.
E. A. AVERILL, *Managing Editor*. A. C. LOUDON, *Associate Editor*.
GEORGE L. FOWLER, *Associate Editor*.

Subscriptions, including the eight daily editions of the *Railway Age Gazette* published in June in connection with the annual conventions of the Master Car Builders' and American Railway Master Mechanics' associations, payable in advance and postage free:

United States, Canada and Mexico..... \$2.00 a year
Foreign Countries (excepting daily editions)..... 3.00 a year
Single Copy 10 cents

Entered at the Post Office at New York, N. Y., as mail matter of the second class.

WE GUARANTEE, that of this issue 4,300 copies were printed; that of those 4,300 copies, 3,800 were mailed to regular paid subscribers and 125 were provided for counter and news companies' sales; that the total copies printed this year to date were 41,976—an average of 4,664 copies a month.

VOLUME 87. SEPTEMBER, 1913. NUMBER 9.

CONTENTS

EDITORIALS:

Grinding Competition.....	463
Fuel Saving and Capacity.....	463
Rules of Interchange.....	463
Master Blacksmiths' Convention.....	464
Traveling Engineers' Association.....	464
New Books.....	465

COMMUNICATIONS:

Truck Wheel Tire Turning Test.....	466
------------------------------------	-----

GENERAL:

Traveling Engineers' Convention.....	467
Railroad Smoke Inspectors' Association of Chicago.....	478
Correction.....	478
Inspection Locomotive on the Reading.....	479
Air Sander for Interurban Cars.....	482

SHOP PRACTICE:

Paint Shop at Sedalia.....	483
Turning Eccentric Strap Liners in a Boring Mill.....	484
Hammer for Removing Side Rod Bushings.....	484
Master Blacksmiths' Association.....	485
Molding Driving Box Plugs.....	494
Boiler Shop Scaffold.....	494

CAR DEPARTMENT:

Car Inspectors' and Car Foremen's Association.....	495
Defective Applications of Brake Apparatus.....	496
Study of Car Wheel Flanges and Treads.....	497
Seventy-Ton Hopper Car.....	503
New End Construction for Pullman Cars.....	504
Freight Car Designing.....	505

NEW DEVICES:

Improved Flow Meter.....	507
Osman Boiler Check.....	508
United States Air Brake.....	508
Rumsey Mail Car Door.....	509
Poyer Pneumatic Saw.....	509
Improved Coal Sprinkler.....	510
Pressed Steel Carline.....	511
High Duty Radial Drill.....	511
Fractured Crank Pin Detector.....	512
Smoke Burning Device.....	513
Tank Well and Valve.....	513

NEWS DEPARTMENT:

Notes.....	514
Meetings and Conventions.....	514
Personals.....	515
New Shops.....	517
Supply Trade Notes.....	517
Catalogs.....	518

Grinding Competition

Most railroad shops now grind piston rods, many of them grind guides, some are grinding axles, and a few grind car wheels. Portable grinders have been found useful in many directions. These operations are fairly well known, but is this as far as you have gone in taking advantage of the possibilities of grinding for rapid and accurate work? With a good grinding equipment, chilled cast iron and case hardened or tempered steel are made available for finished parts. Are you taking any advantage of this opportunity? As a rule the coarser the turning of a part, the greater is the economy of finishing it by grinding. Have you found it wise to change your method of finishing any parts in this way? We would like to know about the latest development in the use of grinding in railroad shops, either in the shape of new ways of performing certain operations; changes in the material or design that have been made possible by the availability of the grinding machine; examples of work that is now being finished by grinding which previously was finished by cutting tools or by hand; original arrangements for safeguarding the operator of grinding machines; or, in fact, anything new in connection with this subject. A prize of \$35 will be given for the best article that is submitted to us before October 1, and such other articles as do not win a prize, but are accepted for publication, will be paid for at our regular rates.

Fuel Saving and Capacity

In a paper on the superheater locomotive at the General Foremen's convention, the statement was made that it is claimed the superheater will effect a saving of 25 per cent. in coal, 35 per cent. in water, and increase the horse power or hauling capacity about 33 per cent. One member asked for an explanation of how a 25 per cent. saving could result in an increase of 33 per cent. in capacity, and in view of the fact that a satisfactory explanation was not given on the floor of the convention, and for the benefit of the few who do not already understand it, a simple explanation will be given: Assume that on a saturated steam locomotive 4 lbs. of coal an hour is required for each horse power delivered from the cylinders. Thus, if 4,000 lbs. of coal per hour are burned, it will result in the locomotive delivering 1,000 horse power. Assume that a superheater is applied to this locomotive and that it saves 25 per cent. of the fuel. Under these conditions the 1,000 horse power will then be obtained from burning 3,000 lbs. of coal, or 3 lbs. of coal an hour will give a horse power. Inasmuch, however, as it is perfectly possible to burn 4,000 lbs. of coal per hour, assume that this original firing rate is continued on the superheater locomotive. In this case with 3 lbs. of coal for each horse power and 4,000 lbs. of coal being fired, or the same amount fired to deliver 1,000 horse power on the saturated steam locomotive, the power output will be 4,000 divided by 3, or 1,333 1/3 horse power. This is an increase of 33 1/3 horse power with the same amount of coal fired, or, an increase of 33 1/3 per cent. in capacity on the same fuel consumption due to the use of superheated steam.

Rules of Interchange

The joint annual meetings of chief interchange car inspectors and car foremen of the railways in the country for discussing Master Car Builders' Association's rules of interchange with a view of obtaining more uniform interpretation of these rules, is not only of great benefit to the men themselves, but to the railways at large. With a large collection of rules, like these, there are bound to be misunderstandings, not because the rules themselves are at fault, but because of the different view points of the men, which, when aired in a meeting of this kind, may be corrected. While all should be thoroughly familiar with these rules there are many that do not give the in-

tended interpretation to them, and in these meetings many questions are cleared up. Another advantage of this association, and perhaps the most important, is the discussing of the working out of the rules in practice. These men are much more able to advise as to the needed changes in the rules when acting as a body of co-workers than when offering individual suggestions to the parent organization. That their recommendations are of value is evidenced by the number that have been appointed by the M. C. B. Association. It is important when considering any changes that the opinion of all the members be considered so that a recommendation that will accomplish the greatest good may be made. Although the members of this association are in a position to offer many valuable suggestions, they should remember there are sometimes conditions, with which they are unfamiliar, that make it impossible for some of their recommendations to be accepted, but this should not be allowed to discourage, in the least, their efforts and the continuation of their endeavor to improve matters as they see them. Apparently it has not and will not.

Master Blacksmiths' Convention

In the discussion of flue welding at the Master Blacksmiths' Association convention, it was brought out very clearly that the increasing use of superheaters in locomotives has required the introduction of special tools and methods in more than one branch of repair work. In one instance where modern locomotives are repaired in a comparatively old shop it has been found impossible to remove superheater flues from the boilers because of lack of space, unless the doors of the erecting shop are opened, which, in a northern latitude, is out of the question in winter. This has been overcome by constructing a special type of cars which close the door openings and also provide a platform for the workmen. It is quite probable that there are other shops similarly situated, where either a new building or an extension of the old one is being considered and an arrangement of this kind could be applied with a resultant saving.

In the discussion on tools and formers there was a wide variation of opinion. Some of the members seemed to think that it pays to make a tool for any job, no matter how small, while others placed limits, varying from 12 to 100, on the number of pieces to be made for which it pays to provide a special tool. This is a question for which a definite answer cannot be given; in large shops where hundreds or thousands of one piece are frequently required, no one can deny that a large saving can be effected by making special formers, but there are many small shops in which it would be a waste of money to employ such methods.

In the paper on electric welding it was brought out that at the New York Central shops at Depew, N. Y., this process has been successfully used to fill in flat spots on locomotive driving wheel tires, some of the spots being $4\frac{1}{2}$ in. long. With the soft metal which is used it scarcely seems probable that this practice could be of any very lasting benefit as, even if the wheels were not slid again on the same spots, it is probable that the ordinary wear and tear of service would soon affect the soft metal, causing a return of the flat places.

One of the most interesting reports was that on spring making. With the weight of locomotives and cars what it is today, the very best methods and materials should be used in spring manufacture, yet there are hundreds of shops where the methods used in making springs that had less than one-fourth the weight to bear are still employed on the large modern springs. The use of machinery and the heat treating of the steel should result in great improvements. An example given in the report was the making of 18,000 leaves by this process without one of them failing under test. Stress was laid on the use of the recording pyrometer. To the smith of the older days, accus-

tomed to judge temperatures, this may seem unnecessary, but there is no doubt that the pyrometer will assist greatly in obtaining uniformity of tempering.

Traveling Engineers' Association

In past years the Traveling Engineers' Association has made itself a reputation for getting the maximum of real value from its annual meeting. This year's convention fully maintained the previous standard. For size of attendance at, and interest in, the meetings, the evident desire of the members to receive and impart the greatest amount of information, close adherence to the subject under discussion, frankness of expression, selection of most important and most suitable subjects for discussion and dignified parliamentary control of the meetings, there is no association in the mechanical field which exceeds the Traveling Engineers' and, considering all of these features together, there is none that equals it. All the other associations can learn something by studying the work of the Traveling Engineers.

Not the least important feature of the success of these meetings is the wisdom of selecting a few really important subjects which are strictly within the limits of the Traveling Engineers' province and giving plenty of time for a full discussion. This year there were five subjects for four full days' sessions. The meetings were in session for a total of about 21 hours, and if six hours are excluded for the amount taken by addresses and routine business, it leaves an average of three hours for presentation and discussion of each report.

* * * * *

Warning has been given several times in these columns as to the advisability of giving closer attention to the water level of the superheater locomotive boiler, that it is not carried too high. In speaking on this subject, one of the members at the Traveling Engineers' convention stated that on the large number of superheater locomotives he had been on, over 60 per cent. were carrying water over into the superheater due to the level being maintained too high. While probably this percentage is excessive in most cases, still, as was shown by the report of the Committee and the comment of the other speakers, in far too many cases is the water level too high on superheater locomotives. The whole trouble is probably due to a lack of thorough understanding by the engineer of the effect of carrying water over into the superheater units. It is hard to believe that any engineer would handicap his locomotive to this extent if he realized what was going on. Unless a pyrometer is fitted, which will show the temperature of the steam in the superheater, it is very difficult for an engineer to know if water is being carried over and his only safeguard is to carry a level low enough to be sure that a minimum is being carried through the throttle. It is even doubtful if all traveling engineers fully understand the bad effects of this practice and it is probable that, as a result of this convention, there will be far less reason to complain on this score in the future than in the past. A number of locomotives have been equipped with pyrometers which have proven to be of great assistance to the engineer in the operation of his locomotive in obtaining the best return from the superheater. Where pyrometers are used, if any water is carried over it immediately shows in a sharp dropping in the temperature and the trouble can be corrected immediately. Furthermore the best relation of throttle opening and cutoff to obtain the highest degree of superheat can be quickly discovered. In connection with the latter feature, the members were advised by a superheater expert to use a full throttle up to the point where the cutoff reached 25 per cent. of the stroke. When, however, it became necessary to shorten the cutoff beyond this it was more advisable to close down the throttle than to use a cutoff less than 25 per cent.

Among the other features of superheater locomotives that received considerable discussion were the matter of insuring the

cleanliness of the superheater unit and the lubrication of the locomotive. With some grades of fuel it is only by using the utmost care that the superheater flues and the units can be kept clean. Blowing them out with a high steam or air pressure in a 3/8-in. pipe of sufficient length to reach through the tube is successful in most cases, if the operation is performed frequently enough, but in others there is a collection of scale and cinders which cannot be blown out and even after the passage of this pipe, inspection will show a solid mass around and between the superheater pipes in the unit. In some cases the collection of cinders is so bad that the small pipe cannot be forced through and in one extreme case, it is mentioned that the turntable had to be used to pull a superheater unit out of its tube. It was clearly understood by everyone, however, that no matter how difficult it may be, it is absolutely necessary that these units be kept clean, otherwise the capacity of the boiler will be greatly reduced and an engine failure invited. Blowing them out with air or steam pressure, as recommended, supplemented by careful inspection and the use of bars or hooks to dislodge the clinkers will do it successfully and no traveling engineer or roundhouse foreman should allow a locomotive to leave the terminal until he is sure that this has been done.

Lubrication of the cylinders and valves did not seem to be causing as much trouble as it did on the first introduction of the superheater. A good grade of valve oil will properly lubricate these parts if it is used effectively but positive assurance must be had that the lubricant is being distributed uniformly and constantly. Oil pipes direct to the cylinders do not seem to be necessary in all cases, although their presence and use is advised when the locomotive is drifting for any considerable distance. Flaked graphite fed to the valves and cylinders in small quantities has been successful on both superheater and saturated locomotives but the experience of several of the members indicated that care must be taken not to overdo the matter and feed too much graphite, as in that case the packing rings would stick solid and difficulty with blows would be incurred.

* * * * *

The efficiency with which the operating department performs its duties has a very direct and marked effect on the coal consumption of locomotives is well known to all mechanical men, but it is doubtful if the same features are thoroughly appreciated by the minor officials in that department. The report of the committee on this subject at the Traveling Engineers' convention listed the more important of these activities where the results of the work of the operating department had an effect on the coal pile. Coal wasted by locomotives standing at terminals waiting for trains was believed to be one of the greatest sources of waste. Several experiments were mentioned by the members where the locomotives were run over two divisions continuously, only stopping at the intermediate terminals long enough to renew the supply of coal and water and to clean the ash pan. There is no doubt but this practice will result in a very distinct saving of fuel and it is being used on quite an extensive scale already by some of the more progressive roads. Coal wasted by overloading the locomotive and thus requiring a very long time on the road is another feature under the control of the operating department in which there can be considerable improvement on some roads. Many other conditions were mentioned in the report and by the members discussing it, but so far as appeared there had been very little conscientious effort to educate the minor operating officials in their responsibilities and opportunities in connection with the fuel account. Advice was extended to the members that whenever an opportunity for the operating department to save fuel comes under their observation, they should take the matter up with the proper official and present actual figures to show the advantage of a different policy.

* * * * *

Splendid results are following the efforts being made to reduce black smoke, particularly within city limits. In the opinion of

most of the members light and level firing, sufficient air openings in the ash pan and the use of the brick arch, especially when these are assisted by steam jets through the side water leg and in the back head, will make possible practically smokeless firing. The greatest offenders in the smoke nuisance have always been the switch engines which, due to the intermittent operation and frequent use of full stroke have made it very difficult to maintain a smokeless condition in the firebox. The application of the brick arch and superheater, however, appears to have changed all of this and it is now possible to have a most successful switching locomotive which can operate at full power and practically without smoke. It is, of course, not to be inferred that the superheater has any effect on the smoke *per se*, but the fact that it saves about 50 per cent. of the fuel, permits much lighter fires to be carried and allows the fireman to exercise more care in its distribution. Avoiding smoke at roundhouses is, of course, a much more difficult proposition, but the majority of the members seem to believe that even here, with proper facilities and proper care it could be very greatly reduced. The Lake Shore & Michigan Southern seems to be having some success with the use of smoke washers at roundhouses. In these cases the smoke is all discharged into a duct around the house in which a suction fan makes circulation and discharges the smoke in vats of water which remove all of its objectionable properties. The reduction of black smoke in the neighborhood of cities is a very important matter and the sentiment expressed at this meeting was most encouraging and if the actual achievement meets the expectations, the greatest cause of public demands for expensive electrification in cities will be eliminated.

* * * * *

Mr. Parish in his paper on the brick arch stated quite truly that the value of the arch tube as a means of better water circulation has not received the attention it deserves. He states that four 3-in. arch tubes, when the boiler is working up to its capacity, will circulate fully 30,000 gals. of water an hour when the discharge end of the tube is designed to discharge at the surface of the water. This is practically nine times the total amount of water in the boiler of a large consolidation locomotive and in view of the fact that these tubes are at the hottest point of the firebox and have the greatest temperature difference between the inside and outside of the tube, and are thus capable of transmitting the larger proportion of heat, their value as heating surface is much greater than any other part of the boiler. In this connection Mr. Gaines mentioned in his discussion that he had found the thin arch tubes much better than the thicker ones and is now using tubes .15 in. in thickness. In connection with this rapid circulation feature Mr. Parish gives warning about using a tube smaller than 3 in., stating that as the diameter of the tube bears a direct relation to the amount of water circulated, if the tube is reduced to any considerable extent it is probable that there will be no circulation except that required to replace the water evaporated in steam in the tube. Or, in other words, the tube would flash the water into steam of high temperature and practically no water would be carried out with the steam.

NEW BOOKS

Engineer's Handbook on Patents. By William Macomber, Professor of Patent Law, Cornell University Law School. Illustrated. Bound in flexible leather. 270 pages, 4 1/2 in. x 6 3/4 in. Published by Little, Brown & Co., 34 Beacon street, Boston. Price, \$2.50.

This book is a distinct departure from the orthodox order of works on patent law and is, as its title indicates, a handbook in which there are presented the theories which underlie successful invention and tend to guide the inventor along successful lines, both as to law and theory of patents. The information given will tend to enable the inventor to avoid lines of thought which have resulted in past failure, and will inform him

on the steps necessary to secure for himself the full benefit of a successful invention. The section on what is patentable is exceptionally detailed and complete. Special attention has been given to indexing and paragraphing with a view of making the contents accessible with the utmost directness.

Holmes Hinkley, an Industrial Pioneer. Edited by Walter S. Hinckman. Bound in cloth. 42 pages. 5½ in. x 8 in. Illustrated. Published by the Riverside Press, Cambridge, Mass. Price \$1.00.

Holmes Hinkley built the first locomotive from original design in New England. This locomotive was called the Cumberland, and was built for the Portland, Saco & Portsmouth Railway, in the year 1840. About a year before he died in 1866, Mr. Hinkley wrote a brief autobiography which has been made the basis of this book. Letters from those who either knew him or his work and various data of interest have also been included, together with several illustrations of his early locomotives. The edition has been strictly limited, and but few copies are for sale.

Laying Out for Boilermakers. Second edition. Bound in cloth, 302 pages, 10 in. x 13 in. 600 illustrations. Published by the Aldrich Publishing Company, 17 Battery Place, New York. Price \$5.00.

The first edition of this work, which was published about three years ago, clearly indicated the demand for a thoroughly practical instruction book on the laying out of work of all kinds. The second edition, now being published, contains over twice as much reading matter as did the first, and all parts have been revised and enlarged. The book is thoroughly practical in every particular and is fully illustrated. It explains how to lay out various different types of boilers and all of their parts. Proper procedure in making repairs, particularly to locomotive boilers is fully covered and chapters are given on the construction of steel stacks and on various miscellaneous problems, such as laying out Y-breeching, elbows and various other unusual and odd forms. A new chapter in this edition is one given under the title of Miscellaneous Calculations, which shows how to determine the efficiency of riveted joints, the area of circular segments, how to estimate the cost of different types of boilers, etc. The last chapter is devoted to tools for boilermakers and how to use them. Both machine and hand tools are described and illustrated in this chapter. This book will be found useful by all boilermakers and would be of particular value to a boilermaker apprentice.

Engineering as a Profession. By A. P. M. Fleming and R. W. Bailey. Bound in cloth. 278 pages. 5 in. x 7½ in. Published by John Long, Ltd., Norris Street, Haymarket, London. Price 75c.

The authors of this work have had considerable experience supervising the technical and practical training of young engineers, and the opinion has been forced on them that the large number of failures in this field are due to a lack of knowledge as to what constitutes a suitable course of training and ignorance of the conditions governing engineering employment. To supply this deficiency they have written this book, which aims at giving a broad general outline of the field of engineering activities for the benefit of those who have only a popular conception of engineering matters and a comparison is drawn between engineering and other well recognized professions. The book is written entirely from an English standpoint and the methods for obtaining training in that country are fully discussed. Full information is given in regard to various scholarships and other facilities for obtaining engineering education and training at the minimum of expense. A brief outline is given of the apprenticeship courses in the various prominent works in Great Britain, and considerable information is included for the benefit of young engineers going to England from other countries for education and training. This book is an excellent commentary on English engineering education, facilities and practices.

COMMUNICATIONS

TRUCK WHEEL TIRE TURNING TEST

CHICAGO, Ill., July 23, 1913.

To the Editor:

The accompanying table gives the result of a truck wheel tire turning test performed at the Chicago shops of the Chicago & North Western, June 20, 1913. The work was started at 7 a. m., and performed by a regular lathe operator and his regular helper. No extra help of any kind was used, and all the wheels turned were so worn that their removal from service was required. Twenty-four pairs of wheels were turned in 6 hrs. 22 min., with an average time from floor to floor of one pair of wheels in 15 min. 55 sec. The fastest time from floor to floor was 12 min. 40 sec. A 42-in. Niles-Bement-Pond lathe operated by a 55 h. p. d. c. General Electric motor was used. The total weight of chips was 13.92 lbs.

Number of pair.	Diameter of Rough Wheel.	Diameter of Finished Wheel.	Time to Machine. (Min. and Sec.)	Time of Turning. (Min.)	Machine to Floor.	Total Time. Floor to Floor.	Speed. (ft. per Min.)	Fuel (lb. per Min.)	Condition of Tire.	Depth of Cut. Outside Tread of Wheel.
1	29½	29½	1.20	16.30	1.15	19.5	13	3.8
2	28½	27¾	1.30	10.15	1.10	13.25	15	3.8
3	28½	28¼	1.30	10	1.10	13.10	15.5	3.8	Hard spot
4	31	30¾	1.30	10.30	1.20	13.50	15	3.8
5	28½	28½	1.30	10	1.10	13.10	15	3.8	Hard spot
6	28½	28½	1.30	11	1.10	14.10	15	3.8
7	30½	29½	1.30	13	1	16	15.5	3.8
8	30¾	30	1.40	11.10	1	14.20	15	3.8
9	29½	29½	1.30	10.30	1	13.30	15	3.8
10	29½	29½	1.30	11	1.10	14.10	15	3.8
11	31¼	30½	1.50	10	1	12.50	15.5	3.8
12	27¾	27¾	1.30	10.30	1	13.30	15	3.8
13	30	29¾	1.30	12	1	15	15	3.8	Hard spot
14	31	30¾	1.30	30	1.10	33.10	15	3.8
15	28½	28½	1.30	17	1	20	15.5	3.8	Hard tires
16	31½	31½	1.40	10	1	12.40	15.5	3.8
17	30½	30	1.30	11	1	14	15	3.8
18	30¾	29½	1.30	13	1	16	15	3.8
19	30½	30	1.30	11	1.10	14.10	15	3.8
20	30¾	30¾	1.40	18	1.20	21	13	3.8	Hard spot
21	30	29¾	1.30	11	1.20	14.20	15	3.8
22	30	30¾	1.30	12	1.10	15.10	15	3.8
23	30¾	30¾	1.30	10	1.10	13.10	15	3.8
24	30¾	30¾	1.30	19	1.10	22.10	14	3.8	Hard spot

E. H. MOREY,
Demonstrator.

NEW LOCOMOTIVE ENGINE.—We were much gratified a day or two since by a visit to the machine shop of William B. James, No. 40 Eldridge street, where we saw in operation on a short temporary railway in his yard, a locomotive engine constructed upon an entirely different plan from any that we have before seen. No part of the engine except the boiler and smoke pipe is over 39 in. above the surface of the rails and it is so constructed that no fire falls from the furnace nor is a spark even seen to rise from the smoke pipe. The cylinders are on the outside and below the top of the wheels. It is to carry its own fuel and water, and the fire is driven by a bellows worked by the machinery, and therefore is always in proportion to the velocity. It is estimated to weigh, with the supply of water and fuel on board, 3½ tons, and to run from thirty to forty miles an hour. Its power is equal to 16 horses. To give some idea of the ease with which it is controlled when under way, we saw it run a distance of about 50 ft. forward and backwards eight times in 63 seconds, including stops. Mr. James placed it upon wheels without flanges a few days since and ran it over the pavements on Third avenue to Yorkville, about five miles, took breakfast and then returned to the city. The performance, he said, was altogether satisfactory. He has it in contemplation to take it to Baltimore in a few days to give it a fair trial. It will be found, we predict, an ingenious and valuable addition to those already in successful operation on their railroads. We wish Mr. James success, for his plan is called the American.—From the American Railroad Journal, October 20, 1832.

TRAVELING ENGINEERS' CONVENTION

Large Attendance and Active Discussion Made the Twenty-First Annual Convention Very Successful.

The twenty-first annual convention of the Traveling Engineers' Association was opened at the Hotel Sherman in Chicago, on August 12, by President W. H. Corbett, master mechanic, Michigan Central, Michigan City, Ind. After the opening prayer by Rev. Samuel Fallows, D.D., the convention was welcomed to the city by the assistant city attorney.

W. A. Garrett, vice-president, Chicago Great Western, delivered the opening address. Mr. Garrett complimented the members on the success that has followed their efforts in training the engine crews and pointed out the great value of team work among the employees of a railroad. All are working toward a common end and the co-ordination of their efforts cannot help but improve the results. Increasing government regulation of railroads makes necessary even greater and more conscientious efforts on the part of all employees if the properties are to be in any sense successful.

Attention was drawn to the very large number of people killed or injured by the railroads, it being pointed out that on an average there are 14 people killed each day. A very large part of these are trespassers, and it becomes the duty of railway employees of all classes to prevent trespassing as far as they are able. Efforts in this direction will probably reduce the total number killed more than any other way. Statistics compiled by the Interstate Commerce Commission as to the causes of the principal train accidents which occurred for the past 10 years were quoted by Mr. Garrett. Out of a total of 535, excessive speed was responsible for 137 accidents, 95 are charged to carelessness, while 69 were due to misread orders. Other causes of accidents quoted were: 66 due to running past signals; 63 to disobedience of rules; 49 to forgetfulness; 40 to someone falling asleep, and 16 to failures to follow the schedule. It was pointed out that the traveling engineer has it within his power to greatly reduce a number of these accidents, and in fact it has devolved very largely on him to do so.

Mr. Garrett stated that the obligations of the employer toward the employee do not end with the pay envelope. The success of the employer depends on the well-being and high standing of his employees. And again, the success of the employee depends on the success of the employer and the success of a railroad depends on the prosperity of all.

ADDRESS OF THE PRESIDENT.

President Corbett confined his remarks very largely to pointing out the possibilities of the Traveling Engineer and the necessity for him being thoroughly conversant with all the new devices that are placed on a locomotive. It is only through the traveling engineer that the engine crew can be properly instructed and trained, and to a large extent it devolves on him to see that the proper returns are obtained from the investment in improved designs and economy devices that are placed on locomotives. It is vitally necessary at the present time to obtain full results from every device that will lead toward economy of locomotive operation and the railroad companies look to the road foreman of engines for this accomplishment.

OPERATING SUPERHEATER LOCOMOTIVES

Following is an abstract of a committee report entitled, "Uniform Instructions to Enginemen on Handling of Superheater Locomotives."

Superheaters of various design, capable of developing a moderate degree of superheat, have been experimented with, but the results obtained have not been of sufficient value to warrant their adoption, and they have gradually given way to the fire-

tube type, which has been adopted as the most efficient and economical means of superheating. It is therefore proposed to consider only this type.

The principal advantages derived from the use of superheated steam are: The increased volume of steam delivered per unit of water evaporated, the prevention of cylinder condensation, and a much smarter engine. When we consider the fact that the heat losses in the cylinders of a saturated steam locomotive average 30 per cent., due to cylinder condensation, which is eliminated with highly superheated steam, and in addition there is an increase in volume, it is an easy matter to see why the superheater locomotive produces such remarkable results in the way of efficiency and economy.

Add to this the fact that the efficiency of the superheater locomotive increases as the load increases, while it is the reverse with saturated steam, and we have the reason for its being generally adopted.

In the operations of a superheater locomotive it is necessary, as with all other devices, in order to obtain the most efficient and economical performance, that the enginemen be familiar in a general way with the construction and operation of the superheater as well as the nature of superheated steam, and while the operation does not require any radical departure from what has been the recommended practice for saturated steam locomotives, there are some operating features which, if followed closely, will produce the desired results, while on the other hand, if they are not followed, the results are unsatisfactory and the full efficiency and economy of the superheater locomotive will not be obtained.

DRAFTING AND FIRING.

One of the most important features to be considered is firing. Inasmuch as the efficiency of the locomotive increases as the degree of superheat increases, it can readily be seen that the flame temperature in the fire-box is a very important factor and it is quite necessary that the draft appliances be so constructed as to produce an even, steady pull over the entire grate, and a draft condition that will make the locomotive a free steamer. In order to obtain this, it is generally necessary to use a somewhat smaller nozzle, draft-pipe and stack arrangement.

On account of the smaller volume of exhaust steam and its higher velocity, a moderate reduction in the size of the exhaust nozzle does not produce the same bad effect as with saturated steam, and its reduction to produce the desired draft conditions may be reached before there is any noticeable effect in the way of back pressure. However, the necessity for these changes depends much on the quality of fuel used and the operating conditions.

Firing should be light and regular and a high flame temperature maintained.

Keep a light fire, a bright fire and a level fire, and if you do this you will have a hot fire and this is necessary to obtain best results. Close the fire-door after each shoveful.

Banked fires and applying fuel in large quantities must be avoided, as this practice produces a low flame temperature, which materially reduces the degree of superheat and affects the economy and efficiency of the locomotive.

The kind of coal to be used has to be considered. For illustration: A superheater locomotive will give less trouble and will be more efficient using Colorado or New Mexico coal than it will with Iowa or Arkansas coal; this is on account of the former coals being almost free from clinker and slag forming properties, while the latter is very hard to clinker the grates and honey-

comb the tubes, superheater units and flues. This is especially true during wet and snowy times when the percentage of moisture is high in the coal, all of which has to be evaporated before the coal will burn, and while this evaporation is taking place, instead of having a white burning fire, we have a red, smoky looking fire that has a temperature just up to the melting or fusing point, and the impurities which are present more or less in nearly all coal, melt and run and form clinkers in the fire and on the flue-sheet, in tubes and flues. This occurs worse with old flues than with new ones.

The way the engineer starts his train has much to do with this also. If in starting he gives his engine too much throttle, the first move causes the engine to slip, which helps to form clinkers and honeycomb on the flue-sheet and superheater units.

When making a terminal start, the condition of the steam being used is exactly the same as ordinary wet or saturated steam, and this condition continues until the superheater elements get heated, the steam gradually getting hotter and hotter and dryer and dryer. Enginemen should be interested in having flues kept clean.

Any stoppage of the flues reduces the boiler heating surface and in case of the superheater flues also reduces the degree of superheat, as the steam passing through the unit contained in the plugged flue is not superheated and when it is delivered in the superheat portion of the header its effect is to reduce the temperature.

The enginemen should report promptly any indications of trouble in the front end, or other trouble that will in any way affect the free steaming of the locomotive.

Experience has shown that a very bad condition can exist in the front end of the superheater locomotive, and still the performance be reasonably satisfactory. Many cases have occurred where these conditions have become bad enough to cause a failure ordinarily before it was known that there was anything wrong.

Enginemen should always bear in mind that if a superheater locomotive does not steam freely there is something wrong which should be corrected at once.

Enginemen should report promptly any failure of the superheater damper to work properly, and in case it fails to operate on the road the damper weight may be tied up to hold the damper in open position until the trip is completed, and to avoid a failure.

If for any reason the damper on a road locomotive does not close when the throttle is closed, the engineer can always protect the superheater units from overheating by slightly cracking the throttle when in his judgment it is necessary.

BOILER FEEDING.

Enginemen should feed the water regularly and carry it at a uniform level, making sure that it is not high enough to carry over into the superheater.

Any water carried over into the superheater will be evaporated by the heat passing through the large flues and in this case the superheater is being used as an auxiliary boiler with little or no superheat obtained. This is one of the most common and expensive mistakes made in operating this class of power.

Enginemen should bear in mind that the water consumption should be about one-third less than with a saturated steam locomotive in doing the same work and should regulate the boiler feed accordingly.

Enginemen should avoid the practice of filling the boiler too full before starting or when drifting. Otherwise the locomotive will be slow getting under way, due to the superheat coming up slowly, and usually the engineer runs two or three miles before it is necessary to apply the boiler feed and much steam is wasted at the safety valves.

Enginemen should always note the height of water in the boiler when taking charge of a superheater locomotive and

should not attempt to move it until the air pressure is pumped up and the brake in operation.

The common practice of filling boilers too full of water in engine houses and yards makes the above instructions necessary, because when the boiler is too full and the throttle is opened, the large volume of water passing into the superheater makes it difficult to handle the locomotive, particularly if the engineer is not aware of the conditions. This, however, is a very bad practice and should be stopped.

Cylinder cocks should be open before starting and remain open until dry steam appears, except when making station stops, when there is not liable to be any condensation in the cylinders.

Enginemen should run with a wide open throttle when the working conditions will permit and with a short a cut-off as is consistent with the proper handling of the train.

It is not expected that an engineer will attempt to run with a wide open throttle with a very light train and he should not handle a heavy train with a light throttle and an unnecessarily long cut-off.

Enginemen should bear in mind that the application of the superheater has practically increased the boiler capacity and as the efficiency of the locomotive increases in proportion to the increased pull on the draw-bar, they can work the engine much harder than is possible with saturated steam, when occasion requires it.

LUBRICATION.

Owing to the fact that there is no moisture in superheated steam to assist in lubricating, it is generally necessary to use a little more oil than with saturated steam.

Enginemen must know that the oil feed to valves and cylinders is constant and where the cylinders are equipped with an independent feed about 75 per cent. of the oil should be fed to the valves and 25 per cent. to the cylinders. When the cylinders are not equipped with independent feeds and all of the oil is delivered in the steam way or steam chest, no reduction should be made in the total amount of the oil used.

Owing to the high temperature of the valve and cylinder walls when shutting off, and particularly at high speeds, it is considered necessary to admit a small amount of steam when drifting, in order to prevent the oil from carbonizing and also to prevent drawing in hot gases from the smoke-box.

In many cases special means of admitting steam to the valves and cylinders is provided, but in the absence of this it is recommended to slightly crack the throttle when drifting until such a time as the valve and cylinder walls cool down.

If you keep enough steam in the cylinders when drifting to keep the air and smoke-box gases out, you will have very little trouble about lubricating with any of the best valve oils furnished. In other words, if you keep the steam pressure in your cylinders above atmospheric pressure, air won't get into the cylinders. It won't run in against a higher pressure any more than water will run up a hill, and the oil won't burn without air. It is just as necessary to have air to have a fire as it is to have fuel. In fact, it is the air that burns. It takes air, fuel and temperature for a fire. Steam, fuel and temperature will not burn. Steam in many cases is used to extinguish mine fires. The ability of the oil to adhere to the surfaces to be lubricated is very important.

It has been learned from experience that a great many of the troubles formerly attributed to insufficient or defective lubrication have been eliminated by the proper delivery of the oil, and the use of metal in valve chambers and cylinders most suitable to high temperature, and more care in fitting up the parts coming in contact with the superheated steam.

Enginemen should be prompt in locating and reporting blows; and any report of this nature should receive prompt attention.

Keep your ear on the alert for blows in valves and cylinders; the steam you are using now travels faster than it used to and carries away a great deal of your lubrication when blows occur.

DON'T'S.

Don't expect too much out of the superheater; it is not intended to overcome blows or supply steam leaks or square valves, and it is like some children—won't keep itself clean.

Don't forget when switching that there is more steam between the throttle and cylinders with the superheater than with the saturated steam engine—the superheater holds some.

Don't carry water too high just because you don't hear any in the smoke stack. You might be using your superheater to boil water instead of heating steam.

Don't think because your engine steams that you are getting the full value of the superheat; your engine may not be calling for the capacity of your boiler.

Don't close your throttle entirely on road engines until you are going quite slow; your cylinder lubrication will be much better.

Don't shake the grates violently when the engine is working hard; it causes the tubes and superheater units to choke up more frequently.

Don't fire your coal too wet; it won't clinker so badly if reasonably dry. The more you rake the fire the more the flues will stop up. There are only two reasons why a fire should be raked: one, because too much coal is used, and the other because it is not put in the right place.

While there is a great difference in coal, there is not as much difference as in what you are able to get out of it. They tell us of the high number of heat units or B. T. U.'s in certain coal; what does that amount to, to us, if we are not able to catch them, harness them up and use them to our advantage?

Keep after the terminal forces to clean the superheater units. Watch this a little when you have an opportunity. You are liable to find them using anything from a short flue auger to a 1½-in. pipe. They should use about a ¾-in. pipe, long enough to go through the flues, and this should be used with a high air pressure, along with suitable hooks and scrapers to fully clean the superheater units. If it is not done in this way, they will not be clean, and the money invested in the superheater is worse than wasted, because you will then have a saturated steam engine with a low-pressure boiler with decreased heating surface, impaired water circulation drafted too strong through lower flues, causing holes to come through the fire near the flue-sheet, which has a tendency to make them leak. If this is allowed you have a low pressure saturated steam engine with big cylinders, and generally nothing to put in them.

Committee: J. W. Hardy, chairman; Sheridan Bisbee, W. A. Buckbee, B. J. Feeny and J. W. Heath.

DISCUSSION.

The use of a full or partially open throttle on superheater locomotives was the subject of an extended discussion. Strong advocates of both methods were heard and concrete examples were related where each method had proved to be the better. In one case a test was reported where the temperature of the superheater was recorded and it was shown that when operating with a full throttle, as the speed increased and the cut-off was shortened, the temperature in the superheater continued to decrease, but when the cut-off was lengthened and the throttle partially closed the temperature again reached 680 deg. Some members advocated the use of a light throttle in freight service in connection with a long cut-off, but the use of a full throttle and very short cut-off in passenger service with superheater engines. It finally appeared that the proper method of operation is the use of a full throttle up to the point where the cut-off is 25 per cent. If it is necessary to use a shorter cut-off than this it is advisable to close down on the throttle in preference to shortening the cut-off.

One member claimed that as high as 60 per cent. of the superheater locomotives he had seen in operation carried the water too high and made a steam generator of the superheater. Some

of the other members who had had much experience with superheater locomotives had not found the proportion as large as this, although in a number of instances they reported trouble in getting some of the crews to carry the water low enough. In cases where pyrometers are applied, the difficulty with high water is not encountered, as the presence of water in the superheater is indicated by a sudden reduction in the temperature of the superheater.

It is claimed that when converting a saturated to a superheated engine the best results are obtained by reducing the nozzle from 10 to 15 per cent. and using a smaller stack. The reason for this is that the total weight of steam discharged through the nozzle is considerably less than that for saturated steam, and a small nozzle will give the desired draft to better advantage. This reduction in the size of the nozzle, however, does not increase the back pressure.

Considerable discussion arose on the subject of cleaning the superheater. The paper recommended the use of a ¾ in. pipe, but one member strongly objected to this size, claiming that it was not possible to bend a pipe of this size of the necessary length so as to get it to properly enter a long superheater tube. He recommended the use of ¼ in. pipe. Other members, however, seemed to have found no difficulty in using the ¾ in. diameter. It was generally agreed that thorough cleaning of the superheater units and tubes was not only necessary, but almost vital for the success of the appliance. It was also agreed that it was only with the greatest care that a thoroughly clean surface could be maintained. One member explained the construction of an electric lamp with a reflector so that the light could be thrown in the tube and disclose any cinders or clinkers that might still remain around the unit. He has found it necessary in some cases to use a long bar with a hook on the end, in order to dislodge the clinkers around the unit supports. Cases of where the turn table had been used to remove a unit from a tube were mentioned. This was due to the collection of cinders and clinkers around the unit and its supports, cementing them in place. In connection with the difficulties caused by the formation of honeycomb it was explained that coal, if less than 2 per cent. sulphur, will not clinker or honeycomb, and also that it is only at the high temperatures that honeycomb forms. It was also suggested that leaks might be responsible for the starting of honeycomb, but the general evidence was that a very high temperature with certain qualities of coal was the principal reason for it.

Lubrication of superheater engines appears to have caused trouble in some cases. A number of instances were related where ordinary Perfection valve oil in comparatively small quantities had been successful on superheater engines. It was recommended that the use of cylinder oil feed be confined to the time when the engine was not working steam, and that as soon as the throttle was open the cylinder feed be cut off.

Graphite lubrication has been very successful at two points where it has been tried. Care is necessary, however, not to use too much graphite. One member explained a test with a 4,000 ton train for a distance of 150 miles. The run required 25 hours. This superheater locomotive was lubricated by feeding oil only to the valve and but 3½ pints of valve oil were used, giving most excellent results in every particular. Superheater oil can be successfully used, but in many cases it appeared that it is not required, as the Perfection valve oil gives satisfactory lubrication.

THE OPERATING DEPARTMENT AND FUEL ECONOMY

A committee report on "Credit Due the Operating Department for Power Utilization and Train Movement that Reduces the Consumption of Fuel," was presented, of which the following is an abstract:

For the purposes of this paper it is assumed that the operating and mechanical departments are to be considered as distinct

units. The operating department consists of officials usually known as general superintendent, superintendent of transportation, division superintendent, trainmasters, train dispatchers, yardmasters, etc., or those who have to do with making up and dispatching trains. The consumption of fuel per ton mile is variable and dependent on many conditions, two of which come within the province of the operating department. When the power is ready for service, fuel burned while it is waiting to be utilized might be considered by the strict economist as being wasted, as no direct earnings result from its use. Fuel burned during the time beyond that in which the train should be delivered at destination under average favorable conditions might also be considered wasted. The relation which the operating department has to economical consumption of fuel lies in its control of the above two items through its connection with power utilization and its supervision of train movement.

The study of fuel economies is scarcely a duty of the operating department, but moving trains and handling power in connection therewith are its chief duties and on the efficiency with which it performs these functions a low or high fuel consumption largely depends. Its opportunities for aiding in keeping down fuel consumption through betterments of many underlying conditions, well within its charge, that have an indirect bearing on promptness with which power can be utilized and trains made up and delivered, are far from limited. Credit is due it for betterments that result in actual savings in fuel and for endeavors to take advantage of opportunities tending to further savings. The true credit due is proportional, however, to the utilization it makes of these opportunities as a whole, considering possible savings that could be made if all were taken advantage of. While credit is due any department for every pound of fuel saved, the credit is grudgingly given if it is known that conditions exist, capable of remedy, whereby two pounds might be saved, where but one was saved. Paradoxical as it may appear, a seemingly low fuel consumption per ton mile may actually be a high consumption, and the maximum amount that should be used may be less than the minimum amount being used through adverse conditions of operation which might be reduced to a minimum if proper efforts were made.

Among the features which the operating department controls to a more or less extent, and through study of which it can perhaps aid in reducing fuel consumption, we might call attention to the following:

LIMITATION OF POWER KEPT IN ACTUAL SERVICE.

We assume that practically the maximum number of engines required to handle business at its height is assigned each division. Good judgment in shopping engines for repairs and in storing them during dull periods is an important item in fuel economy. We do not believe in limiting the number of engines kept in service to a point that might delay freight through lack of power to move it, but while any train or number of trains may be moved with a low rate of fuel consumption when only fuel used in actually moving is considered, yet all fuel consumed by the engines of a division must ultimately be charged against the total train movement of such division, and engines needlessly lying ready for service and consuming fuel in idleness increase the fuel consumption per ton mile above the figure used in actually handling tonnage. If an engine, which when promptly utilized can cover the division with four tons of coal, burns a ton while waiting to be utilized, five tons must be charged against train movement and fuel consumption per ton mile is increased accordingly. The same is true of power held out on road beyond what would be a reasonable time under favorable conditions, when such delay is due to indifferent operative conditions. It is realized that delays are not always chargeable to the operating department, but closer final charges for fuel consumed are to the number of pounds per ton mile used in actually handling train, the greater will be the credit due that department.

In storing engines, we believe in keeping those in service whose mileage comes nearest entitling them to shopping. If poorer engines are stored, the good ones are being worn out during the dull season and when the rush season comes this department is handicapped by having the majority of its power in poor condition. With poor power in use during dull periods, the tendency of such power to break down is not as likely to cause delay to following trains, with accompanying waste of fuel, as in the busy season when trains run closer together.

Credit should be given to the operating department by the fuel economist when it exerts its influence to have maximum amount of power repairs made in dull seasons. Judgment in assignment of different classes of power to sections best suited to each class, or assignment of such variety of power to various sections as the peculiar requirements of such sections demand, is important to fuel economy. While each division operating department may not always obtain the power best suited to its needs, judicious assignment of such power as is at its command to runs best suited to each class, aids in keeping down fuel consumption and brings corresponding credit.

TURNING OF POWER.

Whether in direct charge of turning or not, it is entitled to credit for aid in procurement of betterments that make quick turning possible with accompanying economy in fuel. This calls for good arrangement of trackage to and from yards to turn-table, ash-pit, coal-chutes and water tank, and a sufficient and efficient turn-table, ash-pit, coal-chute and water crane arrangement whereby, particularly at busy terminals, a more or less continuous "blocking up" condition is avoided.

YARDS—TERMINAL, INTERMEDIATE AND HUMP.

Yard conditions, terminal and en route, are perhaps the most prolific source of train delays that result in increased fuel consumption. Terminal yards should be large enough to permit prompt entrance of incoming trains and provide for quick movement of the power to the engine terminals. Yards at intermediate points should provide for speedy switching where necessary to pick up or throw out cars and for prompt obtainance of water and fuel when necessary. At large terminals, separate yards for making up trains going in opposite directions, classification tracks in connection with making up, provision for proper storage tracks, cripple tracks of easy access into which bad order cars may be thrown for repairs, which are to be used exclusively for this purpose, and making up tracks, long enough to hold the maximum length of trains hauled, thereby avoiding switching incidental to making up on two tracks, all tend to promptness of train movement and minimizing of fuel consumption. Hump yards are an efficient means of reducing fuel charges in switching service by reducing switching power. Credit is due the operating department for being instrumental in having these installed. Experience is teaching, however, that unless closely watched they not only run up car department costs, but are not as conducive to fuel economy as they might be, due to failure of the yardmasters at some points to see that the cars are not prevented by riders from striking with sufficient force to damage them. This frequently results in delays due to making repairs or throwing out badly damaged cars and is believed to be a material cause of break-in-twos en route, due to damage done to the drawbar rigging by permitting such serious impacts, with increased fuel consumption due to such delays. While giving credit for betterments promoting prompt train movement and fuel economy, none of the saving gained should be lost by unnecessary carelessness.

LOADING OF THE POWER.

Proper loading of the power as to capacity is important to prompt train movement and fuel consumption. We believe the power should be loaded to not more than 90 per cent. of its maximum capacity under the best conditions and this varied according to weather conditions. Fuel is sacrificed by under-

loading as well as overloading. Where a grade on the division is not sufficient to justify pusher service, if trains were loaded so to make certain they would not stall on such grade they would be underloaded over the rest of the division, causing considerable loss in ton miles and increased fuel consumption per ton mile. Local conditions should be carefully studied to determine the most economical load for the territory. Makeup of trains as regards heavy and light cars is important, as the further from the engine the heavy cars are, more flange friction is increased on curves and the harder the train will pull. Efforts should be made to place heavy cars at head end of train. Judgment, however, should be used in order not to bring about bad braking conditions.

TRAIN INSPECTION.

While train inspection is not usually directly in control of the operating department, it bears such intimate relation to train movement that this department is vitally interested in it. Prompt inspection of trains, providing adequate facilities for such inspections, for making light repairs, for throwing out bad order cars, for inspection and testing of air brakes before the road engine is attached, or arrangements for quick test after it is attached, are of direct benefit to it, and incidentally to fuel economy.

BLOCK SIGNALS.

Where block signals are in use, their location so they can be seen a reasonable distance away from the approaching train is important. So, also, is proper maintenance of lights thereon, their size and the focus of the lens. Being required to reduce speed on account of not being able to see the signal until almost at it is not an uncommon cause of slow movement and, therefore, not conducive to fuel economy. In congested districts, where stops are likely to be frequent, the location of signals with a view to good starting ground, is of importance. Automatic block signals are decided improvements over mechanical or hand-thrown signals, on account of being closer together, enabling an inferior train to occupy the main track closer to the time of a superior train and to start out closer behind a superior train, thus bringing about more prompt train movement and less delay in allowing superior trains to pass, resulting in fuel saving.

TRAIN DESPATCHING AND HANDLING OF TRAIN ORDERS EN ROUTE.

Handling train orders from towers without requiring the train to be brought to a standstill is important to prompt movement. Handling orders to the crew in passing at low speeds by means of hoops and staffs is in successful operation on several roads, and credit for the accompanying savings in fuel is due the operating departments that adopt it. In automatic block territory on ascending grades, heavily loaded trains should be allowed to proceed under caution instead of coming to full stop. In manual block territory on ascending grades, caution cards should be handed on by hoops instead of stopping the train. The use of telephone boxes at outlying points for the purpose of directing crews with reference to train movement is also a distinct aid and source of credit to the operating department. Utilizing the track against the current of traffic can be frequently done on double track roads to good advantage.

POOLED OR ASSIGNED POWER.

Whether best to pool the power or assign each engine to a regular crew has an influence on fuel consumption. Admitting a regular assigned engine is given more attention by the engine crew, that it will get out on time more frequently, and with a good engine crew may perhaps cost less for maintenance, yet with the growing tendency to take the responsibility of doing work on the engines from the engine crew and placing it on the shop, the advantages of assigned engines are becoming fewer. The sixteen-hour law makes it practically impossible for an engine crew to follow an engine unless it is held a long

time at the terminals, which cannot be thought of when the yards are congested. If the engine is not held, the engine crew that brought it in may not see it again for a week, which practically places the engine in pooled service. If men could, as formerly, follow their engine with whatever rest they themselves considered sufficient, the assigned engine would be ideal. If the assigned engine is in better condition, it is only because the engine crew is continually reporting work and following it up. If engineers on pooled engines were educated to take the same interest in promptly and intelligently reporting work on every engine brought to the terminal and were held to strict accountability for reporting all defects, and the shops were required to do the work reported, there would be little, if any, advantage in assigned engines over pooled engines. While every railroad has its portion of indifferent engineers, the pooled engine will occasionally, even now, get the care of the interested engineer. It is a well-known fact that the same volume of business can be handled with less number of pooled engines than assigned engines, which should result in a corresponding lower total fuel consumption.

CONCLUSIONS.

The measure of credit due to the operating department for low fuel consumption per ton mile lies in the progressiveness, strenuousness and the persevering continuity of its efforts to bring about perfect operating conditions and despatching methods in its territory. With railroads hampered, as they are today, by restrictive laws and rate-making legislatures and commissions, the recognized successful railroad men are those who can increase the company's net income by limiting the amount of its financial outgo, and in so far as the efforts of the operating department are successful in bringing about conditions that cut down the fuel consumption per ton mile, it need have no fear of not receiving the full credit thereof.

Committee: M. J. Howley, chairman, T. B. Mowen, J. C. Petty, J. W. Nutting, G. H. Travis, and P. J. Miller.

DISCUSSION.

Many different ways in which fuel could be saved by care on the part of the operating department were mentioned in the discussion. It was pointed out that many of the lower officers of the operating department did not realize this and that if they were shown clearly exactly how their actions affected the coal pile different results might be obtained. There is no lack of interest on their part but a lack of knowledge.

Forgetfulness in recalling slow orders by the roadmaster or bridge department is frequently the cause of much wasted coal. Several members seconded the report of the committee where it mentioned the importance of the location of water tanks, switches and signals in relation to grades. Lights on signals and switches which were not large enough or out of focus were also mentioned as frequent causes for slow downs which required an unnecessary increase in the fuel consumption.

The very large and entirely unnecessary consumption of fuel caused by a locomotive ordered but waiting for its train is probably where the operating department has its greatest opportunity for fuel saving. Two hours is ample time for the roundhouse to prepare an engine for its train, and any loss of fuel due to waiting should be debited to the operating department. In the same connection the anxiety of the yardmaster or superintendent to quickly get the train out of the yard as soon as the engine is attached to it, is responsible for working the engine so hard for the first mile or two that the fire is put in a very bad condition and a failure further down the line is invited in addition to the direct loss of fuel at the time.

While it is generally admitted that the dispatcher will make every effort to keep the trains moving, it was believed that closer care by all other operating and road men to avoid delays would decrease the fuel consumption. It was believed by some members that over 30 per cent. of the fuel burned on a trip was

required while the engine was standing still. The Interstate Commerce Commission reports show that a speed of but 20 miles per day is made by all freight trains. A faster movement of trains would tune up the employees in freight service to faster work. The trainmen in passenger service were used as an example of this result. As a flagrant example of waste of fuel due to the operating department not using an engine as quickly as it was ready, a test had recently shown that at one terminal 81 per cent. as much fuel was used by the locomotive before starting out as was required to cover the whole division. In this connection it was pointed out that all of the fuel saving devices on the locomotive are only of value when the engine is in operation.

Although it was understood that the character of the freight often governs the size of the train, it was believed that greater care in arranging the tonnage in order to give a full sized train to the locomotive, and at the same time not overloading it, would have a distinct effect on the coal pile. Examples of where locomotives were run over two or more divisions continuously with only cleaning the ashpan and taking coal and water at the intermediate terminal, were mentioned. In one case a run of 286 miles was made by a freight engine with but seven minutes delay at the intermediate terminal.

It was advised that when matters of this kind are being taken up with the operating department it is advisable to have all details immediately at hand. Generalities will not bring results and give the co-operation which really spells success. It is the practice on one road to issue each month from the vice-president's office a sheet giving the fuel consumption per hundred ton-miles and per car-mile for each division. This sheet is arranged for ready comparison between the divisions and has had a very material effect on the operating department in regard to reducing coal consumption.

MR. TOLLERTON'S ADDRESS.

W. J. Tollerton, general superintendent of motive power, Rock Island Lines, in addressing the convention, stated that traveling engineers should remember that the necessity for using discipline is, in many cases, an indication of lack of proper instruction. Education is the proper means of obtaining the best work from an engine crew and the better it is, the less necessity there will be for disciplinary action. The educational work should start with the fireman when he is first hired and be most thorough at the beginning. He recommended that meetings be held with firemen and engineers, committees appointed and papers prepared and discussed. A box in the roundhouse where suggestions from engineers could be deposited was also mentioned as a good practice.

Vague engineers' work reports were mentioned as a point for possible improvement. Such indefinite reports are needlessly expensive. Of the total cost of locomotive operation, fuel consumes 42 per cent., but repairs require 24 per cent., and more explicit and carefully made engineer's reports will reduce the latter figure considerably. Careful attention to prevent overloaded tenders, and also to seeing that the water glass shields are properly applied and maintained were mentioned as two features in which the traveling engineer can assist materially in the safety movement. It was pointed out that the cost of personal injuries and fire are a complete loss to a railroad company.

ELIMINATION OF BLACK SMOKE FROM LOCOMOTIVES

BY MARTIN WHELAN.

We all agree that smoke escaping from a locomotive stack is a waste and the greater the volume of smoke the greater the loss. The emission of black smoke is a sure indication of imperfect combustion. It is also an infallible sign that there is some condition existing in the firebox that is detrimental to

combustion, and the question is: Could that condition have been averted? In other words: Can the emission of black smoke from the stack of a locomotive burning bituminous coal, be prevented, and how can it be done?

It can be done, and locomotives working in all kinds of service, both heavy and light, and frequently dragging trains up a long grade at slow speed, and in ten hours' work can be fired so that they will not make No. 2 smoke of the Roberts chart.

The most effective device for preventing smoke is a number of combustion tubes used in conjunction with steam jets. These tubes are located in the side sheets or back head of a boiler. The number in the side sheets usually varies from four to seven on each side. They are 2 in. in diameter and are applied by removing the fifth or sixth staybolt above the mud ring and in enlarging the hole to fit the 2 in. tube. Where the tubes are located in the back head they are usually placed above the fire door. The object is to admit air above the fire and to mix it with the gases as they escape from the burning coal. The steam jets are connected by $\frac{1}{2}$ in. pipe with $\frac{3}{8}$ in. nipple entering the tube. Some roads have the nipple opening just flush with the outside sheet, and others go to the other extreme and extend it in almost to the inside sheet. The reason for this difference is that when placed outside the noise is very annoying and it requires constant watching to get the engine crews to use them. The noise is greatly reduced when they are extended inside. The tubes located in the back head are also effective, but the noise is objectionable.

The next requirement is the blower connection with a $1\frac{1}{4}$ in. pipe extending from the fountain to the smokebox. The multiple blowers are preferable because they are almost noiseless, but objectionable because the small openings soon become filled with dirt. The double tip blower is the most serviceable and is generally used on that account. The blower pipe should have a quick-acting auxiliary valve located so that the fireman can reach it easily from either the deck or the seat box. The steam jet connection is usually made to the blower pipe, either above or below the auxiliary blower valve (preferably above), so that the steam jets can be controlled independent of the blower, as there are times when the engine is using steam that it is found necessary to use the jet and not use the blower. The valve which controls the steam jet should be located close to the auxiliary blower valve.

The brick arch is a great help when using steam, but in my opinion is of little benefit when the engine is shut off, unless the arch is sealed against the flue sheet. When this is done it will pocket the smoke and gases and prove a great benefit. There is the objection of cinders and dirt accumulating on top of it, but I find that after two weeks' service between washouts the amount of cinders will seldom cover more than two or three rows of flues. On freight and passenger engines there is sometimes an opening left between the flue sheet and arch, as they are almost continually using steam, and if properly handled by the crew, will make no smoke.

Another device that is frequently brought in discussions on smoke elimination is the mechanical stoker. Although I doubt that the question of smoke elimination was primarily considered by the designers of any of the locomotive stokers, still I believe it should be considered, as smoke from locomotives has been declared by a law a nuisance in many places, and while the absence of smoke does not always indicate proper combustion the presence of it does indicate improper conditions. I have seen several of these stokers tested, but with one exception they made a great deal of smoke. The only one that I know anything of that is smokeless is an underfeed stoker used on the Pennsylvania Railway and known as the Crawford stoker. I have seen this stoker in all kinds of service and know it is a success as a smoke eliminator.

Co-operation on the part of the engine crew is of the greatest

importance. Without it mechanical devices are a failure. The most effective preventer of black smoke is the man behind the scoop. A fireman who has a fair knowledge of the principles of combustion and makes use of that knowledge will make a better showing on smoke elimination than a disinterested one with all the known devices or even the best grades of coal. Experts may spend time and money figuring on the best methods, etc., but all devices are more or less dependent on the human element. None are foolproof, and we are brought down to the conclusion that the men on the locomotives are the principal factors and therefore it becomes necessary to work along the lines of first getting them interested and then educating them. Why are firemen not interested and what can be done to overcome this lack of interest, is the great problem of today, and until it is solved, smoke elimination is a difficult proposition. We all recognize that the firemen of today have not the advantages of the regular engine or the regular engineer. That has been taken from them. Arrangements have been made to take care of the pooled engines, but we have failed to arrange for the changed conditions that the pooled engines have forced on the firemen. All progressive railroads maintain apprentice schools for the purpose of educating the mechanics, but how many pay any attention to the education of the firemen? The mechanical apprentice, after serving four years, still continues under the eyes of a foreman, whereas the fireman after three years spent feeding coal into a firebox is considered competent to assume the responsibility of managing a locomotive on a busy railroad. The apprentice just out of his time may leave the railroad that educated him and never return, whereas the promoted fireman usually remains during his life, and once he becomes an engineer he has no foreman immediately over him in his daily work, but instead he becomes a foreman himself.

Daily observation has convinced me that the engine crew is the main factor. The devices only assist in proportion to the degree of intelligence used by the engine crew. In a district like ours where the smoke question is followed closely, we are able to fully appreciate the value of it over the conditions that existed before the question was given any consideration. There is considerable saving in fuel owing to the fact that the men are educated to put in small quantities of coal at a time; as a result of this the fire is kept in better condition, there is much less work cleaning it on the ash pit, less trouble with tubes leaking, fewer engine failures, and finally when these firemen are promoted to road service we hear less of engines not steaming on account of poor coal. In the Cleveland district the crews are disciplined for violations where such violations are the results of carelessness. Both engineer and fireman are held equally responsible. For the first offense they are warned, and if they still continue to disregard the instructions they are suspended, usually for ten days.

In conclusion I wish to state that if engines are equipped with the ordinary devices for the prevention of smoke and the engine crews are properly instructed as to their use and the proper method of firing a locomotive, there will be but little cause for complaint on account of objectionable smoke.

DISCUSSION.

Ample testimony was given that proper instruction and supervision of the engine crew will do very much to reduce the amount of black smoke. This should begin when the fireman has first entered the service. In fact, some members believe that the fireman should be given a more thorough understanding of his work before he is hired at all and given to understand exactly what will be required of him in the matter of making smoke. Difficulty is found in getting the engine crews to properly follow instructions and it is recommended that an inspector whose sole duty it would be to supervise the crews in this particular, could make himself valuable. One member went so far as to say that smoke could be prevented in any service if the proper care and equipment were provided.

It is generally admitted that the roundhouse is the most flagrant offender. Probably 70 per cent. of the smoke made in roundhouses could be eliminated with the proper supervision and equipment, was the opinion of one of the speakers. Smoke washers are being tried with some success on the Lake Shore & Michigan Southern. These consist of a large duct running around the house into which all smoke from the locomotives is drawn by a suction fan and then discharged through a vat of water which dissolves most of the obnoxious gases and entrains all of the free carbon.

Both the brick arch and the superheater were mentioned as aiding in improving the situation. This is especially true on switch engines. Sufficient air opening to the ash pan is a very important feature in reducing the smoke when the engine is working hard and in some cases it was found impossible to have successful firing except when the fire door is open.

ADVANTAGES OF THE BRICK ARCH

BY LE GRAND PARISIE.

The general introduction of the brick arch in the past few years has been brought about by the necessity for increased boiler power and sustained steam pressure. The other incidental advantages, which, in themselves, are large, are subordinate to the necessity for increased power per pound of metal.

The locomotive builders were among the first to advocate the application of the brick arch and superheater, which are referred to by them as fuel-saving devices. They recognized the fact that, where the weight on drivers had reached the maximum, increased power must come from sustained steam pressure. These, as well as any other devices which will aid in bringing about this result, are receiving earnest attention by mechanical and operating officers. Important improvements are being made in the form and application of brick arches and arch tubes, as is evidenced by the recent combination of the sectional arch on tubes and the Gaines furnace. These improvements are the inventions of men in railroad service who are trying to improve the steaming capacity of the boiler. The long firebox with a suitable combustion chamber, shorter flues in some cases, improved front ends, improved grates and better air admission in the ash-pan have given surprising results. Important improvements in exhaust nozzles and exhaust passages in the saddle have also been developed in the past few years. All of these things are essential to the successful operation of the locomotive, and every detail that will in any way result in the increased capacity of the boiler is imperative today.

One result of the application of arches is to reveal weaknesses in other factors affecting combustion. It is frequently necessary to give immediate attention to the admission of air through the grates. This is usually done by cutting down the nozzle, whereas the fault lies in the ash-pan. The fire must have air, and when it is considered that it is necessary at times to use twenty-five tons of free air per hour (or a volume equal to 350 box-carfuls of air), we better appreciate the problem which confronts us when this has to be drawn in by the exhaust nozzle. The more difficulty experienced in getting air into the ash-pan, the more back pressure we produce in the cylinders. The speed of the air entering the coal on the grates when burning one hundred pounds of coal per square foot of grate per hour is approximately sixteen miles per hour. Its velocity is increased after passing through the fire on account of the increase in volume due to increase in temperature. The speed of the gas entering the flues would increase to approximately 180 miles per hour on a locomotive with seventy square feet of grate and eight and one-half square feet of flue opening, such as is found on our large Mikados. This will give a fair idea of the difficulty in burning the gases before they escape. The arch, acting as a baffle wall, retards the gas only to a limited extent, but long enough, however, to give a better mixture of the air and gas and greatly improve the combustion.

It is a well-known fact that the length of the flame-way is

the all-important factor, because the gas must have sufficient travel to complete its series of explosions before it enters the flues.

The fact that the value of the fire-box heating surface is seven times the value of the same amount of flue heating surface was brought out in the Jacobs-Shupert fire-box tests conducted by Dean Goss, at Coatsville. The long box equipped with a sectional arch, or with the Gaines combustion chamber, insures the proper distribution of heat over the fire-box sheets. The longer fire-box is a protection to the flues to just the extent that the combustion is more complete. The cold air from the door has a longer travel, and, naturally, absorbs more heat.

Another important matter which must receive constant attention is the care of the arch tubes. No trouble whatever is experienced from scale when a mechanical cleaner is used to cut it out of the tubes at each boiler washout. This practice is now quite general and should be universal.

There is no difficulty experienced from bad water where the tubes are properly cleaned. Washing will not answer the purpose—the scale must be cut out. This practice has been in effect on all water tube boilers of the stationary type for years, and the water tube boiler is in common use in all bad water districts. It was the successful use of the mechanical cleaner in water tube boilers that brought about its general use in locomotive boilers and made the use of the arch tube a practical success. The flow of the water through the tube is reduced very rapidly as the scale increases, due to the rough surface of the interior of the tube.

The value of the arch tube as the means of better water circulation has not received the attention it deserves. The history of the arch tube shows clearly that it was originally applied as a means of support for the arch, and its value as a circulation device was not seriously considered. Later it was accepted as having some value. In this respect today its value is of decided importance. The problem in good steaming is to utilize the full value of the heating surface. Flues which lie below the center line of the boiler have difficulty in getting rid of the heat. The only way that this may be accomplished is by getting a more rapid circulation of water in the bottom of the boiler. This will be better understood when it is known that, when the boiler is working up to its capacity, four 3-in. arch tubes will circulate fully 30,000 gallons of water per hour, when the discharge end of the arch tube is designed to discharge at the surface of the water. The boiler of a consolidation engine of modern type ordinarily contains about 3,500 gallons of water. From this you will see that the circulation is very rapid.

The 3-in. arch tube ($2\frac{3}{4}$ in. internal diameter) in common use today is the minimum size that should be used, as the diameter of the tube has a direct relation to the amount of water circulated. If the tube were reduced to one inch, it is quite probable there would be no circulation except that required to replace the water evaporated into steam in the tube. In other words, the tube would flash the water into steam of a high temperature, and practically no water would be carried out with the steam. It is quite possible that the future will see the use of circulating tubes of greater diameter than three inches. A proper design should give all the additional benefits to steaming that are obtained in water tube boilers of the stationary type.

We expect to see a decided improvement in locomotive boilers due to better circulation. More rapid circulation of water on the heated surfaces will increase the evaporation on account of the rapid replacement of the hot water with colder water. The scouring effect of the water will take up and carry away the heat, allowing the colder water to come into contact with the heated surfaces. It will be necessary to give attention to this feature if we expect to secure the benefit from a higher velocity of gases over the heated surfaces. Heat will flow rapidly through a sheet when there is cold water on one side, and will flow less and less rapidly as the temperature of the water increases. This may be illustrated by the trouble which

was experienced with bottom combustion chamber sheets before arch tubes were applied. The over-heating of the sheets was due to the fact that there was no circulation to take away the heat.

Improved steaming means better fire-boxes, and this means more satisfactory operation. The relation between the air supply, the coal and the arch is so intimate that they must be considered together.

Free access of air into the ash-pan is very important. The cases are rare where too much air is admitted through the grates when they are properly covered.

The important improvements in the future must come from improvements in nozzles or draft; improvements in grates and air supply; improvements in water circulation, and, last but not least, the development of longer combustion chambers.

The theory of a combustion chamber as applied to a locomotive is quite simple. The fixed carbon burning on the grates distills the volatile matter which is below the temperature of the heat which produced it. By adding the proper amount of heated air to the volatile matter as it passes over into the combustion chamber, the volatile matter is ignited and the temperature in the combustion chamber raised above the temperature over the fuel bed. The complete burning of the volatile matter depends upon the proper mixture of air and the length of the combustion chamber.

Anything mechanical that will aid in making a better mixture of the gas and air will improve combustion. The long combustion chamber increases the distance the gas has to travel on its rapid race to the flues, and gives more time for the gas and air to unite in the proper mixture and complete the series of gas reactions, or explosions, before they reach the flue-sheet.

Improvements in the locomotive have been made so rapidly that it is difficult to realize the importance of keeping up with the development. More expert supervision is necessary in order that proper results may be obtained, and the burden of this expert supervision rests on the members of this association. The success of any device, no matter how small, depends upon the information which the manufacturer is able to obtain from his own experts and the experts having charge of the device on the railroads. We are, therefore, mutually interested in the highest development of the service. The rapid development has brought about the necessity for more expert supervision, and the staff of the manufacturer is being drawn from the ranks of railway service and is made up almost wholly of men who specialize in the work for which their railroad experience has fitted them.

It has been stated at one of your meetings that "the arch is the best device for instructing firemen how to fire properly." This statement should receive the attention it deserves. The arch does not admit of using an excessively heavy fire; therefore, the fireman does not have to be instructed on this important factor.

The value of the brick arch as a smoke preventive is too well known to dwell on the subject here. The cost of the arch is overshadowed by the fuel saving, and the maintenance cost can be kept very low with proper supervision and by having sufficient material on hand at all times to make the necessary and proper renewals promptly. Failure to make these renewals at the proper time often necessitates a complete removal of the arch. If the arch is of value, it should be maintained in 100 per cent. perfect condition all the time.

The whole subject of the brick arch is tied up so closely with the question of proper drafting that it is not wise to apply an arch without full knowledge of its relation to the grates and exhaust nozzle.

DISCUSSION.

F. F. Gaines, superintendent of motive power, Central of Georgia Railway, gave a most interesting and instructive talk on this subject. His remarks in part follow:

While I do not want to bring any chemistry of combustion into the discussion, one of the gentlemen remarked something about the necessary temperature of the air brought into the fire-box to complete combustion. If you are going to produce carbon dioxide you will find, on looking up the various books on the subject, you will have to have a fairly high temperature. In other words, CO will not combine with oxygen to make CO₂ unless the temperature is very high.

There is another thing that has been developed recently about admitting air to the top of the fire. The report on the series of experiments made by the Pennsylvania in their testing plant at Altoona, was presented at the Master Mechanics' association convention. They found very clearly there that if you force a boiler beyond a certain point in order to get sufficient air to complete combustion you have to open the fire doors and allow air to be introduced in that manner. In other words, they could not get enough oxygen in the box through the fuel bed, without opening the doors. Of course, that is contrary to all

There is another point that has been brought up in the introduction of this paper that is very interesting, and that is the proper drafting of the engine. The experiments I have made, and they have been extending over a period of years, show that the maximum results with an arch require a low nozzle, and I do not believe you can get it too low. What I mean by that is this: if you have the old style inside steam pipes they, of course, obstruct a great deal of your area through the front end and you have got to raise your nozzle high enough to give opening enough for your gases to go out underneath, on account of the steam pipes obstructing the area. But if you have the outside steam pipes, as you have on a majority of superheater engines today, you can afford to bring the nozzle very much lower.

I have recently experimented along these lines and have nozzles on large size Mikado locomotives, that are only 15 in. high, and I find the lower I go the better results I get. Our present design is shown in the illustrations. All our road foremen and our

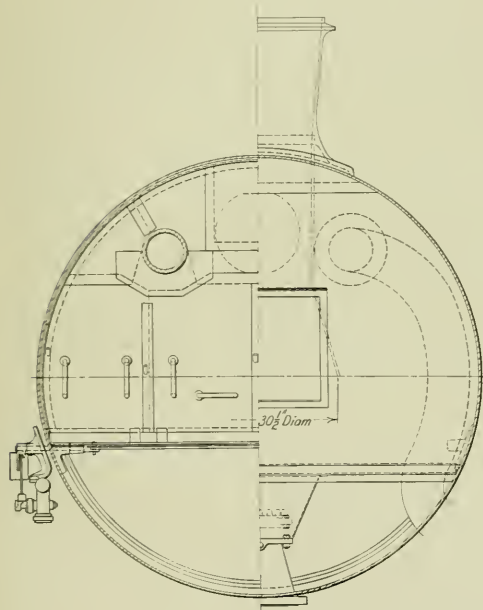

Front End with Low Nozzle; Central of Georgia.

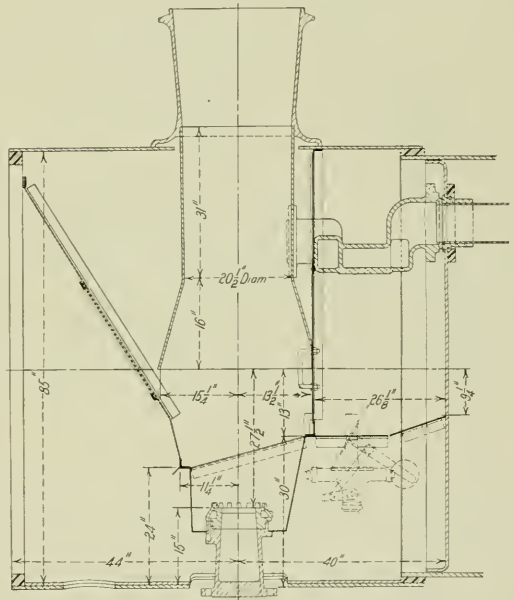

accepted practice in firing, as we understand it. Nevertheless, the fact remains, in order to get the maximum evaporation out of that engine they had to introduce large quantities of air on the top of the fire.

If you use a mechanical cleaner and good sized tube there is very little trouble with the arch tubes, even in bad water districts. We have found since using mechanical cleaners we have almost no trouble at all, and where we previously had a rule that they must be removed after a certain length of time, I have gradually been increasing that limit until I think we have gone to a period of a year now before removing arch tubes.

Another thing I found in experimenting with arch tubes, and that is that it is not always wise to use a heavy tube. We originally used to use a heavy tube, but when we cut it down to .15 in. thickness we found that apparently there is a better circulation of the water, probably due to the fact that the thinner tube does more evaporating and we have less trouble with the tubes themselves.

master mechanics were rather against the idea when we started out, but I think they are now all converted.

In connection with that, I want to call your attention once more to the series of tests made by the Pennsylvania, in which they demonstrated quite thoroughly that to properly fill a stack the old form of circular nozzle would not answer; in other words, that the nozzle must be oblong or rectangular in character. I have been carrying on some experiments along this line and I am thoroughly in accord with the results obtained. I find we fill our stacks much better with the oblong nozzle than we ever did with the round nozzle.

We find that with a combustion chamber and arch combination we have superheater engines that have been running for 15 or 16 months and we have yet to get the first report in the round-house to have one of the large superheater tubes blown on account of being stopped up. I think you will all agree with me that is quite a remarkable record. When we first got them we blew them every trip, and then we gradually reduced until I sup-

pose we blow them not more than once or twice a month now, just as a matter of form.

A saving of from 5 to 10 per cent. in the amount of fuel burned was reported by a number of members who were using the brick arch. In most cases it is advisable to have the arch tight against the throat sheet although instances were mentioned where it was desired to keep a heavier fire and several of the bricks on the lower rows were omitted. Very little difficulty was reported in connection with the arch tubes failing although the necessity of seeing that these tubes are properly cleaned and kept clean was generally admitted. The value of the arch as a safety device in case of a burst boiler tube was mentioned. On the Lake Shore & Michigan Southern there has been but one arch tube failure in three years and three months service. As a general thing the engineers and firemen were found to strongly favor the use of the arch.

The discussion was expanded to include firing methods. Examples of where a very heavy and thick fire had proven successful from every standpoint was mentioned but it finally appeared that the almost universal sentiment of the members was in favor of light and level firing with a light body of fire in the box.

A	B	Equivalent Diameter
4 1/2"	6 1/2"	6 1/2"
4 3/4"	6 3/4"	6 3/4"
4 7/8"	6 7/8"	6 7/8"
5"	6 7/8"	6 7/8"
5 1/8"	7"	6 3/4"

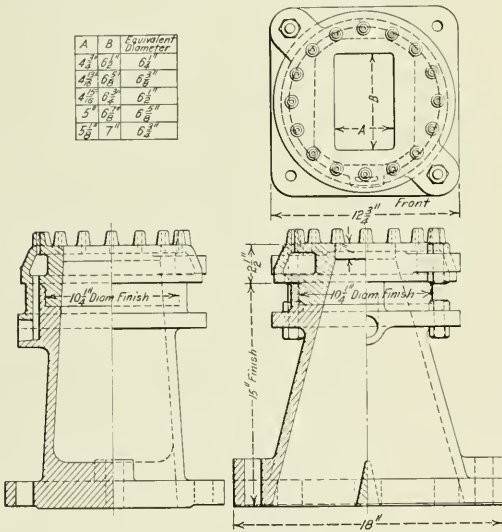

Rectangular Nozzle on the Central of Georgia.

Comparative tests of both schemes were mentioned by some of the members, in each case showing that the light fire and light feeding were by far the most economical.

Mr. Gaines stated that when first starting his design of locomotive furnace he had the idea of obtaining a large firebox volume. This, however, he discovered after longer experience, was not the proper idea and what was really needed is a long flame way. In this connection Mr. Gaines used a most expressive term, viz., "conversational heating surface," meaning that it is by no means the total amount of heating surface that indicates the capacity of a boiler but its proper arrangement and not infrequently a boiler which has a larger amount of surface is by no means as good a steam producer as one with much less surface properly arranged.

MR. MACBAIN'S ADDRESS.

D. R. MacBain, superintendent of motive power, Lake Shore & Michigan Southern, spoke in part as follows:

There is an impression on the part of many that you must fill a smoke stack with the exhaust jet of an engine in order to have a proper steaming engine. There never was a greater

fallacy, and if you will all just stop to think for a moment what a steam jet from a 1 1/4 in. pipe going up through a stack does by way of stimulating your fire to make it burn, you will readily realize that it is not necessary to have a steam jet the full size of the smoke stack.

We found a great deal of our trouble on some of our engines which have a little short smoke stack outside and an extension bell inside. It came from the fact that the exhaust struck this thing on one side or the other. The engines all cross-fired to a certain extent and they scoured up the side of the stack. The effect of that was on passenger engines that there was just one notch you could work your engine in, just so much throttle. In fact, you could evaporate just so much water and keep your fire burning nice, and when you began to crowd beyond that point the fire would begin to redden up and the steam pressure would drop correspondingly. What we did, was to provide a big enough smoke stack, and a means for sending the steam jet straight up through the center of the stack. The effect of this was to reduce the steam failures 90 per cent. It is now the rarest thing for us to have a steam failure on anything.

We have now about 350 superheater locomotives running and their use is carrying with it some evils that we did not look for at the start. The one I have particular reference to is the carrying of the water. When we had saturated steam engines the engineer never thought of carrying the water out of sight in the glass or even up at the top of the glass. But on the superheater locomotives the engineers say there is one thing sure, you can carry more water than you used to. Of course, men informed on the superheater proposition will understand just why that is so. As a matter of fact, the engine foams just the same as she ever did, primes just the same, but the water that goes over into the dry pipe and out into the units is re-evaporated so that you are using the superheater unit as an evaporating proposition pure and simple, instead of for the purpose for which it was intended. This is something that the road foremen ought to give careful attention, and get the engineers and firemen to understand that they are hurting themselves when they are taking advantage of the fact that they can carry the water higher than they did before.

I do not know any of the important roads in this country now that are not using the brick arch. As regards location, opinion is divided on that and I believe it always will be. We have two districts, one east of Toledo and one west of Toledo, and the master mechanic west of Toledo would not listen to anything else except keeping his brick arch down next to the sheet, while the master mechanic east of Toledo has the opposite view and all his staff with him. He believes they ought to carry the brick arch back 4 in. from the sheet. Whether it is due to the class of coal we use I do not know, but we are getting good results on both divisions. Equally good, I might say.

We have had some very interesting experiments with the brick arch in smoke prevention in the past three years. We had some engines switching in the Cleveland district that did nothing but handle passenger cars around the station. There was no continuous effort. There was no very hot fire at any time, and we thought we could go a long way in putting a lot of brick in that firebox without getting into trouble, and we covered the whole firebox with brick first, and then took out the two back corner bricks, and ran that engine three or four months. She is the best smoke consumer in the world. There are only two 13 in. x 10 in. holes in the back of the smoke box. I have changed that a little since. We now have three holes. On a switch engine doing short work, where there is no continuous effort and the fire will not be stimulated to an intensely high degree for any length of time, that is a proper installation of brick arch. If you want to save trouble with smoke put all the brick you can in there; just leave an area a little greater than your smoke stack, and you will get good results.

The superheater on switching engines has done more than

was never anticipated for it by the promoters of the device. While you do not get at any time any perceptible degree of superheat above the temperature of the steam as it leaves the boiler, you do, in a properly designed equipment, eliminate practically all of the condensation which takes place between there and the cylinder, which makes a big saving, not only in economy in fuel, but in a corresponding decrease in the amount of smoke that goes out. The Lake Shore is putting it on all standard switch power at the present time. We are equipping 50 engines this year.

I used to be a very strong advocate of the petticoat pipe, but I want to say to all that there is no necessity for a petticoat pipe in the locomotive. We have not a petticoat pipe on a Lake Shore engine, switch engine or any kind, and have not had for the past five years. We are getting along splendidly. In place of the petticoat pipe make your exhaust pass through the center of the smoke stack. That is all that needs to be done to get a good draft.

CARE OF LOCOMOTIVE BRAKE EQUIPMENT

The committee concludes that its paper was intended to deal with such failures of this equipment as might occur while out on the road, and has proceeded under that assumption.

The federal law requires that not less than 85 per cent. of the cars in a train (engine and tender being counted as two cars) shall have air brakes in use by the engineer; also that "all power-braked cars in every such train, which are associated with the said 85 per cent., shall have their brakes so used and operated." Obviously, the foregoing plainly implies brakes that are efficient. While this law makes no provision by which, in the event of any failure that prevents use of the train brakes, the train may be moved beyond the point where this occurred, the fact that this would seriously block traffic has prevented objections to moving such a train carefully and under full control of hand brakes to the next side track, but beyond which, we understand, it may not be taken, with liability of prosecution, until repairs or another locomotive again permit of using the air brakes as required.

This necessarily means that engineers must possess a reasonable knowledge as to how to locate and remedy the causes of the ordinary failures to the locomotive brake equipment that may be susceptible of remedy, in order to prevent delays and the possible tying up of the trains. The engineer who can correctly diagnose the cause of such troubles and apply such remedy as will permit him to proceed within the law and without serious delay to his run, is bound to stand high in the good opinion of the officials of his road.

While a good knowledge of the construction of the air brake equipment and its operation is excellent, a knowledge of what to do in case of trouble with any of its parts is indispensable; more so today than ever, and the teaching of how to render "first aid" to an ailing equipment should form an important part of all air brake instructions.

The air pump, furnishing, as it does, the power that operates the brakes, is naturally the most vital part of the equipment, as its failure to operate means the tying up of the train if out on the road and it cannot be started up again. Its operation is controlled to some extent by the pump governor, which in turn may be responsible for the erratic action or complete stoppage of the pump, and it is therefore particularly important that the engineer should be familiar with the possible defects that can occur in either of these parts, how the governor defects may act on the pump and the means that can be used to perhaps overcome the troubles.

[Most of the probable failures of the equipment on the locomotive were mentioned in the report and the proper procedure for correction or temporary repairs was given.—EDITOR.]

Committee: H. A. Flynn, chairman, T. F. Lyons, F. B. Farmer, L. W. Sawyer, C. M. Kidd.

DISCUSSION.

The general opinion of most of the members was that an engineer should make all efforts possible to repair any breakdown of the air brake apparatus on the road. He should first notify the despatcher or superintendent, giving an estimate of the length of time that he will be delayed and also information as to probability of his requiring help. It was, of course, admitted that every effort should be made to prevent any breakdowns on the road and that the greatest care should be given to the repairs and inspection of the air brake apparatus before the locomotive left the roundhouse. A good plan is to have the air brake inspector make a minute and thorough inspection of the whole apparatus at each boiler washout. Where this plan is followed very little difficulty has been found in keeping the apparatus in good condition.

One of the members explained how many of the breakdowns which frequently cause the locomotive to give up its train can be repaired by a little ingenuity on the part of the enginemen.

On the Erie it is the custom to have a general mechanical staff meeting every ninety days and a staff meeting of the road foremen and superintendents of locomotive operation at the same interval. These meetings last several days. One day is given up to air brake discussion and an expert is invited to address the meeting and answer the questions of the members. Most excellent results have followed this practice.

It seems to be the general opinion that superheater oil was not suitable for use on the air end of the pump and that where it is used, trouble with broken feed valve packing rings and clogged ports is liable to occur. In connection with lubrication it seems that over-doing it is the cause of the greatest trouble. It is not the amount of oil fed but obtaining the minimum amount at the right time that counts. The location of the pump and other parts on the locomotive in a convenient position was also mentioned as a feature which materially affected the making of repairs on the road.

On some roads it is the practice to repair air pumps on a mileage basis. With this scheme the pumps in the different services are allotted a certain amount of mileage and when it has reached its limit, it is removed and sent to the shop for repairs, irrespective of its condition. After being repaired it is subjected to a most severe test which insures its being in perfect condition when again applied.

There appeared considerable difference of opinion as to the advisability of the engineer taking the pump apart on the road in case of trouble. Most of the members, however, seemed to favor the engineer making such repairs and cleaning such parts as may be stuck and seeing that he obtains proper instructions so as to do this properly and promptly.

REMARKS BY E. W. PRATT.

E. W. Pratt, assistant superintendent of motive power, Chicago & North Western, said that the foundation of the locomotive is not always maintained in as good condition as it should be and that it is very largely up to the traveling engineer to follow the roundhouse foreman and see that the best possible work is done. In this connection he mentioned that the Chicago & North Western now has nearly all of its locomotives assigned to regular crews.

In preparing tonnage rating he believes it is best to try it out in practice first and then make the figures and formulas to suit the conditions as found in practice. He suggested that the members in speaking of tonnage rating and discussing the matter with the operating department should be careful not to seem to be trying to underload the locomotive. There is as much objection to underloaded locomotives as there is to overloading.

W. L. PARK'S ADDRESS.

W. L. Park, vice-president of the Illinois Central, pointed out the change that has been made in the position of traveling engineer in recent years. Formerly this position was a sort of a

pension job for an engineer who had given good service. Now, however, it is very distinctly an indispensable position and requires diplomacy, tact and extensive knowledge.

Mr. Park took this occasion of recognizing the work of the supply men for the benefit of the railroad. He stated that not infrequently their work was of the utmost value and that great credit should be extended to them.

The traveling engineer should act, so far as lay within his power, as a publicity agent for the railroad. Railroads are public property. Their stockholders in a majority of cases are people of small means. All employees should give publicity to the real facts of the case, especially in connection with railway legislation and, so far as lay in their power, effect the trend of such legislation toward sensible laws.

Greater efforts should be made to keep trespassers off the line of road as the deplorable showing of the number of people killed and injured by the railroads is principally due to the presence of trespassers who have no right on the property. More influence of a legal nature should be incited to prevent this.

MONUMENT TO MR. CONGER.

A committee was appointed to confer with a similar committee from the supply men's organization in connection with erecting a monument to C. D. Conger, one of the originators of the Traveling Engineers' Association and its president for the first five years. Inasmuch as Mr. Conger was connected with a supply house for a number of years before his death, it seems fitting that the two associations should co-operate in this work.

SUBJECTS FOR 1914.

The committee on subjects suggested for the next convention, committee reports on smoke abatement, efficient locomotive operation, mechanical stokers, and air brakes, with papers on speed recorders, chemistry of combustion, and tonnage rating.

ELECTION OF OFFICERS.

The following officers were elected for the ensuing year: F. P. Roesch, president; Robert Collett, first vice-president; J. C. Petty, second vice-president; J. W. Hardy, third vice-president; D. Meadows, treasurer, and W. O. Thompson, secretary. The new executive committee is as follows: W. C. Hayes, H. F. Henson, Martin Whelan, W. E. Preston, W. H. Corbett, J. R. Scott.

Chicago received the highest number of votes for the next place of meeting.

could be taken. In this way the usefulness of the smoke inspectors was greatly increased. The chief smoke inspectors of each road meet every two weeks and go over the reports submitted during that time, discussing the ways and means of improving conditions and securing uniformity of action. If necessary, a number of inspectors are placed in a territory where the smoke is exceptionally bad to overcome the trouble.

As a means of determining the best possible way in which to reduce smoke from locomotives, the General Managers' Association made a series of tests on various smoke devices; these tests were conducted by the Pennsylvania Railroad on the testing plant at Altoona.* As a result of these experiments it has been recommended to the General Managers' Association that all the locomotives entering Chicago be equipped with the device recommended in the report. From the meeting of the Railway Smoke Inspectors' Association of July 25, it was learned that most of the roads operating in Chicago have already equipped their locomotives with smoke consuming devices, such as steam jets, brick arches, etc.

YEARLY REPORT OF THE CITY SMOKE INSPECTOR OF CHICAGO ON LOCOMOTIVE SMOKE DENSITY.

Railroad.	Summer 1913— Per cent. Density.	Standing	Summer 1912— Per cent. Density.
1 A. T. & S. F.	4.73	2	4.75
2 Illinois Northern	6.31	23	17.92
3 Chicago Central	7.43	4	6.98
4 C. & N. W.	7.43	16	12.94
5 C. B. & Q.	7.74	1	3.51
6 L. S. & M. S.	9.49	9	11.55
7 Soo Line	10.86	24	19.18
8 C. M. & St. P.	11.75	6	9.36
9 N. Y. C. & St. L.	11.9	7	10.53
10 B. & O. C. T.	12.14	8	10.3
11 Michigan Central	12.23	5	8.98
12 Chicago Great Western	13.37	3	5.6
13 Baltimore & Ohio	13.4	25	20.92
14 Wabash	14.12	20	14.89
15 C. R. I. & P.	14.66	15	12.85
16 C. & E. L.	14.73	14	12.47
17 C. & O.	14.78	Not listed
18 C. R. & I.	14.94	21	15
19 C. I. & S.	15.12	13	12.18
20 C. I. & L.	15.63	11	12.15
21 C. & A.	16.56	10	11.62
22 Pennsylvania	16.58	19	14.4
23 Grand Trunk	16.62	17	13.08
24 Chicago Junction	17.01	28	24.84
25 C. & W. T.	17.1	12	12.16
26 Belt	18.06	22	16.87
27 E. J. & E.	18.45	29	31
28 Pere Marquette	18.8	18	13.18
29 Erie	20.51	27	21.76
30 I. H. B.	26.22	Not listed
31 South Eastern	28.23	Not listed
32 C. S. Line	29.23	31	40

The results obtained by this joint association are well illustrated by the annual report of the city smoke inspector of Chicago, which is given in the accompanying table. This inspection was made by six of the city's inspectors over a period of 48 days; there were 11,151 observations made during that time. The table clearly shows the way in which the different roads are endeavoring to reduce locomotive smoke. While the biggest improvement over last year was made by the Illinois Northern, which jumped from the twenty-third place last year to the second place this year, the Chicago & North Western deserves a great deal of credit in moving from sixteenth place to fourth place, as that road operates in Chicago very nearly twice as many locomotives as any other road. The value of such an association to Chicago is very great, and the work of the railroad inspectors is greatly appreciated by the City Inspection Bureau.

CORRECTION

On page 444 of the August issue in the article by C. H. Faris, entitled "Tables for Designing Center Sills" and at the top of the second column, it is stated that $I=P+Ad^2$. The minus sign in this formula should be plus. The correct formula is $I=P+Ad^2$.

*The results of these tests were presented in a paper before the American Railway Master Mechanics' Association at the recent convention at Atlantic City, and were published in the *Daily Railway Age Gazette* of June 14, on page 1377.

RAILROAD SMOKE INSPECTORS' ASSOCIATION OF CHICAGO

According to the United States Bureau of Mines, Chicago stands foremost in the matter of a scientific solution for the smoke problem of large cities. The Smoke Inspection Bureau of that city is composed of 25 inspectors whose chief duties are the inspection of the stationary plants. The inspection of locomotive smoke is looked after by men in the employ of the railroads entering Chicago who co-operate with the city inspector. Each year the city inspection bureau makes a series of observations extending over a period of about two months to determine the progress made by the railroads in the reduction of locomotive smoke. As a means of obtaining concerted action among the railroads in this matter, the General Managers' Association of Chicago appointed a committee, of which H. T. Bentley, principal assistant superintendent of motive power and machinery, Chicago & North Western, is chairman, to investigate the locomotive smoke problem. This committee found that the inspectors in service on the various roads were not able to give the service desired, and in the latter part of 1912 it was decided to pool the services of these men so that wherever they might be it was their duty to inspect the smoke of any locomotive of any road, and make their reports to the local company's smoke inspector and to the General Managers' Association, so that immediate action

INSPECTION LOCOMOTIVE ON THE READING

Characterized by a Boiler of Small Size and Large Capacity and a Large Observation Room.

Ordinarily inspection locomotives are built by simply applying a cab or possibly a new boiler and a cab to an old American type locomotive. On the Reading, however, when it was recently necessary to provide three new locomotives of this type it was decided to prepare a design especially for this purpose and the result is a decided improvement in every particular. The space in the observation room is larger, the size of the firebox insures

effort to handle one or two private cars on a good schedule.

One of the illustrations shows a cross section of the boiler which indicates the efforts that have been made to keep everything as low as possible. The firebox is of the Wooten type and the crown sheet is on a level with the top of the firedoor. Although the height may be very small, the size of the grate is not and an area of 63 sq. ft. has been provided. The usual combustion chamber is arranged ahead of the firebox and the brick wall is used in the normal position. This leaves space for 14 ft. tubes of which there are $180\frac{1}{4}$ in. in diameter, giving 1,154 sq. ft. of heating surface. The dome is so located as to be included in the engineer's cab and could be made as large as was desired. It is $27\frac{1}{2}$ in. in diameter or considerably more than half as large as the barrel of the boiler and measures 34 in. in total height. This will insure dry steam, although it is located directly above the hottest part of the crown sheet. No superheater has been applied. It will be noted in this connection that the crown sheet is very largely supported by sling stays, there being but seven rows of radial stays at the back. Flexible staybolts have been put in the breakage zone on both side sheets. A steam pressure of 225 lbs. is carried on this boiler.



Interior of Observation Room Looking Toward the Rear.

sufficient steam making capacity and the locomotive throughout can be more perfectly balanced, making it easier riding and capable of higher speeds.

These locomotives were designed in the office of the mechanical engineer and were built at the Reading shops of this company. The Atlantic type wheel arrangement was selected in order to obtain the very wide and large grate area desired. The boiler shell has been made very small in diameter so that it fits between the wheels and in fact is so located that the center of the boiler

Underhung spring rigging was necessitated by the relative positions of the frames and boiler shell. This is arranged to be continuous on each side for the drivers and trailing wheels, there being four semi-elliptical springs in each set.

The 18 in. x 24 in. cylinders are separate from the saddle casting and the single bar front rail of the frame is enclosed between the two. 11 in. valve chambers are set $7\frac{1}{2}$ in. outside of the cylinder centers and the outside steam pipe extends from the side of the smoke box, underneath the floor of the observation room to the top of the steam chest in nearly a horizontal line.

The valve gear is of the Walschaert type with the link supported by a casting extending between the two drivers. Owing to the location of the boiler, it is not possible to carry the lift shaft across the locomotive in a straight line. Furthermore, there is no clearance for an upwardly extending arm on this shaft for connecting with the reverse lever. An arrangement



New Inspection Locomotive Designed and Built by the Philadelphia & Reading.

barrel is but slightly above the top of the drivers. A small wash room is provided in the cab and the fittings throughout are heavily nickel plated, giving the locomotive a very attractive appearance. No provision is made for operating the locomotive from the observation room, but push buttons are provided for attracting the attention of the engineer, and there is an emergency brake valve in each front corner of the observation room. While the locomotive normally is operated alone, it has sufficient tractive

has therefore been made whereby the reach rod from the reverse lever connects to the arm on a shaft bolted on the frame just ahead of the firebox. This shaft extends inward to the center of the locomotive where it has a downwardly extending arm to which a bifurcated reach rod is connected that extends to the downwardly extending arm at the center of the lift shafts for each side of the locomotive. This rod spans the axle of the rear driver. The difficulty of finding sufficient clearance for these

has only a guide to keep it in line. The hand wheel is connected to the screw itself by a train of gears which not only increases

is provided for supplying current for the electric lights. One of the illustrations shows the interior of the observation car, giving a good idea of the clearness of vision which can be obtained on all sides.

General dimensions, weights and ratios of this locomotive are given in the following table:

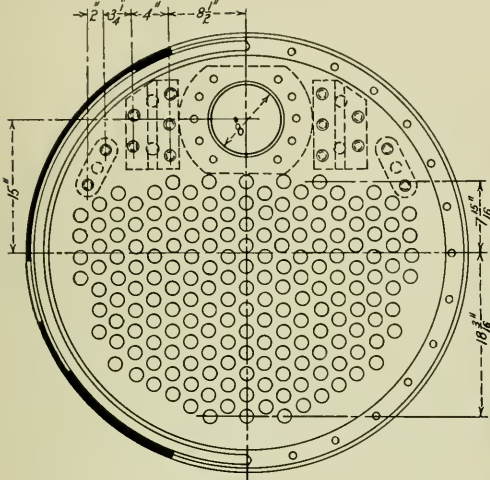

180, 1 1/2" Tubes, 2 3/8" Pitch.

Section of Boiler Showing Arrangement of Tubes.

the leverage of the wheel but also brings it in a more convenient location for handling. One of the illustrations shows the construction of the reverse lever in detail.

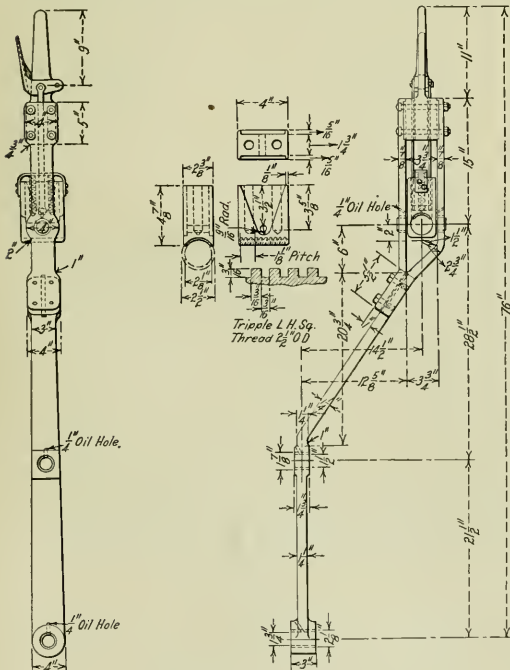

Details of the Reverse Lever.

Ample provision for heating the observation room is made by means of steam pipes under the floor. A small turbo generator

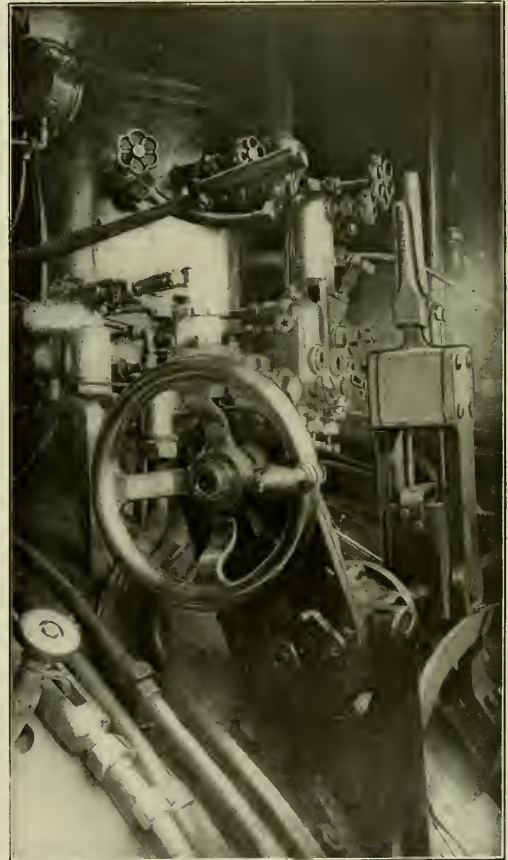

View in Cab Showing Combination Screw and Lever Reversing Gear.

Weight of engine and tender in working order.....	299,500 lbs.
Wheel base, driving.....	6 ft. 6 in.
Wheel base, total.....	24 ft. 7 1/2 in.
Wheel base, engine and tender.....	53 ft. 5 1/2 in.

Ratios.

Weight on drivers ÷ tractive effort.....	5.13
Total weight ÷ tractive effort.....	8.41
Tractive effort × diam. drivers ÷ heating surface.....	1,042.0
Evap. heating surface ÷ grate area.....	20.22
Firebox heating surface ÷ total evap. heating surface, per cent.....	10.61
Weight on drivers ÷ total heating surface.....	77.20
Total weight ÷ total heating surface.....	126.7
Volume both cylinders, cu. ft.....	7.06
Total heating surface ÷ vol. cylinders.....	180.00
Grate area ÷ vol. cylinders.....	8.92

Cylinders.

Kind.....	Simple
Diameter and stroke.....	18 in. × 24 in.

Valves.	
Kied	Piston
Diameter	1.11 in.
Greatest travel7 in.
Outside lap	1.33 in.
Inside clearance34 in.
Lead93 in.

Wheels.	
Driving, diameter over tires68 1/2 in.
Driving journals, main, diameter and length8 1/2 in. x 1.2 in.
Engine truck wheels, diameter33 in.
Engine truck, journals5 1/2 in. x 1.0 in.
Trailing truck wheels, diameter4234 in.
Trailing truck, journals7 in. x 1.2 in.

Boiler.	
Style	Wooten
Working pressure	225 lbs.
Outside diameter of first ring46 in.
Firebox, length and width	1.08 in. x .84 in.
Firebox plates, thickness3 in.
Tubes, number and outside diameter	180-1 1/4 in.
Tubes, length	1.4 ft.
Heating surface, firebox	1.154 sq. ft.
Heating surface, total	1.274 sq. ft.
Grate area	63 sq. ft.

Tender.	
Frame	12 in. channel
Wheels, diameter36 in.
Water capacity	6,000 gals.
Coal capacity	9.75 tons

AIR SANDER FOR INTERURBAN CARS

BY F. G. LISTER,

Mechanical Engineer, Oregon Electric Railway, Portland, Ore.

A. C. Adams, superintendent motive power of the Oregon Electric and the United Railways, has designed and had in operation for over a year on all of the passenger motor cars of those roads, a simple and very efficient air sand rigging which is shown in the illustrations.

A large sand box, made of No. 14 iron and having a sloping bottom, is provided in the cab or vestibule of the car. The sand drops by gravity from the sand-box through a 1 1/4 in. iron pipe into a trap made of a 1 1/4 in. x 1 in. standard pipe cross, which is closed on the bottom with a 1/4 in. pipe plug; the plug can be easily removed in case the trap becomes clogged. Air is admitted to the trap from the whistle pipe through a 1/4 in. pipe into a horizontal nozzle which extends about three-fourths of the way through the trap. The admission of air is controlled by a globe valve close to the motorman's brake valve. From the trap the sand is blown through a 1 in. pipe which connects to a 1 1/2 in. air hose 36 in. long, providing for the swing of the truck. The bottom end of the hose is fitted with a nipple which connects through a street elbow to a 1 in. x 1 in. pipe cross where the sand is separated by means of a wedge-shaped plug in the bottom of the cross. The separated sand goes to each leading wheel

through 1 in. pipes, bent to deliver sand to the rails directly ahead of the wheels and securely fastened to the truck frame.

This sand rigging is made in the company's shops and in

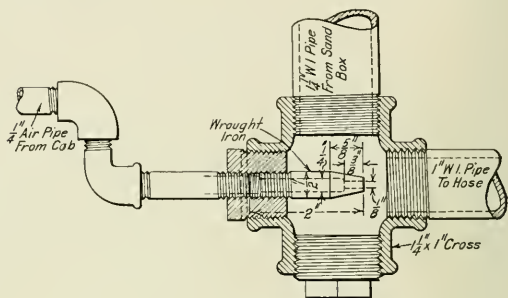

Sand Trap for Air Sander on Interurban Cars.

the entire time that it has been in operation there has not been a single case where sand did not flow freely to the rails. An over-supply of sand cannot feed into the trap, nor has any trouble

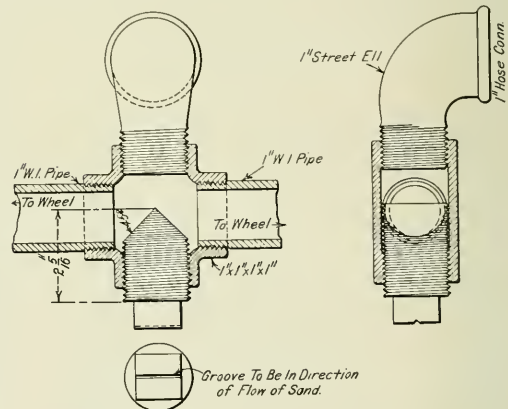

Sand Separator for Air Sander on Interurban Cars.

been experienced from sand blowing back into the sand box. Sharp, clean sand is used, and is thoroughly dried in a sand dryer located at the Portland shops.

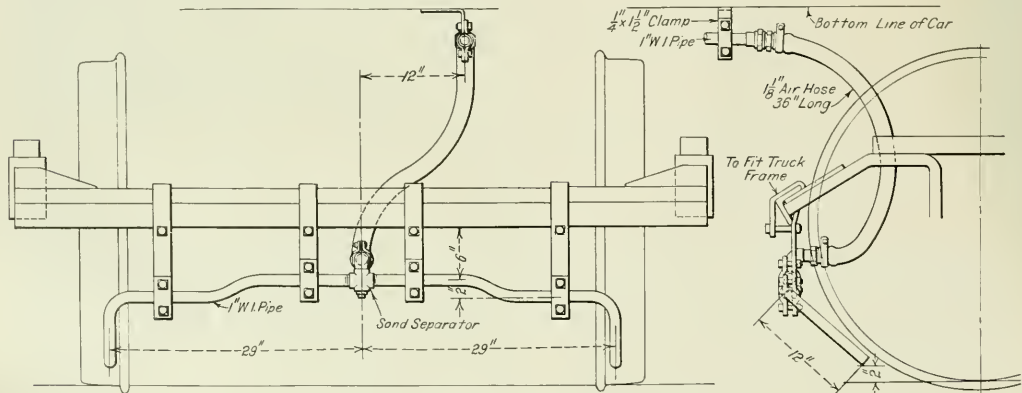

Arrangement of Pneumatic Sander Rigging on the Truck.

SHOP PRACTICE

PAINT SHOP AT SEDALIA

The most impressive features of the Missouri, Kansas & Texas car paint shop at Sedalia, Mo., are the generous allotment of space for this work and the neat appearance of the shops. All the departments are carefully laid out under one roof, two adjoining buildings being used for that purpose. The main paint shop is laid with a concrete floor, and is especially well lighted, having

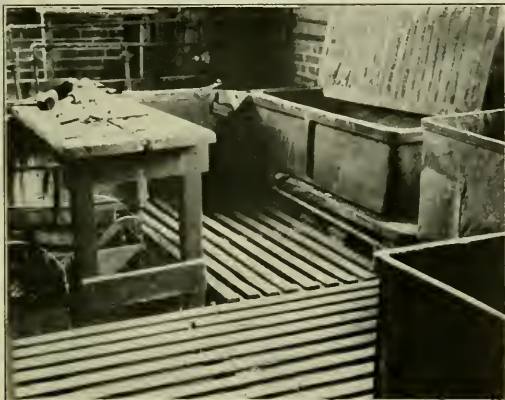

Lacquer Room with Tanks for Cleaning.

a capacity of 35 to 45 cars a month. A doorway in one end of this building connects to the second building, which is two stories high. The lacquer room is located in one corner and is shown in one of the illustrations. The floor of this room is covered with a grating for the men to stand on. All the brass fixtures are cleaned here. The tank in the lower right corner



Silvering Room and Chemical Testing.

is filled with lye for removing the grease and old lacquer. The next tank, of which only one corner shows, is filled with hot water for thoroughly rinsing the material as it is taken out of the lye bath. The third tank is filled with an acid bath made up of equal parts of soft water, sulphuric acid and nitric acid, to which is added 5 per cent. of a saturated solution of sulphate of

copper and 5 per cent. hydrochloric acid. The material taken from this tank is immediately washed in a tank of flowing cold water. It is then dipped in flowing hot water to which has been added a little sal soda to neutralize any acid that may remain on the material. After thoroughly drying the material with a cloth it is dipped in a first class lacquer.

Another interesting feature is the storeroom, as is shown in the illustration. The different tanks are conveniently arranged about a concrete mixing table $4\frac{1}{2}$ in. thick, 3 ft. 4 in. wide and 16 ft. long, supported on eight legs of $1\frac{1}{2}$ in. pipe. The picture was taken directly over the counter.

The electroplating room is also located on this floor. This



Store Room in the Paint Shop.

room is very well arranged and is equipped for copper, nickel, silver and brass plating. The tanks are lined with $\frac{3}{4}$ in. glass, concrete being placed between the wood and the glass. A motor generator set operating at 220 volts and delivering at 6 or 8 volts with 100 amperes is used for the electroplating.

The second story of this building is devoted to the glass work, all the designs in frosted glass used on the M. K. & T. cars



General View of the Main Shop.

being made at Sedalia. The silvering room is shown in the photograph. The further table is made of concrete, being pitched toward the center and grooved as shown, so that it may be readily drained. Steam pipes extend through the body of the table, which is 4 in. thick, to heat it to the necessary temperature for silvering. It is supported by iron pipe legs screwed into flanges

on the floor to allow for adjustment when the table gets out of level. This room is also used for chemical testing. There are two other rooms on this floor, one for etching glass and the other a dark room for printing the designs on the glass. The acid or etching room is lined inside with painted cloth to prevent the fumes of the hydrofluoric acid used in the etching process permeating the walls. The acid tanks are lined with lead.

Another interesting and profitable adjunct to the paint shop is the roof board dipping plant. The boards are put in one end of a paint trough through rollers, which force them along through 12 ft. of paint to the other end, where they are drained. This plant will dip 1,200 ordinary freight car roof boards an hour and will use about 2¾ gals. of paint to about 300 boards. The rollers are operated by a 2 h. p. motor.

TURNING ECCENTRIC STRAP LINERS IN A BORING MILL

BY V. T. KROPIDLOWSKI.

The new design of locomotive eccentric strap, which utilizes a brass liner for the wearing surface of the eccentric, has made it a serious problem to finish the liners speedily and accurately. To overcome the difficulty a chuck and centralizing box, which are shown in the illustrations, have been developed.

Fig. 1 is a half side view and half sectional view and Fig. 2 is a top view of the chuck. A pattern is necessary, unless a suitable casting can be found for the body *B*, the other parts are easily made from material available around the shop. First, the stem *A*, of wrought iron, is turned 3 in. in diameter and threaded; the body *B* is then bored out and the stem *A* pressed

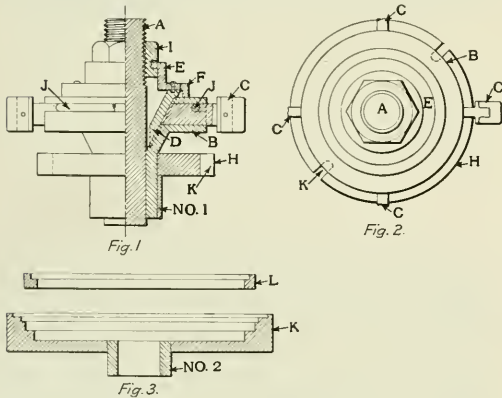

Chuck and Centralizing Box for Turning Eccentric Strap Liners.

into it. The body is then bored to a suitable taper, so that a short range of movement of the taper sleeve *D* adjusts the jaws *C* for the various sizes of liners. The brass ring *E* is fastened with tap screws to the taper sleeve *D*, and its upper lip fits loosely in a groove cut around the nut *I*. By turning the nut *I* the sleeve *D* is raised or lowered by means of the connection of the sleeve to the nut through the brass ring *E*. The spring *J* pulls in the jaws *C* when the sleeve *D* is raised. The extension, No. 1, is made to fit the center hole of the boring mill table, and the chuck is fastened to it by bolts inserted in the slots *K*, in the wrought iron ring *H*, which is pressed onto the body *B*.

Fig. 3 is a sectional view of the centralizing box. Steps are turned on the inner side to receive the different sizes of liners after they are turned on the outside on the chuck. The liners are turned on the outside to fit the different sizes of straps, which are not subject to wear and, therefore, are fixed for all

time, and for this reason the steps inside of the centralizing box *K* can be turned to the standard diameters of the liners. The ring *L* is to accommodate a size for which another step in the main body *K* could not be cut. By the use of these tools it has been possible to finish, complete, one liner per hour at a cost for labor of 41 cents.

HAMMER FOR REMOVING SIDE ROD BUSHINGS

At the Norfolk & Western roundhouse at West Roanoke, Va., a simple arrangement is used for driving in and removing side rod brasses. This is shown in the illustration and consists of a pair of iron guides running between the floor and the ceiling. A crosshead, consisting of two iron plates, bolted together, operates on these guides and holds a discarded crank pin, which acts as a hammer. This hammer is directly below

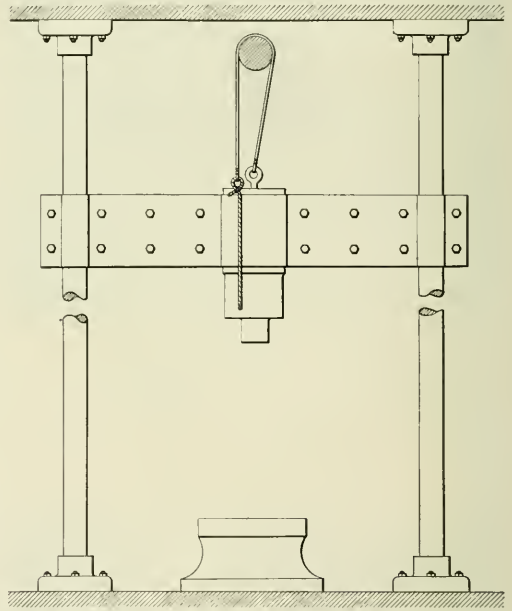

Hammer Raised by the Friction of a Belt on a Revolving Shaft.

a line of shafting and a belt passes from the hammer over the shaft with a piece of rope on the end. In order to raise the hammer the rope is tightened by pulling slightly on it and the friction of the belt raises it. When at a sufficient height the tension on the rope is released and the hammer drops, striking the brass in the rod, which is supported on an anvil below.

SHIP BUILDING ON THE CLYDE.—During the first six months of 1913, the Clyde shipbuilders built 127 vessels, aggregating 348,470 tons, which is the largest output on record, exceeding the next largest output, that of the first six months of 1906, by over 12,000 tons.

SARATOGA AND SCHENECTADY RAILROAD.—The receipts on this road during the last week were between six and seven hundred dollars. This, considering the very small number of strangers who have visited the Springs, is very handsome and indicates with much certainty the future prosperity of the road.—From the *American Railroad Journal*, September 8, 1832.

MASTER BLACKSMITHS' ASSOCIATION

Richmond Convention Included Papers on Flue Welding, Spring Making and Electric Welding.

The twenty-first annual convention of the International Railroad Master Blacksmiths' Association was held at the Jefferson hotel, Richmond, Va., August 19-22. President McSweeney called the meeting to order at 10:20 a. m., August 19, after which George W. Kelly led in prayer. W. W. McLellan in a brief speech introduced Governor Mann of Virginia, who addressed the association, welcoming them to the state. Governor Mann was followed by Mayor Ainslie of Richmond, who gave the members the freedom of the city. Addresses of welcome were also made by the president of the Chamber of Commerce of Richmond, by W. D. Duke, assistant to president, Richmond, Fredericksburg & Potomac, and by the Rev. J. T. O'Farrell. On Wednesday a short address was made by W. H. Owens, master mechanic, Southern Railway, Manchester, Va.

FLUE WELDING.

E. J. Haskins (L. S. & M. S., Elkhart, Ind.):—Flue welding and swedging at Elkhart is handled in the blacksmith shop. We have two flue rattlers, one of which is 23 ft. long and one 18 ft. long. These rattlers run about 15 revolutions a minute with a load of about 200 2-in. flues. The 2-in., 2¼-in. and 3-in. flues are cleaned in these rattlers from two to four hours, depending on the amount of scale. The flues, after leaving the rattler, are cut off at the firebox end with a cutter operated by compressed air and having two rollers below with a rotary beveled cutter above. They are then placed on an incline and rolled to a rack near the furnace, where they are heated, the ends belled out on a



Flue Swedge Used on the Oregon Short Line.

horn and the safe ends applied; they are then piled on a rack convenient to the welding furnace; one man swedges and welds flues of the three sizes.

After welding, the flues are skidded to racks outside the building, on account of the limited room in the shop. The flues are brought from the rack outside to the hot saw oil furnace, where they are heated and sawed to the proper length on the hot saw. The operator of this saw takes his own measurements from the boiler to determine the length of the flues. They are then placed upright in a pit for the annealing of the ends. Any defects may be readily seen, as the flues are cut while heated.

Five men in the flue department handle from 6,000 to 8,000 flues per month. We use the Ferguson oil furnace and the Draper pneumatic welder and swedger. All the flues are tested on a hydraulic testing machine with 300 lbs. per sq. in. pressure. As some of our flues have four or five welds, we consider it a paying proposition to test them, as we find a number of defects with this method, most of them being in the old welds.

Scarf ends are made from new stock. In cutting them off we leave a scarf on the safe end of about ¼ in.; we heat the end of the flue and bell it on a horn. A safe end is then inserted in the usual manner and set down ready for welding. With this method we obtain a maximum amount of stock around the part of the flue to be welded, which holds the welding heat until after the two parts are welded together. We are able to weld successfully steel on steel, or steel on iron. When bringing a flue up to a welding heat great care must be exercised to heat it uniformly, not too rapidly, and to be sure and not overheat the steel safe end. Unless the operator is very careful he will endeavor to bring the iron flue up to the proper temperature for welding, which will overheat the steel flue, making it brittle and resulting in flues breaking in service, the fracture usually taking place just forward of the weld and through the steel portion.

In the erecting shop the pits are so short that large superheater flues cannot be removed from the modern boilers without opening the erecting shop doors. To prevent cooling the shops in winter and to provide a special platform for applying superheater elements and the large tubes, we have designed special cars that fit in the door openings. They serve the purpose of a door and also a very convenient platform for the workmen in removing or applying the superheater units and the large tubes. The superheater flues of 5¼ in. and 5½ in. diameter are cut off, removed from the boiler and placed in the cars. The firebox ends are cut off square by a machine located in this car, and the flues are then brought to the blacksmith shop, to be cleaned and welded. We place about 17 of them in the rattler and mix with them 125 short flues of 2 in. diameter; from three to four hours in the rattler cleans them sufficiently. We use safe ends about 6 in. long with an abrupt scarf on one end. The flues are taken from the rattler to the oil furnace, heated, belled out with full thickness of metal and the safe ends applied. The flue is then put back in the furnace, brought up to a welding heat and welded on a 200-pound Bradley belt driven hammer, for which we have constructed a special mandrel and die. We use three men for this operation, a flue welder and two helpers. We do not test any superheater flues welded in this way under the Bradley hammer. Out of the 25 sets of flues so welded we have lost only two flues on account of leaks in the welds. We apply safe ends on large flues with a lap of 5⁄8 in. before welding. This provides ample stock, and after it is closed and worked under the heavy Bradley hammer it makes a perfect weld. We also swedge superheater flues of 5¼ in. and 5½ in. diameter in this same manner, averaging about 11 large flues per hour, welding and swedging.

Fred B. Nielson (Oregon Short Line, Pocatello, Idaho):—It is of more importance to swedge the flues than to weld them. Our superintendent of motive power took the subject up with me to find some way whereby the flues could be swedged without hammering the scale over them, as I am positive even by having the air blowing on the swedge, a certain amount of the scale drops down on the bottom of the swedge and the result is that a certain portion of it is hammered into the flue. In order to overcome this we made a swedging machine operated by compressed air, practically of the same construction as a bolt machine, and have had good success with flues since installing it. The dies are grooved to hold the old flues, which are sometimes a little smaller than the new ones. We have never tried to swedge any superheater flues with the machine, but I am sure it will do the work.

George Massar (C., N. O. & T. P., Ludlow, Ky.):—We repaired 625 superheater flues from January 1, 1913, to June 1, 1913.

We converted our 2½-in. roller machine so the change can be made in 20 minutes to weld 4½-in. or 5½-in. safe ends on superheater flues by changing the mandrel and using the same rolls that are used for welding 2-in. or 2½-in. flues. For swedging them down from 5½ in. to 4½ in. for welding on safe ends, the welding rolls are taken off and taper rolls put on, using the same mandrel that is used for welding. Our flue furnace is so arranged that the change can be made in a very short time from welding superheater flues to the 2-in. size. Instructions have been issued by the superintendent of motive power not to have more than one weld on superheater flues at one time. In order to do this, the flues must be cut off close to the front and back end of the flue sheet to have as little waste as possible. The flues are cleaned in a rattler, taken to the cutting off machine, cut off and scarfed on the inside with a reamer 1¼ in. taper to 3 in., making the scarf 5½ in. long. The safe ends are chamfered on the outside with the same taper. The cutting of old welds, reaming and chamfering safe ends is done on one machine by changing tools. In welding, the safe ends are put on the mandrel cold; the flue is then heated and forced on, this making a neat scarf, as both have the same angle. The flue is then put in the furnace to be welded; when the proper welding heat is produced it is then bumped up, taken out and welded under the roller machine. We use charcoal iron safe ends, No. 10 gage, cut to suitable lengths so as to allow but one weld in each flue. This can be done by first welding on a 5-in. end, second 8 in., third 11 in., fourth 15 in. We have three men on the job, and they average from 10 to 12 flues per hour; they have welded 103 in eight hours. The flues are not tested before being put in the boiler, and we have never had a complaint from the foreman boiler maker.

TOOLS AND FORMERS.

John Carruthers (D. M. & N., Proctor, Minn.) :—We have but one forging machine in our shop, and have to use it for both light and heavy work; I think it a good idea, when there is but one machine in a shop, to have a large one, because light work can be done on it, but heavy work cannot be done on a small machine. For instance, we make 5½-in. grab irons on a 3-in. machine, one end in one heat; these are upset, punched and bent ready to go on the car after two heats.

We started to rebuild a number of cabooses, and needed a lot of pieces bent in various shapes; I had no bulldozer, so had to make one. I obtained a cylinder 19 in. x 24 in., and some rails and made an air-driven machine which does the work very well. We can bend 6 in. x 1½ in. material, and we also bend drawbar pockets with it.

It is possible to make too many tools. I mean that we can make tools for work that will not pay for the making, because there are not pieces enough to make. It will not pay to make a tool for a machine to make about twelve articles once in six months; it would be cheaper to make them by hand.

Material for dies and punches depends a good deal on what kind of forgings are to be made; we have them made of cast iron, carbon steel, axle steel, tire steel and some cast iron with steel faces. We make most of them of air hardening steel, which we find is the best for punches, as we have them from 3/16 in. to 1½ in. round. We punch all of our brake hanger pins and brake rod pins with a round punch, which I find is cheaper than drilling them.

Chas. Popisil (Union Pacific, Omaha, Neb.) :—I believe that there are times when it pays both the foreman and his company to make tools or formers for one job only. I had an example of this at Omaha when a man came to the general foreman with a broken manhole plug. He was referred to me and I got a bar of square steel and made a ring the size of the manhole. After I had the proper ring or former made, I took a piece of soft steel large enough to cover the former, heated it and dropped it under the steam hammer, trimmed the surplus off, put the proper radius in and had the holes drilled.

Discussion.—J. E. Carrigan (Rutland Railroad, Rutland, Vt.) :—I find we are apt to make a mistake in punching holes. We have got to leave quite a little clearance in the back die for the punch to pass through, as much as with the ordinary punching shears; if we don't we will break every punch we put in. If there isn't enough clearance behind, it will break the end out. I do not use any particular method in hardening my punches. I punch 3/16 in. x 13/16 in. slotted holes in a ¾-in. round, and I have punches that have made thousands of these.

H. E. Gamble (Penna., Altoona, Pa.) :—We had to set a number of splice bars with a big pad. It is impossible to do it on the anvil, and it is an impossibility to get up dies for it. I took two pieces of rail the size of the splice, left them apart ¼ in. or ⅜ in. and put them on the press. I built the splices on the rail and I made a perfect job out of No. 100 splice. I do not believe it would be possible to set one of these splices by hand.

Alex. McDougal (B. & A., Milo Junc., Me.) :—When I came to the convention I was instructed by my superintendent of motive power to find out a good scheme for making main and side rod keys without planing them. The only tool I have to work on is a steam hammer.

T. E. Williams (C. & N. W., Chicago, Ill.) :—We shear them off in the blacksmith shop. The body of the key is cold rolled steel bought the right size, and it is sheared off the right size.

G. L. Gay (A. C. L., Rocky Mount, N. C.) :—We order the steel the size we want it, cut the keys off in the cold saw or shears and put them on the milling machine; a great number are milled at a time, and we find this the cheapest method.

ELECTRIC WELDING.

Joseph Grine (N. Y. C., Depew, N. Y.) :—In common with many others, our first experience with electric welding was very disappointing and failures were so many that at one time we came pretty nearly giving up the process entirely. With the discovery of an error in the adjustment of our machines, and its correction, marked improvement in results were obtained at once. We have two electric welding outfits, which have been operated day and night since May, 1912. At one of our shops 102 broken locomotive frames located in all varieties of places and on all sizes of power have been welded, and so far without a single

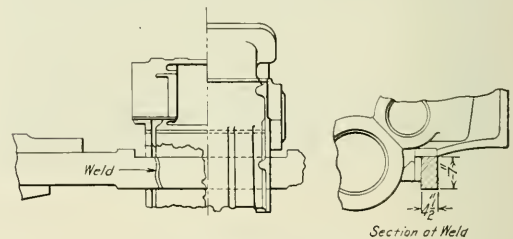

Frame Scarfed Through To Cylinder and Welded From Inside.

Frame Welded by Electricity at the New York Central Shops at Depew, N. Y.

failure; we believe it the easiest and cheapest method of welding frames without removal from the locomotive. There is no expansion or contraction to contend with in making such welds, and after completion the frame is in its original position. There is also a minimum amount of stripping needed.

In frame welding the machines are adjusted to work at 147 amperes and 60 volts. The frames are prepared for welding in a similar manner to that for welding over a fire. They are "V'd" out by means of the oxy-acetylene machine, the oxidized surface left by the burner being then chipped off by an air hammer and chisel so that a clean surface is presented for the electric welder.

The following is the total cost of welding frames of three different dimensions:

Frame 5 in. x 5 1/2 in.	
Labor	\$5.63
Material	3.38
Total	\$9.01
Frame 4 in. x 4 1/2 in.	
Labor	\$4.01
Material	2.51
Total	\$6.52
Frame 4 in. x 2 1/4 in.	
Labor	\$3.03
Material	1.95
Total	\$4.98

This includes the oxygen used to prepare the frame, wire necessary for welding, as well as the cost of the current used.

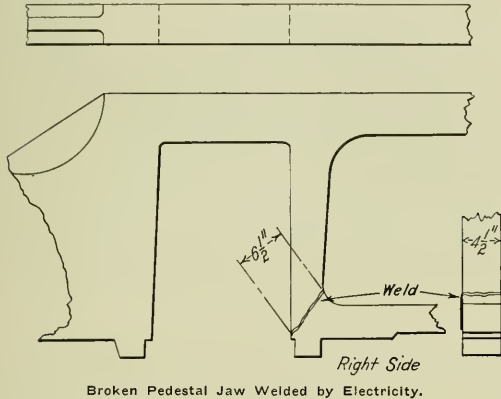

It is very rarely that we have to take down a frame for welding purposes. The process is also being put to many other uses besides frame welding, such as welding firebox cracks and patches, welding flues in the sheets, filling in wasted spots about boilers or fireboxes, filling in worn motion work, filling in frames that have been chafed by spring hangers, plugging holes of all

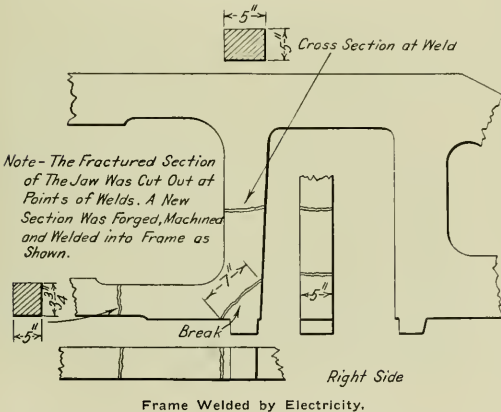

descriptions, welding mud ring corners, etc. As an illustration of its utility on firebox sheets, there have been made at the shop referred to 201 firebox welds with only seven failures, or less than four per cent., and those that did fail had an average life of 58 days before so doing.

Another item of saving effected by the process during the past

winter is the filling up of flat spots on 46 locomotive driving wheel tires, these spots running in length from 2 1/2 in. to 4 1/2 in. It would, of course, have been necessary to turn these tires had it not been for the electric welder.

DROP FORGING.

F. P. Diessler (Bessemer & Lake Erie, Greenville, Pa.) :—We make a number of drop forgings by making two blocks of steel, top and bottom, with pins at the sides to act as guides. We make a reasonably smooth pattern of what we want, forge two blocks of steel and sink the pattern two-thirds of the depth in each one. We then take these blocks to the machine shop and face them so as to make the impression one-half the depth in each block, and also plane or mill 1/16 in. deep around the edges, and 1 1/4 in. from the impression for splash. After the dies come from the machine shop we harden the faces and block out or bend the stock to suit the work; we then take a good heat, open the blocks, insert the stock and strike one good blow under the steam hammer. The top block is then lifted and the piece taken out. We try to do this work with one blow, as the tools will last longer, because otherwise the fin chills quickly and dents the edges of the tools. We make trimmers to trim off the fin; this is done cold by making blocks of steel the shape of the work, with clearance from top to bottom, so as to clear when driven through under the hammer. By this method drop forging dies can be made very cheaply and they will do a lot of work that will answer the purpose, and do it quickly. I believe that all shops should have at least one drop hammer, as that is the only way to do this work properly.

H. E. Gamble (Penna., Altoona, Pa.) :—We have a 12,000-lb. steam drop hammer from which we have produced some fine forgings, weighing from 100 to 300 lbs. The dies made for this hammer must be large and well heat-treated to withstand the blows. The larger the hammer, the more roughing out is required from the forge shop. The trimming press used for this hammer is operated by hydraulic power and has a capacity of 200 tons.

G. F. Hinkens (Westinghouse Air Brake Co.) :—The secret of drop forging is in making the dies, and the secret of the die is in making the preparatory part so as to get the stock in the right place before placing it in the finishing die. There is a great deal of skill required by the die maker. I do not think that the ordinary machinist, until he has the experience, can make a die for a drop forging from a blue print or from a model unless he is instructed by somebody who knows how the die ought to be made.

The next important thing is the hardening of the die. Drop forging dies are very expensive, and the cost of the work depends on the number of pieces that can be made by the die, which will range probably from 1,600 up to 40,000, depending on the shape of the forging. We harden all our dies by a special method; they are all tried for hardness.

MANUFACTURING TRUCK TRANSOMS FOR PASSENGER COACHES

George Fraser (A. T. & S. F., Topeka, Kan.) :—The manufacture of wrought iron transoms for passenger coach trucks is a very difficult operation, in the absence of a suitable forging machine capable of forming the transom ends from solid material. A forging machine suitable for such heavy duty requires so large an investment that it is inadvisable to have such equipment where transoms are made in small quantities. Forging a transom of this design in the usual manner by means of the steam hammer and anvil makes the production cost prohibitive and renders it necessary for these parts to be purchased from the builders of coach trucks.

The problem has been very satisfactorily solved at the Topeka shops of the Atchison, Topeka & Santa Fe, by means of dies for use under the ordinary steam hammer. The details of the opera-

tions are shown in the accompanying illustrations. The two parts of the transom end are punched out separately under the steam hammer. The foot is a piece of bar iron bent at right angles with a square hole and lip to assist in the welding operations. The web is punched from plates of the required thickness with



Two Parts of a Coach Truck Transom After Being Formed with Dies Under a Steam Hammer.

the assistance of the die in position under the steam hammer. The two parts are assembled by inserting the lug on the web through the square hole in the foot and riveting it over slightly to hold the parts firmly together. The parts thus assembled are placed in the furnace and heated sufficiently to be welded together with one operation under the steam hammer.

The die parts are held in position by keys through the cross-bolts, which facilitates the assembling and dismantling for weld-

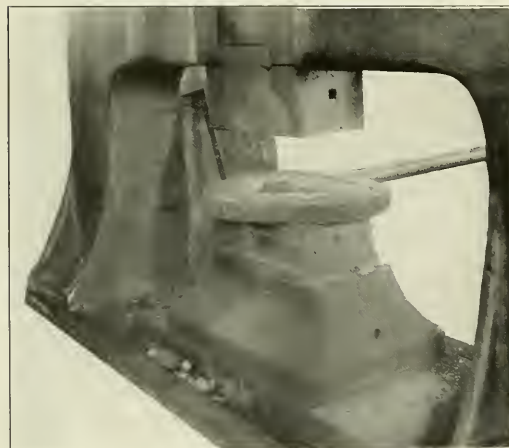

Die in Position for Punching Out the Main Part of the Transom End.

ing purposes. When the parts assembled are sufficiently heated in the furnace, they are placed in position in the die and the welding is completed by several strokes of the plunger. After the transom end leaves the die, the forming has been so well accomplished as to render unnecessary any further dressing or trimming. After the ends have been formed they are welded to the crossarm in the regular manner on the transom.

SPRING MAKING AND REPAIRING.

G. M. Stewart (Penna., Altoona, Pa.):—The spring business has taken the same forward movement that all other industries have, leaving the old hand practice behind and resorting to ma-

chinery, the demand for springs now being so great and the need of uniform and dependable work so obvious. There is no question but what spring making has reached the highest point of efficiency possible with the aid of the human eye, but with the use of the pyrometer and machinery, it is possible to turn out more work and have it much more accurate than by hand practice.

One of the machine manufacturing companies is now making a machine for manufacturing springs, to be used by one of the large spring makers at Pittsburgh. There has been installed in one of the Pennsylvania shops a machine for making springs which has proven a success, not one failure having been found in the making and adjusting of 2,000 plates recently turned out.

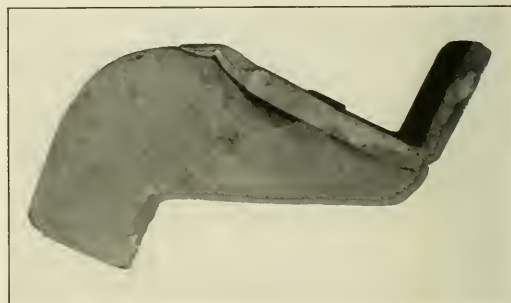

Parts of Coach Truck Transom End Assembled for Welding.

This machine shapes the plates properly, the pyrometer being used to get the correct temper, and all the plates being exact duplicates. It also shows a saving of not less than 30 per cent. in the cost of production. I may be somewhat premature in saying that elliptical springs will sooner or later be made by machinery, and without the use of a hammer, but in a number of shops this method is now in every-day operation and has resulted in a decided saving and a better spring. An objection may be raised to the machine method on account of the large number of designs of springs generally made or repaired in railroad shops. To induce the designing engineer to change designs will take time. However, if it can be shown that a superior

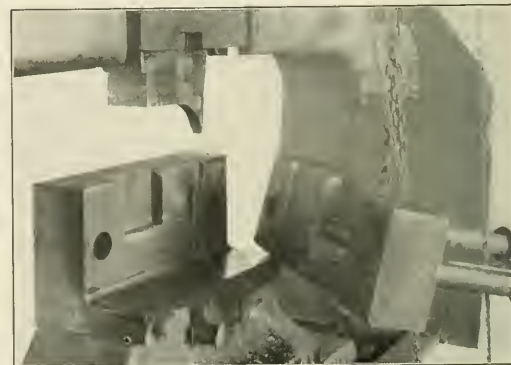

Die and Plunger for Welding Transom Ends.

spring can be made at lower cost, the question of providing the proper machinery will at last receive careful attention, and we may also hope to see a number of springs, differing only slightly, eliminated.

A number of methods of manufacturing elliptical springs by machinery are now employed. All that I am familiar with do

this work in a hydraulic press or a bulldozer. Two methods of bending the leaves have been called to my attention. By one of these a number of fingers set close together like piano keys are employed; these are set to the desired radius by cams or by bolting each finger separately. When these are set the working surface looks like a piano keyboard bent to the shape of a spring. When forming the spring plate it is pressed between two of these keyboards, or one keyboard and a second set of weighted fingers, where each finger has a separate weight. The hot leaf

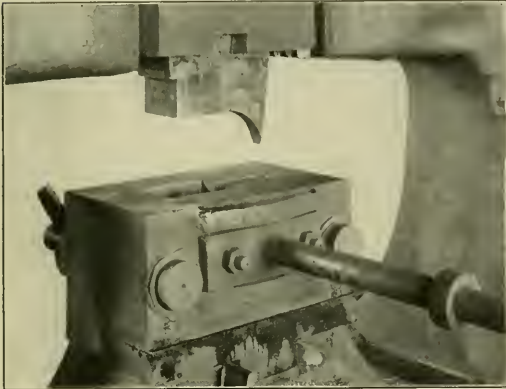

Dies Assembled for Welding Transom Ends.

is placed on the keyboard and is forced against the weighted fingers, raising each according to the camber. This method looks promising, especially where a large number of designs are required. Another method employed is to use dies, or dies and easily-made liners, for each radius of spring leaf. This requires a number of die liners, but when once made they will last for an indefinite number of leaves. By this method the leaf is pressed while hot between two dies, either in a hydraulic press or bulldozer. Either method will make elliptical spring leaves more uniformly than by hand setting.

For the large elliptical springs, such as are used on locomotives



Transom End After the Parts Are Welded.

and cars, the taper put on the leaves is rarely correct, and if properly made it should only extend back from the end about one inch. As a matter of fact the leaves are tapered back two or three inches, and as a result the taper of one leaf extends over the taper of the leaf above, so that the object of tapering is defeated. Some railways have done away with tapering spring leaves, which is a step in the right direction. In some cases the leaf is square at the ends as it leaves the shear when cut from

the bar, and in other cases the corners are clipped off, making the end of the leaf look like a spear with the point cut off. Either method makes a good looking spring, and saves the cost of heating the ends for rolling the points. I believe that the tapering machine could be put on the scrap heap, as has been done in one shop that I know of. Omitting the tapering of the leaves makes it much easier to form by dies, as it is difficult to make dies to fit the tapered ends.

There is a method of manufacturing elliptical springs in which a hydraulic press is used. This is a double or two-story press; that is, one press above the other, each controlled by three rams of 25 tons capacity each; by suitable valves 25, 50 or 75 tons pressure may be used, according to the size of the leaf. In the bottom part of the press the end corners of the leaves are clipped off and the nib formed at the center; in the upper half the leaf is formed to the proper radius or camber. Following the leaf through, the process is as follows: The leaves are cut to the proper length, placed in the furnace, and the ends are then cut and the nibs formed in the lower part of the press. Next, the leaf is formed to the proper camber in the upper part of the press, the third and fourth operations being made with the one heat. It is then allowed to cool, and next is heated to 1,500 deg. F. and quenched in oil; it is then heated to 800 deg. F. and allowed to cool in air.

In every-day practice two men can easily cut, nib and form 600 leaves in a ten-hour day. To change from one length of leaf to another takes about 15 minutes; to change from one kind of spring to another takes from 15 to 30 minutes.

Probably no piece of steel is hardened by a much worse method than the locomotive spring. No blacksmith would think of hard-

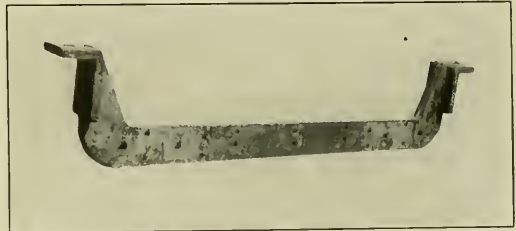

Coach Truck Transom Complete.

ening a lathe tool in the crude method used in hardening springs, yet with the heavy equipment of today, the spring must stand much abuse. In a number of shops the following is the practice: First, the leaves are formed and allowed to cool off; second, the leaves are heated in a furnace to about 1,500 deg. and quenched in oil; third, they are drawn to about 800 deg. F., taken out and allowed to cool slowly in air. Recording pyrometers showing the temperature, are used on all furnaces; by this method the foreman can keep a record of the temperature. Heat treatment will add from one to two cents to the cost of each leaf, but it is well worth the money, as failures of heat-treated springs are very rare.

As an illustration of what may be done by machine forming and heat treating, by actual practice, 18,000 leaves were handled by this method and not one was broken or failed in a test. Experience indicates that there will be a saving in repairs to heat-treated springs.

Vanadium steel has proven quite an advance; but if it is attempted to harden it by the hit or miss method that has been the practice for spring work, trouble may be looked for. Vanadium steel springs must be properly heat treated and all others should be. Insist on having pyrometers on all furnaces in which springs are heated and see that they are in order.

Discussion.—J. Carruthers (Duluth, Missabe & Northern, Proctor, Minn.)—I have had considerable experience with

vanadium steel for springs. We had some large locomotives with trailer springs that were giving considerable trouble, for the simple reason that we did not know how to use vanadium steel. We take the springs, cut them off and do the preliminary work, then place them in the furnace, which is brought up to 1,650 or 1,700 deg. F. We take the temperature in the furnace with a water pyrometer.

In making trap door springs for coaches we bring the steel up to 1,700 deg. and form it; when it is formed, we put it in oil to cool. It is then put back in the furnace and brought up to 1,450 deg., and it is then taken out again and put into oil; it is next put in a tin bath, which is brought up to 975 or 1,000 deg., so that it shows a dark red.

We treat the carbon steel springs the same way, but we do not get the same results.

PIECE WORK

Geo. P. White (M. K. & T.):—Piece work enables a foreman to estimate the cost of work and length of time that will be necessary to prosecute such work within a very small margin, for the workmen are after the money and know that it depends upon what kind of a day's work they put out, as to the amount of wages they will draw. For instance, we have 500 of a certain class of car to build. Knowing that our material is in stock and we have the drawings to work to, our first line up would be to get out the forgings for the bottom, then the bodies and trucks. A foreman in a piece work shop should be able to tell within a day as to when certain forgings will be received for this work, as he would know the cost that he has to pay for each item, and would also know the amount that each workman would try to make. If it should come about for some reason that the company wanted this work several days ahead of the specified time, it is a very easy matter to push the work somewhat faster in a piece work shop than in a day work shop, for when the workmen can see they are to benefit their pocketbook, they will strain every effort to get just a little more out of each day.

J. H. Dalton (Erie Railroad, Huntington, Ind.):—We work piece work on new and repair work. Wherever there is piece work the output is greater and that is what we are looking for. Some say, under the piece work system they get an inferior grade of work. I don't think so. If a man does a job which will not pass inspection, send it back to him and let him do it over on his own time and he will soon begin to do his work right. Under the piece work system the foreman has got more time to look after his other duties, because if a man gets out of a job he will hunt up the foreman instead of the foreman having to watch him. He will also take better care of his tools and have them ready for the next job.

C. E. Lewis (Penna., Baltimore, Md.):—I have had about 29 years' experience with piece work, and think it is the only fair way to have work done. When the piece work system was first started at the Baltimore shops, there was a great deal of prejudice against it. The men seemed to think it was only another way of getting more work out of them, but they soon found that there was an advantage in it for them; and now if you ask a man to work day work he will become dissatisfied at once. I believe that all work should be done piece work. One of the worst things to contend with is that the prices are not set right at the beginning. If you get the price right at first, you will not have much trouble. When you set the price on a job of piece work be fair to the men as well as to the company. We have gang foremen that check the men on and off the jobs. These gang foremen should be men who will not show partiality to any one, as the men will soon get dissatisfied if they are not given fair treatment. I find that piece work is much easier for the foreman, as he does not have to watch over the men to see that they do their work properly. It is just as easy to do repair work by piece work as it is new work. If we repair a chisel we pay so much for the head and so much for the blade; re-

pairing a pair of tongs, so much for each jaw, etc. I find that the man who works piece work has his mind on his work more and find him studying out ways by which he can get out more work. Do not cut prices because a man is making more money, but encourage him to improve the tools and give him credit for improvements that he makes.

Discussion—E. Dixon (W. & L. E., Toledo, Ohio):—Every job in our shop is done by piece work, except coal wheeling and tool dressing. When a job comes in the shop, the inspector takes the time on it and it is entered in a book; when the master car builder gets time he goes over the job and sets a permanent price. The helpers are paid by piece work for building fires; the oiler is paid in the same way for oiling machines. I find if the blacksmiths haven't work they do not stand around; they look for me and if I do not give them work they complain.

OXY-ACETYLENE WELDING AND CUTTING

E. Dixon (W. & L. E., Toledo, Ohio):—In making this report I will submit records for three jobs as follows:

Tail block for 200 ton wheel press; broke on Saturday, March

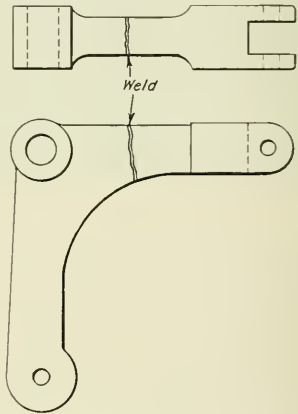

Arm for Automatic Rivet Maker Welded by the Oxy-Acetylene Process.

8, about 11:30 a. m.; was welded and annealed Saturday afternoon and machine was in working order Monday morning, at a labor cost of \$4.20.

Kick-out arm on Ajax automatic rivet maker; broke Feb. 20

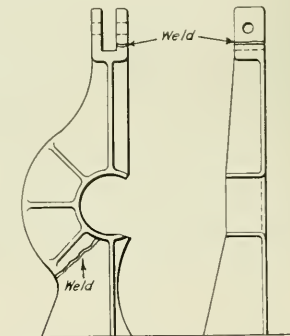

Tail Block for 200-Ton Wheel Press Welded by Oxy-Acetylene.

about 10:30 a. m. At 7:30 a. m., February 21, the machine was in running order at a labor cost of \$1.05.

Cylinder head on 750 lb. steam hammer; this hammer was

out of commission about 20 hours, and the labor cost was \$4.90.

Had we not had the acetylene gas plant we would have had to send each of these pieces to the factory, causing a delay of from 12 to 15 days for each machine.

CASE HARDENING

George Massar (C., N. O. & T. P., Ludlow, Ky.) :—We have double deck furnaces especially designed for our spring work and case hardening. We use cast iron boxes and lids. The pieces to be hardened are packed in one of these boxes of a suitable size. Pack the box carefully with the article to be hardened, so as to allow enough potash when dissolved to cover the work to be hardened. Cover the edges of the lid with fire clay to make the box as nearly airtight as possible. Allow the box to remain in the furnace from eight to ten hours at about 1,600 degrees F. Good results cannot be obtained with a heat

of the box with 1 in. of the carbonizing material, then place the work to be hardened 1 in. from the ends and sides of the box, and ½ in. between pieces; cover this with 1 in. of carbonizing material, and place the lid on the box. The length of time required in case hardening is regulated by the depth of the casing desired and the size of the pieces. At the close of the carbonizing period the box should be allowed to cool with the work undisturbed until cold; then remove the work from the box and reheat it slowly to from 1,450 to 1,472 degs. F. and quench in cold water, oil or brine, as the hardness requires.

C. A. Sensenbach (Penna., Sunbury, Pa.) :—The factors governing case hardening are equipment, temperature, time, and the nature of material. I have placed equipment first, as I do not believe it is possible to get good results with a slipshod equipment. Good results cannot be obtained unless the temperature is even. If the temperature is allowed to go below 1,300 deg.

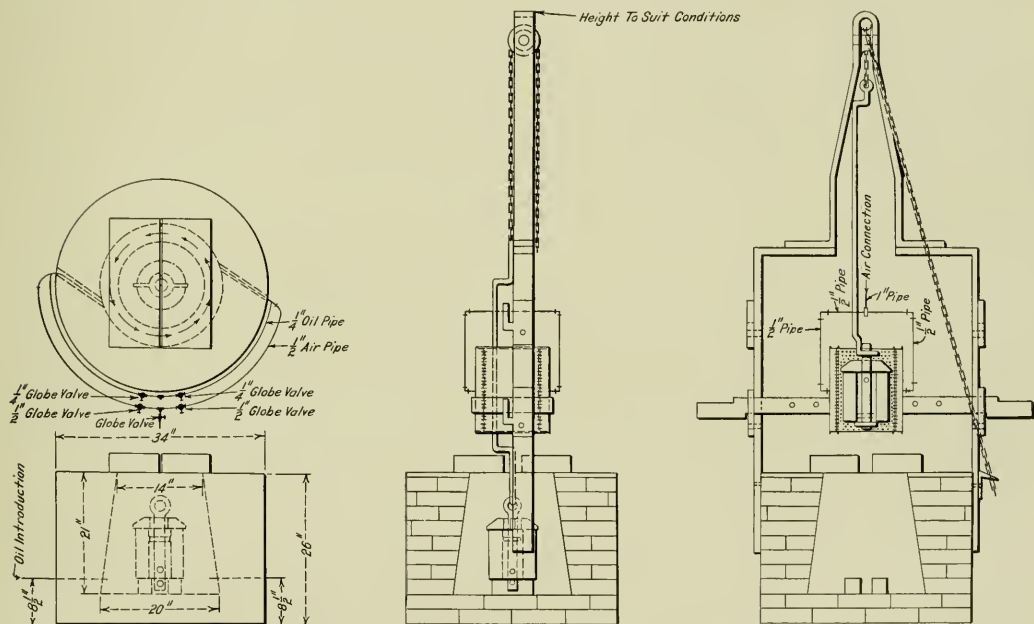

Furnace and Air Cooling Chamber for Hardening High Speed Steel Cutters; Louisville & Nashville.

that is not uniform. If the heat is too low, satisfactory carbonizing cannot take place.

R. E. Cronier (Atlantic Coast Line, Montgomery, Ala.) :—In case hardening I have for the past 12 or 14 years used carbonated bone with prussiate of potash next to the work when I pack the box. I like a wrought box as it is a little lighter to handle, heats through quicker, and will stand more heat than a cast box. I generally burn from 12 to 16 hours, and always take a test piece of ¾ inch or ½ inch round and have 1-16 inch or 3-64 inch on test, which will give me about 1-16 inch or 3-32 inch on an ordinary size link or block which I think very good. I have only a draft furnace for spring work and I do my case hardening in it. I generally pack my own box and see it put in the furnace, and see that red heat is kept on the box if possible. I dip in a clean water bath with wire netting in the bottom so as to keep the water all around the work.

J. P. Kane (Baltimore & Ohio, Newark, Ohio) :—To obtain the proper results in case hardening, a lot of pieces should be packed in a cast iron box of suitable design, say 9 in. deep, 18 in. wide and 30 in. long, with a lid to suit. Cover the bottom

F., the carbonizing stops, and decarbonizing is liable to take place; if the temperature is allowed to go as high as 1,850 deg. F., there is a tendency to crystallize the metal, and it is an accepted fact that a good penetration and good depth cannot be obtained with an uneven temperature. I have found that a temperature from 1,500 to 1,650 deg. F. gives good results, of course depending on the material used, but it must be maintained at that point or the results will not be good, and will show an uneven case after the reheating.

On small pieces I have obtained 1-16 in. case in 5 hours' carbonizing. On large pieces, such as links, crosshead pins, etc., I have found it necessary to run as long as 16 hours, carbonizing time. I think with the proper equipment a regular chart could be tabulated.

The factor of material is a delicate one and the source of considerable argument, and I believe there are as many combinations of materials used as there are railroad shops. The old style of material was raw bone, and I have had some fair results with it, but my principal objection is the tendency to pit and scale the pieces, caused by the excess of moisture and

sulphur in the bone, and also it seems impossible to get two batches alike. I also strongly object to the use of any cyanide preparation on account of the poisonous fumes. I have obtained excellent results with hydro-carbonated bone black and prefer it to raw bone, as I have found it more uniform, which is very essential. I have also been able to get a good depth of case in a reasonable time.

HEAT TREATMENT OF METALS

H. E. Gamble (Penna., Altoona, Pa.) :—We have a plant for heat treating locomotive parts, and the results obtained are beyond first expectations. I believe that the heat treating of the steel casting must come, especially the main frames of the locomotive, as the annealing of the main frames is not enough. They need some refinement; why not quench them, as we would other parts of the locomotive?

James A. Ridgely :—In heating tool steel of about .9 carbon, it goes through many changes. Take as an example a piece of properly annealed tool steel at atmospheric temperature; in heating, the temperature will rise uniformly until it reaches about 1,300 deg. F. Here the temperature remains stationary until certain internal conditions have been satisfied, when it again rises uniformly to about 1,400 deg., when the second transformation takes place. The temperature again remains stationary until this has been completed, and it again rises uniformly to about 1,550 deg., where the third change takes place. These changes have been designated as the recalescent points, and we will refer to them as Ac-1, Ac-2 and Ac-3.

If suddenly quenched in water at Ac-3, or 1,550 deg., the steel will be very hard and coarse, and the metal will be held in the condition in which it was placed by the applied heat. If allowed to cool slowly the temperature will drop uniformly until slightly below the temperature at which the transformation took place. This point has been designated as Ar-3. When the changes in the structure and grain have been thoroughly completed, the heat again falls uniformly until it reaches a temperature of about 1,350 deg., at which point the second change takes place, which is the opposite to that on the rising temperature, and has been designated as Ar-2. After the change has been completed at this point it again lowers in temperature uniformly to the next point, Ar-1, or about 1,250 deg.; after this change it gradually lowers to atmospheric temperature. These have been called the decalescent points.

During these changes in the metal the iron assumes three different conditions. While the temperature is rising to Ac-2, it is highly magnetic and has been called Alpha iron, or "A," or ordinary soft iron, as we know it in ingot iron or steel. At about Ac-2 it loses its magnetism, and between Ac-2 and Ac-3, it is as non-magnetic as brass and has been called Beta iron or "B," a hard variety as we know it in hardened steel. This change in magnetism is accompanied by a change in electric conductivity and specific heat. At Ac-3 another change in electrical conductivity takes place, and also in the metal's crystalline form. Above Ar-3 it is called Gamma iron, and is very low in tensile strength.

The question of when to quench this steel after it has reached the recalescent point has been asked many times. The writer has found that a variation of 100 deg. can be allowed in the temperature without doing harm to steel ranging from .85 to 1.30 in carbon, covering tool steel for general work, and also finds that steel containing 1.20 carbon can be quenched at as high a temperature as 1,472 deg. without injury to the steel.

CAST STEEL IN THE BLACKSMITH SHOP

George F. Hinkens (West A. B. Company) :—The most important element in steel, so far as the tool user is concerned, is carbon. Cast steel is iron and combined carbon in the hardened state, and iron and graphite carbon in the annealed state. The tool smith should know the carbon points of steel he is working. For example, if he has been in the habit of making milling cut-

ters out of steel containing 125 carbon points he knows just what degree of heat is suitable for the right temper. If he should receive a piece of steel with only 110 carbon points, he would get the milling cutter too soft, yet he could in either case make a satisfactory tool if he knew the carbon points. Purchasing agents should bear this in mind, and give the mechanical department what they call for, for it is both common sense and true economy to leave such matters to their judgment.

A point in this case means one one-hundredth of 1 per cent. The following is a classification of tool steels: One hundred and fifty carbon points, suitable for tools for lathes, planers, boring car wheels, etc.; 135 carbon points suitable for large lathe and planer tools, medium size dies, etc.; 125 carbon points suitable for taps, reamers and drill; 115 carbon points suitable for screw cutting dies, chisels, punches and milling cutters; 105 carbon points suitable for cold chisels, punches, dies, large taps, milling cutters, small shear knives; 95 carbon points suitable for large punches, shear blades, large dies and some blacksmith tools; 85 carbon points for stamping dies, hammers, cold sets, track chisels and smith tools; 75 carbon points for swedges, flatters, cupping tools and blacksmith tools generally. In ordering steel give the temper, or state the purpose for which the steel is to be used. The carbon points given are obtained from average results, but must not be adhered to strictly, as conditions may necessitate a deviation. For example: a lathe tool for turning hard tires, tool steel, or for hard roll turning will require 150 carbon points, whereas a lathe tool for turning bolts or soft material will require from 125 to 135 carbon points. The speed of the machine and the nature of the material to be cut are factors.

It is very discouraging to the steel maker to find that after all his care and expense his product is abused in heating after it leaves the mill. Unequal heating will produce an inequality of the particles, and will cause their displacement in one direction or another when steel is subjected to the forging process. In working a piece of steel with uneven heat the particles are pushed out of their normal position and no amount of annealing can altogether replace them. The particles of steel will arrange themselves only in obedience to natural laws. Forging steel at a black heat will crush the particles or bring about rapid crystallization or enlarged crystals. Steel should be in a plastic state during the process of forging, and the heat should be as even as it is possible to have it; the force of the blow should also penetrate the whole mass so as to prevent the drawing of the exterior surface away from the core or center. When the outside of the steel is worked more than the inside, the effect is telescopic, and the steel can only be rehabilitated by annealing, and then by no means will the temper be uniform.

Overheating of steel changes the particles of pure steel to crystals of oxidized carburet of iron, and by cooling in water little diamond points of combined carbon and steel are fixed, but fixed so loosely in this crystallized frame work that holds them that it breaks down and they crumble out. Overheating underheating, overworking and underworking will change the structure of steel, that is, down to 40 carbon points and below. Every degree of heat in any of its stages registers itself in a piece of steel. The higher steel is in carbon, the more mercurial; in other words, high carbon steel is more sensitive and yields to influence more readily than low carbon steel. The proper heat is learned only from experience. If the toolsmith, in forging a tool, were to reduce a piece of steel from 6 in. to 3 in. in diameter, he would use a higher heat than in reducing a piece of steel from 2 in. to 1½ in. in diameter. In the first or larger piece he heats up the coarse grain, but the sufficient amount of hammering in reduction of bulk refines the steel and no harm is done; if the second or smaller piece is heated up to the same high heat as the first piece, he starts with the same coarse grain as in the larger piece, and a reduction of only ½ in. in diameter under the hammer is insufficient to hammer-refine the steel; the larger piece will hammer-refine and reduce in heat at the same

time. Not so with the smaller piece; it will receive no hammer-refining and the high heat will leave its structure coarse.

The object of annealing is two-fold; to remove any discrepancies due to forging, and to soften, so it can be worked into any desired shape. The restoration of the particles of steel that have been changed by forging, to their normal state, is brought about by annealing. The annealing due to slow cooling will remove in a great measure all undue strains that were put in the steel by hammer, sledge or steam hammer. Annealing allows the particles of steel to arrange themselves in their right condition, but we must remember that bad strains can only be imperfectly eliminated by annealing, and it should be the inflexible purpose of the toolsmith to guard against working strains into steel while forging. Steel that has been improperly worked, that is, that has had the grain crushed, cannot be rectified by annealing; there is a certain amount of brushness that no annealing can eliminate.

The action of heat is closely related to the hardening process, and the value of the physical and carbon properties are known to be dependent on the degree of heat in the steel before immersion. In speaking of heat for hardening, we are governed by carbon points; the higher the carbon, the lower must be the heat. When a tool is fractured, if it shows a sandy grain, it proves that the steel was overheated; if, on the other hand, the grain is fine and of clear appearance, it indicates a proper heat; if a variation in grain, it indicates uneven heating. Cooling a piece of steel that is unevenly heated causes a complex arrangement of the particles, a separation in one place and a crowding in another, thus producing strains and water cracks. In cooling, keep the water in motion. If the article to be hardened is bulky, the heat radiating from it will repel the water, and envelop the article in a film of steam surrounded by hot water, and as steam and hot water are poor conductors of heat, they will prevent rapid cooling. By keeping the water in motion, the article to be hardened is kept surrounded by cold water, thus causing more rapid cooling and an increase in hardness. The more instantaneous the cooling, the more harmonious the particles. The time required to heat a piece of steel for hardening depends upon the size and shape of the article, and may be anywhere from a few seconds up to several hours. A milling cutter, 8 in. x 10 in., will require from three to four hours.

In order to obtain the right depth of hardness in a tap or reamer, a good way is to take out a worn-out tap or reamer and use it as a trial piece, both as to heat and length of time for keeping in the water. Break a piece off and the effect will be seen on examination. Hardening in oil, or combination of oil and water, has its limitations, however, and we must be governed entirely according to conditions. The object of a soft center in a tap or reamer is to increase the torsional strength.

HAMMER CRANE SHOCK ABSORBER

George W. Kelly (C. R. R. of N. J., Elizabethport, N. J.) :—A crane shock absorber is a device which eliminates the continuous jarring and sudden jerks transmitted to a crane. The main saddle is made of forged steel and is provided with holes for wheel pins and acts as a seat for a coil spring and spring cage. The ends of the saddle are 1 1/4 in. thick, swelling out in the center to 7 in. diameter. The spring cage is 5 3/4 in. inside diameter, 6 3/4 in. outside diameter and 9 in. long. A slot 3 in. x 1 in. is provided on the upper end for the clearance of the key in its vertical motion.

The trolley roller is made of forged steel and provided with a flange to prevent lateral motion. The wheel has a 3 in. bore to accommodate 15 15/32 in. diameter steel rollers, 2 in. long, case hardened. This roller bearing is a decided improvement over a plain bearing, especially when exceedingly heavy forgings are to be manipulated. The rollers cannot fall out, being held in by the saddle on the inside and by a steel washer on the outside, which is 5 in. in diameter by 1/2 in. thick. This in turn is secured by a 1 1/2 in. nut on the end of the wheel pin. Owing to the vi-

brations of the crane proper due to the heavy hammer blows, the various nuts should be provided with lock washers, etc. A piece of flat bar iron 4 in. x 1/4 in. thick, having hexagonal holes to fit a 1 1/2 in. nut, at the proper centers of the pins, which are 15 in.

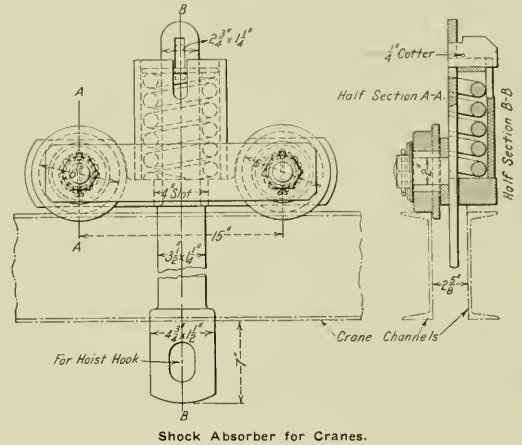

Shock Absorber for Cranes.

in this case, serves this purpose. To prevent these keepers or lock straps from slipping off a 5/16 in. cotter is provided in each nut and pin.

EFFICIENCY

George F. Hinkens (West. A. B. Company) :—Efficiency is systematic organization and practically a community of interest. What we are particularly interested in as foremen is shop or industrial efficiency. Industrial efficiency is not applied science. There is always more or less trouble in attaining the proper degree of efficiency. If the most efficient engineer or expert take hold of a demoralized and disorganized concern, let him not think he is going to embark upon something with the belief that all is to be smooth sailing, for if he does he is certain to be disillusioned. We must deal with human nature as we find it, not as we would like it to be, consequently in striving for greater efficiency and better service we must ever bear in mind the human factor. Much has been written on efficiency movements, and much of it has been received with mistrust from the laborer's standpoint. To the workingman the adoption of new methods and labor saving devices means a reduction in the force of employees. This belief is erroneous, and it is the part of efficiency to counteract it. Lack of appreciation on the part of a foreman tends to make an employee careless and discourages him. As a rule, men will work better and more cheerfully if their work is appreciated. A passing compliment on the manner in which good work is done is a stimulus at all times. Give your best men a sense of responsibility. Use good judgment in choosing workmen to do something on their own responsibility and thereby bring their skill and ingenuity into play. If you have such men let them realize that you think they have brains and the freedom to use them.

Excessive hours of labor, usually called overtime, are not conducive to efficiency, because the workers become fatigued, and therefore are not able to do the same quantity or quality of work. Too many hours of work puts a nervous strain on the worker, causing bodily and mental fatigue, and it makes work monotonous and burdensome. Workers should be physically and mentally fresh when commencing work in the morning. Too much overtime will exhaust the vitality of the worker.

Good men in the ranks are an asset and should not be sent home when a slackness in business occurs. Keep your best men

CAR DEPARTMENT

CAR INSPECTORS' AND CAR FOREMEN'S ASSOCIATION

The fourteenth annual convention of the Chief Interchange Car Inspectors' and Car Foremen's Association was held at Minneapolis, Minn., August 26, 27 and 28, J. L. Stark presiding. Rev. G. T. Lawton offered the opening prayer. The association was welcomed to the city by the mayor, Wallace G. Nye.

PRESIDENT STARK'S ADDRESS.

We now meet to advance, by discussion, our knowledge relating to safe and economical railway car interchange, the construction and maintenance of cars and shops, and to secure a thorough and uniform understanding of the M. C. B. rules. The cost of maintenance and operation of equipment has been and is on the increase and must receive the careful consideration of all car department employees. I would urge the members of this association first to be careful in reaching conclusions and that, secondly, we uniformly carry out the conclusions reached.

ADDRESS BY T. H. GOODNOW.

T. H. Goodnow, assistant superintendent car department, Chicago & North Western, addressed the association at the opening of the Tuesday afternoon session. Mr. Goodnow called attention to the importance of the association thoroughly discussing the M. C. B. rules of interchange with a view of getting the correct interpretation. He spoke of the necessity of thoroughly educating the car inspector in the correct interpretation of the rules. He greatly favored the joint inspection bureaus and predicted their general installation throughout the country. The general tendency of all the M. C. B. rules is becoming broader so as to make it easier to keep the freight moving towards its destination. He mentioned the bad effect that temporary repairs on interchange equipment had on the producing of bad order cars, stating further that he believed there would be still better agreements made within the next few years whereby more complete general repairs will be made to foreign cars. He closed his remarks by again emphasizing the necessity of carefully educating the inspectors in the yard.

DISCUSSION OF RULES.

The code of rules for interchange as adopted by the M. C. B. Association was discussed with a view of determining the correct interpretation of each rule, where there seemed to be any chance of misunderstanding. The following are the important conclusions reached under the various rules:

Rule 1. This rule was generally understood to mean that each road should conscientiously give all foreign cars the same care as to inspection, oiling, packing, adjusting brakes and running repairs that it gives to its own cars.

Rule 2. In regard to the first paragraph, many roads rely on the inspection of the receiving roads to determine defects, while others make their own inspection before delivering. Both practices have given satisfactory results.

In regard to paragraph *c*, many roads accept the improperly loaded car and transfer the load at the expense of the delivering line rather than turn the car back to the delivering line, thereby getting a more prompt delivery of the freight.

Rule 3. The second paragraph of this rule was believed by many to offer protection to the negligent car inspector, and it was thought that better results could be obtained by having this paragraph eliminated from the rules.

Rule 16. Under this rule it was believed to be permissible to make as heavy repairs as are required to place the car in

good condition up to the extent of combination defects and to charge the delivering line or the owner as the case requires.

Rule 32. Under this rule the question of missing brake staffs on cars where they were removed for the accommodation of the lading was considered to be a delivering line defect, for when such cars are received, the inspectors should ascertain whether or not the brake staffs were with the car.

Rule 35. The stenciling of cars as mentioned in the third paragraph was taken to mean the date when the cars were rebuilt rather than when they were originally constructed.

Rule 39. The word "substitute" for draft timber was taken to mean any of the metal draft gears.

Rule 42. It was the consensus of opinion that two broken end posts and two corner posts are cardable defects.

Rule 43. Burned flooring or siding not able to be seen from the outside of the car and under the ordinary methods of inspection was considered as a "concealed fire damage."

Rule 60. In case of neglect to stencil the date of cleaning the various air brake parts, if those parts are re-cleaned on account of the date shown by the old stencil, the road performing the first cleaning cannot collect for the work done. In case it is necessary to clean those parts soon after they have been cleaned by another road, a joint inspection should be made to determine whether the road that did the first cleaning or the owner should pay for the second cleaning.

Rule 68. It is understood that both wheels mentioned in the first paragraph shall be charged to the delivering company, even if the mating wheel has no slid flat spot.

Rule 105. A manufactured article was considered as one that was not included in the schedule and that would have to be purchased in the open market.

Rule 120. While this association appreciated that the rewording of this rule is in accordance with their suggestion, they believed it could be made stronger and serve better the results for which it is intended, by insisting in some way that requests for home route cars be given more prompt attention. A motion was passed requesting the Master Car Builders' Association to impress on the proper railway officers, "the importance of all roads throughout the country giving their immediate attention to requests for home route cards or for authority for dismantling cars, as it is found that such home route cards or authority for dismantling is being unduly delayed. This taken in conjunction with lack of proper storage room, is working seriously to the disadvantage of handling lines. Attention is also called to the fact that, in some cases, when cars reach the owner's line they are not repaired permanently, and it is respectfully recommended that owners give proper attention to such cars rather than permit them to again leave the home line with the same defects in existence."

It was understood that the per diem rates stop from the date of asking for home route cards. It was also understood that the car owner is obliged to pay for putting the car in sufficient repair for home routing.

It was also mentioned that car service *Rule 3*, paragraph F, was soon to be changed to coincide with the new rule.

The following addition to this rule was recommended to the Master Car Builders' Association: "If a car is found to have decayed or worn out parts which constitute an unfair usage combination under rules 37 to 42 inclusive, and if repairs are made without authority from the car owners, a joint evidence statement shall be furnished stating the actual condition of the car in accordance with rule 12, and this statement will be the authority for the company having such car in its possession to

make all necessary repairs and to bill the car owner for the cost of repairs, provided these repairs are necessary on account of defects due to ordinary wear and tear. The joint statement is to accompany the repair cards as authority for the bill." This change is suggested in order to facilitate prompt repairing of bad order cars and place the responsibility for these repairs where it properly belongs. Under the present rules and decisions the company having such a car in its possession must write the car owner for authority to repair before any repairs are made. This action results in seriously delaying bad order cars and also burdens the company handling the car with per diem charges which frequently amount to more than the cost of repairing the car.

Rule 14. In order to have uniform method for locating defects it was agreed to observe following system for underframe and superstructure. On a half of a car, the sides shall be designated right and left from a position facing the car at A end and the sides on the B half of the car shall be likewise designated from a position facing the car at B end.

Car service *Rule 15.* A great deal of trouble has been experienced by improper loading of open cars. An inspection at Chicago disclosed the fact that less than ten per cent. of such cars were loaded in accordance with the rule. It was believed that the shippers should be more carefully informed and be made to live up to the rules. The Chicago Car Interchange Bureau has a printed form requesting authority for reloading such cars which is sent to either the shippers or the delivering road, as the case may be. In some localities it is easier to force the shipper to conform to the rules, and it would be possible in all localities, if all the roads would enforce this rule as they should. It was also stated that box cars should be as carefully watched, as overloading often forces the car doors outside the clearance limits. At Buffalo an average of twelve hundred cars are reloaded per month.

It was stated that much more care should be exercised in placing proper car initials and numbers on repair cards. The yard inspectors are found to give the most trouble. When checked with work cards, corrections can often be made before much trouble has been caused.

One hundred and sixty-two members were registered and the sessions were well attended.

The following officers were elected for the ensuing year: F. C. Shultz, chief interchange inspector, Chicago, president; F. H. Hanson, assistant master car builder, Lake Shore and Michigan Southern, vice-president; S. Skidmore, foreman, car department, Big Four, secretary-treasurer.

DEFECTIVE APPLICATIONS OF BRAKE APPARATUS*

BY FRANK J. BORER,

Department Foreman, Central Railroad of New Jersey Shops, Elizabethport, N. J.

The problem of making cars more fire, water, burglar or proof, or to design them to prevent, or at least reduce the amount of damage both to the cars and the lading is the main issue among a large number of railway officers and employees. The writer will deal chiefly with defects in the brake system as existing on a great many cars to a greater or less extent, which, if remedied, would result in a large saving of money, and reduce the bad order car bills, especially those on account of damaged draft gears. To accomplish this, it is necessary to have absolutely reliable hand brakes at all times. Some of the most common defects are:

(1) Hand brake chain too long, causing fouling on brake staff barrel or drum especially if the piston travel exceeds 8 in.

(2) Hand brake chain too short, causing the brake shoes to drag on the wheels if the brake is adjusted to 5 in. piston travel, or less.

(3) Drum or barrel on brake staff too short, having the same effect as too long a brake chain.

(4) Hand brake chain sticking in hand brake chain sheave, especially when releasing the hand brake. This defect is often the designer's fault in not allowing sufficient clearance for the chain to pass through the sheave and the sheave bracket; or the designer may have had the drawing made for a $\frac{3}{8}$ in. chain, but later some one may have applied a $\frac{1}{2}$ in. chain.

(5) Lever guides and lever carriers designed too short or applied in a wrong manner, causing the levers to butt against the lever guides with a long piston travel when applying the hand or air brake, rendering it useless.

(6) Hand brake chain applied to the wrong side of the brake staff, causing the chain to stick by striking against the brake staff supporting bracket.

(7) Poor hook on hand brake rod allowing the chain to disengage itself from the rod.

(8) Insufficient clearance around the pipes where they pass through holes in the sills, there not being enough allowance for the expansion of the steam pipes or a little shifting of either steam or air pipes. The same may be said of angle cocks applied snug against the end sills of cars without any clearance between the end sill and the angle cock.

(9) Branch pipe connections to the triple valve made too rigid, causing leaks, broken check valve cases and broken pipes, whenever the car receives a shock. The designer and builder have often overlooked the fact that branch pipes ought to be run so as to relieve the triple valve of any strain, if the train line should shift one or two inches. On account of many centrifugal dust collectors freezing up and bursting during cold weather and in order to keep moisture out of the triple valves, branch pipe connections ought to be taken out of the top of train line instead of from the bottom as is usual.

(10) On passenger equipment cars, low pressure gas feed pipes, the car discharge valve pipe and the pipe leading to the conductor's valve ought to be galvanized, especially where they pass through the floors, as they will last much longer.

(11) Some designers of freight cars seem to have entirely disregarded the matter of easy accessibility for clearing and repairing the triple valve and brake cylinder. These parts are placed close against steel sills on some cars making it extremely hard to make proper repairs.

In conclusion, if we expect a man to do good work we must give him a chance. We must make the conditions under which he works as favorable as we can. This applies to the air brake repairman as well as to the brakeman. Let the former put the brake in a good condition and the latter will not damage so many cars in the yards in the course of shifting. Let the designer, the foreman, the repairman, the yardmaster and the brakeman co-operate with one another for the common good of our employers and ourselves, and many existing defects in car construction may be remedied or avoided without any difficulty.

EXTINGUISHING FOREST FIRES.—Ammonia bombs are being tried out on some of the national forests for the purpose of extinguishing forest fires. They are said to have worked well in the case of brush fires where the fire-fighters find difficulty in getting near enough to the burning area to beat out the flames. Each bomb exploded will extinguish fire in a circle of about five yards in diameter.

OVER-SPECIALIZATION.—Over-specialization often leads to undue emphasis upon the importance of individual tasks in given departments; to a lack of interest outside immediately vital responsibilities; to long continued employment at stated compensation perhaps, and not seldom to final replacement before middle age is past by men with less experience in single grooves but with better comprehension of inter-departmental relations and the ability to make effective use of men with limited ideas.—*Pover.*

*Entered in the Car Department competition which closed February 15.

STUDY OF CAR WHEEL FLANGES AND TREADS

High Frictional Resistance Results from Non-Mating and Poor Flanges—Cast Steel Wheels and Coning Good.

BY L. W. WALLACE,

Assistant Professor Car and Locomotive Design, Purdue University

The discussions of the report of the standing committee on car wheels at the last three conventions of the Master Car Builders' Association have been read with much interest by the writer. That portion pertaining to the contour of the tread of the wheels was of most interest. It is surprising to note the wide divergence of opinion as to the value or non-value of coning, and also the very evident lack of actual knowledge of just what influence the condition of the flange and tread of a car wheel has on flange friction. The writer first became interested in this matter and began to make a study of it while associated with the truck tests* made for the American Steel Foundries during the summers of 1910 and 1911, and since that data has been published a careful analysis of it has been made from the standpoint of the wheels. It is proposed to here submit the results of that analysis, in the hope of adding some information to the discussion and to indicate a possible means of determining by experimental methods just what wheel contour is best adapted to American railway practice.

THE DATA.

All of the data used as a basis of this discussion was that published in "Some Experiments with Freight Car Trucks," Volume II, by Professor Louis E. Endsley. That portion of the data obtained when an Andrews side frame truck was tested was used for the purpose of determining to what extent that truck resistance was increased by defective wheels. The truck from which the data was obtained was of standard design, with the exception that it had a heavier bolster than commonly used. By using the heavy bolster and loading the truck with a large steel casting, the weight of the truck as tested was made equivalent to the light weight on a truck of a fifty-ton car.

As access may be had to the complete report of the tests upon which this discussion is based, it is not necessary to go into details as to how the data was obtained and worked up. But since the object of this paper is to show in what manner and to what extent frictional resistance is influenced by the condition of wheel treads and flanges, a rather detailed description of the wheels will be given.

WHEELS USED.

Thirty-two different wheels were used in such combinations as to make the ten sets designated in Table I. The wheels used in seven of the sets were cast iron, and those used in the remaining three sets were Davis cast steel wheels. Table I gives the main facts with reference to the wheels, and Figs. 1 to 10 inclusive show the wheel contours, as obtained by means of a wheel contour recorder. In order to show clearly the condition of the wheel flanges and treads, there was superimposed upon each wheel outline the standard M. C. B. contour. This was done in the following manner: The contour recorder drew the straight line shown in the diagrams, marked "parallel to the base line"; this line was parallel to the axle. In applying the standard contour, its base line was made parallel to the base line of the wheel contour and the gaging point of the M. C. B. standard contour was brought in contact with the wheel's gaging point in the same manner as the regulation wheel defect gage is used. The space between the outer line

and the inner one, in each case, indicates in what manner and to what degree the contours of the wheels tested had been worn. It is evident from this exhibit that as wide a variation in wheel conditions as is ordinarily met with in practice was

TABLE I.

Set.	Wheel No.	Service condition.	Kind of wheel.	Type.	Date made.	Weight, lbs.	Total weight of truck and wheels as tested.
I	II	III	IV	V	VI	VII	VIII
A	1	Mated, new (ground)	C. I.	1/32" under 33"	7-29-10	715	
A	2	Mated, new (ground)	C. I.	1/32" under 33"	7-28-10	715	22,610
A	3	Mated, new (ground)	C. I.	1/32" over 33"	8- 2-10	715	
A	4	Mated, new (ground)	C. I.	1/32" over 33"	8- 2-10	715	
B	1	Non-mated, new.....	C. I.	1/16" under 33"	9-21-99	650	
B	2	Non-mated, new.....	C. I.	1/16" over 33"	9-23-99	650	22,400
B	3	Non-mated, new.....	C. I.	1/8" over 33"	11- 8-99	650	
B	4	Non-mated, new.....	C. I.	1/8" over 33"	11- 8-99	650	
C	1	Mated, new, Davis...	C. S.	3/4" over 33"	8-17-10	612	
C	2	Mated, new, Davis...	C. S.	3/4" over 33"	3-18-10	612	22,200
C	3	Mated, new, Davis...	C. S.	13/16" over 33"	8-20-10	612	
C	4	Mated, new, Davis...	C. S.	13/16" over 33"	7-14-10	612	
D	1	Mated, med., new....	C. I.	13/16" under 33"	9-20-05	700	
D	2	Mated, med., new....	C. I.	13/16" under 33"	9-20-05	700	22,550
D	3	Mated, med., new....	C. I.	3/16" under 33"	8-21-05	700	
D	4	Mated, med., new....	C. I.	3/16" under 33"	8-21-05	700	
E	1	Non-mated, med., new	C. I.	13/16" under 33"	9-20-05	700	
E	2	Non-mated, med., new	C. I.	3/16" under 33"	8-21-05	700	22,550
E	3	Non-mated, med., new	C. I.	13/16" under 33"	9-20-05	700	
E	4	Non-mated, med., new	C. I.	3/16" under 33"	8-21-05	700	
F	1	Mated, old	C. I.	1 1/4" under 33"	5-17-02	650	
F	2	Mated, old	C. I.	1 3/4" under 33"	8-20-02	650	22,400
F	3	Mated, old	C. I.	3/4" under 33"	4-15-04	650	
F	4	Mated, old	C. I.	13/16" under 33"	8-15-06	650	
G	1	Non-mated, old	C. I.	15/16" under 33"	11-22-02	600	
G	2	Non-mated, old	C. I.	3/4" under 33"	11- 5-07	700	22,400
G	3	Non-mated, old	C. I.	15/16" under 33"	3- 8-06	650	
G	4	Non-mated, old	C. I.	3/4" under 33"	5- 4-07	650	
H	1	Non-mated, med., old	C. I.	1/8" under 33"	3-18-07	700	
H	2	Non-mated, med., old	C. I.	1/8" under 33"	3-18-07	700	22,550
H	3	Non-mated, med., old	C. I.	1" under 33"	2- 5-06	700	
H	4	Non-mated, med., old	C. I.	7/8" under 33"	12-22-06	700	
I	1	Special, Davis, mated	C. S.	1.21" under 33"	5-16-11	576	
I	2	Special, Davis, mated	C. S.	1.21" under 33"	5-16-11	577	22,200
I	3	Special, Davis, mated	C. S.	1.18" under 33"	7-19-11	581	
I	4	Special, Davis, mated	C. S.	1.18" under 33"	7-19-11	591	
J	1	Special, Davis	C. S.	1.12" under 33"	5-16-11	576	
J	2	Special, Davis	C. S.	1.21" under 33"	5-16-11	577	22,200
J	3	Special, Davis	C. S.	1.11" under 33"	7-19-11	581	
J	4	Special, Davis	C. S.	1.18" under 33"	7-19-11	591	

used. The special characteristics of each set of wheels are as follows:

Set A. The wheels in this set were new cast iron with contours ground in order to obtain as nearly the M. C. B. standard as possible; from Fig. 1 it is evident that there was a close similarity in the two contours.

Set B. The wheels in this set were cast iron and will be referred to as non-mated new wheels. One pair of these wheels had a difference in tape measurement of 1/8 in., and the other pair had a difference in tape measurement of 1/4 in. The two large wheels were on the same side of the truck. It is evident from Fig. 2 that the contours of this set of wheels were good.

Set C. The wheels in this set were Davis cast steel with contours ground to the M. C. B. standard. A comparison of the contours and that of the standard is shown in Fig. 3. The wheels on each axle were perfectly mated.

Set D. The wheels in this set were mated cast iron wheels, and they will be referred to as medium new wheels. To what

*American Engineer & Railroad Journal, May, 1911, page 193, and November, 1911, page 455.

extent they were worn is shown in Fig. 4. Wheels 3 and 4, which were on the same axle, were $\frac{5}{8}$ in. larger than wheels 1 and 2 on the other axle.

Set E. The wheels in this set were the same as those used in Set D, and their contours are shown in Fig. 5. The mated condition prevailing in Set D was converted into the non-mated medium new set E by placing wheel 2 of Set D on the

as is obvious from Fig. 7. There was a difference of $\frac{9}{16}$ in. in the circumference of wheels 1 and 2, and $\frac{1}{2}$ in. in the circumference of wheels 3 and 4. The large wheels were on the same side of the truck.

Set H. The wheels in this set were cast iron and they will be referred to as non-mated medium old. There was a difference of $\frac{1}{2}$ in. in the circumference of wheels 3 and 4, and

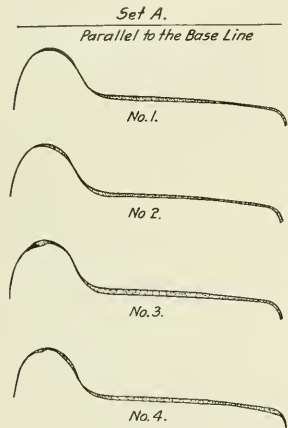

Fig. 1—Set A; Mated New Cast Iron Wheels, Ground.

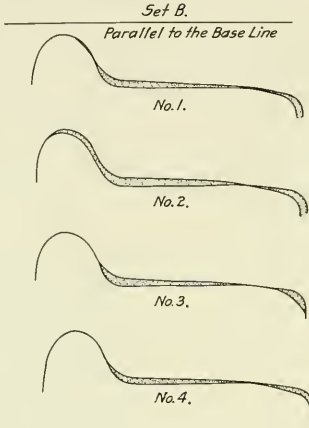

Fig. 2—Set B; Non-mated New Cast Iron Wheels.

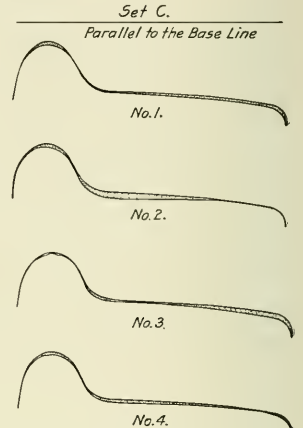

Fig. 3—Set C; Mated New Davis Cast Steel Wheels.

same axle as wheel 4, thus forming 3 and 4 of Set E. In like manner wheel 3 of Set D was placed on the same axle with wheel 1, thus forming pair 1 and 2 of Set E. The above mentioned change made the wheels on one side of the truck $\frac{5}{8}$ in. larger than on the opposite side.

Set F. The wheels in this set were cast iron and will be referred to as mated old. Although they were not exactly

wheels 1 and 2 were mated. Their contours are shown in Fig. 8.

Set I. The wheels in this set were Davis cast steel wheels and will be referred to as special mated Davis. These wheels were made with a height of flange of $\frac{3}{4}$ in., and with no coning on the treads, as is evident from Fig. 9.

Set J. The wheels in this set are the same as those used

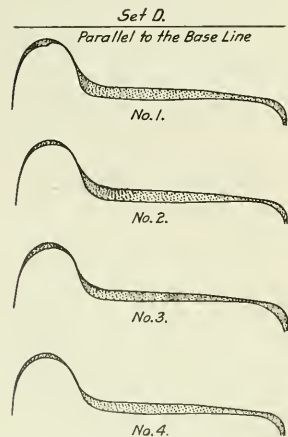

Fig. 4—Set D; Mated Medium New Cast Iron Wheels.

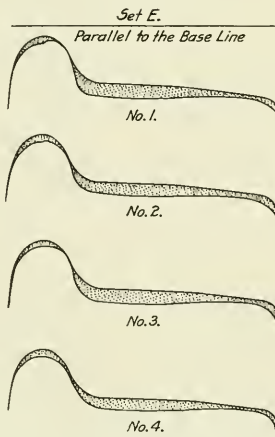

Fig. 5—Set E; Non-mated Medium New Cast Iron Wheels.

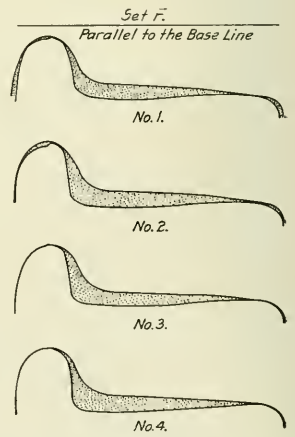

Fig. 6—Set F; Mated Old Cast Iron Wheels.

mated, yet they were nearly enough so to be classed as such when considered in connection with their sharp flanges which are clearly shown in Fig. 6. Wheels 3 and 4 were approximately $\frac{7}{16}$ in. larger than wheels 1 and 2.

Set G. The wheels in this set were cast iron and will be referred to as non-mated old. The contours were not good,

in Set I, and the contours of their flanges and treads are shown in Fig. 10, the only difference between the two sets being in a very slight non-mating condition prevailing in Set J.

DISCUSSION OF RESULTS.

An examination of the value of the resistance in pounds per ton for all tests made with the Andrews side frame trucks

showed that of all wheels used, the mated Davis cast steel gave the least resistance. Therefore, in the further study of this subject, the mated Davis cast steel wheels, designated as Set C, will be taken as a basis of comparison. This comparison is not to be taken as absolute, as only one set of Davis steel wheels was used; consequently data obtained from more sets might indicate something different. But within the limits of the data at hand, such a comparison as will be made

as Set A, were used. The resistance in pounds per ton for both Set C and Set A are given in Table 2.

TABLE 2.
COMPARISON OF SETS C AND A.

Track.	Tangent.	3 Deg.	6 Deg.	12 Deg.
Resistance in lbs. per ton for Set A.	9.8	11.1	12.4	17.5
Resistance in lbs. per ton for Set C.	5.0	6.0	6.9	12.5
Lbs. in favor of Set C.	4.8	5.1	5.5	5.0
Per cent. in favor of Set C.	48.9	45.9	44.3	28.5

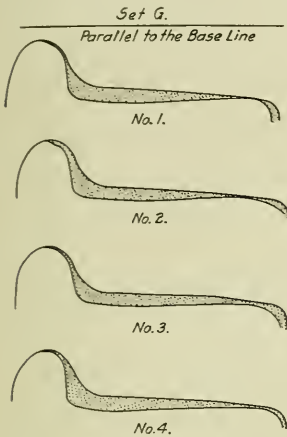

Fig. 7—Set G: Non-mated Old Cast Iron Wheels.

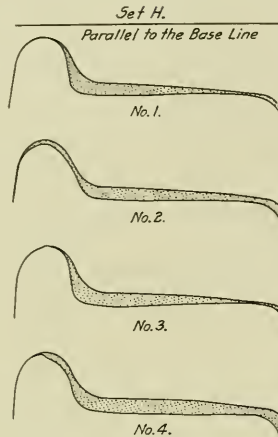

Fig. 8—Set H: Non-mated Medium Old Cast Iron Wheels.

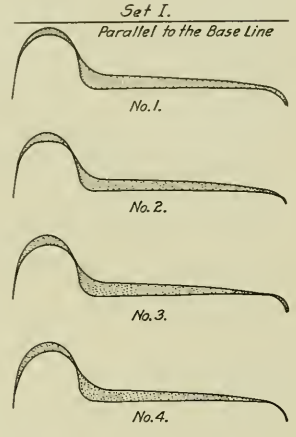

Fig. 9—Set I: Special Davis Mated Cast Steel Wheels.

is justifiable. To this end, the average resistance in pounds per ton for each truck was determined for this set of wheels, which values are as follows: Tangent track, 4.96 lbs. per ton; 3-deg. 5.37 lbs. per ton; 6-deg. 6.38 lbs. per ton, and 12-deg. 12.52 lbs. per ton. These values were plotted as shown in Line 1 of Fig. 11. It is to be noted that the slope of the line gradu-

From the percentages given in the last line of the table, it is evident that the mated cast iron wheels gave a much higher frictional resistance than the mated cast steel wheels. It was expected that there would be a difference in the frictional resistance of cast steel and cast iron wheels, but such a large difference was not anticipated, and the problem of assigning a reason for this great difference became more difficult when it was found that the mated cast iron wheels with good contours gave a higher frictional resistance than did two sets of non-

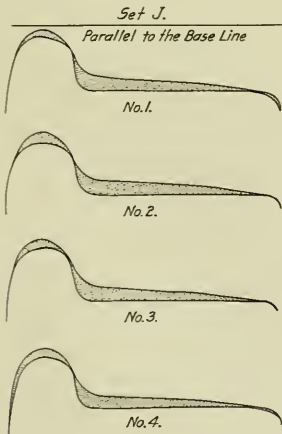

Fig. 10—Set J: Slightly Non-mated Davis Cast Steel Wheels.

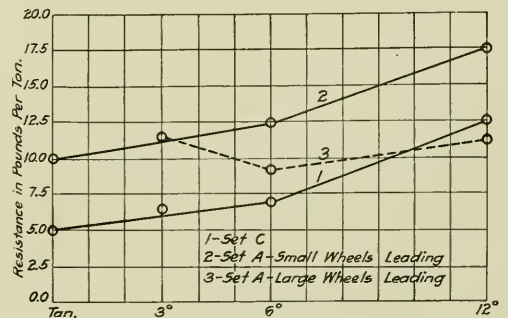

Fig. 11—Average Resistance of Sets A and C on Different Tracks.

mated wheels with contours not so good. At this time, and with the data at hand, no satisfactory explanation can be given for the action of the mated cast iron wheels.

ally increases up to 6 deg. curvature, and from that point to 12 deg., the slope was more pronounced. The lower line in Fig. 11 appears as such in all the succeeding diagrams.

Set A. Line 2 in Fig. 11 was plotted from the average resistance obtained when the mated cast iron wheels, designated

Another interesting feature is shown by the dotted line 3 in Fig. 11. In conducting the work, a series of tests was made with wheels 1 and 2 leading, and another series with 3 and 4 leading. Reference to Table 1 will show that wheels 3 and 4 were larger in circumference than were wheels 1 and 2. It was found that the average resistance in pounds per ton for

the series with the large wheels leading was less than when the small wheels were leading, as the dotted line in Fig. 11 shows.

Set B. The lines 2 and 3 in Fig. 12 show the relation that existed between frictional resistance and degrees of curvature when Set B was used. Two series of tests were made, one being with the large wheels on the outside rail of the curve, and the other with the large wheels on the inner rail. Line 2

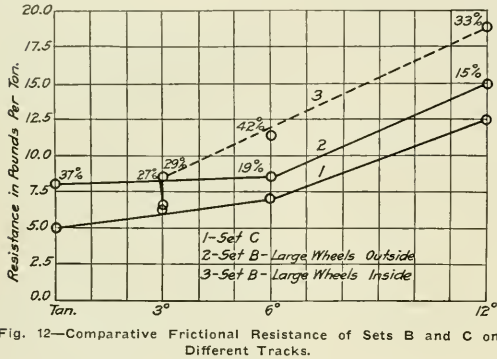

Fig. 12—Comparative Frictional Resistance of Sets B and C on Different Tracks.

represents the results obtained when the large wheels were on the outer rail, and line 3 when the large wheels were on the inner rail. It is obvious from the relative position of lines 2 and 3 that the friction was considerably higher when the large wheels were on the inside of the curve than when on the outside. Table 3 shows the higher friction obtained when the large wheels were on the inside of the curve.

TABLE 3.

Track.	3 Deg.	6 Deg.	12 Deg.
Resistance in lbs. per ton—large wheels inside.	8.5	12.0	18.8
Resistance in lbs. per ton—large wheels outside	8.25	8.5	14.75
Lbs. in favor of large wheels outside.....	.25	3.5	4.05

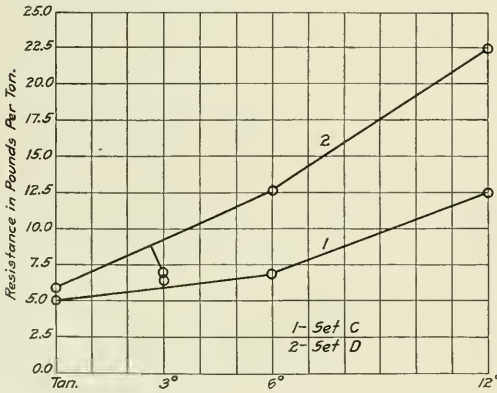

Fig. 13—Comparative Frictional Resistance of Sets C and D on Different Tracks.

Set D. The curve for the medium new wheels D, Fig. 13, is similar in character to the other diagrams. The values in Table 4 show to what extent the friction for this set of wheels differed from those of Set C.

TABLE 4.

COMPARISON OF SET C AND SET D.

Track.	Tangent.	2 Deg.	6 Deg.	12 Deg.
Resistance in lbs. per ton, Set D....	5.75	9.1	12.6	22.4
Resistance in lbs. per ton, Set C....	5.0	6.0	6.9	12.5
Lbs. in favor of Set C.....	.75	3.1	5.7	9.9
Per cent. in favor of Set C.....	13.0	34.0	45.2	44.1

Set E. The curve for Set E, Fig. 14, does not differ in its general tendency from that for Set D. It is also obvious from the values in Table 5 that the friction for the non-mated wheels E is approximately the same as for wheels D, with the exception of the tangent track friction, whereon the Set E gave a

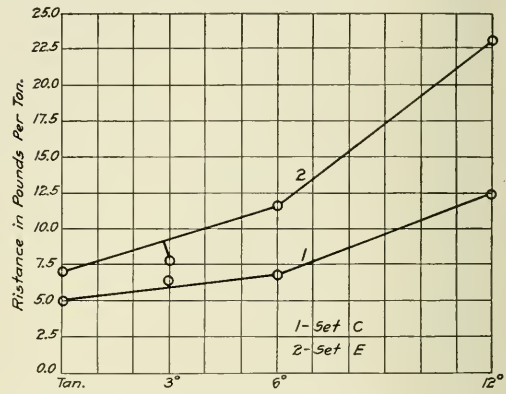

Fig. 14—Comparative Frictional Resistance of Sets C and E on Different Tracks.

higher resistance. The Set E was so tested as to have the large wheels on the inside of the curve, which gave a higher frictional resistance than there would have been had the large wheels been on the outside of the curve. The reason for the comparatively low friction for Set E, which were non-mated

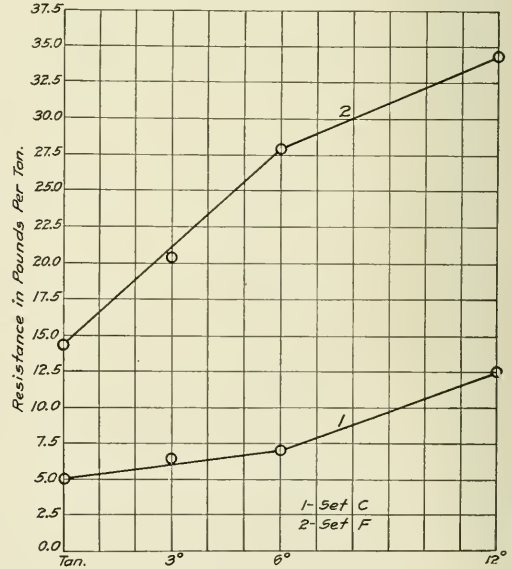

Fig. 15—Comparative Frictional Resistance of Sets C and F on Different Tracks.

to the extent of $\frac{3}{8}$ in., as compared with Set D, the same wheels as E, but mated, is due to the fact that the condition of testing on the 6-deg. and 12-deg. tracks was not the same for the two different sets of wheels. On the two tracks mentioned, Set E was tested at 19 miles an hour, whereas Set D

was tested at 23 miles an hour. This difference in initial speed no doubt accounts for the low friction of Set E.

TABLE 5.
COMPARISON OF SETS C AND E.

Track.	Tangent.	3 Deg.	6 Deg.	12 Deg.
Resistance in lbs. per ton, Set E....	7.0	9.25	11.6	23.0
Resistance in lbs. per ton, Set C....	5.0	5.0	6.9	12.5
Lbs. in favor of Set C.....	2.0	3.25	4.7	10.5
Per cent. in favor of Set C.....	28.5	35.1	40.5	45.6

Set F. Reference to Fig. 6 will show that the wheels in Set F had very bad flanges and that they were not mated. To what extent this wheel condition influenced the frictional resistance is obvious from the curves in Fig. 15, and from the percentages recorded in Table 6.

TABLE 6.
COMPARISON OF SETS C AND F.

Track.	Tangent.	3 Deg.	6 Deg.	12 Deg.
Resistance in lbs. per ton, Set F....	14.4	24.0	27.75	34.3
Resistance in lbs. per ton, Set C....	5.0	6.0	6.9	12.5
Lbs. in favor of Set C.....	9.4	18.0	20.85	21.8
Per cent. in favor of Set C.....	65.2	75.0	75.1	63.5

Set G. The wheels in Set G were non-mated and were so mounted that the two larger wheels were on the same side of the track. The points on line 2 in Fig. 16 were plotted by taking an average of the resistance in pounds per ton for all runs made with the large wheels on the outside rail of the curved tracks and the broken line 3 represents the relation between degrees of curvature and frictional resistance when the large wheels were on the inner rail of the curved tracks. As has been shown in a preceding paragraph, the friction is materially increased by the use of non-mated wheels, and for

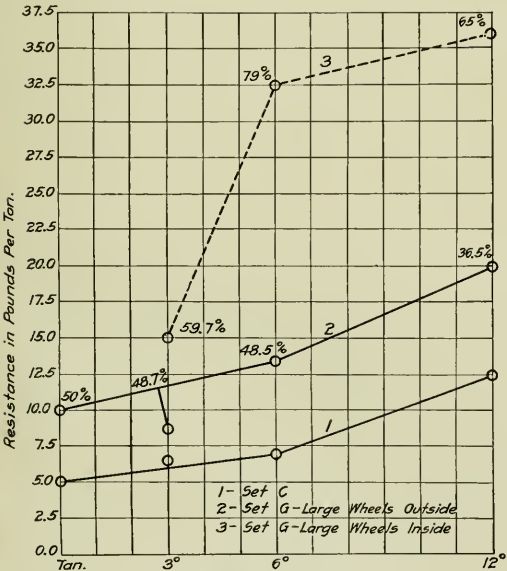

Fig. 16—Comparative Frictional Resistance of Sets C and G on Different Tracks.

the same wheels the frictional resistance is much larger when the large wheels are on the inside rail.

The values given in Table 7 clearly demonstrate this point, as do the curves.

TABLE 7.

Track.	3 Deg.	6 Deg.	12 Deg.
Resistance when large wheels were on inside....	14.9	32.6	35.8
Resistance when large wheels were on outside rail	11.7	13.4	19.7
Lbs. in favor of large wheels outside.....	3.2	19.2	16.1

Set H. There was a peculiar combination of wheel conditions in Set H. The pair composed of wheels 1 and 2 was mated, whereas 3 and 4 were non-mated, wheel 3 being smaller than 4 by 1/4 in. It is also to be noted that the wheels on the same side of the truck were not mated, that is, wheel 3 was 1/4 in. smaller than wheel 2. This peculiar condition no doubt accounts for the inconsistent results plotted for line 2 in Fig. 17. The points for the 3-deg. and 6-deg. curves do not fall in their proper relation to the other points, as has been true for other wheels. The line 2, which represents the relation between degrees of curvature and frictional resistance, was drawn straight because in another feature of the tests conducted, it was found

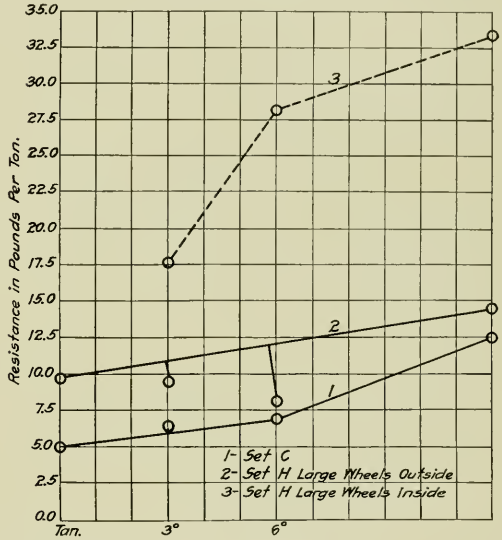

Fig. 17—Comparative Resistance of Sets C and H on Different Tracks.

that this relation for all wheel conditions could be represented by a straight line.

Set I. A comparison of wheel sets C and I is of especial importance, since they were made of the same material, so that any difference that is evident may be taken as directly due to a variation in wheel conditions. The wheels in Set I had all of the coning removed and the flange ground to an approximate height of 3/4 in. This is clearly shown in Fig. 9. The curves plotted in Fig. 18 and the values tabulated in Table 8, serve to emphasize the importance of coning. With wheels identical in every regard, except that one set has the normal coning and the other has all coning removed, the wheels with no coning gave from 60 to 70 per cent. more friction.

TABLE 8.
COMPARISON OF SETS C AND I.

Track.	Tangent.	3 Deg.	6 Deg.	12 Deg.
Resistance in lbs. per ton, Set I....	14.6	19.4	24.1	33.6
Resistance in lbs. per ton, Set C....	5.0	6.0	6.9	12.5
Lbs. in favor of Set C.....	9.6	13.4	17.2	21.1
Per cent. in favor of Set C.....	65.7	69.0	71.3	62.8

Set J. The wheels used in Set J were the same as those used in Set I, with the exception that they were ground so as to be slightly non-mated. The difference in mating was so slight, however, that the results were not materially influenced thereby.

It is obvious from the comparison made between Set C and Sets I and J that the removal of the coning greatly increased the frictional resistance.

To summarize the comparisons that have been made for each

set of wheels with Set C, and to show the relative merits of each set, the diagrammatic exhibit in Fig. 19 is shown. The values plotted are the average resistances in pounds per ton for all runs made on all tracks, for each set of wheels. It is obvious from this diagram that the mated cast steel wheels gave a lower resistance than any other set of wheels. A careful study of the wheel conditions as set forth in Table 1 and as portrayed in the exhibit of wheel contours, confirms the statement that the results as shown in Fig. 19 are entirely con-

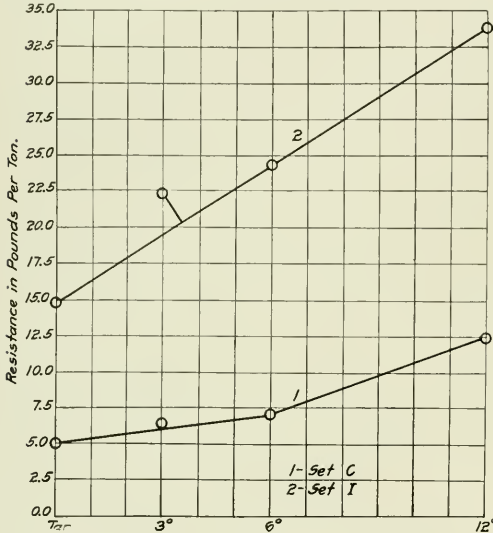

Fig. 18—Comparative Frictional Resistance of Sets C and I on Different Tracks.

sistent with the exception of Set A. As before mentioned herein, no reason can be assigned as to why the mated wheels of Set A gave such high resistance.

SUMMARY.

In order to make a more general analysis, the sets of wheels were grouped into five groups as follows: Group 1, designated as mated and composed of Sets A, C and D; Group 2, designated as non-mated new and medium new, and composed of Sets B and E; Group 3, designated as medium old and com-

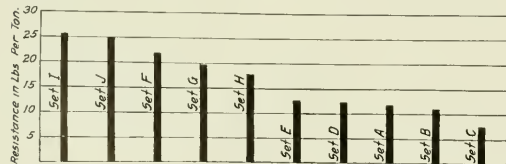

Fig. 19—Average Resistance Obtained for all Tests on the Four Tracks.

posed of Set H; Group 4, designated as non-mated old and composed of Sets F and G; Group 5, designated as special non-aging and composed of Sets I and J.

The resistance in pounds per ton for each group was averaged and the results plotted as shown in Fig. 20. It is obvious from these curves that the condition of the mating and of the contours of the wheels has a very important bearing upon the frictional resistance. It is also important to here call attention to the fact that all of the plotted points for the 3-deg. curve fell below the general tendency of the line for the other three

tracks. This is particularly noticeable in Fig. 20, but it also appeared in almost all of the curves for the individual sets of wheels. This is no doubt due to the fact that for a 3-deg. curve there is sufficient coning of the wheels to compensate for the difference in length between the outer and inner rails of the track, but that at some point between a 3-deg. and 6-deg. curve, there is not sufficient coning; therefore, the friction for any degree of curvature beyond that point increases at a greater ratio.

The numerical values for the several groups as obtained from the curves in Fig. 20, are given in Table 9.

TABLE 9.
AVERAGE RESISTANCE IN POUNDS PER TON, FOR EACH GROUP.

Group.	Track.			
	Tangent.	3 Deg.	6 Deg.	12 Deg.
1—Sets A, C, D.....	5.8	8.5	10.1	16.5
2—Sets B, E.....	7.5	9.3	10.8	20.0
3—Set H.....	9.7	13.6	17.4	25.0
4—Sets F, G.....	12.2	18.7	25.3	31.0
5—Sets I, J.....	14.2	21.2	28.2	36.0

A diagrammatic comparison of the five groups is shown in Fig. 21. The average resistance in pounds per ton for all four

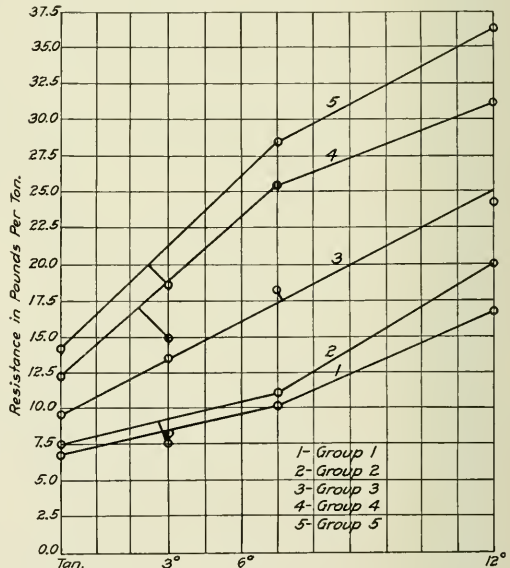

Fig. 20—A Comparison of the Resistance According to Groups as Shown on Table 9.

tracks as given in Table 9 was determined for each group of wheels, and these averages plotted as shown. This diagram indicates that the two first groups gave a comparatively low resistance. This is easily accounted for because the flanges and treads of the first two groups of wheels were what would be termed as in good condition. The three remaining groups of wheels, as is evident from the diagram and curves, produced considerably more friction than the first two groups, which is due to high and sharp flanges, and to the absence of coning. The friction for the two worst groups is 112 per cent. higher than for the two best groups. For this reason, wheels should have as near perfect contours of flanges and treads as it is practicable to make them, and it is very essential that only wheels of like tape measurement be mounted upon the same axle. It is very important to notice that the highest resistance obtained, notwithstanding some of the wheels had very sharp flanges, was recorded for wheels with no coning.

CONCLUSIONS.

From a study of the data obtained upon four different tracks and while using ten different sets of wheels, the following conclusions seem to be justified:

First.—Wheels should be exactly mated in order that frictional resistance be a minimum.

Second.—Mated cast steel wheels will give less resistance than any condition of cast iron ones. The per cent. in favor of the



Fig. 21—Average Resistance for Each Group on the Four Tracks.

mated cast steel wheels over the results obtained from the two best sets of cast iron wheels was 35. All of this gain in per cent. may not be directly due to difference of wheels, because there may have been more journal friction on some of the sets than others. But since due precautions were taken to insure the minimum amount of journal friction in every case, it is thought that the greater portion of the per cent. in favor of the cast steel wheels is due to the difference of material out of which the wheels were made. It is regretted that more of the mated cast steel wheels were not tested in order that more

friction obtained for any test was for wheels which had all the coning removed.

In view of the importance of the subject and since the data herein submitted throws some light upon the problem, it seems that a detailed and exhaustive investigation should be made to determine the best contour of wheel treads and flanges. The writer is of the opinion that such an experimental plant as was used at Granite City by the American Steel Foundries for the truck tests would be suitable for making a thorough investigation of the proper coning to use and to investigate other questions concerning wheel treads and flanges.

SEVENTY-TON HOPPER CAR

The Birmingham Southern recently received from the Pressed Steel Car Company, Pittsburgh, Pa., 80 hopper cars of 70 tons capacity. These weigh 58,600 lbs., 38,700 lbs. of which is in the body and 19,900 lbs. in the trucks; this is considerably more weight than would ordinarily be necessary for a 70-ton car of ample strength, but these cars have been built to withstand very severe service. They have a capacity level full of 2,840 cu. ft., and with a 10 in. average heap, of 3,157 cu. ft. The ratio of the paying load to the total weight of the loaded car is 72½ per cent. The general dimensions of the cars are as follows:

Length over striking plates.....	41 ft. 8 in.
Length over end sills.....	41 ft. 3½ in.
Length inside.....	40 ft. 0 in.
Distance center to center of trucks.....	32 ft. 0 in.
Width over side stakes.....	10 ft. 1½ in.
Width inside of body.....	9 ft. 6 in.
Height, rail to top of coke rack.....	12 ft. 0½ in.
Height, rail to top of brake mast.....	12 ft. 9 in.
Length of drop doors in clear.....	about 3 ft. 6¾ in.
Width of drop doors in clear.....	about 3 ft. 4¾ in.

The cars are equipped with 16 drop doors, made of ¾ in. pressed plates reinforced by flanges and operated by the "Lind" door gear, which is self-locking and when the doors are closed guards against the accidental discharge of the lading. The total door area is 97 sq. ft., and the hopper sheets are 5/16 in.



Seventy-Ton Capacity Car with Four Hoppers.

data for comparison with the other wheels tested might be available.

Third.—Wheels with sharp and high flanges, as Set F, give 123 per cent. more friction than wheels with comparatively good flanges, as Set B.

Fourth.—The coning on wheels is of great value in reducing flange friction on curved tracks. It was found that the greatest

thick. The trucks are of the arch bar type with 6 in. x 11 in. journals and are equipped with Reliance truss type bolsters, pressed channel brake beams, rolled steel wheels and adjustable side bearings.

The car body is designed to carry a uniformly distributed load of 154,000 lbs. The body bolsters are built integral with the underframe, each bolster consisting of a web plate made of ¾

in. open hearth steel with a cast steel center brace, reinforced at the top by a $\frac{1}{2}$ in. plate, and at the bottom with four $3\frac{1}{2}$ in. x $3\frac{1}{2}$ in. x $7/16$ in. angles. The body center plates are cast steel and the side bearings pressed steel. There are three cross ridges of $\frac{1}{4}$ in. plate reinforced at the top by 3 in. x $\frac{1}{2}$ in. bars, and at the bottom by 6 in. x $3\frac{1}{2}$ in. x $7/16$ in. angles. Four diagonal braces are used, consisting of 6 in., 10.5 lb., channels extending between the bolsters and the end sills. The two center sills consist of 12 in., 40 lb., channels extending from end sill to end sill and are tied together and reinforced at the top by a $19\frac{3}{8}$ in. x $\frac{1}{4}$ in. plate. The end sills are 12 in., 20.5 lb., channels reinforced at the top by $3/16$ in. pressed plates, and at the coupler opening by a cast steel striking plate to which is bolted the malleable iron coupler carrier. The junction of the end sill and the side of the car is reinforced by a malleable iron push pole pocket. The side sills are 10 in., 15 lb., channels, and extend from the bolsters to the end sills.

The end sheets are $5/16$ in. thick, reinforced at the top by flanges and pressed steel floor connections and connected to the end sills by two pressed steel channels and two angles at each end. The floor sheets are $5/16$ in. thick and the side sheets $\frac{1}{4}$ in. thick, reinforced at the top by $3\frac{1}{2}$ in. x $3\frac{1}{2}$ in. x $3/8$ in. angles, at the bottom by 3 in. x 3 in. x $3/8$ in. angles, and vertically by eleven stakes on either side of the car made of $\frac{1}{4}$ in. pressed steel. The sides are tied together by four cross-ties made of 6 in., 15.7 lb., Z-bars.

NEW END CONSTRUCTION FOR PULLMAN CARS

There has been much discussion during the past few years regarding the best type of end construction for passenger equipment cars and after a study of recent wrecks it has been decided by the Pullman Company that a new arrangement is necessary to

of the Pullman Company. All of the modern Pullman equipment is provided with the Commonwealth steel underframe, which has a cast steel combined platform and double body bolster at each end and this underframe readily permits of the new end construction in combination with which a very efficient arrangement is obtained.

The principal feature of the design is that of an I-beam bent in the form of a U, the legs of which extend upward through apertures in the platform casting. The upper ends of these I-beams are thoroughly anchored in an end superstructure made up of structural shapes. Two of these U-shaped I-beams are applied on each end of the car in the manner shown, one leg forming the door post at the entrance of the car, while the other forms the door post for the opening between the cars at the platform end sills. The U-shaped members are made from one continuous I-beam instead of being made up of riveted sections, in order to eliminate any possibility of riveted joints failing. With this construction it is readily seen that in case of collision, should one underframe override that of the next car, its progress will first be obstructed by the legs of the U-beam at the bumper sill, which as they bend will tend to lift the whole car body, thereby offering greater resistance to further advance of the overriding car. If these should fail there would still be the second leg of the U-shaped member, together with the strengthened car end, to further retard the progress of the overriding underframe.

This new car end is being applied to all new Pullman cars and to all high class wooden cars as they pass through the shops for general repairs. Mr. Dean in his patent claims states that unduly strong underframes, instead of affording the presumed advantages of safety to passengers and of preserving the cars from injury, may, at least in some instances, contribute to the damage of the latter, especially when the force of the collision is sufficient to cause the overriding of the underframes, resulting in the breaking down of the end wall of the car. It is

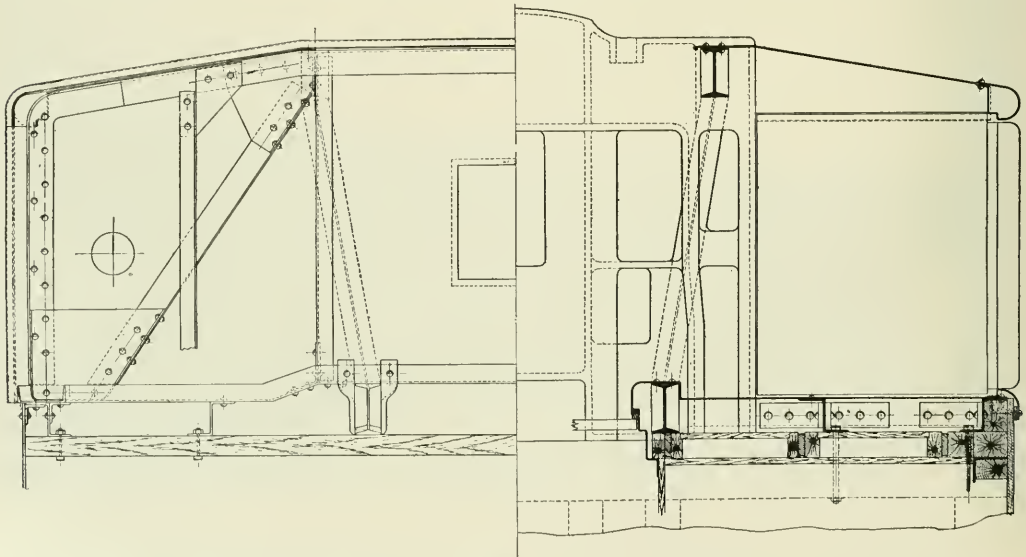

Top and Floor Plans of New End Construction for Pullman Cars.

withstand the shearing effect that the heavy steel underframing of a car has upon the superstructure of another car when one underframe overrides the other in a collision. The new design adopted is the invention of Richmond Dean, general manager

his idea to remove the surplus strength from the underframe and so construct and strengthen the vestibule, as described above, that it will act as a cushion to absorb and dissipate the force of the impact of such a collision without materially increasing the

weight of the car. Throughout the construction it has been his idea to reduce the number of riveted joints to a minimum.

The new car body end wall is securely fastened to the cast steel combined platform and double body bolster, and is made up of Z-bar end posts extending to the top of the roof, and secured to the other parts of the car framing in the usual manner. The outer faces of these posts are riveted to a channel sill above the doorway, which is bent to allow for the rear legs of

FREIGHT CAR DESIGNING

BY E. G. CHENOWETH,

Mechanical Engineer, Car Department, Rock Island Lines, Chicago, Ill.

So much has been written in connection with freight car design that it would seem that the ideal construction, or a 100 per cent. car for some particular service, had been obtained. Or at all events it would seem that the proper items should have been considered in car construction so that the car would keep off the repair tracks. Perhaps a great deal more will be written before even a small portion of those interested in the design and maintenance of the equipment will be satisfied in their own minds that a perfect car of any class has been built, not to mention the numerous classes which are to be covered. There is also a question as to the best method to produce the best design.

It is believed by some railway officials that the drawings should be made and specifications written by the outside car builders, although it is strenuously objected to by others. It is claimed in the first case, that the builders are better organized in their engineering offices to develop a design to meet the railway company's requirements, and apparently at a less cost, as the cost is included in the price of the lot of cars, and perhaps is not felt by the railroad. In the second case it is held that the users and maintainers of the equipment would better know their own standards, and would be more liable to maintain them in the construction than the builder. And still further, which appeals to the writer as being very important, the railroad, knowing just what facilities are available throughout the system for making repairs, would design the cars accordingly. Maintenance is one of the most important factors in railway operation and anything that will reduce maintenance costs should be considered.

Statements have been made that car builders should design equipment and be responsible for weaknesses which may develop later on, but this is not the customary procedure. In the majority of cases the builder submits the drawings and specifications to the purchaser for checking and approval, which naturally relieves the builder from the responsibility as to the details of the design. It may be said that if the drawing office checks the drawings and specifications, as they are furnished by the builder, all weaknesses will be eliminated, but if the railway does not maintain a sufficient drafting force to draw up the original designs, it will not have the force to thoroughly check the drawings, and further, the time making an accurate check will not be much different from that taken to make the drawings.

If the railroad designs its own freight cars, arrangements should be made whereby all foremen concerned in maintaining the cars could go over drawings and specifications with the designer and understand all parts of the design. This makes the shop men feel a personal responsibility in the cars, and they will watch closely for weaknesses which may develop in service.

In an article which was recently printed in an engineering journal, the author left the impression that if it was desired to design nearly a perfect car it was only necessary to have the practical car men prepare the drawings and specifications. This may, or may not be conceded as the truth, it surely all depends on what is understood by a practical car man. Perhaps some one may say that a practical car man is a person who is a shop man, has repaired cars, has charge of the maintenance of cars, can read a drawing and specification, and understands the construction of a car thoroughly. Again, others will say that a practical car man is a person who has had the experience of repairing cars and maintaining equipment, and can design a car, making all the drawings and specifications, calculating the stresses and strains, and has an understanding as to the strength of the materials entering into the construction. Which is the practical man? The writer will not commit himself as to his belief, but the reader can use his own judgment as to whom he would desire to design equipment for him, were he the man "higher up."

The weaknesses and failures developing every day are not all

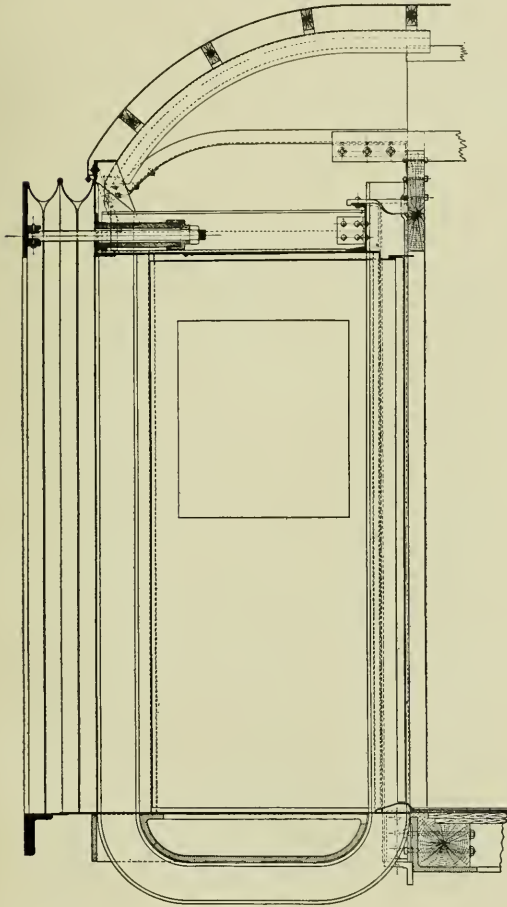

Side Elevation of U-Shaped Member in Pullman End Construction.

the heavy U-shaped I-beams; the remainder of the vestibule is constructed to harmonize with the new features. It is believed that this new design will be the means of preventing the disastrous results that have been recently experienced with the ordinary type of end construction in collisions.

REPORTING FOREST FIRES.—The Western Pacific has instructed its engineers to report fires along the right-of-way where it traverses the Plumas national forest in California. The location of fires is indicated on a card dropped by the engineer or fireman to the next section crew met after the fire is discovered. It is then the duty of part of the section crew to go back on hand-cars or speeders and put out the blaze.

due to the designer, whether he be practical or otherwise, as there are many conditions and requirements that must be met over which the engineer has no control. It is often the case that limitations are placed on a design by the requirements of the shippers, the necessity of using certain specialties, the required light weight, or the original cost, which, perhaps, do not allow the designer to follow out in every respect the dictates of his own judgment. The cost of hauling an extra ton of dead weight of car will pay, in some cases, for the repairs that would have been necessary had the car been lighter. However, it must be remembered that a car on the repair track is not in revenue service, and therefore an extra strong car should be given credit for more days in actual service.

It has been the practice of some railways to design the cars, build samples and have them carefully inspected and then put through an accelerated test. In many cases, if time will allow, the car is placed in service for a few days or weeks to ascertain if all the details are properly designed, or, in some cases, the car is loaded considerably in excess of its marked capacity, and the deflections and the permanent set are carefully noted. Although the building of a sample car gives a proper check on the drawings and specifications, it is questionable if any of these tests furnish all the information desired, for the reason that it is not the cars that fail under a static load or under a few days' service which give the trouble, but those that will not withstand the years of rough treatment given to a freight car in service. Again, if the sample car is placed in regular service, it must be realized that perhaps it would never get in such service as to show its weaknesses, while if a great number of the same design were put in use several weaknesses might be developed.

Rapid strides are perhaps being made toward a perfect freight car design, and perhaps it has been reached in some rare instances, but it is hard to be convinced that there are many perfect cars after checking bad order cars on repair tracks for a year, and moreover, if a perfect design has been developed, it is surprising to note that when railroads consider the purchase of new equipment they, as a rule, modify the present designs or develop entirely new ones. This, however, clearly shows that the designers are untrusting in their efforts and by a closer observation of the present cars on the repair tracks, ascertaining the weaknesses that have developed in service, there should be marked advances toward better designs. It is feared that in many cases not enough attention is given to the fact that new cars have shown weaknesses, which the designer is slow to acknowledge as weaknesses as they may require some changes or even the abandoning of his entire design. It is not advisable, however, to make changes in the design on the first report of any weakness before a thorough investigation is made as to whether or not the damage was done by fair or unfair usage. In this connection it is advisable to furnish standard forms at all freight car repair points which will furnish all the information desired.

Constant inspection at the repair shops and yards leads one to believe that the increase in strength of the freight cars is not keeping pace with the increase in the severity of the treatment that the cars are receiving in service. Much effort has been made to procure good draft gear, and perhaps an equal amount of thought has been given to its proper application to freight cars. Some steel underframe designs show the draft sill spliced to the center sills between the end sills and the bolster, just back of the draft casting, it being claimed that if the cast draft sills are damaged, they can be replaced without removing the center sills, which is plausible as far as it goes; but others claim, in cases where the center sills extend through to the end sills, acting as draft sills, that if the sills are broken they can then be spliced and thus save the original cost of the splicing of the sills. All who have followed up the repairing of freight cars will appreciate the fact that if the draft gear and the draft sill maintenance could be eliminated the cost would materially be decreased. In making a check of the cars on the repair tracks,

taking all cars indiscriminately, it was found that 70 per cent. of the repairs necessary were in relation to the draft rigging, but, as a majority of these were on wooden underframe cars, some improvement along this line is anticipated as steel is substituted for wood.

In the preparation of drawings and specifications for new freight car equipment, the following are some of the parts of the design which should be carefully checked for weaknesses that may develop in service:

On steel underframe or steel cars, the corner back of the push pole pocket should be properly backed up with a casting or a steel gusset. It would seem that the general opinion is that on steel cars the diagonal brace between the bolster and the end sill should extend from the corner of the car to a point near the junction of the draft gear, or center sills, to the bolster. This then becomes a compression member, and of course should have an ample moment of inertia, both in the vertical and horizontal planes. A heavy angle has been used in this place with good success. It is well to carefully figure the shear on the rivets, securing this member at both ends. Some readers will no doubt, bring up an argument in favor of running this diagonal brace from the intersection of the side sill and bolster to the intersection of the end sill and draft sills, but it is the belief of the writer that the draft sill should be of such a design as to withstand the buffing forces without its being necessary to transmit part of the load to the side sill at the bolster by the use of the diagonal braces. Whether the application is made according to the first or second method, it is recommended that a compression member be used, and this has not been done in a great many of the recent designs.

Many types of box car roofs have been designed and applied, and have been given a good service test, but the subject is still a lively one for discussion. Even with the improved designs on the market of both inside or outside metal and all-steel roofs, the mechanical man is still in a quandary as to just which one to recommend for new equipment. They all have their good features. The inside and outside metal roofs have been in use for years, and some data as to original cost and cost of maintenance should by this time easily have been procured, but the type which is known as the all-steel roof has had recent improvements, and it appears that no very marked perfection has as yet been obtained. A roof, of whatever design, must be flexible, and at the same time the metal sheets of which it is constructed must so fit and be so secured to the car that the roof will present a perfectly water-tight construction. It is an interesting fact and a matter of record that the majority of the roofs which require renewing do not have the metal sheets rusted out but are actually worn or broken at the joints or where they are secured to the car, with the exposed part of the sheet in good condition. It, therefore, would seem that the application of the roof to each particular car is an important factor. The flexibility of the roof must be equal to or greater than the flexibility of the car body, and this has been a problem of the roof designers which apparently has not entirely been met.

The tendency at the present time is to increase the amount of steel in freight cars; the box car is getting a steel upper framing, and box cars of all-steel are being built which will probably be given a thorough service test to ascertain if they are entirely feasible. In making a study of the design of cars which have been delivered, or of those which are only contemplated, one is convinced that there is a tendency to get away from a uniformity of design of most all classes of equipment. The use of steel in the construction of cars has brought about many new or novel designs, and some indeed appear directly opposed, yet will no doubt well answer the purpose for which they are designed. It is easy to find cars of the same capacity and class having a one-piece center sill, a two-piece center sill with narrow side sills, or two center sills with a side sill equal in depth to the center sills; all without truss rods—a matter of opinion of the designer, but not tending toward a uniform steel underframe construction.

NEW DEVICES

IMPROVED FLOW METER

In large power plants, etc., the economical handling of steam, water and air depends on accurate information which will show the total volume transmitted and its instantaneous rate of flow during any interval of time. The meter shown in the illustrations is designed for use either as a test instrument or as a stationary meter. The body consists of an iron casting cored out so as to form one leg of a U-tube and a reservoir for mercury, the outer leg of the U-tube being formed by a pipe which opens into the reservoir. The pressure on the surface of the mercury varies with the rate of flow of the fluid being measured, as will be explained later. A float rests on the surface of the column of mercury in the body of the meter and rises and falls with the corresponding change in its elevation. The

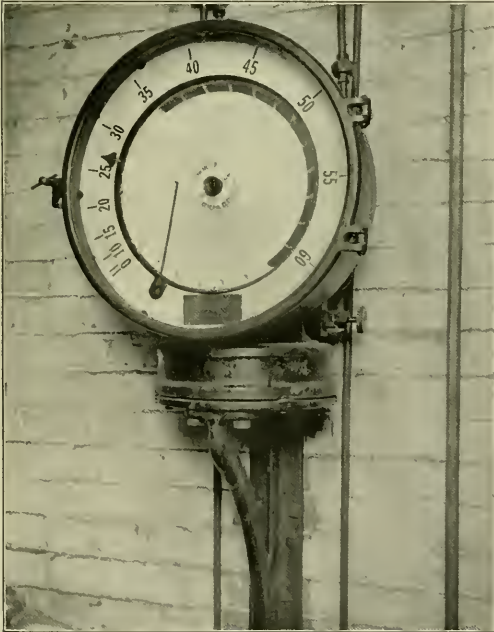

Indicating Recording Flow Meter.

float is geared by a rack and pinion to a horizontal shaft which carries a permanent U-shaped magnet. The poles of this magnet face a copper cap which closes an opening into the meter body and the remaining parts of the meter's mechanism are mounted on the outside of the cap. A shaft, parallel to the one on which the magnet inside the body is mounted, carries a smaller magnet, whose poles are opposite to those of the larger magnet, this arrangement serving to transmit motion through the cap without piercing it with a shaft. As the poles facing one another are of opposite polarity, the magnetic flux binds them together so that a movement of the magnet inside the body involves a corresponding movement of the one outside, the latter moving the indicating needle and the recording pen through suitable mechanism.

The pressure which moves the column of mercury in the U-tube is obtained, for pipes 2 in. and greater in diameter, by inserting a modified form of Pitot tube, termed a "nozzle plug," directly into the pipe line. This can be done without disturbing the piping, except where it is desired to increase the rate of flow at the point of metering, in which case a special pipe reducer is provided. This reducer is made of brass and has a long throat with rounded entrance terminating in a flange which is inserted between the pipe flanges and is held in place in the same manner as a gasket. A special nozzle plug is supplied with the pipe reducer. The nozzle plug is a tube with two separate conduits in it, each conduit having a set of openings, the two sets being on diametrically opposite sides of the tube. Those on the side of the tube facing the flow are called the leading openings, and those on the opposite side the trailing openings. The flow against the leading openings in the nozzle plug sets up a pressure in the leading conduit which equals the static pressure plus a pressure due to the velocity head; the

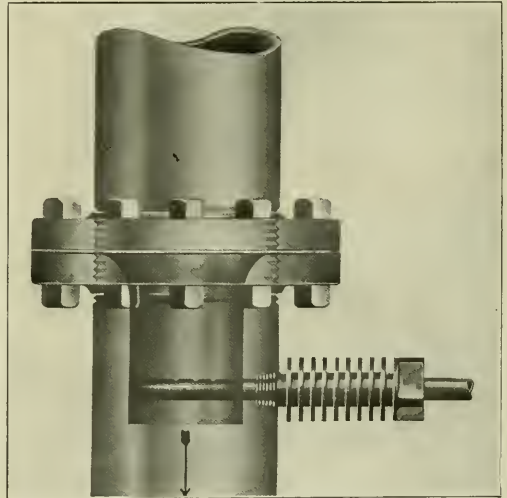

Pipe Reducer and Nozzle Plug.

flow past the trailing openings causes a suction which lowers the pressure in the trailing conduit. As these two conduits are connected to the U-tube by $\frac{1}{4}$ -in. pipes, the column of mercury is affected by this unbalanced pressure, causing a movement of the float. The leading set of openings in the nozzle plug extends approximately across the pipe, so as to make the velocity pressure transmitted to the meter the mean, rather than that at a single point in the pipe.

The chart on which the pen records are made is rotated by a clock work at a suitable speed. The recording pen sweeps the chart radially, and the resulting curve shows the rate of flow at any time during the chart cycle. The integrating device consists of a stationary flow-rate planimeter driven by the chart paper. The angular position of the planimeter wheel is determined by a cam connected to the shaft of the recording pen and moving with this pen. The planimeter dials read in arbitrary units, which, multiplied by a constant furnished with the

meter, gives the flow in the desired unit. This device is extremely simple and there is practically no danger of its getting out of adjustment.

For pipes less than 2 in. in diameter, an orifice tube, which is a brass pipe tapered internally from both ends and so as to form a restricted opening at the middle of the tube, is provided and must be incorporated in the pipe line. One leg of the U-tube is connected to the orifice tube near its end and the other leg to its middle point where the greater velocity at the orifice



Float and One of the Magnets of the Flow Meter.

will give a reduced pressure in the pipe leading to the U-tube.

To meet the requirements of different classes of service and the various conditions met with, this meter is made in four different ways—as a recording or curve-drawing instrument; with both indicating scale and recording chart; with recording chart and integrating dials; and with indicating scale, recording chart, and integrating dials. It is manufactured by the General Electric Company, Schenectady, N. Y.

OSMAN BOILER CHECK

In an article in the August issue of the *Railway Age Gazette*, *Mechanical Edition*, describing the Osman regrinding and pressure equalizing boiler check, it was stated that this device is manufactured by the Swenson Valve Company, Decorah, Iowa. This is incorrect, as the rights for the manufacture and sale of the valve are controlled by G. H. Osman, who is superintendent for that company.

AERIAL RAILWAY IN COLOMBIA.—By permission of the Colombian government, Thomas Miller, who held a concession from the government for constructing an aerial railway between Manizales, Pereira, or Neira, and the National Occidental Railway, has transferred his concession to the Dorada Railway, Ltd., of London. Six months' extension of time for putting the railway into service has also been granted.

UNITED STATES AIR BRAKE

The United States Air Brake Corporation, Buffalo, N. Y., has developed a system of locomotive and car air brake equipment which is now being tried out on three railroads, among which is the Buffalo, Rochester & Pittsburgh.

The principal feature of the locomotive equipment is the quick release, which provides three exhaust ports to insure the rapid escape of the air from the brake cylinders to the atmosphere. This feature does not interfere with the normal automatic release, as, when it is desired, one exhaust port may be used. Provision is also made for retarding the release when necessary, and the locomotive brakes can be graduated on or off independently from the train brakes whenever desired.

In addition to the triple valve, there is used in the car equipment what is termed a regulating maintaining valve, whose purpose is to prevent excessive piston travel and brake cylinder leakage. This valve is furnished with a supply reservoir, and

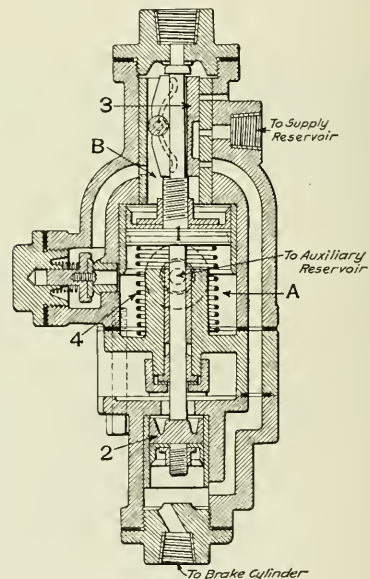

Regulating Maintaining Valve.

it is claimed that it will automatically increase the brake cylinder pressure in correct proportion to the brake pipe reduction, regardless of the piston travel, and that it will maintain that pressure during a brake application, regardless of ordinary cylinder leakage.

When the car equipment is being charged, air from the auxiliary reservoir enters chamber *A* of the regulating valve and passes the check valve, filling chambers *A* and *B*. When a brake pipe reduction is made the triple valve permits auxiliary reservoir pressure to flow into the brake cylinder, lowering the pressure in chamber *A*. Should the charge of air from the auxiliary reservoir be sufficient to exert a force on the underside of the small piston *2*, which combined with the force on the underside of the large piston *1* would equal the force on top of the latter, there would then be no movement of the parts in the regulating valve. However, should the piston travel be excessive and the force on the underside of the small piston not sufficient in combination with the pressure in chamber *A* to equalize with the pressure in chamber *B*, the large piston would then move down and bring the slide valve *3* in position to admit air from the

supply reservoir to the brake cylinder; when the cylinder pressure is increased so that the force on the underside of the piston 2 is sufficient in combination with the pressure in chamber A to equal the force in chamber B, the equalizing spring 4 will push the large piston and slide valve back, shutting off the supply reservoir from the brake cylinder. After the pressure in the brake cylinder has been increased to the proper amount, if there should be any leakage from the brake cylinder the piston 2 would again be forced down by the pressure in chamber B and again permit pressure from the supply reservoir to flow into the brake cylinder until the combined force on the undersides of the small and large pistons equalled the force on the top of the large piston; the equalizing spring would then again force the piston and slide valve up and close the port which admits air from the supply reservoir to the brake cylinder.

When the brake is released by increasing the brake pipe pressure and forcing the triple valve to release position, the sudden drop of brake cylinder pressure will cause the large piston to make a quick downward movement, carrying the slide valve down until its extreme end passes the small vent port, which allows the pressure in chamber B to equalize with that in chamber A; the equalizing spring will then force the large piston and the slide valve back to normal position. It is not necessary that the pressure in chamber B should be permitted to escape when the brakes are released, as the raising of the auxiliary reservoir pressure in combination with the force of the equalizing spring, will hold the large piston in its normal position.

RUMSEY MAIL CAR DOOR

The illustrations of the door sections show clearly how the features involved in the standard freight car door manufactured by the Rumsey Car Door & Equipment Company, Chicago, have been included in the mail car door recently developed by that company. When closed, the door is forced to a positive bearing on all four sides by the door post sealing flanges, which not only make it watertight but keep the cold out in winter.

The chief point of interest in the Rumsey car door is the pressed steel, unitary post structure which is anchored at the top and bottom to the car sills and into which the door inter-

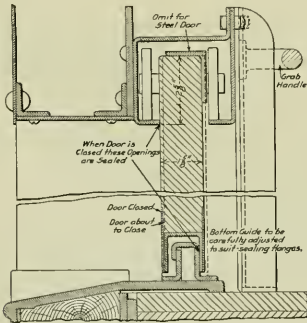

Vertical Section Through Rumsey Door for Postal Cars.

locks when closed, making it thereby an integral part of the superstructure. Any shock received by the door is transmitted through its interlocking feature to the posts, which by their anchorage transmit it to the superstructure. These pressed steel posts will stand a stress of 13,300 lbs. without the wood fillers and 15,000 lbs. with the fillers in place; to illustrate further, they take a stress equal to the resistance of a stick of oak 4 3/4 in. x 3 1/4 in. This represents the stress received at the center of the post, when No. 10 gage open hearth steel is used.

The combined steel and wood post is similar to what is known

as the Harriman standard. The steel member extends sufficiently beyond the face of the post to form interlocking sealing flanges whose functions are identical with those of the all-steel post, and this construction is recommended for rebuilt equipment and for stock cars, owing to its moderate cost.

This company has also designed a flush door which does not

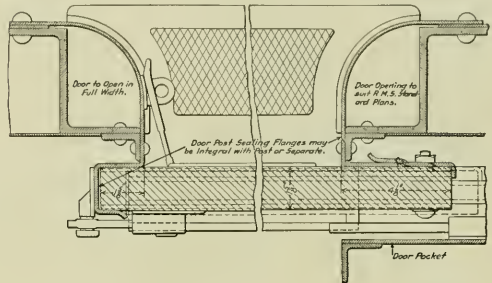

Horizontal Section Through Rumsey Postal Car Door.

interfere with the strength of the car superstructure and is the type recommended for stock and refrigerator cars. This particular type of door is also applicable to box cars.

BOYER PNEUMATIC SAW

A recent innovation in car building is the cutting and trimming of the car roofs with a Boyer pneumatic saw. A No. 2 Boyer air drill furnishes the power, and by a special arrangement of gearing, the speed of the spindle in which the saw arbor is fitted is brought up to 2,200 revolutions a minute. The

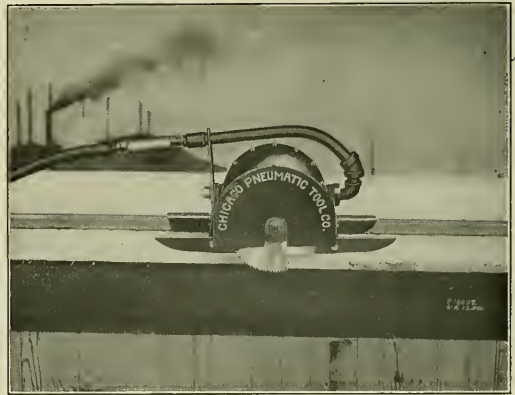

Boyer Pneumatic Saw Trimming a Car Roof.

motor itself rests on a grooved shoe which fits over a guide strip nailed to the car roof at the proper distance from the edge. The arbor, bearing an 8 in. circular saw, is also supported by a shoe. It will cut a 60 ft. car roof in 1 1/2 min. It is manufactured by the Chicago Pneumatic Tool Company, Fisher building, Chicago.

ERIE AND MAD RIVER RAILROAD.—A body of the United States Corps of Engineers are engaged in making a survey of the route from Sandusky city to Dayton, Ohio.—From the *American Railroad Journal*, October 27, 1832.

IMPROVED COAL SPRINKLER

Among the devices recently placed on the market for the use of locomotive firemen in sprinkling coal is the ejector which was developed by the Hancock Inspirator Company, Boston, Mass., and was described in the *Railway Age Gazette*, Mechanical Ed-

sprinkler and result in injury. With sprinkling devices having separate valves for the steam and water connections, there is always the possibility that the man operating the device will forget to open the water valve in the suction when starting the sprinkler, or forget to close it when shutting off the sprinkler. In an improved coal sprinkler which has been devised by the Hancock Inspirator Company, only one handle is used, and this operates both the steam and water valves. As shown in the drawing of the cross section, the sliding steam nozzle is so constructed that its front end overlaps the back end of the combining tube when the steam valve is closed, thus effectually closing the water opening; when the steam valve is open the steam nozzle which is attached to it is drawn back from the combining tube at the same time that the steam port is opened. The sprinkler, as shown in the other illustration, is located on the left hand side of the cab and takes its water supply from the suction pipe of the injector through a $\frac{3}{4}$ in. pipe. A $\frac{3}{8}$ in. globe valve is placed in the steam supply pipe to shut off the steam from the sprinkler when necessary.

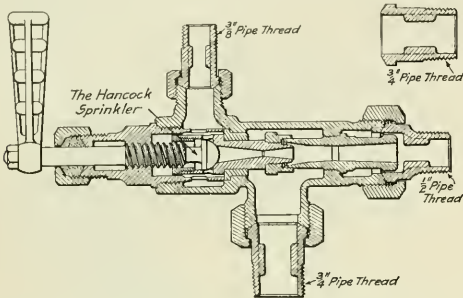

Improved Hancock Coal Sprinkler.

ition, June, 1913, page 334. Investigation of the subject of coal sprinklers has convinced the manufacturers that, as a safeguard, the apparatus should be operated entirely by one handle, so arranged that the water connection will positively be closed when

WASTE RETAINER FOR JOURNAL BOXES

The object of the attachment illustrated herewith is to keep the waste in a journal box from working forward and forcing open the lid, and to prevent it from piling up in front of the journal collar and away from the inner end of the journal. The device also prevents the waste from getting under the journal brass. As the waste is held close to the journal under the brass, the journal is kept lubricated at all times without becoming heated; furthermore, the device prevents cinders and dust from getting into the packing.

The side waste retaining members, *A*, are formed with curved extensions which serve to support them at the inner end. The front edge of each side member is provided with a lug, *B*, in which is a slot adapted to receive the closing gate, *C*. The

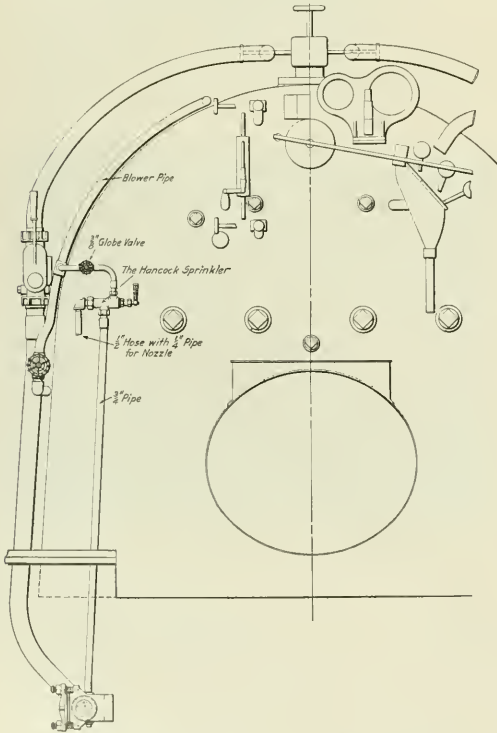

Coal Sprinkler in Position on Backhead of Boiler.

the sprinkler is not in operation. Unless the water passage is entirely closed when the injector is used for heating the water in the tank, steam is likely to back up through the suction pipe of the

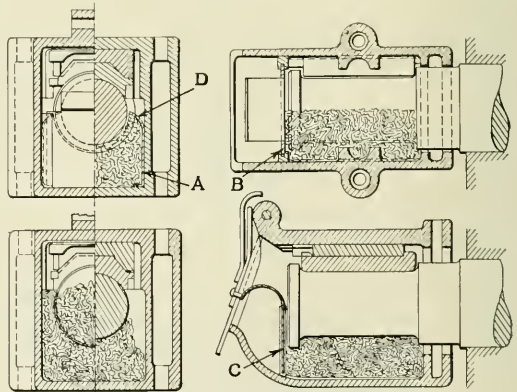

Device for Holding Waste in Journal Boxes.

upper edges of the side members are curved inward as shown at *D*, so as to come against the journal and serve as a stop to prevent waste from being dragged upward under the brass. The device is made of 1/16 in. sheet steel and can be applied by removing all the packing from the box and taking both side plates, which are wired together at the bottom at the back end, in both hands and sliding them into place. The brass and wedge can be removed without disturbing the retainer, and inspectors are also given a better opportunity to inspect the brass and journal on account of the packing being held down. It is also claimed that the packing necessary is reduced 50 per cent.

This device has been applied with great success to 750 50-ton freight cars, 5 coaches and the tenders of 30 heavy consolidation locomotives on the Pittsburgh, Shawmut & Northern. It was invented and patented by R. A. Billingham.

PRESSED STEEL CARLINE

A new style of pressed steel carline has recently been designed by the Cleveland Car Specialty Company, Cleveland, Ohio, in connection with the use of steel side plates in car framing. It is necessary that the carline should rest flat on the side plate with large bearing surface and the design illustrated is now being placed on a large number of cars with steel side plates. While it is intended for steel framing, it is equally

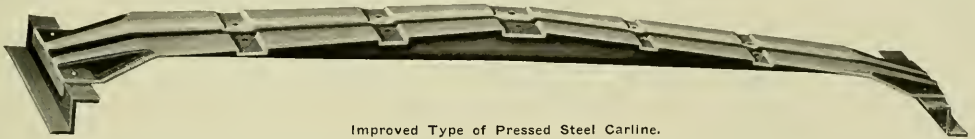

Improved Type of Pressed Steel Carline.

applicable to cars with wood side plates. In a recent test, it required a pressure of over 4,500 lbs. to deflect it when placed upon supports spaced the same interval apart as the side plates. The use of pressed steel for carlines has made it possible to produce a design in which the maximum strength is gained with a minimum weight, as the whole carline can be made from one piece of steel and the metal distributed where it is most needed.

HIGH DUTY RADIAL DRILL

In response to a demand for a radial drill which would be at once easy to operate and rigid and powerful enough to do the heaviest class of work, the Baush Machine Tool Company, Springfield, Mass., has brought out a 6 ft. machine having the

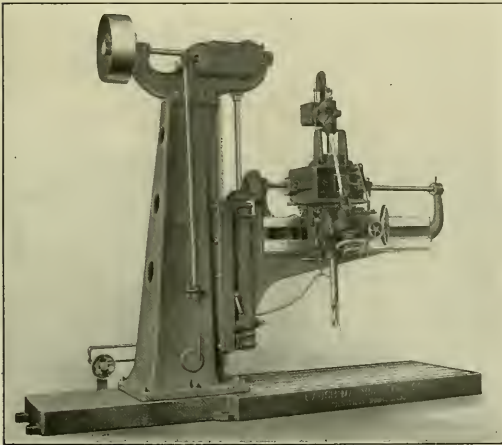

Heavy Service Six-Foot Radial Drill.

ings to take care of the thrust in either direction. The spindle proper, *c*, extends down through the head and is driven by means of a long sleeve, *d*, which in turn drives the feed mechanism from the lower end. The drive is accomplished by means of a pair of bevel gears, *e*, which are arranged to be clutched to the spindle, providing in this way a tapping attachment and at the same time a stop motion for the spindle when the clutch is in the intermediate position. The method of keying this clutch spindle to the driving sleeve is unusual in that it is accomplished by means of three lines of balls, *f*, mounted in ball cases and

itself is mounted on large trunnions which are provided with ball thrust bearings to take the weight, and roller bearings to provide for easy operation.

The head gearing is all enclosed in an oil-tight case, and the main drive consists of the conventional vertical shaft down to the center of the trunnion, and a horizontal driving shaft, *b*, extending through the head to an outboard bearing on the arm. Both of these shafts are provided with ball thrust bearings, and in the case of the two horizontal shafts, the one on the head of the machine and the one extending the length of the arm, roller bearings are added.

The gearing of the head proper is entirely enclosed, the feed being accomplished by means of worm and worm gearing and a pinion engaging in a rack, which is mounted on a quill on the upper end of the spindle. This quill is provided with ball bear-

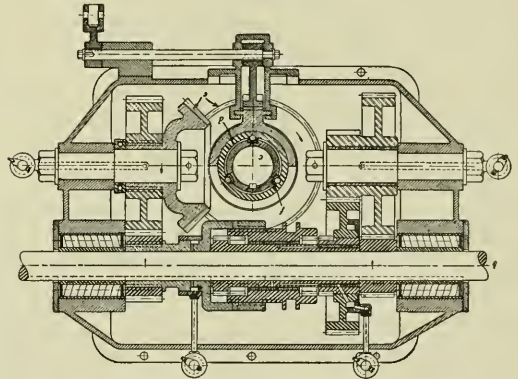

Horizontal Section Through Head of the New Baush Radial Drill.

traveling in hardened steel races, providing a clutch spline which moves practically without friction; it is therefore possible to start, stop or reverse the spindle with a minimum of effort on the part of the operator.

The back gears are carried in two nests, one on each side of the spindle and in enclosed oil tight case, thus providing a balanced head. The back gear is thrown by means of a lever on the front of the machine and is arranged to lock in either high or low position. The gearing and all bearings are oiled from the outside by means of sight feed cups. The bevel gears are all provided with ball thrusts and the bearings are bronze bushed. The gears themselves are alternately steel and bronze.

The machine is provided with six changes of feed by means of a sliding key, and also by a quick and slow hand feed; the

bed, arm and column, as well as the head mechanism, extremely heavy and rigid. The post is of rectangular box form, and is tapered to provide an ample base. The saddle carrying the arm trunnions is extra long and rigid, and is elevated with a screw. The arm

quick feed is provided for by a large hand wheel directly on the feed shaft, while the slow feed is obtained by a small hand wheel which is geared up to such an extent that back facing or counterboring can be accomplished. The feed has both automatic and hand knock-off, by means of a single lever, one motion of this lever stopping the feed in any position. For counterboring, facing or back facing, where an accurate dimension or a flat surface is required, the fine feed can be used until the tool reaches practically the dimensions required; the feed can then be instantly knocked off by means of the stop lever and a slight additional feed given by hand through the slow hand feed wheel. This reduces the hand labor to a minimum in doing fine work of this nature. The automatic stop for the feed is arranged principally to throw out at the end of the spindle travel to protect the machine against breakage, and it has an adjustable stop, so that the machine may be set to drill a certain depth.

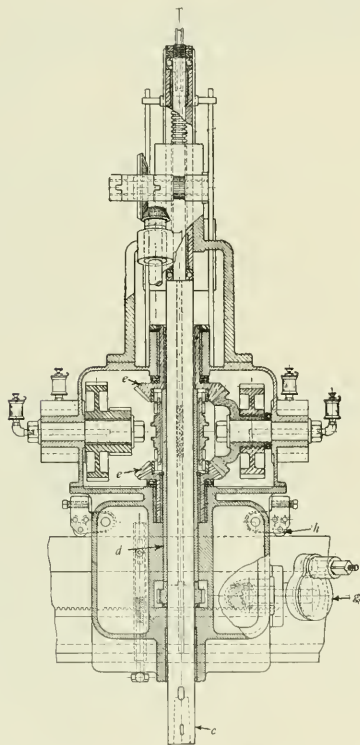

Vertical Section Through Head of Baush Radial Drill.

The traverse of the head on the arm is accomplished by means of a hand wheel and the spiral gearing *g*, operating in a rack in the conventional way, except that the hand wheel is geared up so that the traverse is accomplished with a minimum amount of effort on the part of the operator. The head is carried on a pair of friction rollers, *h*, which are set up by very powerful springs. The binder for the head is arranged to clamp it against the bottom surface of the arm, that is, in the direction that the work forces it. The spindle is accurately counter-weighted and is driven by its largest diameter. Owing to the driving sleeve, the action of the feed does not in any way tend to draw the tapping clutch in or out of engagement.

The arm is raised and lowered by means of a screw and is arranged with a binder to lock it on the post. The arm is pre-

vented from swinging by means of the conventional arm lock, the latter being operated from the saddle by means of a small pneumatic cylinder, which is arranged so that the weight will lock the arm. There is, therefore, no waste of air while the arm is locked, the air being used only for the purpose of swinging the arm. This has the added advantage that, should there be no air available, the lever of the arm lock can be temporarily operated by hand, or it can be removed and a regular binder arm substituted.

FRACTURED CRANK PIN DETECTOR

A novel device for detecting a broken crank pin has been invented by H. Van Dyken, Two Harbors, Minn., and has been applied to sixty locomotives of the Duluth & Iron Range. It has been found that all crank pins start to break at that part of

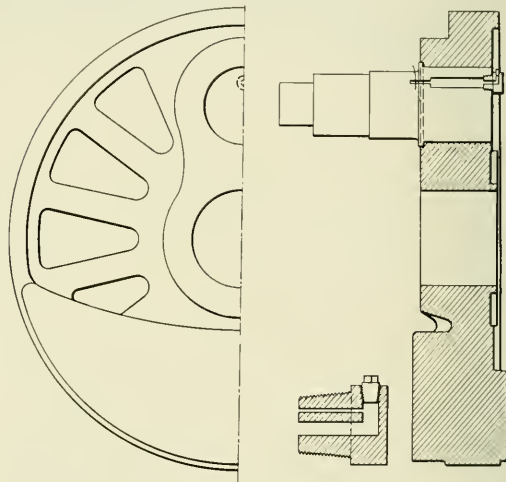

Method of Applying Crank Pin Detector.

the pin most remote from the center of the wheel. A hole is drilled about $1\frac{1}{2}$ in. or $1\frac{3}{4}$ in. from the side of the pin, and deep enough so that when it starts to break, the break or crack will intersect the hole. A red liquid is poured into this hole

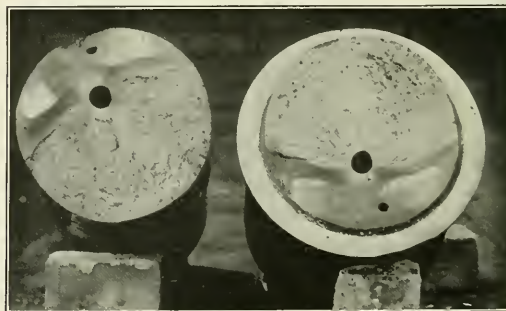

Fractured Crank Pin Discovered by Means of the Detector.

through the plug as shown in the illustration. This liquid will leak through the crack or break and will be seen around the hub of the pin. The liquid should be poured in slowly, allowing the air to escape, and both plugs should fit tightly. When applied

to old crank pins they should be examined after the first trip for it may have been defective for some time. Crank pins should be examined twice a month by unscrewing the little filling plug. Should the liquid remain in the pin for a long time, and finally the pin be found dry, and the substance could not be seen around the hub on the outside, the hole should be refilled. This detector not only avoids the trouble of broken crank pins on the road but it also saves the expense of taking out crank pins that are in good condition, for fear they might break soon.

The crank pin shown in the photograph was detected twice by this method. When the pin had cracked to the first or small hole, it was considered safe to use the engine for a while and a second hole was drilled further toward the center of the pin. The distance between centers of the two holes is $1\frac{7}{8}$ in. The engine remained 21 days in continuous heavy service, before the liquid leaked out of the second hole. The pin was then pressed out and replaced.

SMOKE BURNING DEVICE

The Chicago & North Western is equipping all of its locomotives entering Chicago with the steam jet smoke consumer shown in the accompanying illustration. The arrangement is in accordance with the recommendations made by a sub-committee of the General Managers' Association of Chicago, appointed to investigate the value of the steam jets in locomotive fireboxes.*

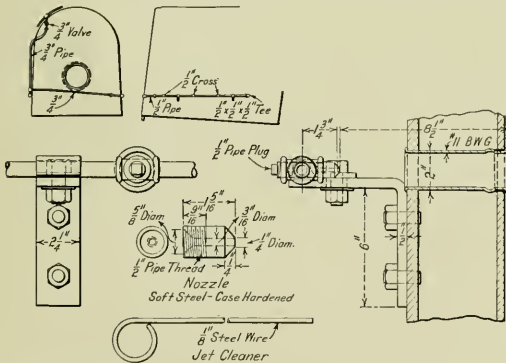

Details and Arrangement of Firebox Steam Jets; Chicago & North Western.

This device has been found very effective when used in conjunction with the quick action blower valve described in the March, 1913, issue of the *American Engineer*, page 160. The results following the use of this arrangement were also published in this journal on page 236 of the May, 1913, issue.

UNPRECEDENTED SPEED.—The new steamboat *Patrick Henry*, built in Baltimore to run between Norfolk and Richmond, is now in the line and performed the distance, 145 miles, on Tuesday last in 7 hours and 43 minutes, after the stoppages were deducted.—From the *American Railroad Journal*, September 8, 1832.

RAILROAD CARS.—A gentleman from Rockland county called upon us a few days since with a model of a railroad car. His improvement consists, he says, in the manner of placing the car upon the axis of the wheels. The model may for the present be seen at this office by those who feel interested in such matters.—From the *American Railroad Journal*, September 15, 1832.

*A report of the tests made by this committee was presented before the Master Mechanics' Association last June and abstracted in the *Daily Railway Age Gazette* of June 14, page 1377.

TANK WELL AND VALVE

A low type of tank well has been designed in the mechanical engineer's office of the Delaware, Lackawanna & Western, and is being applied to all of the new locomotives built for that road. As can be seen in the illustration, it is characterized by simplicity, lightness and ease of application and operation. It consists of a hollow well which contains a pair of sliding disc valves held in a rotating frame which is operated by a shaft projecting through the bottom of the well. The arrangement is such that all the upper rigging of the ordinary type of tank well and valve is entirely eliminated.

It will be seen in the illustration that the two valve discs are

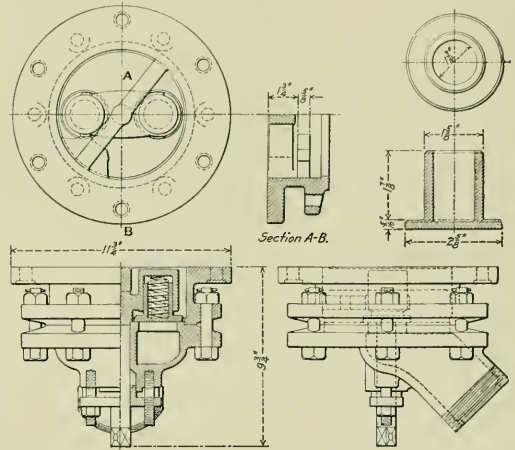

Low Type Tank Well and Valve.

held on their seats by means of coiled springs, and further that there is no stuffing box in connection with the valve itself, the only one on the whole construction being at the bottom of the operating shaft. The spring seated valves allow the tank hose to be blown back when the valve is closed, and furthermore make the valve self-cleaning and to a certain extent, self-grinding. The bottom part of the well is separable from the casting riveted to the tank bottom and when the bolts holding it in place are released, the whole valve and seat can be removed without difficulty. A stop is provided for the full open or entirely closed position, and the valve is practically locked when in either position.

SAFETY TALKS IN PAY ENVELOPES.—One of the latest ideas in what has sometimes been called welfare work is a plan of insurance now being tried out by the Kilbourne & Jacobs Manufacturing Company, Columbus, Ohio. The scheme is that all of the employees are properly protected against accidents during the full twenty-four hours of each day. This is accomplished by insuring them under a blanket policy of an accident insurance company for one-half of the workman's weekly wage. When a man punches the time clock in the morning he knows that he is insured for the ensuing twenty-four hours. The company pays the premiums and collects and disburses to the injured employee all indemnities due. No charge is made the workman for the cost of the premium, nor is he asked to sign any release papers for an injury sustained in the factory or outside. If the workman's injury keeps him incapacitated for fifty-two weeks, one-half his weekly earnings is paid to him for that period, with the exception of the first week's payment, for which there is no indemnity allowed.—*Michigan Manufacturer and Financial Record*.

NEWS DEPARTMENT

According to a press despatch the Chicago & North Western is now operating all its trains out of Omaha, Neb., by oil burning locomotives.

The Western Maryland has arranged with a correspondence school to instruct its enginemen in the use of the air brake and an instruction car will soon be put in service.

A Rock Island train was delayed for 40 minutes on July 30 near Ford, Kan., by a large number of grasshoppers that had blown on the track at a deep cut. The trainmen were obliged to scoop them off the tracks with shovels and sand the rails before the train could proceed.

The committee of management of the International Engineering Congress (1915), has announced that Col. Geo. W. Goethals, chairman of the Isthmian Canal Commission and chief engineer of the Panama Canal, has consented to accept the honorary presidency of the Congress and will preside in person over the general sessions to be held in San Francisco, September 20-25, 1915.

R. C. Richards, chairman of the Central Safety Committee of the Chicago & North Western, is furnishing to all the moving picture shows along the line of the road a set of stereopticon views similar to those shown in its trespass circular, showing the manner in which so many people are killed and injured while trespassing on railroad tracks. One of the slides used shows a statement giving the number of persons killed and injured while trespassing in the last 20 years.

AUTOMATIC STOPS ON THE NEW HAVEN

The New York, New Haven & Hartford announces that its offer of \$10,000 for the best automatic stop has expired; and that 2,816 persons have entered the competition. Only 704 of the applicants have submitted plans; but any inventor who got his name on the list before July 1 will be allowed until January 1, 1916, to qualify. C. H. Morrison, signal engineer of the road up to July 1 had written 4,002 letters; and 1,483 copies of patents had been obtained from the Patent Office. Of the 704 devices of which plans have been submitted not one has met condition No. 1, which reads: "The apparatus should be so constructed that the removal or failure of any essential part would cause the display of a stop signal and the application of the train brakes, and if electric circuits are employed, they should be so designed that the occurrence of a break, cross, or ground, or a failure of the source of energy in any of the circuits, should cause the display of a stop signal and the application of the train brakes." A few of the devices submitted might be made to meet this requirement. The company will proceed at once to test two devices on the western division, between Hartford and Newington. One of these is the invention of Mr. Webb, of the International Signal Company, and the other of an engineer of the Union Switch & Signal Company.

A SAFETY EXPOSITION IN DECEMBER

The first international exposition of Safety and Sanitation ever held in America will be held in New York City, December 11 to 20, 1913, under the auspices of The American Museum of Safety, 29 West Thirty-ninth street. Safety and health in every branch of industrial life, manufacturing trade, transportation, business and engineering, in all of their sub-divisions will be represented at this exposition. By a special act of Congress, exhibits from foreign countries are to be admitted free of duty. European employers have cut their accident and

death rate in half by a persistent campaign for safety. There are 21 museums of safety in Europe. All of these will contribute to the exposition.

AMERICAN LOCOMOTIVE COMPANY

The annual report of the American Locomotive Company for the year ended June 30, 1913, shows that the earnings of that company increased in proportion to the very large increase in locomotive construction during that period compared with the previous year. In the calendar year 1912 the number of locomotives ordered was larger than in any other year since 1906 and until June, 1913, orders continued to come in at approximately the same rate. The gross revenue for the year, \$54,868,175 including earnings from the manufacture of automobiles, was the largest of any year in the history of the company. It was \$24,418,723 larger than in 1912; \$5,350,000 larger than in 1907, the best previous year, and over twice as great as in 1902, the first year in the company's history. The amount earned on the common stock was 17.7 per cent. compared to 0.47 per cent. in 1912 and 18 per cent. in 1907. No dividends have been paid on the common stock since 1907. The company started the year under the most auspicious conditions, for on June 30, 1912, the contract work in course of construction amounted to \$2,051,187, compared with \$740,550 one year before; also the amount of unfilled orders on July 1, 1912, was \$14,450,000, compared with \$6,015,000 on the corresponding date of the previous year. Judging from present indications the earnings of the fiscal year 1914 will show a decrease from those of last year, for, although the contract work in course of construction on June 30, 1913, amounted to \$3,975,022, and the amount of unfilled orders on the following day was \$17,156,388, orders have shown a sharp falling off since last May, so much so that it is expected that there will be a reduction in the operations of the plants in the United States in the near future.

MEETINGS AND CONVENTIONS

The following list gives names of secretaries, dates of next or regular meetings, and places of meeting of mechanical associations.

- AIR BRAKE ASSOCIATION.—F. M. Nellis, 53 State St., Boston, Mass.
AMERICAN RAILWAY MASTER MECHANICS' ASSOC.—J. W. Taylor, Old Colony building, Chicago.
AMERICAN RAILWAY TOOL FOREMEN'S ASSOCIATION.—A. R. Davis, Central of Georgia, Macon, Ga.
AMERICAN SOCIETY FOR TESTING MATERIALS.—Prof. E. Marburg, University of Pennsylvania, Philadelphia, Pa.
AMERICAN SOCIETY OF MECHANICAL ENGINEERS.—Calvin W. Rice, 29 W. Thirty-ninth St., New York. Annual meeting, December 3-6, Engineering Societies' Building, New York. Railroad session, Thursday morning, December 5.
CAR FOREMEN'S ASSOCIATION OF CHICAGO.—Aaron Kline, 841 North Fifthth Court, Chicago; 2d Monday in month, Chicago.
INTERNATIONAL RAILWAY FUEL ASSOCIATION.—C. G. Hall, 922 McCormick building, Chicago. Convention, May 18-22, 1914, Chicago.
INTERNATIONAL RAILWAY GENERAL FOREMEN'S ASSOCIATION.—William Hall, 829 W. Broadway, Winona, Minn.
INTERNATIONAL RAILROAD MASTER BLACKSMITHS' ASSOCIATION.—A. L. Woodworth, Lima, Ohio.
MASTER BOILER MAKERS' ASSOCIATION.—Harry D. Vought, 95 Liberty St., New York.
MASTER CAR BUILDERS' ASSOCIATION.—J. W. Taylor, Old Colony building, Chicago.
MASTER CAR AND LOCOMOTIVE PAINTERS' ASSOC. OF U. S. AND CANADA.—A. P. Dane, B. & M., Reading, Mass. Convention, Sept. 9-12, 1913, Ottawa, Can.
RAILWAY STOREKEEPERS' ASSOCIATION.—J. P. Murphy, Box C, Collinwood, Ohio.
TRAVELING ENGINEERS' ASSOCIATION.—W. O. Thompson, N. Y. C. & H. R., East Buffalo, N. Y.

PERSONALS

It is our desire to make these columns cover as completely as possible all the changes that take place in the mechanical departments of the railways of this country, and we shall greatly appreciate any assistance that our readers may give us in helping to bring this about.

GENERAL

G. M. CROWNOVER, master mechanic of the Chicago Great Western at Oelwein, Iowa, has been appointed superintendent of motive power, with office at Oelwein, succeeding J. G. Neuffer, resigned to retire from railway service.

J. E. McQUILLEN has been appointed mechanical superintendent of the Gulf, Colorado & Santa Fe, with headquarters at Cleburne, Tex., succeeding P. T. Dunlop. He was born at Rochester, N. Y., January 25, 1873, and was educated in the public schools of Rochester and at the Sacred Heart Academy at Palestine, Tex. He began railway work in October, 1887, as roundhouse caller for the International & Great Northern at Palestine, being employed in that capacity until February, 1888, from which time until April, 1892, he was a machinist apprentice. He was then until October, 1895, machinist and foreman in various railroad and contract shops in the United States and Mexico, on the latter date being appointed general foreman of the Houston East & West Texas at Houston, Tex. From January, 1897, to June, 1901, he was a machinist and division foreman in the shops of the International & Great Northern at Taylor, Tex., and the following three months was with the Missouri, Kansas & Texas at Smithville, Tex., as a machinist. Mr. McQuillen went to the Gulf, Colorado & Santa Fe in September, 1901, and until December, 1902, was machinist and roundhouse gang boss at Temple, Tex. He was then made general foreman at Gainesville, Tex., and in November, 1906, was promoted to master mechanic at Silsbee, Tex., which position he held until his recent appointment as mechanical superintendent as above noted.

HUGH MONTGOMERY has been appointed superintendent of motive power and rolling stock of the Rutland Railroad, with office at Rutland, Vt., succeeding F. C. Cleaver, resigned.

G. A. SCHMOLL has been appointed district superintendent of motive power of the Baltimore & Ohio, with headquarters at Pittsburgh, Pa. He was born November 23, 1862, at Fort Wayne, Ind., and began railway work in June, 1885, as an apprentice in the shops of the Pennsylvania Railroad. He later became machinist, and in January, 1902, was made shop foreman, leaving that company the following November to become motive power inspector on the Baltimore & Ohio. In June, 1903, he was promoted to master mechanic at Mount Clare, and seven years later he became superintendent of motive power at Wheeling, W. Va., remaining in that position until his appointment as district superintendent of motive power at the same place, which position he held at the time of his recent appointment as district superintendent of motive power at Pittsburgh, as above noted.

H. C. VAN BUSKIRK has been appointed mechanical superintendent of the first district of the Chicago, Rock Island & Pacific, with headquarters at Des Moines, Iowa, succeeding J. B. Kilpatrick, resigned.

The headquarters of J. J. Waters, superintendent of motive power of the Pere Marquette, have been moved from Grand Rapids, Mich., to Detroit, Mich.

MASTER MECHANICS AND ROAD FOREMEN OF ENGINES

A. B. ADAMS has been appointed master mechanic of the Atchison, Topeka & Santa Fe at Silsbee, Tex., succeeding J. E. McQuillen, promoted.

W. S. BUTLER, master mechanic of the Huntington division of the Chesapeake & Ohio, at Huntington, W. Va., has been appointed master mechanic of the West Virginia general division, with office at Hinton, W. Va.

J. L. CUNNINGHAM has been appointed master mechanic of the Philadelphia, Baltimore & Washington, at Wilmington, Del., succeeding C. G. Turner, resigned. Mr. Cunningham



J. L. Cunningham.

was born September 28, 1874, at West Fairfield, Pa., and in 1891 graduated from Blairsville, Pa. High School. In November of the same year he became machinist apprentice on the Pennsylvania Railroad at Altoona, Pa., and after completing his apprenticeship entered Purdue University, graduating with the class of 1900. In July of the same year he was appointed motive power inspector on the Pennsylvania Railroad at Philadelphia, Pa., and the following March was transferred in the same capacity to Pittsburgh.

In December, 1902, he was made foreman of the Bedford division shops, at State Line, Pa., and one year later became assistant master mechanic at Harrisburg. He was appointed general foreman at Columbia, Pa., in October, 1904, and in April, 1906, was made assistant engineer of motive power at Williamsport, Pa., becoming master mechanic of the New York, Philadelphia & Norfolk in August, 1910, with headquarters at Cape Charles, Va., which position he held at the time of his appointment as master mechanic of the Philadelphia, Baltimore & Washington, as above noted.

FOSTER DEWEY has been appointed division foreman of the Atchison, Topeka & Santa Fe at Williams, Arizona, succeeding Chas. Johnson.

C. A. KOTHE has been appointed master mechanic of the Cincinnati division of the Erie at Marion, Ohio.

CHARLES L. McILVANE has been appointed master mechanic of the New York, Philadelphia & Norfolk, with office at Cape Charles, Va. He was born September 25, 1876, at Wilmington Del., and was educated at the University of Pennsylvania. He began railway work as an apprentice in October, 1899, on the Philadelphia, Baltimore & Washington, at Wilmington, and in 1901 was made special apprentice at the Pennsylvania shops at Altoona, Pa. In January, 1903, he became draughtsman at Jersey City, N. J., and in March, 1905, was appointed inspector in the motive power department at the same place. The following month he was made assistant master mechanic on the Amboy division at Camden, and in May, 1907, became assistant engineer of motive power on the Buffalo & Allegheny Valley division at Buffalo, N. Y. From September, 1910, to May, 1911, he was assistant engineer of motive power of the Philadelphia & Erie and the Northern Central, at Williamsport, Pa., and then became assistant engineer of motive power in the office of the general superintendent of motive power at Altoona, Pa., which position he held at the time of his recent appointment as master mechanic of the New York, Philadelphia & Norfolk, as above noted.

J. E. FOWLER has been appointed road foreman of engines of

the Atchison, Topeka & Santa Fe at Silsbee, Tex., succeeding D. Ross.

DAVID ROSS has been appointed road foreman of engines of the Atchison, Topeka & Santa Fe at Cleburne, Tex., succeeding C. C. Walker.

CAR DEPARTMENT

W. T. COUSLEY, chief car inspector of the Elgin, Joliet & Eastern, at Gary, Ind., has been appointed master car builder of the San Antonio & Aransas Pass, with headquarters at San Antonio, Tex.

SHOP AND ENGINE HOUSE

GEORGE T. DEPUE has been appointed superintendent of shops of the Erie Railroad at Galion, Ohio.

C. H. GILLER has been appointed foreman boilermaker of the Atchison, Topeka & Santa Fe at Riverbank, Cal.

W. E. GOODWIN has been appointed tool foreman of the Chicago & Alton at Bloomington, Ill.

C. B. HITCH, general foreman of the Chesapeake & Ohio at Covington, Ky., has been appointed general foreman of that road at Hinton, W. Va.

GEORGE HOFF, JR., formerly special apprentice at the Altoona shops of the Pennsylvania, has been appointed an engine inspector at the Twenty-eighth street roundhouse of the same road.

H. W. HUNT has been appointed bonus demonstrator of the Atchison, Topeka & Santa Fe, with headquarters at Richmond, Cal., having charge of bonus demonstrating work on the Valley and Arizona divisions, succeeding J. R. Leverage, transferred.

J. R. LEVERAGE has been appointed bonus demonstrator of the Atchison, Topeka & Santa Fe, with headquarters at San Bernardino, Cal., having charge of bonus demonstrating work at San Bernardino shops, Los Angeles and Albuquerque divisions, succeeding S. S. Lightfoot, promoted.

S. S. LIGHTFOOT has been appointed bonus supervisor for the Atchison, Topeka & Santa Fe Coast Lines, with headquarters at Los Angeles, Cal., succeeding D. E. Barton, transferred.

JOHN L. MILLER has been appointed roundhouse foreman of the El Paso & Southwestern at Douglas, Ariz., succeeding W. C. Leland, promoted.

H. A. PREWITT has been appointed general foreman of the Atchison, Topeka & Santa Fe at Amarillo, Tex., succeeding H. H. Stephens.

E. M. WILCOX, division general foreman of the Chicago, Indiana & Southern and the Indiana Harbor Belt, has been appointed division general foreman of the Lake Shore & Michigan Southern, with headquarters at Englewood, Ill., succeeding George Thomson, promoted.

PURCHASING AND STOREKEEPING

G. W. ALEXANDER, storekeeper of the Central of Georgia at Savannah, Ga., has been appointed division storekeeper of that road at Macon, Ga.

J. L. BENNETT has been appointed purchasing agent of the Central of Georgia, with headquarters at Savannah, Ga., succeeding A. C. Mann.

A. C. MANN, purchasing agent of the Central of Georgia, at Savannah, Ga., has been appointed purchasing agent of the Illinois Central, with headquarters at Chicago, succeeding J. C. Kuhns.

F. K. MAYS, treasurer of the Atlanta, Birmingham & Atlantic, at Atlanta, Ga., has been appointed purchasing agent of that road, also of the Georgia Terminal Company and the Alabama Terminal Railroad, in addition to other duties previously as-

signed to him, with headquarters at Atlanta, succeeding W. A. Hammel, resigned to go to another company.

G. E. McWHITE has been appointed assistant purchasing agent of the Atlanta, Birmingham and Atlantic, with headquarters at Atlanta, Ga.

B. H. ROTUREAU, storekeeper of the Central of Georgia at Macon, Ga., has been appointed division storekeeper of that road at Savannah, Ga.

THOMAS SPRATT has been appointed assistant purchasing agent of the Norfolk & Western, with office at Roanoke, Va.

NEW SHOPS

ATCHISON, TOPEKA & SANTA FE.—Work will begin immediately on a new roundhouse at Temple, Tex., to cost about \$25,000.

ATCHISON, TOPEKA & SANTA FE.—This company has asked bids on an eight-stall brick and concrete roundhouse at Silsbee, Tex.

ATCHISON, TOPEKA & SANTA FE.—This company has awarded a contract for a "Unit-Bilt" reinforced concrete 25-stall roundhouse at Redondo Junction, near Los Angeles, Cal., to the Van Sant Houghton Company of San Francisco.

CANADIAN PACIFIC.—This road will build another addition to its passenger car repair shop at Toronto, Ont. The new building will be one story high and will be built of brick with concrete foundation. John Hayman & Son Company, London, Ont., have secured the concrete contract for this building, which will cost about \$26,000.

PORTLAND, EUGENE & EASTERN.—It is reported that this road will begin work within 90 days on the construction of a machine shop and foundry at West Oregon City, Ore.

ST. LOUIS SOUTHWESTERN.—Work has commenced on a new 16-stall roundhouse at Texarkana, Tex.

ST. LOUIS SOUTHWESTERN.—This company, through a newly incorporated subsidiary called the Valley Terminal Association, has purchased about 140 acres of land on which to erect a roundhouse, shops and other terminal buildings, and a yard with a capacity of about 5,000 cars at East St. Louis, Ill.

INDIAN RAILWAY MILEAGE.—During the calendar year of 1912, 668 miles of new line were opened to traffic in India, bringing the total mileage in operation up to 33,484 miles. This figure comprises 17,189 miles of 5 ft. 6 in. gage; 14,165 miles of 3 ft. 3 in. gage; 1,692 miles of 2 ft. 6 in. gage, and 438 miles of 2 ft. gage.

TRAFFIC THROUGH HARLEM RIVER YARD.—During the month ending July 15, 1913, 1,721 carloads of potatoes from the South passed through the Harlem River yard of the New York, New Haven & Hartford, destined for cities in New England, an average of 54 cars a day. In the same time there were sent through this yard 467 carloads of watermelons, 135 of cantaloupes, 112 of berries and 98 carloads of peaches. The movement of freight cars through this yard, eastbound and westbound, now amounts to about 5,000 a day.

ELECTRIFICATION OF MELBOURNE SUBURBAN RAILWAYS.—The Electrification Committee has been meeting frequently to arrange details of the scheme. Among the principal questions considered have been those in connection with the bonding of the rails for the transmission of electrical energy, the provision of the requisite number of carriages suitable for electric traction, and the structural alterations in the bridges on the route. A commencement has been made with the construction of the loop line to the site of the new power house to be erected.

SUPPLY TRADE NOTES

The National Tube Company, Pittsburgh, Pa., announces that commencing August 1, 1913, it will enter the electrical conduit field.

The Goldschmidt Thermit Company, New York, has moved its San Francisco, Cal., office from 432 Folsom street, to 329 Folsom street.

A. L. Whipple has resigned his position as vice-president of the Standard Heat & Ventilation Company, New York, with office in Chicago, to enter the railway supply business on his own account.

L. C. Noble, vice-president of the Pittsburgh Spring & Steel Company, died at his home in Evanston, Ill., July 25. Mr. Noble was born at Ann Arbor, Mich., July 24, 1842. In October, 1862,

he became foreman of the machine shop of the Detroit Locomotive Works, holding that position until 1863. From 1863 to 1867, he was employed in the shops of the Chicago & North Western at Chicago. From 1872 to 1874, he was general foreman of the Houston & Texas Central, and in May, 1874, was appointed general master mechanic for the same road. Subsequently he was for several years prior to 1890 superintendent of motive power of the same road. In 1890 he became associated with the A. French Spring

Company, as western manager of sales, and in 1902 he resigned that position to become vice-president of the Pittsburgh Spring & Steel Company, with office at Chicago, which position he held at the time of his death.

The Mid-Western Car Supply Company, Chicago, which was declared bankrupt on May 20, 1913, has filed an application for the discharge of its debts. A hearing will be held in Chicago on October 6.

C. R. Weaver has been made vice-president of the L. J. Bordo Co., Philadelphia, Pa., maker of Bordo blow-off valves, succeeding C. W. Allen, resigned. Mr. Allen has also resigned his position as a director of this company.

The American Locomotive Company, New York, has decided to discontinue the manufacture and sale of Alco automobiles and motor trucks. The automobile department, since its start in 1905, has been unprofitable to the company, and the prospects for the future of carrying on the business successfully are so uncertain as not to warrant, in the judgment of the directors, the continuance in this field of industry. The company will continue to make repair parts for its automobiles for a period of not less than five years.

District Judge Thomas I. Chatfield, sitting in the United States district court for the Eastern district of New York, handed down a decision on June 12 in *Heinrich L. I. Siemund vs. Joseph Enderlin, Sr., and Joseph Enderlin, Jr., doing business under the firm name and style of Joseph Enderlin, Jr., & Co.*, dismissing the complaint against the defendants for infringement on electrical welding patents. It was found that the complainant, the defendants and others had been applying the teachings of the

Bernados method of electrical welding, as improved upon by Coffin and Kjellberg through the use of a metal electrode. They had found that under certain relative conditions of size of parts and strength and quantity of current, an experienced workman could weld upon an overhead surface, but Siemund was the first man who described to the patent office, or who expressed in writing a definite description of the proportion and arrangement of the entire apparatus and the method of the manipulation of the parts when making a successful overhead weld. The court found that such a description was not the invention of a method; also that an arrangement of the parts of a device cannot be patentable as a new invention when the earlier patents show both an understanding of the possibility of these results and the existence of such an arrangement of parts and of the conditions produced, even though the explanation of the cause of the results themselves be mistakenly stated. For seven or eight years prior to the Siemund experiments, Enderlin was welding by the method of electric current, of substantially the proportions needed for the Siemund method, and by the use of a metallic electrode of such small size as to produce a voltaic arc, manipulated in almost the identical way which Siemund later patented. The court decided that even if the particular improvements upon the Bernados method were patentable, or if the particular device showed patentable novelty, the Siemund patent must be held invalid when tested from the standpoint of the defendant's prior use.

Alfred Atmore Pope, president of the National Malleable Castings Company, Cleveland, Ohio, died at his home in Farmington, Conn., on August 5. Mr. Pope was born in North

Vassalboro, Me., in 1842. In his early boyhood his family moved to Salem, Ohio, where he spent his school days, and, a few years later, to Cleveland, Ohio, where Mr. Pope's business experience began. After five or six years as a partner in the woolen manufacturing business his connection with the malleable iron business began in the year 1869. This became the leading commercial interest of his life and he, associated with his partners, was foremost in developing the present process of making malleable iron and in extending its manufacture,

until now it has become one of the important iron industries of the country.

Rare patience, foresight, sound judgment, absolute justice, untiring devotion to detail, and a gift for inspiring and rewarding the best efforts and stimulating the best qualities of other men were among the striking elements of Mr. Pope's successful career. Under his leadership the Cleveland Malleable Iron Company rapidly grew in importance and reputation and its operations extended in the course of years to other communities, resulting finally in the great group of the malleable iron and steel casting plants of The National Malleable Castings Company at Cleveland, Chicago, Indianapolis, Toledo, Sharon, and Melrose Park.

The Eberhard Manufacturing Company of Cleveland, established in 1879, for producing light and special castings, has developed from small beginnings into one of the largest manufacturers of vehicle and saddlery hardware in the world. The Ewart Manufacturing Company of Chicago and Indianapolis,



L. C. Noble.



A. A. Pope.

now a part of the Link-Belt Company, originators of detachable link belting, is another of the large enterprises which grew and developed under Mr. Pope's management.

At the time of his death Mr. Pope was president of The National Malleable Castings Company and The Eberhard Manufacturing Company, which positions he had held since their organization. He was director in the Link-Belt Company of Chicago, the North & Judd Manufacturing Company and the Landers, Frary & Clark Company of New Britain, Conn., the Indiana & Michigan Electric Company of South Bend, Ind., the Colonial Trust Company of Waterbury, Conn., and the Century Bank of New York. He was a member of the Advisory Board of the Guardian Savings & Trust Company, Cleveland; trustee of Western Reserve University; president of Westover School, Middlebury, Conn.; member of the Royal Society of Fine Arts, London; a member of the Visitors' committee of the Fogg Museum of Fine Arts of Harvard University.

FEDERATION OF TRADE PRESS ASSOCIATIONS

The annual convention of the Federation of Trade Press Associations will be held at the Hotel Astor, New York, September 18-20. The subject of the opening meeting on the morning of September 18 will be Business Promotion Through Trade Press Efficiency, which will be followed by addresses by President H. M. Wilson of the New York Trade Press Association, President H. M. Swetland of the Federation of Trade Press Associations, Secretary-Treasurer E. C. Johnston, of the same association, and by the presidents of the various local associations. R. R. Shuman, of the Shuman-Booth Company, Chicago, will deliver an address on The New Force in Business, which will be followed by an address on The Weakest Spot in Trade Press Efficiency by Elton J. Buckley, editor of *The Grocery World and General Merchant*.

Lunch will be served at the Thirty-ninth Street Publishers' building, followed by an inspection of the plant and publishing offices of the Federal Printing Company. The editorial symposium, under the leadership of A. J. Findley, of the *Iron Age*, will be held on the afternoon of September 18. At this symposium will be presented papers on general editorial subjects; also on the relations of editors with other departments. On the same afternoon there will be the circulation symposium under the leadership of M. C. Robbins, at which papers will be presented from subscription managers, canvassers, and subscribers, giving views as to the value of the trade press and wherein it fails to be of value to them.

On September 19 there will be the advertising symposium, which will be under the leadership of Hugh M. Wilson, and at which papers will be presented by educators, publishers, advertisers, advertising managers and advertising agents. At the business meeting will be told the inside stories of some of the big trade paper publishing successes. These speakers will treat the fundamental principles upon which each business was built. H. M. Swetland, president, will preside.

In the afternoon there will be a mass meeting at which there will be a number of addresses by representative men on subjects of live interest to editors, publishers and advertisers. The banquet will be held on the evening of September 19 at the Hotel Astor. John Clyde Oswald, of the *American Printer*, will be toastmaster. The speakers will include the Hon. Albert S. Burleson, postmaster general; the Hon. William C. Redfield, secretary, Department of Commerce; John Kendrick Bangs, Tom Daly, the Hon. Charles F. Moore and Dr. N. M. Waters.

The publishers' symposium will be held on the morning of September 20. Here will be discussed the policies, standards, and ideals of the trade paper publishing business. This symposium will be under the leadership of E. R. Shaw, of *The Practical Engineer*.

William H. Ukers, 79 Wall street, New York City, is chairman of the committee on arrangements.

CATALOGS

ELECTRIC HOISTS.—Electric driven hoists in any practicable size and arranged for all ordinary uses are shown in a catalog from the Lidgerwood Manufacturing Company, 96 Liberty street, New York. These hoists are of the type especially suited for contractors' work.

TWIST DRILLS.—The new catalog (No. 16) of the Detroit Twist Drill Company, Detroit, Mich., contains 109 pages entirely devoted to twist drills, reamers, chucks, sockets and milling cutters. The section on drills is the largest part of the book and these are shown in many styles with various types of shank. The Detroit grooved shank system is given prominent mention. On each page is a table showing the complete range of sizes for each type of drill together with the price for both carbon and high speed steel. The proper procedure for grinding twist drills is explained on one of the pages.

VERTICAL BORING AND TURNING MILLS.—A leaflet which is to be included in the binder furnished by the Gisholt Machine Company, Madison, Wis., gives an illustration and brief description of the 52-in. vertical boring and turning mills manufactured by this company. These mills are provided with a turret head holding five tools, and also a side attachment for cutting on the edge of revolving work.

EXHAUST FAN OUTFITS.—Motor driven exhaust fan outfits for both direct and alternating current of various styles and sizes are shown in bulletin No. 246 from the Sprague Electric Works of the General Electric Company, Schenectady, N. Y. The fans are illustrated by photographs and line drawings showing the over-all dimensions. The tables show the capacity under different conditions and with different sizes.

ELECTRIC ARC WELDING PROCESSES.—A paper on electric arc welding by C. D. Auel, director of processes, standards and materials of the Westinghouse Electric & Manufacturing Company, Pittsburgh, Pa., is being reprinted by that company. This paper is well illustrated and explains in an interesting manner the different processes used in arc welding, their advantages and limitations and gives some interesting figures of comparison of arc and blacksmith welding.

ELECTRIC GRINDERS.—Bulletin E-29 which supersedes E-24 is being issued by the Chicago Pneumatic Tool Company, Fisher Building, Chicago. Portable electric grinders in various arrangements and sizes are the subject of this bulletin. Each is illustrated, briefly described and a table is given showing the weight and sizes of the machine. The same company is also issuing a new bulletin on enclosed self-oiling type of air compressors for both steam and belt drive. The description of these compressors is thorough.

BALL BEARINGS.—S. K. F. self-aligning radial ball bearings are fully illustrated and the characteristic features of the design fully explained in bulletin No. 9 being issued by the S. K. F. Ball Bearing Company, 50 Church street, New York. The catalog explains how the rating of ball bearings is obtained and tables are included showing the maximum load per pound for various revolutions that is recommended in each size. These tables also include the dimensions of the complete bearing, size of the ball and the weight. Both radial and thrust bearings are considered.

AUTOMATIC CONNECTORS.—The Robinson automatic connectors for air hose is of the full-face, straight port type and employs the minimum number of parts, giving a very light weight and minimum interference. For passenger service this connector weighs 40 lbs. and for freight service about 30 lbs. It employs a hose from the connector head to the train line angle cock and is carried by a connection to the coupler shank. This connector is manufactured by The Robinson Coupler Company, Washington, D. C. It is fully illustrated and described in a catalog being issued by this company.

Railway Age Gazette

MECHANICAL EDITION

INCLUDING THE AMERICAN ENGINEER

PUBLISHED ON THE FIRST THURSDAY OF EVERY MONTH BY THE SIMMONS-BOARDMAN PUBLISHING COMPANY, WOOLWORTH BLDG., NEW YORK, N. Y.

CHICAGO: Transportation Bldg. CLEVELAND: Citizen's Bldg. LONDON: Queen Anne's Chambers, Westminster.

EDWARD A. SIMMONS, President. L. B. SHERMAN, Vice-President. HENRY LEE, Secretary. The address of the company is the address of the officers.

ROY V. WRIGHT, Editor. R. E. THAYER, Associate Editor. E. A. AVERILL, Managing Editor. A. C. LOUGOON, Associate Editor. GEORGE L. FOWLER, Associate Editor.

Subscriptions, including the eight daily editions of the Railway Age Gazette published in June in connection with the annual conventions of the Master Car Builders' and American Railway Master Mechanics' associations, payable in advance and postage free:

United States, Canada and Mexico.....	\$2.00 a year
Foreign Countries (excepting daily editions).....	3.00 a year
Single Copy	20 cents

Entered at the Post Office at New York, N. Y., as mail matter of the second class.

WE GUARANTEE that of this issue 4,900 copies were printed; that of those 4,900 copies, 3,821 were mailed to regular paid subscribers and 50 were provided for counter and news companies' sales; that the total copies printed this year to date were 46,276—an average of 4,628 copies a month.

Statement of the ownership, management, etc., of the Railway Age Gazette, Mechanical Edition, published monthly at New York, N. Y.:

Editor, ROY V. WRIGHT, New York, N. Y. Managing Editor, E. A. AVERILL, New York, N. Y. Publisher, SIMMONS-BOARDMAN PUBLISHING CO., New York, N. Y.

STOCKHOLDERS:

EDWARD A. SIMMONS, New York. ROY V. WRIGHT, New York. LUCIUS B. SHERMAN, Chicago, Ill. ELMER T. HOWSON, Chicago, Ill. HENRY LEE, New York. A. C. BOARDMAN, Riverdale, N. Y. I. B. KINES, New York. F. BOARDMAN, Riverdale, N. Y. SAMUEL O. DUNN, Chicago, Ill. D. BOARDMAN, New York. RAY MORRIS, New York.

BONDHOLDERS:

S. W. DUNNING, New York. A. B. HENSZEEY, Philadelphia, Pa. FRANCIS BOARDMAN, Committee, N.Y. C. W. WALTON, Ridgewood, N. J. S. E. KELLOGG, Newton, Mass. C. C. NEWCOMB, Brooklyn, N. Y. W. H. STRUEY, Chicago, Ill. M. D. HORTON, Brooklyn, N. Y. CHARLES M. PRAIT, New York.

SIMMONS-BOARDMAN PUBLISHING COMPANY, By E. A. SIMMONS, President.

Sworn to and subscribed before Harry E. French, Notary Public for Kings County, N. Y. (No. 12), whose certificate is filed with the County Clerk of New York (No. 8), on September 15, 1913.

VOLUME 87. OCTOBER, 1913. NUMBER 10.

CONTENTS

EDITORIALS:

Night Roundhouse Foreman.....	519
Six Wheel Tender Truck.....	519
Master Painters' Association.....	520
Railroads and College Men.....	520
Freight Car Troubles.....	520
New Books.....	521

COMMUNICATIONS:

Grindstone at Rip Truck.....	523
Car Wheel Flanges and Treads.....	523
Why Don't Railroads Hold the College Man?.....	523

GENERAL:

New Locomotives for the Santa Fe.....	525
Condensed Record of Locomotive Equipment.....	529
An Atlantic Type Locomotive and a Heavy Train.....	529
Design of Counterbalance Weights.....	529
Efficient Power Plant Operation.....	531
Location of Steam Gages in Setting Safety Valves.....	533
Kindling Locomotive Fires.....	536
Firing-Up House for Locomotive Terminals.....	536

SHOP PRACTICE:

Shop Kinks, Central of Georgia, Ga.....	537
Master Painters' Association Convention.....	545
Rack for Testing Feed Valves in Roundhouses.....	546
Installation and Maintenance of Electric Headlight Equipment.....	546
Foundry, Delaware & Hudson.....	546

CAR DEPARTMENT:

Freight Car Troubles.....	551
Prisco Steel Frame Box Car.....	555
Receptacle for Waste Drinking Cups.....	561
Steel Passenger Cars in a Wreck.....	561

NEW DEVICES:

Fosdick Horizontal Boring, Drilling and Milling Machine.....	563
Safety Device for Wetting Coal in Tender.....	564
Car Window Air Intake.....	564
Smith Metallic Packing.....	565
Duplex Journal Bearing Boring Machine.....	566
Heavy Type Forging Machine, National.....	566
Side Rod Grease Plug.....	566
Non-Vibrating Chair for Parlor Cars.....	568
Portable Floor Crane and Hoist.....	568
Portable Turning Machine.....	569

NEWS DEPARTMENT:

Notes.....	570
Meetings and Conventions.....	571
Personals.....	572
New Shops.....	574
Supply Trade Notes.....	575
Catalogs.....	576

Night Roundhouse Foreman

"I dropped into a roundhouse having 12 stalls the other night and asked for the foreman. They told me that he had gone home at seven o'clock and would not be back until seven the next morning. I then asked to see the man who was in charge of the house and was surprised to discover that there was no one in charge. There was a hostler foreman, a couple of machinists, a fire-up man and a couple of handy men, but none of them had any authority over the others. On investigation I find that this is not an unusual condition for small houses of this kind. It does not seem to be a good policy to me."

The above is an extract from a letter recently received. The instance is probably quite typical and it certainly does not seem to be a good policy. If a roundhouse is of sufficient importance to require a foreman in the day time why should it not also have at least an assistant foreman or someone designated to be responsible for its operation during the night time? Engines have to be turned in the night as well as in the day and conditions for working are much harder, the class of help is usually not as reliable, emergency supplies are difficult to obtain, the opportunity for trouble, often of a serious nature, is greater and the train dispatchers are certainly no more patient. How many roundhouses have you on your road where there is not a responsible person in charge during the night?

Six Wheel Tender Truck

It has been the practice of the Santa Fe for some time past to apply six wheel trucks to all high speed passenger equipment whether the weight of the car demanded them or not. This move is believed to be justified in the interest of safety if for no other reasons. Six wheel trucks under locomotive tenders, however, have never seemed to be a necessity and their use under the tenders of 32 Pacific type locomotives, recently completed for the Santa Fe, is an interesting departure. This company, however, has had experience with six wheel tender trucks in the case of the Mallet type passenger locomotives which were built a number of years ago. The truck for the Pacific type is illustrated on page 506 of this issue and has a cast steel frame in one piece with cast steel pedestals bolted to it. The bolsters are suspended on heart shaped links which are pinned to the transverse sections of the truck frame. The links, however, are unsymmetrical, the outside upper pin in each being vertically above the lower pin. It is believed that since with this method one side of the bolster will be raised higher than the other when the truck is displaced on the curve, the stability of the tender will be increased and a more even distribution of the weight on the track be obtained. The Santa Fe is practically the only system which has found the balanced compound passenger locomotive to be a success, and in addition to a large number of Atlantic type engines of this cylinder arrangement it now has 80 Pacific type

locomotives with inclined high pressure cylinders. The latest order also includes 29 Mikado type locomotives which are the first of this design to be put in service on this road. By careful attention to the use of standard parts or parts which, at least, are common to a number of other type locomotives, the usual difficulties and expense which accompany the introduction of a new type on any system will be greatly minimized in this case.

Master Painters' Association

The forty-fourth annual convention of the Master Car and Locomotive Painters' Association was marked by the consideration given to the painting of steel cars. Several of the members called attention to the fact that engine tenders had been painted and satisfactorily maintained for a long time, and expressed surprise at the difficulties experienced on the steel car equipment. While the engine tank and the steel car may be comparable in some respects it is plain that the steel freight car is subject to much more severe treatment and the steel passenger car requires a more elaborate finish.

The painting of steel cars by the baking process, as described by John Gearhart, of the Pennsylvania, was received with some degree of skepticism by many of the painters, even though the results thus far obtained have been very satisfactory. This process not only allows a car to be finished in a much shorter time, but also permits of a paint containing no special drying agent, which is claimed to materially increase the life of the paint. A question was raised as to the removal of this baked paint. There was no definite information on this point, and when these cars are shopped for repainting it will be interesting to learn of the procedure followed.

As regards locomotive painting it seems to be the general opinion of the master painters that the present so-called economical methods are grossly extravagant. It is believed that with more time, more paint coats and with better material a locomotive can be painted at a decrease in ultimate cost, because the finish will last much longer, the cost of maintenance will be materially decreased and the engine will have a much more attractive appearance.

While the convention as a whole was a successful one, the lack of a thorough discussion of all the papers presented should be mentioned. Three or four subjects received a very thorough discussion, but there were others that were passed with only the presentation of the report. In order to obtain the greatest good from a subject it should be thoroughly discussed; and if for any reason it cannot be discussed, it should not be presented at that time. Furthermore each member having anything constructive to offer should not hesitate to give his information. If an author of a paper knows that his paper is to be closely analyzed, he will of necessity make a closer study of the subject assigned to him, and present a much more able paper in order to protect himself. In assigning the papers care should be taken that the authors are fully capable of handling the subjects, and they, in turn, should exert their best efforts to make their paper the best one presented. In this way the good reputation of the association will not only be maintained and advanced, but its prominence amongst the railway mechanical associations will grow, and the value of its work to the trade will be recognized by those in authority.

Railroads and College Men

A correspondent, whose letter is printed in this issue, gives his ideas of the reasons why so few college trained men remain on the railroads. While what he has to say may be true in many cases, does the whole fault lie with the railroads?

The colleges have a responsibility in this connection which should not be overlooked. Are they generally accepting it and supplying the kind of training that will permit their graduates to enter the railroad field with as good an equipment as is

supplied for other fields of endeavor? So far as the mechanical department is concerned, and it is particularly this department that our correspondent refers to, the indications are that with but two notable exceptions in the United States and possibly one in Canada, the colleges where mechanical engineering is taught at all are making but slight effort to give their students the kind of training that will prepare them to compete on the railroads with men of similar mental caliber who have come up through the ranks. To be sure, the graduate's personality enters very materially into the question and it is difficult to make comparisons, but the result of an examination of the college trained men who have made distinct successes in the mechanical department will show so great a predominance in favor of a few colleges where more or less special attention has been given to a preparation for railroad work, that the indications are conclusive that such a preparation gives the man a decided advantage. It is by no means certain that a special training, confined exclusively to railroad subjects is the best for the future success of the graduate, but instruction in how to apply engineering principles to the solution of the peculiar and special problems met with in locomotive and car design, operation and repair, appears to be sadly lacking in most mechanical engineering courses. A college would be failing in its duty if it gave the degree of mechanical engineer with a training in the application of engineering principles to the railroad or any other single field. On the other hand, it is equally failing in its duty to the railroads of this country if it gives its students no opportunity of learning how to apply the same principles to railroad problems as well as those found in stationary practice, the electrical field, or general manufacturing. The railroads need college trained engineers and no one realizes that better than the responsible officers in the various departments. But is it surprising in view of the experience of the past, that they cannot see their way clear to make any special inducement to them? There is no field which at the present time offers a more attractive future to a properly trained mechanical engineer who has suitable personal characteristics and a sound character than will be found in the mechanical departments of our railways. To be sure, they will have a much harder path to follow than they probably should have, due to the disappointing experience with their predecessors, but those who have the stamina to overcome the obstacles and the ability to make up for the shortcomings in their training while in college in case they are unfortunate enough to come from those colleges which are weak in this regard, will find that the reward is well worth striving for and at thirty or thirty-five years of age they will be commanding a larger salary and be in a much better position than their classmates who, in other lines of work, seemed to be far above them at twenty-five.

Freight Car Troubles

Better maintenance of freight cars is one of the most important, if not the most important, problem now before the mechanical department. J. C. Fritts, master car builder, Delaware, Lackawanna & Western, in his paper at the September meeting of the Central Railroad Club, makes some very excellent suggestions and offers some sound practical advice for improvement in this direction. He analyzes the whole situation and reaches the same conclusions other investigators have reached, that the draft gear and its attachments are the principal cause of the trouble. While it is the older and weaker cars that fail most frequently, some of the recently built equipment is proving a source of considerable trouble because of poor design. Mr. Fritts believes that, with the proper repairs, much of this older equipment can be kept in service with a moderate cost of upkeep for a number of years. Where a car has an expectant life long enough to make the expense advisable, he suggests the application of a complete

steel underframe. In cases where so large a cost does not seem to be justified he recommends the application of steel draft sills which extend through and over the body bolster and are backed up with good heavy compression timbers. F. F. Gaines, superintendent of motive power, Central of Georgia, in his analysis of this same subject which was published on page 205 of the April issue of this journal, shows that on his road 38.91 per cent. of the cost of freight car repairs was due to the draft gear and its attachments. Following this analysis he put in practice the scheme which is now again recommended by Mr. Fritts, and applied metal draft arms engaging the steel body bolster to a number of wooden coal cars which were being rebuilt. This extended well back of the body bolster so as to reinforce the center sills and was applied in connection with a substantial friction draft gear. These cars went in service and after three years they showed no cost for repairs of couplers or draft gears. One of them was in a collision on a foreign road and when returned had the eight longitudinal sills and the side planks broken, but there was no damage whatever between the center of the car and the end, including the draft gear. This experience would seem to conclusively prove the value of Mr. Fritts' suggestion. It will be noticed that Mr. Gaines applied friction draft gears to the cars rebuilt at that time and Mr. Fritts strongly urges the same action. He gives, in his paper, an analysis of the comparative service for a period covering twenty-six weeks between various types of spring gear and various types of friction gear. The report covers spring gears on 15,000 cars and friction gears on 4,805 cars. It was compiled from weekly reports submitted by inspectors and shop foremen at every point on the Delaware, Lackawanna & Western where repairs were made, and shows that spring gears failed on 81 per cent. of the cars during this period, while with the friction gears there were failures on but 17 per cent. These failures included broken couplers, knuckles and knuckle pins, pockets and pocket rivets, followers, springs and draft spring castings, and in view of the fact that most of the spring gears were applied to wooden cars, which to a certain extent form a cushion themselves and protect the gear, the indications seem to be most conclusive in favor of the friction gear. Mr. Fritts makes a most excellent suggestion that there be formulated some standard specification which could be adopted for the testing of draft gears before purchasing in order to know something of their value in connection with the shock absorbing capacity and the amount of recoil. Expense of maintenance of the car roof is not overlooked and the author recommends that the present wooden roof be supplanted by an all-metal one as soon as it has been demonstrated what the proper construction should be.

* * * * *

It will be remembered that at the last convention of the Master Car Builders' Association there was considerable discussion over the elimination of 40,000 lbs. and 50,000 lbs. capacity cars in interchange. This was finally disposed of by the appointment of a committee to obtain from each member of the association a statement as to the situation from its viewpoint and ascertain if it would be possible to make recommendations to the American Railway Association for the setting aside of older cars. This committee has been appointed and D. F. Crawford, general superintendent of motive power, Pennsylvania Lines West of Pittsburgh, Pittsburgh, Pa., is the chairman. It is difficult to see the direct relation between the capacity of a car and its strength for resisting shocks, and it is quite probable that this committee will take the broad view of the situation and not follow the lines indicated by the title of this subject. Mr. Fritts suggests that the question is one of draft gear, draft timbers and buffing arrangements, much more than capacity or even age. What is desired is strong cars, not necessarily high capacity cars, and if this committee

can recommend a minimum strength requirement which will govern the interchange of cars, it will perform a most valuable service.

NEW BOOKS

Master Boilermakers' Association Proceedings of the Seventh annual convention. Bound in paper. 6 in. x 9 in. 174 pages. Illustrated. Published by the Association, H. D. Vought, Secretary, 95 Liberty St., New York. Price \$1.00.

A condensed report of the 1913 convention of this association appeared on page 314 of the June issue of the *American Engineer*. The volume of Proceedings, however, contain the verbatim account of the discussion, together with the full text of all of the papers presented and of the addresses which were delivered before the meeting. Papers on length of tubes without midway support; weak and unsafe condition of boilers; best method of welding the superheater tubes; effect of superheaters on the life of the firebox and flues; inspection of boilers; best forms of grate; applying and caring for flues; chemically treated feed water and advantages of oxy-acetylene and electric welding for boilers were discussed. The Proceedings contain a list of the members and their addresses, the membership of the committees for the following year, and the subjects that will be discussed at the next convention.

Smoke and Smoke Prevention, Bibliography of. Compiled by Ellwood H. McClelland, Technology Librarian, Carnegie Library of Pittsburgh. Bound in paper. 164 pages. 6 in. x 9 in. Published by the University of Pittsburgh, Pittsburgh, Pa. Price 50 cents.

This pamphlet is Bulletin No. 2 of the Mellon Institute of Industrial Research and School of Specific Industries. It includes an extensive list dealing mainly with coal smoke, but does not include the literature on dust, fumes and other subjects more or less directly related to the suppression of smoke. Titles and quotations are given in the original, regardless of variations in spelling. Each reference gives the date of publication, shows the extent and method of illustration and indicates the length of the article either in words or by inclusive pages. Titles and sources are given in full. This includes reference to all foreign publications as well as those in the English language.

Engineering Education. Proceedings of the twentieth annual meeting of the Society for Promotion of Engineering Education. Bound in cloth. 508 pages. 6 in. x 9 in. Illustrated. Published by the Society, H. H. Norris, Ithaca, N. Y., secretary. Price \$1.25.

At this meeting there were a large number of papers and addresses presented by the leading engineering educators in the country on subjects connected with the improvement of engineering education. The assigned subjects, on each of which there were several reports and considerable discussion were: The Teaching of Elementary Physics, the Training of Engineering Teachers, the Efficiency of Engineering Education, Engineering Laboratories, Entrance Requirements for Engineering Schools, Industrial Education. Among the papers presented were a number descriptive of engineering laboratories and apparatus, of methods which have proven satisfactory in the teaching of various subjects and of the proper use of some of the recently perfected testing instruments.

International Railway Fuel Association. Proceedings of the fifth annual convention. Bound in paper. 315 pages. 6 in. x 9 in. Illustrated. Published by the Association, C. G. Hall, 922 McCormick building, secretary. Price 50 cents.

The proceedings of this association form the best single source of information concerning the use of fuel on railways. While most of the deliberations are confined to a discussion of coal, including the mining, handling and use, liquid and gaseous fuels are also given some attention. In fact, at one of the recent conventions the most extensive and important paper presented was

entirely confined to the discussion of fuel oil and its use on locomotives. At the fifth convention papers were presented on the following subjects: Construction, Development and Operation of a Bituminous Coal Mine, Firing Practice, Modern Locomotive Coaling Station, Scaling of Locomotive Boilers and Resultant Fuel Loss, Self-Propelled Railway Passenger Cars, Standard Form of Contract Covering Purchase of Railway Fuel Coal, Sub-Bituminous and Lignite Coal as Locomotive Fuel. A beginning was made at this meeting in preparation of a standard manual of firing practice which eventually will probably prove a most important and valuable basis for instruction of locomotive firemen. The proceedings include the full text of the papers and the verbatim account of the discussion, together with a copy of the constitution and by-laws, a list of the members with their addresses as well as a list of subjects from which those to be discussed at the next meeting will be selected.

Water, Its Purification and Use in the Industries. By William Wallace Christie. Bound in cloth. 212 pages. 5¼ in. x 7¾ in. Illustrated. Published by D. Van Nostrand Company, 25 Park Place, New York. Price \$2.00.

The purification of water is treated in this book more from an industrial standpoint rather than for drinking purposes, although the latter use is also considered. It gives a comprehensive treatment of the apparatus and methods of purification, presenting all available data from a technical rather than from the commercial viewpoint. In the first chapter the sources of water, its impurities, uses and reagents used for softening, are considered and the next two chapters are devoted entirely to water softening, the second one discussing the cold process and the third, the hot process. Results accomplished by softening systems are considered in the fourth chapter, while the fifth discusses pressure filters. Following these are chapters on aeration, sterilization, measurement, oil filters for boiler water, purifying drinking water, etc. Many tables of value to users of water for manufacturing or industrial purposes are included. The book is illustrated with drawings and phantom views of the various apparatus used in this connection.

Locomotive Boiler Construction. By Frank D. Kleinhaus. Additions by Geo. L. Fowler. Illustrated. Bound in cloth. 462 pages. 5½ in. x 8 in. Published by Norman W. Henley Publishing Company, 132 Nassau street, New York. Price \$3.

Presentation of theoretical matter has been avoided as far as possible in this book. The best and most rapid methods of the large builders and railroads have been given and new untried methods or designs have been avoided. The author states that as the different operations on the different makes of boilers are so similar to each other, it has been considered best to devote a section to the description of boilers in general. This section only covers five pages and following it the locomotive boiler is taken up in the order in which material goes through the shop. It begins with the laying out of the sheets and gives the necessary information that will enable a boilermaker to lay out the different parts of the boiler. In some cases several methods, each best suited to certain conditions, have been explained. Following this there is a section on shearing and one on flanging. The next operation is the punching or drilling of holes and preparing the edges for calking. The next operation considered is that of bending, following which there is a section on assembling and calking and then one on details. Boiler shop machinery has also been allotted a section of the book, and an attempt has been made to show the points of machines which are liable to become broken through carelessness. Instructions are included for keeping the machines in good running order and how to make necessary repairs. The testing of boilers is allotted a chapter and the last section is devoted to a group of useful tables which are intended to include all the matter that is necessary in connection with the construction of a boiler, together with the stresses which are set up in the various members due to the

steam pressure and expansion. A number of folding plates showing several different types of modern locomotive boilers in detail are included at the end of the book. Difficult designs have been selected for these drawings with the idea that a person who has become capable of laying out and following the sheets shown through the shop would have no difficulty in handling any boiler made.

Factory Lighting. By Clarence E. Clewell. Bound in cloth. 156 pages. 6 in. x 9 in. Illustrated. Published by McGraw-Hill Book Company, 239 West 39th St., New York. Price \$2.00.

Examples can be seen on every side, that a large amount of artificial light does not necessarily mean good lighting. Mistakes, due to ignorance of the principles of good illumination, have been frequent in otherwise perfectly appointed shop buildings and offices. There is no doubt that good lighting is an aid to accurate workmanship and manufacturing output, and contributes to a large extent to a reduction in manufacturing cost. The author of this book has been engaged in the design and supervision of the installation of lighting systems for a number of years, and aims to tell how to obtain good lighting and to tell it in a simple way. The experiences of actual installations are made the basis for analysis and explanation throughout the book. Actual results are given precedence over generalized statements. The office, the drafting room and the power house have been given consideration as well as the shop itself. One chapter is devoted entirely to machine tool lighting and the insignificance of the cost of adequate lighting for machine tools is illustrated by the statement that the energy and maintenance of an individual electric lamp amounts to 25c. a month, while the operator who depends on the lamp receives \$3 a day. Therefore, the cost of the lamp is equal to the wages for two minutes each day, and if the better illumination will save the workman that amount of time it is a paying investment. Photographs are freely used to emphasize the facts explained in the type and drawings of typical installations are included.

Rules of Management. By William Lodge, president of the Lodge & Shipley Machine Tool Company. Bound in cloth. 140 pages. 5 in. x 8 in. Published by the McGraw-Hill Book Company, 239 West 39th St., New York. Price \$2.00.

In his foreword, Mr. Lodge states that when he decided to relinquish the active management of the Lodge & Shipley Machine Tool Company and let a younger generation take up the reins, he realized what would probably happen if he simply handed them over to others who had never learned how to drive. He, therefore, endeavored to see what could be done to prevent the immediate development of a new set of conditions with which the organization he had built up would not be able to cope. In carrying out his plan of teaching the subordinates to handle things, the record of his personal experience, put in the form of rules and comments, was printed for the information of the succeeding manager of the shop. This work is the result of the desire to give, in a permanent written form, a knowledge of facts and scheme of organization that would enable the next manager to carry on his work with a feeling that he was on sure footing on the ground over which he must travel. These instructions may also be found applicable in many lines of machine building and they have therefore been published for general distribution. In this book the duties and work of each department are outlined in some detail and there are separate chapters for each class of employees from the general manager to the janitor and watchman. These rules and instructions throughout are excellently worded, tempered with common sense and are thoroughly practical in their application. Although intended for the machine building industry, the principles of good management in the abstract are so well understood and have been so thoroughly interwoven throughout the whole series of instructions, that they are applicable to practically any manufacturing activity.

COMMUNICATIONS

GRINDSTONE AT RIP TRACK

ASHLAND, Ky., May 26, 1913.

TO THE EDITOR:

The freight car rip track at the Ashland shops of the Chesapeake & Ohio is nearly half a mile from the main shop, and, while we have an air line running to it to supply 90 to 100 lbs. pressure for small pneumatic tools, testing, etc., it was necessary to bring the edge tools and saws to the shop for sharpening. To save this lost time we rigged up the arrangement shown in the illustration. It consists of a reversible air drill and a steel shaft, turned at one end to fit the socket of the drill and squared at the other end to fit the hole in a grindstone. The boxes or spools used for bearings are cast iron with a brass bushing

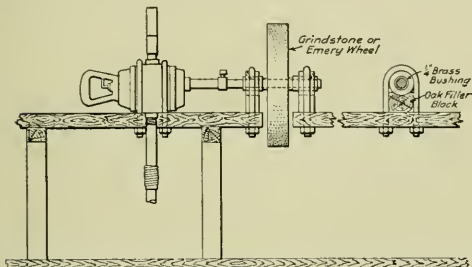

Reversible Air Motor Temporarily Driving a Grinding Wheel.

pressed in and bored to fit the shaft. They rest on oak blocks and are held by $\frac{3}{4}$ in. U-bolts. The same form of bolts is used to hold the air drill to the bench.

When it is desired to use it, the device is rigged up on one end of the work bench in the carpenters' shed. The shaft and its attached parts are stored when not needed, and the air drill is used in regular work.

This arrangement will be found very satisfactory when using a grindstone 18 in. in diameter or less. Also on small emery wheels for sharpening cross-cut saws. We have the latter mounted on a separate shaft, all other parts being used as shown.

W. P. HUNTLEY,
General Foreman.

CAR WHEEL FLANGES AND TREADS

PITTSBURGH, Pa., September 10, 1913.

TO THE EDITOR:

Referring to a series of experiments with wheels under loaded single trucks as described in the September issue. Prof. Wallace deserves a great deal of credit for giving us something to think about. Some of his results check very accurately with the long accepted theories and the experiences obtained by the different railroads for the last fifty years, while others do not. Therefore, it may not be amiss to reflect briefly on each item brought out by Mr. Wallace.

Conc of the Tread.—The figures show very conclusively that the cone is essential. It, of course, compensates for the difference in length of the rails on curves and on tangents it keeps the flanges from continually hugging one rail or the other, and it is for this very reason that the increase in taper from 1 in 32 to 1 in 20 has produced improved results.

Mating of Wheels on One Axle.—Mr. Wallace obtained on badly matched wheels (B) much better results than on mated ones (A), and on the 3 deg. curve (D and E) obtained about equal results, although one set was exactly mated and the other one $\frac{3}{8}$ in. out, with the larger wheel on the inside rail at that. It is self-evident that these figures contradict all fundamental

and accepted principles and must be due to some differences in outside conditions. It looks as if the readings on wheel A are entirely out, so that the author is entirely justified to conclude contrary to what the figures show.

Mating of Wheels as Pairs.—It is very strange that a difference of $\frac{1}{16}$ in. in mating between the front and the rear pair (each pair properly mated) should have any influence on the resistance, and in spite of this Mr. Wallace found (set A) a difference of over 6 lbs. on a 12 deg. curve in favor of having the large wheels leading. This again points towards some irregularity not accounted for.

Location of Large Wheel.—The figures show that the resistance drops whenever the larger wheel is located on the outside rail and vice versa. This is natural, as the larger circumference then runs on the longer rail, and the conditions are more nearly as they exist on a tangent.

Material.—The rolling resistance depends on the smoothness and the hardness of the wheels. Wheels A and C were both ground so the hardness was the only one item left to affect the result. Mr. Wallace found that the chilled iron wheel showed about twice as much resistance as the cast steel one, which again points to some irregularity in the performance of the set A, and inasmuch as the difference was actually 5 lbs. on a tangent as well as on the curves, the discrepancy must be looked for in a difference of the journal friction.

It is, of course, well understood that the friction found on these single trucks is not train resistance properly, as so many other items enter into that question. It is also likely that some of the items under consideration will show up differently as soon as the trucks are put under a car. None the less, the figures so far obtained are very interesting and Prof. Wallace deserves thanks for starting this work.

A. STUCKI.

WHY DON'T RAILROADS HOLD THE COLLEGE MAN?

CHICAGO, Ill., September 10, 1913.

TO THE EDITOR:

"About 2 per cent. of the college men we employ stay with us," reports a motive power man on one of the big trunk lines. Scan the records of any road taken at random or any number of roads; note the number and names of the college men entering the service of a road and follow them through—one, two, five years, and in nine cases out of ten it will be found that, at the end of five years, only about 10 per cent. remain. Although they know this condition, few officials have done anything to correct it. Why do the college men leave railroad service, especially in the motive power department? They are better taken care of during slack times than the rank and file in other activities, they are shown every courtesy, and given every opportunity to advance while learning. Yet they leave; some in two or three months, others in two or three years.

The reasons are many, but usually simple, and it is surprising how little is done to hold the college trained man. Take the man, for instance, who enters the motive power department. He is usually a graduate in mechanical engineering and decides to become a special apprentice. Without casting any reflections on the piece work system, it is generally a fact that if he enters a piece work shop he is decidedly unfortunate and his time is practically wasted. This is borne out by unsolicited statements of the men themselves. There is only one way to teach a man to do things—have him do them! A machinist or other skilled laborer in a piece work shop is busy, far too busy to have time to show some one else how to do the work properly; he not only does not have time, but he can't and won't afford it. Every minute taken from his work means just so much from his pay envelope. Go through a piece work shop and you can doubtless count on the fingers of one hand the number of apprentices running big machines. In the parlance of the shop, "they

don't get a show." To be sure, they are allowed to stand by and be helpers, hold a brush and help transfer work to and from floor and machine; they can ask all the questions they wish and gain much useful knowledge, but will they be able to handle tools intelligently? Can they tell others how they want a thing done? Hardly. These are conditions as they exist in one of our biggest railroad shops in Pennsylvania, and the apprentices spend four years at it too. Is it any wonder that some of them leave rather than be a "brush holder" for four years? They obtained more actual machine work in college, and ran the tools themselves.

In Chicago is another very large shop, run by a western road—a "closed day rate" shop—no piece work. Special apprentices as well as regulars enter this shop; are assigned to a certain gang machinist (if on the floor) or lathe, generally a bolt lathe first. In less than a week they will be running that machine under the supervision of an apprentice instructor having been first broken in by the apprentice that preceded them. And so it goes in every department; they are taken right in hand, and lay off shoes and wedges, set valves, hang link motions and so forth, and do it themselves, as well as the machinist who taught them. They are moved from one job to another, getting a real chance to learn, with the result that they know tools at least, and can step into a foreman's position with the assurance that they at least know what the men under them are doing. This particular shop has a three year course for specials and four for regulars. Three years in a day shop is enough, but four, or even six in a piece work shop does not equal it in many cases.

Follow along with the men who have "stuck" through the apprentice course. The percentage who finish in the day rate shop is generally smaller by far than in the piece work shop. This at the start is a big advantage, both to them and the company, for the very reason that the work they *personally* do is real hard work, as hard and exacting as the work of the men they work under; they are not mere helpers and observers, but workers in every sense of the word. It is this hard work that weeds out the "collar and cuff" crowd who would rather sit at a desk and "push a pen" than get greasy and dirty. This class is weeded out in the first two or three months and no one is the loser. Then there is the ambitious few who have served, say two years of their time; they do their work well and are well liked. Some go home on vacations, or go here and there on business for the company and meet men, fellow classmates of theirs who are in industrial lines. These men are making, on an average, *more than twice as much* as the railroad man is, are being steadily advanced, and have an assured success before them. Yet they left college at the same time as the railroad apprentice, who still has one or two more years before him at a laborer's wage! What is the result? Is it any wonder that 50 per cent. quit at the first opportunity and go into other fields? Can they be blamed? The railroads, however, seem content to let this big majority go by after training them for so long. No inducements are held out—they don't seem to think it is capital gone to waste.

The way to hold these men is to cut the apprentice course for them to two years. Any man who is a graduate mechanical engineer, if he is any good at all, can with the right system get all that is necessary out of the shops in two years. Yet the Union Pacific is the only road to my knowledge that has realized and profited by this fact. There are men (and you can see them every day) in one of our big piece work shops in Pennsylvania, both special and regular apprentices, who have served their four years, yet cannot swing a hammer properly or chip out a stud; they can be seen standing at a bench in the shop practically "pushing" the hammer, and this after four years training.

To get back to the subject, the few men who finish their time in the day shops are at once made machinists, and after two

or three months more are made assistant roundhouse foremen, assigned to special duty or some similar position paying from \$100 to \$125 a month. Four years in college and three or four more in the shops; seven or eight all told. They, after all these years of preparation, are getting as much as a good bookkeeper, clerk or draftsman who in many cases stepped into these positions right out of high school, or after a few months of business college. They have a bank account, and are bringing up families, while the prepared college man is only earning a few cents an hour.

One road makes a specialty of turning its "shop graduates" into the test department, where they don't get even as much as the machinists in the shops. After eight years of study and preparation they can get more for their muscle than for their brains! They are given work far beneath their capabilities; odd drafting jobs, computing and tabulating road tests, shop tests, etc., things that wouldn't tax the mind of a high school graduate; things that are not even worth the salaries they are paid. Yet they are kept on the pay roll, thrown a sop in the form of a title, and so it goes.

I have pointed out the faults—what is the remedy? Simply this: If you do have an apprentice course for college graduates, make it for *two years*—no more. Have special instructors and machines for your apprentices, make them work *all* the time they are on bench, machine, floor, and in the roundhouse, and get all there is to be gotten out of it. See that they are able to run their lathes, planers, shapers, etc., themselves, have them turn out work and compete with the other machinists. A schedule as follows would be ample for all purposes and would, with proper supervision by competent instructors accomplish more in two years than the present system in some shops does in four. Bench work, 3 months; machines, 6 months; floor, 9 months; roundhouse, 3 months; special work, 3 months; total, 2 years.

Under special work would come dynamometer car, test work, drafting, etc. Some roads require boiler shop, but unless a man is to be employed there later as an assistant foreman, one month should suffice. Some roads require no work in the boiler shop at all.

One other thing—give them a fair living wage; some roads do, but the majority do not. The pay is usually from 15 cents to 20 cents an hour the first year and from 20 cents to 30 cents the last. The result is that two-thirds have to have additional funds from home.

Give a course of two years properly conducted, make the men earn their money and pay them what they earn; and make them work *after* their course is completed as well, increasing their pay accordingly, and the railroads will be in dollars and cents on one hand and build up a force of executives on the other that will stick and return a hundred fold what the company has spent on their education and preparation.

I. I. W.

LEAD STORAGE BATTERIES.—On the continent of Europe the lead battery appears to have made quite a permanent position for itself in connection with a certain class of road transit. Complete fire brigade equipments, tower wagons and light postal vans are used in considerable numbers, while one company has produced and sold large numbers of powerful tractors for municipal service.—*The Engineer*.

HIGH SPEED SHIP PROPELLERS.—A new propeller for high speed ships has been patented by Sir Charles Parsons. It has blades of large area, with a leading edge of scimitar or thrown-back shape. The formation, which is verified by experiment, induces a more regular stream-line motion of the fluid round the blade, and has a considerably improved efficiency at high speeds, while showing some improvement at low speeds.—*The Practical Engineer*.

NEW LOCOMOTIVES FOR THE SANTA FE

Six Wheel Tender Trucks on Passenger Locomotives—Mikado Type Introduced on This Road

The Atchison, Topeka & Santa Fe has recently placed in service eighty-eight new locomotives, which were built by the Baldwin Locomotive Works. Five types are represented, as follows:

- 10 consolidations for oil burning.
- 12 Santa Fe type for coal burning.
- 32 Pacific. These all have balanced compound cylinders. Thirteen burn oil, fifteen bituminous coal and four Gallup coal (a species of lignite).
- 29 Mikados for coal burning.
- 5 switchers for oil burning.

In designing these locomotives, special attention was given to making the details interchangeable with those on locomotives previously built; and practically all parts subject to wear interchange with engines of other classes. This is especially true in the case of the 2-10-2, or Santa Fe type locomotives. The two classes have the same piston stroke and driving-wheel diameter, and the driving-wheel centers, tires, boxes and axles are inter-

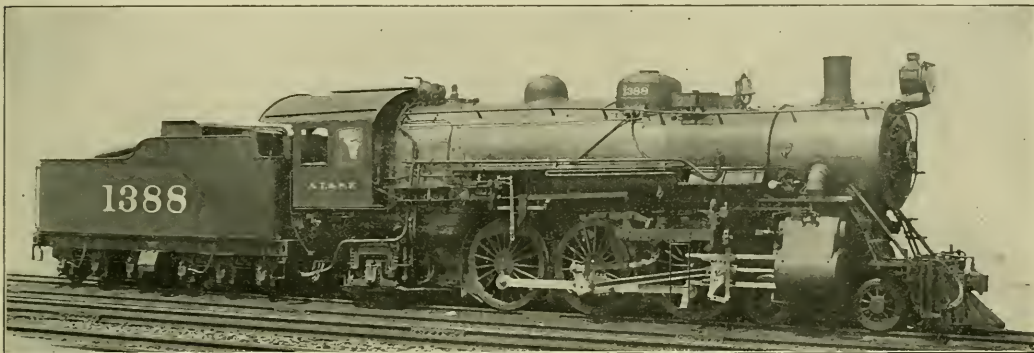

Pacific Type Locomotive with Six-Wheel Tender Trucks.

With the exception of the 2-8-2 type, which represent a new design on this road, these engines are all nearly duplicates of others previously built.* Special interest therefore centers in the mikados, which are intended for heavy freight service on divisions having moderate grades. These locomotives were designed with a weight limitation of 55,000 lbs. on each pair of driving wheels, and the actual weight runs close to this limit,

changeable; as are also the crank pins and piston valves, and, as far as possible, the valve gear details. The front foot plates and cast steel frame crossies also interchange on these two classes.

The boilers of the Mikado type locomotives, although somewhat smaller than those of the Santa Fes, are generally similar in construction. The grate castings are interchangeable, and the

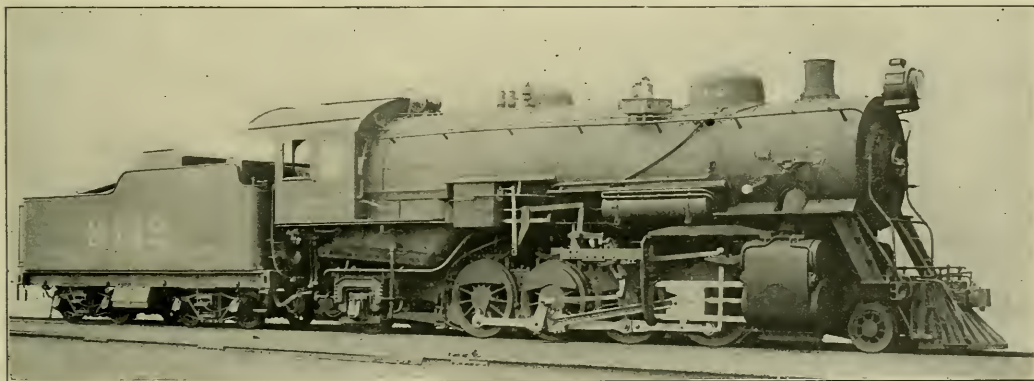

Mikado Type Locomotive on the Santa Fe.

with a very even distribution; the minimum and maximum weights per pair of wheels being respectively 54,500 lbs and 54,900 lbs. The tractive effort is 50,700 lbs., and the locomotives can traverse 16 deg. curves.

superheaters are alike except for the lengths of the pipes. The safety-valves on the Mikado type are mounted over a 16-in. manhole, located back of the main dome. The openings for the dome manhole are in the third boiler ring, which has a welded longitudinal seam on the top center line. The joint is strengthened by a large inside liner, cut from a single piece of

*For description and dimensions see *American Engineer*, October, 1912, page 515.

11/16 in. plate. The dome is of pressed steel, in one piece. The furnace equipment includes a brick-arch, also power-operated fire door and grate shaker.

The cylinders have the same diameter as those of the latest single expansion Pacific type locomotive built for this road, and the cylinder heads of the two classes are interchangeable. The cylinders of the Mikados are provided with vacuum relief valves, and also with drifting valves of the Sheedy pattern. The main frames extend forward under the cylinder saddle, in the form of single rails which measure 5 in. in width and taper in depth from 12 in. at the front to 15 in. at the back. Nine horizontal and two vertical bolts, 1 1/4 in. in diameter, secure each cylinder casting to the corresponding frame. The cylinders are also bolted to the front deck-plate by six 1 1/4 in. bolts, and are secured to the smoke-box shell, and to each other, by double rows of the same size bolts. This provides a strong construction, with ample bearing areas between the various parts.

The steam distribution is controlled by 16-in. piston valves set with a lead of 1/4 in. The gears are controlled by the

springs interchange with those used on the single expansion Pacific type locomotives to which previous reference has been made.

The Mikado type locomotives have tenders of the railway company's standard design, with tanks of 8,500 gals. capacity. Twelve tons of coal can be carried, and a coal pusher is provided.

Including the new balanced compound locomotives, there are now in service, on the Santa Fe system, eighty balanced compound locomotives of the Pacific type with inclined high-pressure cylinders. The new locomotives represent the latest development of a type which has proved particularly successful, largely because of intelligent handling and the provision of suitable maintenance facilities. These locomotives are fully capable of working heavy express passenger traffic under the unusually difficult conditions existing on certain sections of this road.

The tenders of the new engines of this type have water tanks of 9,000 gals. capacity, and are carried on six-wheel trucks designed by the Commonwealth Steel Company, acting jointly with the mechanical engineer's office of the railway company. The

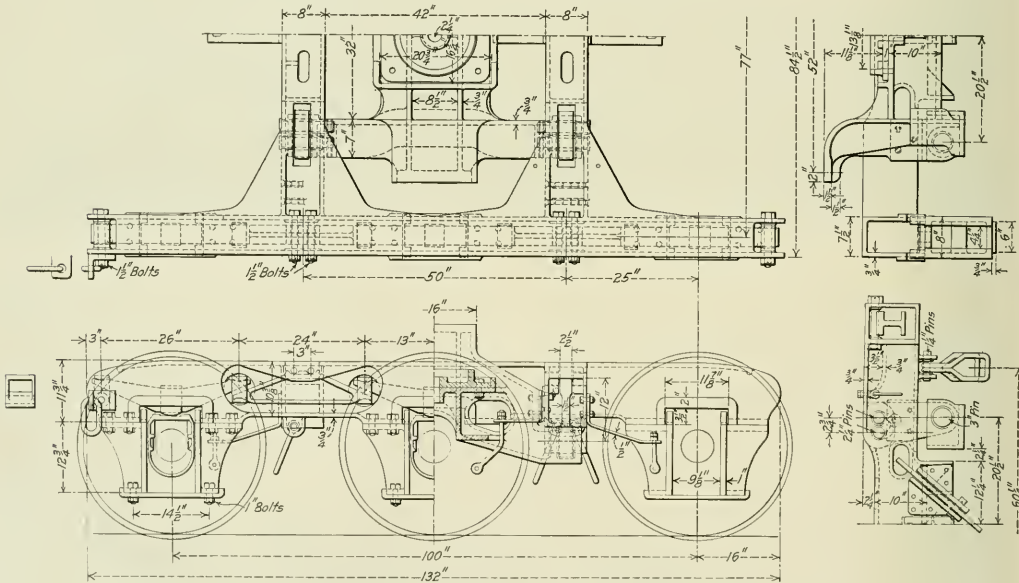

Six-Wheel Equalized Tender Truck with Cast Steel Frame.

Ragonnet reverse mechanism. This device has been applied to all road engines recently built for the Santa Fe.

As in the ten-coupled locomotives, these engines have supplemental counterweights keyed to the main axle between the frames. This has proved, on this road, a satisfactory method of counterweighting locomotives which have heavy reciprocating and revolving parts and comparatively small driving wheels.

The arrangement of the rear frames and trailing truck in these engines is materially different from that used in the Santa Fe type locomotives. In the latter design, the firebox extends forward over the rear drivers, and the trailing truck carries 25,500 lbs. It is of the Rushton pattern, with inside journals which measure 7 1/2 in. x 12 in. In the Mikado type locomotives, the firebox is placed back of the driving wheels, and the rear truck carries 40,700 lbs. It is also of the Rushton pattern, but with outside journals, measuring 8 in. x 14 in. With the exception of the springs, this truck is interchangeable with that used under the latest 2-6-6-2 type locomotives built for the Santa Fe. The

truck wheel-base is 100 in. Each truck frame is of cast steel, in one piece, with pedestals of the same material bolted to it. The bolster is also of cast steel, and it is suspended on heart-shaped links which are pinned to the transverse sections of the truck frame. These links are unsymmetrical, the outside upper pin in each being vertically above the lower pin. As a result, one side of the bolster is raised higher than the other when the truck is displaced on a curve, thus helping to maintain the stability of the tender and keeping a more even distribution of weight on the inner and outer rails. The weight carried on each pair of wheels is approximately 30,000 lbs., which is moderate when compared to that found in many recent tenders of large capacity. The truck springs are of the half-elliptic pattern. They are mounted directly over the journal boxes, and the three springs on each side are connected by cast steel equalizers, which support the truck frame.

The problem of standardizing locomotive details is specially difficult on a system which, like the Santa Fe, includes both level

and mountain divisions, and requires a variety of locomotive types for its successful operation. This problem, however, is being successfully solved; and the new Mikado type locomotives illustrate in a striking manner, how the work is being accomplished. The result will be a decrease in maintenance costs and in the amount of stock required for renewals, together with fewer engine failures and increased motive power efficiency.

The general dimensions, weights and ratios of the new 2-8-2 type locomotives are given in the following table:

General Data.

Gage	4 ft. 8 3/4 in.
Service	Freight
Fuel	Bit. coal
Tractive effort	50,700 lbs.
Weight in working order	284,100 lbs.
Weight on drivers	218,900 lbs.
Weight on leading truck	24,500 lbs.
Weight on trailing truck	40,700 lbs.
Weight of engine and tender in working order	455,000 lbs.
Wheel base, driving	16 ft.
Wheel base, total	34 ft. 1 in.
Wheel base, engine and tender	66 ft. 3/4 in.

Ratios.

Weight on drivers ÷ tractive effort	4.32
Total weight ÷ tractive effort	5.60
Tractive effort × diam. drivers ÷ heating surface*	531.00
Heating surface* ÷ grate area	93.00
Firebox heating surface ÷ evaporating heating surface, per cent.	6.38
Weight on drivers ÷ heating surface*	40.20
Total weight ÷ heating surface*	52.10
Volume both cylinders, cu. ft.	18.30
Heating surface* ÷ vol. cylinders	297.00
Grate area ÷ vol. cylinders	3.19

Cylinders.

Kind	Simple
Diameter and stroke	25 in. x 32 in.

Valves.

Kind	Piston
Diameter	16 in.
Lead	1/4 in.

Wheels.

Driving, diameter over tires	57 in.
Driving, thickness of tires	3 3/4 in.
Driving journals, main, diameter and length	1 1/2 in. x 12 in.
Driving journals, others, diameter and length	1 1/4 in. x 12 in.
Engine truck wheels, diameter	29 1/2 in.
Engine truck, journals	6 1/2 in. x 10 1/2 in.
Trailing truck wheels, diameter	40 in.
Trailing truck, journals	8 in. x 14 in.

Boiler.

Style	W. T.
Working pressure	170 lbs.
Outside diameter of first ring	73 3/4 in.
Firebox, length and width	108 in. x 78 in.
Firebox plates, thickness	3/8 and 9/16 in.
Firebox, water space	F, 5 in.; S & B, 4 1/2 in.
Tubes, number and outside diameter	240—2 1/2 in.
Tubes, thickness	No. 11, B. W. G.
Flues, number and outside diameter	36—5 1/2 in.
Flues, thickness	No. 9, B. W. G.
Tubes and flues, length	20 ft.
Heating surface, tubes	3,849 sq. ft.
Heating surface, firebox	237 sq. ft.
Heating surface, arch tubes	25 sq. ft.
Heating surface, total	4,111 sq. ft.
Superheater heating surface	880 sq. ft.
Grate area	58.5 sq. ft.

Tender.

Wheels, diameter	34 1/2 in.
Journals, diameter and length	5 1/2 in. x 10 in.
Water capacity	8,500 gals.
Coal capacity	12 tons

*Equivalent heating surface equals evaporating surface (4,111 sq. ft.) plus 1.5 times superheating surface (880 sq. ft.), or 5,431 sq. ft.

CONDENSED RECORD OF LOCOMOTIVE EQUIPMENT

BY R. M. SWARTZ.

New York Central Lines, Chicago, Ill.

It is a general practice on most large railroads to maintain a record of the locomotive equipment in a condensed form, particularly for the use of those both in and out of the motive power department who do not have ready access to the drawings and other records covering the locomotive data, but who must have the information as to the tractive effort, general dimensions and the number of each class and type, etc., of locomotives. To be of the greatest value this record should be of a size that may

○ ○

Pony locomotives 24, 30 and 34 have no class letter.

Type A	
Type B	
Type C	
Type E	
Type F	
Type G	
Type I	
Type J	
Type K	
Type M	

EXPLANATION.

In the designation of classes the first letter, the index letter, a one-inch letter as placed on cabs, indicates the wheel arrangement as given above. All locomotives with the same wheel arrangement have the same letter beginning the class designation. Difference in design, size, etc., of locomotives with same wheel arrangement is indicated by the number following the dash. A small letter following a class letter or figure indicates that the locomotives are slightly different from those in the class represented by the letters and numbers preceding the small letters. Thus in the class designation "F-48c" the "F" indicates a ten-wheel locomotive, the "48" indicates a particular design of the ten-wheel locomotive, and the "c" (half the size of the "F" and "48") indicates that the locomotives in this class are slightly different from locomotives in the class "F-48a." Similarly locomotives in class "F-48a" are slightly different from class "F-48a," although all three classes are alike in general.

Fig. 1—Classification Sheet.

LIGHT BURNING ON PINE FORESTS.—The effect of light surface fires on pine timber is to kill or damage more than half of the mature trees, according to findings just announced by the United States forest service.

FOREST FIRES.—Forest officers throughout the West are congratulating themselves on a season so markedly free from heavy losses. They feel that the immunity from loss has been due to two principal causes, partly to a favorable season, but largely to a much better organization for fire prevention than has been attained heretofore. The effectiveness of the organization is shown particularly by the fact that while there were in all approximately 2,260 fires, as against 2,470 last year, yet the area burned so far this year is only about 60,000 acres as against 230,000 acres in 1912, and 780,000 in 1911.

be conveniently carried in a pocket, and it should be kept as nearly up-to-date as possible. One practice is to issue blue-printed books or to print the books and bind them in permanent binders. With the former method the books are either too large to be conveniently carried in a pocket, or, if of pocket size, are more or less incomplete and are not accompanied by a diagram of the engine, on account of the difficulty of preparing the text and diagrams of this small size which will make satisfactory blueprints. The latter method is satisfactory when the books are first printed, but they rapidly get out of date, necessitating re-printing at two or three year intervals.

To overcome the objections to both these types of books, the Lake Shore & Michigan Southern recently issued a book in a

loose leaf form which can be maintained indefinitely without reprinting the entire book, by simply adding new sheets for new power purchased or reprinting individual sheets when the number of corrections on a sheet makes it advisable to do so. The book is made up of four essential parts:

First: A "basis of typification" sheet based on the Whyte

No.	Class	Owning-ship	No.	Class	Owning-ship	No.	Class	Owning-ship	No.	Class	Owning-ship
5638	G-44	L	5677	G-46-D	...	5616	G-6M	...	5655	G-6B	...
5639	G-44	L	5678	G-46-D	...	5617	G-6M	...	5656	G-6B	...
5640	5679	G-46-D	5618	G-6M	5657	G-6B
5641	5680	G-46-D	5619	G-6M	5658	G-6B
5642	5681	G-46-D	5620	G-6M	5659	G-6B
5643	5682	G-46-D	5621	G-6M	5660	G-6B
5644	5683	G-46-D	5622	G-6M	5661	G-6B
5645	5684	G-46-D	5623	G-6M	5662	G-6B
5646	5685	G-46-D	5624	G-6M	5663	G-6B
5647	5686	G-46-D	5625	G-6M	5664	G-6B
5648	5687	G-46-D	5626	G-6M	5665	G-6B
5649	5688	G-46-D	5627	G-6M	5666	G-6B
5650	5689	G-46-D	5628	G-6M	5667	G-6B
5651

Fig. 2—General Numerical List.

system of locomotive classification, as used on the New York Central Lines, showing the general class letter assigned to each type of locomotive according to wheel arrangement. (See Fig. 1.)

Second: A general list of engine numbers, which also shows the class designation of each particular engine and the initial

Class.	Type.	No. of Loco's	Hauling Cap's	Cylinder	Diameter of	Boiler Pressure	Weight on	Service.
			Percentage		Driving Wheel		Drivers, Lbs.	
G-5ACDE	Consol.	3847,023	x32	63200	200000			Freight
G-6KMYZ	"	6547,223	x32	63200	207000			"
G-5R	"	2547,223	x32	63200	208000			"
G-6B	"	2047,223	x32	63200	211000			"
G-6M	"	4047,223	x32	63200	214500			"
G-6V	"	1547,223	x32	63200	211500			"
G-18V	"	1050,225	x32	63180	214500			"
G-42A	"	2535,121	x30	63200	149000			"
G-42B	"	2436,221	x30	63200	154000			"
G-43	"	12036,821	x30	63200	158000			"
G-46AB	"	749,123	x30	67200	203000			"
G-46D	"	2049,123	x30	67200	211900			"
G-46G	"	1549,123	x30	67200	214500			"
I-40	Atlantic	1021,419	x26	69180	97500			Passenger
I-40	Prairie	4525,320	x28	81200	134000			"
J-41A	"	928,621	x28	79200	168000			"
J-41B	"	128,621	x28	79200	168800			"
J-41C	"	1028,621	x28	79200	170000			"
J-41D	"	728,621	x28	79200	165200			"
K-2ADL	Pacific	9029,922	x28	79200	170700			"
K-2BC	"	629,922	x28	79200	167000			"
K-3	"	1031,723	x26	79200	173000			"
M-3	10 Wh. Switch	862,525	x28	62210	270000			Switching

Fig. 3—Condensed Classification.

of the owning road, when the engine is the property of a subsidiary line. (See Fig. 2.)

Third: A condensed classification, which covers the number of engines in each class, the type and the service, with the tractive effort, the diameter and the stroke of the cylinders, diameter of the driving wheels and the weight on drivers of each class. (See Fig. 3.)

Fourth: Individual classification sheets for each class of engine, each sheet having a small but complete diagram of the engine with its principal dimensions, a statement of the important data pertaining to the class and a list of the individual engine numbers. Each number is followed by arbitrary letters indicating the special equipment, such as superheaters, pneumatic fire doors, etc., on the engine. (See Fig. 4.)

The parts of the book are usually assembled in the order given, but on account of its flexible character, the holder may rearrange the different portions in the most convenient manner for his own particular use. While the book was in preparation superheaters were being applied to a number of classes of the larger power. As it was the intention to eventually equip all of the engines of such classes it was not deemed advisable to change the sub-classification letter. In such cases the individual

Builder's Order No. S-781. **Class K-3 B**

No. of Locom. 10

Built by American Loco. Co., Schenectady, 1911.

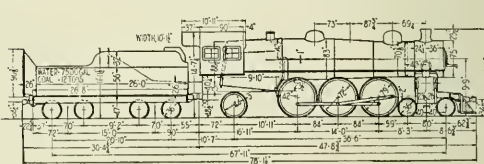

Kind of main valve.....	Piston 14 in.	Heating surface total.....	3791.3 sq. ft.
Valve travel.....	7 in.	*Heating surface superheater.....	1026 sq. ft.
Kind of valve gear.....	Walschert	Heating surface grand total.....	4817.3 sq. ft.
Firebox length inside.....	108 1-8 in.	Weight on drivers working order.....	173,000 lbs.
Firebox width inside.....	75 1-4 in.	Weight on front truck.....	50,000 lbs.
Grate area.....	66 4 sq. ft.	Weight on back truck.....	48,000 lbs.
Tubes, large.....	28 5 3-8 in.	Weight total of engine.....	271,000 lbs.
Tubes, small.....	24 3 in.	Weight of tender loaded.....	155,300 lbs.
Tubes length over sheets.....	21 ft. 8 in.	Weight of tender empty.....	89,000 lbs.
Heating surface tubes.....	3550 sq. ft.	Steam pressure.....	200 lbs.
Heating surface tubes, including arch fires.....	211.3 sq. ft.	Rating.....	31.7 per cent

Engine No.	Special Equip.	Engine No.	Special Equip.	Engine No.	Special Equip.	Engine No.	Special Equip.
4895	HASF						
4896	HASF						
4897	HASF						
4898	HASF						
4899	HASF						
4900	HASF						
4901	HASF						
4902	HASF						
4903	HASF						
4904	HASF						

H—Steamheat K—Stoker *Superheater surface as given in 1 1/2 times actual surface of superheater elements.
 A—Air Signal F—Franklin Door
 S—Superheater E—Fire Extinguisher

Class K-3 B

Fig. 4—Individual Classification Sheet.

sub-classification sheet was made out to carry the data for the engines when using saturated steam, and appendix sheets added at the back of the book to show the number of tubes, heating surface, weights, etc., after the application of superheaters, reference being made to the proper appendix sheets on the bottom of the individual classification sheet. (See Fig. 5.)

Loose leaf holders 4 1/4 in. x 6 3/4 in. in size are used, it being a simple matter to remove or replace sheets by removing the binding screws. Minor corrections are made to the sheets without removing them from the covers.

Lists of corrections are sent out to all holders of books at frequent intervals from the office of the superintendent of motive power, new sheets being printed and sent out with the lists of

F_3 = Area of the crescent ACBD.

x_3 = Distance of the center of gravity of the crescent ACBD from O_1 .

t = Thickness of the counterbalance weight in inches.

q = Weight per cubic inch of the material in the counterbalance weight.

W = Weight to be counterbalanced at the crank pin radius a .

Using the formula for center of gravity of a segment from Church's Mechanics, page 23, the values for x_1 and x_2 are

$$x_1 = \frac{(AB)^3}{12F_1} \text{ and } x_2 = \frac{(AB)^3}{12F_2} - N$$

$$F_3 \cdot x_3 = F_1 \cdot x_1 - F_2 \cdot x_2$$

Substituting the values for x_1 and x_2 in the last equation,

$$F_3 \cdot x_3 = F_1 \left[\frac{(AB)^3}{12F_1} \right] - F_2 \left[\frac{(AB)^3}{12F_2} - N \right]$$

$$F_3 \cdot x_3 = NF_2$$

For equilibrium of forces in this case

$$F_3 \cdot tq \cdot x_3 = Wa \text{ or } F_3 \cdot x_3 = \frac{Wa}{tq}$$

Combining the two equations and solving for t we find

$$t = \frac{Wa}{qNF_2}$$

In using this formula, it will be found more convenient to assign values for M and R_2 , increasing the value of M if the thickness of counterbalance is found to be too large for clearance past the side rods, etc. The area F_2 of segment ABD may be determined by the aid of the planimeter or by using the following formula.

The area of the segment is equal to the area of the sector ADBO₂ minus the area of the triangle ABO₂.

$$\text{Area } F_2 = \left[\frac{\sin^3 \frac{A}{2}}{180} \cdot \frac{AB}{2R_2} \cdot \pi R_2^2 \right] - \left[\frac{AB}{2} (N + x) \right]$$

in which the value for x is found from the two right-angled triangles BEO₁ and BEO₂.

In triangle BEO₁, $x^2 + (BE)^2 = R_1^2$, and in triangle BEO₂

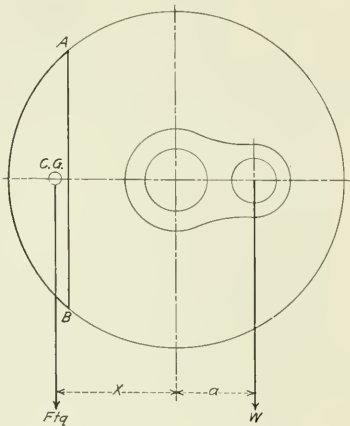

$(x + N)^2 + (BE)^2 = R_2^2$. Solving both equations for $(BE)^2$ and combining:

$$x = \frac{R_2^2 - R_1^2 - N^2}{2N}$$

SEGMENT COUNTERBALANCE.

Using the same notation, as above

$$x = \frac{(AB)^3}{12F}$$

For equilibrium of forces.

$$Ftqx = Wa$$

Solving for x

$$x = \frac{Wa}{Ftq}$$

Combining the two equations and solving for AB we find

$$AB = \sqrt[3]{\frac{12Wa}{tq}}$$

SECTOR BALANCE.

Let M = Number of spaces filled by counterbalance.
 N = Number of spokes in wheel.

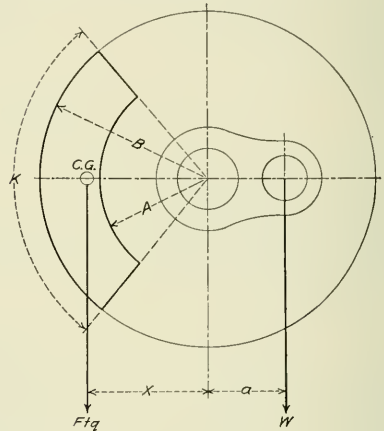

For equilibrium of forces in this case

$$Wa = Ftqx$$

Substituting in this equation the value of x for a sector of a flat ring from Church's Mechanics, page 22, we have:

$$Wa = Ftq \cdot \frac{4}{3} \cdot \frac{B^3 - A^3}{B^2 - A^2} \cdot \frac{\sin \frac{1}{2} K}{K}$$

The area F may be expressed as follows:

$$F = \frac{K}{360} (\pi B^2 - \pi A^2) = \frac{\pi M}{N} (B^2 - A^2)$$

Substituting this value we have:

$$Wa = \frac{\pi M}{N} (B^2 - A^2) tq \cdot \frac{4}{3} \cdot \frac{B^3 - A^3}{B^2 - A^2} \cdot \frac{\sin \frac{180}{N}}{2\pi M / N}$$

Reducing and solving for A

$$A = \sqrt[3]{B^3 - \frac{3Wa}{2tq \cdot \sin \frac{180}{N}}}$$

METAL PLATING BY DEPOSITION.—A new process of electro-deposition is claimed to have effected a very substantial advance that may have a more than ordinary effect on various branches of industry. In the manufacture of tin plate it is said to be possible to coat effectively 112 plates, 14 in. x 22 in., with 1 lb. of tin, as against 1¼ lbs. by hot dipping. It is also claimed that no wasters are made, there are no fumes injurious to health, and that boy labor may be employed. In galvanizing the cost of coating is said to be one-half that of hot dipping.—*The Practical Engineer.*

EFFICIENT POWER PLANT OPERATION

Large Losses Result from Machinery in Need of Repair and Pipe Lines Improperly Maintained

BY ERNEST CORDEAL.

Inefficiencies that will increase the unit cost to many times the ideal figure, may easily creep into the production of heat, light and power for the operation of a shop or factory. This applies more particularly perhaps to the power plants in connection with railroad shops and engine houses than to factories.

As an example, the power plant at a small railroad terminal, through years of service and as many years of neglect, had reached a point of inefficiency where the average cost per month of furnishing heat, light and power was \$908. At last a point was reached where no increase in cost of operation served to produce from the plant the amount of power actually required, and an investigation was made to determine what action was necessary. Under competent council the various power units were overhauled at small expense; pipe lines were gone over and the leaks stopped, steam lines were protected from the condensing effect of cold weather, an adequate system of checking fuel consumption was installed and the firemen and engineers were instructed in the proper methods of firing. The total cost of all repairs and improvements was less than \$250. The cost of operation decreased during the next six months period to an average of \$420 per month.

The peculiar conditions of railroad shop work render close supervision of power production essential to reasonable cost of operation. The shop power plant must furnish steam for heating buildings and for draft in firing up; air for operating motors, hoists and jacks and for testing air equipment; electricity for lighting and for operating electric tools and motors, often in addition to its regular function of furnishing power for the operation of engine driven shafting. The load to be carried is, under the best conditions, variable through a very wide range and the plant designed or re-inforced to meet the maximum requirements must operate at a comparatively low efficiency during a greater part of the time in order to provide for emergencies. Perhaps the knowledge that a certain amount of inefficiency in power plants is inevitable is responsible for the fact that in very few cases is any attention given to the cost per unit, or any effort made to effect economy in this department. That economies, which are very large when the importance of the power item in relation to the total cost of operation is considered, may be effected by careful study and systematic supervision, has been often proved by the results following serious efforts along this line.

Probably the principal difficulty encountered in any endeavor to investigate power plant efficiency will be the entire absence, in nearly all cases, of any means of determining the amount of power of the various classes which is being actually generated or consumed. Companies which generate gas, electricity or steam for sale to individual concerns, find it expedient to install meters, even when the consumption through certain of these gages does not amount to a value of one dollar a month. Such companies must know exactly how much it is costing them to produce the product which they sell, in order that equitable prices may be set which will allow them a profit on their investment, and enable them to compete with other companies producing the same or substitute commodities. It may be argued that a concern which is generating power for its own use only need not go to the expense of installing meters, as the entire cost of operating the power plant must be carried in the overhead charges and that information as to amounts used and unit costs are superfluous. If the same plant purchased its power from an outside company the manager would object strongly to

paying for it at the rate of maximum consumption and would probably insist on some method being employed whereby he would only be charged with the amount of power which was actually used.

A little thought will be sufficient to show that the two cases are analogous. The product of the plant must pay for the power regardless of whether it is furnished by an outside concern at so much a unit, or is generated at the plant itself and its cost is carried as an item of expense of operation. It is, therefore, just as important that means should be provided for measuring the amounts used and figuring the cost in one case as in the other. Meters are not absolutely essential to efficient power generation, but their use is the only means of providing definite knowledge that the maximum economy in power unit cost has been effected, and what the unit cost is as compared with other plants, or with power purchased from independent companies.

Regardless, however, of whether or not meters are provided, there are a number of items contributing to inefficient power plant operation which may be controlled by careful supervision. These items are in a greater or less degree common to nearly all power stations, particularly those in connection with railroad shops. For convenience they may be classified under the five following heads: Inefficient power units; leaks in air and steam lines; waste of delivered power; waste of fuel at boilers, and waste of labor.

INEFFICIENT POWER UNITS.

The proper designing of power units to insure the maximum economy is not strictly a matter of operation, and it is not intended that this article should deal with that phase of the question. The problem of the engineer in charge of a power station is to so operate the equipment with which he is provided as to insure the maximum efficiency under existing conditions. An engine, compressor or dynamo may be of such a design as to permit of only 50 per cent. efficiency, as compared with the best obtainable article in that line, but if the engineer in charge succeeds in obtaining the 50 per cent. result from the machine, his effort has been 100 per cent. efficient. On the other hand, if the unit only operates at an efficiency of 25 per cent., the engineer's effort has only been of 50 per cent. quality. His efforts should therefore be directed toward obtaining from the equipment provided, the maximum possible economy. This can only be done by keeping all machinery in the best of repair.

The engine which pounds, runs hot or drags is consuming more steam than it should and the cost of the power it produces is consequently higher than it should be. Neglected small repair items, although they may not materially affect the cost of output, lead to heavy repair charges at a subsequent time, all of which expense must be figured in the final cost of the power delivered. It is not an uncommon sight to see a compressor working at unnecessarily high speed and with high steam consumption in an endeavor to keep up the air pressure against a handicap of leaking valves and packing, whereby only a fraction of the work it performs is transmitted into usable power. Such conditions as these are excusable, but none the less common, and their existence may be traced directly to the absence of any comprehensive check on the cost of power. The importance of the inefficiency of power units does not end simply in the increased cost of power, but its effect may be traced through the entire shop wherever its product is used. The compressor, which, through lack of attention, is unable to keep up the required air pressure at all times, contributes to the inefficiency of every air

tool in the shop, and the tool in turn retards the effectiveness of the effort put forth by the workmen in its operation.

Such a condition as this actually existing in a certain shop was responsible for a decrease of approximately one-half in the output of every man operating air tools. In the case of one particular man it was found that with the insufficient air pressure furnished he was only able to ream holes 1 in. to 1½ in. in diameter and of an aggregate depth of 180 in. in 10 hours. The compressor and pipe lines were completely overhauled, after which the same man with the same motor and the same reamers averaged 350 in. in a 10 hour day.

Considering labor costs only and taking the workman's rate as 30 cents an hour, we find that while, with inadequate air pressure, it cost \$5.83 to do 350 in. of reaming, the same work only cost \$3 when the pressure was maintained. This represents a clear saving of \$2.83 on the amount of work specified. Now, as there were approximately 20 men in this shop continually using air tools, it is safe to assume that the total loss for which the air compressor was responsible aggregated \$56.60 a day, an item well worth consideration.

From this example it will be seen how inefficiency in the power plant not only increases the cost of power but also materially increases the labor cost of the shop output and decreases the effectiveness of the shop tool equipment.

Finding an opportunity to take power units out of service long enough to make necessary repairs is, perhaps, the cause of the difficulty in many instances. Machines are often under load for 24 hours a day, every day in the week, and no auxiliary equipment is provided to relieve them for a period sufficient for their thorough overhauling. The case is rare, however, where, by carefully planning ahead, arrangements cannot be made to give the necessary time required for repairs. Even the shutting down of the entire plant for a short period, although the apparent loss may be great, may prove in the end a measure of economy.

LEAKS IN AIR AND STEAM LINES.

One of the most prolific sources of high power costs is found in the loss of generated power without the production of any useful work. The long lines of air and steam pipes which convey power or heat from the power station to the various departments often waste far more through leakage, condensation and friction, than they deliver for effective use. The arrangement of pipe lines to provide protection from the weather, accessibility for inspection and repairs, and minimum distance of transmission should be given careful consideration, and when the best possible arrangement has been effected, frequent inspection should be made to detect any leakage or stoppage in the pipes which may cause waste. The engine house and repair yard are probably the worst offenders in the matter of pipe lines, as it is necessary to have many lines for conveying water, steam and compressed air, which must be placed in positions where they are liable to become cracked and broken. These conditions require that, not only should a careful study be given to their proper placing and protection, but that rigid and frequent inspection should be made to insure the prompt repair of any defects.

As an aid to the thorough inspection of pipe lines a map of the entire plant should be carefully prepared showing the exact location of all lines, length of sections and position of joints and elbows. This should be carefully revised whenever new lines are laid or changes made. It should be framed to prevent destruction or defacement and should occupy a conspicuous position in the power plant so as to be easily available for reference at all times.

An inspection trip around almost any plant will demonstrate the necessity of careful attention to pipe lines. The innumerable small leaks that will be found may account for a loss of generated power running as high as 50 per cent. of the total, or, in other words, equaling the total power effectively used. During the

winter season, of course, the greater pipe line losses will be encountered, as at that time the loss through condensation becomes much greater, particularly in lines placed above the ground and not properly protected from the cold.

As an example of what fuel losses may be expected from exposed steam pipes the following actual case is cited: A 4 in. overhead pipe line 100 ft. long carrying steam at 100 lbs. pressure from the power plant to supply the steam hammers in the blacksmith shop, was entirely without protection. The heat radiated from this line in winter weather, when the temperature averaged 32 deg. F., amounted to a condensation of approximately 98 lbs. of water an hour. Using the ratio of 1 lb. of coal to 6 lbs. of water, the heat loss from this cause alone represented a little over 16 lbs. of coal an hour. Any good pipe covering would have reduced this loss by 90 per cent.

Sixteen pounds of coal does not represent a very large investment, but when it is considered that this loss is continuous and that proportional losses are sustained from each foot of uncovered pipe, also the cost of labor to handle the additional fuel, the cost of additional equipment and its upkeep and the effect of overload on the efficiency of the plant as a whole, it will be easily understood that this is an item which should not be overlooked.

In cold weather also the power plant carries the greatest load, as the heating of buildings is added to the power demands, and for that reason particular attention should be given to the protection of pipes from the effect of radiation. The leaks which develop are more easily detected in winter than in summer, but their correction is a far more difficult matter, and for these reasons a thorough overhauling of all pipe lines should take place before the beginning of cold weather. In any plant where a considerable length of pipe line is necessary it will be found a measure of economy to employ a regular pipe man on the staff of the power plant engineer, whose duty it should be to make a daily inspection of all lines, together with the connections and hose used by mechanics or others in applying power to their tools or machines, and to repair such small defects as would otherwise probably go unnoticed. Such a man taking proper interest in his work will be able to save many times the amount of his wages.

WASTE OF DELIVERED POWER.

By no means does all the loss of power lie between the power plant and the point of delivery. As insufficient power supply decreases the efficiency of otherwise effective tools, so do defective or unskillfully handled tools decrease the efficiency of the power furnished. A dull drill or an improperly ground reamer will waste more power than it actually uses in effective work; a motor or a machine in poor repair requires more power for the same amount of work than the same machine in good repair; shafting which runs when none of the machines which it drives are in operation, represents wasted power. Such wastes as these are not properly under the control of the power plant engineer but he may nevertheless obtain considerable economies by securing the co-operation of department foremen in reducing them to a minimum.

Poor tools are an expensive luxury, not so much from the point of power consumption, which in reality is a comparatively small item, as in their effect on the efficiency, both qualitative and quantitative, of the work performed, and the power plant man should encounter no difficulty in obtaining the aid of shop foremen and managers in correcting defects which are overloading his plant and holding back the output of the shop. The engineer may not be an expert on machine tools, in fact seldom will his knowledge of such matters permit him to offer comments or suggestions as to their proper design or operation, but he should be in a position to know whether or not such machines are wasteful in their consumption of power and his reports on this subject should be given the attention they deserve by the man responsible for results.

WASTE OF FUEL AT BOILER.

A surprisingly small proportion of the heat units contained in the fuel fed to stationary boilers ever develop any useful energy. A part of this loss is inevitable, but in the average plant much of it may be eliminated by careful supervision supported by a competent check of the fuel used in proportion to the steam generated. The design of the plant is an important feature in the fuel efficiency which may be obtained, but the plant equipped with modern equipment for securing the maximum fuel economy, or the antiquated equipment with none of these improvements, both lend themselves readily to the effect of wasteful management. Some means of measuring the amount of steam generated by the boilers of a plant is an incalculable aid in checking up the efficiency of fuel performance, but this is a convenience which is seldom provided. The absence of such a check, however, is no valid reason for not securing a high standard of performance in the item of fuel consumption.

The fuel performance of a locomotive is quite generally computed on the basis of the tons hauled one mile and there is no reason why the load to be carried by power plants at various periods, or by various stations, may not be estimated with sufficient accuracy to provide a basis on which their efficiency may be computed. In locomotive practice it has been demonstrated that all the modern appliances such as superheaters, compound cylinders, stokers and brick arches, applied in an endeavor to decrease fuel consumption, are of little value unless their use is accompanied by intelligent action on the part of the crew in charge. In stationary practice as well, ignorance or carelessness on the part of engineers and firemen may lead to greater fuel losses than can be accounted for by the absence of modern equipment. Records of the fuel consumption and the load carried should be accurately kept and comparisons should be made to determine the relative efficiency of fuel consumption as between various plants and various periods at the same plant.

Firemen should be carefully instructed in the best methods of firing and the supervision should be such as to provide against lapses from the prescribed practice. The most efficient method of firing is a question which cannot be determined by any fixed law covering all conditions. The fuel itself, the design of boiler, the draft conditions and many other things must govern the practice which will be followed at any particular plant, and the practice that will prove to be the best can only be determined by intelligent trial. The quality of fuel that will produce the greatest amount of steam at the minimum cost is also a matter which must be determined individually for each plant. A cheap grade of slack or pea coal fired on grates designed for run of mine, will generally prove far more expensive in the end than higher priced coal of good quality; conversely, high grade coal fired in boilers designed to burn slack will prove expensive and troublesome.

Another point which has a direct bearing on the efficiency of the fuel performance and which will yield gratifying results, if given the proper attention, is the controlling of the number of boilers in use at times when the load is below the maximum. When two boilers are fired to do the work which could easily be handled by one, the waste of fuel is large and it will be found a measure of great economy to keep such a check on the power requirements at different periods of the day as will enable the boilers in use to be worked as nearly as possible to their full capacity.

WASTE OF LABOR.

Wasted labor in the power plant is, as a rule, associated with the handling of fuel and the disposal of cinders. Improper firing, which causes more coal to be thrown into the fireboxes than would be required under proper methods, wastes labor both in handling the fuel and the refuse; the use of an improper quality of fuel has the same result. The greatest waste of labor at the average plant is due to poor arrangement of the facilities for conveying the fuel to a point within easy shoveling distance of the fire doors and in the lack of a convenient method of disposing

of the cinders. It is a matter of comparative simplicity to arrange coal bunkers which, without adding any difficulty to the unloading of cars, provide a means of feeding the coal by gravity to a point which enables the fireman to shovel directly into the firebox without taking a step. Every step which the fireman must take decreases the efficiency of his applied effort, and even though but one step is required from the coal supply to the fire door, the total wasted energy in a month or a year is surprising. It is not entirely a question of whether a rearrangement of the fuel bin will enable the firing force to be reduced, although this may often be done. The man who is overworked or who sees that he is doing unnecessary work is not an efficient performer and much of the poor firing observed in power plants may be attributed to the fact that inconvenient facilities have led the men employed to adopt practices which are wasteful both of fuel and labor. The cleaning of fires and handling of cinders is another item which a little study may enable the engineer in charge to so handle as to require the minimum expenditure of time and effort from his firemen and laborers.

The principal need in effecting power plant economies, as in securing like results in any other line, is the provision of records of performance which are accurate and immediate. The man who realizes that the results of his work are intangible does not put forth the effort that he would if his record were comparable with the record of other men or with his own past record. It is, therefore, a matter of the greatest importance that an accurate record should be kept of all the expenses incident to the generation of power and that such reports should be furnished as will show the comparative efficiency of performance from week to week, or from month to month.

No item should be so small as to go unnoticed by the head of a shop and the importance of the power plant in its effect on the cost of output, both directly in the cost of generating the power and indirectly in the effect of wasted or misapplied power, should not be overlooked by the executive in search of economy.

LOCATION OF STEAM GAGES IN SETTING SAFETY VALVES

BY C. T. ROMMEL.

On June 2, 1912, the Interstate Commerce Commission amended rule 35 of the rules governing the inspection of locomotive boilers so that it is now necessary when setting safety valves to use two steam gages, one of which must be in full view of the person engaged in setting the valves. At the same time rule 29 was also amended, requiring the siphon pipe and its connections leading to the boiler to be cleaned every time the steam gage is tested. Before this amendment, rule 29 was as follows:

"Every gage shall have a siphon of ample capacity to prevent steam entering the gage. The pipe connection shall enter the boiler direct, and shall be maintained steamtight between the boiler and the gage."

Rule 28 is as follows:

"Each boiler shall have at least one steam gage which will correctly indicate the working pressure. Care must be taken to locate the gage so that it will be kept reasonably cool, and can be conveniently read by the enginemen."

The amendments to rules 29 and 35 do not state where the second steam gage is to be located, neither do they call any particular attention to the siphon to be used with this gage, and the writer believes that to make rule 28 cover this point requires that it be broadly interpreted. The amendment to rule 35 specifically states that if there is a variation of more than three pounds in the readings of the two gages being used, they must be removed and tested before the safety valves are set. The question of the location of this second gage has been a live one with the railroads, as beyond doubt they wish to live up to the full extent of the rules, and it is hoped that this article may be of some help in determining a location for the gage.

In the illustrations, the column headed Test No. 1 shows the

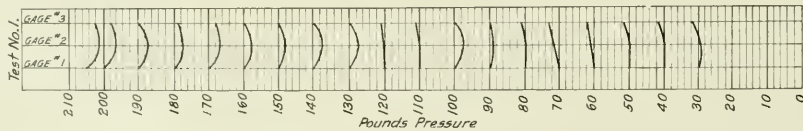
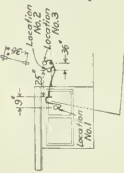
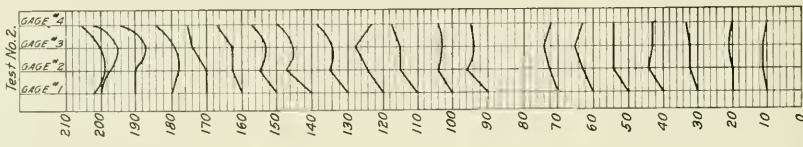
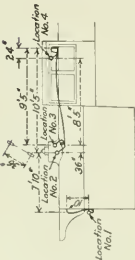
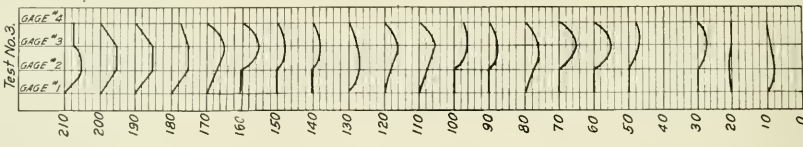
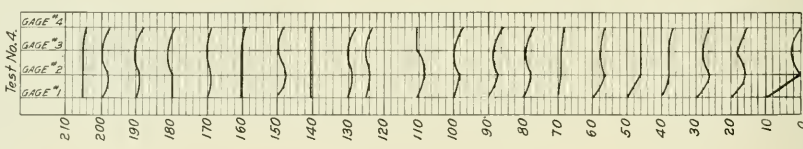
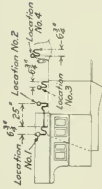
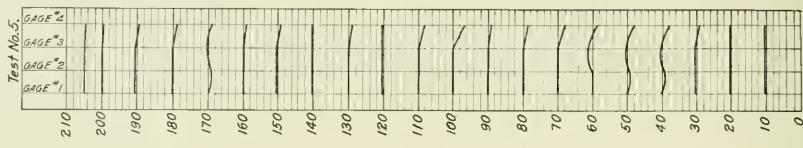
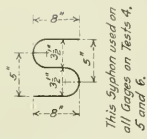
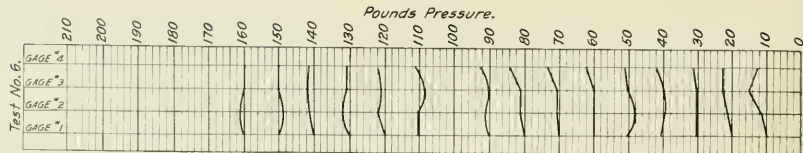

Tests of Steam Gages in Different Locations in Setting Safety Valves.

results obtained from tests made on a deck locomotive on which the safety valves are located in the roof of the boiler about midway between the dome and the cab. In the pipe leading to the master gage in the cab a tee was placed, and from this tee a pipe was led outside of the cab and two steam gages attached to it, one with a siphon and the other without; the master gage in the cab also had a siphon in accordance with rule 28. Location No. 1 represents the master gage, No. 2 the test gage without a siphon and No. 3 the test gage with a siphon. The readings obtained are shown graphically from 30 lbs. to 205 lbs., the latter being the authorized pressure for this class of locomotive. These results show that test gage

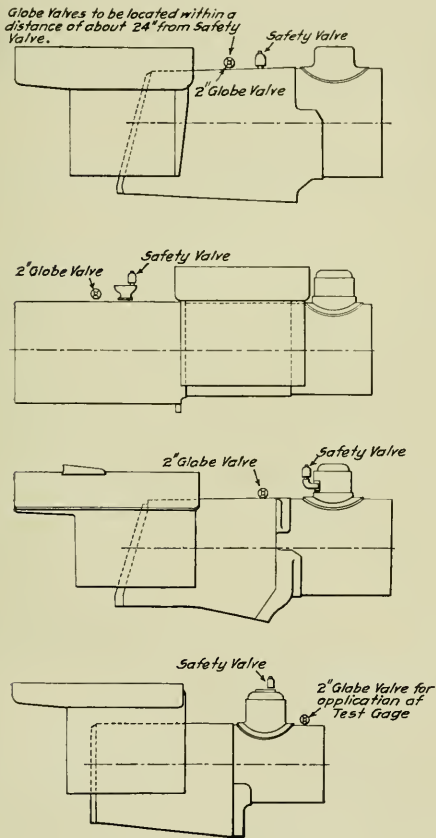

Points of Application of Test Gages on Different Types of Locomotives.

No. 3, with a siphon, checks closer to the master gage, No. 1, than does No. 2 which did not have a siphon. All three of the gages were tested with a dead weight tester before being applied and all were correct, although they varied during the time the test was being made on the locomotive.

In test No. 2 a Wooten type boiler was used on which the safety valves were located in the roof sheet back of the cab. On this type of boiler two steam gages are always used, as it is not possible for the fireman to see the master gage in the cab. As in the first test, a tee was placed in the pipe leading to the master gage and the two test gages were connected to a pipe leading from this tee, one with a siphon and one without. Location No. 1 shows the gage on the backhead for the use of

the fireman; the pipe for it was connected to a cock in the back end of the roof sheet and a siphon was used. Location No. 2 shows the test gage without a siphon, Location No. 3 the test gage with a siphon and Location No. 4 the master gage in the cab, the pipe for which was fitted with a siphon. The results obtained at the authorized pressure of 205 lbs. show that this arrangement would not conform with rule 35, except in the cases of gages 1 and 4. Between the master gage No. 4 and the fireman's gage No. 1 the variation was three pounds; between No. 4 and No. 2 there was six pounds variation (it should be noted that there was no siphon in the pipe leading to gage No. 2), and between No. 4 and No. 3 there was five pounds variation. As it would not be possible for the person engaged in setting the safety valves to see gage No. 1, either No. 2 or No. 3 would have to be used and the variation between these two and the master gage in the cab would be greater than the rules permit. If the fireman's gage No. 1 were considered as the master gage, the test gages 2 and 3 would conform to the ruling, as No. 2 varied three pounds from No. 1, and No. 3 varied two pounds. All the gages were tested before being ap-

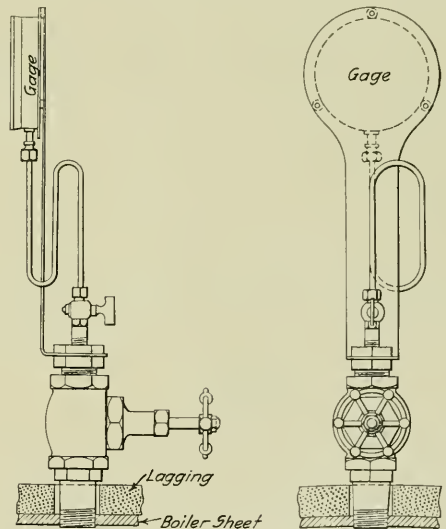

Arrangement of Test Gage for Setting Safety Valves.

plied to the locomotive and after the test was finished and nothing was found wrong, so that it can hardly be claimed that removing the gages and testing them, as called for by the amendment to rule 35, will overcome the variations found in the readings.

Test No. 3 was made on a locomotive on which the safety valves are attached to the dome; during this test four gages were used. Location No. 1 is the master gage in the cab with a siphon in the pipe; Location No. 2 is a gage connected to a pipe branching off from the pipe leading to the master gage and fitted with a siphon; Location No. 3 is a gage connected to an ordinary steam gage cock in the roof of the boiler and fitted with a siphon. Location No. 4 is a gage connected to a two-inch globe valve in the side of the dome, and fitted with a siphon. At a pressure of 210 lbs., gages 3 and 4 varied from the master gage three pounds and would conform to the ruling, while gage No. 2 varied four pounds and would not therefore conform.

During these three tests no attention was paid to the siphon used, either as to shape or dimensions, although the pipes leading to all of the gages were the same size. A careful analysis

of these three tests showed that the test gages with siphons and a pipe nearly the same length as that attached to the master gage, did not show as great a variation as those without the siphons. From this the conclusion was drawn that the siphon had a great effect on the results obtained and in test No. 4 all the siphons used were of exactly the same dimensions; the results obtained during this test seem to bear out the previously formed conclusion. At 205 lbs. pressure, the location of the different gages being the same as in test No. 3, all of the test gages read close enough to the master gage to conform to the ruling, gages 2 and 3 reading exactly the same, while No. 4 varied but one pound. Test No. 5 was made as a check on test No. 4 and at 205 lbs. the readings were the same as those obtained during test No. 4. From the diagrams it can be seen that the readings obtained during the entire range of pressures were more uniform than when no attention was paid to the siphons.

Test No. 6 was made on a deckless locomotive which necessarily requires two gages, and as in the case of tests 4 and 5, siphons of exactly the same dimensions were used on all of the gages and the same results were obtained. At the authorized pressure of 160 lbs., there was a variation of but one pound between the four gages.

From this it appears that it is possible to obtain a location for the second, or test gage, so that its readings will be near enough to those of the master gage to conform to the amendment to rule 35, provided the siphons used are of the same dimensions as those used on the master gage. From the results of these tests the road with which the writer is connected adopted the arrangement shown in one of the illustrations. This consists of a bracket on which the test gage is mounted and the pipe leading to this gage has a siphon which is applicable to the master gages on all classes of locomotives. The bracket is fastened to a nipple which is screwed into a two-inch globe valve in the roof of the boiler, the location of this valve on the different types of locomotives being shown in another of the illustrations; the distance from the safety valves is about the same in all cases. The globe valve not only provides a convenient connection for the test gage when setting the safety valves, but also a convenient means of blowing off the steam from the boiler.

With the use of this style of test gage and siphon no results can be obtained if the gage is applied and the valve and cock are not opened until almost the authorized pressure has been reached, as the in-rushing pressure is likely to injure the sensitive Bourbon tube in the gage. This fact was determined while these tests were being made. An attempt was made to change the location of the different gages at each ten-pound reading by closing the cocks in the pipe; after the change had been made the cocks were opened and the hand on the gage would jump violently around and then remain fixed, giving no results.

According to the rules, steam gages must be tested but once every three months, and during this time the spring in the safety valve will not take any permanent set if the adjusting screw is properly locked. If the safety valves are reported by an engine crew as not relieving the boiler at the authorized pressure, it is well to first test the steam gage and if it is found to be correct, apply the test gage when the pressure on the boiler is low, opening the cock to the gage gradually. At every three-month period the testing of the steam gage and setting of the safety valves should take place at the time of boiler washing, and the test gage should be applied when the boiler is cool and with all the cocks open; it is also well to fill the siphon with water and see that it is kept so at all times. During these tests it was found that the S form of siphon would generally give more uniform results than any other.

KINDLING LOCOMOTIVE FIRES

BY E. A. MURRAY,

Master Mechanic, Chesapeake & Ohio, Clifton Forge, Va.

The increasing cost of crude oil has led to much serious thought as to how best to make a reduction in the cost of firing up locomotives. Upon making a test by using shavings without being oil soaked, it was found that the oil could be omitted without any noticeable effect in the time required to generate steam, in fact any difference was in favor of the method of firing up without the oil. This is accounted for by the quickness in which the shavings will burn when oil soaked, whereas without oil it has been found that the flame will be of longer duration and will necessarily ignite the coal better; especially is this true when using slow burning coal. The consumption of fuel oil at this point averages 50 gals. each 24 hours. By eliminating the use of oil, a saving of \$56.25 per month or \$675 per annum has been accomplished.

FIRING-UP HOUSE FOR LOCOMOTIVE TERMINALS

BY PAUL R. DUFFEY

A house for firing up and finishing locomotives when they are taken out of the erecting shop is something which should be provided, unless a stall or two in a nearby roundhouse are set aside for this work.

In the erecting shop quick work is necessary to avoid delaying the movement of locomotives into and out of the shop. Frequently locomotives, when nearing completion—or sometimes as soon as mounted on the wheels—are pulled out of the shop and placed over a pit near by so that the piping, valve setting and other final work may be done; the firing up is also done on this pit so that the air brakes and boiler may be tested under steam. During inclement weather much time is lost from the men's inability to do their work well under such conditions.

The finishing or firing-up house should be of sufficient size to conveniently accommodate the output of the shop; for the average shop a building 75 ft. x 100 ft. x 25 ft. 9 in. high will give very good results and the pits should be spaced 24 ft. between center lines, the center line of the first being 13 ft. 6 in. from the wall. A smoke jack should extend across the three pits with a large outlet at the center through the roof of the building. This smoke jack should be about ten feet wide at the bottom to permit of moving the locomotive ahead or back a short distance without filling the house with smoke. A crane should be installed for lifting air pumps, dome casings, stacks, etc., and there should also be a few benches and vises in order to avoid the necessity of the men returning to the shop to do any work that may develop when the locomotive is under steam.

Large doors should be provided at both ends of the house so that there will be plenty of light and ventilation and also that material may be brought in or removed from either end. The upper half of the doors should be glazed and there should also be a sufficient number of windows in the side walls. The pits should be of concrete, capped with 12 in. x 12 in. wooden sills, special attention being given to the matters of depth and drainage.

BOILERS IN NEW ZEALAND.—In New Zealand all steam boilers, other than on government railway locomotives, must be certified to be safe for work by the inspector of machinery department every year. In its annual report to parliament the department states that during the past year 7,011 boilers were examined, and that in 1,239 cases defects were discovered, of which 33 were very dangerous. The new boilers registered during the year numbered 587, with a total of 6,649 horsepower.—*The Engineer*.

BOILER EXPLOSIONS.—Of the various types of steam boilers which contribute to the annual list of explosions in England, the small vertical is probably the most prolific.—*The Engineer*.

zero divisions on this scale which designate the minimum and maximum limits. The overall length of the rod is made to suit the requirements. When testing the tires all that is necessary

frame and also while squaring up the shoes and wedges. It is simple in construction consisting of a 4-in. cylinder having a stroke of 11 $\frac{3}{4}$ in. The top cylinder head is fastened to a hook

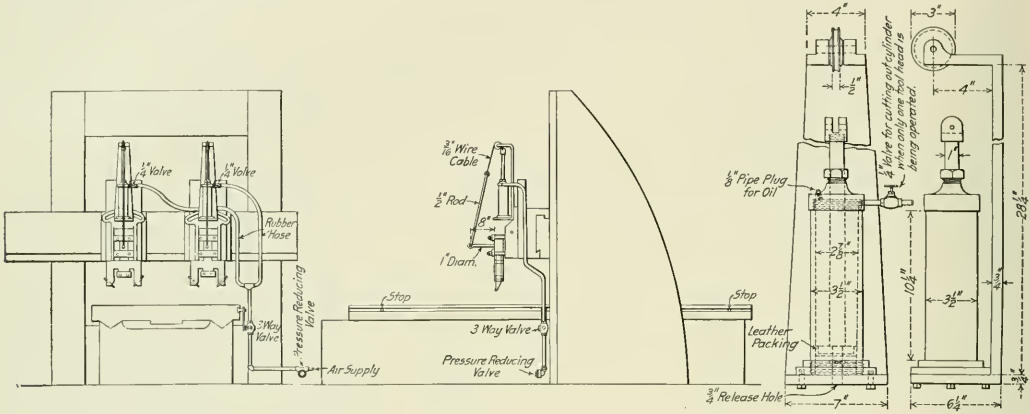

Fig. 3—Automatic Air Lift for Planer Tool Heads.

is to spring the gages over the flanges of the tires, the spring bringing the points of the gages hard against the throats of the flanges. By this means the tires are accurately set on the

made of 6 in. x 3/4 in. bar iron as shown. The lower hook has two prongs and has a swivel connection on the bottom of the rod. This little device has proved valuable in the erecting shop

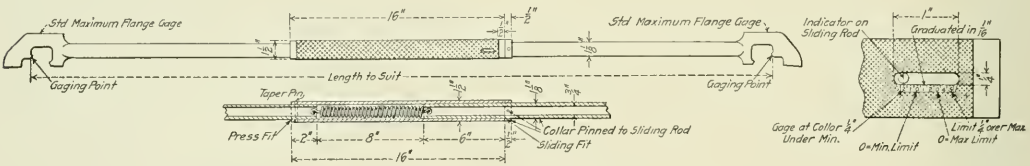

Fig. 4—Spring Gage for Setting Tires.

wheels, true with the throat of the flange, instead of from back to back of the tires. The gage on each end is the standard P. & W. maximum tire gage.

and materially reduces the labor in handling this class of work. It is light and may be easily lifted from one pedestal to another by one man.

PEDESTAL BINDER HOIST.

The air hoist shown in Fig. 5 has been found convenient in lifting the pedestal binder on heavy power when fitting it to the

UPSETTING BRAKE STAFFS.

The ram and dies shown in Fig. 6 are used to upset the ends of solid end brake staffs from a diameter of 1 1/4 in. to 1 1/2 in. The rams are made in two lengths, the shorter one being used

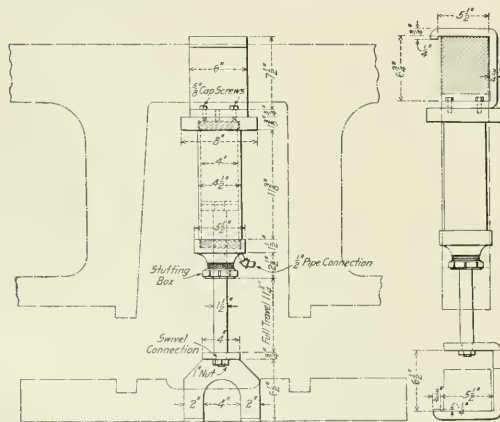

Fig. 5—Air Hoist for Fitting Pedestal Binders.

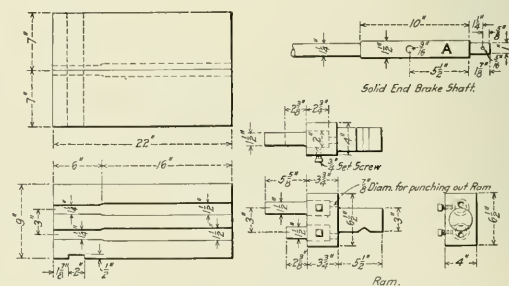

Fig. 6—Dies for Upsetting Brake Staffs.

to start the upsetting and the longer one to finish the operation. The female dies are made in two parts as shown. The end of the brake shaft ready for application is shown at A. The dies are fitted to a 4-in. Ajax forging machine.

MASTER PAINTERS' ASSOCIATION

Care of Steel Cars, Rust Inhibitive Paints, Safety First, and Brushes for Painting Steel

The forty-fourth annual convention of the Master Car and Locomotive Painters' Association was held in Ottawa, Canada, September 9 to 12, President A. J. Bush, master painter of the Delaware & Hudson, presiding. The opening prayer was offered by Rev. W. A. McIlroy of the Stewarton Presbyterian Church. J. A. Ellis, mayor of Ottawa, also a member of the provincial parliament of Ontario, and Dr. R. H. Parent, one of the four comptroller, welcomed the association to the city. C. A. Copp, master painter of the Boston and Main, responded to the addresses of welcome, stating that the last time this association met in Canada was 28 years ago when the convention was held at Toronto.

PRESIDENT'S ADDRESS.

President A. J. Bush in his address spoke of the successful work of the various committees, especially that of the information and test committee. Both these committees have given the association some very valuable information, and it is hoped that more of the members will make greater use of the information committee. He exhorted the members to participate freely in the discussion and to do everything in their power to make the work of the association a material success.

FINISHING STEEL PASSENGER CARS

Two papers were presented on this subject, one by John Gearhart (Penna.), and another by H. M. Butts (N. Y. C.). Mr. Gearhart described the baking process by means of a large oven which the Pennsylvania have placed in service at Altoona, Pa.* This oven is large enough to accommodate the largest car on that road, being 90 ft. 3 in. long, 13 ft. wide and 15 ft. high. This oven is heated by steam coils, having a total surface of 2,741 sq. ft.; the ratio of heating surface to cubical contents being one to six. This oven has been heated to as high as 305 deg. It is believed that the temperature can be raised to the desired degree in from 2½ or 2 hours without affecting the durability of the paint. With this oven it is possible to paint two cars complete in 6½ days, the saving in time on new cars being between 7 and 10 days over that of the air-drying system. The advantages of the baking process are that the cars may be finished on schedule time, the temperature and weather conditions can be more carefully regulated and there is no interference by workmen of the other trades while the paint is drying. Two 54-ft. passenger cars, four 78-ft. dining cars, six 70-ft. baggage and mail cars, four passenger locomotive tenders, and 20 steel hopper cars have been baked in the oven at Altoona, and 1,000 steel freight cars are to be baked at the oven at South Amboy, N. J., next month. Experiments are being made with non- and semi-drying oils on freight cars. Japans or other artificial driers are not used in this baking process.

H. M. Butts (N. Y. C.); With the advent of the steel passenger car it was thought that many radical changes in our present methods of painting wooden cars would become necessary in order to maintain as fine and as smooth a finish on steel cars. By some the fact has been completely lost sight of that we have been successfully painting steel on cars and locomotives for many years. To the master painter the painting of a steel passenger car seems easy in comparison to painting a locomotive tender which is fraught with many and greater difficulties. Nevertheless much valuable time and money is being expended to produce a more durable and less expensive method than the old reliable ones in use for generations. However, it yet seems

to be an open question whether very much real progress has been made along these lines.

The process of baking the paint and varnish mixture is not new, but has long been in common use. However, as applied to passenger cars it is comparatively new, and largely in the experimental stage. The various formulas are very imperfect and cannot be relied on as giving the proper proportion of material which can be safely used in mixing the various colors for the baking process. J. W. Lawler, chief chemist of the Pullman Company, says that results and experience based on practical tests show that the life of a baked paint on steel is greatly prolonged, its adherent qualities are increased and it has the additional value of being much more impervious to moisture and gas than the same vehicle unbaked.

Allowing this statement to be correct, has it been fully determined whether its life has been really and wonderfully improved? It is a commonly accepted fact that slow drying and more elastic vehicles will resist moisture and severe atmospheric changes for a much longer time than a quick, hard drying one, also that very soon after a vehicle loses its elasticity, decomposition sets in and complete disintegration is very near at hand. Immediately after baking, a vehicle becomes hard and brittle, which justifies the assumption, does not baking hasten its destruction? A sufficient exposure or service test can only satisfactorily answer this question. Baking the interior separate from the outside is being tried with considerable success by the Hudson & Manhattan of New York City. Electric heaters are suspended from the ceiling, the windows and doors being closed tight, thus enabling a proper amount of heat to be generated to accomplish the baking. This test seems to have determined the fact that the best results are obtained with thin mixtures of paint composed of very elastic vehicles with a small amount of pigment. It has also been proven by actual test that pigments when baked become hard and brittle, therefore the less amount of pigment added to the vehicle the greater will be its life and durability, likewise the lower the temperature and the longer time the paint is baked the better it will wear. Twelve hours at 180 degs. F. is better than 5 hours at 280 degs. The preparation of the metal before the paint is applied has also been given attention. The evidence produced is largely in favor of the sand blast over the pickling process.

The prevention of corrosion of the metal seems to be the most difficult problem which confronts us. Numerous mixtures claiming to prevent corrosion are on the market. There is no reliable evidence at hand which proves that any of them can be safely used for painting passenger cars. Most of the so-called rust preventatives are only suitable for use on structural steel, such as is used on bridges and buildings. A somewhat radical departure by a well known paint and varnish company from the old established rule that a primer suitable for use on wood must be made considerably more elastic than if it were to be used on metal has come to my notice. They recommend the same primer with their surfacing system for both wood and metal. There seems to be abundant evidence that a primer of this character can, and is being safely used. The New York Central is using the same priming coat for both wood and metal. We have in service about 200 steel passenger cars which were painted about 7 years ago with one of the surfacing systems, well known to us all, which are making a very excellent showing. The surface of these cars was first thoroughly sand blasted, then primed and surfaced in the old fashioned way.

Painting the interior of steel cars involves much the same problem as the exterior as far as the priming and surfacing is

*A description of this oven and the method of painting used in connection with it appeared in the *American Engineer* of May, 1913, page 245.

concerned. The only departure from old tried and true methods is the baking on of the priming, which is being done by the Pullman Company before the work is assembled. The surfacing and finishing is being done in the usual way. For information as to the value of the various pigments used in mixing paint, and their adaptability for painting steel, we are dependent very largely upon chemical analysis.

DISCUSSION.

H. M. Butts (N. Y. C.): If a paint can be dried artificially without the use of a liquid drier its life and durability will be increased and this feature alone would make the baking process worth while.

John Gearhart (Penna.): The surfacers used have been prepared in our own laboratories. We have been experimenting with six or eight different varnishes. Some we find will bake better than others; some became flat after rubbing, while others looked the same as if they were air-dried. The cars baked last February are in much better condition at the present time than those that were air-dried. Baked dining cars running in the tunnels at Washington, D. C., appear to be in the same condition after the eighth cleaning as the air-dried cars after their fifth cleaning. The air-dried finish on the car does not behave like those on the test panels, the test panels being much shorter lived than the cars. The baking process is practical and looks economical, but it will be a year or so before definite information can be obtained.

We have used varnishes that caused the job, when finished, to be rather tacky, perhaps a little more so than it should be in order to rub successfully. Another trouble was that finger marks would show. But those varnishes, after being out now about five months, are just about the same as the others. I believe that the fish oil made the best job of any; we used that on freight cars, giving them two coats. The first coat looked nice and glossy, and the second coat flattened. The paint was applied by the spray. We find no trouble at all in drying when using the fish oil even when no dryers are used.

You have got to know your material and just what it will stand. We have one varnish where we ran the heat up to 210 degs. F. and left it in the oven all night at 150 degs., and still it was not any dryer the next morning than it was the night before. In the inside of the cars it was a little harder to rub than the air-dried. The luster of the varnish on the cars that we have baked is much better than the air-dried. The reason for that, I think, is that it did not have the amount of cleaning to get the dirt off as it did on the air-dried.

We commenced baking in February, and we could then throw open the windows and cool a car in an hour or an hour and a quarter, but in the last month or six weeks, during the hot weather, we had to wait two hours and a half for a car to cool. It has to get pretty cool before you can apply the next coat successfully so that it will not lap. I am going to try this winter to run in a car and make it very hot, and then run it out into the cold, and see if it will not crack off the paint, as I believe we will be better able to get the old paint off in that way.

J. H. Pitard (M. & O.): Our traveling inspector told me the other day that a foreign steel freight car, passing through the yard, suddenly broke in two in the middle. He made an examination and found that the iron had been eaten away where it broke by the rust. While this is an exceptional case, I mention it to show what rust will do to a steel car if it is neglected. Possibly in a few years we will have more of that sort of cases if the steel freight car equipment is not given better attention.

C. F. Mayer (C., St. P., M. & O.): We received our first steel cars in 1910 and the paint on them has given very poor satisfaction. The average life will be about thirty-six months. I think the trouble with them is that they have been surfaced too heavy at the factory. The lighter the cars are surfaced the longer will be the life of the paint. Some of the cars have been repainted by the old process. Two of these have been in service

sixteen months without shopping, and they are giving good results.

Mr. Gearhart: Our cars are all steel, except the sash in the dining cars, and we have had no trouble with them when baking. The wood is well seasoned, but I suppose if you had wood that was not well seasoned you might have trouble.

Mr. Butts: Quoting from Mr. Lawler's article: "The baking produces an extremely hard and durable coat. Up to the present time, when it is necessary to refinish such a car, we have not found any chemical which will successfully remove the baked surface." It seems to me there would be difficulty there when the car comes in for repairs.

Mr. Gearhart: We have had no trouble in repainting. However, I believe it will not be safe to use as high as 250 degrees of heat, and it may be necessary to use a little dryer to get it to dry, but we will have to use a lower heat.

John D. Wright (B. & O.): raised the question as to whether it would not be feasible to raise the temperature of the paint shop each night to 150 deg. or more so as to force the drying along. This has been done at other shops and was found to be considerable trouble. On the D., L. & W., however, this method is in use and is giving good results.

Further discussion brought out the fact that a low temperature and a longer time would give better results in baking than a higher temperature and a short time. Many also believed that better results could be obtained by having as few coats of paint on steel equipment as possible.

TEST COMMITTEE'S REPORT.

Oscar P. Wilkins (N. & W.), chairman of the test committee, read the following report:

In order to determine the actual relative value of paint stock it is necessary to make service tests under normal conditions, but as it requires long periods of time to accomplish satisfactory results, we find in the test panels a good medium for making comparative tests. Accelerated tests under abnormally severe conditions are misleading unless the results obtained by the method selected will be in harmony with long time service tests. Therefore in making a panel test we should adhere closely to the line of actual practice in preparing the panel, and the exposure should be consistent with that of actual service.

The test panels of varnish exposed for 12 months beginning July, 1912, and which were referred to in the last year's report, were prepared in accordance with these views. We consider the test an accelerated one, but one that indicates the comparative value of the varnish samples involved. The samples were secured from various master painters who are members of this association, and were taken from the regular purchased stock. The wood panels, 14 in number, and 5 ft. long, were cut from the same piece. They were finished with the same priming, surfacing and coloring materials in exactly the same manner as a new wooden passenger coach. Three coats of varnish were applied to each panel, 48 hours being allowed between the coats for drying. All operations were performed by the same man, and as near the same time as possible. The panels were allowed to stand one week after the last coat of varnish had been applied, for hardening. They were then sawed into 1-ft. lengths and a panel of each sample sent to H. M. Butts, Albany, N. Y.; J. H. Pitard, Whistler, Ala.; T. J. Hutchinson, London, Ont.; A. P. Dane, Reading, Mass.,* and one set was retained at Roanoke, Va.

An examination of the test panels showed that the southern climate is the most severe on varnished surfaces; that there is a difference between all the samples tested; also a difference between the results obtained on the same varnish at different points.

One of the most noticeable features of the test is the gen-

*An unfortunate circumstance connected with the set of panels sent to Reading, Mass., prevented their exposure in time to be considered with the test, therefore they are not included.

erally superior condition of panels exposed in the North over those exposed in the South. The test furnishes a good opportunity to select varnishes that might be expected to render the best service in any of the zones represented. We secured these samples with the understanding that we would not publish names, etc., therefore we will not make a detailed record of the standing of each panel. The committee will be glad to furnish detailed information to any master painter who may be interested in the test.

H. A. Polhemus (Erie), a member of the committee, submitted the following on baking enamels:

To prepare a car body for enameling, remove all grease with gasoline and, if necessary, sandblast the surface to remove all the rust and scale. This must be done to insure a perfect and lasting job. Immediately after sandblasting give the surface a thorough dusting and apply a coat of priming enamel. Never let a sandblasted job remain over night without priming, as it will rust in a very short time. A steel passenger car when shopped for general repairs can be completed in less than half the time by the enameling process than by our present air-drying system, if there are proper facilities for doing the work. If the work is properly done, enameling will outwear the air-dried job by two years or more service, and the surface of the car is easier cleaned and the appearance is 100 per cent. better.

Mr. Polhemus exhibited several interesting panels of enamel work.

The test committee exhibited other specimens, among which was a film $\frac{5}{8}$ in. thick representing 365 coats of an oil retarded black carbon paint, each coat being applied daily during the period. When the film was finally lifted it was found that 38 per cent. of its weight had been lost, due to oxidation. Another film represented a retarded surfacing system which embodied 11 coats, applied in 12 days. Other films represented the practical oil retarding of the first class quick setting up paint oils found on the market. One was retarded with a high grade fish oil and another with the soya bean oil. It was recommended that these be given a good atmospheric test during the next year.

RUST INHIBITIVE PAINT

W. A. Breithaupt and A. M. Johnsen (Pullman Company): Sheet steel as it is usually received from the mills has a surface coating of mill scale. If this mill scale coating was uniform in thickness over the entire surface and if it would stand heat and bending without chipping off, it would be desirable to leave this coating on the steel. The fact is, however, that it does in no way fulfill these conditions satisfactorily.

The sandblast, according to our experience, is the best method for removing this scale and rust. The steel should be painted immediately after sandblasting, or if it is not convenient to do so it should be placed in a room warmer than the outside temperature in order to prevent the condensation of moisture on the steel.

Sandblasting the steel provides a sufficiently roughened surface for the paint to thoroughly adhere to. The paint coats must be of such material that the vehicle or combinations of oils and varnishes give the pigment a coating which will resist to the utmost capacity the passage of moisture and gases. The pigment must also be alkaline to a slight extent and electrolytically positive to the steel.

The Pullman Company have made a large number of tests on such protective coatings for steel, and now believe that the lesser the number of coats possible to give the desired protection, the better it will last. Where previously the 7 or 8 coat system was used we found that three coats of paint would give the desired capacity and ample protection to the steel. We then began the five-coat system, applied as follows: primer, body color, varnish color and two coats of varnish. The priming coat is made with an inhibited pigment as a fundamental requirement and a vehicle of good adhering quality. The prime factor of the second coat

lies in the vehicle which must be the very best moisture and gas resister than can possibly be obtained. The pigment was also a very good inhibitive. The steel plates are dipped in these two first coats and baked at 240 deg. F. for 12 hours. Cars so painted have been in service thirty months, without the slightest indication of destruction of the paint. The outside surface was entirely free from checks and cracks and as a general assertion would state that the paint was in excellent condition.

A. J. Bishop (Nor. Pac.): While the baked surface on steel is perhaps a better inhibitive coating than ordinary or even special painted surfaces, it has several objectionable features besides the one fact that it does not entirely prevent rust. J. W. Lawrie, Ph.D., in a paper before the World's Eighth Congress of Applied Chemistry, states "that while it is true that the problem of the preservation of steel is not new to us, the artistic preservation and protection of steel from corrosion is a new problem. A railway passenger coach must not only be painted carefully, but it must be painted so as to be and present a pleasing appearance to the eyes of the traveling public."

Paints for steel have different functions than those for wood; therefore in painting equipment constructed with wood and steel these functions should be carefully noted. We have not the absorption into the pores of steel only to a limited extent, and for this reason a different quality of paint is required to secure stronger clinging effects than that of the pores of wood. While it is undoubtedly true that sandblasting gives a slightly roughened surface which aids materially in holding the paint to steel, it is necessary to assist an oil paint with something that is better as an adherent to steel than linseed oil. The fewer the number of coats of paint on steel which will give the maximum protection, the longer the wearing and the better service will the paint coats give. The pigment and vehicle must be such as to exclude from the steel surfaces all moisture and gases.

It matters not what coating is to be applied, special attention should be given to the application of the priming coat, especially on metal.

DISCUSSION.

John Gearhart (Penna.): In Mr. Breithaupt's paper he states that they give four or five coats of material. I realize very well that the Pullman Company's steel is a very thin and smooth steel. If we had that kind of steel we would not have to put any surfacer on at all outside of our priming; and in fact we do not do that on the inside of our cars at the Altoona shops, as the steel on the inside of the cars is much smoother than on the outside, and we only give it a coat of primer and go on with our ground coats. Outside of the car the surface is much rougher, and we have to give it a certain number of coats to make its appearance come up to the standard that we try to maintain.

ECONOMY IN LOCOMOTIVE PAINTING.

D. A. Little (Penna.): When ultimate economy is considered the present practice of cheapening the cost of locomotive painting is undesirable. With very few exceptions the present practice of painting locomotives is not economical in any degree. Time was when locomotives were painted with the intention of securing a reasonable degree of durability and appearance commensurate with the amount of time, labor, and material expended thereon. I am not referring to the old-time method in vogue during the sixties and early seventies, when locomotives were given a carriage body surface and elaborately scrolled and artistically landscaped.

About eighteen years ago, a motive power officer on a certain railroad declared it useless to paint engines as they were then painted, which, by the way, was the most economical and common sense way an engine has been painted since the existence of railroads. He advocated painting them like bridges, using one or two coats of oil paint. His suggestion was, of course, commented on both favorably and unfavorably, and those who looked upon it favorably began to act and immediately a wave of

reform swept the railroad paint shops of the country. The cost of engine painting, then reasonable, has been gradually growing less and the average foreman painter demurred not. If he did, it was so meek and humble that it had no effect, and he drifted into the same rut, contenting himself with the false conclusion that if his superiors wanted it done that way, he had no right to object. But was he right in his deductions? The best reply I can make to this inquiry is contained in an article published in the May number of the *Painter's Magazine*, under the heading of "English vs. American Methods of Locomotive Painting." I will read it now, as it is interesting, and I will incorporate it as part of this paper.

"H. W. Jacobs, formerly assistant superintendent of motive power of the Atchison, Topeka & Santa Fe, makes conspicuous comment on the beautiful appearance of the British locomotive in an article on "Impressions of British Railway Practice," recently published in the *Railway Age Gazette*. He avers that fourteen coats of filler, paint and varnish are applied to the jacket, cab, tender and wheel-cover. This painting, Mr. Jacobs was informed, lasts from five to seven years, the locomotives not being repainted at every shopping. Immediately upon reading Mr. Jacobs' deductions the question arises, which method in the long run is the more economical? Painting every seven years and then painting very thoroughly, in comparison with the practice of repainting at every shopping of the locomotive, offers an opportunity for our master locomotive painters to do some problems in economy. It is evident, however, at the outset, apart from the question of economy, that British railway people believe there are important advertising possibilities in the locomotive flaunting a superior finish.

Reasonable specifications for painting the locomotive should provide for the outside of the cab one coat of primer, three coats of surfacer, one coat of color, one coat of varnish color, and two coats of engine finishing varnish. For the cab interior, one coat of primer, one coat of filling pigment, two coats of cab enamel, and for a strictly first-class job, one coat of engine finishing varnish. Engine and tender, which includes sand-box, dome, bell-stand, cylinders, driving-wheels, tank, tank frame, etc., one coat primer, one coat surfacer, one coat flat color, one coat varnish color and two coats engine finishing varnish. The jacket should receive two coats engine jacket enamel. Front end and smokestack to have at least one good coat of black finish. While this finish furnishes only a trifle more than half what Mr. Jacobs assures us the British locomotive gets in the matter of coatings, it at least provides a fair foundation for repainting as the machine is shopped from time to time."

I would not advocate such an elaborate system as that of the English railways, but I would advocate a system such as was generally used about twenty years ago, which was good enough for all intents and purposes—reasonably cheap in cost and as durable as could be desired. At the present time our business is simply to get it done before the machinists are through, even if done piecemeal, and that is the usual way. To do this, we must use quicker drying paint and varnish than should be used in durable painting.

J. W. Gibbons (A. T. & S. F.): There are some roads that only consider the first cost when painting their equipment and endeavor to get along with cheap material. This is false economy. The Santa Fe uses a good durable material for their locomotives which is applied in a thorough workmanlike manner, believing, by so doing, that the saving in maintenance will more than pay the difference between the cost of the second rate paint and the first class paint. The formula for the paint should be based on the kind of material on which it is to be used, on the service it is to be used in, and on the treatment it is to receive after it is in service. The paint on a locomotive is subjected to most severe treatment but has given excellent results and it is surprising to hear of the difficulties experienced with the steel cars.

The steel underframe of tenders very seldom receives the protection it should. The overflow of the water and the wetting down of the coal seeping down through the coal becomes of an acetic nature, and when it reaches the underframe will lodge there and greatly augment the corrosion. One coat of paint applied when the tender is built and not maintained is not enough.

W. E. Woods (N. Y. C.): The use of cheap materials for painting locomotives has not proved economical, both from appearances and durability. The New York Central Lines are to rewrite the schedule for painting locomotives to conform to the Master Painters' Association standards.

PAINT BRUSHES FOR STEEL EQUIPMENT

E. F. Bigelow (N. Y. C.): The surface of steel cars is unusually flat apart from the riveting, and I see no reason why the same brushes will not apply to steel cars as to wooden cars. We are using a 5 in. brush now for covering cars and a large 8-0 oval paint brush for surfacing, which is about as large as a man cares to handle. We find that the oval brushes carry paint better and put on a more uniform coat than flat brushes do, considering the amount of work. I would not recommend flat brushes for use over a surface that has been riveted. But for cover brushes we use wide 5-in. civit hair brushes, a varnish brush, as it is equivalent to an 8-0 thumb, a little larger than a thumb brush, the hair being a little longer. And our varnishers, as a rule, use this large oval brush to apply the varnish, using the thumb brush to level the paint afterwards.

H. M. Butts (N. Y. C.): We have recently revised our brush schedule, cutting down the number of brushes carried and selecting those which we have tried out and found to be well adapted for all kinds of work. We did not have in mind when we were doing that that we needed anything particularly different to paint a steel car that we needed for a wooden car. Many of us have had years of experience in painting steel tanks, and I would like to have anybody tell me the difference between a surface of steel on a locomotive tank and on a steel car. Any man who can paint a steel tank need have no fear about painting a steel car, and in fact they are much easier to paint than a tank.

J. A. P. Glass (Y. & M. V.): We use the same brushes on the steel as on the wooden cars. We use the largest one we can get on the steel cars because it is all piecework. In these days of rush work, it is a case of having to get the paint on. And another thing, you cannot convince me that getting a good heavy coat of paint on a steel car or a box car is a detriment. We do not like to have paint thrown away, but I like to have a good honest coat on, and when you ask a man to put on a yard of paint for less than a cent you cannot expect him to brush it down the same as he would if he got better prices.

A. P. Dane (B. & M.): I claim that a man can put on a flat color with a 4-in. brush better and more evenly than he can with a 5 flat.

Mr. Butts: I have to differ about the use of the smaller brushes. A number of years ago we used a 2½-in. camel's-hair brush for flatting, putting our body colors on the coaches. We then went to 3½-in. brushes. I found the work was done better and quicker. Then we increased to 4, 4½ and 5-in., and every stage of that increase was an improvement. We used to pay \$2.50 for flatting an ordinary passenger car, and our men are now making more money at 90 cents and doing the work absolutely as well. We are treating our best equipment in that way and doing it with a 5-in. brush, and the work has to be first-class, as we would not accept any other.

T. J. Hutchinson (G. T.): When I first went to Ontario we used the 3-in. camel's-hair brush for color coats, but I found that the hair was not long enough and we soon had a lot of stubs accumulated. We now use a longer-haired brush called an ox-hair brush. The hair is fully one-third longer than the civit hair brush or the camel's-hair brush. If I were working piecework below the windows I can understand how I could

use a 5-in. civit hair brush, but above the windows you would have to use another brush. We work piecework, and so far have been able to get over the cars in a reasonably short time, so that the pieceworkers make a good premium with a 3 and 3½-in. ox-hair color brush. The hair is much longer and they are able to spread it quicker, because the pressure does not crowd the color out of the brush as it does with a shorter-haired brush, as it does not leak.

J. W. Gibbons (A. T. & S. F.): The proper brushes depend to a great extent on the kind of surfacing and paints that you are using. For instance, if you have a mineral with linseed and turpentine, the brush does not have to be very stiff to cary the color. If you have some strong, heavy surfaces, I think you require a half elastic brush, stiffer and stronger, and in the same line as a varnish brush, but not as good. The proposition also depends upon the men. We use today a 4-in. Gem brush for our primer, which is a heavy surfacer. The varnish brush is a 6-0 thumb, long hair. We have the bonus system on our road. 67½ per cent. efficiency is a day's work, and all over that they get a bonus for. We have men applying surfaces and varnishes that run from 125 to 180 per cent. efficiency. I believe that particularly in flat colors a large brush that will carry the material and flow it on evenly will cover the surface and do away with the laps.

Mr. Dane: On the tenders, cabs and top work we use a flat color and then we varnish afterwards. In applying that flat color, my men have selected a brush that I would call a No. 4-0 varnish brush, stiff, instead of the flat camel's-hair or anything of that sort. They work by the day. They seem to think they can apply that flat color better with that brush than they can with a flat brush. It is a question whether that brush applies flat color better than a flat brush or camel's-hair or soft hair.

E. E. Lewis (Penna.): Our men prefer the round 8-0 brush for applying engine finish with flat color. We use flat brushes for primers and surfacers. For varnish we use a 6-0 varnish brush, either black or white bristle. We get good results and the men seem to be satisfied. They work piecework and, of course, that has a tendency to enlarge the sizes of the brushes and tools. We have not increased the size of the brushes at all except flat brushes for priming. They seem to be very well satisfied; they get good results and good rates using the round brushes. Just a short time ago we had some sample flat brushes sent to us, but the men preferred the round brushes.

SAFETY FIRST

J. H. Pitard (M. & O.): The safety first movement which was recently launched by the railroad companies for the purpose of safeguarding the lives of their employees and the traveling public, is an act of benevolence that deserves the hearty cooperation of all departments of railroad operation to insure its success. The accidents in the paint department are perhaps too infrequent to be seriously considered and the principal question is the preventing of occupational diseases. Even these, however, are very few. They owe their origin to three principal sources: Hygienic shop conditions, unwholesome paint materials and the habits of the workmen.

There is nothing mysterious about shop hygiene; it simply means good sanitation, ventilating, and heating a shop in such a manner as will permit of the free escape of impure air and noxious gases and the admission of pure air. Failing to do this will lower the vitality of the workmen and correspondingly decrease their efficiency. Good ventilation is especially essential in a paint shop, due to the fine particles of lead dust, fumes from the paint materials and the necessarily heated condition of the shop.

With a few exceptions all paint materials are more or less unwholesome, the chief offender being white lead, which is liable to cause lead poisoning or "painter's colic." Wood alcohol, bi-sulphide of carbon, benzole, turpentine substitutes of various kinds and some other chemicals are unwholesome on account

of their rapid volatile properties, their fumes permeating the shop. Such materials should be labeled, calling attention to their inherent dangers. It is possible to eliminate these detrimental odors by only using freely mixed paints and by keeping all paint stock in air-tight containers. The stock rooms should be especially well ventilated.

All employees should be compelled to keep themselves clean and should have clean overalls every week. They should not be allowed to eat meals in the paint shop and the use of intoxicants and cigarettes at any time should be discouraged.

C. A. Cook (P. B. & W.): The solving of the problem of safeguarding ourselves and others, lies entirely within our own province, and can only be solved by the elimination of the element of carelessness so universally prominent and the development of our powers of observation. Safety appliances and rules avail themselves of no value if we allow ourselves to be careless, indifferent and disinterested in their use and observance. It has been said that 80 to 90 per cent. of injuries to railroad employees are due to their carelessness. The preservation of the health of the workman is of vital importance to the corporation that employs him and the deterioration of his vitality impairs commensurately his productiveness. The results of investigations and tests of the paint materials used in the paint shop should be carefully studied and considered when handling them in order to guard against any possibility of injury from them.

E. F. Bigelow (N. Y. C.): The absence of machinery in the paint shop does not permit a great deal to be done in the matter of safety devices, but nevertheless danger may be present and may also be overcome in a great degree. Probably the most accidents which occur in paint shops result from the use of the old style plank and horse staging, their imperfect construction and recklessness on the part of the workmen while using it. The practice of using a horse with legs of unequal lengths or having broken cleats is quite common, and with a warped or twisted plank form a very dangerous combination. A large number of accidents have occurred from this source, all of which were preventable had ordinary care been used.

Ladders used in shops having concrete floors should be equipped with movable basswood shoes, or some similar appliance, to prevent slipping. Lying face downward on car roofs to paint decks or clean deck glass is a common and very dangerous practice. In some shops this is now a dischargeable offense. Bad places in flooring, the occasional piece of wood with projecting nails lying on the floor, are fruitful of sprained backs and ankles and blood poisoning, all of which may be reduced to a minimum by prompt repairs and a clear shop.

As regarding occupational diseases in the railway paint shop, I must confess to utter ignorance, for in twenty-eight years' experience and association with several hundred men in different localities during that time, I have yet to find the man suffering from any disease resulting from his occupation as a railway car or locomotive painter. The commission of labor of the state of New York has recently issued orders requiring that a place outside the paint shop be provided in which the painters may eat their lunches. Food or drink is not permitted to be brought in the paint shop.

DISCUSSION.

The consensus of opinion seemed to be that a paint shop should be well ventilated, especially in rooms where volatile, injurious liquids were being used, so that any of the fumes being breathed by the workmen may not have a harmful effect. The greatest number of accidents in the paint shop appears to have been caused by injuries due to carelessness rather than occupational diseases, but it was suggested that the painters should be informed as to the injuries that might result from handling the various paint materials, and instructed as to how to protect themselves from injury. As regards the question of using the paint sprayer apparatus, it was pointed out that if the men were properly provided with a regular respirator, the same as

they use around lead works, no trouble would be experienced. It was acknowledged that to try and spray a lead or turpentine vehicle was more or less dangerous. G. Swing, of the Pullman Company, mentioned that every painter employed by that company is subjected to a physical examination and is then given clean overalls, jacket and nail brush by the Safety Department. He is allowed ten minutes before closing time to change his overalls, clean his hands and finger nails, brush his teeth and wash. Once a week each man is allowed half an hour in which he is compelled to take a bath. During that time he is under the jurisdiction of the Safety Department. The company furnishes all the overalls, etc., and they are sent to the laundry and washed each week. A doctor examines every man in the paint department once a month for lead poisoning, and advises if the work the man is doing is injuring him in any way. A separate dining room is maintained outside of the paint shop for the men to eat their lunches.

A resolution was submitted by C. A. Copp, of the Boston & Maine, to make a Safety First slogan of the association, and to watch at all times to render the shop a safe place for employment.

PAINT PROTECTION FOR STEEL EQUIPMENT

J. F. Lanfersick (Penna.): No matter how well this kind of equipment is painted there are some other things that should be given consideration by the officials. I refer to the loading of coal cars with hot billets, slag, cinders, ashes or any other hot substances, also the striking of the sides of the cars with hammers and wrenches to start the load to fall out. If these practices are allowed to continue, it is useless to bother much about the painting of this class of equipment, as they soon put the paint to the bad. The inside of the cars is not given the same attention in the way of painting as the outside. In most cases the interior does not receive any paint whatever. Before assembling the parts used in the construction of new steel equipment, all of them should be sandblasted on the exterior and given one coat of good linseed oil paint as quickly as possible after the sandblasting is completed. After the cars are constructed the outside and underneath parts should be given two additional coats of good linseed oil paint, leaving twenty-four hours between coats. After the last coat is dry the necessary stenciling should be done. This method will insure the paint rendering from four to six years' service without repainting.

When this class of equipment is sent to the shop for repainting, all rust and foreign matter should be removed with the steel scraper and wire brushes from the parts outside and underneath the cars. After the cars have been cleaned, the parts outside and underneath, if necessary, should receive two coats of good linseed oil paint, leaving twenty-four hours between coats. After the last coat is dry the necessary stenciling should be done. As to interiors of coal carrying cars, I do not think it would pay to paint them. When refrigerator cars have steel ends, those parts on the interior of the cars should have at least one coat of paint to protect them from dampness. All steel roofs and other parts of steel equipment should have the exposed steel parts painted with at least one coat of paint.

F. A. Weiss (C. of N. J.): Our steel freight equipment consists mostly of hopper coal cars and freight gondolas; the former cars are used in handling anthracite coal, which is particularly hard service. The first requisite is to remove the rust and place the surface of the steel in proper condition to receive its protective coating of paint; experience has taught us that the sandblast is not only the cheapest, but the most effective way to do this.

Our plant consists of a blasting shop, of two cars' capacity, 90 ft. long by 28 ft. high, flooded with light because the sides are practically all glass above a height of 5 ft. and amply ventilated. At a distance of 300 ft., and so arranged that the cars when cleaned may be run directly into it, is the paint shop, which is used more particularly in rainy weather, on clear days the work

of painting being usually done outdoors. I may say here that all our steel freight car painting is done by the paint spraying machine. Air is piped through the yard at a pressure of 95 lbs. per sq. in., with outlets at all points where the painting is done. The sand we use is sea sand. The men engaged in this work are provided by the company with proper protection to prevent them from inhaling the sand, and thereby possibly injuring their health.

The cars are painted immediately after the blasting is done, to protect them from moisture that may settle on them. After twenty-four hours the sides and ends of the bodies are given the second coat of paint, and on the third they are stenciled and released for service, the trucks receiving but one coat.

The paint we use and find to be durable is carbon black, reduced with raw linseed oil and one of the prepared extending oils, the proportions of which are determined by the quality of the extending oil.

Provided the question of time in getting the equipment through the shop was not so urgent as it is on most railroads, and also where cost is not considered such an essential element in the problem as it is generally regarded by the railroad management, the exterior surface of the car should be sandblasted and primed with red lead mixed with raw linseed oil, and finished with two coats of carbon black, carrying the maximum quantity of raw linseed oil to which is added a portion of extending oil. The last coat need be applied only to the sides and ends of the body. On new cars laps and joints should be given a heavy coat of red lead or carbon black before the car is assembled. Trucks which are repainted require but one coat, while new trucks should have two, carbon black being a suitable material for the purpose.

Oscar P. Wilkins (N. & W.): We have been, and expect to continue the practice of testing out every promising material offered for the protection of steel, but up to the present time we have not found anything that will equal pure red lead and linseed oil as a primer, with two finishing coats of carbon black. A steel car surface carefully cleaned with a wire brush, scrapers, benzene and waste, primed with a freshly mixed pure red lead and linseed oil, and finished with two coats of good high grade carbon black, carrying maximum quantity of linseed oil, will give maximum wear with no increase in cost. We have been building steel cars at the Roanoke shop for several years and find fully 99 per cent. of the steel is free from corrosion, which renders it unnecessary to use the sandblast. As for the scale, I believe red lead is an inhibitor of rust, and if there is any rust under the scale the red lead, if not completely arresting its action, certainly retards it. We see this in evidence every day on steel cars that have been in constant service for eight or ten years with nothing but the initial painting, and aside from the hammer blows for loosening up the contents at certain points are in excellent condition.

I realize in taking this position regarding the sandblast that the field is against me, but I can't see the necessity of using a sandblast on steel freight equipment. In order to secure the very best results from red lead priming it must be mixed on the job. In other words, prepare sufficient red lead paste today to be thinned down and used tomorrow. By making the lead and linseed oil up in paste form and allowing it to stand for about twelve hours it permits the particles of lead to become thoroughly saturated with oil, and when it is thinned down and spread on the surface of the car it does not draw from the new oil added, but merely assists in oxidizing the film. I never use lead priming after it has stood in the package for as much as 72 hours, on account of a certain action taking place within that time that should take place on the surface of the car.

ENAMELED INTERIOR TRIMMINGS

John D. Wright (B. & O.): It is a well known fact that nearly all of the interior metal trimmings, lamps, parcel racks, etc., applied in passenger cars in recent years have been made of

brass, and more thought seems to have been given to their design, and to the coloring of the metal, than to their cost. In other words, they have been considered more from an artistic than an economical standpoint.

The railroad companies are today confronted with conditions that force economy in many of the smaller details, some of which, perhaps, have been overlooked in the past; and while the metal used on the interior of passenger cars may appear to be a trivial matter, in the aggregate it amounts to thousands of dollars. During the past year this point has been taken up by certain companies and it now looks as if some of the interior brass work will, sooner or later, give way to cheaper metals, and the baking enamel proposition makes this possible. Where the baked enamel finish is used many of the parts which are now removed every time a car is shopped for repairs could be cleaned with the interior of the car, without being removed and replaced. This expense would then be saved, to say nothing of the additional cost connected with the polishing, sandblasting, dipping, coloring and lacquering of brass work.

Another argument in favor of the enameled metal is the improved appearance of a car interior when trimmings are used that are enameled in colors to match the part of the car on which they are placed; the lamps being the same color as the head lining and the parcel racks, locks, lifts and other trimmings to match the body of the car.

There is a possibility, however, of greatly injuring the appearance of these parts if the enamel chips, or wears off, particularly when dark enamels have been applied over brass, or other light metals. This trouble may be overcome, however, to a certain extent, by the use of iron and steel, which holds the enamel much better than brass.

MAINTENANCE OF PASSENGER CARS

T. J. Hutchinson (Grand Trunk): Maximum paint protection is a necessity in railway service and whenever these seven-day systems are introduced and hurried methods of cleaning continued at terminal points, we may look for future trouble that may be called paint failures.

When making out schedules of paint operation it must be remembered that the exterior protection lies chiefly in the varnish, and whenever the service exceeds the life of the varnish it will be at the expense of the whole paint structure, which means extra time and material.

On the steel or wood-sheathed car after the primary coat I believe it will prove economical to apply not less than three coats of surfacing material where the old surfacing systems are followed. I believe that the present-day hurried method of cleaning and caring for the interior of the car en route and at the terminal point is false economy.

RAILWAY PAINT SHOP SUPPLIES

H. Heffelfinger (Penna.): The best materials obtainable for painting and varnishing passenger cars and locomotives brings about the most economical results. The different localities through which the equipment is to run should determine to some extent the material to be purchased and in order to insure the correct material being secured the master painter should be consulted, he in turn being thoroughly familiar with the goods on the market. It is useless to expect good results when inferior paints and varnishes are used, and every master painter of this association should endeavor to make a reputation for doing good work and should do all that lies in his power to impress on his superior officers that he cannot attain the best efficiency in painting passenger equipment and locomotives without their aid in procuring the best and most lasting materials.

OTHER BUSINESS.

W. O. Quest (P. & L. E.) presented an interesting paper on the art of staining woods in which he described the methods

and stains used in producing the various beautiful samples he had on exhibition.

F. W. Brazier, superintendent rolling stock (N. Y. C.), in a letter to H. M. Butts, master painter of the New York Central at West Albany, N. Y., conveyed his regrets at not being able to attend the convention. He called attention to the importance of the steel car question as regards the best method of treating and preserving the steel. This problem is still in its infancy and the members by their discussions and exchange of ideas are in a position to greatly advance the art. He congratulated the convention on the interesting and pertinent subjects that were considered.

At the opening session T. J. Hutchinson, master painter of the Grand Trunk at London, Ont., presented the association with a beautiful banner painted by himself embodying the emblems of the United States and Canada. The following officers were elected for the ensuing year: President, Oscar P. Wilkins, Norfolk & Western; first vice-president, T. J. Hutchinson, Grand Trunk; second vice-president, H. Hengevelt, Atlantic Coast Line, and secretary-treasurer, for the tenth consecutive year, A. P. Dane, Boston & Maine, Reading, Mass. Nashville, Tenn., received the greatest number of votes for the next place of meeting.

ROUNDHOUSE POST RACK FOR TESTING SLIDE VALVE FEED VALVES

BY F. W. BENTLEY, JR.,

Machinist, Butler Shops, Chicago & North Western, Milwaukee, Wis.

In a great many instances where slide valve feed valves or reducing valves become defective at roundhouse points some distance from general or division shops, there is no provision made for a fair test of the valve after cleaning. The feed and

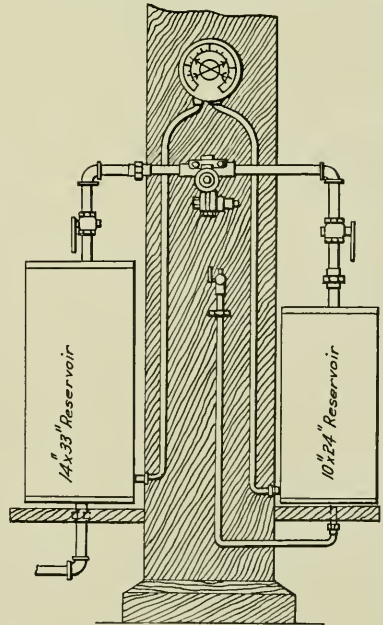

Rack for Testing Slide Valve Feed Valves in a Roundhouse.

reducing valves, playing the important part they do in the operation of the "E T" equipment, cannot be too closely examined after repairs of any nature, while on the other hand suitable pro-

visions for their testing can eliminate the unnecessary return of many of the doubtful valves to the shop when but trifling repairs are necessary to put them at once back into service. The illustration shows an inexpensive feed valve test rack for outside roundhouse points which necessitates no bench or table arrangement as the parts are built up around one of the large roof posts of the roundhouse. The two reservoirs are generally available from material taken from scrapped locomotives, as are also the gage, cut-outs and pipe fittings. With this device it is possible to make every necessary test of the valve's operation to be certain of a satisfactory condition before applying it to the locomotive.

INSTALLATION AND MAINTENANCE OF ELECTRIC HEADLIGHT EQUIPMENT*

BY V. T. KROPIDLOWSKI

III.

It is not possible in an article of this kind to go deeply into the theory of electricity and dynamo-electric machinery, nor is it intended to treat even remotely of electrical designing, but some elementary explanations and illustrations are considered necessary. Those that care to go deeper into the subject will find a number of good books in almost any library treating fully on every phase of the subject.

Figs. 1 and 2 represent an elementary dynamo-electric machine; it will be noted that if the armature revolves in the direction of the large arrow, and if the brushes are connected through an external circuit so as to provide a path for the current, there will be an electromotive force induced in the coil which will cause a current to flow in it in the direction indicated by the small arrow. The two segments of the commutator are represented by *a* and *b*. The commutator serves the purpose which its name implies; it commutes or changes the current, which is alternating in direction twice in every revolution, to a direct current as follows: When the side *A* of the coil in Fig. 1 is passing the *S* pole face the other side *B* is passing the *N* pole face, the brush +, is in contact with segment *a* and the brush -, with segment *b*; the current flows from the side *A* into segment *a* and out to the circuit, returning through brush -, and segment *b* to the side *B* of the coil. In the side *B* it flows toward the back of the armature, upward across the back and again through *A* to the circuit. When the armature has turned far enough so that the side *B* of the coil is passing the *S* pole, as in Fig. 2, segment *b* will have also turned far enough to make contact with brush +, and the current will again flow out to the circuit through the same brush, and so on, as long as the armature is revolving in that direction and none of the connections are changed. In the elementary armature but one coil is shown, but in an actual armature a great number of coils and several turns per coil are necessary in order to generate the required voltage. In the case of a headlight generator there usually are in the neighborhood of 240 inductors (wires that cut lines of force) depending, of course, on the speed and strength of the field. Selecting, for example, a drum armature like the one in the elementary machine, with 20 coils and six convolutions to each coil, there will be (in the drum armature both sides of the coil are on the surface of the armature core)

240 wires distributed over the surface of the core. If the armature makes 2,800 revolutions per minute, or 46 revolutions per second, each wire cuts the flux twice per second, making a total of 92 times. In a wire cutting lines of force at the rate of 100,000,000 per second an electromotive force of one volt is induced, and if we wish to generate 37 volts we must provide ampere turns enough to force through the magnetic circuit

$$\frac{37 \times 60 \times 100,000,000}{2 \times 2,800 \times 120} = 330,351$$

lines of force. The ampere turns, that is, the number of convolutions of wire around the iron forming the magnetic circuit, depend entirely on the kind of iron or steel, its quality and the way it is assembled to make up the magnetic circuit, the size of the air gap, etc. This is shown in Fig. 8, where the vertical figures represent the kilolines (number of lines of force divided by 1,000) per square inch of the iron, steel or air gap that will be produced by the ampere turns, as represented by the horizontal figures. The top horizontal figures are those for metal, and the bottom ones those for air.

Figs. 3, 5 and 6 represent the field coils and magnetic circuits, and Figs. 10, 11 and 12, diagrammatically, the field winding connections of the types of dynamos in present use for electric headlights. The dotted lines and the arrows represent the path and direction of the magnetic lines of force and the circles the sections of the wires composing the field coils. If Fig. 3 is studied carefully it will be seen that due to its construction it is not as efficient, from the magnetic and electric standpoint, as Figs. 5 and 6, and of these latter, Fig. 5 is the more efficient. It will be noted that some of the lines of force in Fig. 3 must force their way into the armature core through an additional air gap as well as the air gap between the armature and pole pieces and, as a consequence, more ampere turns are required, as may be seen by again referring to Fig. 8. There is also more leakage, or lines of force going astray and not cut by the armature wires, due to this air gap. The lines of force will also tend to crowd toward the neck of the pole pieces where the gap is the least, and if the designer has not allowed for this the iron will become over-saturated and in an over-saturated magnetic circuit the lines of force do not increase nearly in proportion to the ampere turns, or the current passing through the field winding. Furthermore, the armature inductors in that kind of a field will cut the lines of force diagonally and they are not then as effective in inducing an electromotive force as when they are cut directly at right angles. All this requires more wire in the field, and greater speed of the armature, in either case requiring more power, and as a result, more steam. Of course, this may be all offset in other good features of the completed machine, as for instance, in lower maintenance cost, etc.

It will be noted that in Figs. 3 and 6 the frames are in two pieces. Ewing tried the effect of joints in the iron of a magnetic circuit, and Fig. 9 gives the results of his investigation. Reading vertically, the figures represent lines of force, and horizontally, ampere turns required to produce the lines of force. It requires considerably more ampere turns to produce the same number of lines of force through a circuit containing a joint than it does in the case of a solid bar. An ordinary joint is equivalent to an air gap of about .002 in., and it will therefore be seen that Fig. 5 is the most efficient from a magnetic standpoint. The magnetic circuit of Fig. 3 is rather difficult to understand, but if Fig. 14 is referred to it is easier to grasp. The two arrows along the coil of wire represent the current, and the dotted circles the lines of force which the current produces.

There are mainly three types of field windings in general use, the shunt, the series and the compound wound dynamo. Only the latter two are used in headlight service. Figs. 10 and 11 are compound and Fig. 12 is series wound. Fig. 10 shows the way the Pyle generator is connected. One terminal of the shunt field and one terminal of the series field are connected at *d*, and

*It has come to the attention of the author of these articles that there are some readers who believe that if the plan of wiring described in the *Railway Age Gazette, Mechanical Edition*, July, 1913, page 367, is followed, the incandescent lamp in front of the reflector will burn continually. No such trouble need be feared. This can be shown by reference to the fundamental rule of derived circuits. The use of this rule shows that there is available an e. m. f. of approximately 0.02 volts and the resistances for the current to choose in order to reach the negative brush are 30 ohms in the lamp and about 0.02 ohms in the wire. One can thus readily see which path the current will choose. For those not familiar with this rule an actual test is advised. Theoretically there is a small current flowing through the lamp, but from the practical standpoint there is none. This loss of current exists in all commercial installations, but there is not sufficient current to light the lamp.

the terminal of the series coil is left longer and connected to the positive brush holder at No. 2. The other terminal of the series coil is brought out and connected to binding post No. 1, which

current's path is from the positive brush to connection No. 2, thence to the junction *d*, from where the main current circulates through the series field and comes to binding post No. 1; the

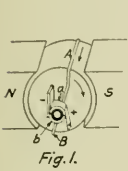

Fig. 1.

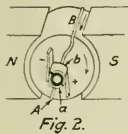

Fig. 2.

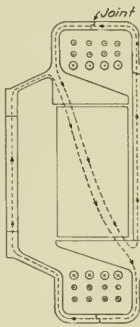
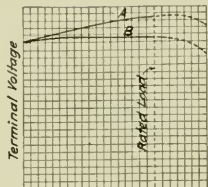

Fig. 3.



Load Current Curve of Compound Generator Fig. 4.

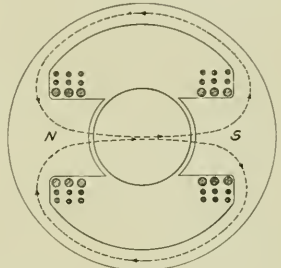

Fig. 5.

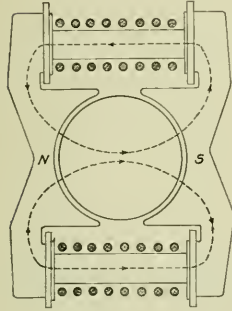
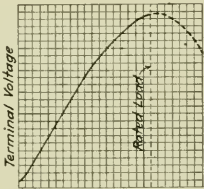

Fig. 6.



Load Current Curve of Series Generator Fig. 7.

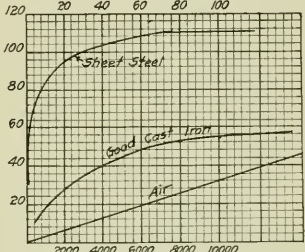

Fig. 8.

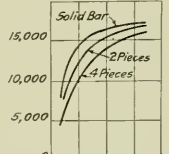

Fig. 9.

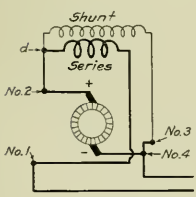

Fig. 10.

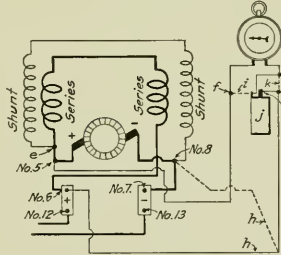

Fig. 11.

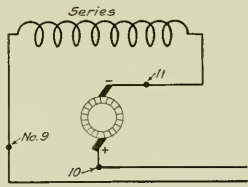

Fig. 12.

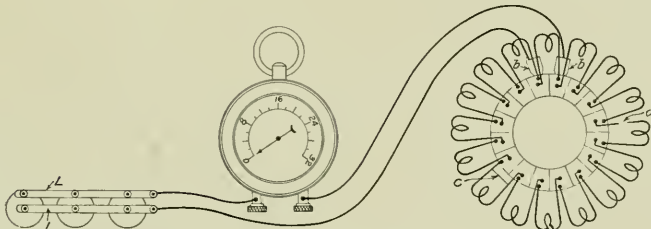

Fig. 13.



Fig. 14.

Diagrams Showing the Path of Electric Current Through Different Generators.

is on the negative brush holder, but insulated from it. The other terminal of the shunt coil is also brought out and connected, metallicly, to the negative brush holder at No. 3. The

binding post being insulated from the negative brush holder, the current enters the external circuit, performs its work and returns to the armature by way of binding post No. 4, and the

negative brush holder and brush to the negative side of the armature winding, as in the case of the elementary dynamo. The shunt winding admits but a very small portion of the main current but, nevertheless, supplies the main part of the excitation; this is due to the fact that it has very many turns of fine wire in proportion to the series field and as the field strength depends on the ampere turns, that is, the current times the number of convolutions in the field winding, it is evident that even though nearly all the current goes through the compound field (it having but just enough turns to compensate for the drop of voltage in the armature and external circuit wires due to the full load current) the result from multiplying the current by the number of turns does not nearly equal that of the shunt field. The reason that as much current does not flow through the shunt field as through the series field, when both have the same metallic connection, is that the former has greater resistance due to the use of very fine wire with greater number of turns. It also seems, in the case of a series machine, where very nearly full load current must be passed through the series field when but two or three incandescent lamps are burning, that there must exist a lot of waste of current; this is not the case, as the number of watts lost in the field depends on the square of the current times the resistance. The series field has a very low resistance and the shunt a high resistance; for example, if the shunt field has 25 ohms resistance and a current of 1.2 amperes flows through it the loss is $1.2 \times 1.2 \times 25 = 36$ watts, and if a series field has a resistance of .04 ohms and a current of 30 amperes passes through it the loss equals $30 \times 30 \times .04 = 36$ watts, the same as in the previous case.

Fig. 11 shows the way the Schroeder generator is connected. The first two terminals of the shunt and the series fields are connected to each other and to the positive brush, the same as in the Pyle machine, *c* being the common junction of the two fields and No. 5 the connection to the positive brush holder. The other terminals of the fields are brought out, the series connected to screw No. 6 and the shunt to the negative brush holder at No. 8. The current's path is from the positive brush to connection No. 5, to junction *c*, a small part of it going through the shunt field to the negative brush at connection No. 8, and the main current through the series field to connections No. 6 and No. 12, which are metallically connected; from there it passes through the external circuit, doing its work, and returning to the negative brush by way of connections No. 13 and No. 7 and brush holder connection No. 8.

Fig. 12 shows the connections of the American headlight generator, which is a series machine. This machine, instead of having a large number of turns of fine wire on its field pieces, has comparatively few turns of larger size wire, through which all the current passes. The path of the current in this machine is from the positive brush to connection No. 10, thence to the external circuit, doing its work and returning to the negative brush by way of binding post No. 9, the series field and positive brush holder connection No. 11 and through the negative brush into the negative side of the armature.

Fig. 4 represents the external characteristic curve of a compound generator, that is, it shows the voltage in relation to the current. The curve *A* is that of an over-compounded generator, and curve *B* of a flat-compounded machine, or one in which the voltage is maintained practically constant. It will be seen that in a compound generator the voltage is at its maximum whether the generator is supplying no current or full load current; after the capacity of the machine is reached it begins to fall quite rapidly, this being due to the iron composing the magnetic circuit becoming over-saturated with lines of force. Fig. 7 represents the voltage curve of a series generator, and it is seen that at no load there is very little voltage, only that which the residual magnetism is able to create. The reason for this is that when no current is delivered to the outside circuit there also passes no current through the field; but the voltage increases

rapidly with the load until the capacity of the machine is reached, when it again begins to drop, due to the reason given above. The expression "up to capacity" is, in this instance, not strictly true, as the capacity of the winding may be reached and yet the magnetic circuit might be so designed that its saturation point has not been reached, in which case the voltage will continue rising until ultimately it may destroy the insulation of the winding, due to overheating from excessive current. For this very reason the designer proportions the sectional area of the magnetic circuit so that when the capacity of the winding is reached, or even before it is reached, the iron becomes saturated, thereby offering greater resistance to the lines of force and consequently less lines of force circulate in proportion to the exciting current; as a result the voltage begins to fall rapidly.

A considerable number of headlight failures and delays to locomotives could be avoided if proper inspection was followed out in the roundhouse, and there is included here a description of a method of testing armatures and fields for defects. An ammeter reading to 30 amperes and three dry cells are required. The ammeter shown in Fig. 13 is a small instrument, but a higher grade instrument is more reliable. The cells should be connected in series with copper strips of about $1/32$ in. \times $3/4$ in., and the connecting wires should be as large in diameter and as short as conditions will permit, so as to have as little resistance as possible, as cells have very low voltage and if connected through even quite low resistance the current, and consequently the reading, will be low, making the easy determination of faults difficult. To illustrate, supposing the three cells to have a voltage of 2 volts each and a resistance of 0.10 ohms each, if we short circuit them on themselves we will get a current of

$$\frac{2 \times 3}{0.10 \times 3} = 20 \text{ amperes, but if we connect them through some-}$$

thing that has, for instance, 2.7 ohms resistance, we will get a current of only $\frac{2 \times 3}{0.10 \times 3 + 2.7} = 2$ amperes.

ARMATURE TROUBLE.

An armature should run without heating excessively; if it heats to any great extent and the machine does not carry an overload it may be due to several reasons. The armature may be damp, thus materially weakening the insulation, in which case it should be taken out and baked. This fault can be determined with a high reading volt meter, but this will not be taken up now as it belongs more to shop repairs, which will be treated later.

If a generator sparks badly or fails to generate at all, an open circuit invariably exists somewhere. To look for it in the armature, take out the brushes and apply the testing device as shown in Fig. 13. The two contacts *b* should be of ample size and of copper, each of a width to not quite cover one segment. They should be placed on two adjacent segments and arranged so as not to touch. By moving them around the commutator step by step, a practically uniform reading will be obtained until the segment to which the broken or unsoldered connection belongs is reached as at *a*, Fig. 13, when there will be a very low reading due to the current having to pass through the entire armature winding. Temporary repairs can be made on this broken coil by entirely disconnecting it and short circuiting the two segments to which it was connected by dropping some solder on them to bridge them over the mica.

Sometimes an open circuit will not show when the machine is standing still, as the conditions may be such that centrifugal force separates the broken wires or connection, but when the machine comes to rest the broken wires may come together enough to allow considerable current to flow. In such a case, when the generator is again started it should be watched very carefully, to see if by short circuiting the brushes with some piece of metal a spark is obtained when it is starting up; if a spark is

obtained when starting and not after the machine speeds up, there exists an open circuit, and the armature should be replaced and sent to the shop for repairs. Of course, in this case it is assumed that nothing is wrong with the field.

If a short circuit exists in an armature it will heat and will be hottest where the short circuited coil is. In testing for a short circuit apply the tester as before, when a uniform reading will again be shown until the short circuited coil is reached, when a heavy reading will result. To repair this temporarily either remove the coil entirely and bridge the two segments with solder as in the previous case, or cut every convolution of the coil and tape the ends so as to prevent them from coming together metal to metal.

In testing the field for troubles the method is as follows, referring to Fig. 11. It is well to test one of each of the different makes of generators, to determine the resistance of the fields when they are in good condition, and put the readings of the meter in a note book, so that in testing later for faults it can be determined whether the resistance is high or low compared with that of a machine in good condition. The shunt field has a high resistance, and if the instrument and battery are connected in series with it there will be a very slight deflection from which little can be learned; the testing set is therefore connected in parallel, as shown by the dotted lines. Connect one side of the set to connection *No. 8* as shown by dotted lines *h* and *k*, and the other side to *No. 5*, and connect the battery *J* across the two wires at *F* and *W*; the brushes should be lifted when doing this. If the meter shows about the same reading as that in the note book for that make of machine the shunt field is in good condition, but if it shows a much lower reading the field is short circuited somewhere and must be replaced. If the meter shows a very high reading, an open circuit exists

in the field; to make sure of an open circuit, connect the testing set in series with the field by disconnecting the battery at *F* and connecting it at *u*, as shown by the solid line, and disconnect wire *k* either at *w* or *u*; if no deflection is evidenced there is an opening somewhere in the field. The series field can be tested with the testing set in series, and to put it in series with the series field, leave the connections of the battery and the meter as in testing the shunt field in the second case, but change the dotted line *h* from connection *No. 8* to *No. 6*. If there is a reading closely approximating the record in the note book for that make of machine the field is good, but if the reading is much higher the series field is short circuited. The generator will generate full voltage even though the series is short circuited, but the voltage, when the arc lamp is switched on, will drop considerably and will cause the arc lamp to jump, due to the solenoid not being able to lift the upper carbon sufficiently. The only remedy in case of a short circuited series field is to replace the entire field, as in the case of a shunt field; of course both fields must be removed, as they are in one coil. If no deflection occurs it is a sure sign that a connection is loose somewhere in the field circuit.

DELAWARE & HUDSON FOUNDRY

In connection with the new shops at Watervliet, N. Y., the Delaware & Hudson has installed a combination grey iron, brass and steel foundry. The making of even brass and iron castings by railroad companies is believed to be of doubtful economy by many, but in addition to these this foundry is turning out all the steel castings used in locomotive and car repairs except driving wheel centers and locomotive frames. The mechanical department officers of the road have been much pleased with

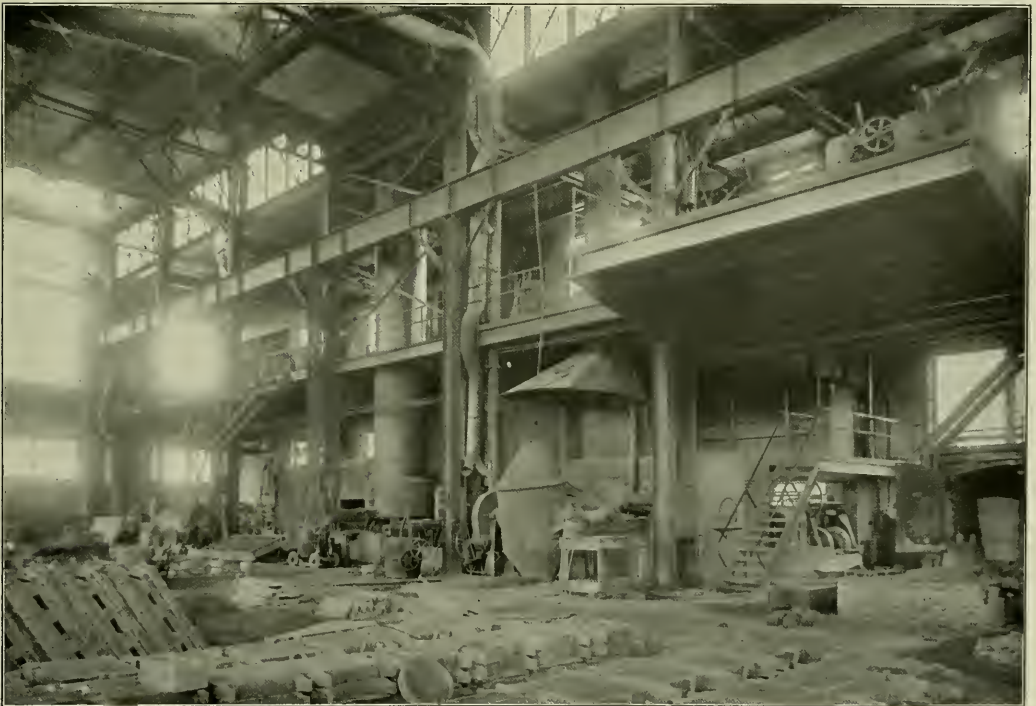

General Arrangement of the Interior of the Delaware & Hudson Foundry.

the results, particularly in the reduction of the time of delivery of castings. When a casting of any description is needed in a hurry it can be molded and delivered almost immediately, eliminating the delays attendant on ordering and shipping from outside sources. Excellent results have been obtained from the steel



Oil Burner Type Annealing Oven.

castings, including driving boxes, and with the means of making these castings so near at hand, it has been found convenient, in several cases where iron castings have proved of insufficient strength, to replace them at once with steel castings. This often saves delay in getting locomotives out of the shop and if the

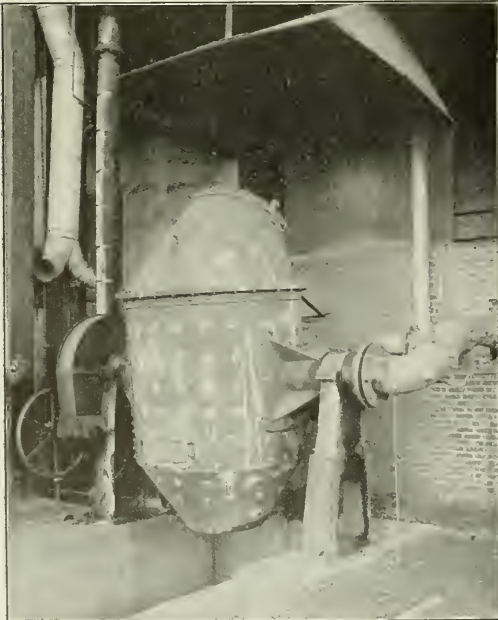

Side Blow Steel Converter of Two Tons Capacity.

casting is unnecessarily heavy it can be redesigned later.

The main bay of the foundry is 57 ft. 4 in. x 176 ft., and is devoted to molding operations. The side bay is 30 ft. x 176 ft., and includes the cupola room, the core room and the cleaning room, and also provides space for the steel converter, sand grinder, sand storage, and annealing oven. The blowers are located on mezzanine floors.

The equipment was furnished by the Whiting Foundry Equipment Company, Harvey, Ill. For the melting department (grey iron and steel) this includes a standard No. 5 Whiting cupola of from seven to nine tons capacity per hour, and a cinder mill; a No. 3 cupola is used for melting stock for the converter.

In the steel foundry there is used a Whiting side-blow converter of two tons capacity, with the tipping mechanism operated by a motor; it is fitted with a Roots high pressure positive blower. There is also an oven 10 ft. x 13 ft. 6 in. for annealing steel castings, and a rotary sand grinder.

The coremaking department is provided with a car oven 7 ft. x 17 ft.; a drying oven for cylinder molds, 12 ft. x 17 ft., and a battery of drawer type ovens in three sections. An electric jib crane of four tons capacity is used for handling the cores. The core and annealing ovens are oil fired. The cleaning department contains three exhaust tumblers 36 in. x 60 in.

The brass foundry included a tilting brass furnace of 400 lbs.

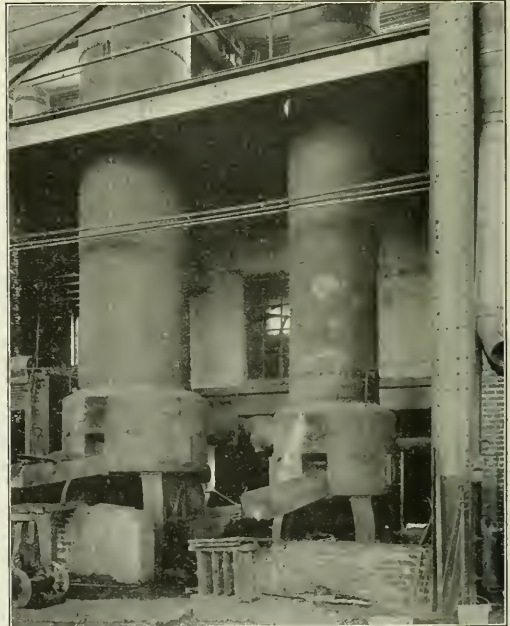

Arrangement of Cupolas in the Delaware & Hudson Foundry.

capacity, but this was found to be insufficient for the needs and it was moved to the erecting shop, where it is used for casting hub liners, a larger one being installed in its place. There are also installed a magnetic separator, a 24 in. x 30 in. wet tumbler, a metal band saw and the necessary benches and grinder. In the general equipment of the plant there is a complete system of industrial tracks and turntables, as well as charging cars for pig iron and coke.

The foundry is under the direct supervision of J. H. Manning, superintendent of motive power, and G. S. Edmonds, superintendent of shops, Delaware & Hudson Company. V. Z. Caracristi was consulting engineer in charge of the construction.

CAR DEPARTMENT

FREIGHT CAR TROUBLES*

BY J. C. FRITTS,

Master Car Builder, Delaware, Lackawanna & Western

The question has been asked as to why we are experiencing so much trouble with freight carrying equipment. In answering this question we must take into consideration the age and design of the cars and also the service they are called on to perform. There are in round numbers about two and one-quarter millions of freight cars in the country, varying in age from one to twenty-five years, and beyond doubt a large number of the older ones are unadapted for present-day train service.

Up to fifteen or sixteen years ago it was the general practice to build cars with short draft timbers extending from the end



Fig. 1—Older Type Draft Sills and Bolster.

sill back to and butting against the body bolster. These draft timbers were secured to draft sills (5 in. x 8 in., in some cases 5 in. x 9 in.) with four vertical bolts. I know of some cases where this practice was in use within the last three years. As a protection to the car against shocks it was the practice to use one or two helical springs between the followers for a draft gear. Cars having draft arms and attachments of this type will not stand the strains they are subjected to in the present long trains.

One of the first things I would suggest doing to relieve the present unsatisfactory condition would be to substitute for the present short draft arm one of metal construction that will extend back of the bolster. This would lead to an inspection of such cars by their owners to determine whether any of them would warrant the expenditure necessary to re-enforce them with suitable metal draft arms and the application of a draft gear which would be a non-recoil, shock-absorbing device. Cars which would not warrant such repairs or renewals should be confined to local service, where the owner would be the only one to suffer the consequences of perpetuating such equipment, or they should be destroyed, using the money received from the sale of scrap to apply on the purchase of new equipment. I believe if we were able to keep a record of the amount expended on each car to keep it in service we could easily prove that so much of the total amount used was being spent on a certain lot

*Copyrighted by the Central Railway Club. Reprinted by permission.

or class of cars that it would be economical to take them out of service.

The Master Car Builders' Association, at its June meeting this year, discussed at some length the question of withdrawing from interchange service all cars of 40,000 or 50,000 lbs. capacity. The discussion resulted in the following motion by D. F. Crawford:

"I move that a committee of this Association obtain from each of the members a statement of the situation as to each of their cars and ascertain if it would not be possible to make a recommendation to the American Railway Association which will permit us, for the benefit of the traffic conditions of the country, to set aside the older cars which are giving every one of us trouble that are moving them" This motion was carried.† This is a move in the right direction for instant relief, and it behooves us as members of the Central Railway Club to get in touch with this committee, as soon as it is appointed, and render all the assistance in our power. I believe, however, the question is one of draft timbers, draft gear and buffing arrangement more than capacity, or even age. However, should we eliminate the old cars, we still have a large number left that are giving a great deal of trouble in the way of broken draft sills, draft timbers, end sills, couplers, etc., and with such cars it is often hard for the mechanical man to decide the most economical method to follow.

Careful investigation indicates that the stresses due to buffing and pulling have more than doubled in the past ten years so that cars built to meet conditions of ten or twelve years ago are not



Fig. 2—One of the Common Failures.

able to stand present-day service without serious damage to themselves as well as adjacent equipment. It can hardly be expected that the cost of maintenance due to failures will remain constant with the same equipment under such varying conditions of operation.

Fig. 1 shows the general construction of the older type of equipment, having wooden body bolsters, short draft arms, separate lug castings and a single spring of 18,000 lbs. capacity to protect the car from shocks, which in many instances exceed 500,000 lbs. It is not an unusual occurrence to apply draft timber bolts to cars of this construction two or three times

†See *Daily Railway Age Gazette* of June 18, pages 1488-9.

while being handled a distance of from four to five hundred miles, resulting in delays, extra switching in the various yards, and, in many instances, serious interruption to traffic.

One of the very common failures in this class of equipment is illustrated in Fig. 2. It will be noted that the draft timber bolts have been pulled completely through the center sills, which were of sound material and properly applied, the car simply having been subjected to greater stresses than it was possible for it to withstand. Due to the age and construction of this type of car the expense of applying proper re-enforcements would not be justified, and if the cost to maintain the older equipment was kept separate from the newer and stronger cars it could be easily shown that the proper course to pursue would be to destroy them and apply the scrap credit to new cars. There are, however, a large number of cars built at a later date that are subject to frequent failures, partly due, it would seem, to faulty construction.

Fig. 3 shows a type of construction used on many cars less than ten years old; these are equipped with solid metal body bolsters, with short draft arms in connection with double spring gear and even, in some instances, with the single spring gear. This arrangement will not stand the frequent shocks to which freight equipment is subject, especially over mountainous roads where heavy power of the Mallet or Mikado type is used. The draft arms that extend only from the end sill to the body bolster

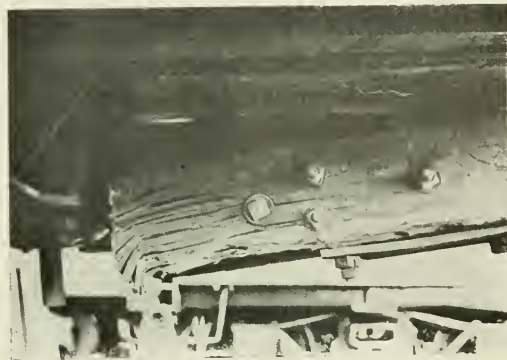

Fig. 3—Metal Bolster and Short Draft Sills.

should not be used in any case. They are the cause of numerous failures together with resultant interruptions of traffic and should be replaced either by the continuous steel construction or long metal arms in connection with open bolsters, locking them with both the top and bottom members. As before mentioned, the general condition and age of the cars have to be taken into consideration when deciding which method of reconstruction should be used.

Fig. 4 shows the center sills and side sill of a modern steel underframe box car, body of which was completely broken in two, due to a bursted air hose while being handled in a train of forty-two cars. The reason for this failure is very apparent and could have been avoided if the sills had been properly tied together. It is quite common to still see cars built having a center sill construction without cover plates, using diagonal braces from the outer ends of the body bolsters, needle beams and end sills to the center sills to avoid spreading or buckling. It has been demonstrated that this type of construction will not give satisfaction.

Steel center sills buckled within 12 in. back of the body bolsters are shown in Fig. 6. It is thought by some car designers that if steel members are tied together at a distance in proportion to the width of the flange, it is sufficient and will meet all requirements. This practice may be mathematically correct but it

does not prove out in service, as this photograph clearly shows.

Another type of steel underframe construction that is giving considerable trouble is shown in Fig. 5. While the center sills have been properly tied and strengthened between the bolsters, one of the most vital points has been overlooked; i. e., the draft arm, made of pressed steel shapes, is riveted to the center sills which have no cover plate, or other means of tying them together, resulting in frequent serious damage and delays to both equipment and lading. The experience of the writer indicates



Fig. 4—Weak Center Sills.

Fig. 5—Weak Draft Sills.

that riveting the draft arms to the center sills to facilitate repairs does not make as strong a construction as continuous sills. It forces a weak construction to start with, because, in order to make such a connection secure against buffing shocks and pulling stresses, a large number of rivets must be used in making the connection, and the holes for the rivets are sure to weaken the structure; but in either case cover plates should be used. The top one should extend from end sill to end sill and the bottom one as far through the bolsters as possible without interfering with the movement of couplers or draft gears.

A very common failure where the draft arms are riveted to the sills is shown in Fig. 7. The slight saving made in facilitating repairs is offset many times by frequent damages of this nature and the large number of cars failing at this point is conclusive proof that this construction is unsatisfactory.

The photographs, selected from a large number, are typical and show the seat of some of the freight car troubles.

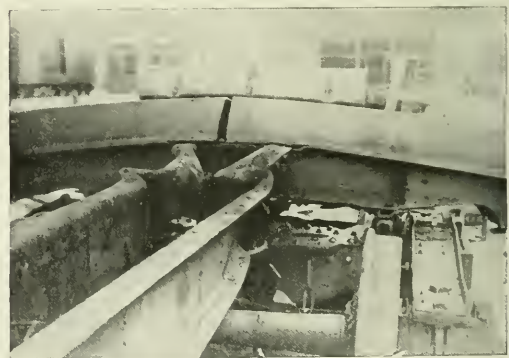

Fig. 6—Failure of Center Sills Due to Poor Design.

The cars shown were not in wrecks or collisions but were damaged in regular service; and all were equipped with one of the various types of spring draft gears which will be considered later.

The photographs also show what we all know to be true, that the part of the car designed to withstand the buffing and pulling stresses is giving more trouble than all the other parts

taken together and for this reason must be strengthened. There are two methods used in re-enforcing old equipment.

First, for the older types of cars that we do not feel justified in going to the expense of providing with steel underframes, some roads are using a metal draft arm instead of the old oak timbers. These metal arms are being made of steel castings or standard rolled steel shapes riveted together in such a manner as to prevent the sills from spreading. I have tried both kinds and favor the steel casting for the reason that it withstands greater buffing stresses and can be molded into one piece for each arm, making fewer parts for the repair men to handle; the only extra parts needed are two or three tie plates riveted from arm to arm so as to make them both act together in receiving the shocks. Furthermore, the metal can be molded in any shape, which allows of a distribution to give maximum strength. These arms, starting at the striking plate, should pass back through and over the transom for a distance of at least 24 in. and have square butting ends to receive a good stiff compression timber secured to the under side of the center sill.

One of the latest designs of this type of steel casting draft arm is shown in Fig. 8. The compression timbers should be placed in line between the needle beams and from each needle beam to the butting face of the metal draft arm. They should also be fitted so tightly that a jack is required to get them in place, and they should be of good stiff section, at least 5 in. x 6

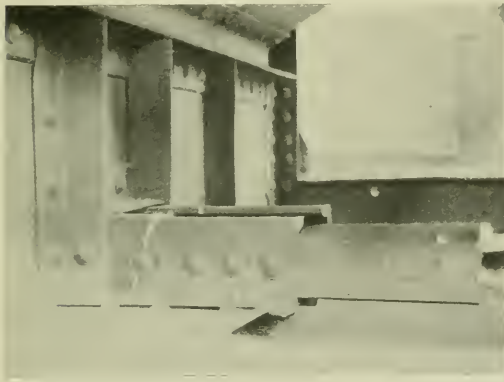

Fig. 7—Common Failure When the Draft Arms Are Riveted to the Center Sills.

in. This type of re-enforcing, including a modern friction gear, can be applied to a car for approximately \$135, and I feel sure it is all that is necessary for a very large number of the old cars that are now giving trouble.

The other method is to apply steel underframes complete at a cost of perhaps three times that of steel arms. This is pretty expensive, but there are a large number of cars that will warrant this expenditure. Some of these underframes have been giving considerable trouble; therefore, we should look carefully into these troubles and design future frames with a view of overcoming them.

One of the latest types of steel underframe construction which it is believed has the greatest strength for a given weight is shown in Fig. 9 and Fig. 10. The center sills are continuous and the cover plates extend through the body bolsters as far as the construction will permit. Auxiliary cover plates at the center have been provided, both top and bottom. The body bolsters have been carefully considered. (A few extra pounds of metal at this point will bring good results.) Securely riveted to the center sills is a top plate 20 in. wide, which will throw a great deal of strength into the center column over the center plate, where the failures show we have the most work to do, and also

acts as a gusset, strengthening the frame against lateral forces. The back lugs have been extended to the bolster and act as stiffeners for the sills. The area of the cross section at the bolster is between 24 and 25 sq. in., which we believe should be the minimum for a 30-ton car. The center line of the coupler has been placed 1 in. below the neutral axis of the center members, this being a feature which does not seem to have been given proper consideration in the past. By keeping the force thrown against the car near the center of the draft sills, not only the liability of buckling but the breaking down at the bolsters

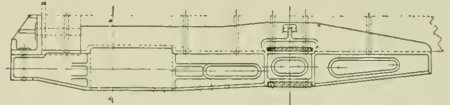

Fig. 8—Cast Steel Draft Sills.

is reduced to a minimum. Car designers should arrange the trucks and underframes so that this can be accomplished.

The underframe having been properly designed and constructed, we must next consider the type of draft gear. Experience from service conditions indicates very strongly that a modern friction gear gives the greatest protection, thus reducing the cost of maintenance and all other expenses incident to car failures. A very careful check of cars placed on shop tracks for repairs, in several parts of the country, shows that an average of 71 per cent. are so placed on account of defects that have developed due to shocks, and of a lot of 1,000 cars recently transferred it was found that over 80 per cent. of the failures were

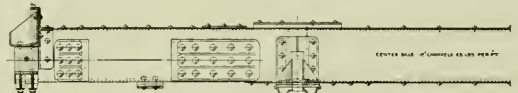

Fig. 9—A Satisfactory Design of Center Sill and Draft Gear Connection.

also due to shocks. Investigation of the cause of damage to lading indicates that a large percentage can be traced to the same cause. If these shocks are responsible for so great an expense to the railroads in general, and we all know it is, what should be done to relieve the equipment of their ravages? We have already considered the underframe construction, but the desired results will never be obtained unless some device, between the frame and the coupler, is installed which is especially designed to destroy or absorb the force of the blow. A car may be properly constructed throughout, but if it is not protected against the force of shocks which freight cars are subjected to, the weakest

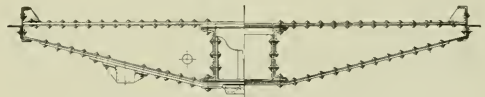

Fig. 10—A Successful Form of Body Bolster.

point will finally begin to fail. Strengthen this one and the next weakest will start to give trouble, and so on during the entire life of the car. Springs varying from 18,000 to 60,000 lbs. capacity have been tried and gave good protection some years ago when cars were of light capacity and handled in short trains, but they do not meet the requirements of today. A large number of railroads, realizing this, have started to replace the spring gear with friction devices that have from three to four times the shock-absorbing capacity that it is practicable to obtain from a spring gear. In a device of this kind there should be no recoil. The force exerted by the recoil of a spring is practically

as great as the force to compress it and results in much damage to equipment, especially in long trains.

The following statement gives the actual comparative service performance of these two types of gears, covering a period of twenty-six weeks, and shows very clearly the superiority of the friction gear:

	Number of Broken										Number of Cars Equipped.	Per Cent. of Failures.
	Couplers.	Knuckles	Knuckle Pins.	Pocket Rivets.	Pockets.	Followers.	Springs.	Draft Spring Castings.	Total Failures.			
Various types of spring gears....	1536	710	2421	3143	207	1102	1620	1482	12211	15000	81	
Various types of friction gears...	168	93	438	86	12	6	21	4	828	4805	17	

The information was compiled from weekly reports submitted by inspectors and shop foremen at every point on the entire system where repairs were made and is impartial and correct. The statement is self-explanatory and needs little comment. The majority of the spring gears were applied to wooden cars, which, to a certain extent, form a cushion themselves and greatly protect the parts susceptible to failures. In order to obtain a correct comparison, only defects that are common to both wooden and steel cars were considered, otherwise the results would have been much more favorable to the friction gear. It is interesting to note that on 4,805 cars equipped with the friction gears there were 828 failures, or 17 per cent. of the total number of cars, while of the 15,000 cars equipped with spring gears 12,211 or 81 per cent. failed, a difference of 64 per cent. in favor of the friction device. A reduction of car failures of this magnitude means a great saving to the railroads in general because of the increased earning power of the cars and the decreased cost of maintenance, lost and damaged lading accounts, delays and interruptions of traffic, transfers of lading and switching through the various terminals. The sum total cannot be estimated, but that it represents an enormous figure I believe we will all agree. It will also be noted that for every coupler broken there were 1.7 knuckle pins which failed, showing that this is the weakest point in the car coupler. We know that the manufacturer as well as the M. C. B. Committee on coupler designs is considering this point and arranging to relieve the knuckle pin of a large part of the work the present design of coupler throws on it.

I fear that some users do not appreciate what a draft gear is called on to do. I am free to confess that up to the time I started to investigate this question some years ago, I did not credit it with being such an important factor in the question of car maintenance, and other expenses incident to car failures. It is the only device that we apply to a car to protect it and its lading from damage. It has no other function to perform. It must destroy shocks from impact, shocks from pulling and shocks due to recoil. I will try and point out a few of the damages occurring to cars because of the draft gear failing to perform the work for which it is intended.

Couplers.—The M. C. B. Association has furnished an elaborate specification, which includes a physical test, to prove the worth of the coupler before it is purchased; yet, after they go into service, they do break in large numbers. If it were possible to put a draft gear between the coupler and the car that would absorb the heaviest shock, we would eliminate broken couplers, and their removal would not be necessary until they are worn out, and I believe the coupler bodies of late design are sufficiently strong to last approximately the life of a car.

Knuckles.—While knuckles wear out in service there are a great many of them that break from shocks, and here again the draft gear that will relieve the coupler from shock also relieves the knuckles. The same conditions hold true of knuckle pins.

Coupler Yokes.—Here again, the failures are due to shocks and I think coupler yokes are being replaced by other forms of attachments, on account of the pocket rivet failures which are due to the rivets being in shear under impact. In several years' investigation of the draft gear question I have satisfied myself

that by eliminating this feature, the wrought iron, or forged steel yoke, with 1½ in. x 5 in. section riveted to the coupler with two 1½ in. rivets can be operated with very few failures.

Draft Springs.—I think no one will deny that draft springs are destroyed by shock, and with a properly designed friction draft gear I have learned that this failure can be reduced to a very low figure, for the reason that the draft springs are not driven solid even though the gear receives a shock that closes it.

Draft Followers.—Here again we have a very common failure that is due to shock. A large number of modern friction draft gears that I have examined show practically no follower failures. Draft lugs, draft arms, draft sills, dead woods and end sills also fail simply because the draft gear fails to destroy the force of the blow.

Burst Car Ends.—The end of a car is often burst by the lading it contains or the lading from an adjacent car. In either case it is on account of the lading moving in an effort to perform the work that the draft gear should have done. However, I believe that more attention should be given to re-enforcing this part of the car.

Car Roofs.—Everyone knows of the trouble we are having with car roofs, and I think you will all agree that it would be very little trouble to apply a satisfactory roof, if the car was standing still all of the time, but the roof being located so far above the floor line and the coupler below the floor line, with a more or less weak construction between the roof and the floor, it cannot help but be racked to its final destruction by the shocks delivered to the car through the coupler. It has been stated that a poor roof will last longer on a car equipped with an efficient draft gear than a good roof on a car with a poor draft gear. The writer is not in a position to either contradict or confirm this statement, but I do know that by replacing an inferior gear with an efficient one is equal to strengthening every part of a car that is susceptible to failure from shocks. We can sum the whole situation up and say that anything about the car that is broken by shock or racked by the large number of shocks is chargeable to the failure of the draft gear to perform its work. I am not here to tell you that there is a draft gear on the market that will prevent all of this damage or that the friction device will cure all of the ills to which the freight car has fallen heir, but I do know there is a great difference between the amount of protection offered by the different draft gears, and for this reason I think some standard specification should be adopted for testing draft gears before purchasing in order to know something of their value. I also believe that a great deal can be learned by periodically removing a few of the draft gears for further tests to see the amount of work they will perform. Also check the failures that are occurring in connection with the several types of gears in actual service. It would seem that sufficient data of this character which would permit of a thorough realization of the possible increase of freight car efficiency are not being collected at the present time.

CONCLUSIONS.

In closing, I have to offer as a relief to the present situation:

First—Re-enforcing the older types of cars that will not stand the expense of a steel underframe, with a long metal draft arm that extends through and over the body bolster. This in turn to be re-enforced, with good, heavy compression timbers.

Second—On such cars as will permit of the expenditure, the application of a carefully designed steel underframe.

Third—In all cases apply the draft gear that will destroy the greatest amount of shock with the entire elimination of recoil.

Fourth—The adoption of a standard specification for the testing of draft gear to determine its shock-absorbing capacity, and amount of recoil before purchasing.

Fifth—Substitute for the present wooden roof an all metal one as soon as it has been demonstrated what the proper construction should be.

FRISCO STEEL FRAME BOX CARS

The Prevention of Lost and Damaged Freight Claims Given Special Attention in the Design

Within the past two years there has been a rapid awakening to the fact that box cars should not only be designed to properly meet the severe service demands due to the use of larger locomotives, longer trains and the more extensive use of hump yards, but that far more attention should be paid to making the cars proof against damage to and loss of freight. The St. Louis & San Francisco has received an order of 1,000 box cars within the past year, which were designed with the express purpose of providing a weather proof and grain leakage proof structure in connection with the desired strength and durability, as well as providing a smooth style of interior construction, with a view to reducing to a minimum the destruction or injury to package freight in paper bags, boxes, or other insecure packages. These cars are of the outside steel frame or Canadian Pacific construction and have a number of features of unusual interest. They are of 80,000-lb. capacity and have the following general dimensions:

Inside length.....	40 ft.
Length between end sills.....	40 ft. 11 in.
Length over running boards.....	42 ft. 1 in.
Length over striking castings.....	42 ft. 3/4 in.
Center to center of bolsters.....	31 ft.
Width inside.....	8 ft. 6 in.

road specified that this was to be placed over a layer of asphaltum coated burlap, which was laid flat on the single course of 13/16 in. yellow pine roofing boards.

The side plates consist of 4 in. x 3 in. x 5/16 in. angles, extending the full length of the car, and with the 4 in. flanges vertical. The side posts are 3 in., 6.7 lb. steel Z-bars, which extend from the underside of the side plate angle to the bottom of the bolsters and cross-bearers, to which they are riveted. The center side braces are also 3 in., 6.7 lb. Z-bars, while the intermediate side braces are 3 1/16 in., 8.4 lb. Z-bars. The door posts are 4 in., 8.2 lb. Z-bars, as are also the end posts at the center. The intermediate end posts are 3 in., 6.7 lb. Z-bars. The corner posts are 5 in. x 4 in. x 3/8 in. angles, which extend from the underside of the side and end plates to the underside of the end and side sills. Angles of 1/8 in. pressed steel at each corner of the car perform the function of rain caps, closing the joint between the side and end plates and protecting the top of the corner posts.

The end plates are of 3/16 in. material flanged to a Z shape, 10 15/16 in. deep at the center and tapering to the side plates with the ends flanged around and riveted to the side plates. The end plate has a 3 3/8 in. flange at the top, which turns in and



Forty-Ton Outside Steel Frame Box Cars; St. Louis & San Francisco.

Width over steel side sills.....	8 ft. 8 3/4 in.
Height from top of floor to under side of carline.....	8 ft.
Height from rail to top of floor.....	4 ft. 1 in.
Height from rail to eaves.....	12 ft. 5 3/8 in.
Width of side door opening in clear.....	6 ft.
Height of side door opening in clear.....	7 ft. 7 3/8 in.
Truck wheel base.....	5 ft. 6 in.

The cars are said to be giving splendid satisfaction from the standpoint of being waterproof, burglarproof, and proof against the leakage of grain; and it is expected that they will also give a favorable account of themselves from the standpoint of the cost of maintenance. The steel underframe, together with the steel framing for the superstructure, including the eight Posson I-beam carlines, furnished by the Camel Company, provide a comparatively rigid structure and furnish a much more substantial support for the roof than was usual in the older types of construction. A Murphy outside metal roof, type X L A, is used and as an additional safeguard against leakage, the rail-

provides a bearing for the ridge pole and purlines. At the bottom it has a 4 in. flange turned outwardly to form a bearing for the end and corner posts. The ridge pole is of yellow pine, 2 3/16 in. x 5 in., and the purlines are 1 3/4 in. x 3 in. The side fascia is of yellow pine, 2 in. x 6 1/4 in., and the end fascias are 1 in. x 6 1/4 in.

The frame work, being on the outside, makes it necessary to provide an inside lining only as shown on the drawing, and the sheathing is in narrower widths than usual with a view to reducing the shrinkage of the side planks. Ordinarily in this type of car the material is used in 5 1/4 in. widths, while on the Frisco cars it is only 3 3/4 in. wide. The lining, which is 1 1/2 in. thick, is connected to the members of the metal frame work by 3/8 in. carriage bolts. The lower side board is cut in 1/2 in. at the floor level to allow the floor planks to pass under the edge. At the ends of the car the floor board is gained 1/2 in. to allow the lower end lining board to fit below the floor level,

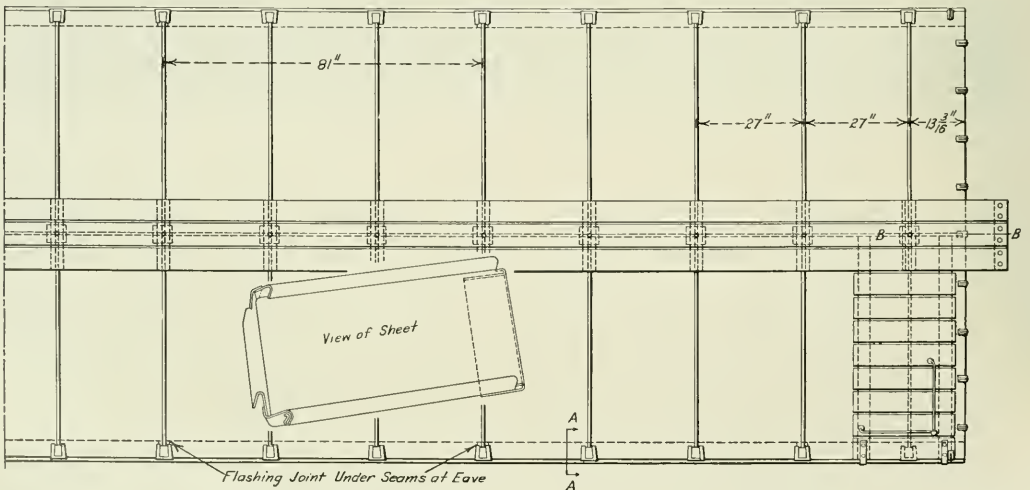
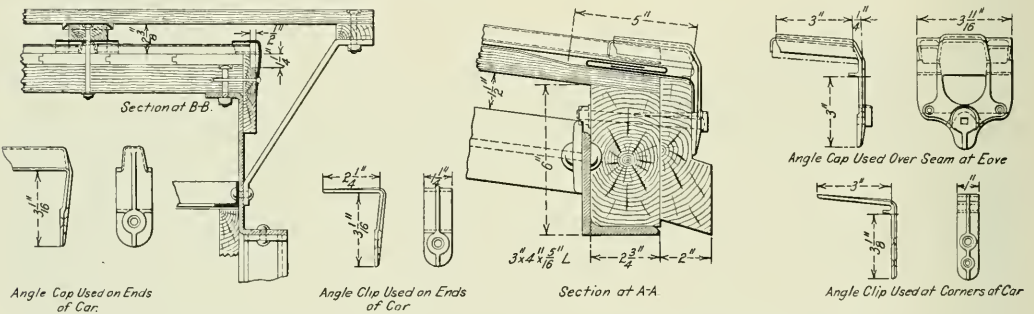
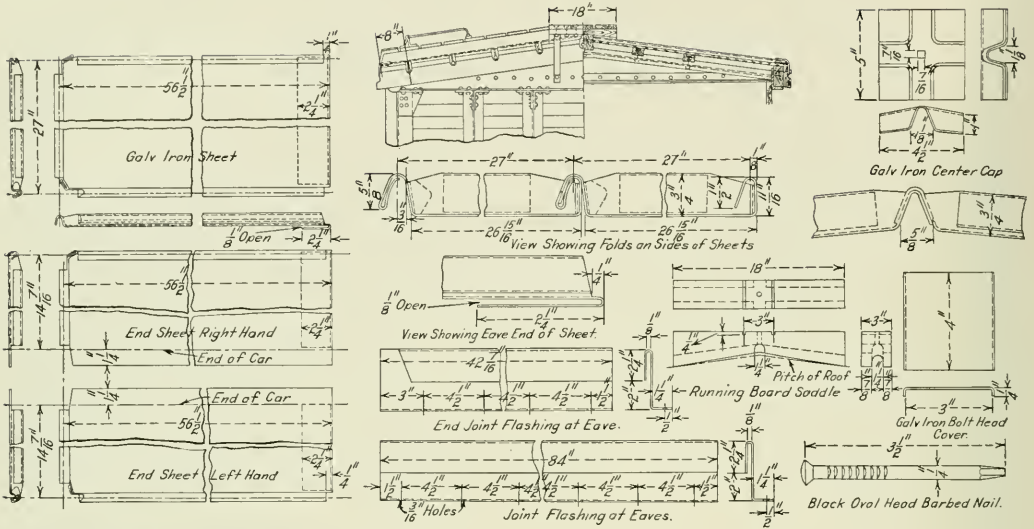

Construction and Details of Murphy X L A Roof as Used on the Frisco Box Cars.

thus insuring a tight fit. The end is also reinforced at the bottom of the lining for the full width of the car by placing a $\frac{1}{4}$ in. steel plate on the outside of the lining, extending about 9 in. above the floor and riveted to the end and corner posts. The lower edge of this plate is flanged at the bottom and is

riveted to the end sill cover plate. This not only stiffens the ends but is an additional precaution against the leakage of grain at that point. The flooring is of yellow pine, $1\frac{3}{4}$ in. in thickness, and is nailed to side nailing stringers of yellow pine, 3 in. x $4\frac{5}{8}$ in., and two center and two intermediate stringers,

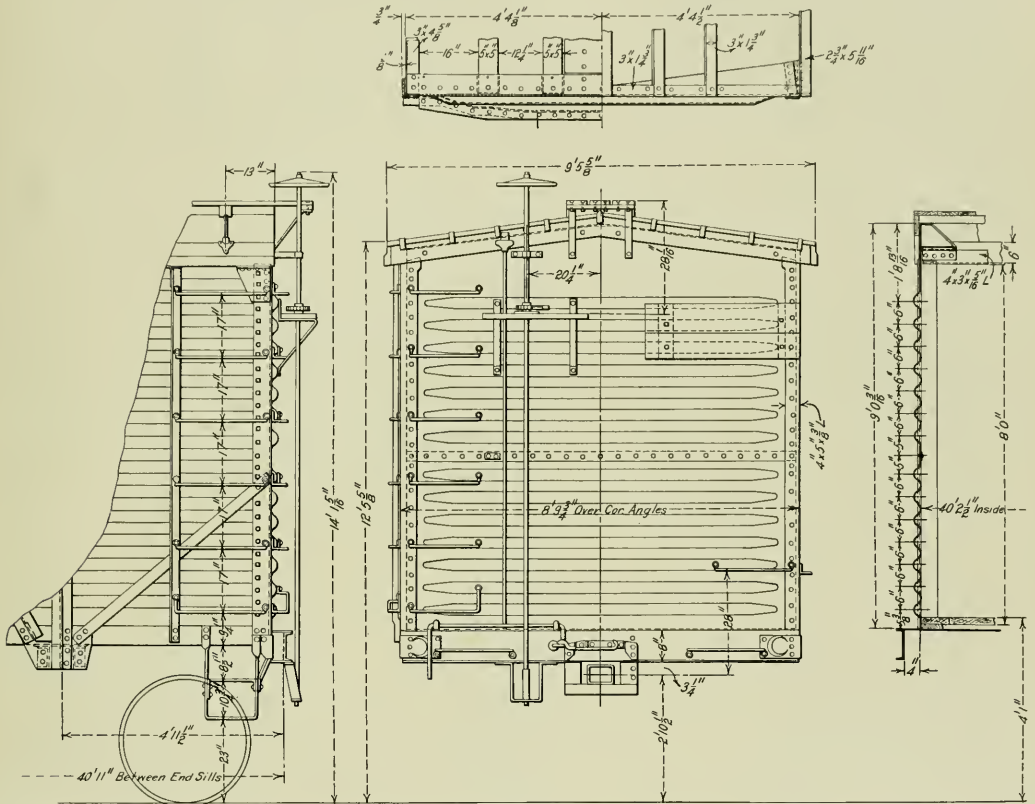

Steel End Used on Twenty-seven 40-Ton Frisco Box Cars.

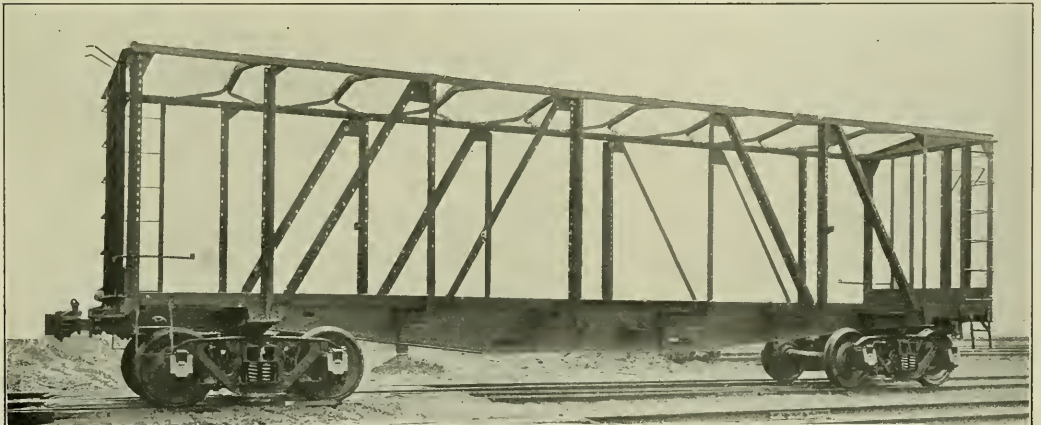

Steel Frame for Frisco 40-Ton Box Cars.

5 in. x 5 in. The flooring at the door openings is supported by 3 in. x 2½ in. x 5/16 in. angles, riveted to the side sill angle.

Wooden ends were used on 973 of the cars and corrugated metal ends furnished by the Standard Railway Equipment Company were placed on 27 of the cars for test purposes. Details of both of these ends are shown in the drawings.

The side doors are equipped with Jones Peerless fixtures and Positive malleable iron door fastenings. The bottom guides are riveted to the door post, floor support angle and the ¼ in. bracket. The door is stiffened horizontally at the top and the bottom by 1¾ in. x 1¾ in. x 1¼ in. x 3/16 in. Z-bars; it is stiffened vertically at the front edge by a 1¾ in. x 1¼ in. x ⅝ in. angle, and at the rear edge by a 2½ in. x 2½ in. x ¼ in. angle. The front edge of the door is protected against weather, cinders,

10 in. back of the center line of the bolster. A 20 in. x ¼ in. center sill cover plate extends for the full length of the car. The draft sills are of ¾ in. pressed steel plates flanged to Z shape, and are connected to the striking castings at the front by 3 in. x 3 in. x 5/16 in. angles. Cardwell type G-11 draft gear is used with Latrobe 5 in. x 7 in. shank steel couplers. The couplers are controlled by the Imperial Appliance Company's uncoupling device.

The side sills are 5 in. x 3 in. x 3/8 in. angles extending the full length of the car and are secured to the end sills by ¼ in. pressed steel combined corner hands and push pole pockets. These sills rest directly on top of the bolsters and cross-beamers with the 5 in. leg vertical. The end sills are 8 in. channels weighing 11.25 lbs. per ft. The end sill top cover

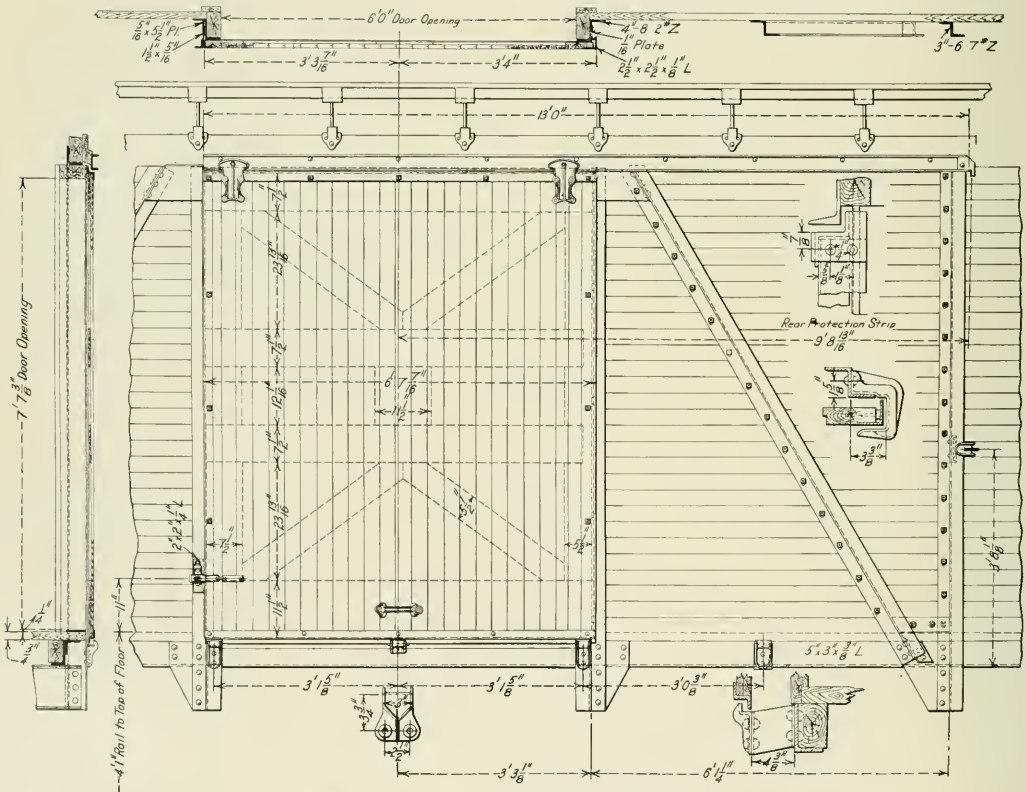

Side Door Construction Used on Frisco Box Cars.

etc. by a 5/16 in. vertical bar which is riveted to the door post and spaced 5/16 in. from it by a filler, the bar abutting the front edge of the door when the door is in a closed position. The rear edge of the door is protected by a 1/16 in. steel bar which is riveted to the door post and is bent in a U shape to form a contact with the vertical rear door edge stiffener angle.

The center sills consist of ¼ in. web plates with 3 in. x 3 in. x ¼ in. top angles and 3 in. x 3 in. x 3/8 in. angles on the outside at the bottom and 3 in. x 3 in. x 5/16 in. angles on the inside. The web plates are continuous between the bolsters and extend 2 ft. 2½ in. beyond them in order to provide for the splicing of the draft sills. The center sills are 26 in. deep at the center for a distance of 11 ft. and taper to 13¾ in. in depth,

plate is 12 in. x ¼ in., shaped to conform to the contour of the end sills.

The body bolsters consist of 5/16 in. pressed steel channel plates placed 6½ in. apart back to back. The top cover plate is 14½ in. x ¾ in. and passes through slots cut in the center sill webs. The bottom cover plate is 18 in. x ¾ in. The center filler is of malleable iron; a steel casting forming a combined roping and jacking casting is applied at the ends of the bolster. The diagonal braces in the underframe extend from the juncture of the side and end sills to the juncture of bolster and draft sill and consist of 5 in. 6.5 lb. channels placed with the flanges down. There are four 9 in. channel floor beams, weighing 15 lbs. per foot, which extend the full width of the car and pass through slots which are cut in the center sill web. They pass

under the side sill and form a direct connection with the Z-bar side posts.

The trucks have cast steel frames furnished by Scullin-Gallagher Iron & Steel Company, and the cast steel truck bolsters were made by the same company. These cars were built by the American Car & Foundry Company.

RECEPTACLE FOR WASTE DRINKING CUPS

BY JOHN H. NAGLE,

Chief Draftsman, Buffalo, Rochester & Pittsburgh, DuBois, Pa.

A very neat and satisfactory arrangement for the disposal of waste drinking cups in passenger cars, has been designed for use on the Buffalo, Rochester & Pittsburgh. Since the railroads have been using sanitary drinking cups it has been found necessary to provide some means of collecting the used cups, as they were thrown on the floor, the result being that the floor around the cooler was always wet and presented an unsanitary appearance.

As shown in the illustration, a small cast iron chute is placed

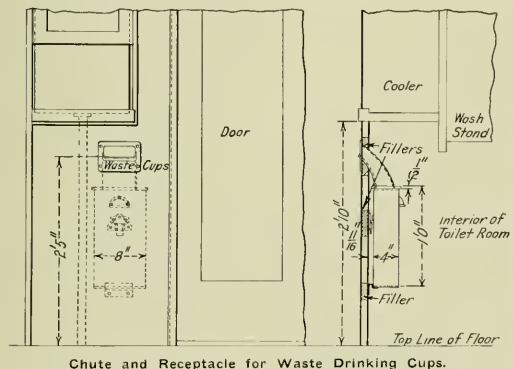

Chute and Receptacle for Waste Drinking Cups.

through the wall of the toilet room, directly under the water cooler. On the wall inside directly under the chute is a galvanized iron can of suitable size, supported on the wall by a male and female bracket, which allows the can to be removed for cleaning. In this way all the used cups are collected, as well as any water which remains in them. This arrangement is hidden from view from the outside, with the exception of the front of the chute, on which is cast in raised letters the words "Waste Cups."

STEEL CARS IN THE TROPICS.—It has, hitherto, been considered inadvisable to operate steel passenger cars in tropical countries, because of the climatic conditions which prevail there, and in adopting a new type of all steel cars for passenger service the South Indian Railway would seem to be embarking upon a policy which has, up to the present, remained untried. Although the cars are of steel construction, every precaution has been taken in designing them to avoid the risks and inconveniences which otherwise would have been experienced. The tests made with the cars have shown remarkably good results. In the matter of internal temperature some very satisfactory results have been reached, a saving in weight, as compared with the latest wooden cars of the same dimensions, has also been effected. This saving would undoubtedly have been exceeded had the designers preferred not to make too sudden a departure from existing standards. It is interesting to note that several other railways in India and Egypt have placed orders with the manufacturers of these South Indian Railway cars for steel coaches.

STEEL PASSENGER CARS IN A WRECK

A recent rear-end collision between two passenger trains of about equal weight, and each composed of all-steel equipment, illustrates what can be expected of the all-steel passenger car when subjected to the severe punishment of a collision.

In this case a train consisting of a Pacific type locomotive, a steel postal car, two steel postal storage cars, two 70-ft. all-steel coaches, a steel parlor car, steel dining car and a wooden private car, when running at a speed estimated at between 30 and 35 miles an hour ran into the rear end of a train drawn by a similar type locomotive and having eight all-steel cars as follows: one postal car, one baggage car, four coaches, one dining car and one Pullman parlor car. The latter train was just moving from the station and at the time of the collision had proceeded about one car length. The colliding train had a weight of approximately 730 tons, including the weight of the locomotive, while that which was just leaving the station had a weight of somewhat over 700 tons, also including the weight of the locomotive and tender.

The rear car of the forward train was the Pullman parlor car, and this received the greatest amount of damage. The report of the Interstate Commerce Commission states that the locomotive crushed the rear end of this car for a distance of 10 or 12 ft. The distance from the buffer to the center plate of these cars is 11 ft. 10 3/4 in., which would indicate that the locomotive did

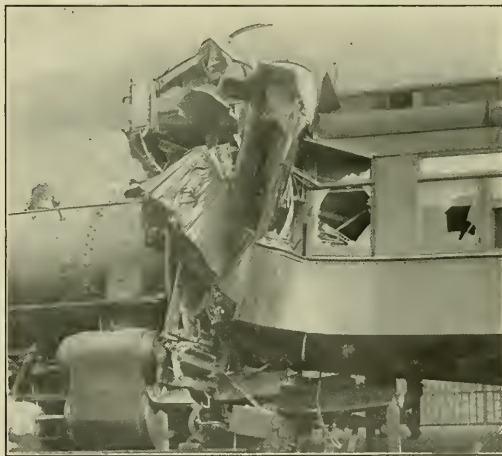

Rear End of the Parlor Car; the Point of Collision.

not pass entirely through the combination steel body bolster and end casting. This would mean a penetration inside the end of the car of about 8 ft. That the destruction up to this point was complete is well shown in the photograph, and it will be noticed that, with the exception of broken window lights, the structure of the car is practically intact beyond the point of actual penetration.

The next car ahead of this was an all-steel dining car, and the vestibules of both of these cars were badly crushed. As will be seen in the illustration, the platform of the dining car passed over that of the parlor car, shearing the vestibule diaphragm and corner posts from the underframe. This action was probably caused by the lifting effect of the locomotive on the opposite end of the car, which would tend to throw the platform at this end under that of the dining car. The shearing of the posts and other parts of the vestibule drew down the hood, and this in turn crushed down on the top of the vestibule of the dining car, forcing

it through the end framing slightly. It will be noted, however, that all the members of the dining car structure held together, and the action throughout is a crushing effect of bending the sheets, but apparently not rupturing any of the main parts of the structure. This indicates that if the shock had been greater,

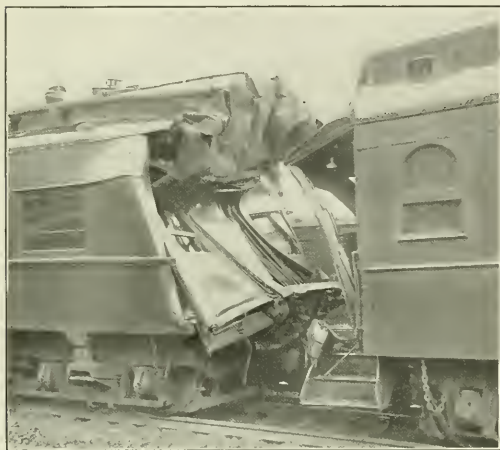

Another View of the Rear End of the Dining Car.

and more of it had been absorbed at this point, the crushing would have continued in this crumpling effect. It should be noted, however, that in spite of the fact that the platform of the dining car lifted over the underframe of the parlor car, there was no penetration of the end framing of the latter at this end.

No other cars of this train were materially damaged, with the



Rear of the Dining Car and the Front End of the Parlor Car.

exception of the pulling out of a coupler on the front car, which was probably the result of the reaction of the heavy locomotive at the head end, which was already in motion.

The action of the cars in the colliding train, however, should be considered, for it will be seen that a considerable proportion

of the shock was absorbed by their action, and apparently the damage done to the forward train was caused by absorbing the blow from but little more than the locomotive alone. The tender of the colliding locomotive was thrown from its frame and came to rest on an adjoining track, and at right angles to it. The postal car, directly behind this, was thrown from the rails and diagonally across the next track, coming to rest with its forward end on the adjoining station platform. One end of this car was crushed in for some distance, and the roof over half of the car was out of alignment. The crushing of this car, however, is very similar to that which took place on the dining car, and consists simply of the distortion and crumpling of the sheets and members in the upper part of the framing without any appreciable tearing or separation of the various parts. The underframe is distorted and twisted as far as the bolster, but the connections between the members are nearly all intact. The opposite end of the postal car and adjoining baggage car were slightly crushed and the remaining cars in the train suffered slight damage, consisting principally of broken windows and fixtures.

The indications from this collision are, that with cars of all-steel type the effect of the blow and momentum of the train will be absorbed first by the dislodging of a car from its position if possible and throwing it across the adjoining track, and secondly, by the crushing of the vestibules and platforms of the cars immediately adjoining the point of collision. If the various members at the end of the cars are securely fastened there will probably be no considerable penetration of the car bodies except at the point where the locomotive itself strikes, and that even here the penetration will not usually extend much beyond the center plate.

GASOLINE SPEEDERS IN FIRE PREVENTION.—The Department of Agriculture says that the government's forest rangers are using gasolene railway speeders for fire protection purposes. They follow up trains on steep grades where sparks thrown out by the locomotives are likely to start fires along the right of way.

THE SECOND SIMPLON TUNNEL.—A correspondent writes: The boring of the second gallery of the Simplon tunnel is advancing steadily, 1,367 workmen being employed in the tunnel itself, and 816 outside it—in all on an average 2,183 per day. The work is in the hands of the Swiss Federal Railways, and is being supervised by Chief Engineer Rothpletz, who was also the chief engineer of the Loetschberg tunnel. Originally there was talk of handing over the contract for the work to a German firm, whose tender was lower than that of any Swiss firm, but owing to the outcry raised by the Swiss engineers, and more or less by the Swiss in general, the Federal railways decided to be their own contractors.

BURMA RAILWAYS.—The Burma Railways Company, Ltd., is hampered by the action of the railroad board, which reflects the attitude of the government of India. The railway board is alternately accused of extravagance and of parsimonious neglect, but the former is neither required nor desired in the case of Burma. The traffic returns of the Burma Railways last year bear eloquent and conclusive testimony to the advantages of a forward policy of railroad building. The number of passengers carried on the main line and the Pegu-Moulmein and Henzada-Kyaungin extensions was 23,966,266, an increase of over 2,000,000 as compared with the previous year. Both on the main line and on the extensions the percentage of expenses to earnings fell, and the percentage of earnings to capital outlay everywhere increased. Figures like these are very satisfactory in themselves and amply warrant the belief that if further extensions were undertaken—and especially if the construction of the through connection to China were placed in the hands of the Burma Railways Company—the financial and commercial benefit to Burma would be large.

NEW DEVICES

FOSDICK HORIZONTAL BORING, DRILLING AND MILLING MACHINE

A number of important improvements have been made in the new design of horizontal boring, drilling and milling machine of the Fosdick Machine Tool Company, Cincinnati, Ohio. Among them are: A better centralization of the controls, narrow gibbing surfaces, steel gearing cut with special cutters, self oiling bearings, phosphor bronze bushings, positive, hardened clutches, precision micrometer dials that can be set to zero at any position and the thorough inacing of the moving parts.

The general appearance and the arrangement of the various parts are well shown in the illustration and reference needs to

ness of its work. Automatic safety trips are provided for both extremes of the movement of the head.

The spindle is of high carbon crucible steel accurately ground and is fitted with Morse taper and cotter keyway. It is driven by two long driving keys and slides in a sleeve with phosphor bronze bushings tapered to take up the wear. The thrust is taken on a ball bearing. The quick advance and return turn-stile is conveniently placed at the front of the head. A special device is provided in the sleeve by means of which the spindle can be held in perfect alinement after any amount of wear.

The feed is composed of all steel slip gears and is entirely enclosed. The changes are made by two handles in front of the casing without stopping the machine and a safety friction device, adjustable from the outside, prevents accidents. The

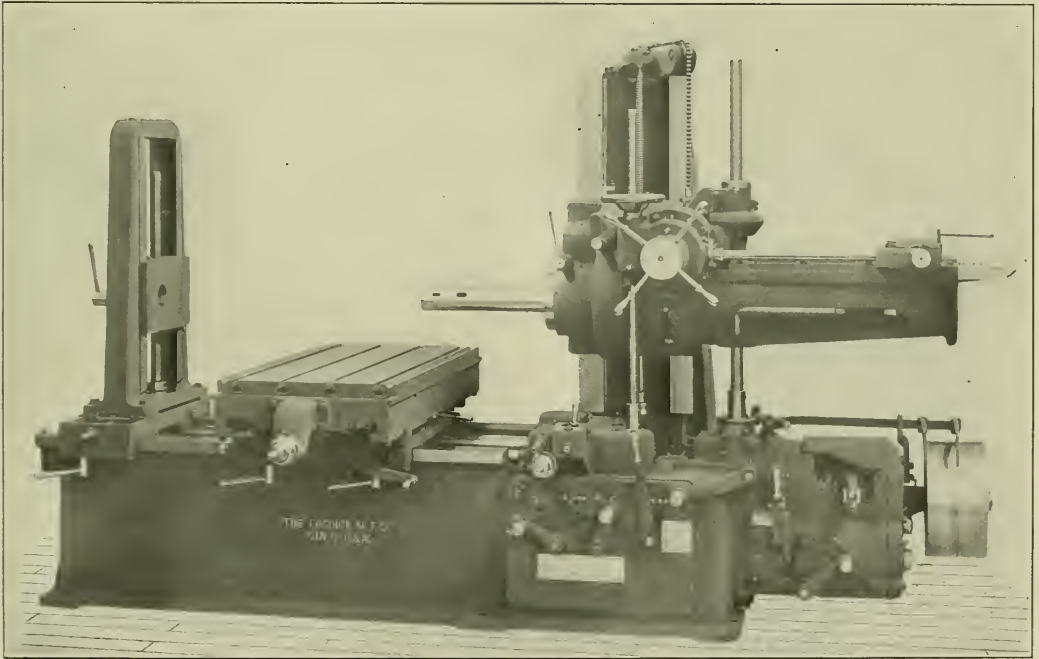

Centralized Control Has Been Made a Special Feature of this Horizontal Boring Machine.

be made to only a few of the more important features that are not clearly visible.

The bed is extra deep and is very well ribbed, giving it a rigidity which makes the machine self-contained and a foundation unnecessary. There are chip chutes arranged to carry the chips and dirt to the rear of the bed. An extra wide space is arranged for the seating of the heavy box column which positively insures its alinement.

The head and the outer support are raised and lowered simultaneously by a rapid power traverse by hand or by the feeds. The elevating screw is suspended from a ball bearing at the top to avoid buckling. This screw has been given special attention to insure the accuracy of the thread and the positive-

rates of feeds are given on a metal feed plate and are the same for the spindle, saddle or head in any direction, and the selection is made by one handle. This makes it impossible to get any but the required movement of any of these parts. The direction of feed reverses with reversing the spindle and stops with the stopping of the spindle. An independent feed reverse gear is provided. Power rapid traverse to all parts is always in the direction opposite to the feed.

A direct reading index over the speed changing handle gives the number of revolutions per minute of the spindle. The drive is direct and requires no countershaft. A novel overtake clutch keeps the machine running at reduced speed when making changes. This practically eliminates the shock. The reverse

mechanism is embodied in the construction, and it is operated by a lever on the front of the machine. All levers are secured with latches to prevent chattering on heavy work.

When used as a motor driven machine a five horse power constant speed motor of any speed may be employed.

Some of the more important dimensions are given in the following table:

Diameter of the spindle bar.....	3 1/8 in.
Traverse of the spindle.....	.26 in.
Vertical adjustment of the head on the column.....	25 1/2 in.
Maximum distance of table to the center of spindle.....	.26 in.
Distance from the face of the spindle to the boring bar support.....	.5 ft.
Size of table.....	24 in. x 50 in.
Cross travel of the table.....	.30 in.
Longitudinal traverse of the table.....	.32 in.
Number of spindle speeds.....	16
Range of spindle speeds.....	112 r. p. m.—225 r. p. m.
Number of feeds in all directions.....	18
Range of feeds.....	.004 in.—.396 in.
Speed of the driving pulley.....	.300
Approximate net weight.....	8,500 lbs.

SAFETY SQUIRT FOR SPRINKLING COAL

The long established and simple method of wetting the coal in the tender by means of a squirt hose is one of the most recent locomotive attachments to receive radical improvement. The last annual report of the chief inspector of locomotive boilers of the Interstate Commerce Commission records 243 accidents due to the failure of such apparatus, of which a large proportion might have been avoided by the introduction of a safety device. These acci-

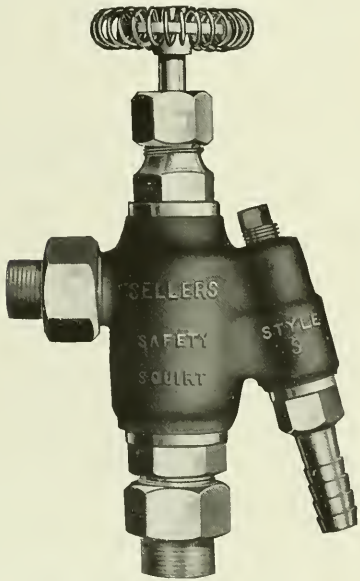

Safety Device for Wetting Locomotive Coal in the Tender.

dents were due to the bursting of the hose and the scalding of the enginemen and to the slipping of the hose from its union, etc.

The old arrangement has, however, the advantage of simplicity and ease of operation. It requires little trouble to open the valve from the injector delivery or from the boiler, and were it not for the excessive temperature of the water used and the high pressure in the hose, there would be little danger of accident. A superseding device therefore must be convenient and simple to operate, and deliver a low pressure jet of cool water.

The accompanying illustrations show a safety squirt, which has been produced by William Sellers & Company, Incorporated, Phila-

delphia, Pa. It is operated by steam from the boiler and is connected by a 1/2-in. pipe to the strainer on the left hand injector for its water supply. Opening the valve at the top produces a strong suction which lifts the water supply, discharging a low pressure jet through a 5/16-in. nozzle the full length of the tender. The temperature of the water is about 110 deg., which is suitable for either winter or summer. The operation of this safety squirt is the same whether it is placed above or below the level of the water in the tank; the internal construction prevents outflow

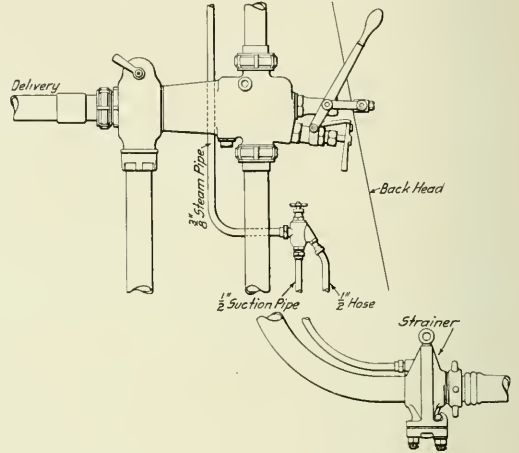

Sellers Safety Squirt Applied to a Locomotive.

through the hose when it is placed under a head of water, or if the injector is used as a heater. The suction branch contains a water check valve which is normally closed, but opens automatically when steam is admitted by the valve at the top. This device is now in quite extensive use and is giving good service.

CAR WINDOW AIR INTAKE

Up to within a few years, about the only means of ventilating a car was by opening the deck sash or the side windows. There are now in use, however, several types of exhaust ventilators usually placed at the deck sash openings, which materially aid in producing a circulation of air through the car. Since the steel car is now rapidly superseding the wooden car, the amount of air leakage around windows and doors is much less than it has been with the wooden car, due to the improved fittings around the windows and doors, and providing for the admission of the proper amount of fresh air into a steel coach, and particularly into the lower berth of a sleeping car, without discomfort to the passengers, has been something of a difficult problem in car ventilation. It is very objectionable to have currents of cold air blow down on the passengers from deck sash openings, and it is likewise disagreeable to have cold air blow into a window or lower berth direct from the outside.

Fresh air should not be allowed to enter a car in large quantities at one or only a few points, but should be admitted through a large number of small openings. With this arrangement there will be no discomfort to the passengers and at the same time there will be a sufficient amount of air enter the car to cause a steady flow of the air exhaled by the passengers out through the exhaust ventilators. A plan for obtaining "free leakage" of air through the car windows without raising the windows has recently been devised. The device is so constructed that the outside air can be admitted at any window

without opening the window and is regulated by the occupant of the seat or berth. Hinged to the sill between the outer and inner windows is a quarter round strip hollowed out, except at reinforcing sections and extends the entire width of the window. A perforated metal screen is placed over the outer flat side to keep out cinders. When the intake is not to be used the quarter-round strip is turned over to lie on the sill between the two windows and the outer window rests on the sill in its normal closed position, as is shown in the illustration. When it is desired to use the intake, the outer window is raised 1 in., the quarter-round strip turned outward and the window allowed to rest on the strip as shown. A stop is attached to each end of the strip so that it will always be in proper position for the window to rest on it. Attached to the bottom of the inner sash is a strip of wood with notches or openings through which the air can pass. This strip also extends the full width of the window and is screwed permanently to the bottom sash rail. These air passages are opened or closed by another strip of wood which

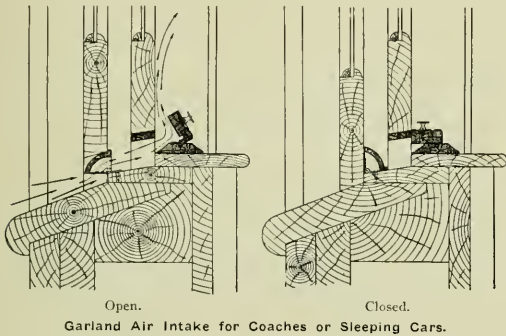

Open. Closed.
Garland Air Intake for Coaches or Sleeping Cars.

extends the width of the window and is hinged to the sill. The edge of this strip closes down against the face of the inner bottom sash rail and completely seals the openings. To prevent air from passing into the car under the strip when it is closed, a tongue and groove is placed at the hinge line. For application to cars now in service, this inner regulating strip is hinged to another strip which is fastened on the present window sill as shown. The edge of the bottom strip next to the window is beveled to increase the open area.

A spring pin is placed in each end of the regulating strip which rubs against the window frame and holds the strip in whatever position it is placed. The passenger can, therefore, admit a small or larger amount of air through the intake as may be desired. The air is deflected upward against the window and does not strike the occupant of the seat or berth.

The device can be applied to cars now in service without cutting any part of the window framework, the strips being attached with a few screws and will not in any manner interfere with the operation of the window.

The device is the invention of Thomas H. Garland, and is being handled by Mudge & Company, Railway Exchange, Chicago.

LIGHT RAILWAYS IN JAPAN.—The British vice-consul at Yokohama reports that numerous light railways have been constructed during the last few years, and there are now within the consular district of Yokohama no less than 271 miles of light railways, while another 238 miles are either under construction or consideration. So far, he adds, nothing further has been heard regarding the scheme for converting the Tokaido railway track into a standard gage system, which was first mooted several years ago, but subsequently abandoned owing to the enormous outlay it would involve.

METALLIC PACKING

The metallic packing shown in the illustration consists of a cup containing three packing rings and two carrying rings. The cup has four slots, set 90 deg. apart, through which steam reaches the outside surface of the packing rings. The slots also serve to engage lugs and bridges to prevent the rings turning inside the cup, while the cup and rings as a whole are free to revolve about the rod.

The smallest bore of the cup is large enough to go over the enlarged end of the piston rod. The carrying rings are made in halves when the piston rod has an enlarged crosshead fit, but in other cases they are in one piece. Of the three packing rings, two are alike, but may be of different thickness to facilitate assembling. Packing ring 1 consists of two symmetrical pieces with a flattened portion as shown, the flat part covering the joint or opening. These flat parts form the two bridge seats; besides being flattened on the outside the halves are cut out 1/4 in. to allow an opening and closing movement. On the two bridge seats are placed bridges of exactly the same width as the ring, and having an outside radius corresponding to the ring itself. Each bridge has a lug to engage in the slot in the cup and prevent the ring from turning. The bridge extends almost across the flattened seat when the ring is closed, but each half ring can slide under the seat to the small extent allowed by the

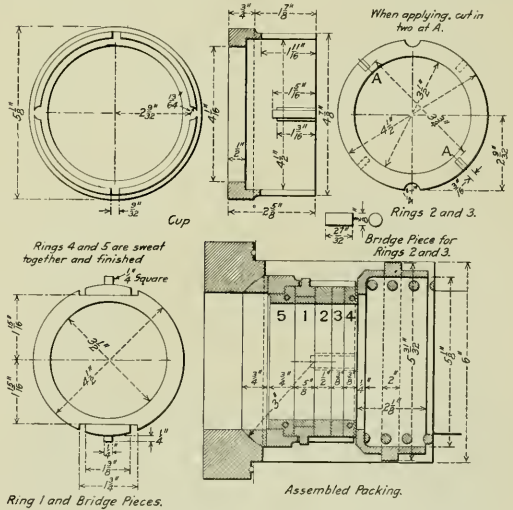

Smith Metallic Packing as Applied to a Wabash Locomotive.

cup. When steam is admitted through the slots in the cup against this ring, it will close around the piston, the ends of the two halves approaching each other. Rings 2 and 3 are also made in halves, with 3/16 in. cut out to allow for opening and closing. Each of these halves has a half round cut in its outside circumference to correspond with two of the slots in the cup, so that a simple round bridge piece engaging the slots in the cup and these half rings holds them from turning in the cup. These two round bridges fit loosely and should be slightly shorter than the combined width of the two rings, so as not to hold the rings apart. Rings 2 and 3 are placed in the cup so as to break joints with each other, and also with ring 1. There is no pressure on the rings when steam is shut off and the cup and rings as a whole float about the rod, the carrying rings supporting the cup when steam pressure is not present.

The packing is made entirely from brass, and it is claimed

that it cannot be melted out by superheated steam. It is in successful use in engines having piston speeds of 1,500 ft. per minute, and also in both saturated and superheated steam locomotives. It is the invention of Thomas Smith, Apartado 279, San Luis Potosi, Mex., and has been patented by him.

DUPLEX JOURNAL BEARING BORING MACHINE

The motor driven, two spindle journal bearing boring machine shown in the illustration has been designed by Detrick & Harvey Machine Company, Baltimore, Md. This machine is constructed for heavy, rapid work, and all parts are made as simple as possible with an aim toward rapid operation and accurate results. The two boring bars and all connections are in duplicate and are mounted on a common bed of the double shear type. The bed is of sufficient length to bore and face car boxes 6 in. x 12 in. The headstocks are bolted directly to the bed and are of sufficient height to give a clearance of 13 in. from the center of the spindle bearing to the top of the bed. The spindles are of cast iron $4\frac{1}{4}$ in. in diameter with a 17 in. bearing in the headstock and carry steel tooth gears which revolve loosely on the spindles and are connected to them by sliding tooth steel clutches which are keyed to the spindle and actuated by an eccentric lever. The pinions are of bronze or steel while the driving gears are of cast iron.

Steel boring bars $3\frac{11}{16}$ in. in diameter are supplied for boring 5 in. diameter boxes and larger. The bars are secured to the ends of the spindles by sockets and are supported at the opposite end by bearings. These can be operated simultaneously or independently as desired.

The carriages have a sliding motion on the bed by either hand or power, and are also provided with a quick hand motion by

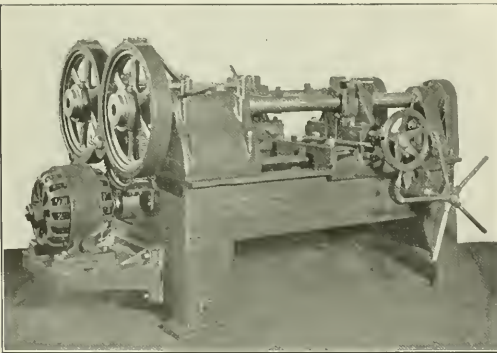

Journal Bearing Boring Machine; Detrick & Harvey.

a spider to the rack. A slow hand motion is provided by a hand wheel on the end of the screw. The power feed is arranged by means of a spur gear at the end of the bed furthest from the headstock where the motion of the feed mechanism is taken from the spindles by enclosed gears. Each spindle has independent feed changes and feeds for the carriage are arranged for $1/16$ in., $1/8$ in., and $3/16$ in. per revolution of the spindle. Each carriage carries a cross slide on which two other slides are fitted, being adjusted to and from the center line of the spindle by a right and left hand screw. The slides support the gripping jaws for holding the journal bearings and a clamp is provided at the top to prevent any springing of the parts. The carriages contain opening and closing nuts operated by a lever.

HEAVY TYPE FORGING MACHINE FOR GENERAL WORK

A new design of heavy forging machine which embodies a number of improvements and is suited for handling high carbon and alloyed steels as well as wrought iron, has been perfected by the National Machinery Company, Tiffin, Ohio. This machine is designed with a very high factor of safety and has an improved safety release on both the gripping and plunger movement.

One of the most important features of a successful forging machine of this size is the insuring of the utmost stiffness and rigidity in the frame. Especial attention has been given to this in the design illustrated, and the bed frame of the machine extends considerably below the floor line with a very heavy and

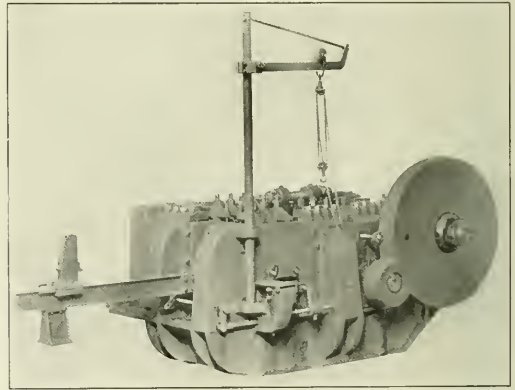

View Showing Underribbing of the National Forging Machine Frame.

massive under-ribbed or girdered portion. The whole frame is a large steel casting and efforts have been made to distribute the metal along the line of the greatest stresses to the best advantage. Sufficient success has been obtained to allow the entire elimination of tie rods which are sometimes used across the top of the bed at the gap or entrance to the dies as well as longitudinally. The massiveness of this part of the machine is well shown in the illustration.

A special design of friction fly wheel, which has proved successful in previous designs of this type of machine, is applied in this case. This, while primarily intended as a safety or relief on the plunger movement, also provides an element of elasticity and allows a motor to be connected directly to the fly wheel if desired. The motor can be geared to the fly wheel through the medium of a rawhide gear which will insure quiet operation, and experience has shown that the excessive strain thrown on the motor when the machine is accidentally stalled by cold stock or excessive metal is fully compensated and provided for by this design of fly wheel.

In the illustration of the top view, the four inch type of machine is shown. It will be seen that the heading movement is effected by a crank while the gripping action is controlled by two cams, one controlling the forward or gripping movement of the toggles and the other serving to open the dies. By employing two cams for the gripping movement the opening and closing

of the dies is so timed as to secure practically the entire stroke of the heading tool or plunger, thus giving the machine unusually large gathering capacity, *i. e.*, ability to upset a large amount of

operations, and thus fewer heats, to complete the forgings, while the large die opening facilitates the handling of large upsets in and out of the machine.

This view also shows the automatic relief of the gripping movement. This safety device is designed in the form of a by-pass toggle, the action of which is better shown in the line drawings. It is designed so that but a small proportion of the gripping pressure or power is dependent on the toggle and the spring which holds the toggle in the normal position. This spring does not relieve the machine until the same strains are secured in the dies which in other relief designs would shear a breaker pin or bolt. The relief resets automatically without any attention on the part of the operator. Its action will be readily understood by an examination of the drawing showing it in both normal and relief positions.

Another new feature that has been incorporated is a suspended type of heading and gripping slides which are shown in section

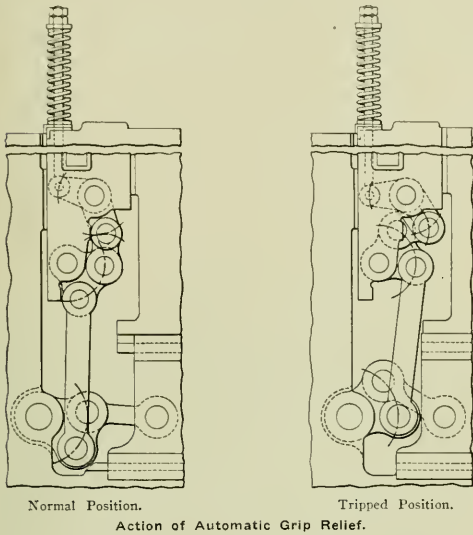

stock at one stroke of the plunger. This double cam mechanism also enables the dies to be opened wide which, with the large gathering capacity, enables the machine to handle large and difficult forgings with greater economy, as it necessitates fewer

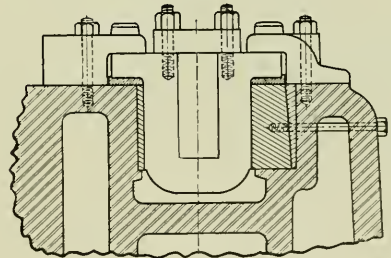
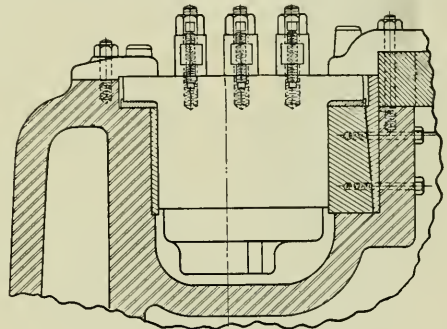

Sectional View of the Suspended Heading and Gripping Slides.

in one of the illustrations. In this type of slide the supporting bearings are at the top instead of at the bottom which removes them from the line of water and scale that are so detrimental to lubrication. The sectional views also show the wedge construction back of the side liners on these slides. With this construction shimming can be added as needed without removing the slides or liners and it is easy to maintain a very close contact between the slide and the liner and to keep them in perfect alignment.

The slide bearings, toggle and shaft bearings are given an unusually large area in an effort to minimize wear by facilitating lubrication. The means for supplying lubricant to the various surfaces has been carefully considered and large oil boxes in the cover take care of the slides and the main shaft. Oil cups with connecting ducts are provided for the bottom toggle and other bearings. The suspended slides eliminate a source of great trouble in lubrication on many former machines.

This type of forging machine is built in sizes ranging from 2 in. to 5 in. capacity, the one shown in the illustration being the 4 in. size.

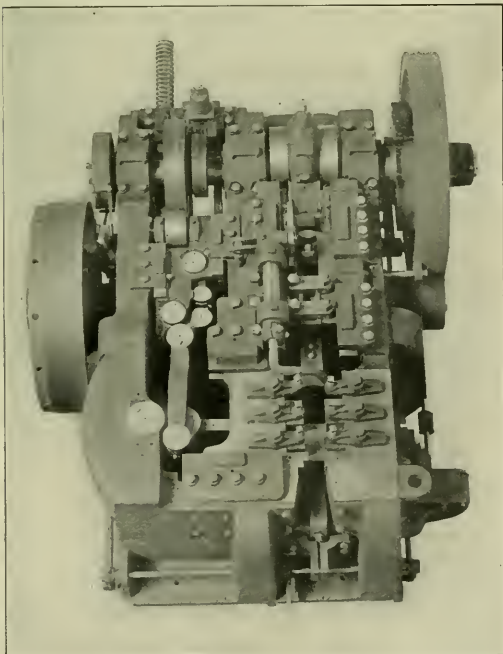

General View of the National Heavy-Pattern Forging Machine.

SIDE ROD GREASE PLUG

The loss of grease plugs from locomotive side rods is a cause of much annoyance and expense. The loss of a plug on the road is quite likely to permit a crank pin to heat badly before the plug can be replaced and quite frequently no spare plugs are at once available. The grease plug which is shown in the illustration is the invention of L. P. Welley, Hinton, W. Va., and has been patented by him. The body of the plug is cored out and a bolt is passed through, as shown, with a taper head bearing against the sides of the plug, which are tapered to conform to the bolt head. In order to lock the plug in any position, it is only necessary to tighten up the nut on the outer end of the bolt; the same wrench can be used both for tightening this nut and for screwing down the plug in the rod. This method of locking prevents any outward movement of the plug, and therefore any slacking off of the pressure on the grease. It is claimed for this device that no injurious pressure is put on the threads and also that the

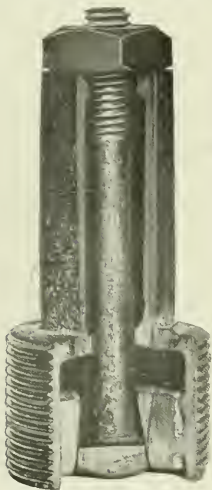

Grease Plug Showing Locking Bolt.

cost of manufacturing the plug is quite low.

NON-VIBRATING CHAIR FOR PARLOR CARS

In order to reduce the vibration transmitted to passengers in parlor cars, a special type of chair pedestal has recently been devised. In the construction of this seat there is used a central shaft connected at its upper end to a metal frame, which in turn is secured to the seat frame. This shaft passes through the base, or pedestal, of the seat and has nuts on the lower end for

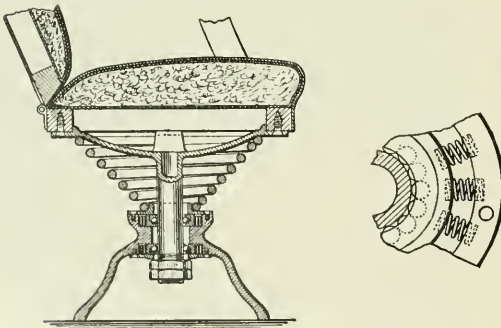

Parlor Car Chair Designed to Eliminate Vibration.

the purpose of applying compression to a volute spring, which has its smaller end bearing on the upper surface of the pedestal and the large end under the metal frame. The recessed upper end of the pedestal is provided with upper and lower grooves with plates secured to the pedestal. In the grooves thus provided are placed annular ball bearing collars held in place by

springs. Any tendency to divert the shaft from the vertical is at once taken up by the shifting of the ball bearing collars, which move in opposite directions. This does not interfere with the resilient action of the volute spring.

This device was invented and patented by Henry A. Bates, Middletown, Conn., and Harold Ferrell, Plainfield, N. J.

PORTABLE FLOOR CRANE AND HOIST

The portable crane shown in the illustration has proved to be of decided value in a large number of railroad shops. The crane is shown as working in the erecting shop, where experience has proved there are a large number of operations to which it can be adapted with a very distinct saving in time and effort. In addition to this, however, it is used with advantage in the machine shop handling work to and from the machines,

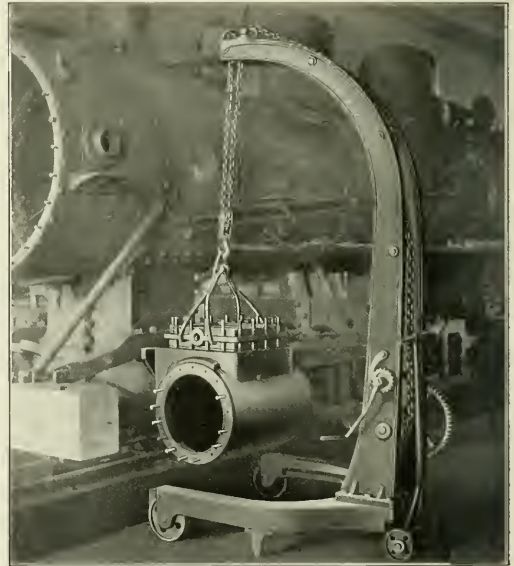

Portable Crane Removing a Steam Chest.

as well as transporting heavy parts under a balcony and similar places where overhead cranes cannot reach.

The crane here shown is manufactured by the Canton Foundry & Machine Company. It is provided with roller bearings, which greatly improve the ease of operation. The arrangement is simple and will allow one man to lift and carry from 200 to 4,000 lbs. on the hook.

CAUSES OF FOREST FIRES.—The various causes of fires have not changed greatly in their relative proportions. Railroads and lightning head the list, with campers next. There has been, however, a marked decrease in the number of fires caused by burning brush, which, according to the forest officers, indicates a closer co-operation with the settlers in and near the forests and with timberland owners in fire prevention and control. It is still true, nevertheless, that a large proportion of all fires started are due to human agencies and may generally be charged against carelessness. Fires caused by lightning are of course not preventable, but the system of lookouts by which they may be detected immediately after being set is greatly lessening the loss from this source.

PORTABLE TURNING MACHINE

The machine shown in the accompanying illustration is intended primarily for turning crank pins in position, but is also suitable for a variety of other work where it is desired to true up a circular surface on any part of a machine without dismantling and removing it to a lathe. It is also suited for boring as well as for cutting on the outside of a shaft or pin.

It is simple in general construction, and consists of a rectangular body, planed true on all sides, which has a slot or

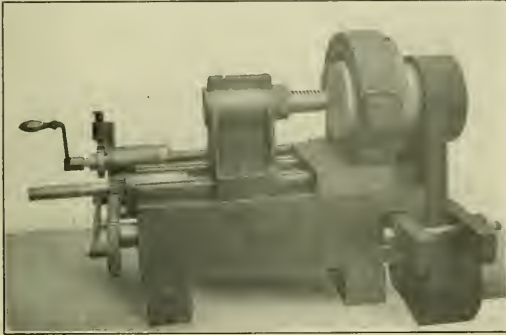

Portable Turning Machine Truing a Crank Pin.

opening at the front end through which a bar can be passed for clamping it to the work. The shears on which the cutter head slides are scraped and all parts are carefully fitted to give freedom of action without lost motion. The feed screw is on the far side of the bed and is actuated by a ratchet and pawl arrangement like a shaper feed which allows variable, reversible and automatic feeds to be obtained. The driving shaft is beneath the cutterhead inside the body and is supported by substantial bearings at either end. It projects beyond the

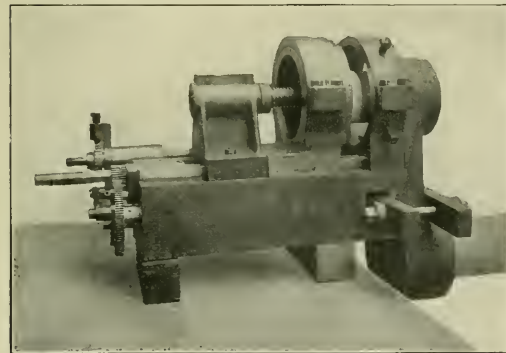

Machine Supported on the Crank Pin.

end of the bed and is arranged for driving by an air or electric motor or by a flexible shaft if there is not sufficient clearance for the application of a motor. The cutterhead is split in halves in a special manner which in no way weakens the construction and allows the machine to be used on the pins of cranked axles, driving axle journals, etc. A movable tail stock is provided and can be placed anywhere on the bed, either ahead or behind the cutterhead. It carries a centering screw with a square thread and a lock nut. When using the machine for re boring crank pin holes the tail stock is placed ahead of the cutterhead

and is employed as a guide for the bar. A divided setting head is also provided which, by means of four set screws, allows the centering of the machine to be made directly from the shaft or pin itself, insuring greater accuracy, especially where the side of the crank or driving wheel is not square with the center line of the pin.

In the illustration the machine is shown truing a crank pin under conditions which permit it to be clamped directly on the wheel center. Another view shows the use of the setting head which, by means of its four set screws, allows the whole machine to be supported by the pin alone, the clamp to the crank or driving wheel being only for steadying and holding the machine in place. The third view shows it in use as a boring bar truing the crank pin hole. In this case the cutterhead is provided with clamps for holding the boring bar and the tail stock is used as a guide.

In addition to the use as a crank pin truing machine this tool is also available for truing up journals on driving axles when a wheel lathe is not available or its use not advisable. The cutterhead is arranged so that tools can be placed on either side and it can thus cut close to a shoulder on either side, as would be necessary in the case of a cranked axle. When used on a cranked axle or similar work, two tail stocks with centering bars are employed which set in deeply countersunk centers on the

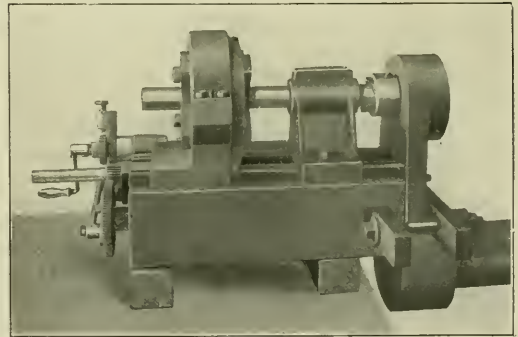

Portable Turning Machine as a Boring Machine.

outside of the crank check and give the required alinement without other attachment.

The machine illustrated is manufactured by the Pedrick Tool & Machine Company, 3640 North Lawrence street, Philadelphia, Pa.

PROPOSED LINE FOR PARAGUAY.—A commission of engineers has arrived at Asuncion, Paraguay, to carry out the surveys for a line from Puerto Suarez to Santa Cruz. This line forms one of those which the Farquhar syndicate proposes to build.

RAILWAY DEVELOPMENT IN GREECE.—Discussing the reception of King Constantine in the capital the Athens newspapers say that, after the impending demobilization, the country must work at the organization of a settled administration and the development of Greece's new territories. Apart from joining up Greek railways with the European lines, the Greek system must be extended throughout the kingdom.

TRANSPORTING COAL THROUGH PIPE LINES.—A method of transporting coal by water pressure through a pipe has been suggested by E. G. Bell, engineer for the Hammersmith Electricity Works of London. By this method from 30 to 60 tons of coal per hour can, it is claimed, be forced through an 8-in. pipe leading from the Thames and under Chancellors' Road to the yard of the power plant on Fulham Palace Road, a distance of 600 yards.—*Coal Age*.

NEWS DEPARTMENT

The Great Northern and the Northern Pacific have announced that all passes issued to Montana state officers and their deputies have been revoked.

The United States district attorney at St. Louis has filed suit against the Illinois Southern to recover penalties of \$8,000 for alleged violations of the hours-of-service law and for failure to report such violations.

President Daniel Willard, of the Baltimore & Ohio, has ordered that no intoxicating liquors be carried or served in his official car. President Willard aims to set an example of respect for the rules of the operating department.

James J. Hill entertained 360 members of the Veterans' Association of the Great Northern Railway, at Glacier Park, Montana, on September 16, Mr. Hill's seventy-fifth birthday. The association includes officers and employees who have been in the service of the company 25 years.

The Chicago, Milwaukee & St. Paul, the Chicago, St. Paul, Minneapolis & Omaha, the Chicago & North Western, and the Illinois Central have notified the Wisconsin Industrial Commission of their determination not to come under the state workmen's compensation law.

An appeal is made to the public by the Pennsylvania Railroad to "stop, look, and listen." That is all very well for the part of the public which goes on foot or drives milk carts, but as for the automobilists, ought not the express trains to stop, look and listen for the honk?—*Springfield Republican*.

The shops of the Trinity & Brazos Valley at Teague, Tex., including a number of cars and locomotives in the shops for repairs, were almost totally destroyed by a fire supposed to have started from an electric wire, on August 26. The loss is estimated at \$225,000. It is announced that the shops will be rebuilt at once.

The Canadian Pacific has fitted up a car for giving instruction in first aid to the injured. The car, with an instructor, has been started out on a complete tour of the system, from New Brunswick to the West. It will remain at each grand divisional point for about three weeks, and at the smaller ones for about ten days.

Senator O'Gorman of New York, has introduced in Congress a bill designed to prohibit the use of wooden cars in passenger trains after a certain date in the future. The senator would make it unlawful to introduce any new wooden cars after the end of this year, and at the same time he would extend to the whole train the present rule concerning mail cars, which forbids running wooden cars between those of steel.

The Electric Division of the New York Central & Hudson River now extends on the main line from New York northward to Harmon, 33 miles, and a considerable number of through trains change engines at Harmon, instead of High Bridge, as formerly. Seven additional trains were put on this schedule recently. The northbound Empire State express, which for several years has stopped at High Bridge, now passes that place without stopping and makes a stop at Harmon.

A press despatch from Jackson, Tenn., reports that an attempt to hold up a Mobile & Ohio northbound train on the night of September 13, was frustrated by an armed guard of fifteen men who had been expecting the holdup. The bandits,

who had climbed aboard the engine at a point ten miles from Jackson, jumped when the firing began and escaped into the woods, firing back as they ran. No one was wounded so far as known. The posse left the train and began a search of the surrounding country for the robbers. A farmer who lives near the scene of the holdup and who was taken into the confidence of the bandits weakened and gave the information that prevented the robbery.

R. C. Richards, chairman of the Central Safety Committee of the Chicago & North Western, has compiled a statement showing the results of the safety work for the three years ended June 30, 1913, on the basis of the number of accidents occurring during the year ended June 30, 1910. This statement shows that there was a decrease of 28.6 per cent. in the number of employees killed and 24.8 per cent. in the number of employees injured; an increase of 12.1 per cent. in the number of passengers killed with a decrease of 23.6 per cent. in the number of passengers injured, and of 18.8 per cent. in the number of "outsiders" killed. During the three years from 1911 to 1913 there were 229 employees, 37 passengers and 572 "outsiders" killed on the North Western.

The New York Central is sending out a circular, to be posted in all its stations, which calls attention to the fact that about 400 persons are killed annually in the state of New York while trespassing on the railroad tracks. This is about four times the number killed at grade crossings. This notice is printed on a sheet about 8 in. x 10½ in., and is headed "DO NOT WALK ON THE TRACK." It contains the usual arguments and warnings against endangering one's life by unnecessary walking on the railroad right of way and is in type large enough to be read some little distance away. Agents are instructed to deliver a supply of the placards to the schools and also to manufacturers, shippers and others who might aid the railroad in bringing the trespassing class to their senses.

In preparation for greater fruit crops, the Pacific Fruit Express is building a large new ice manufacturing plant at Los Angeles. It will be completed in October, will have a capacity of 85 tons daily, and will cost \$125,000. The design is such that, by the installation of another unit of machinery, the capacity can be increased to 170 tons daily. Storage room will be provided for 15,000 tons. The building will be of concrete construction. Icing platforms will care for 20 cars at one time, so that fruit can be moved promptly without delay in refrigeration. The ammonia condensers will be of a new type. The entire output is to be used for the rapidly increasing refrigerated shipments of fruit through Southern California and in icing Southern Pacific passenger cars at the Los Angeles station.

The North Western University School of Commerce, Chicago, has announced a course of thirty-two lectures on transportation to be given on Friday evenings from 7 to 9 o'clock, from October 1 to June 1. The course is designed to give the student a general knowledge of the transportation field as well as a detailed knowledge of the principal problems in transportation. The lectures will be given by Professor Secrist and will be grouped under the following heads: First semester, the American railway system, the railway service, the railroad and the public; and the railroad and regulation. The work of the second semester is primarily concerned with railway rates and regulation. The main topics considered are the theory of railroad rates, rate-making and practice, personal and local discriminations, freight classification, rate systems and the regulation of interstate commerce.

CHICAGO ARBITRATORS' DECISION

W. J. Jackson, F. A. Burgess and E. C. Houston, the arbitrators appointed to decide questions of wages between the Chicago & Western Indiana and the Belt Railway of Chicago, and their locomotive engineers, have completed and handed down their report, and they hold that the roads were not justified in paying the higher wages demanded by the employees, except that they awarded an increase in the work train rate from \$4.15 to \$4.40 a day. Some changes in working conditions were approved. The board found that these two roads were paying higher wages than are paid by the majority of Chicago lines for the same services.

APPRENTICES ON THE NEW YORK CENTRAL LINES

The report of the apprentice department of the New York Central Lines west of Buffalo for July, 1913, gives the following figures:

Table with columns for various trades (Machinists, Boilermakers, Blacksmiths, Cabinet Makers and Coach Carpenters, etc.) and rows for different months (July 31, 1913, etc.). Includes a 'Total' row at the bottom.

that one had answered for the whole party. The party consisted of J. Robinson, J. R. Seeley, David Hennessey, P. Rice and Mr. Cook. Mr. Cook said that the Baldwin letter, except for the signature, was written by George Burnham, Senior.

DISCIPLINE WITHOUT SUSPENSION ON THE CANADIAN GOVERNMENT RAILWAYS

F. P. Gutelius, who was recently appointed general manager of the Canadian Government Railways (the Intercolonial and the Prince Edward Island), has issued a circular stating that it is the intention to insist on a more rigid compliance with the rules and regulations, which are made for the protection of the lives of the public and employees, as well as for the protection of the railway's property.

All employees will start with a clean record, beginning September 1. Any exceptional service rendered will be credited to the employee's record. A monthly discipline list will be issued. This list will show cause, extent of discipline, or action and extent of reward.

Employees will, as heretofore, be subject to summary dismissal for insubordination, drunkenness on or off duty, using intoxicating liquor when on duty, frequenting saloons, or places of low repute, incompetency, dishonesty, failing to carry out train orders and rules respecting train movement. Where previously discipline was meted out by suspension demerit marks will be placed in the record of an employee. For every repetition of an offence by the employee, the number of demerit marks will be doubled. When the demerit marks against any employee number 60, his services will be dispensed with.

For every 12 consecutive months good service, free from demerit marks, an employee will have 20 demerit marks deducted from those that may stand against his record. Employees will be advised when demerit marks are recorded against them, the same as they have hitherto been advised respecting disciplinary measures in the past.

A LETTER OF M. W. BALDWIN

The letter dated April 3, 1849, a fac-simile of which is shown below, was written by M. W. Baldwin of Philadelphia, the founder of the Baldwin Locomotive Works. It is of interest, not alone because of the distinguished name attached to it, but also from the fact that John S. Cook, the man in whose favor

Facsimile of a handwritten letter from M. W. Baldwin to John S. Cook, dated Philadelphia, 3rd April 1849. The text discusses Cook's employment and character.

MEETINGS AND CONVENTIONS

American Electric Railway Association.—The American Electric Railway Association will hold its annual convention at Atlantic City, N. J., October 13-17. Some of the principal topics to be discussed will be Unsightly Poles; Profit Sharing with Employees; The Relation of Carriers to the Development of the Territory They Serve; Relief of City Congestion; Present Tendency of Public Service Laws and Regulations; Valuation and Electric Railway Securities from the Investor's Viewpoint.

American Society of Mechanical Engineers.—The date of the railway session of the fall meeting of the American Society of Mechanical Engineers has tentatively been arranged for the afternoon of December 3. The topic for discussion will be Steel and Steel Underframe Box Cars. As the result of replies to a circular letter it has been decided to restrict the scope of the papers to secure more detailed discussion. W. F. Keisel, Jr., assistant mechanical engineer, Pennsylvania Railroad, has been asked to prepare a paper on All Steel Box Cars; and R. W. Burnett, M. C. B., Canadian Pacific, on Steel Underframe Box Cars. E. G. Chenoweth (Rock Island Lines), R. B. Kendig (New York Central Lines), and B. D. Lockwood, chief engineer, Pressed Steel Car Company, Pittsburgh, Pa., have been asked to prepare written discussions on the former paper; and G. W. Rink (C. of N. J.), O. C. Cromwell (B. & O.), and A. Christensen, chief engineer, Standard Steel Car Company, Pittsburgh, Pa., have been asked to prepare written discussions on the latter.

Pennsylvania Industrial Welfare Efficiency Convention.—The Pennsylvania Industrial Welfare and Efficiency Convention will be held in the capitol at Harrisburg, Pa., October 28-30. The convention has been called by the Hon. John Price Jackson, commissioner of labor and industry, and will consist of rep-

it was written, was in active railroad service for about 64 years, and until a few weeks ago. The death of Mr. Cook is announced in another column of this paper.

In a letter to a friend in Philadelphia, written nine years ago, Mr. Cook explained that the reason the Baldwin letter had remained in his possession, was that one other man of a party of five presented his letter to the prospective employer and that

representatives of industrial establishments, engineers, contractors and other employers of labor doing business in Pennsylvania and representatives of labor, and heads of the various state departments coming in contact with engineering and industrial affairs of the state. The exhibit to be held in connection with the convention will be of a general engineering nature to appeal to the type of delegates attending the convention. The price for floor space will be 40 cents per sq. ft., including the standard booth, decorations, signs and reasonable amount of electric, steam, or compressed air power. These exhibits will be held in the building of the Harrisburg Railways Company, where about 26,000 sq. ft. of concrete floor space will be available. J. V. W. Reynders, vice-president of the Pennsylvania Steel Company, Steelton, Pa., is chairman of the exhibit committee.

Railway Fire Protection Association.—The proposal to establish an association for the purpose indicated by the foregoing title, which was made public some months since has now so far taken shape that a meeting for organization is to be held at Hotel Sherman, Chicago, October 7 and 8 next. Eight instructive addresses are already on the program, as follows: Charles N. Rambo, superintendent of the Mutual Fire, Marine & Inland Insurance Company, on Railroad Fires; A. D. Brooks, Illinois Central, on "Spark Hazard"; B. W. Dunn, of the Bureau of Explosives, on Handling of Explosives; N. S. Dunlop, of the Canadian Pacific, on "Causes of Fire"; Anson Murphy, Alabama Great Southern, "Construction of Buildings"; B. S. Mace, Baltimore & Ohio, on "Fire Organization," and P. Hevener, Rock Island, on "How a Locomotive May be Used to Extinguish a Fire."

W. H. Merrill, manager of the Underwriters' Laboratories, Chicago, will make some tests for the benefit of the members of the association, plans having been made for a visit to the laboratories Tuesday afternoon.

The secretary of the Committee on Organization is C. B. Edwards, fire insurance agent of the Mobile & Ohio, Mobile, Ala. Most of the members of the committee come from railroads in the southern states, but they desire to enlist the interest of all railroads; and, indeed, they have already received such assurance that they feel confident of success.

The following list gives names of secretaries, dates of next or regular meetings, and places of meeting of mechanical associations.

AIR BRAKE ASSOCIATION.—F. M. Nellis, 53 State St., Boston, Mass.

AMERICAN RAILWAY MASTER MECHANICS' ASSOC.—J. W. Taylor, Old Colony building, Chicago.

AMERICAN RAILWAY TOOL FOREMEN'S ASSOCIATION.—A. R. Davis, Central of Georgia, Macon, Ga.

AMERICAN SOCIETY FOR TESTING MATERIALS.—Prof. E. Marburg, University of Pennsylvania, Philadelphia, Pa.

AMERICAN SOCIETY OF MECHANICAL ENGINEERS.—Calvin W. Rice, 29 W. Thirty-ninth St., New York. Annual meeting, December 3-6, Engineering Societies' Building, New York. Railroad session, Thursday morning, December 5.

CAR FOREMEN'S ASSOCIATION OF CHICAGO.—Aaron Kline, 841 North Fifthth Court, Chicago; 2d Monday in month, Chicago.

CHIEF INTERCHANGE CAR INSPECTORS' AND CAR FOREMEN'S ASSOCIATION.—S. Skidmore, 946 Richmond street, Cincinnati, Ohio.

INTERNATIONAL RAILWAY FUEL ASSOCIATION.—C. G. Hall, 922 McCormick building, Chicago. Convention, May 18-22, 1914, Chicago.

INTERNATIONAL RAILWAY GENERAL FOREMEN'S ASSOCIATION.—William Hall, 829 W. Broadway, Winona, Minn.

INTERNATIONAL RAILROAD MASTER BLACKSMITHS' ASSOCIATION.—A. L. Woodworth, Lima, Ohio.

MASTER BOILER MAKERS' ASSOCIATION.—Harry D. Vought, 95 Liberty St., New York.

MASTER CAR BUILDERS' ASSOCIATION.—J. W. Taylor, Old Colony building, Chicago.

MASTER CAR AND LOCOMOTIVE PAINTERS' ASSOC. OF U. S. AND CANADA.—A. P. Dane, B. & M., Reading, Mass.

RAILWAY STOREKEEPERS' ASSOCIATION.—J. P. Murphy, Box C, Collinwood, Ohio.

TRAVELING ENGINEERS' ASSOCIATION.—W. O. Thompson, N. Y. C. & H. R., East Buffalo, N. Y.

PERSONALS

It is our desire to make these columns cover as completely as possible all the changes that take place in the mechanical departments of the railways of this country, and we shall greatly appreciate any assistance that our readers may give us in helping to bring this about.

GENERAL

G. M. CROWNOVER, whose appointment as superintendent of motive power of the Chicago Great Western, with headquarters at Oelwein, Iowa, was announced in the September issue, was

born September 26, 1863, at McVeytown, Pa. He graduated from the high school at Hampton, Iowa, and began railway work April 1, 1881, with the Illinois Central at Waterloo, Iowa, as machinist apprentice. After serving an apprenticeship of four years he worked two years as journeyman machinist, and in April, 1887, was made roundhouse foreman at Clinton, Ill. He remained in that position for five years, when he was transferred to Waterloo as machine shop foreman, and in October, 1896, he was promoted to general foreman in charge of the Waterloo shops. In December, 1900, he was made division foreman at Fort Dodge, Iowa, and in April, 1902, again returned to Waterloo in charge of the new shops as general foreman. Mr. Crownover was made master mechanic at Freeport in November, 1902, and two years later was transferred to Chicago as shop superintendent in charge of the Burnside shops. He left the Illinois Central in December, 1909, to become master mechanic of the Chicago Great Western at Oelwein, Iowa, which position he held until September 1, when he was promoted to superintendent of motive power, as above noted.

GEORGE A. HULL, acting assistant mechanical engineer of the Rock Island Lines, has been appointed assistant mechanical engineer, with office at Silvis, Ill., succeeding G. W. Lillie, promoted.

G. W. LILLIE, acting mechanical superintendent of the second district of the Rock Island Lines at Topeka, Kan., has been appointed mechanical superintendent at that point, succeeding C. M. Taylor, deceased.

GEORGE W. ROBB, master mechanic of the Grand Trunk Pacific, at Transcona, Man., has been appointed superintendent of motive power, with headquarters at Transcona, and his former position has been abolished.

C. J. STEWART, master mechanic of the New York, New Haven & Hartford, at South Boston, Mass., has been appointed assistant mechanical superintendent, with office at New Haven, Conn., succeeding H. C. Oviatt, promoted.

MASTER MECHANICS AND ROAD FOREMEN OF ENGINES

B. W. ALLING, master mechanic of the Old Colony division of the New York, New Haven & Hartford at Taunton, Mass., has been appointed master mechanic of the Shore Line division,



G. M. Crownover.

with office at New Haven, Conn., succeeding W. F. Clarkson, resigned.

W. F. BEARDSLEY, master mechanic of the Pennsylvania Lines West of Pittsburgh, at Crestline, Ohio, was retired on September 1 under the pension rule of the company. The position of master mechanic of the Missouri, Kansas & Texas, at Sedalia, Mo., heretofore held by C. P. Letts, is abolished and the duties of that office will be assumed by W. Rothmeyer, road foreman of engines at that place.

J. H. DALEY, road foreman of engines of the Shore Line division of the New York, New Haven & Hartford, has been appointed master mechanic of the Old Colony division, with office at Taunton, Mass., succeeding E. W. Alling, transferred.

J. McCABE, master mechanic of the New York, New Haven & Hartford at Harlem River, N. Y., has been appointed master mechanic of the New York division, with office at Harlem River.

G. A. MORIARTY, master mechanic of the New York, New Haven & Hartford at Providence, R. I., has been appointed master mechanic of the same road at South Boston, Mass., succeeding C. J. Stewart, promoted.

F. W. NELSON, general road foreman of engines of the New York, New Haven & Hartford, has been appointed master mechanic of the Western division, with office at Waterbury, Conn., succeeding C. H. Reid, transferred.

C. H. REID, master mechanic of the Western division of the New York, New Haven & Hartford at Waterbury, Conn., has been appointed master mechanic of the Providence division, with office at Providence, R. I.

J. H. WATTERS, assistant master mechanic of the Georgia Railroad, at Augusta, Ga., has been appointed master mechanic, with headquarters at Augusta, succeeding John S. Cook, deceased.

He was born September 12, 1851, at Rome, Ga., and was educated in the high school of his native town. He began railway work in 1868 as a locomotive fireman on the Selma, Rome & Dalton, now a part of the Southern, and from 1871 to 1885 was locomotive engineer on the same road. He was subsequently master mechanic of the Anniston & Atlantic, and then until January, 1892, was master of transportation and master mechanic of the same road and of the Anniston & Cincinnati. Both of these roads are now a part of the Louisville &



J. H. Watters.

Nashville. In January, 1892, he was appointed master mechanic of the Louisville division of the Louisville & Nashville, and in October, 1901, went to the Georgia Railroad as assistant master mechanic, which position he held at the time of his recent appointment as master mechanic of the same road, as above noted.

CAR DEPARTMENT

E. L. BESHLEK has been appointed car foreman of the Atchison, Topeka & Santa Fe at Cleburne, Tex., succeeding G. C. Cox.

A. COPONY has been appointed master car builder of the

Western lines of the Grand Trunk, with headquarters at Port Huron, Mich., succeeding J. L. Hodgson.

JOHN L. HODGSON, master car builder of the Grand Trunk at Port Huron, Mich., has been appointed superintendent of the car department of the Grand Trunk Pacific, with headquarters at Transcona, Man. He was born in 1858 at Simcoe, Ont., and entered the service of the Grand Trunk at Brantford, Ont. In 1884 he was transferred to Toronto, as car foreman, and since 1897 has been master car builder of the same road at Port Huron.

T. W. KENDALL has been appointed car foreman of the Atchison, Topeka & Santa Fe at Newton, Kan., succeeding G. D. Wood, promoted.

W. E. PATTERSON has been appointed foreman of the car department of the Atchison, Topeka & Santa Fe at Cleburne, Tex., succeeding G. S. Weiler, promoted.

JAMES REED has been appointed assistant division master car builder of the Lake Shore & Michigan Southern at Englewood, Ill., succeeding George Thomson, promoted.

R. W. SCHULZE, who recently resigned as general car foreman of the Gulf, Colorado & Santa Fe, at Cleburne, Tex., has been appointed superintendent of the car department of the St. Louis & San Francisco, with headquarters at Springfield, Mo.

I. S. DOWNING has been appointed master car builder of the & Michigan Southern at Englewood, Ill., has been appointed master car builder of that road, with headquarters at Collinwood, Ohio, succeeding I. S. Downing, resigned.

I. S. DOWNING has been appointed master car builder of the Cleveland, Cincinnati, Chicago & St. Louis, with headquarters at Indianapolis, Ind. Mr. Downing was born at Bentonville, Ohio,

and began railway work in April, 1886, as a car cleaner for the Flint & Pere Marquette. From February, 1890, to February, 1892, he was foreman of passenger work. He then went to the Lake Shore & Michigan Southern as a car cleaner at Toledo, Ohio, and from April, 1893, to March, 1895, was an inspector at Air Line Junction, Ohio. On the latter date he was made yard foreman at that point, and in November, 1899, was advanced to general foreman at the same place. Five years later Mr. Downing was appointed master car

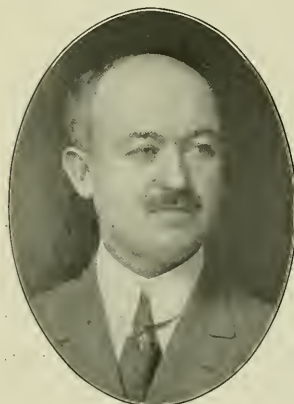

I. S. Downing.

builder of that road at Englewood, Ill., and in August, 1906, he was transferred to Collinwood, Ohio, as master car builder. He held the latter position until September 1, when he became master car builder of the Cleveland, Cincinnati, Chicago & St. Louis, as above mentioned.

GEORGE THOMSON, assistant division master car builder of the Lake Shore & Michigan Southern at Englewood, Ill., has been appointed division master car builder at that point, succeeding J. W. Senger, promoted.

G. S. WEILER has been appointed acting general car foreman of the Atchison, Topeka & Santa Fe at Cleburne, Tex., succeeding R. W. Schulze, resigned.

GEORGE D. WOOD has been appointed general car foreman of the Atchison, Topeka & Santa Fe at Shopton, Iowa, succeeding J. W. Matthey.

SHOP AND ENGINE HOUSE

C. E. BROOKS has been appointed locomotive foreman of the Grand Trunk Pacific at Edmonton, Alta., succeeding W. W. Yeager, transferred.

T. W. COE has been appointed superintendent of shops of the Lake Shore & Michigan Southern at Elkhart, Ind., succeeding W. J. Fraudiener, resigned.

W. J. FRAUDIENER, superintendent of shops of the Lake Shore & Michigan Southern at Elkhart, Ind., has been appointed general inspector, locomotive department, in the office of superintendent of motive power of the Cleveland, Cincinnati, Chicago & St. Louis at Indianapolis, Ind.

B. E. HATSEL, air brake room foreman of the Atchison, Topeka & Santa Fe at Cleburne, Tex., has been appointed machine foreman at that point.

D. W. HAY has been appointed locomotive foreman of the Grand Trunk Pacific at Redditt, Ont., succeeding A. J. Roberts, transferred.

W. F. HOWARD, machine foreman of the Atchison, Topeka & Santa Fe, at Cleburne, Tex., has been appointed general foreman of the same road at that point.

A. H. MAHAN has been appointed locomotive foreman of the Grand Trunk Pacific at McBride, B. C., succeeding A. McTavish, assigned to other duties.

A. J. ROBERTS has been appointed locomotive foreman of the Grand Trunk Pacific at Edson, Alta., succeeding A. H. Mahan, transferred.

CHARLES L. SHANK has been appointed roundhouse foreman of the Atchison, Topeka & Santa Fe at Strong City, Kan., succeeding G. F. Tier.

W. W. YEAGER has been appointed locomotive foreman of the Grand Trunk Pacific at Wainwright, Alta., succeeding C. E. Brooks, transferred.

PURCHASING AND STOREKEEPING

D. D. CAIN has been appointed general storekeeper of the Seaboard Air Line at Portsmouth, Va., succeeding W. M. Portlock, promoted.

D. DOWNING, general storekeeper of the Wheeling & Lake Erie, at Ironville, Ohio, has been appointed general storekeeper of the Chicago & Alton, with headquarters at Bloomington, Ill., succeeding C. B. Foster, resigned.

W. M. PORTLOCK, general storekeeper of the Seaboard Air Line at Portsmouth, Va., has been appointed assistant to the general purchasing agent.

R. W. SIMPSON has been appointed general fuel agent of the Intercolonial and the Prince Edward Island, with headquarters at Moncton, N. B.

WILLIAM D. STOKES has been appointed general storekeeper of the Central of Georgia, with office at Savannah, Ga., succeeding James L. Bennett, promoted.

OBITUARY

C. M. TAYLOR, mechanical superintendent, second district of the Chicago, Rock Island & Pacific, at Topeka, Kan., who was granted leave of absence on account of illness in July, died on September 3, at Colorado Springs, Colo. He was born on May 25, 1862, and had been with the Rock Island since December 15, 1906, as district master mechanic and mechanical superintendent, and was previously mechanical superintendent of the

Western Grand division of the Atchison, Topeka & Santa Fe at La Junta, Colo.

JOHN S. COOK, master mechanic of the Georgia Railroad, at Augusta, Ga., died on August 28, in Johns Hopkins Hospital, Baltimore, Md. Mr. Cook had been in railroad service sixty-four years, and it is probably safe to say that previous to his last illness he was, in point of years of service, the oldest railroad officer in the United States. He was born on October 5, 1827, at Brooklyn, N. Y., and began railway work in April, 1849, as machinist in the shops of the Central Railroad at Savannah, Ga. Later he was machinist in the shops of the Georgia Railroad at Augusta. From 1850 to 1853 he was a locomotive engineer on that road; then from 1854 to 1878, about twenty-five years, he was foreman of shops. On



J. S. Cook.

the election of General E. P. Alexander to the presidency of the Georgia Railroad, in May, 1878, he was made master mechanic, and had held that position ever since. Mr. Cook was well known in the railroad mechanical world and was highly respected. Before entering railroad service he served an apprenticeship at the Baldwin Locomotive Works, and on leaving the Baldwin shops in 1849, he received a testimonial from Matthias W. Baldwin.

WILLIAM B. TURNER, for 48 years foreman of the car shops of the Wabash Railroad at Toledo, Ohio, died recently at his home in Toledo, aged 79 years.

NEW SHOPS

McADAM JUNCTION, N. B.—The new shops now being built by the Canadian Pacific at McAdam Junction include an erecting shop 70 ft. x 129 ft., containing six engine pits, and a machine shop 80 ft. x 129 ft. Both structures are to be of concrete and brick, with steel frames. The work, which will cost over \$100,000, is already well advanced.

RAILWAY TIES IN BELGIUM.—Owing to the scarcity of wood in Belgium the Belgian railways are obliged to import nine-tenths of the timber used for ties, mostly from Russia.—*The Engineer*.

WRECK STATISTICS FOR 1912.—The statistical summary of vessels totally lost, broken up, condemned, etc., recently published by *Lloyd's Register*, shows that during 1912 the gross reduction in the effective mercantile marine of the world amounted to 720 vessels of 748,965 tons, excluding all vessels of less than 100 tons.—*The Engineer*.

GRENCHEMBERG TUNNEL.—The Grenchenberg Tunnel, which when constructed will be over four miles long, and will penetrate the Jura Range, has been the scene of labor trouble. The tunnel contractors are German, the engineers Swiss, the capital French, and the workmen Italian. Twice work has been at a standstill and all workmen paid off.—*The Practical Engineer*.

SUPPLY TRADE NOTES

Charles N. Replogle, superintendent of the Cambria Steel Company, has been made works manager of the Ralston Steel Car Company, New York, with office in Columbus, Ohio.

Judge Carpenter, of the federal court at Chicago, has ordered the Central Trust Company, receiver, to ask bids for the sale of the Union Car & Equipment Company, West Pullman, Ill., which recently filed a petition in bankruptcy.

C. H. McCormick, for a number of years connected with the mechanical department of the Michigan Central, has been made district manager of the Standard Heat & Ventilation Company, Inc., New York, with office in Cincinnati, Ohio.

M. F. Ryan, who has been connected with the Pittsburgh Spring & Steel Company, Pittsburgh, Pa., for the past ten years, has been appointed general western sales agent of that company, with office in Chicago, in place of L. C. Noble, deceased.

W. H. Hooper, assistant to the president of the Chicago Car Heating Company, with office in Chicago, has resigned to become a vice-president of the Standard Heat & Ventilation Company, New York, with headquarters in the Peoples Gas building, Chicago.

Beaudry & Company, Inc., Boston, Mass., have perfected a direct connected motor drive for its Beaudry Champion and Beaudry Peerless power hammers, and is now arranging to carry a complete stock of motor driven hammers in addition to belt-driven hammers.

The Beaver Dam Malleable Iron Company, Beaver Dam, Wis., on Tuesday, September 16, filed a voluntary petition in bankruptcy in the federal court at Milwaukee. Liabilities are placed at \$500,000, and assets at \$650,000. Ernest E. Smythe, of Milwaukee, was appointed receiver.

The Philadelphia Steel & Forge Company, Tacony, Philadelphia, Pa., has just installed in the rolling mill department of its Tacony works a new power plant which will increase the output of finished bars 2,000 tons a month. This company has also installed a heat-treating plant and is specializing on high-grade steels for locomotives, machine tools, etc.

The Taylor-Wharton Iron & Steel Company, High Bridge, N. J., has opened a branch office in the Candler building, Atlanta, Ga., in charge of H. F. McDermott, as engineer and district sales manager. This office will also be a branch office of Wm. Wharton, Jr., & Co., Inc., Philadelphia, Pa.; the Tioga Steel & Iron Company, Philadelphia, and the Philadelphia Roll & Machine Company, Philadelphia.

G. S. Turner, for the last four years connected with the Crane Company, has been made second vice-president of the Chas. R. Long, Jr., Company, manufacturers of railway paints. Mr. Turner will also represent Harry Vissering & Co., having been made second vice-president of that company. His office will be at 20 West Jackson boulevard, Chicago, Ill. Mr. Turner was for more than ten years associated with the Southern Railway in the capacity of general foreman, superintendent of shops and general inspector of equipment.

A. D. Wyckoff, efficiency expert of S. F. Bowser & Co., Fort Wayne, Ind., with office at Pittsburgh, Pa., has been made eastern railroad representative of that company, succeeding Frank T. Hyndman, who recently resigned to become superintendent of motive power and cars of the Wheeling & Lake Erie. Mr. Wyckoff has been with the Bowser company for a number of years, and has had a wide experience in designing equipment for the handling and storage of oils, as well as oil filtering and circulating systems for railroads and manufacturing institutions.

The Hess Steel Casting Company, Witherspoon building,

Philadelphia, Pa., has finally perfected the manufacture of the purest wrought iron material into castings. This produces castings of great density and uniformity which are particularly adapted for parts of electric equipment where high magnetic permeability is essential and also for purposes where castings have to withstand corrosion, high pressure and high temperatures associated with excessive cooling and heating, such as case hardening boxes, etc. Any required alloy can be introduced in this same raw material, producing excessively high tensile strength or hardening qualities as required.

Announcement is made that the entire capital stock of the Putnam Machine Company, Fitchburg, Mass., has just been purchased by Manning, Maxwell & Moore, Inc., New York. The Putnam Machine Company is the pioneer machine tool manufacturer of the country, and was started in 1836 by Salmon W. and John Putnam. The plant now covers about fourteen acres. S. W. Putnam, son of the founder, and his son, S. W. Putnam, 3d, will retain their connection with the company, which will retain its name and be operated on its own identity. The following are new directors of the company: Salmon W. Putnam, Alfred J. Babcock, John N. Derby, Percy M. Brotherhood and George D. Branston.

Charles W. Allen, a vice-president and a director of the L. J. Bordo Company, Philadelphia, Pa., has been made manager of the railway department of the Reading-Bayonne Steel Castings Company, with office in Reading, Pa. Mr. Allen received his education in the Tamaqua schools and served an apprenticeship as machinist in the Tamaqua shops of the Philadelphia & Reading. After several years he was made engine house foreman at Milton, where he remained six years. In 1904 he was transferred to Reading as master mechanic of the Reading and Harrisburg division. He resigned this position on January 1, 1907, to become railroad representative of the L. J. Bordo Company. In 1908 he was made a vice-president and director of that company, which position he retained until his appointment as manager of the railway department of the Reading-Bayonne Steel Castings Company, as mentioned above.

Ernest F. Slocum, formerly vice-president of the Safety Car Heating and Lighting Company, New York, has returned to that company as assistant to the president, a position which has not

been filled for some time. Mr. Slocum was born in Newark, N. J., in 1870, and spent his boyhood days in St. Louis, Mo., where he received his early education. He started his business career as a journalist, and was connected with the *New York Herald* and the *Commercial Advertiser*, also of New York. Later he was made director and manager of the *Daily Advertiser* of Newark, N. J. In 1895 he went to the Safety Car Heating & Lighting Company, accepting a position offered him by the late Colonel A. W. Soper. In May, 1907,

he was made a vice-president of that company, having charge of sales. In October of that year he suffered a nervous breakdown and has been out of business up to the time of his appointment as assistant to the president of the Safety company, as mentioned above.



Ernest F. Slocum.

CATALOGS

SWITCHING LOCOMOTIVES.—Bulletin No. 1015 from the American Locomotive Company, New York, includes tables of dimensions of twenty-four recent designs of switching locomotives of the 0-6-0, 0-8-0 and 0-10-0 types. Most of these engines are also illustrated by means of photographs.

MOTORS.—A new bulletin from the General Electric Company describes its adjustable speed, direct current motors. These are especially designed to meet the requirements of individual drive for machine tools. The bulletin illustrates these motors and their application in considerable detail and contains various curves showing the horse power output at various speeds.

RAILROAD ELECTRIFICATION.—The Westinghouse Electric & Manufacturing Company, Pittsburgh, Pa., is issuing two leaflets covering the electrification of the New York extension of the Pennsylvania and that of the New York, New Haven & Hartford. These leaflets cover the salient points of both systems and give a description of the apparatus used. A map showing the territory covered by both of the electrified systems is included.

STEEL PLATES AND BARS.—A leaflet from the Carbon Steel Company, Thirty-second street, Pittsburgh, Pa., briefly lists the sizes and forms of plates and bars which it is prepared to furnish. Some of the special steels manufactured by this company are briefly described and their special uses mentioned. A table giving the various uses of steels and the recommendations of this company for the quality most suitable for each, occupies several pages.

STARTERS FOR A. C. MOTORS.—A detailed description of an automatic starter for alternating current motors is found in the bulletin just issued by the General Electric Company, Schenectady, N. Y. Automatic control panels for squirrel cage induction motors and slip ring induction motors, as well as float switches for remote control of automatic starting panels or rheostats and pressure governor panels, also for remote control, are described in this bulletin.

PUNCHES AND SHEARS.—The Oeking solid steel frame combination machines will cut a plate, cut and miter an angle and punch without the necessity of changing tools, and all on the same machine. These machines are illustrated together with various other types of smaller size for regular and special uses. The catalog is issued by the Wiener Machinery Company, 50 Church street, New York.

MALLEABLE CASTINGS FOR AIR BRAKE EQUIPMENT.—Catalog No. 22, National Malleable Castings Company, Cleveland, Ohio, is designed for use in ordering brake levers, brake lever pins, brake lever connecting rods, dead lever guides, hose clamps and other castings used in connection with air brake equipment. In each case the part is shown by a photographic reproduction and a line drawing with lettered dimensions, and the accompanying table gives the ordering number and sizes.

DRAWING INSTRUMENTS AND MATERIALS.—A very complete illustrated catalog and price list of drawing and tracing papers, blue printing paper and equipment, drawing instruments and materials, surveying instruments and accessories, etc., is being issued by Kolesch & Company, 138 Fulton street, New York. This book is complete in every particular and lists every appliance or apparatus that is used by a draftsman or surveyor. It contains 336 pages and is fully indexed.

ELECTRIC WELDING.—A very interesting and instructive discussion of the electric arc for welding will be found in Bulletin No. 513-C from the C. & C. Electric & Manufacturing Company, Garwood, N. J. This bulletin discusses the advantages of this form of welding and where it can be used, the method of producing the arc, description of the apparatus needed and how it operates, the kind of welding materials to use, etc. A large

number of illustrations of locomotive and machine tool repairs made in this manner are included.

WRECKING HOOK.—A leaflet from the National Malleable Castings Company, Cleveland, Ohio, illustrates and briefly describes the Goodman Wrecking Hook which has proven its value by constant use for a number of years and on many of the larger railway systems. This hook can be quickly attached to any design of M. C. B. Coupler, having either solid or slotted knuckle, and is made amply strong for its intended uses while at the same time the design has been so carefully worked out that it is light enough to be readily handled by one man. It is made of high-grade open-hearth steel.

RAILWAY EQUIPMENT.—The Orenstein-Arthur Koppel Company, Koppel, Pa., have had over 40 years' experience in the building and developing of industrial and narrow-gage railways of every description in various parts of the world. This company is prepared to study and make recommendations for individual transportation problems of all kinds. A comprehensive catalog is being sent out illustrating and briefly describing the large variety of products which it is prepared to furnish. These comprise rails, portable track, switches, turntables, cars, steam and electric locomotives, etc.

BAR IRON, BOLTS AND NUTS.—The Kansas City Bolt & Nut Company, Kansas City, Mo., has rolling mills which have an annual capacity of 40,000 tons. Its products are merchant bar iron in various sizes and forms, as well as bolts and nuts which are made from the iron coming from its own mills. Catalog No. 813 fully lists all of these products, showing track bolts, machine bolts, blank bolts, carriage bolts, lag screws, etc. Prices are included in most cases. This company is also equipped for producing forgings in large quantities, and the catalog illustrates and mentions a number of railroad forgings that it is prepared to furnish!

GALVANIZING EQUIPMENT.—A pamphlet issued by the Metal Treating & Equipment Company, United States Rubber Company Building, New York, contains a brief treatise on the protection of iron and steel against corrosion. It discusses the causes of corrosion and the methods that are generally accepted and used for its prevention. It describes how the galvanizing or other protecting means act and the difficulties introduced in their use. A description is included of the equipment furnished by this company for galvanizing and instructions on how to figure for the required size of equipment that may be desired for a special purpose.

RAILWAY MOTOR CARS.—Motor cars in several sizes and arrangements are illustrated in a catalog being issued by the Chicago Pneumatic Tool Company, Fisher Building, Chicago. The catalog contains some actual figures on the cost of operating these cars both for section and inspection work. An electric signal bonding outfit consisting of a single cylinder, 4 cycle gasolene engine, direct connected to 1¼ K. W. generator wound for 125 volts, all of which is mounted on a welded steel frame and carried on a four-wheel truck is also described. This is arranged to allow the use of electric drills in the drilling of holes for signal bonding on steam railroads.

STEEL BARS, WIRE AND FORGINGS.—In its latest catalog the Philadelphia Steel & Forge Company, 50 Church street, New York, announced that it has reconstructed its mills and shops, installed the most modern machinery and equipment to meet the most exacting requirements, and that it is prepared to manufacture all grades of crucible and open hearth steels, both carbon and different alloys in bars, strips, forgings and forged and rolled shapes. The company makes particular mention of its specialty department, which is devoted exclusively to high-grade steel, such as tool steel, automobile steels, alloy steels, etc. The catalog lists and briefly describes the special characteristics of all of these products and is illustrated by photographs of the new plant.

Railway Age Gazette

MECHANICAL EDITION

INCLUDING THE
AMERICAN ENGINEER

PUBLISHED ON THE FIRST THURSDAY OF EVERY MONTH BY THE
SIMMONS-BOARDMAN PUBLISHING COMPANY,
WOOLWORTH BLDG., NEW YORK, N. Y.

CHICAGO: Transportation Bldg. CLEVELAND: Citizen's Bldg.
LONDON: Queen Anne's Chambers, Westminster.

EDWARD A. SIMMONS, *President.* L. B. SHERMAN, *Vice-President.*
HENRY LEE, *Secretary.*
The address of the company is the address of the officers.

ROY V. WRIGHT, *Editor.* R. E. THAYER, *Associate Editor.*
E. A. AVERILL, *Managing Editor.* A. C. LOUDON, *Associate Editor.*
GEORGE L. FOWLER, *Associate Editor.*

Subscriptions, including the eight daily editions of the *Railway Age Gazette* published in June in connection with the annual conventions of the Master Car Builders' and American Railway Master Mechanics' associations, payable in advance and postage free:

United States, Canada and Mexico.....	\$2.00 a year
Foreign Countries (excepting daily editions).....	3.00 a year
Single Copy	20 cents

Entered at the Post Office at New York, N. Y., as mail matter of the second class.

WE GUARANTEE, that of this issue 4,300 copies were printed; that of those 4,300 copies, 3,835 were mailed to regular paid subscribers and 100 were provided for center and news companies' sales; that the total copies printed this year to date were 50,576—an average of 4,988 copies a month.

VOLUME 87. NOVEMBER, 1913. NUMBER 11.

CONTENTS

EDITORIALS:	
Engine House for Mallets.....	577
Locomotive Tool Equipment.....	577
College Men and the Railroads.....	577
College Men and the Railroads.....	578
The Diesel Locomotive.....	578
Organization of Engine Houses.....	578
Air Brake Hose.....	579
New Books.....	579
COMMUNICATIONS:	
College Men and the Railroads.....	580
Turning Four-Bar Crosshead Wrist Pins.....	582
GENERAL:	
4-8 Type for Missouri Pacific.....	583
Design of Locomotive Grates.....	585
Result of Letter Ballot of the M. M. Association.....	588
Locomotive Fire Extinguisher.....	588
Locomotive Headlight Laws.....	588
Sulzer-Diesel Locomotive.....	589
Cumberland Terminal of the B. & O.....	591
The Use of Sand on Locomotives.....	594
SHOP PRACTICE:	
Machine Shop Kinks.....	595
Packing Spool Rack for Injector Benches.....	596
Engine House Organization and Operation.....	597
Scrapping Locomotive Boilers with the Oxy-Acetylene Torch.....	602
Machine for Turning Ball Joints.....	603
Installation and Maintenance of Electric Headlight Equipment.....	603
Air Pump Steam Head Repairs.....	605
Boiler Tube Rack.....	606
LABOR DEPARTMENT:	
Tests of Passenger Car Lighting.....	607
Repairing Ballast Cars.....	608
Wabash 50-Foot Steel Postal Car.....	609
Proportions and Insulation of Refrigerator Cars.....	613
Result of M. C. B. Letter Ballot.....	615
Special Baggage Car for Scenery.....	615
Air Brake Hose Label.....	618
Proposed New Subway Car.....	618
NEW DEVICES:	
Mud Ring and Flue Sheet Drill.....	619
Radial Drill of High Capacity.....	619
Pre-Cooling Refrigerator Fruit Cars.....	620
The Standard Locomotive Stoker.....	621
Mahr Oil Burner.....	624
Tool for Repairing Triple Valves.....	625
Landis Stationary Pipe Die Head.....	626
New Power Reverse Gear.....	627
Fire Heaters.....	628
Double Spindle Grinder.....	628
NEWS DEPARTMENT:	
Notes.....	629
Meetings and Conventions.....	629
Personals.....	630
New Shops.....	633
Supply Trade Notes.....	633
Catalogs.....	634

Engine House for Mallets

The engine house recently completed by the Baltimore & Ohio at Cumberland, Md., is of interest mainly because it provides for the housing of Mallet locomotives.

The number of engine houses for Mallets is increasing, although as yet it is by no means great, the Delaware & Hudson and the Norfolk & Western being among the leaders in this step; but, as one of the points urged strongly against the use of Mallets when this type of locomotive was first introduced was the difficulty of providing suitable facilities for housing and caring for such large motive power, it is worthy of note that the Mallet type has advanced to a position in the moving of railway traffic which provides an answer to the question of the economy of providing special facilities.

Locomotive Tool Equipment

It is a surprising fact that on many railways there seems to be little or no systematic attention directed to the care of locomotive tool equipment. If a locomotive stands in the engine house for a few days it is almost invariably necessary to furnish a new hammer, monkey-wrench, shovel, etc., and probably new classification lamps, all because the precaution was not taken to remove and store the tools when the engine was taken out of service. The locking of tank boxes as a remedy may be set aside as unsatisfactory if not entirely useless; no padlock will withstand more than a few blows from a hammer, and in the smoke and steam of an engine house it does not require a thief of any special attainments to make a clear get-away with the contents of a tank box. A frequent procedure is to leave a set of worn-out tools in place of the good ones removed, and if anything this is more aggravating than a mere theft. If the engineman next assigned to the locomotive is good natured enough to start his trip with such equipment he may find himself in trouble on the road, and to withdraw a set of new tools from his little stock, achieved after many blue penciled requisitions, and to receive in exchange perhaps a useless monkey-wrench and two or three battered oil cans, always causes a tearing at the heart-strings of the foreman. The remedy for these difficulties—the provision of an adequate system of checking and caring for such equipment—seems so simple and may be productive of so much saving that it is extremely difficult to understand why so few roads make any real effort along these lines.

College Men and the Railroads

The communication of I. I. W. and the editorial in the October issue of this journal have resulted in a number of communications which clearly indicate the interest that exists in, and the difficulty of the problem. At our request a number of the more prominent educators and apprentice supervisors on railroads have furnished us with their opinions and suggestions. Space would allow the insertion of but two in this issue. Others will be printed in later numbers. Both Messrs. Humphreys and Buell indicate solutions for some of the difficulties. The latter discusses what is probably the most important feature in the whole problem, which is the lack of understanding of so great a proportion of the college men who come to railroads of what they actually want to do, or of the difficulties that lie in the path to any goal in the railroad service which they may decide they wish to reach. Mr. Humphreys points out a fault which undoubtedly does exist in a great many cases, which is the failure of the railroads to conduct their apprenticeship courses efficiently so that a college man is permitted to supplement his previous training in engineering. He believes that an adequate apprenticeship railroad course for engineering graduates could be covered in two years if these men are required to work at high pressure. We will be glad to have the opinion of college men who have made a suc-

cess of railroading showing how, in their opinion, either the college courses or the railroad method of handling the graduate could be improved. Also from those who have left the railroad service, outlining the conditions which they found to be unsatisfactory.

Car Department Competition

At the beginning of this year a prize competition was opened for articles relating to the work or interests of the car department. The interest taken was gratifying and the responses were most satisfactory, but after carefully studying the articles submitted, it appeared that there was still a large proportion of the more important work, in connection with the design and maintenance of cars, that was not covered by any of them. It is therefore decided to open another competition along the same lines and a prize of \$50 is now offered for the best article of this kind which reaches this office before February 1, 1914. Articles considering any subject that is of general or special interest to the car department will be considered.

In order to give a suggestion of a few of the subjects that might be selected for treatment the following can be mentioned: Methods employed for bringing weak cars up to a condition of strength to safely stand the use and abuse they will receive in service; organization and equipment for the best handling of bad order cars in yards; how to avoid leaky roofs on wooden superstructure box cars; features of design that lead to a reduction of claims for lost or damaged freight; ventilation and heating of steel passenger equipment; analysis of the stresses that are set up by the shocks of severe hump yard service in the important members of the car framing and attachments; proposed design of a shop for making heavy repairs on all-steel equipment of different classes, including freight and passenger, showing the required equipment and its best arrangement and an outline of the organization of the forces; the labor situation in a repair yard. These are simply suggestions of a few of the many subjects that can be selected, and contestants are in no way restricted in their choice of subjects, except that they must refer to something of interest to the car department. Three months' time is allowed on this competition, which should be ample to permit a thorough investigation and study of all the conditions of any subject selected by any contestant for his article. Any further information desired in connection with this competition will be gladly supplied. Articles considered suitable for publication which do not win the prize will be paid for at our regular space rates.

The Diesel Locomotive

A passenger locomotive of moderate size driven by a Diesel engine has recently been built in Switzerland, and is now in experimental service in Germany. The arrangement, as will be seen by reference to the description given in this issue, provides for a direct drive between the engine and the wheels. So far as we know, this is the first instance where an internal combustion engine has been directly connected to the wheels of the vehicle which it drives. This arrangement would seem to have a number of serious disadvantages. In the first place it makes it necessary to have a reversible engine which introduces further complications in a machine which, at the best, is far from being simple. Furthermore, it requires the compressing and storing of air at high pressures for giving the required starting torque. In this case a 250 horse power Diesel engine with a large, three stage air compressor, together with a number of reservoirs capable of holding high pressures, have been included, entirely for the purpose of starting the locomotive. Air pressure is used for running the locomotive until it attains a speed of between five and six miles an hour.

It has been estimated that fully 75 per cent. of the cost of fuel will be saved by using a Diesel engine as the source of power

for a locomotive. This comparison is based on the cost of fuel in Europe. In view of this, it is to be expected that every effort will be made to adapt this type of engine to a locomotive, but it does not seem that the present arrangement is the most practicable. The difficulties of designing a satisfactory clutch to carry the full power of a large locomotive will be readily appreciated, and even if one was built, the necessity of reversing the engine is still present. A. P. Chalkley, in his book, "Diesel Engines for Land and Marine Work" (1912), states that, "at the present time it is hardly unfair to say that the Diesel motor is too delicate an engine to stand the great strain that would be put on it under working conditions when used for locomotive driving, and that its method of operation should, as far as possible, be the same as with ordinary engines. This, apart from other considerations, such as greater starting torque, and more easy and economical variation in speed of running, brings up naturally to the question of the employment of electricity as an intermediary between the engine and the driving wheels of a locomotive, and it is upon these lines that we may expect more immediate development." He suggests further that it is probable the Diesel electric locomotive, which may be expected in the future, will be of a type in which alternating current dynamos and motors will be employed. This would seem to be a much more practicable arrangement for taking advantage of the economy offered by the Diesel engine for the hauling of trains, and it is probable that a construction of this kind will make its appearance in the not distant future.

Organization of Engine Houses

An individual paper by Walter Smith presented at the last convention of the General Foremen's Association, reviewed the subject of engine house organization and operation in a very thorough and helpful manner. Unfortunately there was not time for any discussion on this paper and the subject will be brought up again at the next convention. Not the least important part of Mr. Smith's comment is the section on organization. Proper organization, suited to the conditions and the local requirements, has proved of great value for the efficient operation of divisions, departments and large shops, and there is no reason to expect that it would be of less value in such an important place as a locomotive terminal. Mr. Smith claims that it is the keynote of the whole situation and that even where all conditions are favorable and modern facilities are provided, if the organization is not on a firm basis the results obtained will be inefficient. He points out that in an efficient roundhouse organization the foreman and each workman should have his duties clearly defined and should be given to understand that he is responsible for the work he performs. It also provides for the loss or transfer of workmen or foremen and an available substitute for every important position. He claims that there is no question but that the inefficiency of many engine houses is due to the lack of supervision and that an organization to be efficient must relieve the foreman of too much detail work. The paper goes into some detail in outlining the most suitable form of organization and discussing the duties of the various men.

A few years ago at a large engine house where the organization was almost perfect, it was necessary to reduce the working force by about 50 per cent. The indications were that the slack times would be of comparatively short duration, and it was believed advisable to hold the organization intact, even though there seemed to be a great predominance of, so called, non-producers or foremen. In view of the large number of foremen and sub-foremen it was expected that the cost per engine turned would be increased, but the advantage of holding the organization together was felt to largely offset this. After settling down to the new conditions for a few months every one was surprised to find that instead of the cost per engine turned going up it was actually decreased over what it had been

with the larger force. A careful analysis of the whole matter finally led to the conclusion that the decreased cost was entirely due to more careful and thorough supervision. Each foreman now having fewer men under him and fewer locomotives to handle was enabled to give his department closer attention and, although his salary was a decidedly larger proportion of the payroll in his department than had been the case heretofore, he was able to more than offset it by more efficient work. This is but an instance of the value of so arranging the organization of a roundhouse, or any other force, that the foremen will be given ample time for thorough supervision and not be loaded down with detail work.

Air Brake Hose

Circular No. 14 of the Master Car Builders' Association gives the new specifications for air brake and signal hose, air brake gaskets, and the label for air brake hose which were adopted by special letter ballot in July of this year. The new specifications are practically those proposed by the committee at the last convention and, in many respects, are much more severe than those heretofore in force. There has been a general feeling for some time that a better grade of air brake hose was needed, although there was considerable difference of opinion as to just what form the improvements should take. The committee investigated the whole matter most carefully and the new specifications are evidence that its conclusions are in favor of a better grade of rubber and that, having this, the manufacturer should be allowed even greater freedom in his methods than heretofore. The former specifications required a three calendered tube, each calender being 1/16 in. in thickness. It is doubtful if this was actually obtained in many cases. The new specifications allow the tubes to be made either by hand or machine and contain no requirements as to number of calenders or thickness of each, although the whole tube shall not be less than 3/16 in. thick at any point.

Two entirely new tests have been added, and most of the others have been increased in severity. The porosity test is to insure that there are no minute holes in the inner tube which will allow a gradual leakage of air. For this test a hose is filled with air at 140 lbs. pressure for five minutes, and at the end of this time the rubber cover is split with a knife and the hose is submerged in water. Any distinct escape of air will be sufficient to condemn the whole lot. The other new test is one for the tensile strength of the tube and cover. This has been inserted as a check to insure the use of natural rubber, and requires that the test piece shall be pulled in a tensile machine with a test speed of 20 in. per minute. After an elongation of at least 10 in. the inner tube must have a tensile strength between 800 lbs. and 1,200 lbs. per sq. in., and the cover between 700 lbs. and 1,100 lbs. per sq. in.

It is thought by the committee that these two new tests will insure a quality of material which will meet more severe requirements in some of the other tests. The new bursting test requires a hydraulic pressure of 200 lbs., or double that previously used. Under this pressure the hose must not expand more than three-quarters of an inch in circumference. Previous tests allowed an expansion of one-quarter inch, but did not specifically state whether it was of diameter or circumference. The new tests also require a hydraulic pressure of 500 lbs. per sq. in. for 10 minutes without bursting, while the former test required a pressure of but 400 lbs. for this purpose. There was no change made in the friction test but stretching test has been increased from 8 in. to 10 in. for both the preliminary and final stretch and a new requirement that the initial set shall not be more than one-quarter inch within 30 seconds after the time of the last release has been included. After 10 minutes the new tests will not allow a permanent set of more than one-eighth inch where one-quarter inch was previously permitted. This test applies both to the tube and the cover.

While previously there was no test made of the quality of material used in the wrapping, the new specifications require the breaking of a single strand of the warp or filler which strength multiplied by the number of the warp or filler strands per inch shall not be less than 220 lbs. The new hose must be not less than four ply and some changes have been made in the variation permitted in the size. A new label was also adopted by the same special letter ballot.

Of course the new hose is going to cost more than the other and it is probable that it will be sold for about 60 cents a foot, or approximately 50 per cent. more than the average price of the hose manufactured to the old specifications. This represents a very substantial sum which the increased length of life of the hose will amply repay if it is allowed to remain in service until deterioration, due to age, makes it unsafe. Failures due to mechanical injury, which on some roads seem to be the chief cause for removal, will not be prevented by the new hose any better than they were by the old, and it is to be hoped that the increased cost will lead to greater care in the mounting of the fittings, the condition of the couplings and the proper application to the car.

J. S. Sheafe, engineer of tests of the Illinois Central, in the *Railway Age Gazette*, October 17, points out that with the better hose, deterioration will cause failure eventually, although it will have a longer life than the poorer grade, and he suggests that if a certain brand of hose is known to be able to give so many months' service, it should be removed at the end of that time. It is impracticable for car inspectors to continually examine the hose labels as they are now applied, and he recommends that large figures be vulcanized on the outside of the hose near the coupling which will show the month and year in which the hose will have reached its allowable maximum age and should be removed. With these figures easily visible the car inspector will remove the hose from service when the time has expired as he can easily discover it without effort, and there will be no opportunity for the hose to remain on a car until it is so deteriorated that bursting under train line pressure will be inevitable. This suggestion would appear to have many advantages on the side of safety.

NEW BOOKS

The Science of Burning Liquid Fuel. By W. N. Best. Illustrated. Bound in cloth. 153 pages, 6 in. x 9 in. Published by the author at 11 Broadway, New York. Price \$2.

The author has devoted much time to the study of burning fuel oil and has endeavored to make this book thoroughly practical. Analyses of oils from different localities are given and a chapter on atomization gives illustrations and descriptions of different oil burners. The systems in use for burning oil as fuel are considered, theoretically and practically, and locomotive stationary and marine applications are described. Considerable space is devoted to the equipment for ovens and furnaces. There are a large number of illustrations.

Safety First. By George Bradshaw, Safety Engineer. Illustrated, bound in paper, 129 pages, 5 in. x 7½ in. Published by the McGraw-Hill Book Company, 239 West 39th street, New York. Price 50 cents.

Mr. Bradshaw is one of the most active and has been one of the most successful leaders in the safety first movement on railroads. He has given the whole subject the most careful and detailed study and has prepared a most impressive series of photographs showing how the minor accidents on railroads are frequently caused, which, together with explanatory notes, are now bound together to form this book. The scenes illustrated are familiar to all railroad men, and are usually the result of carelessness on the part of some one. Correcting them costs little or nothing in either money or effort. The photographs should be seen by every railroad man whose duty takes him either into the shop or out on the road.

COMMUNICATIONS

COLLEGE MEN AND THE RAILROADS

[A large number of very interesting communications on this subject has been received, but the limits of space will allow the insertion of but two in this issue. Others will appear in December.—EDITOR.]

OMAHA, Neb., October 23, 1913.

TO THE EDITOR:

The subject of the communication of I. I. W. and the editorial in the October issue is a matter that has been discussed pro and con for years, both in mild form and otherwise. There must be some basic trouble. Have we hit on it yet?

The problem of the college man to the average practical railroad official may perhaps be summed up somewhat as follows:

First: When the college man applies for a position he has no definite idea of what he wants to do, what he wants to become, or what method he should follow to achieve his cloud-obscured goal. In many cases he is "wished on" the official in question.

Second: The college man first starting to work is full of protestations as to his willingness to do anything which is laid out for him to do.

Third: Almost from the day the college man begins any assigned work his abnormal impatience begins to make itself manifest.

Fourth: It seems impossible to satisfy such a man either with a routine of work or with normal increases of pay, or promotions.

Fifth: If the college man is acquainted with any of the higher officers of the road or has any "influence," in the majority of cases he begins to write letters of complaint or criticism which filter back to the officers who are trying to handle him.

Sixth: The college man, generally speaking, is inordinately selfish, in that without respect for the loyalty or years of service of trusted employees of a road he expects to be set above them. His conceit is such that he deems himself more competent than these older employees.

Seventh: Generally speaking, the college man's perspective is so limited that he does not realize the importance of that most important element of official success; namely, the ability to handle men, without which, knowledge or practical experience, or both, must be greatly discounted as items of weight in the consideration of promotion possibilities.

Eighth: Selfishness again appears among college men in their utter disregard of the fitness of things as regards "laying off," taking vacations, asking for transportation, special favors, etc. These are elements that make for disorganization in a time-tried and loyal force of workers.

Do not misunderstand my point of view. It is admitted that in some cases college men with the proper requisites for success are mishandled by railroads. There is much to criticize on the other side, but let us first get at some of these most striking primary conditions and ask ourselves why these conditions exist.

There is in Boston an organization known as a Vocational Bureau, the object of which has been to make a careful study of the different industries commonly entered by boys and girls, so that the vocational guidance of youth could be efficiently undertaken by these broad-minded founders, and young folks thereby aided to successfully enter professions in which, according to all indications, they could make more or less progress. The converse of this being that youths would be advised against entering professions in which there was every probability of their failing to achieve success.

I do not believe there are more than a very few of our universities or technical schools wherein intelligent and practical vocational guidance is given to the members of the graduating classes. My experience in handling a considerable number of

college men who have wanted to start railroading has been that few if any of them have any intelligent idea as to the organization of a railroad; as to the functions performed by the various departments; as to the duties of the various minor officials of the different departments; as to the hours of service of these officials, their salary, their requirements as to intelligence, practical experience, technical knowledge, etc. In other words, the college man when turned out into the world is equipped with a certain amount of knowledge which he is ready and anxious to apply, although he is not equipped with accurate information as to where he can best sell his services or best apply his knowledge.

It is also true that in most cases the college graduate has no idea of what he wants to be. In other words, his ambition has not assumed the form of a definite ideal or concept. Those who want to be railroad men in the majority of instances do not know why they want to be railroad men; in fact, don't know what a railroad man is, what he does, or what he needs to know.

It is also true that most railroad officials are not experts on the subject of vocational guidance of college men. Many of them are too busy to take the time to go into the subject thoroughly, and many of them have been so disappointed with past experiences with college men as to have lost all interest in college men in general. The result is that in the majority of instances a college man is given a job without any particular investigation on his part as to what it will be or where it will lead to, and without any particular interest on the job-giver's part as to whether the man is fitted for railroad work or is started in a manner to lead to ultimate success. With such a hit-or-miss manner of getting and giving railroad jobs why should it be expected that any considerable percentage of college men would stick to railroading?

Let us paint another picture. A young man, either before entering college, or while in college, makes up his mind that he wants to be the general superintendent of a railroad. In other words, while still a young man and unformed he has analyzed his desires and analyzed railroad conditions so that he has firmly convinced himself that considering his intelligence, his opportunities for training, his strength, his desire, etc., he is justly entitled to steer toward a reasonable goal of ambition; that is, the general superintendency of some railroad company. What is the first thing he should do? He should by all means find out just as thoroughly as possible what duties, hours of service, necessary knowledge, practical experience, wages, perquisites, etc., are a part of such a position; in fact, he should have found out most of these things before making up his mind that he wants to be a general superintendent, but having once made up his mind and having ascertained the fundamentals required for such a position he is then ready to square about, to steer his course in as straight a line as possible for this chosen harbor.

He finds out many other things—that a general superintendent must be a thorough operating man, must have sufficient knowledge of motive power and mechanical matters to intelligently deal with such mechanical matters as come within the scope of his jurisdiction, that he must, on practically all railroads, be a first-class track man, that he must have big capacity for the handling of men, and in fact a thousand other qualities that go to make up the equipment of a successful operating official. This young man equipped with such knowledge and insight is not troubled with conceit as to his knowledge, is not consumed with impatience, is less prone to be supremely selfish, and has learned his first great lesson; that is, that there is so much for him to learn that he can't overlook any opportunity for getting information of every kind and description.

If this man is of the right calibre he will plan out his own course of action. He will know long before he leaves college what is the first job that he must tackle to get experience. He

may choose to go to work as a section laborer, he may choose to go to work as a locomotive fireman, he may start in as an apprentice in the shop, or he may go braking or switching, or work as a yard clerk, or enter station service—it makes little difference, although if he is wise he will so plan his line of action as to get his dirty work and his poorly paid work done as early in the game as possible.

He realizes with great humility that he cannot hope to get personal practical experience in all of the lines of work, so he works with an active brain, with wide-open eyes and tightly-closed mouth, except when using his mouth to ask intelligent questions which he has previously carefully formulated in his mind.

Such a man if he goes braking will learn all about an engine, will fire half the way over the road on every trip and get his locomotive experience in combination with his train service experience. Such a man will never lose an opportunity to talk to anyone about railroad work. He will, in an inoffensive way, be poking his nose into everything. In fact, he will be so busy learning things that he won't have time to "holler" about lack of appreciation of his work, partiality and kindred other things, and he will be learning so fast and so much that instead of kicking about more pay he will feel that the check he receives at the end of the month is but a small part of his real income. He will automatically make himself so valuable in a short time that he will begin to get special work, small promotions and opportunities for acquiring a further knowledge, etc.—not as a sop to keep him satisfied, but because the railroad needs such men and ninety-nine times out of a hundred takes mighty good care of them.

Such a man in his first period of practical work will live with, and be one of, the men, and he will get an insight into human nature and the peculiar methods of thought of railroad employees that will be invaluable to him in justly and sympathetically dealing with these classes of employees in later years when he is in an official position.

Will this man expect to be a general superintendent at the end of four years of training? No! Nor at the end of twenty, perhaps, but he is on his way all the time and he realizes month by month and year by year his steady progress toward his goal, and as he progresses through the minor positions, is transferred from point to point and attains age, he may perhaps glance higher up and begin to apply the same reasoning powers and methods to the position of general manager, or vice-president in charge of operation, or president, or chairman of the board, and if he aims high enough and persists he will ultimately arrive, if not at the very top, then mighty close to it.

But what of the poor, rudderless, compassless college man who wants to be a railroad man but does not know where he wants to start in and does not know what he wants to do? He has no idea what work such as he can do is worth. He is given a "job." He does not know what he ought to have, but he is pretty sure that what he has is not right and he begins to kick—he does not know what for, but for something different. Generally speaking, the railroad is well rid of the percentage that it loses of such men.

Why should the railroad have to maintain a vocational bureau? Why should it be up to a busy railroad official to tell a college man how to start in railroad? Why should the railroad have to have special courses, special apprenticeships, special studentships, to take care of college men? What is the college for if it has not fitted the graduate to intelligently approach his life's problem? Why should not every university have a department of vocational guidance or an assigned course of study, the sole purpose of which would be to aid and instruct the student in the business of life?

The poor boy with a common school education, good health and character starts out at twenty years of age as an equal with other employees in character and manhood; associates with

them, obtains their support, and starts at once to learn and succeed.

The college boy has learned it all at twenty years of age, considers himself superior, and lacks the support of his associates; discovers his mistake after four or five years work, and possibly at the age of thirty years gets down to business.

Taking the poor boy at thirty, who has made continuous advances, and the college boy at thirty, who has learned to make advances, the latter will probably have better chances for advancement than the poor boy on account of his superior education and training provided he has equal sense and the application of the other.

I will say from personal experience that the college man, who knows what he wants, finds a way to get it on a railroad. He sticks and makes good. It is the fellow with the useless rudder, the defective compass, or the broken-down engine that gets on the rocks of discontent.

D. C. BUELL.

NEW YORK, October 14, 1913.

TO THE EDITOR:

In discussing the communication of I. I. W. and the editorial comment thereon, both in the October issue, I shall speak from my experience as an employer of college graduates as well as from my experience later in life as the president of Stevens Institute of Technology.

I was the first in my specialty to employ, systematically, engineer graduates. I established a cadet corps in which these young men were trained, as rapidly as consistent with thoroughness, for advancement into responsible positions. While I insisted that they should go through the grades and learn to do with their hands, I did not expect to teach each one of these men to be as expert mechanically in every branch of our work as the mechanics who had devoted a lifetime to a single specialty. But I did expect these men, with their superior preparation, to learn quickly and thoroughly the practical essentials in all branches of our work, and to be able to direct accordingly.

I confess that I sympathize with I. I. W. far more than I usually do with the complaints of engineer graduates. As usual, there are faults on both sides; and, in addition, there are great difficulties on both sides, the faults of no one in particular but due to the inherent difficulties of the problem. Most of the difficulties could be eliminated by the complete, open-minded and intelligent co-operation between the schools of engineering and the employers.

I fear that some of our railroads are failing to conduct their apprenticeship courses efficiently. Engineer graduates should not be subjected to a course which is not competently designed to supplement the previous college training in the science of engineering. I am strongly of the opinion, and here I agree with I. I. W., that an adequate apprenticeship railroad course for engineer graduates could be covered in two years. These graduates should be required, if necessary, to work at high pressure to cover the ground in two years. Evening classes for, say, three nights in the week should be so conducted that the students could, under the guidance of competent men, trained in theory and practice, be led more quickly to understand and appreciate the practical application of engineering science to the requirements of the shop and field. And the majority of these men—those of stamina—under proper guidance, would, I believe, respond to the demands so made on them. Unless these engineer graduates are to receive special treatment as apprentices, which will shorten the term of their apprenticeship, they might better follow some other line of study in the school of experience.

As far as compensation is concerned, I do not think the apprentices would have much cause for complaint, provided they were given the proper opportunity to get a thorough experience training without unnecessary loss of time and effort. I have always held with my cadet engineers that they did not

earn their wages at first (the lowest I have ever paid is \$50 a month)—the period depending upon the personality of the man. These cadets were being paid to take a special post-graduate course in the school of experience. I am also of the opinion that it is a mistake to pay these cadets by the hour or the piece. If we are to treat them as cadets, let it be understood by the method of pay that we are not expecting them to earn the hourly wage, but that we are expecting them to do far more—prepare themselves quickly for higher duties, irrespective of the hours in the twenty-four to be devoted to the present task. Paying these men by the hour or piece implies that they are expected to earn the wages so scheduled by the product of their labor. To me this is essentially wrong. We should not expect them to produce on a par with the mechanic who is paid by the hour or piece and is expected so to make good day by day and year after year.

I am glad to see that I. I. W. appreciates that it is up to the engineer graduates to get down to hard and, if necessary, dirty work. The man who thinks that his college diploma is to save him from any or all necessary practical experiences, should not attempt to qualify himself in our profession. Perhaps we might go farther and say that to qualify in any profession or vocation, he must first discard such a puerile conception of life's work.

Certainly the railroads and other employers are making an unnecessary loss for themselves if they go to the expense of establishing an apprenticeship system for engineer graduates, and then do not secure a fitting return through the retention in their service of men thoroughly trained in the science and practice of engineering.

As is pointed out in the editorial referred to, there is an advantage in letting the student before graduation specialize for the line which he expects to follow. But there are disadvantages, and the plan is all too likely to be over-developed. The engineer undergraduate student of good average ability has no easy task if he covers the fundamentals of engineering science in the standard four-year college course. The sub-divided specializing should not be much more than an emphasis on some one branch. For instance, at Stevens, although our sub-title is "A School of Mechanical Engineering," we do not closely specialize in the mechanical branch of our profession and, as a result, our graduates are found to be active and prominent in every branch of engineering. But they have one advantage—they are constantly being instructed to the effect that their college training must be supplemented, chiefly through their own studies, for which they have been trained, in some one of the departments of the school of experience.

And here is where there should be a more complete and intelligent co-operation between the colleges and the employers. The former should be frank to point out to their students that the college studies, no matter how complete and how practical, are not sufficient for efficient practice in engineering and the industries; and the employers should not at the first expect too much of the young graduate, but should give him the best possible opportunities to acquire the additional practical training in the school of experience.

The value of the co-operative scheme of education is well shown in the work of the Glasgow University, and in that of our Cincinnati University.

I am free to confess that if I. I. W. has correctly described the apprenticeship instruction for engineer graduates as practiced by some of our railroads, I should, if consulted, advise a young man of ability not to engage therein. And this I say, notwithstanding the fact that I have given ample proof through years of practice that I would not hire an engineer graduate who was not willing to be a hard-working, conscientious, persistent student in the school of experience. And let me add that studies in this school should cease only with his retirement from active duties.

It is for the colleges, the employers and the engineer graduates to appreciate that there is room for improvement. Some of the colleges and railroads are much at fault; no doubt all of each are partly at fault. We cannot expect the youngsters to do their best unless we first do our best to give them the most complete opportunities to qualify for advancement; provided, of course, that they are willing to do their best to qualify.

ALEX. C. HUMPHREYS,
President of Stevens Institute of Technology.

TURNING FOUR-BAR CROSSHEAD WRIST PINS

St. PAUL, Minn., October 6, 1913.

TO THE EDITOR:

In the April, 1913, number of the *American Engineer*, page 192, is shown an arrangement for turning a four-bar guide crosshead wrist pin. We have an attachment on one of our lathes in the Chicago, St. Paul, Minneapolis & Omaha shops which I believe to be original, and it is positive in its operation. It is shown in the illustration. An eccentric is screwed to the headstock of the lathe which, together with the levers, gives the crosshead the necessary oscillation; the lathe runs as in any other work. In the one in use here the eccentric has a

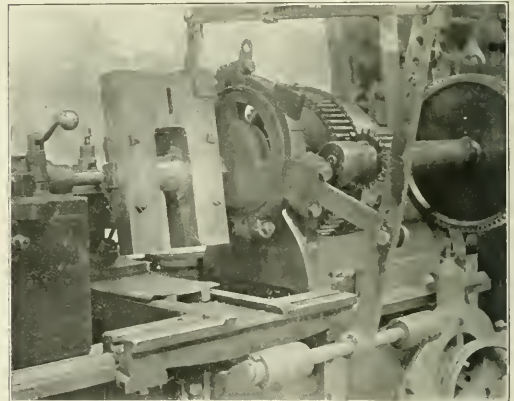

Apparatus for Turning the Wrist Pins of Four-Bar Crossheads.

travel of 8 in., the rest of the apparatus being made to suit the lathe. Our practice is to plane the top and bottom of the pin to size and slot it front and back; we then turn the pin a quarter of a revolution at a time.

I have not shown the tools used, which, although they are not exactly the same as those shown in the April number, are similar and could be used in the same way.

JAS. FINDLAY,
Foreman, Construction Shop.

NEW ALLOY OF PLATINUM.—A new hard alloy of platinum is said to have been produced by the addition of osmium. It is claimed that this alloy, which contains from 0.5 to 1.0 per cent. of osmium, has physical and electrical properties fully equal to the platinum alloy containing a much higher percentage of iridium.—*The Mechanical Engineer*.

RECORD-BREAKING MONOPLANE FLIGHT.—At Rheims, France, September 29, Maurice Prevost, flying over a circular course, in a monoplane, traversed a distance of 124.28 miles in 59 minutes, 45.6 seconds, or at the rate of 124.58 miles an hour. The length of the circular course is 6.213 miles, and Prevost made one circuit in 2 minutes 56.6 seconds.

4-8-2 TYPE FOR MISSOURI PACIFIC

New Powerful Passenger Locomotives Take Trains Weighing 820 Tons Over 1.9 Per Cent. Grades.

On the Missouri division of the Missouri Pacific, which extends from St. Louis to Poplar Bluff, Mo., a distance of 165 miles, there are a number of heavy grades of moderate length. The steepest is 1.9 per cent., 5 miles long and includes 5 deg. uncompensated curves. There are several others of greater length that have a rise of from 1 per cent. to 1.5 per cent. The passenger traffic on this division is very heavy, and up to recently Pacific type locomotives have been used exclusively. These engines have a tractive effort of 36,800 lbs., and when the traffic required trains of more than 8 cars it has been necessary to use two locomotives. As double heading became more or less frequent, it was decided to obtain larger locomotives, and the problem was presented to the American Locomotive Company, which prepared a design of 4-8-2 type locomotive as suited for this service. Seven of these engines have recently been completed and it is found that they are able to handle trains of from 12 to 14 cars, having a weight of 820 tons, over the 1.9 per cent. grade, at a speed of 18 miles an hour. This is from 50 to 75 per cent. heavier train than it was possible to haul with one locomotive previously.

A weight limit of 210,000 lbs. on drivers was specified. This necessitated a carefully designed boiler to obtain the maximum power without exceeding the limit of weight. It was decided to use a steam pressure of 170 lbs., and a boiler of the conical type having an inside diameter of 74 1/4 in. at the front end and an outside diameter at the largest course of 87 1/2 in., and a grate area of 56.5 sq. ft. was adopted. This boiler would not allow the application of cylinders larger than 28 in. x 28 in., and in order to obtain the desired tractive effort to handle 14-car trains, the driving wheel diameter was reduced to 63 in. In view of the class of traffic and conditions of service this combination was thoroughly satisfactory. These engines are not intended for sustained high speed such as would ordinarily be demanded of a large Pacific type, and this size of wheel allows

increase in the grate area of about 14 per cent. and the reduction of the steam pressure from 180 to 170 lbs., there is very little difference in the size. The combustion chamber adds 51 sq. ft. to the heating surface of the firbox, but the heating surface of the tubes and flues has been reduced by 56 sq. ft. If it is assumed that the heating surface in the firebox is six times as valuable as that in the tubes, and that the heating surface of the arch tubes is ten times as valuable as that in the boiler tubes,

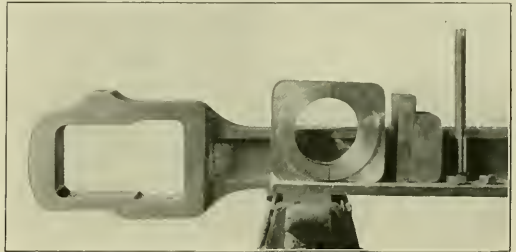

New Type of Main Rod End and Brass.

it will be found that on the basis of heating surface, the mountain type boiler is about 5 per cent. larger than that used on the Pacific type. This, taken in connection with a 14 per cent. increase in the grate area and a reduction of 10 lbs. per square inch in the steam pressure, will give a considerable net increase in this boiler. The size of the superheater is about the same in both locomotives.

The design throughout embodies the latest improved practice of the builders. The engines have a screw reverse gear; outside steam pipes; extended piston rods; latest improved, out-

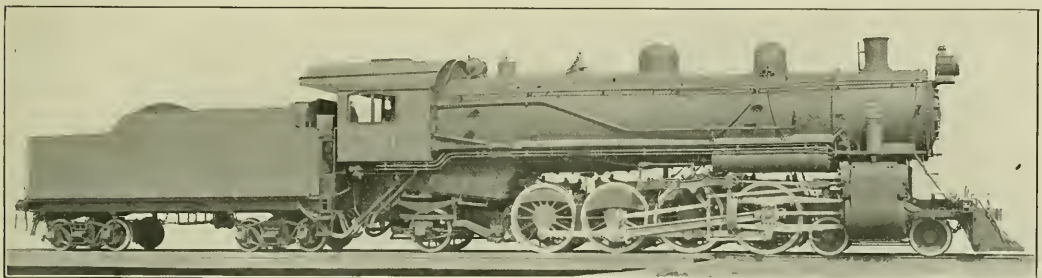

Mountain Type Passenger Locomotive for the Missouri Pacific.

them to go up the steep grades at sufficiently high speed and also is large enough to obtain the necessary speed when they are descending grades where boiler capacity does not become a factor.

Comparing them with the Chesapeake & Ohio mountain type locomotives, it will be seen that the Missouri Pacific engines are distinctly smaller, particularly in connection with the boiler. This is due principally to the weight limitations which allowed a boiler of exceptional power to be applied on the Chesapeake & Ohio design. When the boiler is compared with that on the Pacific type locomotives which they displace, it will be found that outside of the introduction of the combustion chamber, an

side bearing trailer trucks and Baker valve gear. A new design of solid end main rod has been employed, with the result of a saving of about 115 lbs. in weight per rod as compared with the forked end rod. This rod, which is of the Foulder design, uses the same pattern of brass both at the front and the back of the pin and two adjustable wedges are employed for obtaining the desired adjustment.

The general dimensions, weights and ratios are shown in the following table:

<i>General Data.</i>	
Gage	4 ft. 8 1/2 in.
Service	Passenger
Fuel	Bit. coal

Tractive effort	50,400 lbs.
Weight in working order	296,000 lbs.
Weight on drivers	208,000 lbs.
Weight on leading truck	48,000 lbs.
Weight on trailing truck	40,000 lbs.
Weight of engine and tender in working order	457,500 lbs.
Wheel base, driving	16 ft. 6 in.
Wheel base, total	36 ft. 5 in.
Wheel base, engine and tender	27 ft.

Ratios.

Weight on drivers ÷ tractive effort	4.14
Total weight ÷ tractive effort	5.87
Tractive effort × diam. drivers ÷ heating surface	692.00
Evaporating heating surface ÷ grate area	61.00
Firebox heating surface ÷ tube and flue heating surface, per cent.	9.00
Weight on drivers ÷ heating surface	45.40
Total weight ÷ heating surface	64.80
Volume both cylinders, cu. ft.	20.00
Heating surface ÷ vol. cylinders	229.60
Grate area ÷ vol. cylinders	2.83

Cylinders.

Kind	Simple
Diameter and stroke	28 in. x 28 in.

Valves.

Kind	Piston
Diameter	14 in.
Greatest travel	6½ in.
Outside lap	1 in.
Inside clearance	0 in.
Lead	3/16 in.

Wheels.

Driving, diameter over tires	63 in.
Driving, thickness of tires	3½ in.
Driving journals, main, diameter and length	11 in. x 12 in.
Driving journals, others, diameter and length	10 in. x 12 in.
Engine truck wheels, diameter	33 in.
Engine truck, journals	6 in. x 12 in.
Trailing truck wheels, diameter	42 in.
Trailing truck, journals	8 in. x 14 in.

Boiler.

Style	Conical
Steam pressure	170 lbs.
Outside diameter of first ring	73¾ in.
Firebox, length and width	108½ in. x 73¾ in.
Firebox plates, thickness	¾ in. and ⅝ in.
Firebox, water space	4½ in.
Tubes, number and outside diameter	218 in.
Tubes, material and thickness	Spellerized steel, No. 11 B. W. G.
Flues, number and diameter	32—5¾ in.
Flues, material and thickness	Seamless steel, No. 9 B. W. G.
Tubes and flues, length	20 ft.
Heating surface, tubes and flues	3,165.2 sq. ft.
Heating surface, firebox	285.3 sq. ft.
Heating surface, total	3,450.7 sq. ft.
Superheater heating surface	761 sq. ft.
Grate area	56.5 sq. ft.
Smokestack, diameter	18 in.
Smokestack, height above rail	15 ft. ½ in.

Tender.

Frame	Cast steel
Wheels, diameter	33 in.
Journals, diameter and length	6 in. x 11 in.
Water capacity	8,000 gals.
Coal capacity	14 tons

*Equivalent heating surface equals evaporating surface (3,450.7 sq. ft.) plus 1.5 times superheating surface (761 sq. ft.), or 4,592.2 sq. ft.

ENGINE HOUSE SMOKE.—Several years ago we endeavored to collect the smoke and gases by means of suction fans and pass them through water sprays to precipitate the heavier contents, but without success. The size, first cost and operation cost prohibited a plant of sufficient capacity. A modification of this arrangement, in which the smoke and gases are forced through a considerable body of water, is about to be put in operation, and I am sure it will be watched with interest by all concerned in this subject. At the present time the Pennsylvania Lines have under construction, at the engine house in Allegheny, apparatus to carry the smoke and gases from the locomotives in which fires are being prepared, through an underground duct and a fan, discharging them into a stack 150 ft. high, and 7 ft. in diameter. It is felt that this arrangement will not only carry the smoke and gases considerably above the buildings immediately adjacent to the engine house, but, owing to the size of the stack, permit of considerable precipitation of the heavier particles. The stack will be so located that it will be possible to interpose smoke washing apparatus between it and the fan, should a sufficiently promising method be developed.—*D. F. Cratford before the International Society for the Prevention of Smoke.*

DESIGN OF LOCOMOTIVE GRATES

BY W. R. HEDEMAN

Probably the first parts of a new locomotive to need replacement are the grates, due to the heat to which they are subjected, and anything that will tend to improve and prolong their life should be gladly received by motive power men. It is the hope of the writer that the information contained in this article will be beneficial to those who are seeking to better the grate design and arrangement.

There must be enough opening in the grates to permit all the air coming through the damper openings to pass through, in

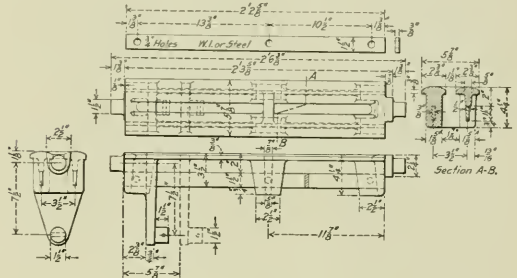

Fig. 1—Table Grate Bar.

order to produce proper combustion; one square foot of damper opening to seven square feet of grate area is a good standard toward which to work. Fig. 1 shows a table grate bar with reinforcing strips of wrought iron or steel cast in it. This is an excellent bar, but is more expensive than one made entirely of cast iron. Owing to the narrowness of this type of grate a front and back dump grate are necessary. Fig. 2 shows a finger grate bar reinforced with wrought iron. This type of bar has been used very extensively and is especially good in breaking up the fire where lumpy coal is used. It must be kept level, as the fingers will burn off if allowed to extend up into the fire.

With the foregoing types of grates dump grates are necessary,

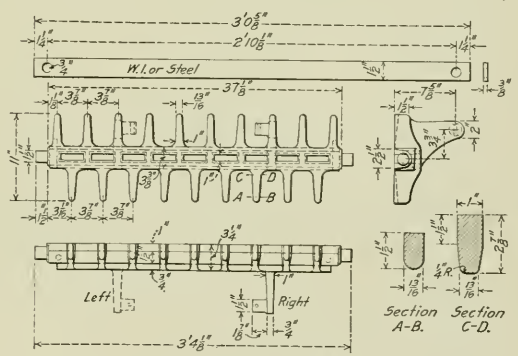

Fig. 2—Finger Grate Bar.

and Fig. 3 shows a design of such a grate which is giving good service. This is also reinforced with wrought iron, which adds considerably to the life of both the grate bar and the dump grate. Any scrap of about the section shown in Fig. 3 (½ in. x 2 in.) may be used for these strips; old boiler plates 5/16 in. to ½ in. in thickness may be cut up and straightened for the purpose. The strips should be heated before being used, to prevent moisture collecting.

A very serviceable locking arrangement for dump grates is

shown in Fig. 4. The keeper or latch is secured to the backhead or cab sheet, and engages over the end of the dump lever which is especially arranged for it.

A bar that is giving good service and one to be recommended,

especially where mechanical stokers are used and a fine coal is necessary, is shown in Fig. 5. The ends of the shaking arms are placed 2 in. off center, which permits the tilting of the grates to such an angle as to provide an opening between them large enough for all clinkers to fall through, thus doing away with dump grates and stationary corner grates.

A cast steel center bearing bar is shown in Fig. 6. This de-

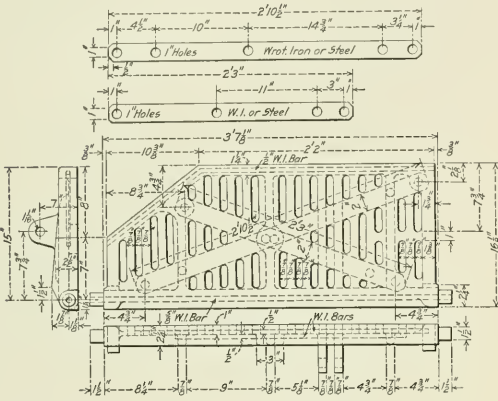

Fig. 3—Back Drop Gate.

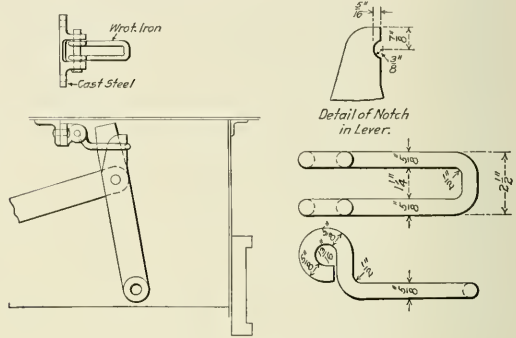

Fig. 4—Drop Gate Lever Keeper.

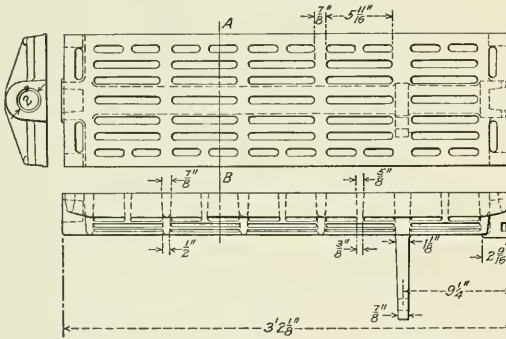
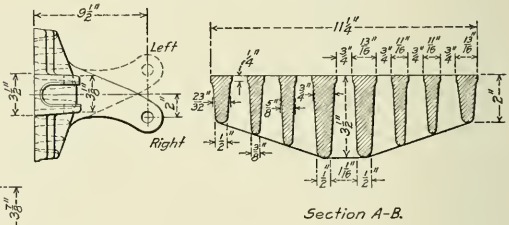

Fig. 5—Box Type Gate Bar.



Section A-B.

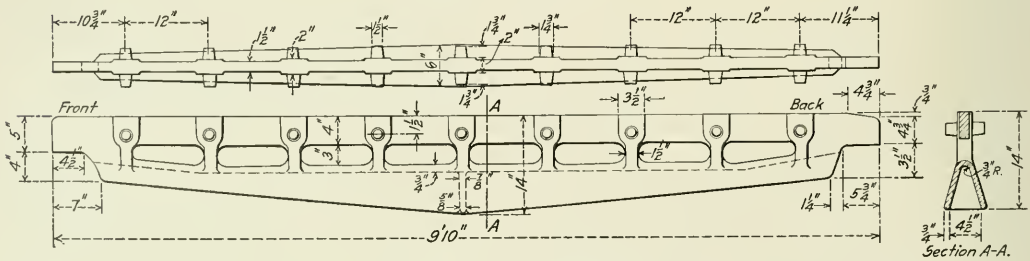

Fig. 6—Grate Center Bearing Bar.

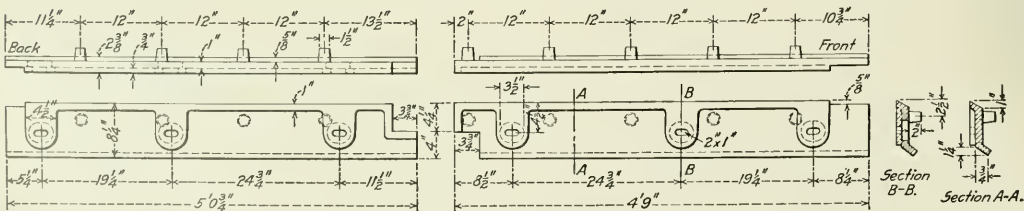

Fig. 7—Grate Side Bearing Bars.

sign gives good service and causes practically no trouble. The trunnion bearing bar has been adopted because it will not hold

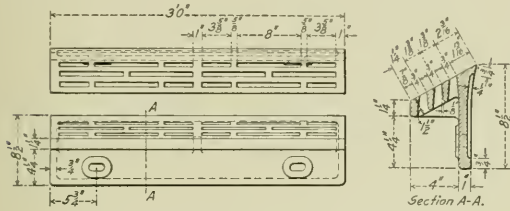

Fig. 8—Front Dead Gate of the Box Type.

the ashes, as in the old type, and permits the gates to be more easily shaken.

Cast steel side bearing bars of an approved design are shown

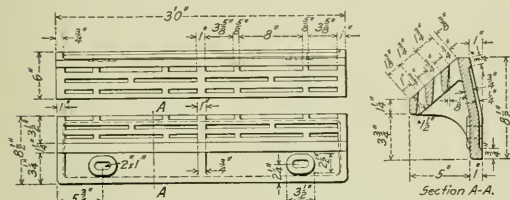

Fig. 9—Back Dead Gate of the Box Type.

in Fig. 7. The top beveled edge of this bar fits snugly against the side sheet, thus preventing hot ashes from falling down

and lodging against the sheet and burning it. There is also a cored depression for the clamping nut which prevents any ashes accumulating on top of the nut. It has been found better to make the side bars in two pieces, rather than a long one piece bar, so as to obtain castings which are not warped.

Figs. 8 and 9 show a box type of front and back dead gate designed to shed the ashes to the shaking gates, and Fig. 10 shows the method of fastening the side bearing bars to the fire-box sheets. The rivet stud is driven into one of the mudding rivet holes and serves a double purpose, that of a rivet and a

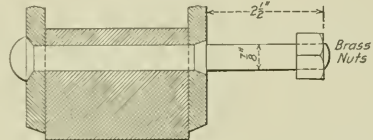

Fig. 10—Method of Fastening Side Bars In Place.

stud. Brass nuts are best for use on these studs, as there is then no corrosion and the nuts are easily removable.

As most modern locomotives have wide fireboxes, two and sometimes three sections of grates are necessary. Fig. 11 shows a two section arrangement of grates made up from the box grates illustrated in this article. This arrangement is being used on large Mikado type locomotives equipped with Street stokers, and is giving excellent service. With this design care must be taken to give the shaking lever full movement in the cab. The bars should tilt until the edges strike against the grouping rods on the arms of the bars. It has been found from experience that the box type of bar shown in this ar-

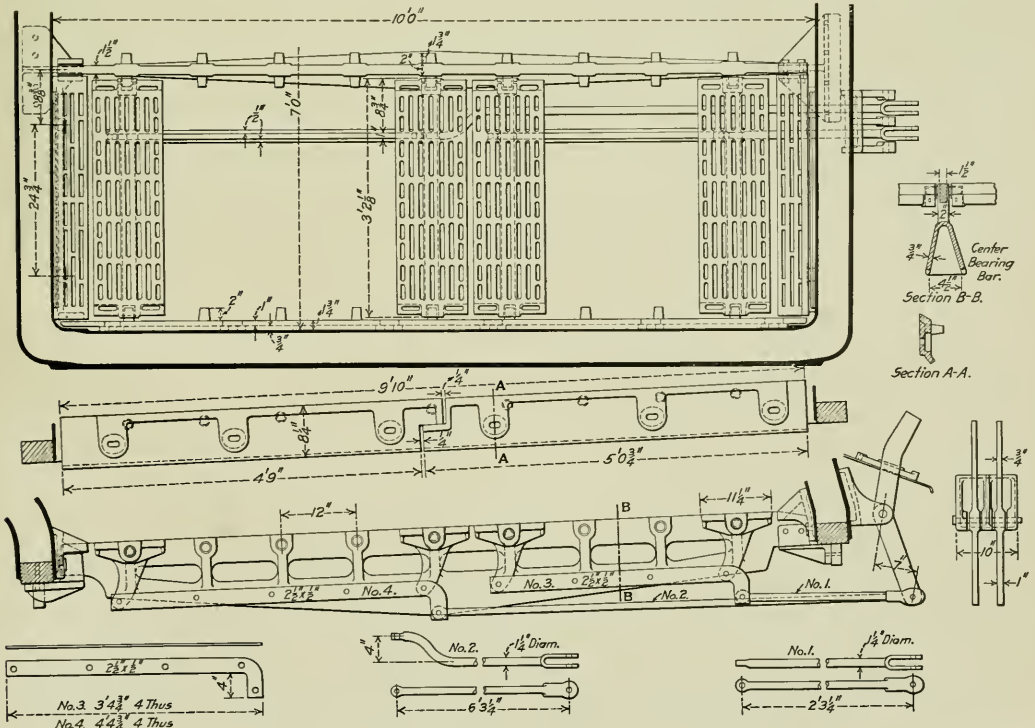

Fig. 11—Arrangement of the Grates In a Locomotive Firebox.

rangement is the most satisfactory and has the longest life, and it also relieves the foundry of considerable output as compared with other types of bars. While this type was primarily adopted on account of the fine coal used with the Street stoker, its use has been extended to other locomotives using lump coal, with excellent results. With the use of a Tabor molding machine the molds for this grate can be made for 15 cents each. It will be noted by referring to Fig. 5 that the shaking arms are of such construction as to permit the cleaning of the grates in the rattler after they are cast.

RESULT OF LETTER BALLOT OF THE M. M. ASSOCIATION

Thirty-seven proposed changes in the recommended practice of the American Railway Master Mechanics' Association were submitted to the members for letter ballot. All of them were adopted. In addition to many which were adopted practically in conjunction with the Master Car Builders' Association there have been changes or complete revisions made in the specifications for locomotive frames, for steel tires, for boiler tubes, for solid wrought carbon steel wheels as well as a new formula for main and side rod design. The designs proposed for solid wrought carbon steel wheels were adopted as well as the other recommendations of the committee on engine and tender wheels which are given on page 1381 of the *Daily Railway Age Gazette*.

LOCOMOTIVE FIRE EXTINGUISHER

At the recent convention of the Railway Fire Protection Association, P. Hevener, assistant supervisor of insurance fund of the Rock Island lines, described the fire extinguishing equipment used on 250 switching locomotives on that system. The injector delivery pipes on both sides of these locomotives have a Y-connection, as is shown in the accompanying illustration. Under the running board in a closed box there is a 50-ft. 2 in. unlined linen fire hose with couplings and nozzles. As the Rock Island engines are equipped with combined stop and check valves

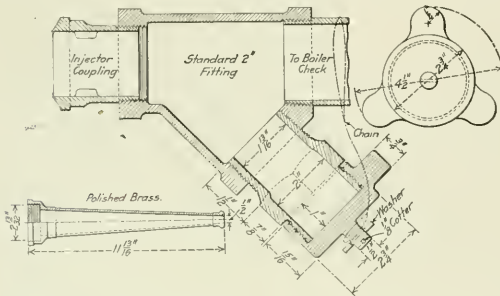

Connection for Fire Hose Used on Injector Delivery Pipe of Rock Island Locomotive.

there is no necessity for an extra valve between this fitting and the check valve. When it is desired to use the hose the check valve is clamped in a closed position, the pipe cap on the end of the exposed leg of the Y is removed and the hose coupled on, the water being forced through the hose by the injector in the same manner as when feeding the boiler. Although this heats the water to a considerable extent, it is not hot enough to scald, and by the use of gloves the nozzle may be easily handled. This equipment costs about \$45, and has given most satisfactory results, saving several thousand dollars worth of property from fire damage since it has been in use on the Rock Island lines.

LOCOMOTIVE HEADLIGHT LAWS

In its report to the convention of the Association of Railway Electrical Engineers, the committee on locomotive headlights gave a summary of the headlight laws in the various states which are reproduced below.

The committee, in considering this summary, expressed the opinion that these laws were drawn without due consideration of the suitable standard condition or basis under which tests could be made and reproduced, and it recommended that the association express its sentiment as being unfavorable to the enactment of any law or laws which do not clearly specify a standard national basis under which tests may be made. It further recommended that the standard specifications be so drawn as not to eliminate apparatus which may be invented or designed in the future. It is the opinion of the committee that the quantity and quality of illumination at some specific point is the prime object of the headlight and not the means or apparatus by which this illumination may be effected or obtained.

The summary presented is as follows:

ELECTRIC.

- (1) Headlight of 1,500 candle power, measured without reflector: Arizona.
- (2) Headlight of 1,500 candle power, measured with reflector: Missouri (effective January 1, 1914).
- (3) Headlight consuming 300 watts at the arc: Georgia (23 in. reflector required). Mississippi (18 in. reflector required).
- (4) Headlight sufficient to distinguish an object the size of a man at 800 ft., measured with reflector: Oregon (effective February 21, 1914).
- (5) Headlight of design approved by Railway or Public Service Commission: Vermont. Washington.

NOT NECESSARILY ELECTRIC.

- (6) Headlight of 1,200 candle power, measured without reflector: Colorado (effective April 3, 1914). North Dakota (effective July 1, 1914).
- (7) Headlight of 1,500 candle power, measured without reflector: Minnesota (effective January 1, 1914). Montana. Nevada (effective January 1, 1914). North Carolina. Oklahoma. South Dakota. Texas.
- (8) Headlight of 1,500 candle power: Arkansas. Florida (effective October 1, 1913). Indiana.
- (9) Headlight of 10,000 candle power, measured with reflector, or sufficient to distinguish an object the size of a man at a distance of 800 ft.: South Carolina.
- (10) Headlight sufficient to enable operator to distinguish an object the size of a man lying prone on track at a distance of 1,160 ft.: Iowa (10 per cent. by October 2, 1913; 10 per cent. each 30 days thereafter).
- (11) Headlight sufficient to distinguish a dark object the size of a man at a distance of 800 ft. while train is running not less than 30 miles an hour: California (effective August 11, 1913).
- (12) Headlight sufficient to distinguish an object the size of a man at a distance of 800 ft.: Illinois (passenger train locomotives only; effective July 1, 1913). Kansas. Wisconsin.
- (13) Headlight sufficient to distinguish an object the size of a man at 600 ft. by a person of normal vision: Nebraska (effective January 1, 1914).
- (14) Headlight sufficient to distinguish an object the size of a man at a distance of 450 ft.: Illinois (freight train locomotives only; effective July 1, 1913).
- (15) Headlight sufficient to distinguish whistling posts, land marks and other warning signs at a distance of 350 ft.: Michigan (30 per cent. by March 1, 1914; all locomotives by July 1, 1914). Ohio.
- (16) Headlight sufficient to distinguish an object the size of a man at a distance of 250 ft.: Illinois (switching, transfer or suburban passenger service only; effective July 1, 1913).
- (17) Headlight of 50 candle power, measured without reflector: Minnesota (switching locomotives only; effective January 1, 1914).

The penalties for violation of these laws vary from a minimum of \$25.00 to a maximum of \$1,000.00 each offense.

Attention is directed to the wide difference in the provisions of these Acts. These differences render it impossible in all cases for railways operating in more than one state to make use of appliances standard in one state in others through which they run. There is no Federal legislation on this subject, but bills are pending in the present Congress.

COAL MINE FATALITIES.—The total fatalities during the first seven months of 1913 in the coal mines of the United States were 1,437 as compared with 1,419 for the same period in 1912.

SULZER-DIESEL LOCOMOTIVE

4-4-4 Type Driven by a Direct Connected Oil Engine; Built for Prussian-Hessian State Railway.

During the past three or four years there has been a continually increasing interest taken in the possibilities of the Diesel oil engine for all classes of work where economy of fuel is desired. It is not only now being employed for stationary plants driving electric generators and other classes of machinery, but has also been adapted to marine use with decided success. There are now between 300 and 400 ships driven by Diesel engines, some of them being of large size.

Its success in these fields has naturally led to a consideration of its possibilities for use on a locomotive, and while the problems here were considerably more difficult of solution, a moderate sized locomotive, successful, at least so far as its operation is concerned, has recently been completed at the works of Sulzer Bros., Winterthur, Switzerland, for the Prussian-Hessian State Railway.

This locomotive is intended for high speed passenger service and the trials already made show it capable of attaining a speed of at least 62 miles an hour. The reports do not give the weight of the train which it hauled at any speed. It is of the 4-4-4 type.

In this type the general action of the engine is as follows: Consider the piston at the bottom end of its stroke; the cylinder is then full of air at nearly atmospheric pressure, and this is compressed during the first or upward stroke of the piston to a pressure of 500 lbs. or more per square inch while the temperature rises to between 1,000 degs. and 1,100 degs. F. During the early portion of the downward stroke the fuel oil is injected in the cylinder above the piston by a blast of air at a higher pressure than that in the cylinders, through a special form of needle valve. Combustion takes place during this period as the temperature of the compressed air in the cylinder is above the burning point of the oil fuel. The duration of this part of the stroke depends on the position of the fuel valve, but cut-off usually occurs not later than 1/10 of the stroke at full load. At the cut-off when the fuel inlet valve closes, combustion continues for a short period, expansion then occurs and work is done on the piston through about another 75 per cent. of its stroke, at which point the exhaust opens and the products of combustion begin to pass out. Air under a pressure of about



Sulzer-Diesel Locomotive for the Prussian-Hessian State Railway.

has a total length of 54 ft. 5 in. and a total weight of 190,000 lbs. The driving wheels have a diameter of about 69 in. The driving wheel base is 11 ft. 8 in., leaving space between the drivers for a jack shaft, which carries a large disc on either end that includes the crank pin for the connection of the rods that drive the wheels through crank pins in the ordinary manner; this disc is counterbalanced. The four-cylinder oil engine is connected directly to this shaft, giving a direct drive to the wheels without the introduction of gears or clutches of any kind. The cab is continuous for the full length of the locomotive and has side and end doors arranged as is shown in the illustration.

A Diesel engine, so far as heat efficiency is concerned, is the most economical machine known, having a thermal efficiency of 48 per cent. and frequently an effective efficiency of nearly 35 per cent. It is generally arranged for use with oil fuel and develops power from the fuel directly in the cylinder without any previous transformatory process. It is distinctly an internal combustion engine, as distinguished from other gas and oil engines which are, strictly speaking, internal explosion engines. Like other gas engines, it is built in both the four-cycle and two-cycle designs, and it is the latter type that is used on this loco-

20 lbs. per square inch then enters through a separate valve or port in the cylinder head, being supplied from a scavenger pump, and the exhaust gases are all forced out through the exhaust ports in the sides of the cylinder, which are opened by the piston at the lower end of its stroke. This leaves the cylinder full of pure air at the beginning of the next stroke and the cycle is repeated.

Since in the case of the locomotive the engine is direct connected to the driving wheels through the side rods, it is necessary for it to attain a certain speed before it can start working on oil fuel. This is done by means of compressed air obtained from an auxiliary compressor set, consisting of a 250-horse power Diesel engine driving a horizontal three-phase air compressor, which furnishes air between 700 lbs. and 1,000 lbs. pressure. Reservoirs are provided for storing the excess air and for providing a pressure for starting the main or compressor engines. It has been found necessary to use the compressed air until the locomotive attains a speed of five or six miles an hour, at which point the liquid fuel is turned on and the engines work as a power producer.

The four cylinders of the main engine are arranged in pairs,

each inclined 45 degs. to a line perpendicular to the rail, their axes intersecting in that of the single crank shaft, common to all. They have a diameter of 15 in. and a stroke of about 21½ in. Each pair of cylinders lies in a common plane and acts on a common crank pin. The two cranks are set at 180 degs. and at 60 miles an hour make slightly over 300 revolutions a minute. Each of the four cylinders carries in its head a fuel valve, a starting valve and two scavenger valves. Between the crank pins there are two eccentrics each controlling all the valves on one-half of the main engine. These eccentrics are rotatable for reversing the running direction; this is accomplished through a special system of links and rods that are operated from the driver's compartment. In connection with the eccentrics there

shaft has two counterbalanced fly wheels and its two cranks are 180 degs. apart, and operate through other connecting rods, two horizontal multi-stage air pumps. There is a distributing valve which controls the delivery of these compressors between zero and the maximum and a governor controls the speed of the en-

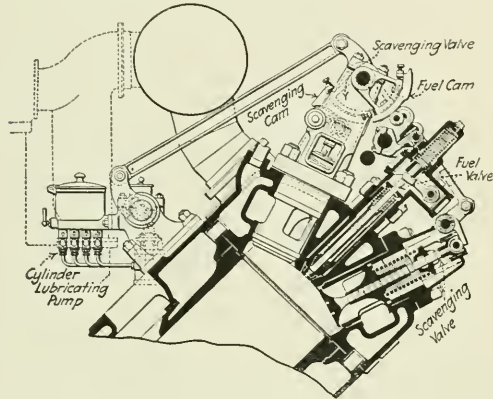

Valves in the Head of the Main Engines.

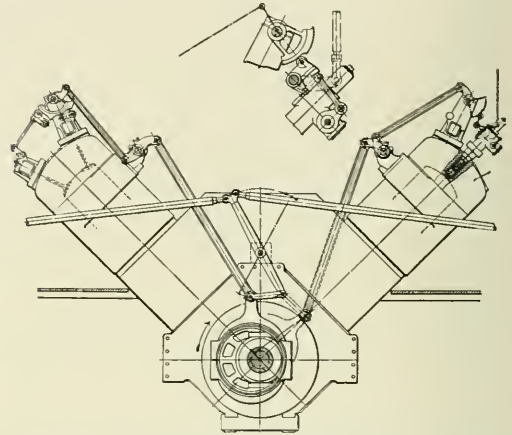

Arrangement of the Cylinders and Reversing Gear of the Diesel Engine.

is a rather complicated system of links, cams and small eccentric shafts for controlling the opening and closing of the various valves in the cylinder head as well as the variation in the time the fuel inlet valves are opened for controlling the speed of the locomotive.

There are two double acting piston pumps as well as a three-stage air injecting pump located between the main engine cyl-

gine. When the locomotive is stopped or under service requiring but little air the compressor delivers its surplus to receivers placed behind the main engine. Special pumps are provided for lubrication and there are hand-operated centrifugal pumps included on the locomotive for priming the cold water, circulating water and the fuel piping when needed.

A Westinghouse brake equipment is used, there being shoes on all of the wheels. The air for braking is taken from an intermediate stage of the compressor and stored in a special reservoir.

The organization formed to build this locomotive, and probably to also control the construction of future locomotives of the same type, is called the Thermo Locomotive Company. In this

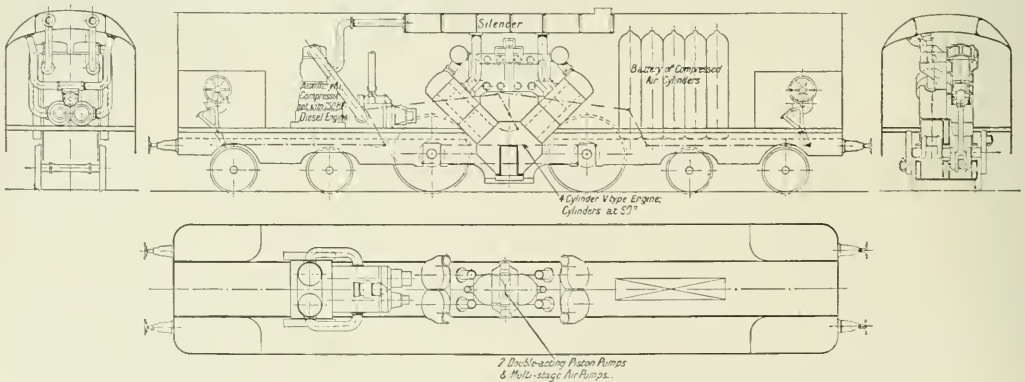

General Arrangement of the Sulzer-Diesel Locomotive.

inders and driven through the medium of rocker arms and links from the connecting rods of two of the cylinders. These pumps are all fitted with relief valves.

The auxiliary Diesel engine is also a two-cycle machine of 250 horse power. It has two vertical cylinders, 12 in. in diameter, with 15 in. stroke, fed by a duplex fuel pump. The crank

are associated the firm of Sulzer Brothers, Oberbaurat A. Klose of Berlin and Dr. Diesel of Munich. The headquarters of the Thermo Locomotive Company are at Ludwigschafen. All of the patents on the new locomotive, however, are owned by Sulzer Brothers. The running gear on the locomotive was built by A. Borsig of Berlin.

Cochrane feed water heater. Natural draft is obtained by a 200-ft. brick stack and regulated by a Richard Thompson Company damper regulator. The washout system is the Winslow and consists of a hot well outside of the power house, a circulating tank inside and two Pratt Iron Works 12 in. x 10 in. x 12 in. duplex piston pumps.

A fire protection system of 22 alarm boxes and 18 hydrants is provided, and a team of firemen is maintained and regularly trained. While there is sufficient floor space for electric generators in the plant the current is being purchased from the local company and is supplied at the switchboard at 2,300 volts, 60 cycles. There are two General Electric 50-light constant-current transformers for arc lights in the yards and terminals, one Adams-Bagnall 25-light constant-current transformer for flame arc lamps around the shops and coaling station, and three 50 k. w. 2,300-440 volt transformers for power. The 2,300-110-volt transformers for multiple lighting are located near the point of consumption, but controlled from the switchboard. All high tension circuits are controlled by oil switches with automatic release.

The coal for the boilers is dumped from cars into hoppers over a crusher and after being crushed it is taken up by means of chain buckets and dumped on a conveyor belt which conveys



Cinder Pits and Roundhouse With Machine Shop and Old Roundhouse on the Right.

it to the desired point. The crusher is run by a 20 h. p. Westinghouse electric motor, and the elevator and conveyor are driven by a 7½ h. p. motor of the same type, the arrangement being interlocked to prevent congestion at any point.

ADMINISTRATION BUILDING.

This is of the same general construction as the others and is built on the east of the machine shop. The entire basement is used for general file rooms for records; the first floor provides offices for the road foreman of engines, roundhouse foreman and general foreman, engine dispatchers, callers and division storekeeper, and the second floor, for the assistant master mechanic, general car foreman, division master mechanic and the timekeeper. It is heated by low pressure steam and lighted by 60 watt electric lamps in fixtures suspended from the ceiling.

CINDER PITS.

The cinder pits are of the submerged type, constructed of reinforced concrete with a steel framing for the crane runway. There are two of them, 8 ft. deep, 20 ft. wide and 200 ft. long with one track between them for cinder cars. The cinders are allowed to fall into the pit, where they are wet and are then taken out and put in the cinder cars by means of a clam shell

bucket and Whiting Foundry & Equipment Company 10-ton crane, electrically driven and travelling the full length of the pits. There is an auxiliary beside the large pits for outbound engines. This has room for five three-ton buckets which are taken out and dumped in the large pits as desired by means of a jib crane which is equipped with a five-ton Sprague electric hoist.

INSPECTION PITS.

There are two inspection pits constructed of reinforced concrete and each of sufficient size to accommodate two locomotives.

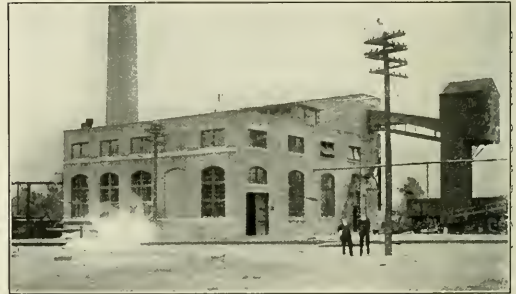

Power Plant, Showing Hot Well on the Left and Coal Conveyor on the Right.

They are connected by a self-draining tunnel, 5 ft. wide and 6 ft. deep, at one end of which there is a stair leading to the inspector's shop. There are facilities here for making light repairs, such as adjusting parts or renewing set screws and nuts without putting the locomotive in the roundhouse. The pits are equipped with electric lights and hand extensions.

COALING STATION.

From the accompanying illustrations an idea of the construction of the coaling station may be obtained. It is of reinforced

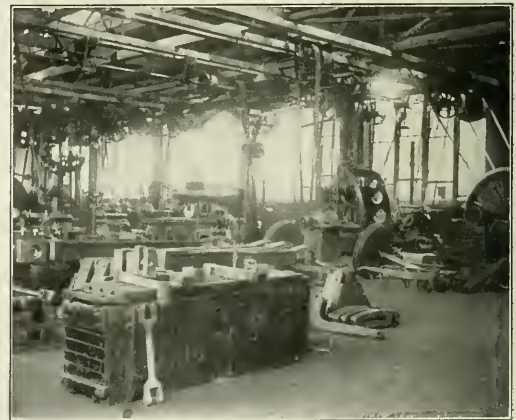

Interior of the Machine Shop.

concrete and steel, the tower being inclosed with corrugated iron. The structural work shown open is the inclined elevator shaft for the buckets. There are four coaling tracks with two chutes for each track, and the bucket capacity is 600 tons. The coal is elevated by means of a two-bucket cable, each bucket holding about five tons. The buckets are operated by means of a drum, compound geared to a 35 h. p. electric motor, the

cables winding on and off alternately as the loaded bucket ascends and the empty one descends. The hoist is controlled by a Cutler-Hammer full reverse, skip hoist, automatic controller and is also protected by limit switches. The loaded cars, as they are received from the mines, are stored on a three-track hump, holding about 20 cars, and as desired they are allowed to roll down over the hopper. The coal passes through chutes with gates operated by the elevator buckets, allowing just enough to pass to properly fill the bucket; it is then distributed to any of the four bins as desired by means of chutes. This is necessary



Cinder Pits and Coaling Station, Looking East.

on account of using different kinds of coal for different classes of locomotives or service.

SAND HOUSE AND DRYER.

The sand buildings are constructed of wood, and are of a somewhat new type, being elevated to permit the sand to be dumped into the storage bins which are provided with covers or trap doors. A trolley is provided through the entire length, and is equipped with a ½-ton self-dumping bucket by means of which

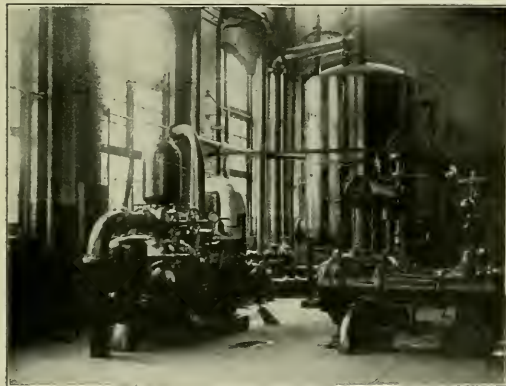

Interior of the Engine Room Showing Fire Pump, Air Compressor and Boiler Washing Plant.

the sand is taken to the dryer. The dryer is of the steam heated gravity type, the dry sand being allowed to run into a tank equipped with a valve so that when closed the sand is forced by compressed air through pipes into bins at the top of the coaling station. This arrangement is in duplicate sets. The dry sand bins are provided with chutes so that a locomotive may obtain sand from any of the coaling tracks. There is storage provided for 1,200 cu. yds. of green sand and 20 cu. yds. of dry sand.

OLD ROUNDHOUSE.

The old roundhouse will be retained for the smaller locomotives with a part of it remodeled for a storeroom for material and supplies. The old machine shop is now being fitted up for boiler, smith and pipe shop purposes. The tools in this shop will be driven by a 30 h. p. Westinghouse electric motor and a 10 h. p. Allis-Chalmers motor. The boiler shop tools consist of punch, shears and rolls, and the pipe shop will have the usual equipment for such stations. The smith shop is fitted with one 1,800-lb. steam hammer, one cutting off machine, one upsetting machine, one scarfing machine for 2¼-in. tubes, and a duplicate set for 5-in. tubes.

CAR WHEEL SHOP.

The car wheel work which was formerly done in the machine shop has been moved to the steel car plant. This not only places this work under the general car foreman, but reduces the handling of old and new wheels, as a large part of the wheels are used in the car repair yard. The car wheel equipment consists of one Putnam double head axle lathe, one Putnam boring mill, one Niles 300-ton wheel press driven by a 30 h. p. electric motor, and one journal grinder driven by a 5 h. p. electric motor. In



Repair Shop for Steel Cars.

addition, the car plant is equipped with a 620 cu. ft. steam driven air compressor, punch, shears, drill, emery stone and bolt cutter. Great care has been taken in making these improvements to consider the comfort and safety of the employees. Guards have been installed on all gears, belts and reciprocating parts and around pits, etc., and warning signs posted.

The new terminal was designed and constructed by Westinghouse, Church, Kerr & Company, New York.

WHAT A LOCOMOTIVE BURNS.—The problem which confronts the railway officer in considering this subject is an extensive one. To obtain from the modern locomotives the average power required from them it is necessary to consume fuel at the rate of about 100 lbs. of coal per square foot of grate per hour, and to obtain the maximum power required it is necessary to consume 150 lbs., and at times in excess of this amount, per square foot of grate per hour. That is, to obtain the power necessary to perform the work demanded, a boiler which from its heating surface would be rated at about 320 horsepower is frequently forced to develop over 1,500 boiler horsepower, and our records show that another boiler, which would on the basis of heating surface be rated at about 400 horsepower, has developed as high as 1,994 boiler horsepower. The performance stated above requires coal consumption at the rate of from 6,000 to 10,000 lbs. of coal per hour, and this has been done on a grate of 55 square feet.—D. F. Crawford before the International Society for the Prevention of Smoke.

THE USE OF SAND ON LOCOMOTIVES

BY F. E. PATTON

Sand is regarded by some people as an item of little importance, but it plays a very important part in the performance of locomotives, both in fuel economy and in handling tonnage, if properly used in starting trains and on grades. It also prevents the wear of tires caused by unnecessary slipping. There is a certain grade of sand used on some roads that has considerable clay in it, and scarcely any glass. This is used instead of lake or river sand on account of its being available with only a short haul, and the difference in the price is very little, if any; but even if it costs a little more it is better economy to obtain good, sharp sand for locomotive use if it is available.

Sand boxes and sand pipe joints are sometimes neglected, and locomotives frequently arrive at terminals in rainy weather with wet sand in the box and the pipes clogged; very often the box is filled with dry sand before the wet sand is removed. The engineman may report the sanders as needing cleaning, and it is then necessary to empty the box to do the work right. The box and pipes should be absolutely free from moisture and the valves should have the same opening on each side. Frequently an engineman will say that he cannot get over the road with one box of sand on account of having to use the hand lever, claiming that he has too many brake pipe leaks to use the air sander, as its use would result in sticking the brakes, and one valve would be partly open before the other started to open and in order to get sand on both sides he would be using too much on one side. With sanders adjusted evenly on both sides it is not always necessary to hold either one open for any length of time after the train is started. If it is necessary to use sand to prevent slipping after the train is in motion it can be used for short distances at intervals, as there is always enough sand sticking to the tire to hold the locomotive for a few rail lengths after the sand is shut off. This results in a saving of sand and lessens wheel friction.

Enginemen on arrival at terminals should open the air sander just before stopping at the point of relief, and shut it off after stopping, moving the locomotive a few inches beyond where the first stop was made and opening and closing the sand valves. When inspecting the engine they should note the operation of both sanders and whether there is sand in the box, and should be able to report any defects. If sand is working on one side only, or is wet in the box and pipes, the hostler and roundhouse foreman should be notified not to sand the engine until the wet sand is removed and the leaks repaired. Sand should be properly screened and handled by careful men, as it is very essential that it may be depended on to respond in any emergency. Very often a piece of waste is found in the box or in one of the pipes at the top, which has been dropped by the men sanding the engines; as a rule it is found in the left pipe, which would indicate that it was placed there for the purpose of saving sand and labor, the men thinking that the engineman will not notice it as he can see the sand running on his side; enginemen should not leave a terminal without sand working on both sides.

It is very important that the sanding devices measure alike on both sides, as sand can then be used sparingly and regulated so that the tonnage can be handled successfully at all points. As a rule, when an engineman starts out with a full box of sand he is not very free, in using it until he discovers that he has used the greater part of it; if, at that time, he has only covered a part of the division, it will require careful work to complete the trip successfully unless he is able to obtain sand at some intermediate point. If an engineman drops a little sand every time he starts his train he will find that the locomotive will not slip so easily after the train is started, and that he can get over the road with very little, accomplishing a saving in sand and fuel and saving wear on the tires.

Passenger locomotives are often observed to slip a few turns when starting at stations. The engineman takes a chance on the locomotive's not slipping, and if it does slip he closes the throttle and drops a little sand. If he would get the habit of dropping a little sand on every start the engine would never slip, and in making a stop where the grade is ascending it is a good policy to drop a little sand before coming to a stop. Passenger engines usually stop at about the same spot at stations, and when they try to start without sand they slip; this being done every day makes the rail very bad at that point, and if the grade is ascending the next freight train following will probably slip there if the engineman is not on the alert. This slipping of the freight engine might necessitate doubling or reducing the train. Careless slipping causes tires to be ground down and also puts a hard glazed surface on the rails, which takes time to wear off; as long as tires are in this condition it requires considerably more sand to hold the locomotive, often necessitating the dragging of a train over a heavily sanded rail, which would not be necessary if more care were taken. If sand boxes and sand pipe joints can be made water proof and a good grade of sand is used, there should be no cause for stalling on hills, if the tonnage is not excessive and no brakes are applied. There is nothing more aggravating or trying to an engineman's patience than to try to get over the road on a bad rail with a box full of wet sand or pieces of coal and waste lodging in the sand valves as fast as they are cleaned.

With everything in good working order, there is still another condition which causes trouble on long runs when the rail is wet; this is the clogging of the sand in the bottom ends of the pipes, when it becomes necessary to jar the pipes to knock it out. There should be some device used to keep the bottoms of sand pipes clean on long runs, and in freezing weather this should be watched closely, as at such times the sand is likely to freeze solid in the pipe.

The general storekeeper of a certain trunk line recently told me that there were more right-hand brake shoes used than left-hand shoes, and asked me if I could explain the cause. This condition should not exist, as the wear should be the same. I told him, however, that it might be possible that a great many locomotives were running with the left sand pipe stopped up, which would cause the right shoes to wear out faster if sand is used in making stops. If such is the case, it not only reduces the efficiency of the locomotive, but also works a hardship on the mechanical department.

PRIVATE-CAR TROUBLE IN ENGLAND.—After the end of this year no wagons (freight cars) will be allowed on the railways in Great Britain which are not fitted with spring buffers. This is in accordance with a notice issued by the Clearing House seven years ago; but it is said that the proprietors of coal mines have from 8,000 to 12,000 wagons still in use which have only "dead" buffers—those not fitted with springs. What can be done with these cars after December 31 is a question which now gives rise to some anxiety.

STEAM AND ELECTRIC LOCOMOTIVES.—From the information offered by many writers on the subject, one would be led to believe that a steam locomotive is a most wasteful machine and that tremendous savings would result from abandoning their use. As a matter of fact, the performance of the locomotive boiler compares favorably with the average results obtained in stationary practice, and the performance of the complete locomotive, of modern construction, is sufficiently efficient to permit of obtaining a coal rate of 2.1 lbs. per indicator horsepower hour, or 2.5 lbs. of coal per horsepower hour delivered at the drawbar of the tender. Surely such results do not warrant the almost general belief that the locomotive is an inefficient machine for the purpose for which it is intended.—*D. F. Crawford before the International Society for the Prevention of Smoke.*

SHOP PRACTICE

MACHINE SHOP KINKS

BY H. T. NOWELL,

General Foreman, Boston & Maine, Concord, N. H.

EXPANSION ARBOR.

An inexpensive expansion arbor or mandrel that may be used to good advantage on work requiring bushings is shown in Fig. 1. This device eliminates the necessity of having numerous straight mandrels of varying diameters. It is necessary to have

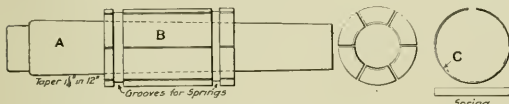

Fig. 1—Expansion Arbor for Light Lathe Work.

only two sizes of the taper pins *A* and about three sets of the split shells *B*, for any size of hole from $\frac{3}{8}$ in. to 2 in., as one of these arbors will expand about $\frac{3}{8}$ in. When the outside shells are made they are turned up like a bushing, then sawed into six pieces and marked in sets; when finished the sets are held together by the spring *C*. These arbors hold exceptionally well when the tool is taking the cut, and are easily driven off on account of the sharp taper of the pin.

HEAVY EXPANSION ARBOR.

A heavy expansion arbor made for turning the outside and ends of side rod bushings for locomotives, in a lathe at one setting, is shown in Fig. 2. The main feature of this arbor is that it is not necessary to remove it from the machine when a bushing has been completed or when a new bushing is put on. This saves the workman considerable trouble as well as time for both the arbor and the bushing together would be quite heavy. The arbor screws on the lathe spindle and the left hand cone is fastened to the arbor collar by a dowel pin. The right hand cone *A* is held in position against the work by the nut *B*

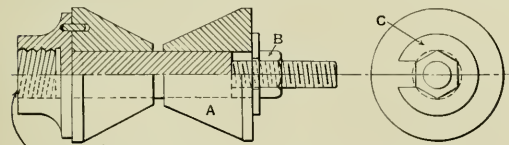

Fig. 2—Expansion Arbor for Turning Side Rod Bushings.

and the collar *C*. The nut *B* is of such size that when the collar *C* is removed the cone *A* may be slipped over it and off the mandrel. This makes an easy and quick method of removing or applying the work. With two sets of cone centers and a long arbor, any size of rod bushing may be turned to advantage in the lathe and time saved on account of the easy manner in which the bushings are put on and taken off. It is also possible with this device to square both ends and turn the bushing at the same setting.

CHUCK FOR THREADING STUDS.

Fig. 3 shows a head for holding studs while the thread is being cut on the end for the final operation. In making the studs they are turned, threaded on one end and then cut off at the correct length in a hollow spindle machine in one operation. When the required number has been made, the head shown in the

illustration is placed in the machine. The jaws *A* are held open by a spring and are closed by the plunger *B*, which has a conical head and extends through the head of the machine. The jaws are removable and are made in sets to accommodate the different sizes of studs. This arrangement will save considerable time over the old method of screwing the stud into a stud set, where it has to be screwed in and out each time a new one is

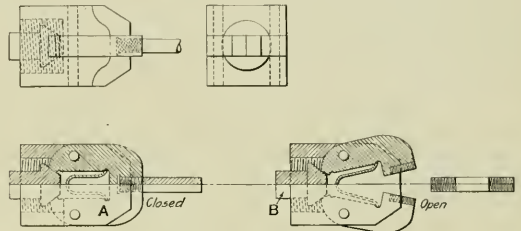

Fig. 3—Lathe Head for Threading Stay Bolts.

put in. This device can be easily made in any shop at a small cost and is applicable to nearly all hollow spindle machines.

EXPANSION REAMER.

An expansion reamer which was built in this shop to ream a hole in a certain class of crossheads that have a shoulder at the bottom of the hole, is shown in Fig. 4. A reamer of this design

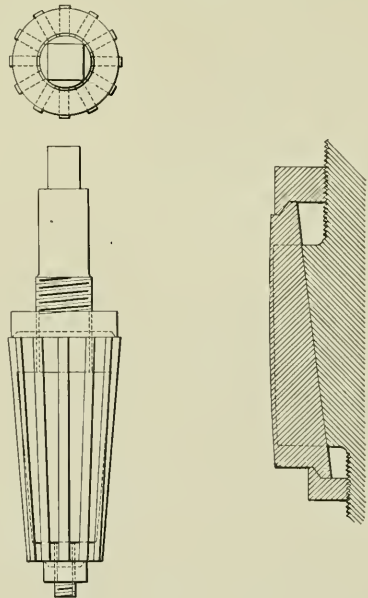

Fig. 4—Adjustable Reamer for Crosshead Work.

can be so adjusted as to enlarge the hole $\frac{1}{4}$ in. and saves carrying a large number of reamers in stock for this particular kind of work. It is easily adjusted by moving the nuts at either end, and is also inexpensive as regards repairs. If one of the blades

should break a new blade is made to pattern and inserted and the reamer is then reground on a grinding machine.

STOCK FEEDERS FOR TURRET LATHE.

A device made to pull heavy bar stock through a hollow spindle turret lathe that has no roller feed attachment is shown in Fig. 5. This can be made to take any size stock up to 6 in., the size of the machine, by the two sliding heads *B*. The shaft *D* fits in one of the holes in the turret head and is carried in the head all of the time. Where a piece of work has been cut

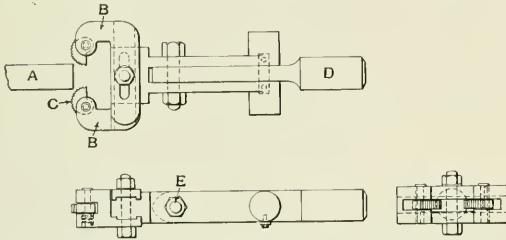

Fig. 5—Adjustable Jaws for Pulling Work Through the Head of a Turret Lathe.

off and it is desired to pull the bar through to start a new cut, the turret is brought forward so that the jaws *C* slip over the stock. When the carriage is started back the jaws grip the stock, due to their eccentric motion, and the work is drawn out the desired distance. When not in use the head of this device tips up at pin *E*, thereby giving more clearance for the turret on the carriage when turning around.

FILING VISE FOR CROSSHEADS.

A device for holding a four-bar crosshead while dressing up the wrist pin, is shown in Fig. 6. The crosshead is firmly gripped at the side by set-screws operating in the two dogs *B* as shown in the illustration. This was made from a scrap link hanger and

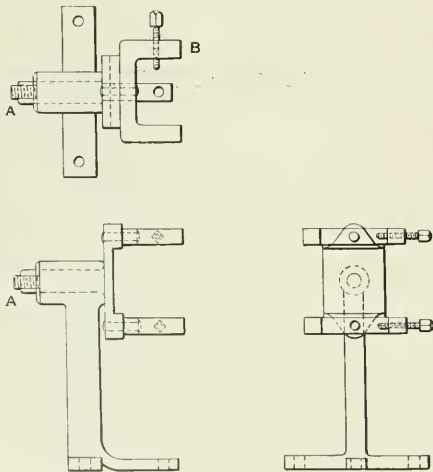

Fig. 6—Standard for Holding Four-Bar Crossheads.

saddle. The hanger was cut and spread as shown so that it could be firmly fastened to the bench. The advantage of this device is that it enables the man who is filing to adjust the crosshead to any position which he may desire by simply slacking the nut *A*.

JIG FOR DRILLING CROSSHEAD SHOES.

The Jig shown in Fig. 7 is used for drilling holes in the shoes of an alligator crosshead. The shoe is placed in the frame *B* and clamped in position by the bar *D*, extending across the top of the shoe, and the cams *E*. The jig is fastened to the angle bar

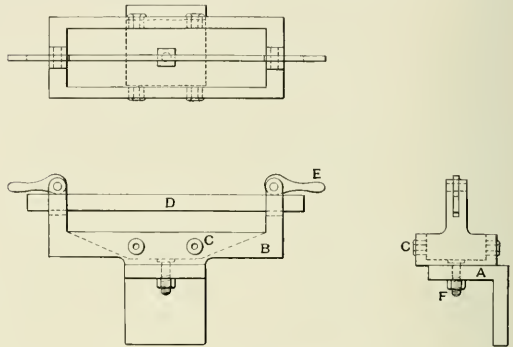

Fig. 7—Jig for Drilling Crosshead Shoes.

A by the bolt *F*, the angle bar being clamped to the table of the drill. The drill is guided by the bushed holes *C* and after one side has been drilled the bolt *F* is slackened, the jig turned around and the other side drilled. The arrangement is simple in design, does the work nicely and helps toward insuring accurate drilling.

PACKING SPOOL RACK FOR INJECTOR BENCHES

BY F. W. BENTLEY, JR.,

Machinist, Butler Shops, Chicago & North Western, Milwaukee, Wis.

Packing spools, in connection with work on the injector benches, are often the source of no little trouble and aggravation to the repairman. They are of such a size that comparatively few of them take up much valuable drawer room, and if they are kept in the store room repeated trips are necessary to obtain small quantities of packing, causing a waste of the workman's time.

The accompanying illustration shows a packing spool rack

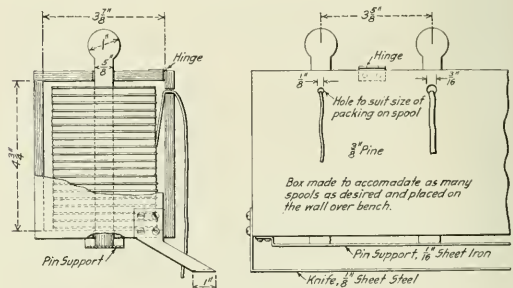

Rack and Spools for Packing Used on Injectors, etc.

which eliminates all annoyance and delay in the procuring and using of small stem packing. The various sized spools are held by wooden pins, turning upon them as small pieces of the packing are pulled out and cut off. At the bottom of the box a piece of sheet steel, ground on the inner side to a knife edge, affords a ready means of cutting off the packing.

ENGINE HOUSE ORGANIZATION AND OPERATION

Individual Paper Presented at the Convention
of the Railway General Foremen's Association.

BY W. SMITH

The subject of engine house efficiency can only be treated in a general way due to the many and varied conditions that are met with, such as the number of locomotives to be handled, and the class of service they are engaged in; also the class of traffic on the road, and the number of grades and curves encountered. Again if engines are pooled, the tonnage ratings excessive, and bad water conditions are met with, the problem is still further complicated. In fact, there are an infinite number of conditions that have their bearing on the subject.

Locomotive Design.—The design of locomotives, as far as the engine house is concerned, is almost uncontrollable, except that recommendations can be made to re-locate inaccessible parts and to re-design parts that are unreliable. Then there are certain desirable features that can be recommended for promoting efficiency in the engine house, such as boiler checks with shut off valves attached, which make it possible to grind in the checks with the engines steamed up; also syphon cocks located on the dome for conveniently blowing off steam. Pistons with long rods that can be pushed far enough ahead to renew cylinder packing, without cutting the rod loose from the crosshead are also to be commended. As a move in the right direction, locomotives are being turned out of the locomotive works at the present time with an auxiliary dome or manhole cover, which makes interior inspection of the boiler possible without removing the throttle standpipe.

Cost of Repairs and Handling.—That local conditions largely determine the cost of repairs is shown by the fact that the cost of repairs per mile in this country varies from 4 to 16 cents. Reduction in cost per mile can be brought about, however, by making the best possible use of the men and facilities available, together with good judgment, and economy in the use of material.

The scrap value of some of the material removed from locomotives amounts to considerable. Hence workmen should be required to bring the scrap material to the storehouse in exchange for the new. What material to require an exchange on will readily suggest itself. Metallic piston rod and valve stem packing should be included, as most kinds have a scrap value of about 20 cents per pound. Parts that can be reclaimed, such as engine truck, tank, and trailer brasses should be exchanged in the same manner. This method will tend to keep the house in a tidy appearance, and less time will be consumed in sorting scrap.

Nothing about the roundhouse should be allowed to go to waste—even dirty waste can be reclaimed, and condemned air hose can be made into throttle gland packing.

The importance of a well stocked storeroom cannot be over-estimated. When repair parts are not in stock, the broken parts have to be expensively patched, or new ones have to be made at great expense, or else the engine is held out of service while the repair part is sent for. The stealing of parts from one engine for another, which is a fruitful source of trouble and expense, is also an outcome of lack of material. Of course when motive power is standardized it is easier to keep the necessary material on hand, due to the fewer variations in the size and design of the parts. This in turn reduces the costs.

Enginemmen should be educated to report work accurately. Shot gun reports, such as "Engine blows," run up the cost of repairs. It costs money to pull valves and take off cylinder heads.

Roundhouse kinks and handy devices when developed to meet the existing conditions of power are great time and money savers.

Labor conditions in the vicinity affect the cost of handling somewhat, but much can be done in the way of reduction by a good organization.

Causes of Failures.—Engine failures will occur as long as there are locomotives in service, and it is only by eternal vigilance, on the part of everybody concerned, that they can be held to the minimum. There are innumerable causes for engine failures, some of which are uncontrollable as far as the engine house is concerned, such as defects in material and design, and poor workmanship during locomotive construction and general repairs.

But, by far the greater number of failures are caused by the lack of skill, care, or judgment on the part of those in charge of inspection, repairs, or handling. Failures are sometimes caused by the neglect of the foreman to have the proper repairs made, either because of poor judgment in deciding that the work reported was unnecessary, or in the oversight in not having the proper repairs made.

Over anxiety to get engines back on their regular runs, after they have received heavy repairs, is a common cause of failure. Good judgment would dictate to run such engines on unimportant runs a sufficient time to develop unexpected trouble.

Prevention of Failures by Discipline.—The problem of engine failure largely concerns the human element. Hence to keep down engine failures, the human element must be controlled, and that means good discipline. Discipline when properly administered will do much to eliminate failures. In some cases, friendly censure or words of caution may have the desired effect; in other cases it may be necessary to resort to suspension.

Each failure should be promptly investigated, and, if possible, traced to the individual or individuals responsible. As aids in this direction complete reports should be required. The chief train dispatcher should notify the master mechanic, by wire or telephone, immediately after the occurrence of a failure, and in addition he should send in a daily report showing all engine failures.

In every case of failure, engineers should be required to make out a complete failure report—preferably on a special form provided for that purpose. Some roads furnish a printed form, which when properly filled out by the engineer, gives all the information in detail. Of course these forms are the dread of every engineer, and they will do everything possible to prevent a failure, if it is for no other reason than to save themselves from making out one of these forms.

Another report should be made out by the roundhouse foreman, in which he should give such information as the cause of failure in his estimation, the work that was previously reported, and by whom it was done.

When enginemmen, inspectors, foremen, and workmen know that each failure will be traced to the individual responsible, and the blame placed accordingly, they will take every precaution to keep the blame from their shoulders.

In order to have the desired effect on the men, a daily report of failures on the division should be posted in a place accessible to all. Most roads compile a record by divisions; it is a summary of engine failures from each cause on each division, and for the whole road. In order that comparisons may be made, the total number of failures, and miles run per engine failure is shown for the previous month, and the corresponding month of the previous year. This report should also be posted, as it has a tendency to create a feeling of rivalry between the men of the different divi-

sions, and it gives the men to understand that they are in a measure responsible for results.

The scheme of giving roundhouse men a bonus for discovering defects that would cause an engine failure has considerable merit. This bonus is given in so many hours off with pay, depending on the importance of the discovery.

Periodical Examinations and Tests.—As a means of preventing engine failures, and of improving locomotive performance generally, periodical examinations and tests have not been given the attention that they warrant. Of course the Federal boiler law defines how often boilers, staybolts, steam gages, and pops must be tested so that is not a matter of choice. Aside from these required tests, there is no general practice—in fact, only at the most efficient engine houses has the matter been taken up.

Just what work should be performed periodically, and what the intervals should be, is largely a matter of conditions and appliances used. If tank water scoops are used, they should be gaged each trip, and if compound locomotives with intercepting

In order to prevent failures from air pumps not working, air pumps should be changed every six months.

High Mileage Between Shoppings.—In order to get maximum mileage from engines between shoppings, all inspections should be made in a thorough manner, and all adjustments and repairs should be given immediate attention. Aside from this, there are certain features with regard to locomotive maintenance, which if controlled will greatly prolong the life of an engine between shoppings. The first is unnecessary or excessive flange wear of driving tires; in some cases this may be overcome by re-spacing tires or putting engine in tram. The second is excessive lateral motion in drivers; this may be prevented to some extent by keeping lateral well taken up in engine trucks and trailers. The third is improper condition of driving boxes; this may be prevented to a large extent by maintaining shoes and wedges in good condition. The fourth is lost motion in rods and connections; this is controlled to some extent by keeping the driving boxes in proper condition. It is also necessary to renew a

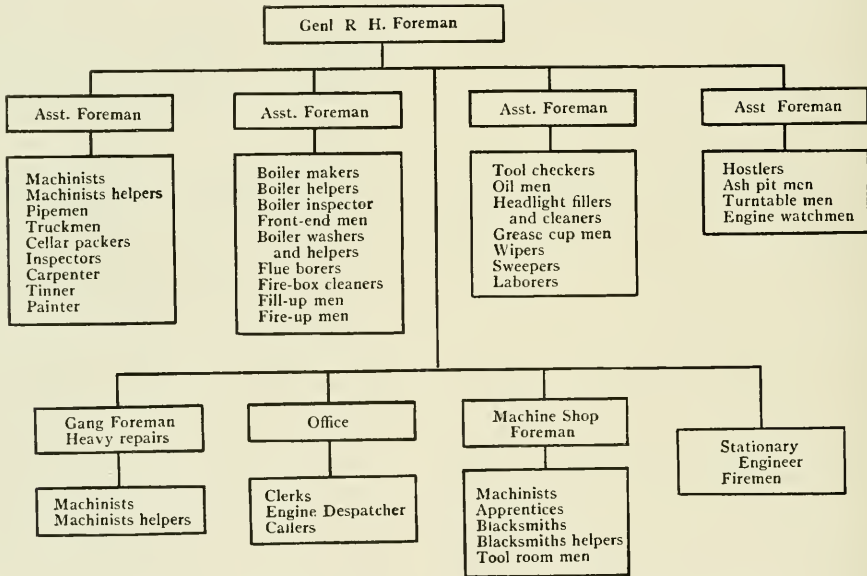

Organization of an Average Engine House Handling Locomotives Mostly of One Class.

valves are in service, the intercepting valve should be examined at least every three months. Superheater locomotives have presented new problems of maintenance, and where the best results are obtained the superheater tubes are tested with water pressure at three months intervals, and the cylinder packing and valves are examined monthly.

To prevent trouble from hot driving boxes, the perforated plates in grease cellars should be examined monthly, and cleaned off if necessary—this to insure a good feed of grease to the journal. All hard grease should be removed from the cellar at this time, and the box re-packed.

Other work that is performed periodically at different engine houses consists of removing drawbar pins each month for inspection; cleaning out tanks each month; draining main air reservoirs each week; gaging height of drawbars and pilots each week; examining piston nuts and follower bolts of built-up pistons each month; testing air brakes each week; examining smoke-box draft arrangements and ash pans each week, etc. When periodical examinations and tests are made, it is very important that a suitable record should be kept of each.

rod or knuckle bushing occasionally, and to keep the main rod brasses reduced.

As an aid to making high mileage between shoppings, square valves should be mentioned. When the valves are properly adjusted the engine can be worked lighter to do the same work, thus saving wear and tear on the machinery.

An engine can be kept in service for so long a time that while the cost per mile run will be apparently low, and while getting over the road without failures, the cost per ton mile may be very high. This should not be mistaken for efficiency.

ORGANIZATION.

The importance of a good organization in the engine house cannot be overestimated. In fact, it is the keynote of the whole situation. Even when the conditions are favorable, and modern facilities are provided, if the organization is not on a sound basis, the results obtained will be inefficient.

By organization is meant, "the selection and assignment of men, and the distribution of responsibility for results." Hence, in an efficient roundhouse organization, each foreman and each

workman should have his duties clearly defined, and should be given to understand that he is responsible for the work he performs.

An organization to be effective must also provide for the loss or transfer of workmen or foremen—that is, there must be men trained for every job so that when absences or vacancies occur, the operation of the engine house will not be affected in the least.

Then the selection of men should be given some attention, and not by the common method of "hiring and firing."

An organization to be effective must have enough supervision to relieve the foreman of too much detail work. There is no question but that the inefficiency of many engine houses is due to lack of supervision.

The engine house foreman should be directly responsible to the master mechanic for results, but the latter should not interfere with the actual supervision of the engine house, as such a

handling both freight and passenger power. The second differs from the first in that separate foremen are provided for freight and passenger repairs. There is much to commend in this plan, but it has the disadvantage of bringing some of the workmen under the supervision of two foremen at the same time.

These organizations are intended for engine houses segregated from the back shop. In this case moderately heavy repairs are usually made, and hence, a heavy repair gang is provided. A heavy repair gang aids to the efficiency of an engine house, because it offers a means of getting immediate action on a rush job, and it is valuable to the organization because it gives a place to draw men from, when there is a shortage in other gangs.

In order to get highest efficiency, work should be specialized as far as consistent. Of course the size of the engine house will determine how far this system can be carried. When work is specialized, the special men generally have the special tools required, and are thoroughly familiar with the work. In large

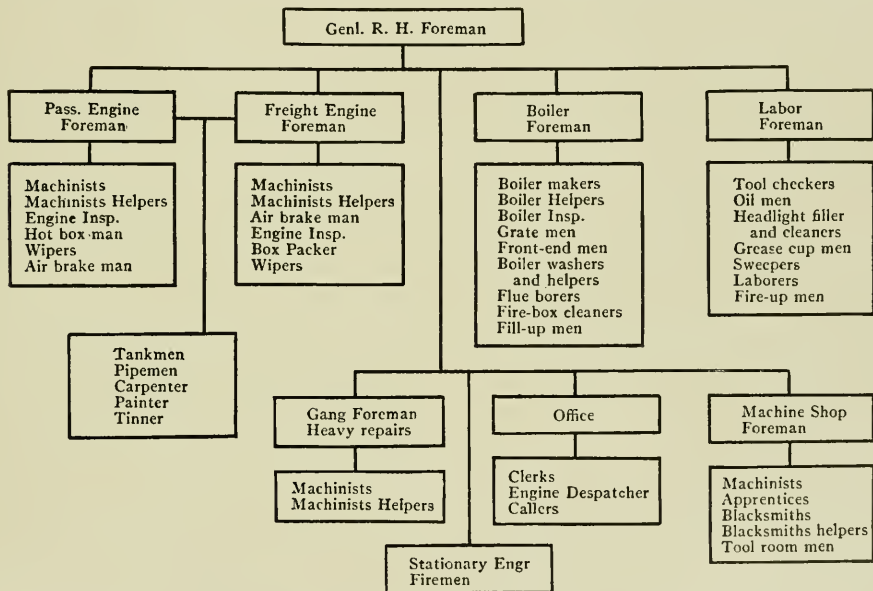

Organization of Large Main Line Engine House Handling Both Freight and Passenger Locomotives.

practice is sure to spoil the authority of the foreman with his men, and consequently the organization as a whole is weakened. The master mechanic should communicate all instructions, suggestions, and criticisms directly to the foreman, and not to individual workmen or assistant foremen.

After an efficient organization has been perfected, the problem that confronts the foreman is to maintain it. This is a question which largely concerns his personality. He should be a firm disciplinarian, and at the same time should have the good will of the men. He should be quick to think and act, and above all should be a keen observer. It is important also that he should be able to key up the organization when the power is badly needed. A spirit of loyalty among the men is one of the greatest aids to efficiency in the engine house, and that can sometimes be brought about by an occasional word of encouragement.

Two methods of organization, which are shown in the accompanying charts, are intended to meet average conditions. The first is for the average engine house which handles engines mostly of one class, either freight or passenger. The second shows an organization especially adapted for large main line engine houses,

engine houses there should be special men assigned to such work as rods, valves, air work, cab work, and so forth. In choosing specialists some attention should be paid to individual proficiencies.

When this system is used, there should be several all around running repair men to take care of work that does not come under the specialists, and to help out on certain work that is behind.

OPERATION.

The aim should be to operate the engine house on the basis of a machine. All movements of the locomotive, from the time of its arrival on the engine house tracks until its departure, should be given the closest attention. The longest delay before an engine is run in the house ordinarily occurs at the clinker pit. Hence the need of especially close supervision at that point. If enginemen are educated to bring in engines, with plenty of steam, full of water, and not excessively heavy fires, an efficient gang of fire knockers can cut the delay down to a surprisingly low figure.

Ordinarily, washing out is the longest operation performed in the house. By all means, there should be a hot washing and

form with a special slip for each job. Preferably the slip should be a special form about 3 in. x 5 in., with blank spaces for the job to be done, the engine number, date, and signature of the workman. When blank paper has to be used it should be in the pad form and about 5 in. wide. Each job should be listed separately on the sheet, and then torn off with a paper cutter. A work report, shipped out in this way, is shown below.

3967—Left main driving box runs hot.

3967—Examine right valve for blow.

3967—Adjust bell ringer.

3967—Open sanders.

Each slip when torn from the sheet should be at least an inch and a half wide. The back of the slip should be left blank for the signature of the workman. Work reports should be marked with a check, when they have been slipped by the clerk—this is to indicate that items have been made out on slips.

When a special form or card is provided for work slips they should be filed away for reference when the work is completed, and they have been properly signed and dated. If the work is designated on ordinary pad paper, it is necessary to have a special reference book with the work reported on the left-hand side of the page, and the workman's name opposite the job on the right-hand side. Of course in this case the clerk will have to check over all work slips turned in and sign the workman's name in the book opposite the job he performed. When this is done the work slip is of no further use and can be destroyed.

It is essential that some system be employed to take care of incomplete work reports—that is, work reported but not done when engine was last in the house. It often happens that it is impossible to do all work reported before the engine leaves the house, but if the incomplete work slips are properly filed away the work can be attended to on the return of the engine, provided it has not been done at the other end of the road. Such slips should be signed and dated on the back by the foreman, together with a brief explanation why the work could not be done, such as "Too short time," "No material in the store room."

In all cases the work report books should be at the disposal of the enginemen, so that they may know what work has been reported by the inspectors, and by the man who came in on the engine; also that he may know what work has been done and by whom it was done. With this information at hand the engineer can inspect the work that has been done, and can make sure that the mechanic has not left any nuts loose or cotter keys out. It also gives him a chance to look after any brasses that have been reduced, or anything of that sort.

In order that the engine house foremen may have an exact knowledge of all work that has been reported, and that they may pass judgment as to how thoroughly the work is to be done, and also that the engines may be promptly reported for service when the work is completed, the work foreman should distribute the work slips personally. As far as possible, he should examine the work reported before the slips are distributed, so that mechanics will not waste time doing unnecessary work. He should also make sure that engines are blown off before he gives out such work as to grind in gage cocks.

In this connection it should be said that the work foreman can do much to promote efficiency by properly analyzing the work slips. If the same work is reported on the same engine a number of times, it is evident that there is some disturbing influence; it should be his duty to find out just where the trouble lies. It may be that a rod pin runs hot; instead of doctoring the pin each time it is reported, the engine should be trammed up, or otherwise examined to determine the source of trouble.

Work slips can be very efficiently distributed and collected by means of the work distribution board. This board consists of a number of tin boxes, which are each divided into two parts—one for slips of work to be done and the other for finished work slips. Each workman is assigned to a box and his name is stenciled below it. The boxes are each about 3 in. x 4½ in., and

each compartment 1½ in., which is the usual width of a work slip. When a workman finishes the slips he has, he goes to the board, deposits the finished slips, and then takes the new assignment.

The system of standard practices, that has been introduced on some roads, is without doubt a great aid in the maintenance of locomotives. There is no question but that considerable waste and inefficiency result when work is done according to varying individual judgment and opinion. When standard practices are used, the allowable limits of wear, the conditions under which to renew worn parts, the lateral to be allowed truck boxes, etc., are definitely determined.

In some cases where standard practices are not used on the entire system, individual master mechanics have framed up a number of rules, with regard to the allowable limits of wear, the application of piston valve rings, etc. These are for the guidance of foremen and mechanics, and when closely followed out are an aid to efficiency.

ENGINE HOUSE EQUIPMENT AND FACILITIES.

There is no question but that modern equipment and facilities will do much to increase the efficiency of an engine house, but it is usually conceded that they are of secondary importance to methods and organization. Unless very heavy repairs are to be made, expensive equipment such as traveling cranes will not, as a rule, give a fair return on the money invested.

The value of a good turntable and tractor cannot be over-estimated. The cost of delays that result from a poorly operating table would sometimes pay for a new installation. The turntable should be power driven by sufficient power so that unnecessary time is not spent spotting engines, and that there may be some margin of power for very bad weather. There should also be a positive lock to prevent derailments due to improperly lined tracks. The tracks should line up with the table at both ends, or the turntable motor should be provided with a drum and clutch attachment, so that dead engines may be easily pulled in or out of the house.

Drop pits are a very essential part of the roundhouse equipment, even when heavy repairs are not the rule. The rapid wear of truck wheels under large capacity tanks, and the frequent mishaps to trailer wheels makes it necessary to drop wheels at frequent intervals.

The tool room should be run on the check system, and not only should the man in charge see that tools are returned and kept in order, but he should make necessary repairs as well, and otherwise see that tools are ready for immediate use. The room should be large enough so that the entire tool equipment can be kept there, including jacks, pinch bars, etc.

There should be combined with the tool room a sub-store room, which should carry a certain stock of bolts, nuts, washers, cotter keys, small pipe fittings, etc. This will avoid unnecessary trips to the store room.

Ordinarily, a considerable part of the time of mechanics is consumed getting together necessary tools for the work. In order to facilitate matters, some of the mechanics should be provided with portable tool boxes, which should contain all the tools for the special work they are assigned to. This tool box can easily be wheeled to the place where the work is to be done, and obviates the need of workmen running back and forth to their tool drawers or to the tool room for necessary tools. These boxes are also convenient to stand on for some kinds of overhead work. A portable tool box and work bench combined is still more valuable for certain special workers. Of course a good vise must be attached to the bench.

To facilitate moving from one engine to another, all special tools such as boring bars, valve setting rollers, tire setting outfits, etc., should be mounted on suitable wagons. When not in use these should be wheeled to a special place provided for them.

A portable floor crane for handling cylinder heads, pistons,

main rod ends, and other heavy parts below the running board is a very valuable addition to the tool equipment of any roundhouse.

Some means should be provided for moving heavy parts such as pistons and side rods to and from the machine shop. A special two-wheeled wagon, with a long tongue will answer the purpose very well. Some engine houses are provided with a narrow gage industrial track, which extends around the outer wall of the inside of roundhouse, and to the machine shop, store house, etc. Small push cars are operated on this track for transporting heavy parts and material.

To prevent boiler washers from dragging the washout hose from one engine to another, they should be provided with a cart on which is a reel for rolling the hose. A place should be provided in the body of the cart for carrying wrenches, nozzles, etc. This scheme also has the advantage of keeping the hose off the floor when it is not in use.

MACHINE SHOP AND AIR BRAKE ROOM.

When the engine house is segregated from the back shop, and fairly heavy repairs are to be made, a complete machine shop should be provided. The following machine tools are recommended to meet average conditions:

1 16 in. Bolt lathe.	1 Bolt cutter to take up to 2 in.
1 18 in. Lathe.	1 Turret head bolt cutter
1 24 in. Lathe.	1/2 in.—1 1/2 in.
1 20 in. Drill press.	1 Pipe threading machine.
1 40 in. Heavy drill press.	1 Cut-off saw.
1 22 in. Shaper.	1 Emery wheel.
1 48 in. x 48 in. x 8 ft. Planer.	1 Hydraulic or screw press for driving box brasses, rod bushings, etc.
1 36 in. Boring mill.	

A boring mill is a rather expensive machine, and if conditions do not warrant the added expense, an attachment for holding rocker boxes, driving boxes, etc., to the carriage of a lathe can be obtained. This can be adjusted to any height. The boring bar is carried on the centers of the lathe, and as heavy a bar as is possible on a horizontal mill, can be used.

The air brake room should be located in the machine shop and it should contain all the special tools for maintaining air brake apparatus. Suitable testing racks should be provided, so that feed valves, etc., can be tested before they are applied. Here, also, repairs should be made to special appliances such as super-heater dampers, lubricators, injectors, etc.

A blacksmith shop equipped with at least one power hammer, and one or two open forges should be operated in connection with the machine shop.

In order that the engine house foreman may get in rapid communication with various under-foremen and others, at large terminals, there should be a telephone system between master mechanic's office, roundhouse office, clinker pit, coal chute, and other points that local conditions will determine.

In every large engine house more or less time is spent by the different foremen looking for each other when something important turns up. As an aid in this direction, an air whistle can be located in some convenient place in the roundhouse, and a suitable code of signals can be arranged. This system of signaling has been installed in Los Angeles engine house of the Southern Pacific, and with splendid results.

SAFETY FIRST.—Everything possible should be done by an establishment to hold its supervisors alive to the importance of preventing chances for accident, to adopt accident prevention and safety devices wherever possible, but not to depend upon these devices to the exclusion of the eternal vigilance required from every individual connected with the place to consider safety first. It is admitted that all this makes an extra load to carry, but humanity alone would require it, if indeed the selfish side of it did not make it obligatory at the present time.—*Thomas D. West before the American Foundrymen's Association.*

SCRAPPING LOCOMOTIVE BOILERS WITH THE OXY-ACETYLENE TORCH

BY PAUL PLEISS

While the oxy-acetylene welding torch has come into prominence in connection with the repairing of locomotive fireboxes, in general railroads have been backward in adopting it as part of their shop equipment, the reason given being that the cost of operation of the cutting torch renders its general use prohibitive. Lack of knowledge on the part of the operator may be blamed for this mistaken idea in the majority of cases. The work of cutting steel with the torch is cheaper by far than the cutting by any other method. This is particularly the case when the material to be cut is of such shape that its transportation to the shears is a difficult matter.

In order to effect the cut as quickly as possible, with a proportionate saving in the oxygen consumed, it is necessary that the metal present as clean a surface as possible, and it is recommended that the parts to be cut be cleaned with a stiff wire brush. This will remove the major portion of the rust and scale which accumulates on boilers.

On account of the varying conditions of steel it is almost impossible to give one figure for the cutting, as conditions play such an important part, but the figures following will give an idea of the saving which may be made with the oxy-acetylene



Boiler Being Cut with the Oxy-Acetylene Torch for Scrapping.

cutting torch. The figures are actual, having been compiled by the owner of the equipment who was anxious to learn its actual costs for cutting. The material in all cases consisted of locomotive boilers, to be scrapped in such a size as to allow them to be taken to the shears and cut. The sizes averaged 3 ft. wide and 6 or 7 ft. long.

Boiler No. 1.—Weight, 21 tons, 6 tons of which were cut; 5/8 in. metal; 115 lineal ft. of cutting.

Cost: 350 cu. ft. of oxygen at 2c.....	\$7.90
45 cu. ft. of acetylene at 2c.....	.90
4 hours labor at 42 1/2c.....	1.70

Total cost for 115 lineal ft.....	\$9.60
Cost per lineal ft.....	.083
Cost per ton (6 tons cut).....	1.60

Boiler No. 2.—Weight of boiler, 2 tons; 5/8 in. metal; 95 lineal ft. of cutting.

Cost: 250 cu. ft. of oxygen at 2c.....	\$5.00
20 cu. ft. of acetylene at 2c.....	.60
4 hours labor at 42 1/2c.....	1.70

Total cost for 95 lineal ft.....	\$7.30
Cost per lineal ft.....	.0769
Cost per ton.....	3.65

Boiler No. 3.—Weight of boiler, 4 tons; 7/16 in. metal; 87 lineal ft. of cutting.

Cost: 150 cu. ft. of oxygen at 2c.....	\$3.00
20 cu. ft. of acetylene at 2c.....	.40
2 1/2 hours labor at 42 1/2c.....	1.07

Total cost for 87 lineal ft.....	\$4.47
Cost per ft.....	.051
Cost per ton.....	1.12

<i>Boiler No. 4.</i> —Weight of boiler, 8 tons; 9/16 in. metal; 19.5 ft. of cutting.	
Cost: 50 cu. ft. of oxygen at 2c.....	\$1.00
6 cu. ft. of acetylene at 2c.....	.12
1 hour labor at 42½c.....	.425
Total cost for 19.5 lineal ft.....	\$1.545
Cost per ft.....	.079
<i>Boilers Nos. 5, 6 and 7.</i> —Weight of boilers, 15 tons; 7/16 in. metal; 675 lineal ft. of cutting; cuts 20 in. x 6 ft.	
Cost: 1,350 cu. ft. of oxygen at 2c.....	\$27.00
450 cu. ft. of acetylene at 2c.....	9.00
24 hours labor at 42½c.....	10.20
Total cost for 675 lineal ft.....	\$46.20
Cost per ft.....	.068
Cost per ton.....	3.08
<i>Boiler in Place on a Locomotive.</i> —This included the cutting of the frames, smokestack, guide yokes, connecting rods, guides and other parts. The cutting was done in such a way as to allow the operator access to the boiler in order to cut it in position. The total length of the cut was not taken nor was the thickness of the material taken into consideration.	
Cost: 350 cu. ft. of oxygen at 2c.....	\$7.00
50 cu. ft. of acetylene at 2c.....	1.00
4¼ hours labor at 42½c.....	1.92
	\$9.92

MACHINE FOR TURNING BALL JOINTS

This machine, which was designed for turning the ball joints of steam pipes, is secured to the work by means of a chuck *A*, and is centered by the set screw *B*. The correct radius of the joint is obtained by adjusting the tool *C*, while the depth of the cut is regulated by screwing the bushing *D* in or out. This bushing is held in place by a set screw which is not shown in the illustration.

In operating the machine, the transmission housing is held stationary by the operator grasping the pipe *E* with one hand, while

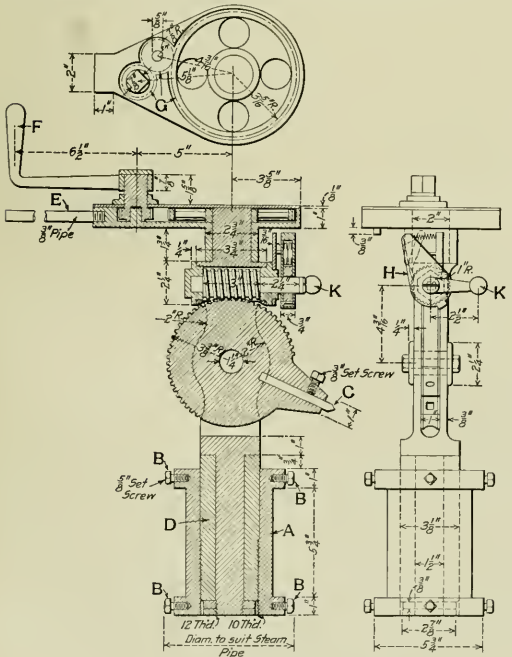

Machine for Turning Ball Joints of Any Radius.

with the other he turns the crank *F*. As the machine can feed but one way, a ratchet is provided on this crank to prevent its turning the gears backward. The entire body of the machine, including the tool *C*, is turned by the crank through the gears *G*,

while the ratchet *H* feeds the tool one notch each revolution through the worm. A crank *K* is provided to move the feed mechanism independently when necessary. The device is the invention of W. C. Deibert, tool foreman of the Chesapeake & Ohio at Clifton Forge, Va., and is in successful use at that point.

INSTALLATION AND MAINTENANCE OF ELECTRIC HEADLIGHT EQUIPMENT

BY V. T. KROPIDLOWSKI

IV

This article is intended to help the reader in familiarizing himself with the various parts of the dynamo for electric headlights. It will not be necessary to go over the last article (*Railway Age Gazette, Mechanical Edition, October, 1913, page 546*), but the reader should keep it before him. The figures used in the last article are made use of here to represent the same details. For example, Fig. 11 represents the Schroeder generator as in the preceding article, but here it is shown more nearly as it actually appears. It will therefore be necessary to explain the newly introduced details relating to the construction, which are considered most important, and it will be necessary for the reader to trace out the other numbered details in the article in the October number.

It is most important to keep in mind the insulation of the different parts, as upon this the successful operation of any electric apparatus depends and it is where most of the trouble arises, due largely to negligence and ignorance. It will be found, therefore, in the drawings that the insulation washers, bushings, etc., are conspicuously shown.

Fig. 11, as previously mentioned, is a front view of the Schroeder generator, with a section taken through the extension of the bearing housing to show the brush holders clearly. The bearing housing *C* is fastened to the field frame by tap bolts. The brush holders are secured to the bearing housing *C* with machine screws and carefully insulated from it as shown at *B* (this is shown plainer in Fig. 1) with fiber washers and a fiber bushing. The pressure with which the carbon brush should bear on the commutator is regulated by a coil spring, of which a top view is given in Fig. 1, and the tension of the spring is adjusted by the small lever *a*. The bolt *No. 30* is passed through the base of the brush holder, which has a slot *d* in it, in which the inner end of the coil spring is securely fastened, the adjusting being done by lifting the lever *a* out of the notch it happens to be in and turning it to the right or left (depending on whether the tension should be increased or decreased) and again allowing the lever to snap into one of the notches.

Fig. 2 shows how the field coils of the Schroeder machine are held in place. In order to remove the fields, take out the brushes before taking off the housing *C*, and also disconnect all the wiring; then loosen the set screw which is under the name plate on top of the field frame. This will loosen the hinge *F*, Fig. 2, when it and the fiber protector *G* can be taken out; do the same with the lower hinge by unscrewing the set screw under the field frame (this is not shown in the drawing) and the coils can then be slipped off the pole pieces. Fig. 3 shows the field coils removed. The machine is compound wound and therefore each of the two completed coils consists of two windings. The compound winding is in the inner circle of the coil and the shunt winding, of which there is much more and the wire of much smaller diameter, composes the outside circumference of the coil. The shunt winding commences at *h* and the compound coil at *i*; a lead wire is soldered to each of the ends, the two ends soldered together at *e* and a common lead brought out to connection *No. 5* of the brush, shown in Figs. 1 and 11. To the end of the shunt and series windings of this first coil are again

soldered two leads at *j* and *k*, these being carried over to the next coil and again soldered to the starting ends of the shunt and compound windings respectively at *l* and *m*. To the ends of the windings of this second coil are again connected lead wires at *n* and *o*, *n* being the shunt, and *o* the compound ends. The

this having two connections, *No. 7* and *No. 8*, which are connected respectively to *No. 7* and *No. 8* in Fig. 11. The shunt and compound windings are wound separately and taped, then the compound coil is inserted in the inner circle of the shunt coil and both are again taped to form a unit.

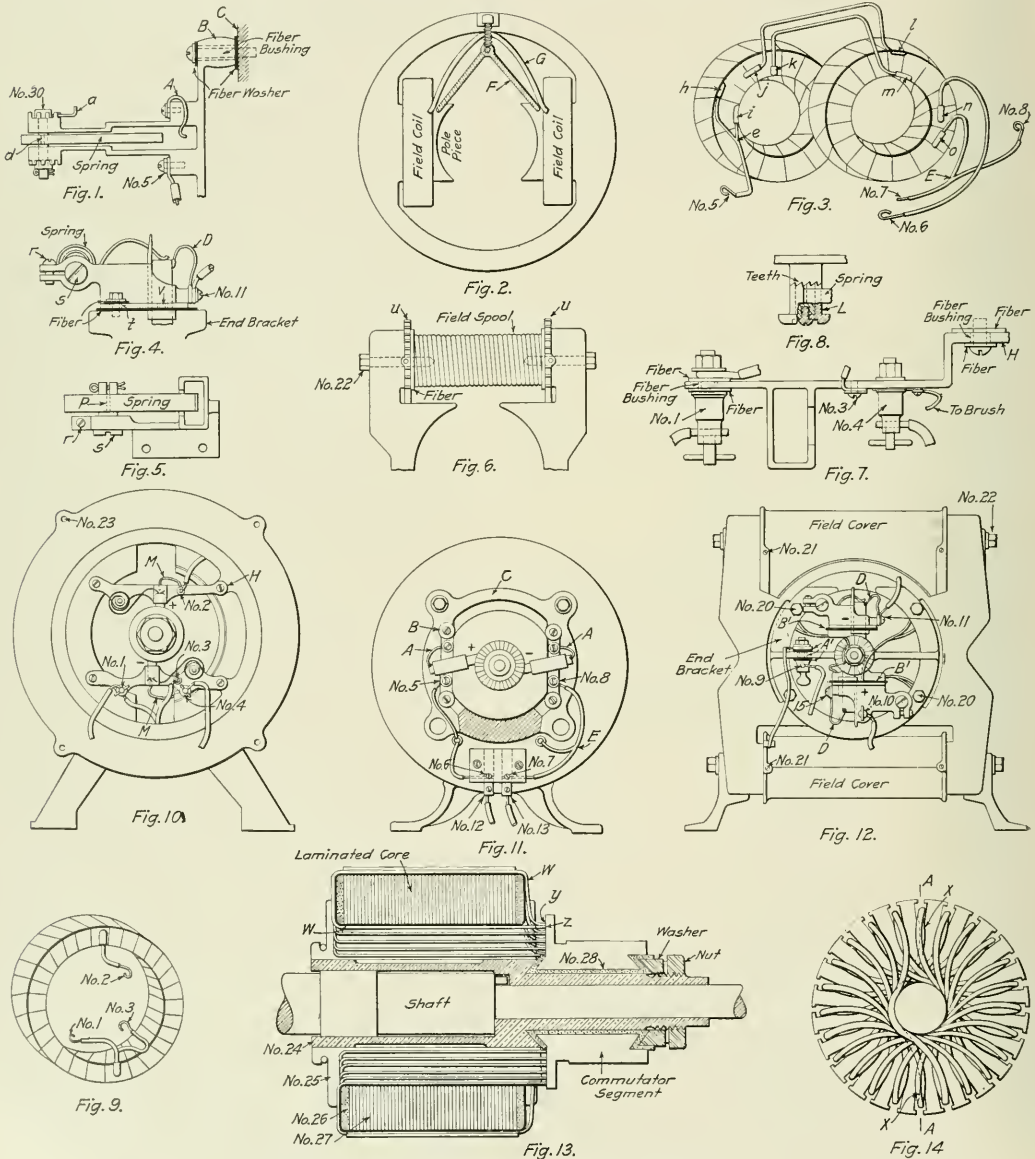

Arrangement of Parts and Connections on Electric Headlight Dynamo.

lead of the compound winding is brought out separately and connected to the brass tube in the fiber block which is fastened to the face of the field frame, as shown at *No. 6*, Fig. 11. The lead of the shunt winding is soldered to a heavier lead at *E*,

Fig. 12 shows the front view of the American generator with part of the end bracket broken off to show a portion of the commutator; this gives a plainer view of the brushes and brush holders. The construction of the brush holders and their man-

ner of application to the end bracket is shown more clearly in Figs. 4 and 5, which show respectively side and top views of the upper brush holder. The brush holders are insulated from the end bracket by fiber washers under the head of the cap bolt and under the entire brush holder, and the cap bolt is prevented from connecting the holder and the end bracket metallicly by the fiber bushing *t*; the other cap bolt which belongs at *v* is not shown. The pressure of the brushes on the commutator is caused by the tension of a coil spring similar to that of the Schroeder machine, but the arrangement for regulating the tension is somewhat different. The pin *s* is split for receiving the inner end of the coil spring, and by loosening the machine screw *r* the pin *s* may be turned with a screw driver to adjust the tension. The letters *A'* and *B'*, Fig. 12, represent respectively the insulators of the binding post No. 9 and the brush holders. The flexible leads, *D*, connect the carbon brushes to the binding screws of the brush holders. The current from the positive brush goes through *D*, Fig. 12, to the screw No. 15, through the brush holder to binding post No. 10, to the outside circuit through the wire connected to No. 10, from the outside circuit to binding post No. 9, from there to the field winding by way of the wire connected to No. 9, out from the field to No. 11, and through *D* to the negative brush. In case the field spools of this machine need to be removed, the end bracket is first removed by unscrewing the tap bolts No. 20, which secure it to the pole pieces, the field covers are then removed by unscrewing the small screws No. 21; the tap bolts No. 22 are unscrewed, when the field spool can be removed. Fig. 6 shows one of the field spools when the cover is removed, *u* being the bracket to which the field cover is screwed.

In Fig. 10 is shown a front view of the Pyle generator. The construction of the brush holders, as well as the way they are applied to the front half of the field frame, is shown in Figs. 7 and 8. The brush holders are insulated from the field frame at *H*, Figs. 7 and 10, by fiber washers and a bushing in the foot of the holder to prevent the screw from touching it; this is done at the foot of both holders, where they are secured to the frame. Binding post No. 4 is not insulated from the brush holder, as the negative side of the outside circuit is connected there, making direct contact with the negative brush. The binding post No. 1 is insulated from the holder, as shown in Fig. 7, as that is where the current from the compound field, which comes from the positive brush and enters the field at No. 2, Fig. 10, enters the outside circuit; one of these parts must be insulated, as otherwise the minus and plus sides of the machine would be brought together and a short circuit would result.

The method of adjusting the brush tension spring on this machine is shown in Fig. 8. The boss of the holder has notches, or teeth, and a stem projects from the boss, which is turned to a smaller diameter; a sleeve, also having teeth, is made to slip over the stem. This sleeve *L*, is drilled through its head to allow a small machine screw to pass, and the stem is threaded for this screw. A coil spring is used, the inner end engaging in a recess in the sleeve; to adjust the tension the small screw is loosened enough to disengage the teeth of the sleeve and boss, when the sleeve can be turned either way.

The manner of winding and the construction of a ring wound armature are shown in Fig. 13. There are many other ways of constructing this style of armature, but the principle is the same in all, only the disposition of the wires being different. A brass sleeve No. 24 and ribs No. 25 constitute what is called a spider; this should be of brass so as to be non-magnetic. The armature core is built up on the ribs of the spider and consists of round slotted discs of very thin sheet steel, varnished on both sides so as to reduce what are termed eddy currents, which heat the core and cause waste of energy. In the construction of this armature the thin sheets are assembled, forced together under high pressure and held with clamps until the ribs No. 25, are slipped on from inside the laminated core and properly spaced;

the clamps are then removed and the core is held together by these ribs, which have lips projecting about half the thickness of the core. Fiber discs No. 26 prevent the wiring from coming in contact with the iron core in case any of the insulation should become damaged. In case any of the wires of the winding became damaged so as to short circuit part of the armature, the damaged coil must be removed and replaced by a good coil. If, for example, coil *W'* needs to be removed, the two soldered ends should be removed from the commutator segments at *Y* and *Z* and the ends pulled out until the turns of the coil are unwound. For simplicity, only one wire per coil is shown, but actually there are about six wires or turns to a coil. A new coil can be similarly wound in the empty space. In this type of armature it is a simple matter to replace a coil, but it is still easier to remove one from an armature having form wound coils; this type is extensively used, but not in any of the machines shown in this article.

The removal of a coil from the type of armature shown in Fig. 14, which is an end view of a hand wound drum armature, is very difficult. The entire winding must be unwound in order to remove one coil. For instance, if it is desired to remove coil *X*, which is the first one wound on the core, the entire winding must be unwound, as all the winding is wound over it; this means, in this case, 48 coils, and if each coil has four turns (only one turn per coil is shown, for simplicity) it is easily seen what an extensive piece of work it is. Fortunately, it is seldom necessary to remove a coil under ordinary conditions, so there need be no hesitation in employing this style of armature. In the recent larger machines, form wound coils are used exclusively, but in these sizes hand winding is invariably resorted to. If but one coil is damaged, and it happens to be one of the top ones, an expert could possibly cut both ends of the coil, pull it out and insert a new winding, but this cannot be done in all cases.

AIR PUMP STEAM HEAD REPAIRS

BY J. A. JESSON.

Air Brake Foreman, Louisville & Nashville, Corbin, Ky.

The accompanying illustrations show successful methods used in repairing the steam head of a Westinghouse air pump. Fig. 1 shows the method of re boring the large main valve cylinder. An adjustable blade shell reamer *A* operating on the arbor *B* is placed in the cylinder with the blades loose, the reamer being

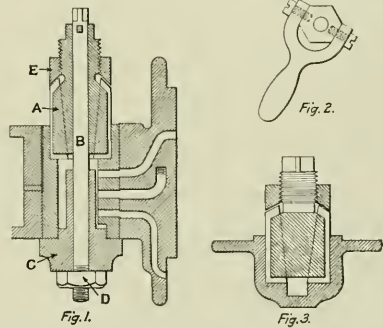

Reamers for Repairing the Main Valve Cylinder of Air Pumps.

attached to the arbor by a pin at the top. The arbor has a close fit in the guide *C*, and when it is drawn downward by the nut *D* the reamer blades are forced out. They are then locked by the nut *E* and the reamer is revolved, making the first cut. The nut *E* is then slackened, the blades are distended still further, and a second cut is taken, the nut *E* locking the blades in their

new position as before. This process is repeated until the cylinder has been made true, and it is found that it will stand considerable enlargement before it is necessary to change from the standard size piston. Fig. 2 shows a handle that may be easily attached to the nut *D* to turn it. The blades of the reamer should be ground parallel for their full length and with about the same clearance as an end mill.

The method of truing the small main valve cylinder is indicated in Fig. 3. A solid adjustable blade reamer is used in this case, the blades being distended by tapping the reamer body instead of pulling it down as in Fig. 1. This cylinder can usually be trued up once and still use the standard piston; after that it should be scrapped or used with a piston larger than the standard. The piston rings should be ground to fit the cylinder and should have a true face on the side toward the exhaust. The reamer blades should be ground the same as those in Fig. 1.

The method of reborring the reversing valve bushing of a 9½ in. pump is shown in Fig. 4. A shell reamer with a straight hole is used on a ¾ in. arbor, which is held in the bushing as shown. With a suitable hollow wrench to fit over the pilot and in the

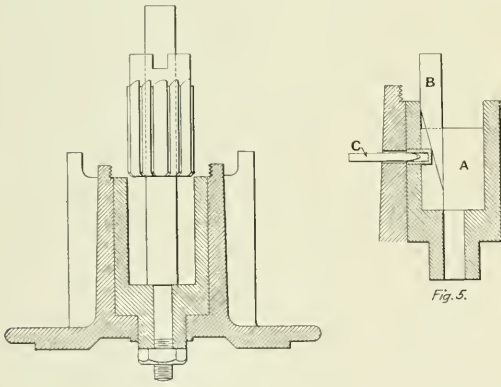

Repairing Reversing Valve Bushings of Air Pump Steam Head.

keyways of the reamer the bushing can easily be reamed by hand.

An easy method of placing a dowel in the reversing valve bushing is shown in Fig. 5. A 3/16 in. hole is drilled in the dowel pin to about two-thirds its length and the end is tapered a little so that it may be easily started. A steel block *A*, 1½ in. in diameter and having a slot deep enough to clear the dowel and the point of the wedged driver *B*, is placed in the bushing. By driving the wedge *B* down, the dowel is forced. The taper pin *C* is then used to spread the hollow end of the dowel, making a tight fit in the bushing.

THE MECHANICAL STOKER.—For the past nine years the Pennsylvania Lines West of Pittsburgh have been working to develop a mechanical stoker for locomotive use, and the results so far have been sufficiently satisfactory to warrant its application to a total of 300 locomotives, of which 215 are at work—66 in passenger, 130 in freight, and 19 in switching service.

SMOKE AND MECHANICAL STOKERS.—Repeated comparisons of the smoke produced by locomotives with and without the stoker show that those equipped with the stoker may be operated with from one-tenth to one-third of the smoke made by similar locomotives in the same service without the stoker, the amount of the reduction depending on the class of service and continuity of the run.—*D. F. Crawford before the International Society for the Prevention of Smoke.*

BOILER TUBE RACK

BY C. M. NEWMAN,

General Foreman, Atlantic Coast Line, South Rocky Mount, N. C.

There are in use in the boiler shop of the Atlantic Coast Line at South Rocky Mount, N. C., several very convenient racks for handling tubes. These are so constructed that they may be placed in front of a locomotive at a convenient height to receive the tubes as they are being passed out of the boiler. The legs are not attached to the rack, and it may be lifted entirely clear from them and placed on an ordinary push car

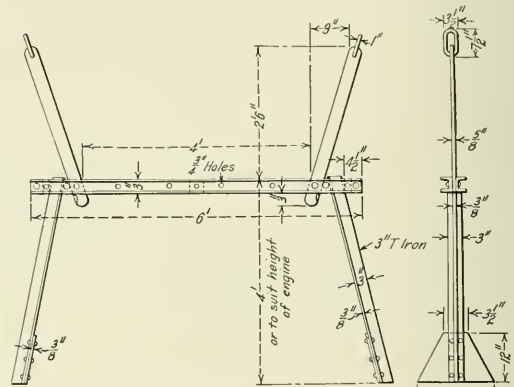

Rack For Handling Tubes
Rack Used for Boiler Tubes.

and a load of tubes delivered at any point desired. Only half of the rack is shown in the illustration and a carrier or sling is also shown for handling the rack. The ¾ in. holes between the uprights are for temporary uprights to separate the flues when they are cut to different lengths to suit the variations in the sheets. For these temporary uprights, pieces of scrap tube or pipe, flattened at one end, are used; the flattened end is punched with a ¾ in. hole and the upright is held in place by a bolt. This type of rack is used at the Rocky Mount shops to

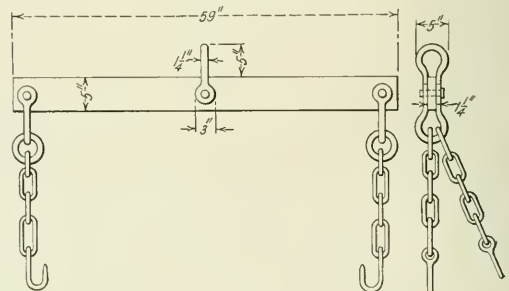

Device for Lifting Boiler Tube Rack.

handle as many as 336 2-in. tubes, 14 ft. 6 in. long. When the racks are not in use they can be knocked down and occupy but very little space when piled in the shop.

STOPPING TRAINS BY WIRELESS.—A system of stopping moving trains by wireless has been invented by Professor C. Wirth, of Nuremberg, who was also the inventor of the wireless distance boat.—*The Engineer.*

CAR DEPARTMENT

TESTS OF PASSENGER CAR LIGHTING

Tests covering an investigation of the relative engineering merits of center deck and half deck system of location of lighting units in passenger coaches, the proper spacing, efficiency, illumination intensity, and uniformity of all distinctive types of lighting units of both the gas and electric systems, were recently made by the committee on illumination of the Association of Railway Electrical Engineers. The results of the tests are given in the report of this committee presented at the convention held in Chicago, October 20 to 24.

The coach employed in the test was a standard Lake Shore & Michigan Southern, 70 ft. steel underframe car, finished in light mahogany with medium olive color head lining and a dark olive green seat covering. The upper deck construction is the Empire or standard New York Central design. The tests were made at the Collinwood shops of this road and lasted about eight weeks.

It has been the generally accepted practice in comparing different systems of lighting to measure the illumination on a horizontal plane at a height above the floor corresponding to that of a typical desk or table. In these tests, however, the committee felt that the investigation of the illumination produced at the point where it would be used most frequently by the passengers was of greater importance than a comparison of the different lighting units as determined by measurement on a more or less arbitrary plane. The illumination was therefore, measured on a 45 deg. plane, 33 in. above the floor and directly above the front edge of the seat cushion, as representing more closely the average position in which reading matter is held by the passengers. Readings, however, were also taken in the usual horizontal reference plane, 33 in. above the floor to provide data for those who wish to compare the results of this investigation with other coach lighting tests, as well as to establish the ratio of illumination produced on the two separate planes with different types of units. The test stations in the latter case were 2 $\frac{1}{4}$ in. back from the front edge of the seat.

In the report of these tests the words "candle power" are the term used to express the intensity, or pressure, of light emanating in any given direction from a light source. It corresponds, for instance, to steam pressure in steam engineering and voltage in electrical engineering.

The word "lumen" is the term used to express the quantity of light emanated from a light source. It is analogous to the term horse power and watt as used in steam and electrical engineering. It is also defined as a quantity of light which is emitted in a unit solid angle per unit of time. The unit solid angle is that which intercepts a unit area on the surface of the sphere of unit radius. A uniform source of one candle unit emanates 4π lumens. Therefore the total lumens emitted by any lamp source can be obtained by multiplying its mean spherical candle power by 12.57. The rated lumens as given by the lamp manufacturers of the 15 watt G-18 $\frac{1}{2}$ train lighting bulb is 119 and of the 50 watt G-30 bulb 397 lumens. To express the values in round numbers, 120 lumens for the 15 watt lamp and 400 lumens for the 50 watt lamp has been used in the test data, and all results are reduced to this basis, being expressed usually as so many lumens per running foot of car. To ascertain the illumination obtained using other sizes of lamps with any given type and arrangement of units it is necessary only to obtain the generated lumens per foot of car under the new conditions by dividing the total lumens in the passenger compartment of the car by the length of that compartment.

Three different features were investigated by these tests. First, to determine the best location and spacing of light units in the car. Second, to determine illumination efficiency and uniformity of various types of lighting units. And third, tests to determine the effect of changing the color of the head lining.

In regard to the first feature, the test showed that as far as efficiency and uniformity of distribution of the illumination produced was concerned, there was practically no difference between the center deck and the half deck systems of locating the light units. The half deck system, however, involves the installation of at least twice as many units as the center deck system, thus materially increasing cleaning cost, reflector and lamp maintenance. In connection with the proper spacing of the lamps the conclusions of the committee are that the most satisfactory illumination results are obtained with a spacing of lighting units, for the direct system of lighting in coaches, of not more than two seats (6 ft.). With indirect lighting, however, the ceiling may be considered the light source as far as its effect on the illumination produced is concerned and on account of its greater height above the seat level, as well as the large area of illuminating surface compared with direct lighting, entirely satisfactory results can be obtained with the three seat (approximately 9 ft.) spacing with this type of light.

The tests to determine the value of the various types of lighting units from the point of view of illuminating efficiency show a wide range in the various units. The more efficient ones produced over twice the units of illumination compared on an equal wattage basis. Tests were made with both open mouth reflectors of various types, bare lamps, and enclosed units, with different types of globes and reflectors. In comparing the electric lighting fixtures, all results were reduced to the same total wattage, representing 66 $\frac{2}{3}$ generated lumens per running foot of car and, on the basis of illuminating efficiency or the percentage effective lumens on 45 deg. angle plane, the bare lamp gives a result of 16.3, and an enclosed unit with a light density opal globe gives 14.6, which is the lowest value recorded. Totally indirect units give a value of 17.4 and semi-indirect of 19.8. The highest efficiency, however, was given with open mouth mirrored glass reflectors which gave 39.5. On account, however, of this type of reflector being opaque and throwing heavy shadows on the deck its use can hardly be considered for direct lighting units for coach service. The next best record was given by an open mouth prismatic clear reflector which gave 34.2, and the next highest efficiency was given by an open mouth heavy density opal reflector which gave an average of 30.3. The latter, however, gave a value much lower on the window side of the seat, but in spite of this, the committee stated that its efficiency is so high that it should possess considerable attraction for those who object to the appearance and the cleaning question involved in the clear prismatic type but who do not wish to sacrifice lighting efficiency. Except in a few forms of passenger car construction, the efficiency of the indirect lighting system is rather low, and it cannot be recommended for general use until a decided advancement has been made in improving the efficiency of the tungsten lamp.

The committee reports that the need of a train lighting lamp of higher lumens capacity is indicated by the tests, but that, at the present time, none is available except at an increase in wattage which, from an operating point of view, is highly undesirable. With the present standard train lighting lamps, therefore, the use of only the most efficient types of lighting units is recommended for electric lighting where the best illumination results are to be obtained.

As might be expected the result of the test on the color of head lining showed that it had no appreciable effect on the useful illumination produced except where the lighting unit used gave a considerable portion of light by transmitting it to the ceiling. The use of a light colored head lining, however, is recommended by the committee as it produces a more cheerful effect in the car.

REPAIRING BALLAST CARS

BY KEYSER

The conditions under which the ballasting of railways is done vary to a considerable extent, depending on whether the line is under construction or is being rebuilt or repaired, the density of traffic, etc., but in too many cases little or no serious attention is given to the matter of repairing the cars used for such work. Ballast cars are very commonly treated as of small importance, and repairs which are really necessary are often allowed to pass with little or no attention, the fact that a broken or burned off journal or a trailing brake beam on such cars can cause just as much delay to traffic as a similar condition on any other class of car seeming to be overlooked.

When ballasting has to be done there seems to be, on the part of some railway officers, objection to putting on more than one or two extra car repairers to take care of the work of ballast car repairs. When a ballast pit is so located in relation to an established terminal that the repair work can be handled by the regular car repair staff, this policy, while it is to be deplored, is not so serious as in an isolated district, as the work can generally be done by overtime if necessary. But when the point of ballast supply is on an isolated branch or so located on a division as to necessitate the repair work being handled at or near the pit, it often becomes very serious. It is impossible for one or two car repairers to properly look after repairs to any great number of cars and the policy of letting bad order cars accumulate until there are enough to require a special train to move them to a terminal is a poor one, as is that of allowing the repairs to be entirely neglected.

In a case which came under the writer's notice, the work was handled with much satisfaction to all the departments concerned, and as there was not a single case of ballast car failure causing a delay to traffic during the three months the work was in progress, it was considered that the method followed was justified. The ballast pit was located a short distance off the main line and the track between the pit and the main line was little used and in poor condition so that the heavier classes of locomotives could not be used and it was necessary to either double head on 28 car trains or haul only 14 cars in a train. There were two shovels in use and the haul varied in length from about 10 to 70 miles, there being no other pit available within that distance. The repair gang consisted of a foreman who also acted as inspector, a man who looked after air brake repairs and the keeping of the journal boxes well packed, two repair men and two helpers. All classes of repairs were handled except such work as repairing broken sills, and as there was only one case of this kind, the car was removed from service and left idle.

In work of this nature there is often too little attention given to the matter of quarters for the men. In this instance there was of course, the regular assignment of boarding cars for the track men, etc., and a special car was carefully fitted up with bunks, mattresses, etc., for the exclusive use of the car and locomotive repair men, as much as possible of the locomotive repairs also being made at the pit. The meals were served with those of all the other men in the car provided for the purpose.

As soon as a train returned from a trip it was inspected and any bad order cars thrown out and placed on a track provided

for repair work. This track was located out of the way of the shovels on ground over which they had previously passed and the gravel made a good dry surface for the work. Adjacent to this track was a shorter one on which cars requiring wheels changed were placed. When inspecting a train, the foreman made a note of any cars which required only trivial repairs, such as brake wheels, renewal of nuts, etc., and later assigned a man to do this work in the train, thus avoiding much of the switching which would have been necessary had the cars been moved to the repair track. The man in charge of the ballast trains was notified twice a day as to what cars were again ready for service, and these were generally switched out and replaced in the trains at noon and in the evening. The man in charge of the oiling made it a point to examine the journals of each car once a day and hot boxes, one of the greatest bugbears of ballast train work, were almost unknown.

One of the most important considerations in work of this kind is that of supplies. The writer has seen ballast pits at which a material car was furnished containing a mass of bolts, brasses, wedges, etc., thrown in indiscriminately and causing no end of trouble and much wasted time in finding material when wanted. In this case two box cars were provided, one for general stores and one for oil. One side of each was boarded up and a good lock was applied to the door on the other side, with keys for the mechanical men only. The store car was arranged inside with boxes and pigeon holes and a good supply of each necessary size of bolt, etc., furnished. It is a mistake, in fitting up store cars, to provide material that is not likely to be used; it is in the way and takes up space which may be needed for such important material as draft timber bolts, brasses, etc. The oil car had racks for barrels and bins for waste and each man was held personally responsible for the neat and cleanly appearance of both cars. A daily inspection of the material on hand was made and the nearest terminal telegraphed for additions a sufficient time in advance to prevent the supply becoming entirely exhausted. Draft timber bolts, journal bearings, and oil and waste for dope are among the most important items, and a good supply should always be kept on hand. Wheels were furnished a carload at a time, and were unloaded next to the wheel changing track, while three complete couplers were kept available at all times.

The man in charge of the car repair work at this ballast pit had had experience in a number of other pits and knew the conditions which generally obtain. In consequence he saw to it that his supply cars were furnished in an efficient manner and organized his staff along lines which he had worked out from his experience. The locomotive work was handled separately from the car repairs. The results proved most satisfactory, there being no failures of ballast cars on the road during the entire time that the work was in progress and a minimum of hot boxes. Enginemmen knew, in starting out with a train, that the slack in the brakes was properly adjusted and that they did not need to take chances in making stops. The conditions were particularly appreciated by the trainmaster and other operating officers and the trainmen, when they learned that real efforts were being made to keep the car equipment in good shape, went out of their way to help in the work instead of using it as roughly as possible, as is more often the case. Considered from any viewpoint, the results obtained fully justified the efforts which were made.

TRAFFIC ON THE NEW YORK SUBWAY.—The total number of passengers carried last year by the Interborough Rapid Transit Company on the subway and elevated lines in New York City was 634,316,516, an increase of more than 27,000,000 over the previous year. The greater part of this increase was on the subway division, and was due principally to the ten-car express service.

WABASH 60-FOOT STEEL POSTAL CAR

Built in Conformity With the Latest Post Office Department Specifications and Drawings.

The Wabash Railroad has had in service for several months five all-steel, 60 ft., full postal cars which conform in every way to the railway mail service specifications as revised to December 28, 1912. These cars were the first full 60 ft. steel cars to be built to these specifications. They were designed by the American Car & Foundry Company and, together with a number of other all-steel passenger cars for this road, were built at the St. Charles plant.

The post office department specifications for the construc-

tion of steel full postal cars permit the use of four different types of construction. The first type permitted is the heavy center sill construction where the center sills act as main carrying members. Type II is of side carrying construction, the sides of the car acting as main carrying members, having their support at the bolsters. Type III is an underframe construction in which the load is carried on all the longitudinal members of the lower frame. Type IV is a combination

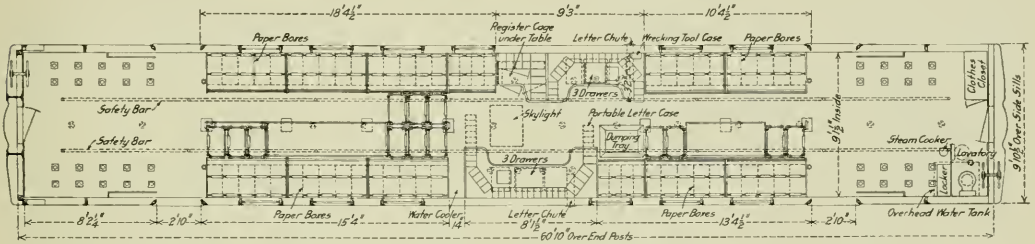

Plan of Sixty-Foot Full Postal Car; Wabash Railroad.

tion of steel full postal cars permit the use of four different types of construction. The first type permitted is the heavy center sill construction where the center sills act as main carrying members. Type II is of side carrying construction, the sides of the car acting as main carrying members, having their support at the bolsters. Type III is an underframe construction in which the load is carried on all the longitudinal members of the lower frame. Type IV is a combination

16 in. apart and having a top cover plate $\frac{1}{4}$ in. thick by 23 $\frac{1}{4}$ in. in width. The center sills and the cover plate extend in one section between the cast steel double body bolster and the end sill, to which they are securely riveted. The only other continuous longitudinal members in the underframe are the side sills which are 6 in. x 6 in. x $\frac{5}{8}$ in. angles continuous between end posts. These also form the bottom chord of the side frame truss. Between the body bolsters there are four



Exterior of Wabash Sixty-Foot Full Postal Car.

construction in which the side frames carry a part of the load transferring it to the center sills at points remote from the center plate for the purpose of utilizing a uniform center sill area. The Wabash cars are of type II where the side frame is used for the carrying members and transfers the load to the bolsters. This, of course, implies a light center sill of only sufficient area to take care of the buffing and pulling stresses. The specifications state that the maximum end

cross bearers of built-up pressed steel shapes and plates, and in addition the underframe is stiffened and the side and center sills are further tied by floor beams of pressed channel section. These are of No. 10 steel and, in connection with the cross bearers, carry the floor supports of No. 10 steel pressed in Z bar section arranged longitudinally as is shown in the illustration. These in turn support the lower floor of No. 16 steel plate. The upper floor, in two courses, is of

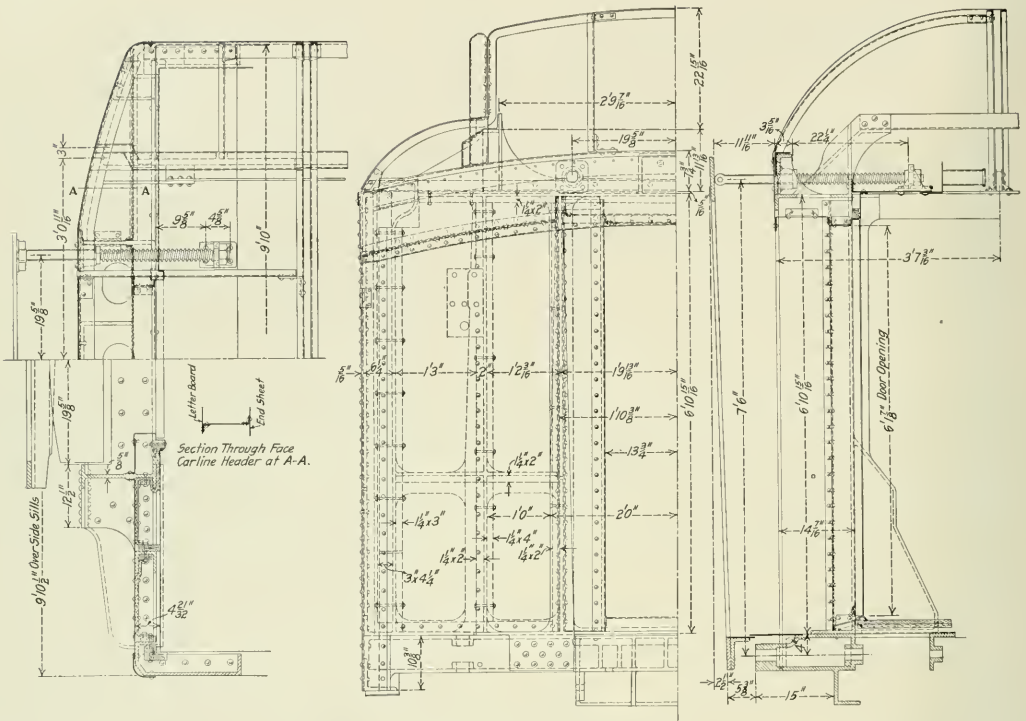

Hood and Cast Steel End Frame of Wabash Steel Postal Car.



Interior of Wabash Postal Car Showing Electric Fixtures and Excellent Natural Lighting.

wood, the lower course being yellow pine laid diagonally and the upper course maple, laid longitudinally. The wood floor rests on wood furring and is bolted through the lower floor sheet to the Z bar floor supports. The hair felt insulation is placed between the furring and above the steel plate.

continuous, but is arranged in sections between the vertical posts to which they are securely fastened.

At the door opening the full strength of the truss is maintained by the addition of a 1/4 in. plate reinforcement at the top and bottom and the use of 5 in., 6 lb. channels as the

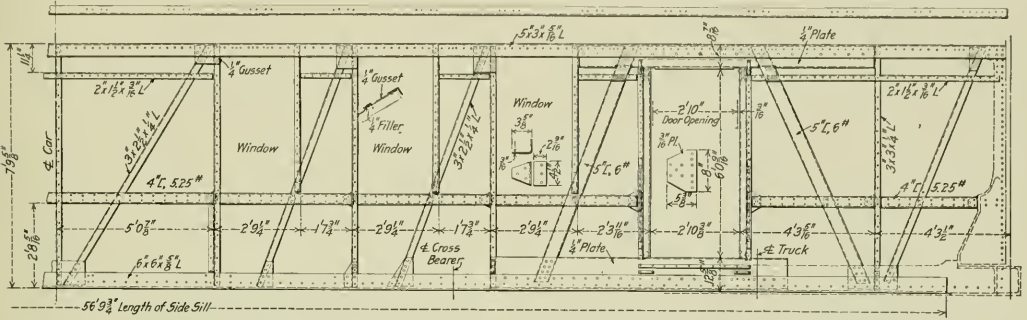

Side Framing of Sixty-Foot Steel Postal Car; Wabash Railroad.

The side frame truss occupies the full height of the car and is composed of a 6 in. x 6 in. x 5/8 in. angle side sill as the lower chord and a 5 in. x 3 in. x 5/16 in. angle side plate as the upper member. Between these are the vertical side posts which are 3 in. x 3 in. x 1/4 in. angles and the diagonal trusses of 3 in. x 2 1/2 in. x 1/4 in. angles which are continuous

diagonal braces on either side. It will be noted that special attention has been given to secure fastening between the various members and a 1/4 in. gusset plate of ample area for allowing enough rivets to develop the full strength of the section is found at practically every junction.

A steel casting manufactured by the Commonwealth Steel

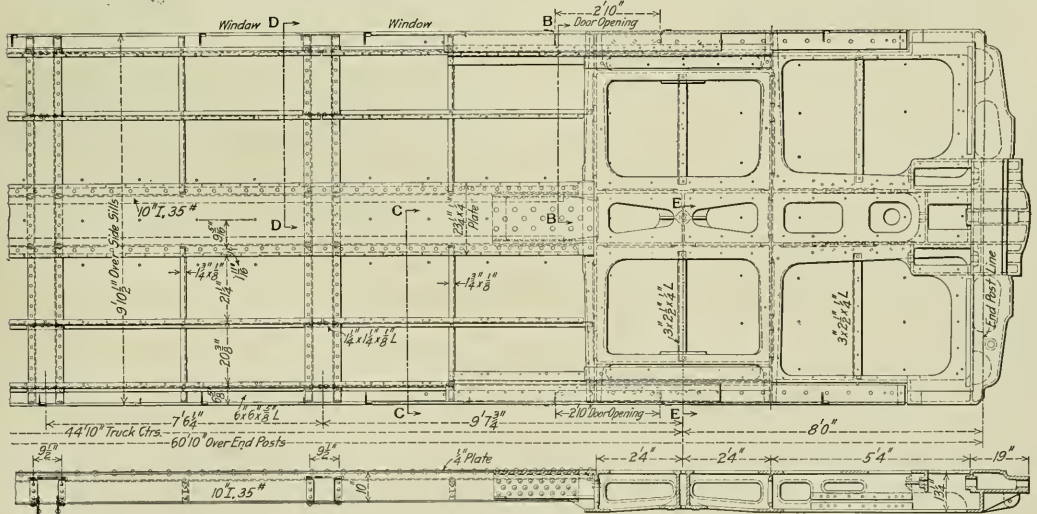

Underframe of Wabash Steel Postal Car.

between the upper and lower frames and are arranged as is shown in one of the illustrations. The side posts and diagonal braces are further stiffened and tied together by the 4 in. channel which acts as a belt rail. This member is not

Company includes the whole of the end framing. This has a broad bearing on the side and is machined and fitted to the combination underframe casting. It is arranged for great strength in a longitudinal direction and in addition to the

corner posts and the door posts has an intermediate vertical member on each side. All of these posts are designed in a general I-beam or channel section and give exceptional rigidity and strength. The sheathing of both the sides and the ends of the car is of 1/8 in. steel plate with butt joints, which are welded.

The roof is of the monitor type and is supported by 22 1 1/4 in. x 3/16 in. angle steel carlines running continuous between side plates to which they are connected with malleable iron knees. The upper deck roof sheets of No. 14 steel are riveted directly to the carlines and extend out over

paint. The sash and doors are of ash, having the standard hardware of the builders with the polished bronze finish.

Insulation in the sides, ends and roof of the car is furnished by 1/2 in. Salamander applied against the outside plates and held in place by wooden strips nailed to wooden furrings. In addition, the inside face of the shell of the car has a thick course of ground cork glued to its surface. The installation of the floors is 3/4 in. hair felt.

Positive ventilation is secured by eight Utility exhaust ventilators, four on each side, applied to the upper deck piers between the deck windows. These are provided with shutters so that the ventilators can be rendered inoperative at will. For the intake of fresh air, six swinging deck sash, three on each side, are provided. These deck sash openings are fitted with copper screens. The Safety Car Heating & Lighting Company's Thermo jet system of steam heat is applied and uses four lines of 2 in. pipe on each side of the car between the side doors. Beyond the side doors two lines

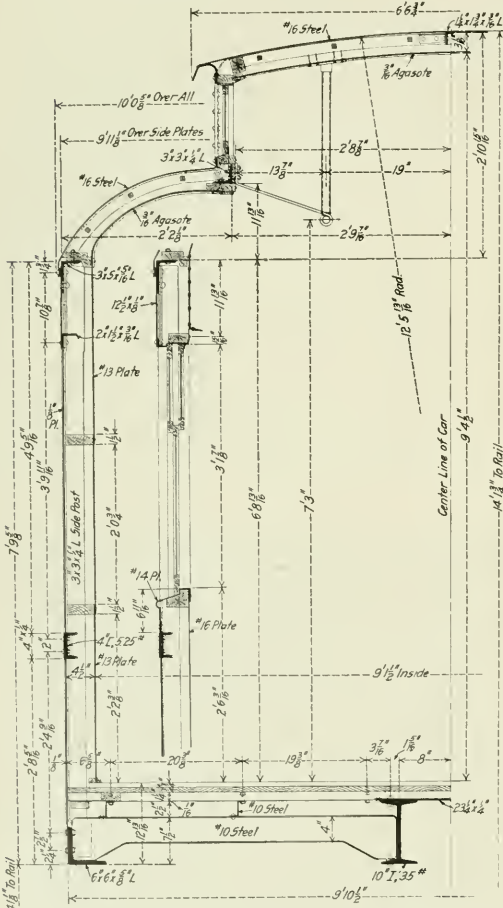

Section of Car Showing Arrangement of Longitudinal Members of the Framing.

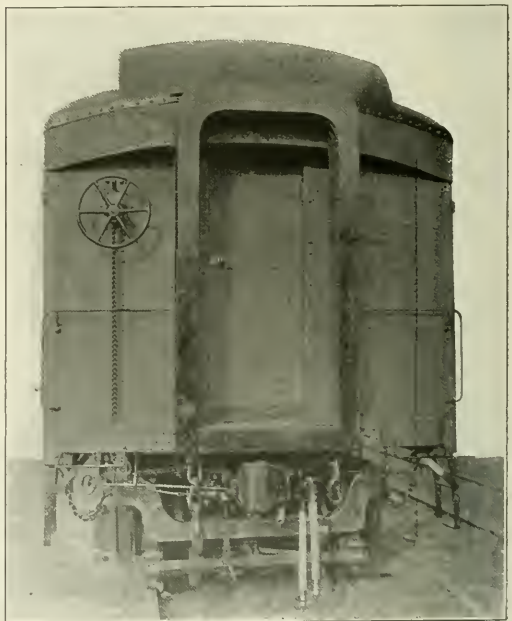

The End Frame of the Wabash Car Is Cast Steel.

of pipe extend halfway across the ends of the car; the pipes are protected by No. 16 perforated steel shields.

For lighting purposes the cars have been fitted with the Gould axle light equipment, using a 30 volt circuit and Gould storage batteries of 16 cells. The system of lighting is of the conduit type, having exposed conduits extending through the center of the car with conduit fixtures for 15 center lights, eight bracket lamps at the letter cases and one bracket lamp at the lavatory. Fifteen watt Tungsten bulbs are used. As auxiliary lighting there are 24 candles provided. The skylight in the center of the car in the upper deck provides 5 sq. ft. of lighting space. Galvanized iron letter cases and paper boxes are installed in accordance with the department specifications.

The trucks are of the railroad company's standard six-wheel type having 5 in. x 9 in. journals and Commonwealth cast steel frames.

Some of the specialties used are as follows: American Car

a deck moulding of 3/16 in. pressed steel in an inverted U-shape. The lower deck roof sheets are No. 16 steel, riveted directly to the carlines, and extend over the sheathing at the side plate angle.

The inside finish is of flat steel plates, No. 16 gage for the sides and ends except at the storage part of the car where No. 13 gage steel is used. The upper and lower decks have a headinging of 3/16 in. agasote, screwed to wood furrings on the carlines; the joints are covered with flat wooden bands. The inside of the car is painted with a light enamel

& Foundry Company's twin spring draft gear; Chaffee centering device; National couplers; Curtain Supply Company's 6 fold diaphragm; Standard Steel 37 in. rolled steel wheels; Hewitt Manufacturing Company's journal bearings; Waycott brake beams; Streeter steel back brake shoes. The cars have a total weight of 124,300 lbs., of which the trucks give 42,000 lbs.

PROPORTIONS AND INSULATION OF REFRIGERATOR CARS*

BY M. R. PARKS,
East Rochester, N. Y.

There are various kinds of refrigerator cars used for the transportation of perishable products and the necessity for increased efficiency has been felt by the railroad companies handling this equipment. Many shippers have claimed that due advance has not been made in the construction of refrigerator cars to keep pace with the general refrigerating cold storage plants and refrigerating engineering of the day. Many of the older cars were lacking in insulation, which is the main feature, and have also lacked in ice capacity. However, the service demands for refrigerator cars have increased so rapidly that it has been impossible to do much more than give the added equipment necessary attention rather than to attempt to rebuild the older. The refrigerator cars used by the various railroads differ considerably in construction and in a greater degree as to the insulation. The cars vary in efficiency because of the light construction and insulation, or because of a variation in the insulating material itself. Knowing the faults of the older refrigerator car has stimulated thorough and thoughtful consideration and study along the lines of increased efficiency.

DIMENSIONS AND PROPORTIONS.

It is only within the past few years that substantial accord has been reached in the principles underlying the best practice in the development of the refrigerator car. It must not be supposed that there is entire unity of opinion existing among the engineers and manufacturers in connection with this particular class of car construction and it can be plainly stated that the opinions held and the individuals holding them may be broadly divided.

The history and development of the refrigerator car is an excellent guide to the manufacturers and operators in adopting a car with standard dimensions. It can be universally stated that the disadvantages resulting from the existence of numerous types and sizes of cars, place the shipper at an inconvenience. As some of the cars may be lighter or heavier than others, it is naturally a question as to which standard is right.

The most modern refrigerator cars in service, and in fact, nearly all which are being built at the present time that are used in the dairy business, are governed almost entirely by the size of the egg cases, this being the only uniform commodity used in carload lots which practically affects the dimensions of the car. The cases being 12 in. square and 26 in. long, the refrigerator car has developed to a point where for a carload lot, about 800 cases of eggs can be loaded. The railroad systems, without any concerted action, have arrived at a car which has inside dimensions of about 8 ft. 2 in. to 8 ft. 4 in. in width, and about 7 ft. 6 in. in height, and practically 33 ft. 0 in. between ice tank bulkheads. The car with these dimensions will take fifteen egg cases in length and will allow for seven tiers to be loaded in height, allowing for sufficient space for the circulation of air over the top tier. With a car of the inside dimensions noted, the length over the end sills would be 41 ft. 4 in. to 41 ft. 5 in. Inasmuch as these dimensions have been arrived at by each road, independent of the other roads, it would appear that

*Paper presented at the Third International Congress of Refrigeration, Chicago, September 15 to 24.

they more nearly meet the general traffic conditions today than any other dimensions.

It is evident that the adopting of a uniform standard for refrigerator car conditions by the railroad systems will be a great benefit to both the shipper and manufacturer. This standard should be based upon experience, not only by the shipper, but by the railroad system supplying this particular class of cars. A purely theoretical standard which does not take into consideration all the conditions necessary to meet the requirements of the shipper would obviously be of little value. It is well known that one of the main essentials in the construction of a car of this type is the capacity of the ice tanks. The modern car has ice tank capacity ranging from 10,000 to 12,000 lbs. of lump ice. This capacity seems to meet the traffic requirements and the theoretical refrigeration required for a car of the dimensions described herein. In the construction and capacity of the tanks, the amount of refrigeration required depends upon a two-fold basis: first, refrigeration required to replace the loss through transmission of heat from the exterior; second, the amount of refrigeration required to quickly cool the contents of the car and to maintain as uniform a temperature as best adapted for the various kinds of produce handled. In the first case, the loss through transmission can only be governed by the thickness of the walls and the insulation so that the heat leakage will not exceed 2 B. t. u. per hour per square foot of surface for 1 deg. difference in temperature Fahrenheit, and the refrigeration for the produce based upon the specific heat at .8 units. These points are very important in the development of the ice tank and are taken into consideration in detail under the subject of insulation. There are no features in connection with these dimensions which do not meet the traffic requirements of all other loading. I think, therefore, that they may be considered as practically standard dimensions for modern refrigerator car equipment.

CAPACITY.

While many of the large railroad systems are continuing the practice of building refrigerator car equipment of the above dimensions with the standard M. C. B. 30 ton capacity trucks, the more generally accepted practice has been to increase the capacity of cars to 40 tons. In a number of instances, cars have been built with capacities ranging from 45 to 50 tons. The average refrigerator load, however, is so much below these capacities that it does not seem advisable to build a car with such large capacity with increased weight for the transportation of light dairy loads. The average dairy load is considerably under 30,000 lbs., and the capacity of the car, therefore, at 30 tons, is well within its limit. However, the general railroad equipment of the country has increased so in size and weight and the handling of the equipment has become so rough that it is almost necessary to build a car of larger capacity to stand the general service conditions now in vogue on most of the roads.

In a car built on 40 ton trucks, the weight of the body is so much heavier than the average freight car body that the usual 10 per cent. overload cannot be permitted; and, in the case of a 30 ton refrigerator car with a body of the above dimensions, the loading allowed would be limited to less than 60,000 lbs.; in both cases it is necessary to consider the ice in the capacity of the load. These limits are reached in the various capacity trucks by the M. C. B. rating for the carrying capacity on the axle. It can be readily seen that if the weight of the body increases, the load must in consequence be decreased.

INSULATION.

The efficiency of a refrigerator car, or its preservative features, depends chiefly upon the number of layers of insulation, its quality and thickness, the character of the workmanship in the construction of the car, the sealing of all parts, such as side doors, ice plugs and water traps so as to keep the interior temperature even without fluctuation. This efficiency, however, is

affected by the ability of the car to withstand the usual wear and tear while in service.

The insulation and ice tank work in connection with a refrigerator car makes it one of the most expensive of the common freight cars which the railroads operate. It costs more to build and more to maintain. In the building of new cars there is a decided tendency towards increased insulation. Cars are being built much heavier and much greater care is given to the selection and amount of insulation used in the construction. It was formerly considered good practice to use two courses of insulation with four courses of paper, but the design and construction of the later standard refrigerator cars has reached a point where four courses of insulation $\frac{1}{2}$ in. thick are being used with eight and ten courses of high grade waterproof paper in addition. A decided departure from previous practice has been made with particular reference to the manner of application and increased thickness of the insulated walls together with the all important requirement of keeping the insulation dry. The importance of good insulation is well understood; perfect insulation is practically an impossibility. Generally speaking, the success and value of a refrigerator car rest primarily on a two-fold basis:

First, proper insulation to resist the exterior heat in summer, and to retain the heat and resist the cold at a low degree of temperature in the winter.

Second, ice tank capacity sufficient to provide adequate circulation of the cold air necessary for quickly cooling the contents of the car.

The more important of these principles of refrigeration is the insulation. The selection of insulating materials and the method of their application depend chiefly upon their insulating power. The insulating power of any material is its capacity to resist heat: or, in other words, the heat conducting or transmitting power, and this is a quantity of heat expressed by the number of British thermal heat units which will pass through a square foot of insulating material of a given thickness in one hour, or for 24 hours for a difference in temperature of 1 deg. Fahrenheit; or for a certain difference in temperature on each side of the insulating material. In addition to the non-conducting qualities, a good insulation must be clean, non-odorous, and non-decayable; it must resist every kind of decomposition, and have the greatest possible strength and durability together with properties making it easy to apply. Besides heat, water and moisture are two elements that enter into the selection of insulation. It is well known that one of the main essentials of economical insulation is dryness. Water is a good conductor of heat, and it is absolutely essential that the insulation be entirely and permanently waterproof. Waterproof does not mean merely resisting the entrance of water, but preventing its entrance. These points referring to the physical laws governing the transmission of heat must be given the fullest consideration in the selection of the insulating materials to be used. A refrigerator car being a movable object, it must resist all the rapid changes in weather and climate, and variations in temperature ranging from 40 deg. below zero to 120 deg. in the shade.

What constitutes adequate insulation is a question upon which a wide diversity of opinion exists among many refrigerator engineers. It is assumed to be the accepted practice in cold storage construction that the walls of the building be so heat proof as to keep from the interior all heat in excess of 2 B. t. u. per 24 hours per degree of difference between the outside and inside temperature. Assuming that the heat leakage in the modern cold storage plant averages 2 B. t. u., then the type of wall with material and character of insulation as applied to new and improved refrigerator cars as herein described, meets the necessary conditions surrounding that of a cold storage plant.

In determining the number of heat units of transmission through the wall consisting of a number of layers of insulation, the insulating power, or heat leakage, etc., can be readily calcu-

lated if the heat leakage, or conducting power and thickness of each of the individual constituents of such insulators are known. The heat leakage of the wall of a car insulated with four courses of $\frac{1}{2}$ in. hair felt with the necessary waterproof paper and linings, theoretically averages about 4.35 B. t. u. per hour per square foot of surface for a difference in temperature of 52 deg. This difference in temperature has been based upon the exterior temperature of 90 deg. and the interior temperature of the car at 38 deg. Reducing the heat leakage to a 1 deg. difference in temperature between the inside and the outside would get approximately 2 B. t. u. for 24 hours per square foot of surface. The loss, however, due to the faulty construction and leakage through openings is not taken into account. These openings of necessity would materially increase the transmission of heat, but inasmuch as very little data is obtainable whereby this quantity could be determined, for all practical purposes when the heat leakage through the walls has been reduced to the basis of comparison with the walls of a cold storage building, it would seem to be satisfactory. The loss through the openings, such as side doors and ice covers can be greatly reduced by care in the construction of these parts and by the proper handling of them in service. This description of refrigerator car conditions is purposely brought out in order to make known the comparison between cold storage buildings and the modern refrigerator car; and that the refrigerator car herein described does meet, practically, the conditions required. This does not, however, apply to the various refrigerator cars in use today of the older type, as it is quite evident that many of them do not meet this standard of insulation, and it would be impractical to reconstruct them.

The first practical consideration being given to the thermal conductivity of the walls, the second most essential point is that the refrigerating capacity of the car must be great enough to replace the cold lost by transmission in the walls, ceiling, and floor, also the amount of refrigeration required to keep the contents of the car cold and at a temperature best adapted to the various kinds of fruit, produce, etc. The amount of refrigeration depends upon a number of circumstances: the size and construction of the storage, the amount and frequency of the products, their specific heat, and the mean external temperature, as well as the perfection of the insulation, and various other conditions. Assuming that the maximum temperature of the outside averages 90 deg. and the inside temperature of the car desired averages 38 deg., the range of temperature would be 52 deg.; the exposed surface of the car being 1,600 sq. ft., the heat leakage at 4.35 B. t. u. per hour per square foot for a difference of 52 deg. then the amount of refrigeration required to replace the cold lost by transmission through the walls would be approximately 1,100 lbs. The amount of refrigeration required to replace the cold lost by transmission through the ceiling and walls being determined, it is necessary to calculate the amount required to cool the products in the car. Assuming that the specific heat of the different kinds of products is about .8 units, then the amount of additional refrigeration required to reduce the temperature of the products to that of the temperature of the car is equivalent to 4.39 tons (or 8,780 lbs.), based upon a load of 30,000 lbs. In the refrigerator cars now in service there are many ice tanks, patented and otherwise, aiming to assist the circulation of the air in contact with the ice. The amount of refrigeration required for the total number of cubic feet of storage is a point that has never been given the consideration that is absolutely essential for the proper cooling of the car and its contents. In many instances, refrigerator cars have ice tank capacity of only 5,000 lbs., quite a number of 10,000 lbs., and very few have been built with a capacity running as high as 12,000 lbs. Some refrigerator cars have been built with an air space entirely around the ice body which largely increases the radiation, and therefore the circulation.

In arriving at the quantity of ice necessary to transport most of the perishable products, the question of salting was not taken

into consideration. It is well known that with the use of from 5 to 20 per cent. of salt, a much lower temperature can be produced than the ice alone will give; and in the transportation of dressed poultry and fish, it is almost necessary to use a percentage of salt to secure a sufficiently low temperature to insure safe transportation.

RESULT OF M. C. B. LETTER BALLOT

Voting by the members of the Master Car Builders' Association on proposed changes in the standards and recommended practice closed on September 14. There were 54 separate changes submitted for decision, of which 7 were changes in standards and 47 were changes in recommended practice. All of the proposed changes in standards were adopted and 35 of the 47 proposed changes in recommended practice were adopted, 12 being rejected.

The changes in standards are as follows: A change in the dimension of the hole in the lid for 80,000 lbs. and 100,000 lbs. capacity journal box; the advancing of the axle E with 6 in. x 11 in. journal from recommended practice to a standard; the spacing of brake beam heads as recommended by the committee (this makes the new average distance between the centers 60 in. with an allowable variation of 1/8 in. either way from this dimension). The details of brake beam gages as recommended by the committee have been adopted as standard and the coupler guard-arm test has also been restored. The wheel circumference measure for cast iron wheels as shown in Fig. 4 on page 1448 of the *Daily Railway Age Gazette* was adopted and the changes suggested in the report of the committee on loading materials, which is given on page 1475, were accepted.

All of the subjects recommended by the committee on revision of standards for recommended practice with one exception were adopted. These are given on pages 1433 and 1434 of the *Daily Railway Age Gazette*, the exception was the maximum side bearing spacing which the committee recommended should not exceed the rail gage with a minimum of 44 in. centers and a minimum clearance of 3/16 in. This was defeated. The committee on train brake and signal equipment recommended that all freight cars weighing between 37,000 lbs. and 58,000 lbs. be equipped with 10 in. brake cylinders, also that the braking ratio for freight equipment should be made 60 per cent. of the light weight of the car, based on 50 lbs. per sq. in. cylinder pressure. It was also recommended that the K-1 triple valve for 8 in. equipment and the K-2 for 10 in. equipment be adopted as standard. Further that no pipe having an internal diameter less than one inch and of standard weight should be used on passenger cars for brake pipe and that all new equipment should be provided with 1 1/2 in. extra heavy pipe. All of these, as well as the recommendation in connection with the position of bolting lugs of hose clamps were adopted. The committee's recommendation in regard to the use of galvanized brake pipe and fittings for refrigerator and coal cars was rejected. The recommendation of the committee on brake shoe and brake equipment in regard to brake beam No. 2 was rejected by a decisive vote. The three recommendations of the committee on car wheels referring to the specifications for solid wrought steel wheels, changes in illustrations of steel wheels and circumference measure for steel wheels were all adopted as were also the journal box, journal bearing, journal wedge, journal-box lid and other parts including the gages for the 6 in. x 11 in. box. Of the recommendations of the committee on train lighting which are given on page 1483 of the *Daily Railway Age Gazette*, the proposed axle for dynamos, recommended dimensions for battery box and a hanging recommended for the battery box were rejected. The other recommendations of this committee were adopted. The specifications for steam heat hose which were given on page 1484 were adopted, as were also the

steam hose couplings. The recommendations of the committee on unloading machines were approved with very little opposition. The recommendations of the committee on car construction with a single exception were all rejected; the one adopted refers to the arrangement and use of end doors. The report of this committee will be found on page 1512 of the *Daily Railway Age Gazette*.

SPECIAL BAGGAGE CAR FOR SCENERY

A recent order of five baggage cars built at the Elizabethport shops of the Central Railroad of New Jersey included two special cars arranged for carrying scenery. The three ordinary baggage cars are 60 ft. in length and are mounted on four-wheel trucks. The scenery cars are 72 ft. long and are carried on six-wheel trucks. In both cases the cars are of composite design, with a very substantial steel underframe and a wooden superstructure with the exception of the ends. In the case of the 60-ft. baggage car, the end framing is all one large steel casting, with a door opening in the center and ribs arranged as shown in the illustration. This is sheathed with steel on the outside. This casting has a broad base at its connection to the side sills which is seated in a machined recess in the combination underframe casting, and makes a most substantial structure at this point. In the scenery car the same general scheme is carried out



Cast Steel End Frame of Baggage Car.

but, owing to the fact that it is necessary to have an opening for the full width at the end of the car in order to introduce the lading, the casting in this case takes the form of a large frame, the details of which are shown in one of the illustrations. Inside of this frame are a pair of doors formed of 3/8-in. steel plate, most securely braced and stiffened by steel angles and backed with wood lining. These large, double doors are so designed as to leave the single center door opening in the ends of the car and are provided with suitable locks at the top and bottom which, combined with the three heavy cast steel hinges on either side, form a most solid and satisfactory end for the car. A detail of this door is also illustrated herewith.

There is comparatively little difference in the design of the underframe of the two types of cars with the exception of the center sills which are somewhat larger in the case of the 72-ft.

car than in the shorter design. The underframe of the former consists of Commonwealth combination double bolster and end sill castings of special design, which are connected by two 12-in.

flanges of the sills on both sides. There are four 1 3/4-in. truss rods pinned in seats in the casting at either end, being spaced and arranged as is shown in the section of the car. The side

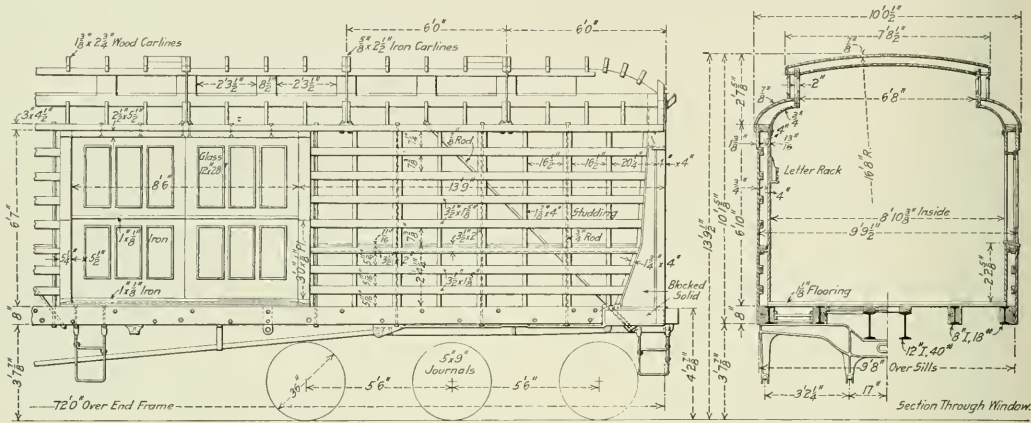

Partial Side Elevation and Sections of Scenery Car; Central Railroad of New Jersey.

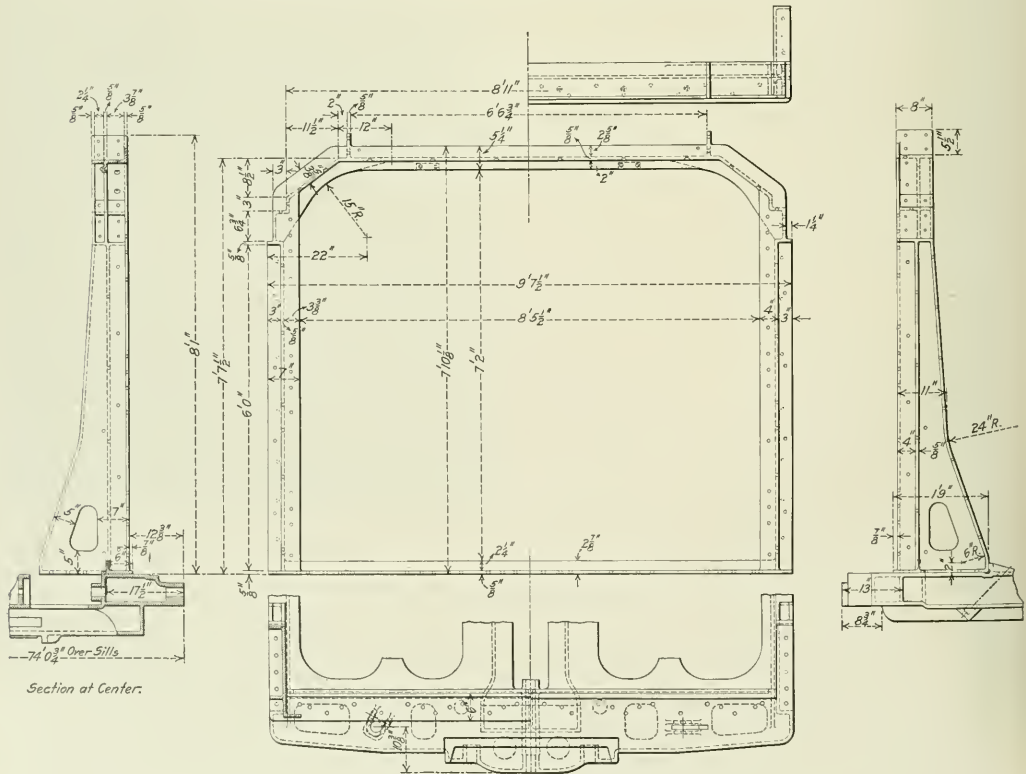

Details of Cast Steel End Frame; Central Railroad of New Jersey Scenery Car.

40-lb. I beams as center sills. There is a 5/16-in. cover plate running the full length of the I beams and lapping over the joints of the end castings. This plate is double riveted to the

and intermediate sills are 8-in., 18-lb. I beams, which pass over the top of the end casting and are continuous between end sills. The arrangement and form of the cast steel cross bearers is also

located under the end sill and operated by a direct pull on either side. The rod on the opposite side of the coupler from the unlocking lever passes over the coupler shank and continues by means of a chain around a shive and connects to the rod on the other side, which is fastened directly to the coupler lock.

The six-wheel trucks have a cast steel frame. They are provided with clasp brakes designed and manufactured by the American Brake Company.

These cars have a capacity of 60,000 lbs., and will be used for shipping automobiles and for baggage when not employed for their special purpose of carrying scenery. They have a light weight of 117,200 lbs., an inside length of 71 ft. 4 in., and an inside width of 8 ft. 11 in. The height on the inside of the car is 7 ft. 3 in.

Among the specialties are Minor Tandem Spring Draw Gear, Gould couplers, Ward steam heat, Pintsch gas lighting and Commonwealth steel bolsters. They were designed in the mechanical engineer's office of the Central Railroad of New Jersey.

AIR BRAKE HOSE LABEL

BY J. S. SHEAFE,

Engineer of Tests, Illinois Central, Chicago, Ill.

If a certain brand of air hose is known to give so many months' service, it should be removed at the end of that time. The impracticability of car inspectors continually examining hose labels is at once evident. One of the illustrations shows the dangerous position necessarily assumed by a man in order that he may read the present label showing the date of manu-



In Reading the Present Hose Label a Man Occupies a Dangerous Position.

facture, and after he has read it he must calculate mentally whether or not the hose has reached the removal age.

One way to insure a hose being removed after a given time is to have figures vulcanized on the outside, and near the coupling end, to show the month and year in which a hose will have reached its allowable maximum age. The hose shown in the other illustration was made in August, 1913, and should not remain in service after February, 1916, as shown by figures legible

from outside the rails. A car inspector would remove this hose from service when the time had expired, and as he could easily tell this without any effort on his part, there would be no opportunity for the hose to remain on a car until so deteriorated that bursting under train line pressure would be inevitable.

Failure from mechanical injury may cut short the life before the hose has deteriorated to a sufficient extent to become dan-

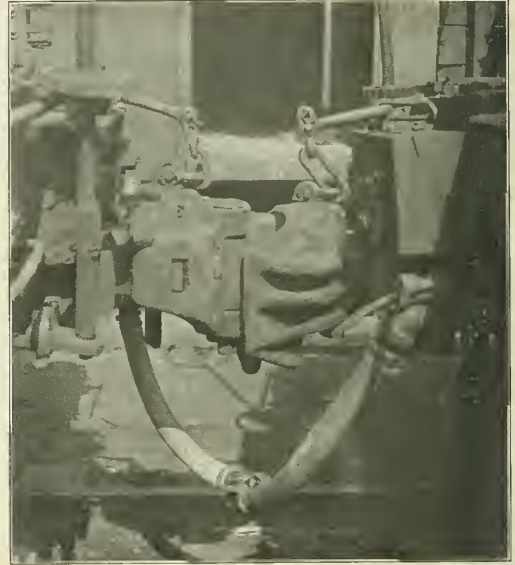

Hose So Labeled That the Removal Date May Be Read from Outside the Rails.

gerous. Only two things will minimize liability to accident with the better quality of hose: (1) Prevent failure from mechanical injury as much as possible; (2) Show legibly on the hose the date when it should be removed on account of age.

PROPOSED NEW SUBWAY CAR

A wooden full-sized model has recently been completed of a proposed subway car for the New York Municipal Railway which is to operate part of the subways now under construction in New York City. This car has been designed with the idea of facilitating the handling of large crowds, of increasing the proportion of seated passengers during the congested periods and to increase the capacity of each train.

The new cars are 67 ft. in length and have maximum width of nearly 10 ft. as compared with 51 ft. 5 in. length and 8 ft. 8 $\frac{1}{4}$ in. maximum width of the present Interborough subway car. They have six door openings in each side, each being 2 ft. 8 in. in width. These are arranged in pairs, one pair being at the center of the car and another at approximately one-quarter of the length of the car from either end. There are no side doors at the extreme ends of the car. The car is arranged to give a seating capacity for 78 passengers when all twelve doors are in operation, and will seat 90 passengers when but one door in each pair is in operation, and 98 passengers when but one door on each side is in operation. Of the 78 passengers seated during rush hours, 44 are provided with cross seats. The seats are arranged to allow ample open space around each door.

The cars will be of all-steel construction and will all have motor trucks. The estimated total weight of each car is slightly less than 122,000 lbs.

NEW DEVICES

MUD RING AND FLUE SHEET DRILL

The four-spindle drill illustrated herewith, has been designed by The Foote-Burt Company, Cleveland, Ohio, for use in boiler shops for drilling the rivet holes around a mudring and for cutting out the flue holes in a flue sheet.

The spindles are the independent feed type, each one being arranged with automatic knockoff to the power feed. The quick return is made by a hand wheel on the front of the head. Each spindle is arranged with clutch for stopping and starting and has an interlocking mechanism so that the feed cannot be thrown in while the spindle is stopped or vice versa. With this independent feed feature some of the spindles are always drilling while the operator is setting the other spindles, so that the full efficiency of both the machine and the operator is obtained.

The spindles are arranged in pairs mounted on auxiliary cross-

machine. Six changes of speed are provided by a three-step cone and throwout back gears. The machine weighs approximately 21,000 lbs.

RADIAL DRILL OF HIGH CAPACITY

The 3 ft. radial drill shown in the illustration was designed for simplicity, accuracy and durability, and has ample power for the efficient use of high speed drills. It is self-contained, requiring no special foundation, and as no countershaft is required may be placed directly under the line shaft.

The base is very deep, of triple I-beam section to insure the greatest rigidity, and is well provided with extra large T slots. An oil channel is cast around the base draining into a large reservoir under the column, which is of the double tubular type.

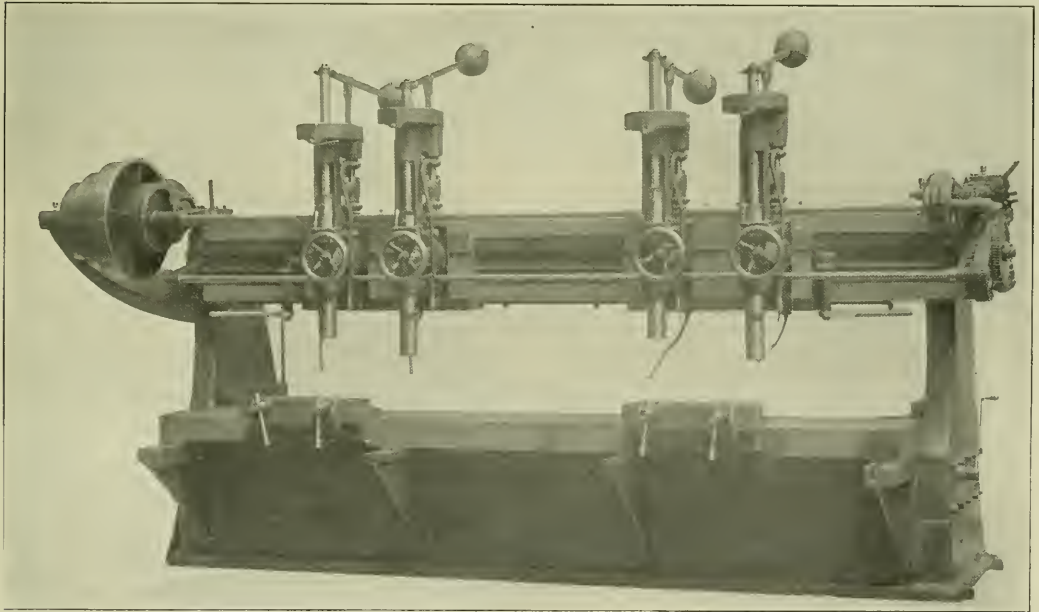

Four Spindle Drill for Boiler Shop Work.

rails and are adjustable on these crossrails to a minimum center distance of eight inches. The advantage of this feature is that it is possible to set the spindles to the proper spacing of the rivet or flue holes and then adjust two spindles along the main rail of the machine, maintaining the proper spacing and eliminating the necessity of spacing each one.

The spindles overhang the front edge of the base by eight inches to take care of the mudring work and the table is provided with chucks for holding the mudrings. The table has an in and out motion of 36 in. and is supported under the spindles by the bracket slides on the front of the base.

Three changes of power feed are provided, any one of which is available by shifting a lever at the right-hand end of the

The fixed inner column is heavily ribbed and extends to the top, where a large ball thrust bearing insures easy swinging of the arm. The column is rigidly clamped by a convenient malleable iron lever which travels with it and is adjustable. The clamping surface of the column is large and is provided with means for taking up the wear.

The arm is of pipe section, well ribbed to give the greatest possible resistance to torsional as well as bending strain. The tighteners are equipped with adjustable screws to prevent sagging and provide means for taking up the wear. The elevating screw is suspended by a ball thrust bearing and the arm lowers at twice the elevating speed by a handle placed below for the convenience of the operator. Safety trips are provided for both

extremes. The head is easily moved along the arm by a rack and spiral pinion with the thrust taken up by a ball bearing in either direction. The back gears on the head give through hardened steel gears and clutches, three changes of speed, all made while running, by a single lever in front of the head. All gears are thoroughly encased and are placed between the spindle and the friction, giving the friction the benefit of the back gear ratio for the heaviest kind of work.

The tapping reverse frictions are simple and powerful. They are mounted on a sleeve which slides on the arm shaft allowing no grit to be drawn into the mechanism, which is enclosed and runs in oil. The adjustment for wear is made from the outside by a common screw driver. The spindle is of crucible steel and takes the thrust on a special ball bearing. The sleeve has a

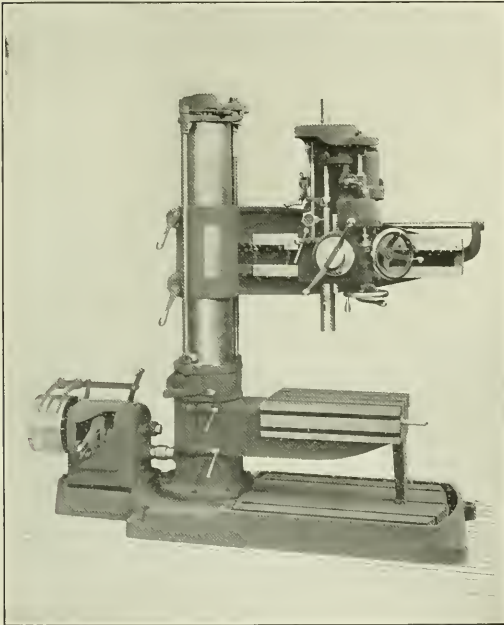

Heavy Duty Radial Drill.

direct reading depth gage and the adjustable automatic trip may be set to the exact depth of the hole in any position. The safety trip is always positive at the extreme of the traverse. The quick return friction is large, may be instantly adjusted and is operated by a double lever. The pinion is hardened.

The feed changes are made while running, with but one handle, which has a direct reading index. The feed box is placed low on the head so as to give support to both sides of the worm. The worm wheel is enclosed and runs in an oil bath, and an overtake clutch permits the hand feed to be fed ahead of the power feed without disengaging the latter.

The speed box is simple and positive throughout and has a direct reading index plate for the positions of the lever. All the changes are made easily and noiselessly by a single lever and shock is avoided by an overtake arrangement which keeps the machine running at a reduced speed when the tumbler is out. A latch pin secures the tumbler and prevents chattering on heavy work. The lubrication system is very complete, oil chambers, felt wipers or pipes, as the location requires, being provided, and the bearings are of special phosphor bronze. Motor drive may be added to the machine at any time without special base or

speed box, or it may be removed and belt drive substituted. Constant speed or 3 to 1 variable speed motors of any speed may be used and connected by rawhide gearing or silent chain.

The machine is manufactured by the Fosdick Machine Tool Company, Cincinnati, Ohio. The following are the principal dimensions:

Drills to center at base.....	72½ in.
Base to spindle, maximum.....	76½ in.
Base to spindle, minimum.....	52½ in.
Base height.....	13 in.
Base working surface.....	16 in.
Spindle to column, maximum.....	41½ in. x 30 in.
Spindle to column, minimum.....	38½ in.
Spindle traverse.....	9½ in.
Spindle diameter at point of drive.....	1 11/16 in.
Feeds (.007 to .031).....	5
Speeds (25 to 400 r. p. m.).....	18
Traverse of head on arm.....	28½ in.
Traverse of arm on column.....	27½ in.
Column diameter.....	10 in.
Face of arm.....	8½ in.
Table working surface.....	16 in. x 26 in.
Table height.....	18 in.
R. P. M., pulleys.....	360
Motor horsepower.....	3 to 5
Floor space.....	9 ft. x 7 ft. 6 in.
Floor to top of column.....	6 ft. 11 in.
Floor to top of spindle.....	8 ft. 7 in.
Weight, net.....	4,200 lbs.

PRE-COOLING REFRIGERATOR FRUIT CARS

One of two sets of two 7 ft. Sirocco blowers driven by 75 h. p. Westinghouse motors, which are used by the Pacific Fruit Express Company, at Roseville, Cal., for cooling fruit cars previous to filling their tanks with ice, is shown in the illustration. Air is drawn from cooling rooms in which the temperature is kept at about 18 deg. F. by direct expansion ammonia coils, and is forced into the cars, reducing their temperature and effecting a considerable saving in ice during transportation. By means of specially designed valves, also driven by Westinghouse motors, the air current can be reversed so that the fans can exhaust foul air from the cars previous to the cooling

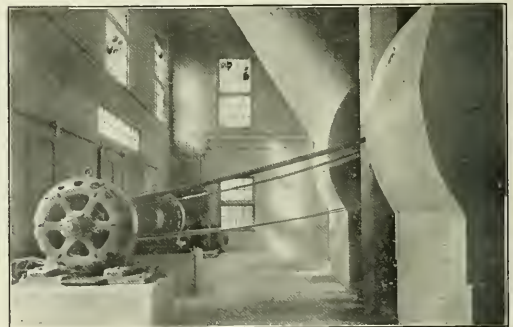

Motor-Driven Blower for Pre-Cooling Refrigerator Cars.

process. The electric motor drive is used extensively in this plant, being employed for the brine tank agitators, ice elevators, chain conveyors for loading and unloading, pumps and miscellaneous machines in the repair shop.

REFRIGERATOR CARS.—According to a German paper devoted to the cold storage business there are in North America 100,000 refrigerator cars in service, besides 50,000 insulated and provided with special ventilating equipment. In the whole of Europe there are only 50,000 refrigerator cars of which 3,000 are on the Russian railways.

THE STANDARD LOCOMOTIVE STOKER

Scatter Type Using Horizontal and Vertical Screw Conveyor; Simplicity Prominent Characteristic.

In the Standard locomotive stoker a horizontal screw conveyor takes the coal from the tender and delivers it to a point under the center of the back mud ring of the firebox. Here it passes through a vertical screw conveyor which carries it upward and delivers it at a point about 12 in. above the grate level inside the firebox close to the back head. Steam jets on the ends of four pipes projecting through the back water leg at this point and having an intermittent action, distribute it

valve located in the steam supply line at a point convenient for operation from the fireman's seat. Each of the four small pipes leading from the control valve to the steam jet is provided with a small globe valve by which the intensity of each jet can be independently controlled. These pipes are also capable of being turned from the outside so as to alter, to some degree, the direction of the blast. In a general way this covers the essential features of this new type of stoker which

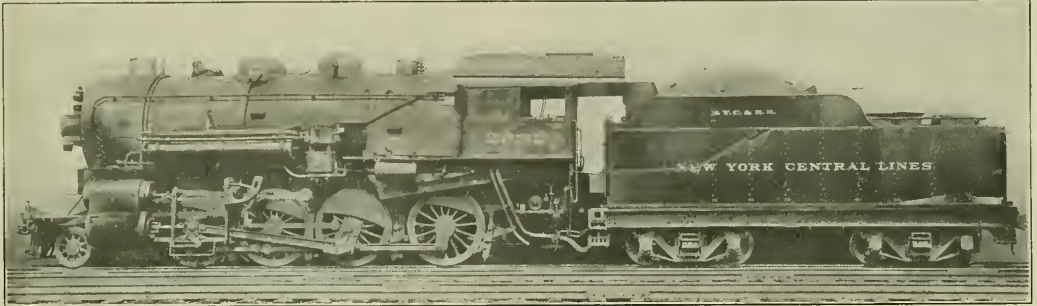

Consolidation Type Locomotive Fitted with a Standard Locomotive Stoker.

from the top of the vertical conveyor to the various parts in the grate. The two screw conveyors and the valve controlling the duration of the steam blast in the jets, are operated through a simple gearing and an eccentric from a horizontal shaft extending across underneath the cab deck which, in turn, is driven through a worm and gear by a small engine secured to the outside of the frame under the cab on the left side. This engine is driven by steam and its speed is controlled by a

it will be seen is very simple in its arrangement, direct in its action, flexible of control, does not occupy any appreciable space in the cab and is still easily reached for inspection or repairs.

This stoker has been in use on a large consolidation type locomotive on the New York Central lines at Buffalo for over three months, and during this time has given 100 per cent. service continuously, although the locomotive has been in heavy

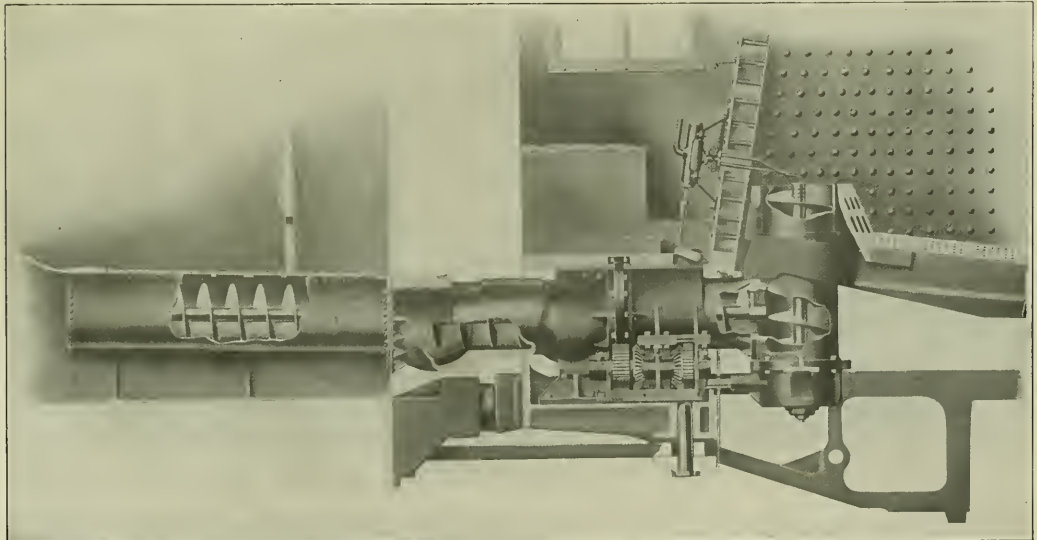

General Arrangement of the Standard Locomotive Stoker, Showing All Parts Except the Engine for Operating the Conveyors.

pushing and road service. Preparations are now under way for a very thorough and complete test of all features of the stoker. Observation indicates that, at the present time, the stoker uses somewhat less coal than is required on the same

ings about 6 in. square for the admission of the coal. Above this grating are sliding steel plates in short sections which can be moved to permit the admission of coal at any desired point. The sides of the coal space are sloped inward to make the

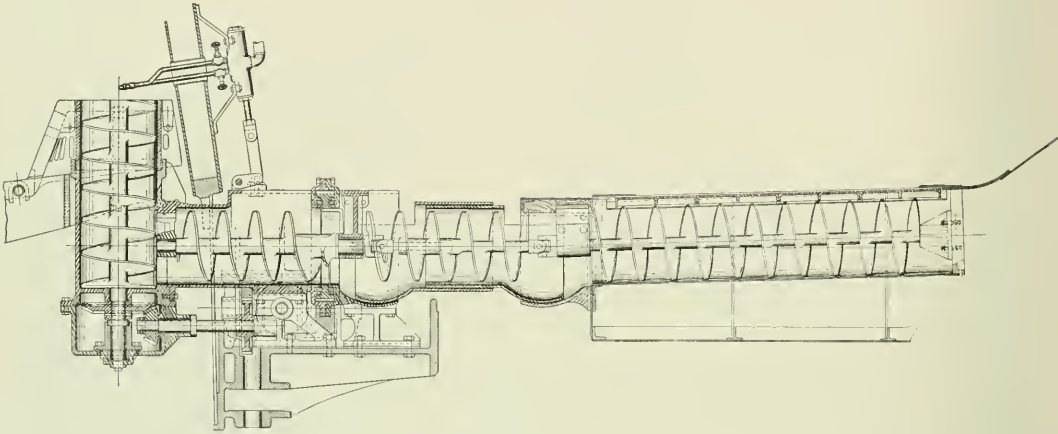

Sectional View of the Standard Locomotive Stoker.

class of engine by hand firing, it makes decidedly less smoke than the hand fired engine and is fully capable of maintaining full steam pressure under severe conditions of operation.

The section of the conveyor in the tender extends from the

tender entirely self-feeding so that, except for pieces of coal which are larger than will pass through a 6 in. square opening, but little attention needs be given the feeding of the coal in the tender. This section of the conveyor is carried by bearings

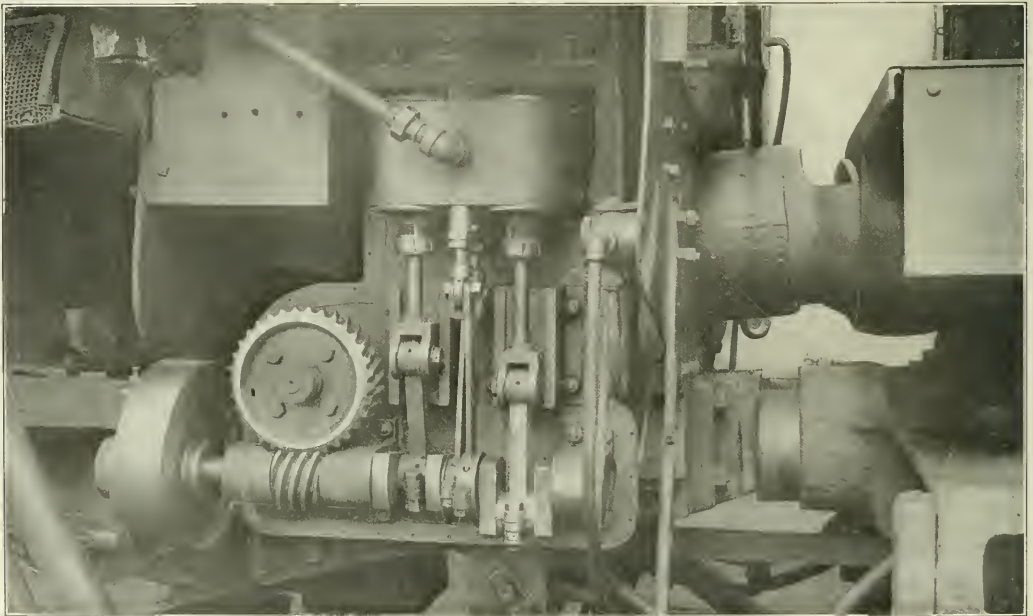

View Showing the Engine and Worm Gearing and the Flexible Connection in the Conveyor.

back slope sheet of the coal space to the front end of the tank. It is enclosed in a trough under the floor and is open at the top with the exception of a wrought iron grating with open-

ings at the ends. It is made with a large steel shaft and separately cast steel spirals which are keyed to the shaft. The bearings at either end are lubricated with grease and, on account of the

low speed will require the minimum of attention. Various diameters of conveyors are being experimented with at this time and the indications are that a 9 in. diameter will prove amply sufficient for handling up to 6,000 lbs. of coal an hour.

Freedom of movement between the engine and tender requires the use of a flexible conveyor section and this has taken the form of a double ball jointed section of the trough which also has a slip joint. A short section of the spiral is contained in this and is connected to the section on the tender by a universal joint and to the section under the locomotive deck by a universal as well as a square slip joint in the shaft. One of the illustrations clearly shows the appearance of this flexible section. In operation it is found that there is no trouble in passing the coal from one section of the spiral to another through the ball joints, nor has any trouble been found with the freedom of movement between these parts. The fine coal and dust which finds its way in between the moving surfaces form an excellent lubricant and these parts have a complete freedom of movement without oil lubrication. The universal joints in the shaft of the conveyor are made of forgings in the simplest form, are screwed directly on the end of the shafts.

The short section of the conveyor under the locomotive cab

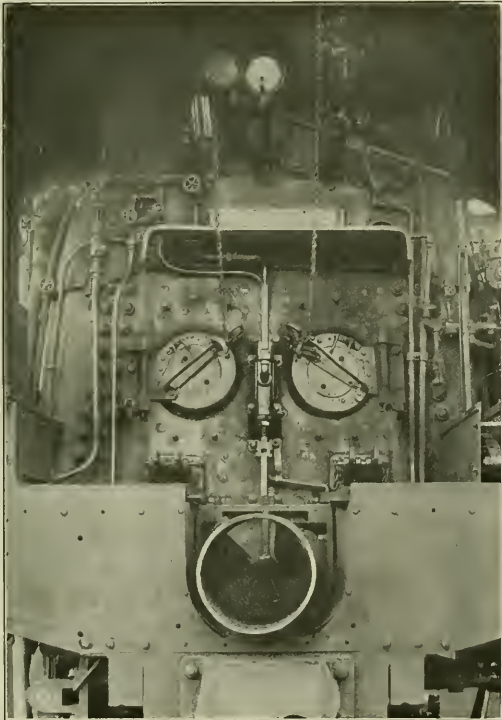

View in the Cab. The Jet Control Valve is Between the Doors and Close to the Back Head.

deck is supported by bearings at either end and its casing is rigidly secured to the locomotive deck plate and to the casing of the elevating conveyor. It is partially open at the top, having a small trap door in the cab deck for inspection. The section of the casing extending under the mud ring, as will be seen in the sectional illustration, fits the spiral with only moderate clearance for the full circumference, and the last full

spiral of this section becomes a feeding mechanism for the elevating spiral which of course, must be kept full of coal at all times. The bearing at this end of the conveyor is carried by a bracket from the top of the trough casing. This bracket is made as narrow as possible to give a minimum obstruction to the movement of the coal. The horizontal thrust of the different sections of this conveyor is resisted by large shoulders at each of the bearings.

The elevating spiral is placed in an exact vertical position

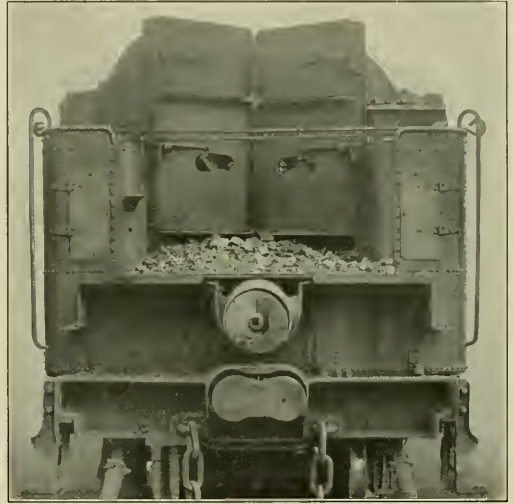

View of Tank Showing the End of the Conveyor.

and it extends from the bottom of the horizontal conveyor trough to a point about 12 in. above the level of the grate. This casing is also securely supported from the frame of the locomotive and is built with heavy rigid walls insuring its alinement and strength. For protecting the upper end which projects above the grate level, from the effect of the heat, a conical shape grate has been arranged which includes the top ring of casing and extends diagonally downward on the sides and in the front, allowing a free circulation of air around the casing. The bottom of this casing is made with a well that holds the lubricant for bevel gears by which the spiral is driven. The shaft has a long bearing above the gear and is supported on a ball thrust bearing. There is no bearing at the top of this conveyor.

A small two-cylinder reciprocating steam engine is at present used for driving the conveyors, although experiments are being made to ascertain the advantages, if any, of using either a turbine or more compact type of engine for this purpose. This engine, as at present operated, has a heavy flywheel at one end of its shaft and runs at about 160 revolutions per minute. It drives the horizontal shaft through a worm gear. This horizontal shaft is of large diameter and extends across the locomotive. It terminates in a bevel gear on the right end just inside the frame and is supported in bearings formed in the bed plate of the stoker, which in turn is supported from the deck casting and the frame. The large bevel gear meshes with two other gears. Both of these drive short shafts which have spur gears on the opposite end. The forward gear meshes with a gear on the shaft which carries the bevel gear for driving the elevating conveyor. The other spur gear meshes with and drives through a large gear on the horizontal conveyor. This gear is keyed to the section of the conveyor under the cab

deck, has its spokes arranged to form a part of the spiral of the conveyor and is so enclosed in the housing that the finest coal dust cannot reach the teeth. This housing is opened only at the point where the small spur gear meshes on the lower part of the right side and brass packing rings resting on coiled springs form sealed joints on the sides of the gear.

The jet control valve consists of a small casting containing a reciprocating valve and is secured on the boiler head between the fire doors. The valve stem projects through the bottom and is connected by a link through a rocker to an eccentric on the horizontal shaft under the cab deck. The steam supply line is connected to the center of the valve casing and a globe valve is provided in this line for controlling the pressure in the jets. A steam gage shows what pressure is being used. The valve is simply a hollow piston valve of the plug type with a connection to the steam supply at the center and a discharge from either end. As it is moved upward and downward by the eccentric it alternately opens a passage at the top and at the bottom which conveys the steam through a cored passage in the casting to an outlet leading to a pair of the jets. These jets are on the ends of 3/4-in. pipes, of which there are four coming from the jet control valve and passing through a 3-in. tube in the back water leg. The nozzles are located at about the center and somewhat above the top of the elevating conveyor and are arranged in a form and direction to blow the coal in fan shape to different parts of the firebox. Small globe valves on each of these supply pipes permit the intensity of the different jets to be varied as desired.

Lubrication for all of the important bearings is provided by means of oil cups accessible from the outside of the locomotive while standing on the ground. The chamber underneath the vertical elevator, which contains the bevel gears, is kept filled with oil at all times, the filling pipe being continued to the right side of the locomotive just above the frame. Other bearings have either grease cups or oil holes which can be occasionally lubricated when necessary.

In operation, it has been found that the running of the conveyor when handling 4,000 and 5,000 lbs. of coal an hour requires very little power. In fact, an estimate based on the speed of the small engine and the steam pressure, indicates that not more than 7 horse power is required for this purpose. The operation of the machine is remarkably noiseless and when the locomotive is in operation it is impossible to tell if the stoker is running or not except as observation is made of some moving part. In the case of the consolidation type locomotive on which the stoker is now being used, but one alteration was found necessary in the adjustment or arrangement of the locomotive. This consisted of enlarging the nozzle from 4 7/8 in. to 5 1/8 in. diameter. The locomotive is equipped with a brick arch and records have been made of the steam pressure during the past three months, readings being taken every five minutes while the locomotive was in operation, from which it is found that the average pressure for this time is 198 lbs., with the pops of the locomotive set to open at 200 lbs. It has been found that the distribution of coal over the grate is remarkably uniform and that the only necessity for using the rake occurs when there has been an unwise or too prolonged change made in one of the distributing jets which has supplied too much coal to a certain section.

The stoker is manufactured by the Standard Stoker Company, with offices at Grand Central Terminal, New York, and the du Pont, building, Wilmington, Del.

SEASONING TIMBER BY ELECTRICITY.—In describing his latest researches on the electrical seasoning of timber, Dr. Nodon claims that his process can be applied in the forest where the trees are felled, since no cumbersome or costly equipment is required. The process depends on the electrolysis of cellulose and its derivatives.—*The Engineer.*

MAHR OIL BURNER

A new type of burner that has found extensive use on car repair tracks and in railway shops has recently been perfected and placed on the market by the Mahr Manufacturing Company, Minneapolis, Minn. An illustration of the equipment with its three nozzles is shown in Fig. 1, and the design of the nozzle is clearly shown in Fig. 2. The most marked results obtained from the burners in actual service have been in the repairing of steel car underframes and of steel cars. Reports from the users of this device have been very satisfactory, and in many cases incidents were mentioned where a considerable saving had been made by its use. On one large road several 100,000-lbs. capacity

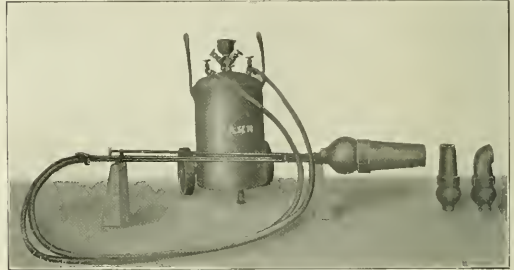

Fig. 1—Mahr Oil Burner for Car Repairs.

self-clearing hopper cars that had been badly damaged in a wreck and relegated to the scrap pile, were reclaimed with the aid of these burners and are now in active service. Fig. 3 shows one of these cars as wrecked, and Fig. 4 after it had been repaired. This was accomplished by heating the sheets and jacking them back into place, it not being necessary to cut the rivets during the work. The underframes of two cars which were badly damaged in a wreck were placed in good condition at a cost of \$215 each, with the aid of this burner.

While the use of this burner in heavy repairs is successful, it

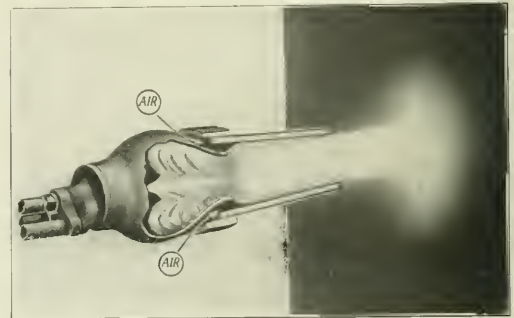

Fig. 2—Mahr Double Combustion Chamber Torch.

has found a still greater field in light repair work. With the ever increasing use of the steel underframe the slight repairs required by the car inspectors, such as bent end sills, bolsters, side sills, buckled sheets, etc., become an important and sometimes a costly factor in repair track work. With the aid of this burner such work is very quickly accomplished.

The elbow torch is readily used in heating the flanges of bolsters that have been damaged by shifting hooks, etc. One such piece of work was done in ten minutes by the ordinary repair track gang. The burner may also be used in close proximity to

the wooden structure of the car without injuring it in any way.

The burner may also be used in the shop in straightening axles. The axle is first heated and then bent straight by a jack; in one case worthy of note the work cost 20 cents. It has other uses throughout the shop, such as preheating locomotive parts preparatory to welding, bending and straightening, etc., making shrinkage fits, melting out bearings, heating bearings for babbitting, etc. In the boiler shop it is used for mud ring corners, flanging throat sheets, firebox door holes, annealing, etc.

The construction and operation of the burner is very simple.



Fig. 3—Hopper Car Damaged in a Wreck.

The tank is loaded with either crude oil or kerosene through the strainer at the top. The air pressure from the shop line is also admitted through this connection, two valves being applied for controlling these operations. The other two valves control the delivery of the air and the oil to the hose connections. The operator controls the intensity of the flame by the plug valve which is in the air line, and a needle valve for the oil, located at the burner but controlled through a long stem extending back to the end of the lead pipes. This permits of heating inaccessible parts of cars or locomotives without interfering with the operation of the burner. The construction of the burner is clearly shown in Fig. 2. The first chamber is so constructed as to choke

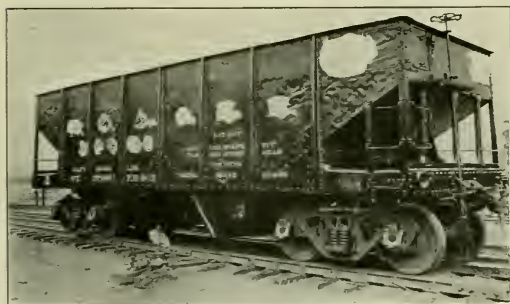

Fig. 4—Car Shown in Fig. 3 After Being Repaired.

the atomized oil so that it may be thoroughly ignited and on passing out of this chamber it draws more air through the auxiliary intake as indicated, which will complete the combustion of the atomized oil. Most any workman may be taught to handle the equipment in a short time.

The burner shown in Fig. 1 is specially designed for steel car work. The small straight nozzle and the elbow nozzle will heat an area 18 in. in diameter, and the larger nozzle, an area of 36 in. in diameter on a 5/8-in. steel plate in a few minutes. The tank

has a capacity of 20 gals. The small nozzle will consume 6 gals. per hour and the large nozzle 9 gals. per hour. The weight of the entire outfit is 210 lbs. Smaller burners are also made for other classes of work, and a special torch may be had for removing paint.

TOOL FOR REPAIRING TRIPLE VALVES

One of the accompanying illustrations shows a triple valve with the check valve case broken and the thread stripped at the branch pipe connection. Either of these defects would make this part worthless and would necessitate its being scrapped.

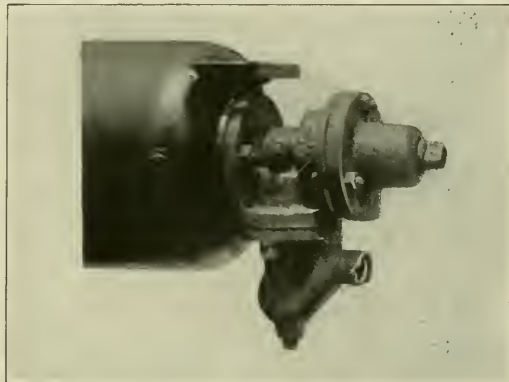

Triple Valve With Broken Check Valve Case and Stripped Thread.

In order to prevent this loss of material, a tool which is called the R. & G. Jiffy repair tool is being made by A. N. Rutan, 365 West Gray street, Elmira, N. Y., for repairing such defects. The parts and the assembled tool are shown in another of the illustrations. The die *A* is used for recutting the thread;

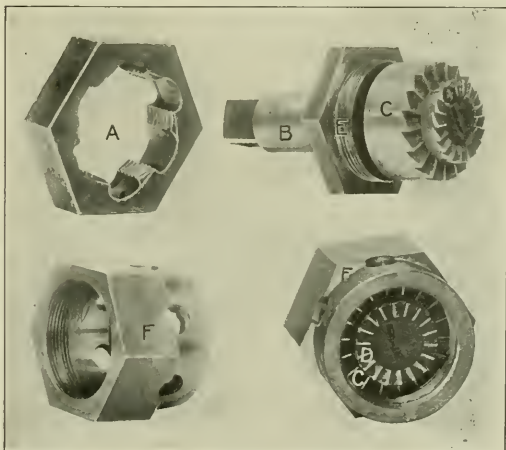

Parts and Assembly of the R. and G. Jiffy Repair Tool.

the shank of the tool *B* passes through the cap *E* and has secured to it a facing cutter *C* and a counterboring cutter *D*. The thread on the cap *E* screws into that on the body *F*, which in turn is screwed to the thread on the triple valve and steadies

the tool when it is being used. The holes shown in *F* are to provide a means of escape for the chips.

Another of the illustrations shows the tool in use and the results which can be accomplished by it. In the upper left hand corner is shown the die in use cutting new threads on the broken part. This die is made so that it can be easily and quickly operated under a car or in places where very little space is available. It usually takes about three minutes to cut the new threads. In the upper right hand corner the repair tool is shown in position after the threads have been renewed. The facing and counterboring of the damaged part are accomplished in one operation, the time necessary being from four to six minutes. In the lower left hand view is shown a West-

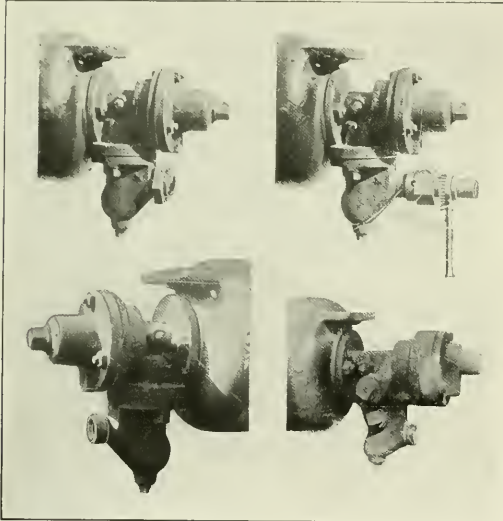

Method of Using the Tool, and Repaired Westinghouse and New York Triple Valves.

inghouse triple valve after repairs have been completed, while in the lower right hand corner is shown a repaired New York triple valve.

LANDIS STATIONARY PIPE DIE HEAD

A new stationary pipe die head that is simple in construction and is applicable to certain pipe machines of the rotating pipe type has been perfected by the Landis Machine Company, Waynesboro, Pa. A general idea of its operation may be obtained from the illustration. The head is composed of four major parts, namely, the head body which carries the chaser slides, the chaser slides, the operating ring, which imparts the oscillatory motion of the handle to the chaser slide, giving the chasers a universal radial movement to and from the center, and the chasers.

There are several important characteristics of this die. Its life is ten to twenty times that of the ordinary hobbled type die, due to the type of chasers used. Moreover, the line contact the chasers have with the work reduces the friction and permits of much higher cutting speeds. This increase in speed is augmented by the flexible rake feature, which makes it possible to obtain the best cutting condition and successfully thread all grades and kinds of pipe.

Since the lengths of thread on the standard sizes of pipe are fixed, a die that requires grinding in the throat is necessarily

comparatively short lived, as a few grindings will cause the length of thread to fall below the standard. This objection is eliminated with this die, since the cutting contour is always the same, this being due to the fact that the chasers are ground on their inner ends and never on the bevel surfaces which form the throat.

As one set of dies covers the entire range on all sizes of standard pipe where the pitch is the same, it is unnecessary to

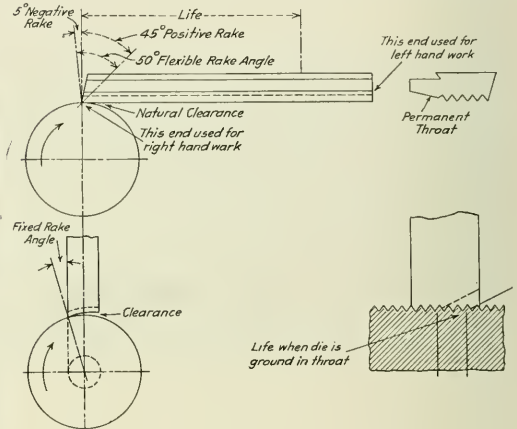

Graphical Comparison of Chasers for Pipe Threading.

remove the chasers from their holders, except for grinding purposes. Their removal is accomplished by slackening the two chaser clamping screws on each holder just enough to allow

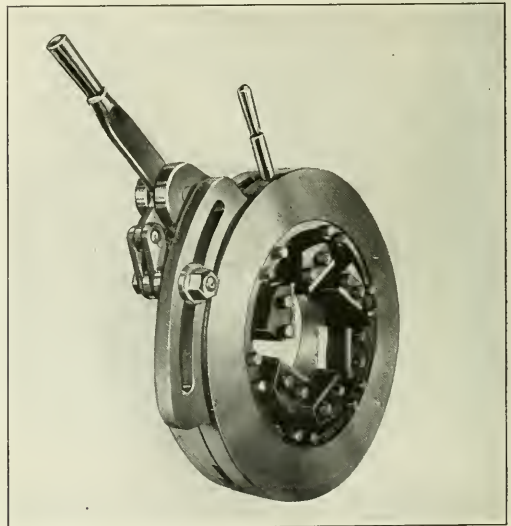

Die Head for Pipe Threading.

the chasers to be slipped from their seats. They are set to the proper position by bringing the cutting edges flush with the flat surfaces on the chaser slide provided for that purpose. A steel scale or straight edge will simplify this operation.

NEW POWER REVERSE GEAR

It is becoming generally recognized by railway men that locomotives in switching service, equipped with power reverse gear, can handle a much larger tonnage than those

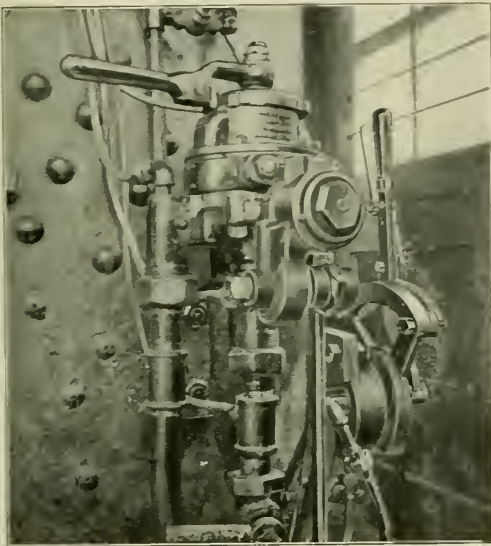

Arrangement of Lever and Valve in the Cab.

without, and as an adjunct to the efficiency and comfort of the crew such equipment cannot profitably be overlooked.

The Casey-Cavin reverse gear, which is a new power gear,

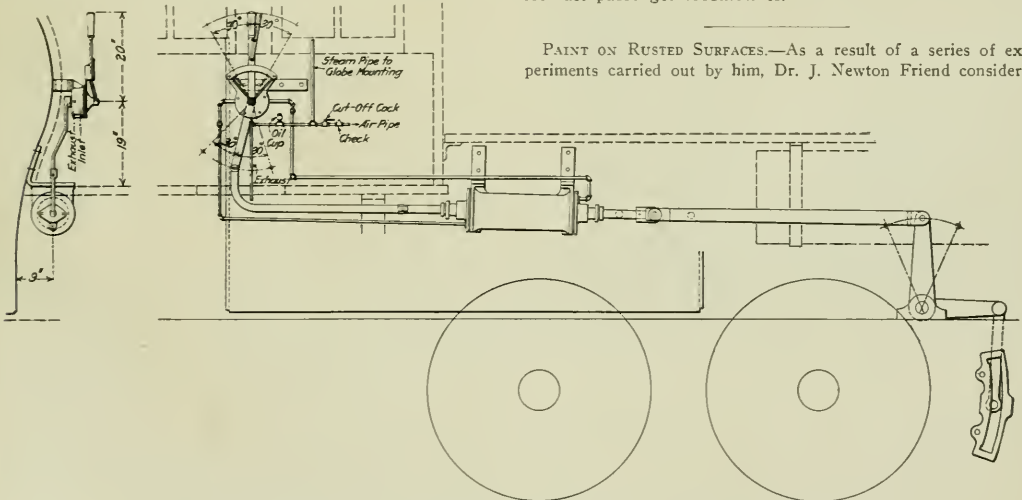

Application of Casey-Cavin Power Reverse Gear to a Canadian Northern Switching Locomotive.

has recently been introduced by the Canadian Locomotive Company, Ltd., Kingston, Ont., and patents are pending in several countries. The illustrations show the general arrangement and also the controlling valve and lever in the

cab. This application was made to some 0-6-0 type switching locomotives for the Canadian Northern.

The device consists essentially of a cylinder containing a piston, and rods so arranged as to shift the links or radius bars, and a valve containing two independently movable discs, one operated by the hand lever and the other by the connecting bar from the piston. These valve discs are so ported and arranged that on a movement of the hand controlled disc, pressure is admitted to one end of the cylinder and exhausted from the other end, thereby producing a movement of the piston which brings the ports in the other disc to the same relation that they originally bore to the hand controlled disc. After either a complete reversal or only a "hooking-up" of the motion, the pressure is held on both sides of the piston, thereby locking it at any point. From this it will be seen that should any excessive strain be set up in the reach rod, causing a movement of the piston, a compensating admission of pressure would take place on the opposite side of the piston. The point of cut-off is indicated by the position of the lever on the quadrant, corresponding to the hand type of lever, thereby guarding against confusion to inexperienced enginemen.

The cylinder is compact and can readily be attached to the boiler, firebox or running board in a substantial manner without interfering with other parts of the locomotive. The space occupied in the cab is very small, the travel of the handle being about 16 in.; the maximum pull necessary is from 12 to 15 lbs. The device is preferably operated by air pressure, but provision is made for the use of steam in the event of trouble with the air system. The total weight of the gear for a simple locomotive is about 375 lbs., and for a Mallet about 500 lbs.

Reports from applications made thus far are extremely satisfactory and seem to indicate that the device fills a long felt want, as it is reliable and at the same time so simple that it adds little or nothing to the cost of maintenance. A gear designed on similar lines and equipped with a positive mechanical locking device has also been developed by this company for fast passenger locomotives.

PAINT ON RUSTED SURFACES.—As a result of a series of experiments carried out by him, Dr. J. Newton Friend considers,

that a single coating of rust on ironwork to be painted is an advantage, as it permits a thinner paint to be used, and also enables it to grip better. An ordinary thick coating of rust, however, is objectionable.—*The Engineer.*

TIRE HEATERS

It has been claimed that a tire can be expanded and removed from the wheel center after ten minutes heating, but in these claims the time for attaching and removing the heater is not mentioned. In the development of the Hauck portable tire heater for roundhouse and similar work, it has been considered of prime importance to use the least possible time in attaching and detaching the outfit. The flexible casing of this heater is made up of sectional interchangeable steel segments in any num-

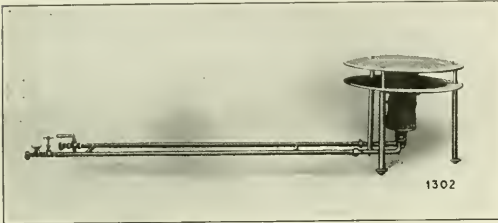

Hauck Stationary Tire Heater.

ber required and of the general form shown. Attached to these segments are brackets furnished with an index to assist in setting to any required diameter of tire. A steel frame truck is provided, if desired. These heaters are adapted for burning crude oil, and the tire casing can be adjusted to fit tires from 33 in. to 96 in. in diameter.

For mounting new or old tires it is customary to heat as many sets as can be conveniently handled by the force or equipment

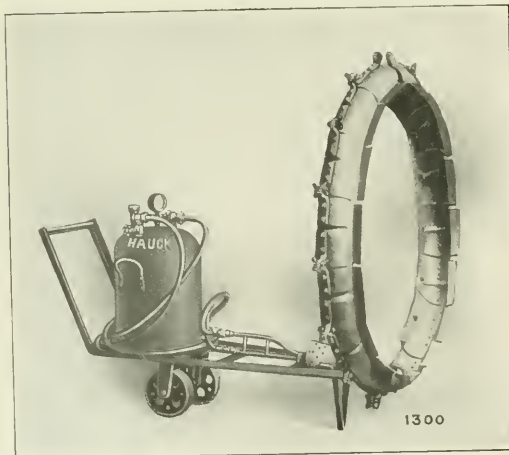

Hauck Portable Tire Heater.

available. The Hauck stationary type tire heater consists of a single Hauck special oil burner which is placed in the center of the nest of tires to be heated. It can be instantly lighted and readily adjusted to suit conditions. The flame is directed against the inside diameter of the tires, heating them quickly and evenly. It is claimed that a single burner machine is more easily started and controlled than one with two or more burners.

DOUBLE SPINDLE GRINDER

A new 18-in. disc grinder, having several interesting features, has been developed by C. H. Besly & Company, Chicago. It has two discs for grinding two parallel surfaces simultaneously, each being directly mounted on the shaft of a motor. The right-hand motor and its disc can be moved by means of a gear and rack, and clamped at any desired distance within a maximum of 10 inches from the other disc. In order to bring the discs in contact with the work the shaft and disc of the right-hand motor can be moved forward about one inch by means of the lever at the end of the shaft. A micrometer stop screw, graduated to .001 in., limits this motion so that work can be ground accurately to gage and then duplicated.

The dust hood telescopes automatically as the distance between the discs is varied. Ten work tables, varying in size from 1/4 in. to 55/16 in. in width, and suitable for all sizes of work

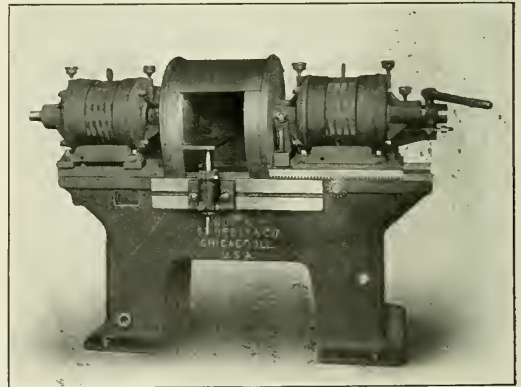

Double Grinder with Adjustable Head.

within the capacity of the machine, are regularly furnished.

The motors are of the Westinghouse steel frame induction type with special bearing brackets to carry the unusually large bearings required for grinding service. The capacity of each is 5 horsepower.

CEYLON'S RAILWAYS.—The railways of Ceylon are owned by the government, and there were 577 miles of line in operation at the end of June, 1911. Certain lines from Ratnapara to Mannar are under construction, while the construction of the Chilaw line has been authorized.

THE BRICK ARCH AND SMOKE.—The brick arch, by retaining heat and retarding the flow of the gases, permits their ignition, while without the arch they would escape without reaching the ignition point, and a portion at least would form smoke. The amount of smoke reduction, although comparatively small, is sufficient to warrant consideration, and application of arches alone or in combination with other devices.—*D. F. Crawford before the International Society for the Prevention of Smoke.*

CAPE TO CAIRO RAILWAY.—In an article dealing with the construction of the Cape to Cairo Railway, a writer in *Colonial Life* says: "The work has been stupendous and the difficulties immense. There have been the unfriendly attitude of the natives to contend with and overcome; encounters with lions, elephants, and other wild beasts in the northwestern parts of Rhodesia; and then, as the Congo was approached, the ravages of the white ant and other termites had to be reckoned with.—*The Engineer.*"

SEPTEMBER ANTHRACITE SHIPMENTS.—The total shipments of anthracite coal from Pennsylvania in September were 5,572,279 tons as against 5,876,496 tons in September, 1912.

NEWS DEPARTMENT

Intoxicating liquors cannot be sold in railroad cars in the state of Ohio after November 4, the attorney general having advised the state authorities that the constitution forbids the maintenance of "moving saloons."

The United States Civil Service Commission announces examinations for telegraph and telephone engineers, senior and junior, and for telegraph and telephone inspector for service under the Interstate Commerce Commission in valuation of the property of common carriers.

The new locomotive shops of the Wabash at Decatur, Ill., were opened on October 18, and 200 men employed at the Springfield shops have been moved, or will move to Decatur to take positions in the new shops, to which has been transferred much of the machinery from the old plant. Officers of the Wabash held a banquet in Decatur on the evening of October 18.

The International Railway Fuel Association has grown from an initial membership of 35 on November 20, 1908, to 615, the present membership. With a view of attempting to increase the membership to a minimum of 1,000 before the annual meeting to be convened in May, 1914, the executive committee has made a special appeal to every member to secure at least one new member.

SAFETY FIRST ON THE GRAND TRUNK

The Grand Trunk Railway of Canada, on which George Bradshaw has been promulgating "safety-first" ideas, has issued a placard 10 in. x 6½ in., the substance of which is reprinted below. The lettering is blue and red on white cardboard—a red, white and blue effect. At each corner in the border is a print of the safety first button.

GRAND TRUNK RAILWAY SYSTEM.

THE PLEDGE.

I will Railroad according to the Book of Rules. I will do all in my power to guard against unsafe acts on my part. If I see a fellow employe doing his work in an unsafe manner, I will speak to him, as a friend, and use my moral influence to have him perform his duties in the Safest Possible Manner. I will remember and practice at all times SAFETY FIRST.

EIGHTY-THREE PER CENT. of all persons injured on railroads are YOU MEN WHO WORK FOR THE ROADS. SIXTY-SIX PER CENT. of all preventable injuries sustained by you are DUE TO UNSAFE PRACTICES which you could avoid.

MEETINGS AND CONVENTIONS

American Society of Mechanical Engineers.—A new centrifugal pump with helical impeller will be the subject of a paper to be presented Tuesday, November 11, by C. V. Kerr, sales engineer of the A. S. Cameron Steam Pump Works, New York. Discussion will follow in which all are invited to take part. An informal dinner (à la carte) will be served at 6:30 p. m.

Railway Business Association.—The fifth annual meeting and dinner will be held Thursday, December 11, at the Waldorf-Astoria Hotel, New York. The business meeting will be at 11 a. m.; the election of officers at 1:30 p. m., and the dinner at 7 p. m. promptly. The speakers will be Howard Elliott, chairman, New York, New Haven & Hartford, and the Hon. James M. Cox, Governor of Ohio. A feature of the dinner last year was that numerous members invited citizens in position to influence public opinion and governmental policy, and the general executive committee expresses the hope that this plan may become still more general this year.

Car Foremen's Association of Chicago.—The annual election of officers of the Car Foremen's Association of Chicago, held October 13, resulted as follows: President, George F. Laughlin, general superintendent, Armour Car Lines; first vice-president, C. J. Wymer, general foreman, Belt Railway; second vice-president, A. Le Mar, master mechanic, Pennsylvania Railroad; treasurer, M. F. Covert, assistant master car builder, Swift & Company; secretary, Aaron Kline, 841 North Fifthth court, Chicago. The election was followed by a banquet, vaudeville and dance. The association is in a prosperous condition, having a membership of 876 practical car men.

The following list gives names of secretaries, dates of next or regular meetings, and places of meeting of mechanical associations.

- AIR BRAKE ASSOCIATION.**—F. M. Nellis, 53 State St., Boston, Mass.
AMERICAN RAILWAY MASTER MECHANICS' ASSOC.—J. W. Taylor, Old Colony building, Chicago.
AMERICAN RAILWAY TOOL FOREMEN'S ASSOCIATION.—A. R. Davis, Central of Georgia, Macon, Ga.
AMERICAN SOCIETY FOR TESTING MATERIALS.—Prof. E. Nærburg, University of Pennsylvania, Philadelphia, Pa.
AMERICAN SOCIETY OF MECHANICAL ENGINEERS.—Calvin W. Rice, 29 W. Thirty-ninth St., New York. Annual meeting, December 3-6, Engineering Societies' Building, New York. Railroad session, Thursday morning, December 5.
CAR FOREMEN'S ASSOCIATION OF CHICAGO.—Aaron Kline, 841 North Fifthth Court, Chicago; 2d Monday in month, Chicago.
CHIEF INTERCHANGE CAR INSPECTORS' AND CAR FOREMEN'S ASSOCIATION.—S. Skidmore, 946 Richmond street, Cincinnati, Ohio.
INTERNATIONAL RAILWAY FUEL ASSOCIATION.—C. G. Hall, 922 McCormick building, Chicago. Convention, May 18-22, 1914, Chicago.
INTERNATIONAL RAILWAY GENERAL FOREMEN'S ASSOCIATION.—William Hall, 829 W. Broadway, Windsor, Mich.
INTERNATIONAL RAILROAD MASTER BLACKSMITHS' ASSOCIATION.—A. L. Woodworth, Lima, Ohio.
MASTER BOILER MAKERS' ASSOCIATION.—Harry D. Vought, 95 Liberty St., New York.
MASTER CAR BUILDERS' ASSOCIATION.—J. W. Taylor, Old Colony building, Chicago.
MASTER CAR AND LOCOMOTIVE PAINTERS' ASSOC. OF U. S. AND CANADA.—A. P. Daue, B. & M., Reading, Mass.
RAILWAY STOREKEEPERS' ASSOCIATION.—J. P. Murphy, Box C, Collinwood, Ohio.
TRAVELING ENGINEERS' ASSOCIATION.—W. O. Thompson, N. Y. C. & H. R., East Buffalo, N. Y.

RAILROAD CLUB MEETINGS

Club.	Next Meeting.	Title of Paper.	Author.	Secretary.	Address.
Canadian	Nov. 11	Conservation Through Railway Electrification	G. P. Cole	Jos. Powell	Room 13, Windsor Hotel, Montreal.
Central	Nov. 14	From Mine to Mold	H. B. B. Yergason	H. D. Vought	95 Liberty St., New York.
New York	Nov. 21	Past, Present and Future of Railway Clubs	Daniel M. Brady	H. D. Vought	95 Liberty St., New York.
Pittsburgh	Nov. 28	Workmen's Compensation	C. W. Garrett	J. B. Anderson	Union Station, Pittsburgh, Pa.
Richmond	Nov. 10	Election of Officers	F. O. Robinson	C. & O. Ry., Richmond, Va.
St. Louis	Nov. 14	The Democratic Side of Public School Work	Prof. A. R. Moyan	B. W. Frauenthal	Union Station, St. Louis, Mo.
Western	Nov. 18	Not announced	J. H. Tinker	Jos. W. Taylor	390 Old Colony Bldg., Chicago, Ill.

PERSONALS

It is our desire to make these columns cover as completely as possible all the changes that take place in the mechanical departments of the railways of this country, and we shall greatly appreciate any assistance that our readers may give us in helping to bring this about.

GENERAL

The office of assistant superintendent of motive power of the Missouri, Kansas & Texas, at Denison, Tex., heretofore held by N. L. Smithan, has been abolished, and Mr. Smithan has been transferred to the mechanical department at Waco, Tex.

H. T. BENTLEY, principal assistant superintendent of motive power and machinery of the Chicago & North Western, has been appointed superintendent of motive power and machinery, succeeding Robert Quayle, promoted. Mr. Bentley was born June 4, 1862. He was educated at Dulwich College, and began railway work in 1877 with the London & North Western of England, where he was employed as an apprentice machinist until 1887. He was then for five years foreman of enginehouse of the same road at Chester, England. In 1892 he began work for the Chicago & North Western as machinist at the Chicago shops. Later he was made foreman of shops at Boone, Iowa, and from 1895 to 1898

was foreman at Belle Plaine, Iowa. He was then general foreman at Clinton, Iowa, and subsequently from April 1 to December 30, 1899, was master mechanic of the Madison division. Mr. Bentley was transferred to the Iowa division as master mechanic on January 1, 1900, where he remained until August 31, 1902, when he was appointed assistant superintendent of motive power and machinery at Chicago, the position he now leaves. Mr. Bentley was president of the Western Railway Club 1906-1907; president of the American Railway Master Mechanics' Association 1911-1912, and president of the International Railway Fuel Association 1912-1913. He is chairman of the sub-committee of mechanical officials of the General Managers' Association of Chicago for the prevention of smoke in the city of Chicago, and also is a member of the Headlight Committee of the Master Mechanics' Association. Mr. Bentley also is a member of the American Society of Mechanical Engineers.

B. E. MILNER, assistant master mechanic of the Philadelphia, Baltimore & Washington at Wilmington, Del., has been appointed special engineer on the staff of the senior vice-president of the New York Central Lines with headquarters at New York. He began railway work as a machinist's helper in the Parsons, Kan., shops of the Missouri, Kansas and Texas, resigning in 1900 to enter the mechanical engineering school of Purdue University from which he graduated in 1904. He then entered the service of the Pennsylvania Railroad as special apprentice at the Altoona shops. From September, 1904, to the following year he was engaged in work under E. D. Newson, engineer of tests, and chairman of the committee appointed by the Association of Transportation Officers to investigate "The Low Mileage of

Freight Car Equipment" and then was special representative of the superintendent of motive power. In the fall of 1905 he was again assigned by the engineer of tests to special work and in 1906 was placed in charge of planning a rearrangement in the location of machine tool equipment at the Altoona Shops. During the first half of 1908 he was sent to the west to visit the principal railway shops for the collection of ideas on betterment methods and practices and for a short time was engaged in putting these into effect. During 1908 and 1909 he was engaged in special work under the direction of H. M. Carson, then assistant to the general manager of the Pennsylvania Railroad at Philadelphia, and continued special work under his successor, J. E. Rogers, principally upon the study of betterment problems. He was appointed assistant master mechanic at Wilmington, Del., in May, 1911, but was temporarily relieved of his duties in 1912 to handle the preparation under the general manager at Philadelphia of the Pennsylvania's case for presentation to the board arbitrating the engineers' demands for increases in wages and adjustments of working conditions. He was engaged in similar work in the firemen's arbitration in 1913, under the direction of the chairman of the conference committee of managers and since January, 1913, when he was relieved of those duties, he has again been engaged as assistant master mechanic at Wilmington.

HARRY W. HIXMAN, apprentice school instructor of the Atchison, Topeka & Santa Fe, at Topeka, Kan., has been transferred from 422 Buchanan street to 705 West street.

MAJOR CHARLES HINE, vice-president of the Southern Pacific of Mexico and the Arizona Eastern, has resigned, effective October 16, to return to the field of expert railway work along organization and efficiency lines.



Charles Hine.

He already has been employed to do work along these lines on the Canadian Northern and while engaged on this his headquarters will be at Toronto, Ont. His permanent headquarters, however, will be at New York City. Major Hine was born March 15, 1867, at Vienna, Va., and was graduated from the Washington (D. C.) high school in 1885 and from the United States Military Academy at West Point in 1891. He was graduated from the Cincinnati Law School and admitted to the bar in 1893 while serving as lieutenant in the United States Army. He began railway work in April, 1895, and for three years was employed by the Cleveland, Cincinnati, Chicago & St. Louis successively as freight brakeman, switchman, yardmaster, conductor, chief clerk and trainmaster of the Cincinnati-Indianapolis district. He was then granted leave of absence in April, 1898, to serve in the Santiago campaign of the Spanish-American war as Major U. S. Volunteers, returning to the Big Four in February, 1899, as trainmaster at Cincinnati, O. In September of that year he was made general superintendent of the Findlay, Ft. Wayne & Western. He was inspector of safety appliances for the Interstate Commerce Commission in 1900, resigning November 1 of that year to go to the Chicago & Alton as assistant superintendent at Roodhouse, Ill. Major Hine was receiver of the Washington, Arlington & Falls Church Electric railway 1907 to 1908, and subsequently held various staff positions in special work and

reports on the Chicago & Alton, Chicago, Rock Island and Pacific, St. Louis & San Francisco, Chicago & Eastern Illinois, Chicago, Burlington & Quincy, Erie, Intercolonial, Prince Edward Island, Delaware & Hudson, Georgia & Florida railroads and National Railways of Mexico as well as other smaller roads. While with Gunn, Richards & Company, in 1907, he assisted in a revision of the business methods in the Department of the Interior at Washington, D. C. As temporary special representative of President Taft in 1910, he outlined a programme for improving organization and methods of executive departments of the United States government. From July, 1908, to December, 1911, as organization expert for the Union Pacific and Southern Pacific, he originated and installed the Hine unit system of organization. He was then in January, 1912, made vice-president and general manager of the Southern Pacific of Mexico and the Arizona Eastern, which position he now resigns, as above stated. Major Hine is the author of "Letters from an Old Railway Official to His Son," published by the *Railway Age Gazette*, and of other works.

ROBERT QUAYLE has been appointed general superintendent of the motive power and car departments of the Chicago & North Western, with headquarters at Chicago, Ill. Mr. Quayle was born at Douglas, Isle of Man. He began railway work with the Chicago & North Western in 1871 as machinist apprentice and until June, 1885, was successively journeyman machinist, gang boss and foreman. He was then promoted to the position of master mechanic and nine years later, on December 1, 1894, was made superintendent of motive power and machinery. After serving in the latter capacity for 19 years he will on November 1 become general superintendent of the motive power and car departments, with headquarters at Chicago, as above noted. Mr. Quayle was president of the Railway Master Mechanics' Association, 1898-1899.



Robert Quayle.

J. E. O'BRIEN, superintendent of motive power of the Western Pacific at Jeffery Shops, Cal., has been appointed assistant mechanical superintendent of the Missouri Pacific and St. Louis, Iron Mountain & Southern, with headquarters at St. Louis, Mo.

HARRY ROSE WARNOCK, has been appointed superintendent of motive power of the Western Maryland, with headquarters at Hagerstown, Md. Mr. Warnock was born on July 16, 1870, at Newcastle, Pa., and was educated in the public schools. He began railway work in June, 1889, with the Pennsylvania Lines West of Pittsburgh as a freight brakeman, and later in the same year went to the Pittsburgh & Lake Erie as a brakeman. He was then locomotive fireman and later engineman on the same road. From May, 1901, to May, 1904, he was consecutively engine despatcher, roundhouse and general foreman on the Monongahela division of the same road, and then to October, 1905, was master mechanic of the West Side Belt, at Pittsburgh, Pa. In October, 1905, he became general foreman of the Monongahela Railroad and was subsequently made master mechanic of that road, which position he held at the time of his recent appointment as superintendent of motive power of the Western Maryland, as above noted.

MASTER MECHANICS AND ROAD FOREMEN OF ENGINES

E. L. AKANS has been appointed master mechanic of the Virginia & Southwestern at Bristol, Va.-Tenn., succeeding J. W. Gibbs.

W. U. APPLETON, assistant to superintendent of motive power of the Intercolonial, at Moncton, N. B., has been appointed general master mechanic of the Intercolonial and the Prince Edward Island railways, in charge of all engine houses and shops (except Moncton shops), locomotives and machinery, with headquarters at Moncton.

W. E. BARNES has been appointed district master mechanic, district No. 3 of the Intercolonial, with office at Moncton, N. B.

JOHN C. BASFORD has been appointed assistant road foreman of engines of the Philadelphia division of the Baltimore & Ohio, with headquarters at Baltimore, Md.

H. G. CASTRON has been transferred as master mechanic of the Chicago, Burlington & Quincy from Beardstown, Ill., to Brookfield, Mo.

GILBERT DEMPSTER has been appointed master mechanic of the Southern Railway Company in Mississippi, with headquarters at Columbus, Miss., succeeding F. E. Patton, promoted.

J. T. FLAVIN, master mechanic, has assumed charge of the locomotive and car departments of the Chicago, Indiana & Southern, with headquarters at Gibson, Ind., reporting to the superintendent and the jurisdiction of D. R. MacBain, superintendent of motive power, has been withdrawn.

W. J. FRAUENDIENER has been appointed master mechanic of the Eastern division of the Cleveland, Cincinnati, Chicago & St. Louis, with headquarters at Bellefontaine, Ohio, succeeding J. T. Luscombe, resigned.

J. W. GIBBS has been appointed master mechanic of the Southern Railway at Sheffield, Ala., succeeding Frank Johnson.

GEORGE A. MORIARTY, whose appointment as master mechanic of the New York, New Haven & Hartford, with headquarters at South Boston, Mass., was announced in the October number,

was born on July 24, 1872, at Connellsville, Pa., and was educated in the schools of Cincinnati and the high schools of Newark, Ohio. He began railway work in February, 1887, as a machinist apprentice on the Baltimore & Ohio, and from March, 1891, to September, 1895, was machinist successively on the Pennsylvania Railroad, the Baltimore & Ohio, the Louisville & Nashville, the Cincinnati, New Orleans & Texas Pacific, and the Cleveland, Cincinnati, Chicago & St. Louis. He then returned to the service of the Baltimore & Ohio as



G. A. Moriarty.

machinist, and was subsequently machine shop foreman and general foreman on the same road. From August, 1898, to July of the following year he was in a contract shop, and then to May, 1903, was first a gang foreman on the Baltimore & Ohio, then roundhouse foreman, and later general foreman. In June, 1903, he went to the Erie as general foreman, and later became

master mechanic, leaving that company in August, 1907, to become master mechanic of the New York, New Haven & Hartford on the Old Colony division at Providence, R. I., which position he held at the time of his recent appointment as master mechanic.

A. E. HALE has been appointed road foreman of engines of the Tucson division of the Southern Pacific, with headquarters at El Paso, Tex., succeeding H. Moore.

T. W. HENNESSY has been appointed district master mechanic, district No. 2 of the Intercolonial, with office at Campbellton, N. B.

F. HODNAPP has been appointed road foreman of engines of the Baltimore & Ohio Southwestern, with headquarters at Flora, Ill.

MARK JEFFERSON has been appointed assistant master mechanic of the Lehigh Valley, with office at Easton, Pa.

FRANK JOHNSON has been appointed master mechanic of the Southern Railway at Birmingham, Ala., succeeding E. M. Sweetman.

GEORGE J. KINTZ has been appointed division foreman of the Atchison, Topeka & Santa Fe at Deming, N. M., succeeding George A. Belcher.

C. A. MCCARTHY, master mechanic of the Chicago, Rock Island & Pacific at Shawnee, Okla., has resigned to become master mechanic of the Colorado Springs & Cripple Creek District Railway, with office at Colorado Springs, Colo.

H. D. MCKENZIE, general locomotive foreman of the Intercolonial at Moncton, N. B., has been appointed district master mechanic, district No. 4, with office at Stellarton, N. S.

H. S. MORED, master mechanic of the Chicago, Burlington & Quincy at Ottumwa, Iowa, has been appointed master mechanic at Aurora, Ill., succeeding J. B. Roach, transferred.

F. W. NELSON, whose appointment as master mechanic of the Western division of the New York, New Haven & Hartford, with headquarters at Waterbury, Conn., was announced in the October number, was born on April 25, 1876, at Ogdensburg, N. Y., and was educated in the high schools. He began railway work in December, 1900, as a fireman on the New York, New Haven & Hartford, and has been in the continuous service of that road ever since. In March, 1903, he was made engineman, and from December, 1910, to May, 1913, he was road foreman of engines. He was promoted to general road foreman of engines on May 1, 1913, which position he held at the time of his recent appointment as master mechanic of the western division of the same road, as above noted.

W. J. O'NEILL has been appointed master mechanic of the Panhandle and Indian Territory divisions of the Rock Island Lines, with office at Shawnee, Okla., succeeding C. A. McCarthy, resigned to accept service with another company.

J. B. ROACH, master mechanic of the Chicago, Burlington & Quincy at Aurora, Ill., has been transferred to Beardstown, Ill., in a similar capacity, succeeding H. G. Castron, transferred.

W. F. ROSS has been appointed road foreman of engines of the Baltimore & Ohio, with headquarters at Benwood Junction, W. Va., succeeding J. F. Little.

H. W. SHARPE, acting master mechanic of the Intercolonial at Riviere du Loup, Que., has been appointed district master mechanic, district No. 1, of the Intercolonial, with office at Riviere du Loup.

G. M. STONE has been appointed master mechanic of the Oklahoma division of the Rock Island Lines, with headquarters at Chickasha, Okla., succeeding W. J. O'Neill, transferred.

D. R. SWENEY has been appointed master mechanic of the

Chicago, Burlington & Quincy at Ottumwa, Iowa, succeeding H. S. Mored, transferred.

K. TATE has been appointed assistant master mechanic of the Eastern division of the Cleveland, Cincinnati, Chicago & St. Louis, with headquarters at Bellefontaine, Ohio.

E. M. SWEETMAN, master mechanic of the Southern Railway at Birmingham, Ala., has been appointed master mechanic with headquarters at Princeton, Ill., succeeding G. N. Howson, promoted.

HARRY WHITHAM has been appointed division foreman of the Atchison, Topeka & Santa Fe Coast Lines at Gallup, N. Mex., succeeding George E. Johnson.

CAR DEPARTMENT

ALBERT A. ALLISON has been appointed car foreman of the Atchison, Topeka & Santa Fe at West 38th Place, Chicago, succeeding Frank Wilkinson.

GEORGE E. SMART has been appointed master car builder of the Intercolonial and the Prince Edward Island railways, with headquarters at Moncton, N. B.

J. W. SENGER has been appointed master car builder of the Lake Shore & Michigan Southern, with headquarters at Collinwood, Ohio, succeeding I. S. Downing, resigned. Through a typographical error in the October issue Mr. Senger's appointment was confused with that of Mr. Downing.

W. K. SMITH has been appointed car foreman of the Rock Island Lines at Hulbert, Ark., succeeding J. Barnett, resigned.

F. C. WATROUS has been appointed assistant foreman of car repairs of the Erie Railroad at Kent, Ohio, succeeding Louis Krall, resigned.

E. M. WILCOX has been appointed general car foreman of the Chicago, Indiana & Southern, with headquarters at Gibson, Ind.

SHOP AND ENGINE HOUSE

M. D. CHASE has been appointed general foreman of the Missouri, Kansas & Texas at Smithville, Tex., succeeding George Hilferink, resigned.

JOHN C. COLE has been appointed roundhouse foreman of the Rock Island Lines at Pratt, Kan., succeeding W. H. Graves, transferred.

FRANK J. ECHLE has been appointed general shop inspector of the Lake Shore & Michigan Southern and the Dunkirk, Allegheny Valley & Pittsburgh, with headquarters at Collinwood shops, Cleveland, Ohio, succeeding Joseph J. Schultz, transferred.

JOS. GRAHAM, erecting shop foreman of the Intercolonial at Moncton, N. B., has been appointed superintendent of the locomotive shops at that point, succeeding H. D. McKenzie, general locomotive foreman, transferred.

E. P. JOYCE has been appointed roundhouse foreman of the Erie Railroad at Kent, Ohio, succeeding M. J. Harrison, resigned.

A. J. KRUEGER has been appointed assistant general shop inspector of the Lake Shore & Michigan Southern and the Dunkirk, Allegheny Valley & Pittsburgh, with headquarters at Collinwood shops, Cleveland, Ohio, succeeding W. S. Gunther, transferred.

H. H. PARKER, roundhouse foreman of the Seaboard Air Line at Portsmouth, Va., has been appointed general foreman at that point.

J. C. SCANLON has been appointed roundhouse foreman of the Erie Railroad at Brier Hill, Ohio, succeeding W. R. Thracht, transferred.

PURCHASING AND STOREKEEPING

J. M. KILLIAN has been appointed storekeeper of the St. Louis Southwestern lines, and will have charge of all miscellaneous supplies and material other than ties, timber, piling, lumber and fuel, with headquarters for the St. Louis Southwestern at Pine Bluff, Ark., and for the St. Louis Southwestern of Texas at Tyler, Tex. He succeeds N. A. Waldron, resigned.

WILLIAM R. SHOOF, purchasing agent of the Buffalo, Rochester & Pittsburgh, at Rochester, N. Y., has been appointed manager of purchases and stores, with headquarters at Rochester, N. Y.

N. A. WALDRON, formerly storekeeper of the St. Louis Southwestern, has been appointed general storekeeper of the Missouri, Kansas & Texas, with headquarters at Parsons, Kan., succeeding J. M. Gibbons, resigned.

OBITUARY

JOHN F. ENSIGN, chief inspector of locomotive boilers, in the Division of Locomotive Boiler Inspection, of the Interstate Commerce Commission, died on September 24, after a long illness, at his home in Washington, D. C. He was born on March 23, 1862, at Marathon, N. Y. As a young man he went to Colorado and began railway work with the Chicago, Burlington & Quincy as a blacksmith. He later was made machinist, and subsequently became fireman and engineman. Nine years ago he was appointed an inspector in the Division of Safety Appliances of the Interstate Commerce Commission; and on March 2, 1911, was appointed chief inspector of locomotive boilers by President Taft, with headquarters at Washington. He was a member of the Brotherhood of Locomotive Engineers and a member of the Washington Society of Engineers. Mr. Ensign had spoken on safety appliances and the inspection of locomotive boilers before different railway clubs and other organizations.



J. F. Ensign.

NEW SHOPS

CHICAGO & WESTERN INDIANA.—This company has prepared plans for a roundhouse, locomotive shop, machine shop, storehouse, turntable and ash pits to be built near its yards now under construction at Clearing, Ill.

ILLINOIS CENTRAL.—This company has given a contract for building a new roundhouse at Nonconnah, Tenn.

NATIONAL TRANSCONTINENTAL.—A contract has been let to J. Gosselin, Levis, Que., for putting up machine and other shop buildings at St. Malo, Que.

NORFOLK SOUTHERN.—A six stall, square engine house is to be built at North Brevard street, Charlotte, N. C. The building is to be of brick construction, 90 ft. x 100 ft., and will cost about \$15,000.

SUPPLY TRADE NOTES

The American Steel Foundries, Chicago, has moved its general offices from the National Bank building to the eleventh and twelfth floors of the McCormick building, Chicago.

The Galena Signal Oil Company of Franklin, Pa., has bought about three acres of land at Clearing, Ill., on which to build steel storage tanks, a concrete and brick warehouse, and a power plant.

J. B. Kilpatrick, formerly mechanical superintendent for the First district of the Rock Island Lines, with office at Des Moines, Iowa, has been made a vice-president of the Chicago Air Brake Company, with office in Chicago.

E. E. Hudson has been made fourth vice-president of Thomas A. Edison, Inc., Orange, N. J., with office at Orange. Mr. Hudson will continue as heretofore in charge of the sales of the Primary battery department.

Chester H. Jones has been placed in charge of the steam railroad department of the General Electric Company's new St. Louis district office. Mr. Jones has been connected with the steam railroad department in the Chicago territory.

Blake C. Howard, heretofore southwestern sales manager of Mudge & Co., has opened offices in the Railway Exchange building, St. Louis, Mo., to handle a general line of railway supplies. He will continue to represent Mudge & Co., together with other accounts.

H. E. PASSMORE has resigned as master mechanic of the Toledo & Ohio Central to become vice-president of the Grip Nut Company, Chicago, in charge of sales in the eastern district. He will have headquarters for the present at Bucyrus, Ohio. Mr. Passmore was born at York, Pa., in November, 1869, and was educated at York Collegiate Institute and the Maryland Institute at Baltimore, Md. He served his machinist's apprenticeship with the Pennsylvania at Altoona, Pa., and worked as a machinist for the Norfolk & Western, Baldwin Locomotive Works, Philadelphia & Reading and Western Maryland. In 1903 he entered the service of the Toledo & Ohio Central as machinist, and advanced through the ranks to the position of master mechanic, which position he leaves on November 1 to enter the supply field. Mr. Passmore has been an active member of the Master Mechanics' and of the Master Car Builders' Associations, is now a member of some of the more important committees, and has a host of friends who welcome him into his new field of endeavor.



H. E. Passmore.

The Transue & Williams Company, Alliance, Ohio, has purchased all of the assets of the Davies-Bach Manufacturing Company, including the plant recently erected in Alliance for making steel stampings. It is expected to operate this plant, which is to be known as the steel stamping department of the Transue & Williams Company, and also to enlarge it materially in order to conduct a general steel stamping business. The

company also expects to add from 60 to 80 per cent. to the capacity of its present drop forge plant, and is now contracting for new buildings and additional machinery. When the new equipment is in place, about 200 additional men will be employed.

The Chicago-Cleveland Car Roofing Company has let building contracts for an addition to its Cleveland works and the work is now under way. The entire Cleveland plant is now operated by individual electric motors recently installed. Besides the Cleveland plant, this company is now manufacturing at three different points in Canada.

The International Oxygen Company has moved its executive offices from 115 Broadway, New York, to the works at Newark, N. J. Additional buildings have been erected for the offices and also to provide additional manufacturing room for the increased demands made upon the plant. The general sales offices will remain at 115 Broadway, New York, as heretofore.

C. C. BRADFORD, manager of the Cleveland office of the United States Light & Heating Company, New York, has been made sales manager of that company, with office in New York; and R. B. Clark has been made acting manager of the Cleveland office, succeeding to the duties of Mr. Bradford. Mr. Bradford was born in Caldwell, Kan., on May 27, 1880. In his early youth he moved to Cleveland, Ohio, where he received his schooling. He graduated from the Case School of Applied Science in the electrical course. Mr. Bradford started his business career with the Willard Storage Battery Company, Cleveland, and became manager of the Chicago office of that company and then manager of the New York office. He resigned the latter position to go to the General Vehicle Company, Long Island City, as assistant sales manager. He remained with that company until 1909, when he was made manager of the New York office of the United States Light & Heating Company. After one year the branch office at Cleveland, Ohio, was established and Mr. Bradford was made manager, which position he retained until his appointment as sales manager, with office at New York, as mentioned above.

Benjamin Tucker Lewis, western manager of the Railway Appliances Company, Chicago, died on October 11. Mr. Lewis was born in Madison county, Indiana, June 8, 1853. He began his business career as clerk and private secretary to the president of the Chicago & Iowa and Chicago, Pekin & Southwestern Railways in 1872, later becoming secretary and director, and also purchasing agent and general passenger and ticket agent for these companies, the Chicago, St. Louis & Western and the Chicago & St. Louis until 1887. From 1887 to 1890 he was director of purchases and taxes and fuel agent of the Chicago, Santa Fe & California. From 1890 to 1900, he was assistant to the vice-president and general manager of the Santa Fe & Mexican Central, with residence at Topeka, Kan., to 1898, and at Mexico City 1898 to 1900. He became identified with the Railway Appliances Company in July, 1901.



C. C. Bradford.

CATALOGS

VALVES.—Renewable discs and disc holders are a special feature of the Jenkins Bros. valves, which are illustrated in a large variety of forms and sizes in a leaflet being issued by this company from 80 White street, New York.

CHUCKS.—The Skinner Chuck Company, New Britain, Conn., has issued a catalog and price list describing its independent, universal and combination lathe chucks, as well as car wheel, planer and many other types of chucks.

RIVETING HAMMERS.—An eight page bulletin from the Ingersoll-Rand Company, 11 Broadway, illustrates a new line of Little David riveting hammers which are suitable for tank and boiler work which uses not larger than 1¼ in. diameter rivets.

BALDWIN FORTY THOUSANDTH LOCOMOTIVE.—Locomotive No. 8661, of the Pennsylvania lines west of Pittsburgh, which is one of thirty similar engines recently built by the Baldwin Locomotive Works, is the forty thousandth locomotive turned out by this company. It is a class K-3-s, Pacific type engine.

CRANE MOTORS.—Direct current motors designed exclusively for crane service are shown in bulletin No. 109 from the Shaw Electric Crane Company, Muskegon, Mich. The bulletin fully describes all parts of the motor and the illustrations show its arrangement and construction.

GAS ENGINES.—A small bulletin from the Mesta Machine Company, Pittsburgh, Pa., briefly describing the general principles of this type of gas engine and illustrating a number of recent installations. This company builds gas engines for any class of service and for any fuel gas in sizes upward from 350 brake horsepower.

PIPE THREADING AND CUTTING TOOLS.—Hand operated pipe cutters and die stocks are illustrated in a variety of sizes and forms, all being suitable for operation by one man, in a catalog being sent out by The Borden Company, Warren, Ohio. These die stocks carry the trade name of Beaver and are shown for any size pipe up to 8 in. diameter.

ELECTRIC TOOLS.—A leaflet from The Van Dorn Electric Tool Company, Cleveland, Ohio, shows several types of portable electrically operated drilling, reaming and grinding machines. It is claimed in this leaflet that these electric tools will accomplish 50 per cent. more work than a pneumatic tool of the same capacity and at one-third the cost for power.

OPERATING INCANDESCENT LAMPS.—The General Electric Company has recently issued bulletin No. A-4142, which deals minutely with the various operating conditions which affect the efficiency and life of incandescent lamps. The subject is treated exhaustively and is prefaced by an explanation of definitions so that the context may be entirely clear. It is well illustrated.

STEEL CONVERTER.—The Whiting Foundry Equipment Company, Harvey, Ill., has recently developed a side blow steel converter which can be installed in a gray iron foundry and provide a means for furnishing steel castings from small to moderate size. This equipment, an example of which was recently installed in the foundry of the Delaware & Hudson Company, Watervliet, N. Y., is fully illustrated in bulletin No. 106.

MANUFACTURE AND USE OF STEEL TUBING.—An address by J. H. Nicholson and Emil Holinger before the U. S. Naval School of Marine Engineering on the subject of the manufacture and use of Shelby steel tubing is being reprinted in pamphlet form by the National Tube Company, Pittsburgh, Pa. This address is particularly noteworthy because of the comprehensive information it contains. The bulletin reproduces a series of illustrations showing the manner of forming various articles from seamless steel tubing and also gives a list of uses to which this material can be adopted. This includes nearly 400 items.

Railway Age Gazette

MECHANICAL EDITION

INCLUDING THE
AMERICAN ENGINEER

PUBLISHED ON THE FIRST THURSDAY OF EVERY MONTH BY THE
SIMMONS-BOARDMAN PUBLISHING COMPANY,
WOOLWORTH BUILDING, NEW YORK, N. Y.

CHICAGO: Transportation Bldg. CLEVELAND: Citizen's Bldg.
LONDON: Queen Anne's Chambers, Westminster.

EDWARD A. SIMMONS, *President.* I. B. SHERMAN, *Vice-President.*
HENRY LEE, *Secretary.*

The address of the company is the address of the officers.

ROY V. WRIGHT, *Editor.* R. E. THAYER, *Associate Editor.*
E. A. AVERILL, *Managing Editor.* A. C. LOGGON, *Associate Editor.*
GEORGE L. FOWLER, *Associate Editor.*

Subscriptions, including the eight daily editions of the *Railway Age Gazette* published in June in connection with the annual conventions of the Master Car Builders' and American Railway Master Mechanics' Associations, payable in advance and postage free:

United States, Canada and Mexico.....	\$2.00 a year
Foreign Countries (excepting daily editions).....	3.00 a year
Single Copy	20 cents

Entered at the Post Office at New York, N. Y., as mail matter of the second class.

WE GUARANTEE, that of this issue 4,100 copies were printed; that of these 4,100 copies, 3,666 were mailed to regular paid subscribers and 100 were provided for counter and news companies' sales; that the total copies printed this year to date were 54,676—an average of 4,556 copies a month.

VOLUME 87. DECEMBER, 1913. NUMBER 12.

CONTENTS

EDITORIALS:	
Grinding Competition	635
Freight Car Repair Costs.....	635
Department Organization	635
Freight Car Repairs.....	636
More Care in Bolt Making.....	636
Preparing for Winter	636
Standard Box Cars.....	636
Steel Passenger Cars.....	637
New Books	637
COMMUNICATIONS:	
College Men and the Railroads.....	638
Turning Driving Wheel Tires.....	640
GENERAL:	
Heaviest 2-8-0 Type Locomotive.....	641
Firing Up Locomotives.....	643
Operation and Maintenance of a Locomotive Drifting Device.....	643
Mechanical Department Organization of the Erie.....	643
Formula for Saddle Pin Offset.....	647
Service of Vanadium Steel Locomotive Paris.....	648
Standard Gage Tracks Through Shop Buildings.....	648
CAR DEPARTMENT:	
Freight Cars Damaged by Improper Loading.....	649
Development of Steel Passenger Equipment.....	650
Steel Framing for Box Cars.....	652
Train Lighting Instruction Car.....	653
Repair Track Notes	656
Are Steel Passenger Train Cars Needed?.....	656
Steel Underframe Box Cars.....	657
SHOP PRACTICE:	
Miscellaneous Shop Kinks.....	661
Filter for Shop Drinking Water.....	662
Preparing Hard Grease for Journal Box Collars.....	662
Grinding Wheels and Their Use.....	663
Shop Output	666
Walschaert Valve Gear Gages.....	669
Autogenous Welding in Locomotive Fireboxes.....	670
NEW DEVICES:	
Link Side Bearing Truck.....	673
Quick Acting Lever.....	674
Young Locomotive Superheating Valve.....	675
Terry Train Lighting Set.....	676
Cab Window Ventilator.....	676
Acme Combination Flat Turret Lathe.....	677
National Coupler Release Rigging.....	678
Collapsible Stake Pocket	678
NEWS DEPARTMENT:	
Notes	679
Meetings and Conventions.....	680
Personals	681
Supply Trade Notes.....	683
Catalogs	684

Grinding Competition

Walter R. Hedeman has been declared the winner of the prize of \$35, offered in the August issue for the best article on grinding, which reached this office on or before October 1. Mr. Hedeman's article appears elsewhere in this issue and gives the conclusions reached after an exhaustive study of the whole subject. The selection of the shape and grade of grinding wheels for different purposes has not generally received the attention it deserves, nor do most shops give the care they should to keeping the wheels in the proper condition, running at the proper speed, or provide instructions for the proper manner of using them. Mr. Hedeman's article fully covers all of these features, and will, no doubt, have a strong influence toward correcting these omissions.

Freight Car Repair Costs

The master car builder of a large railway attributes the rapidly increasing cost of the maintenance of freight equipment mainly to four causes: the rapid introduction of heavy locomotives; the promotion of firemen inexperienced in the handling of locomotives, to the position of locomotive engineer; the indiscriminate use of heavier cars in the same train with light ones; and the sawing back and forth necessitated at passing tracks by the operation of a dense traffic in heavy trains on single track lines. The heavy locomotive has undoubtedly come to stay and the only way to overcome the difficulty caused by heavy motive power is to build cars strong enough to withstand such usage. Some railway managers have been broad minded enough to see this, but a large amount of needless car repair expense can be traced directly to a policy of cheapness in first cost, regardless of maintenance results. Education and discipline, intelligently administered, will go a long way toward making careful engineers out of young men who are careless mainly because they are inexperienced. The remedy for the second difficulty would seem to be the provision of an ample number of competent road foremen; and the application of these two remedies should, to a large extent, provide relief from damage due to the other two causes as well.

Department Organization

In the November issue there appeared an article which discussed the organization of engine houses at some length. In this issue R. S. Mounce presents the diagrams with a brief explanation of the organization of the whole mechanical department of the Erie Railroad in which there has been a number of important changes made during the past year. These have now been in effect long enough to indicate that they were wisely made. An inspection of the diagram will show that in general the principles of good organization have been followed. The paths of authority and responsibility are clearly defined and proper appreciation has been given the value of a sufficient staff for the general mechanical superintendent.

Because this is a good organization for the mechanical department of the Erie does not necessarily prove that it is the best one for the mechanical department of some other road. The determination of the best organization in each case can only be reached after a most careful study of not only the local conditions, but the personnel of the department throughout. If the result is good, it will be capable of being easily diagrammed and will have a minimum number of officers with divided responsibility. In view of the necessity for full co-operation between the operating and the mechanical departments for the most efficient service in both, there will of necessity be some divided responsibility, particularly in the case of the road foreman of engines. The same condition exists between the locomotive and car departments, and in the case of the Erie it will be seen that the mechanical superintendent of the car department transmits his instructions to the divisional foreman in

charge of car repairs through the mechanical superintendent and master mechanic.

Furthermore, a good organization will permit of a brief description and simple short instructions that will give every officer in the department accurate knowledge of the exact limit of the authority and responsibility of himself and every one else in the organization. Can this be done in your department or in your shop?

Freight Car Repairs

A damaged car comes to the repair track with several broken parts which failed under fair usage. Is it wisdom or economy to replace the broken parts with others of exactly the same design and construction? If you do, have you any cause to expect that the car will not appear on the repair track at the next division point? To be sure, most roads are doing just this, but can't you conceive of a better practice? If you can, write it out and send it to us for publication. You may win a prize of \$50 if it reaches this office before February 1, and in any case, if it is used, you will be fully recompensed. What do you know about box car roofs? Is it advisable to put an all-metal roof on a wooden framed car? Is the all-metal roof better than an inside or an outside metal or an all-wood roof, in any circumstance? Have you any facts to back up your conclusion? Send them to us, we want your ideas on these subjects. The same applies to the design of freight cars of all classes, as well as to passenger cars; draft gear design and application; the best organization of forces in car repair yards or shops; the ventilation of steel passenger cars; in fact, articles on any subject of interest to the car department will be accepted in this competition if they reach this office before February 1, 1914. Announcement of the winner will be made in the March issue if possible, and all articles which do not win a prize but are accepted for publication, will be paid for at our regular space rates.

More Care in Bolt Making

A recent examination of the bolts in a storehouse of a large railway system disclosed the fact that many were considerably under size. Out of 21 bolts picked up at random 14 were more than 0.005 in. under size, 4 were 0.005 in. under, 2 were 0.005 in. over size, and only one was of the exact size. The greatest variation found was 0.03 in. under size which in a 1/2 in. bolt would reduce the tensile strength of the bolt 14.7 per cent., and in a 1 in. bolt 7.1 per cent., reducing the factor of safety in both cases by similar percentages. The threading of bolts is one of the large jobs in a railway shop that is given little attention. A speaker at the last Tool Foremen's convention, when telling of the poor results obtained from the dies said, "the general impression in shop practice is that anything with two legs can run a bolt cutter or other thread-cutting machine." In another case a foreman of the bolt shop, who was placed there on account of his driving capabilities, was found cutting the threads on one size of bolts with the dies of the next smaller bolt size, because, as he stated, it saved time and increased the production.

While this work may be considered rough work in which refinement is not necessary, it is certain that it must not be neglected altogether, not wholly on account of the reduction in the strength of the bolt, but from a production cost standpoint. The production on different roads will vary from 5,000 to 50,000 bolts with one sharpening of the dies, and those roads having the smallest production will have the greatest trouble with the die heads. Keeping both the machines and dies in good condition, and instructing the workmen to operate the machines properly, will all tend to lower the cost of production and provide a bolt that can be relied on. In the report of the Tool Foremen's Association it was stated that

the Big Four was able to hob all of its bolt dies for the whole road in a standard head in the tool room as the bolt machines were maintained in good condition. On most other roads it is necessary to send out the blank dies and have them hobbled on the machine in which they are to be used. On the Central of Georgia all bolt dies are removed each morning and exchanged for other sets at the tool room, the old dies being examined by the tool experts and repaired when necessary. This eliminates any chance of poor work from the machine operator and insures a properly threaded bolt. Is there any good reason why other shops should not do as well?

Preparing for Winter

A great deal of work is necessary by the motive power department each fall in repairing locomotives and shops for the winter months. It is often very difficult to have all these preparations completed before the first signs of cold weather appear, but by systematic action a great deal can be accomplished. Storm windows for shops and engine houses always have more or less glass broken when they are removed in the spring and the windows should be taken out of storage in ample time to have this glass renewed before they are needed. A very good method of handling this is to make the necessary repairs when the windows are taken down in the spring. If a proper storage place is provided there should be no danger of more breakage taking place during the summer and it is then only necessary to clean the windows before putting them in place.

Careful record should be made, before shop heating plants are closed down in the spring, of any repairs that are necessary and these should be given attention during the summer months. Repairs to a heating plant can be worked in very nicely to keep men busy on slack days during the months that the plant is not in operation.

A great deal of the difficulty attendant on the installation of side and back curtains on locomotives can be obviated by proper marking and storing of the equipment when it is taken off in the spring. This should be given prompt attention in the fall as an early cold snap or snow storm may cause much discomfort to the crew of a locomotive which has not any side or back curtains. If such equipment is properly designed it can be standardized for a great majority of the locomotives, and by putting the rods in place in the latter part of the summer, it is an easy matter to slip on the curtains when the weather begins to turn cold.

Standard Box Cars

R. W. Burnett, general master car builder of the Canadian Pacific, in his paper before the American Society of Mechanical Engineers, which is given elsewhere in this issue, sees a tendency toward the adoption of a standard box car in the rapid development and uniformly satisfactory experience that has followed the introduction of the steel frame, inside sheathed car a few years ago. He points out that it is certain there will be no backward movement to a wooden superstructure and that this type of car, with possible modifications, will remain a standard car unless some superior type is developed. In support of this position, it is pointed out that a car constructed of rolled shapes seldom needs renewal of any of its framing for, even when the car is wrecked, these parts can easily be straightened and formed to the original shape at any car repair point. Even if they must be renewed, standard shapes can be quickly obtained from the mill or from stock in all of the principal cities. Mr. Burnett bases his opinion on experience with the design, construction and maintenance of 30,000 cars of this type and what he has to say is deserving of the most careful consideration.

George W. Rink, mechanical engineer of the Central Railroad of New Jersey presented a paper on steel underframes for freight cars at the same meeting. This paper is so extensive that space will allow the insertion of but part of it in

this issue. Mr. Rink has made a most careful analysis of the design of a large number of steel underframe cars. Formulas for strength of various parts are presented to be used as a basis of comparison. The study that results develops a number of interesting opinions, some of which are open to argument. Mr. Rink also makes a plea for a standard car and suggests the appointing of a committee representing the various railroads throughout the country with a view of developing a standard box car which will eliminate cars of inferior design and light construction, resulting in quicker repairs and decreased operating expenses.

While a standard car may be very advisable from some standpoints there are so many objections that can be logically raised to it that it would seem much more feasible to reach some conclusion as to the minimum allowed strength of car underframes which, combined with standard inside dimensions, would allow the designer to better adapt his construction to the service in which it was to be used. In considering a standard car it is not conceivable that any action can be taken which will force the destruction of a large number of perfectly good cars. This, in effect, means that even were a standard car adopted during the next year, the advantages could not be fully obtained for six or eight years at the earliest. On the other hand if a standard strength requirement is determined, it could be put in force within two or three years and cars already in service could be strengthened to meet this standard without prohibitive expense.

Steel Passenger Cars

The railroads of this country have already practically ceased ordering wooden passenger cars. The percentage of new wooden passenger train cars placed in service has dropped from 51.4 per cent. during 1909 to 3.3 per cent. during that part of 1913 thus far reported. During the first six months of the present year no wooden cars were ordered. This is one of the reasons why no hasty or ill advised action should be taken by Congress in connection with legislation, forcing the railroads to use only steel equipment, as is set forth in a well digested study of the steel passenger car situation which appeared in the November 21 issue of the *Railway Age Gazette*. It is pointed out that no drastic mandatory statute is called for when those affected are already doing voluntarily what is sought. It is further pointed out that the maximum capacity of the present car building plants of the country for steel passenger cars is but slightly over 3,000 cars a year and it would thus take nearly ten years to replace the 47,000 wooden and composite cars that are now in service, even without making allowance for additional equipment required for increased traffic and new lines during that time. It would cost nearly \$615,000,000 to replace these cars on the basis of an average cost of only \$12,800 each. As a matter of fact, steel passenger cars cost considerably more than this at the present time. One steel car builder is the authority for the statement that steel passenger cars cost from \$14,000 to \$17,000 each.

When it is considered that only 3.1 per cent. of those killed and 21.4 per cent. of those injured on railways are passengers, and further that less than one-half of the passengers killed were in collisions or derailments, the passing of a mandatory statute compelling this large expenditure would hardly seem desirable. In the same connection it must be considered that safety measures other than steel cars are badly needed. No wrecks were ever prevented by the use of steel cars and the wiser course seems to be to make investments for block signals and for the maintenance of better discipline, both of which will actually tend to prevent accidents. In the case of collision, it is beyond contradiction that the steel cars will prevent loss of life and reduce injuries. This feature of the case is well summed up in a recent report of the New York Public Service Commission of the Second district which states: "The enormous cost that would

be required to replace the present equipment of wooden cars in advance of the natural movement in that direction, coupled as it would be with more or less diversion of funds needed for the prevention of accidents, to a purpose that only minimizes the effect of accidents which ought not to have occurred, is one of the considerations to be given proper weight in the study and investigation which we strongly favor."

It is further pointed out in this study that nobody at the present time can draw a bill specifying the type of car which will best insure safety, because expert opinion still differs as to the respective merits of all-steel, steel frame and steel underframe construction and other important details involving both safety and cost. On this phase of the subject the result of the investigation led to the conclusion that the steel underframe car, and more particularly the steel frame car, may be made as strong as the all-steel car and because of their behavior thus far, will probably be included under the classification of steel cars if action is taken by Congress to force the railroads to adopt such equipment.

NEW BOOKS

Proceedings of the Fifth Annual Convention of the Tool Foremen's Association. Bound in paper, 6 in. x 9 in. 133 pages. Illustrated. Published by the Association, A. R. Davis, Central of Georgia Ry., Macon, Ga. Price 50 cents.

These proceedings contain a full report of the recent convention held in Chicago. Many interesting topics were discussed, among which was the reclamation of tool steel, the form of thread and degree of taper for boiler studs and plugs, forging machine dies, thread cutting dies, and superheater tools. This association is made up of expert tool makers, and there is much valuable information contained in its proceedings.

Strength of Materials. By Mansfield Merriman. Sixth edition, revised. Illustrated, bound in cloth, 166 pages, 5 in. x 7½ in. Published by John Wiley & Son, New York. Price \$1.

Merriman's *Strength of Materials* is too well known as a text book to require any extended description. The first edition was issued in November, 1897, and it has now passed to the sixth edition, each being revised to keep pace with the advance of knowledge in this field. In the fifth edition a new chapter was added on reinforced concrete, especially columns and beams and in the sixth a new chapter on combined stresses has been added. Numerous changes have been made throughout the book and many new problems have been introduced. This standard work offers an opportunity for the study of the strength of materials, beams, columns and shafts which may be understood by those not acquainted with calculus. The degree of mathematical preparation required for an understanding of the problems presented is merely that now usually given in high schools. The book deals mainly with questions of strength, the subject of elastic deformations occupying a subordinate place. Since the deductions of the deflection of beams are best made by calculus, they are not here attempted, but the results are stated so that the pupil or reader may learn their uses. A chapter on the manufacture and general properties of materials is given as well as one on resilience and impact.

Railway General Foremen's Association Proceedings, 1913. Bound in paper. Illustrated. 173 pages. 6 in. x 9 in. Published by the Association, William Hall, secretary, Winona, Minn. Price \$1.

The International Railway General Foremen's Association occupies an important field which is not covered properly by any of the other numerous mechanical associations. That its officers and members fully appreciate their responsibility is well illustrated by the work of the ninth annual convention held at Chicago in July, 1913. The proceedings fully demonstrate their activity and in addition to the verbatim account of the discus-

sions and the full text of the reports, it includes the subjects and the chairmen of committees to report at the next convention.

Air Brake Association. Proceedings of the twentieth annual convention. Bound in leather, 321 pages, 6 in. x 9 in., illustrated. Published by the Association, F. M. Nellis, 50 State street, Boston, Mass., secretary. Price \$2.

This association is one of the most logical associations in the railway field. Its meetings are well attended, and the information presented is of great value to the men engaged in the maintenance and operation of air brake equipment. Many of the vagaries of the air brakes are discussed and means found for their elimination. This association perhaps more than any other similar association, calls on the engineering staffs of the manufacturers of air brake equipment and supplies for information that they are able to give concerning special investigations made in their respective lines. This year's proceedings contain papers on Undesired Quick Action; Operation of Long Freight Trains; Operation of the Triple Valve; Air Hose Failures; Location of Steam Heat Traps, and a report of the committee on Recommended Practice.

Master Blacksmiths' Association Proceedings, 1913 Convention. Bound in cloth. 236 pages, 5½ in. x 8¼ in. Illustrated. Published by the association, A. L. Woodward, Secretary, Lima, Ohio.

A general report of the twenty-first annual convention of the Railroad Master Blacksmiths' Association appeared on page 485 of the September issue of this journal. While this account covered the essential parts of the reports and discussions, those who wish to investigate the subject more fully will find the complete report on each subject as well as a verbatim account of the discussion in the proceedings. The papers this year were on the following subjects: Flue Welding; Tools and Formers; Electric Welding; Drop Forgings; Piece Work; Case Hardening; Oxy-Acetylene Welding and Cutting; Heat Treatment of Metals; Cast Steel in the Blacksmith Shop, and Efficiency. The same fault exists in this association that is seen in so many of the other mechanical meetings, that an attempt is made to handle far too many subjects for the length of time allowed. The consequence is that nothing is done completely and no important conclusions are reached. In spite of this however, the work at this convention is interesting and, to a certain degree, valuable.

Traveling Engineers' Association Proceedings, 1913 Convention. Bound in flexible leather. 371 pages, 5¼ in. x 8¼ in. Illustrated. Published by the Association, W. O. Thompson, secretary, Buffalo, N. Y. Price \$1.50.

The twenty-first annual convention of the Traveling Engineers' Association, held in Chicago, August 12-15, 1913, fully maintained the reputation of previous meetings for the practical and beneficial manner in which the subjects were treated. Reports were made on: Uniform instructions to enginemen on the handling of superheater locomotives; Credit due to the operating department for power utilization and train movement that reduces consumption of fuel; What can be done to eliminate the black smoke evil on locomotives; Advantages obtained with the brick arch in locomotive service, and, Care of locomotive brake equipment on line of road and at terminals. In each case the discussion was thorough and extended. In addition to the reports, a number of prominent railway officials were invited to address the meetings. The speakers included W. L. Park, vice-president of the Illinois Central; W. A. Garrett, vice-president of the Chicago Great Western, and W. J. Tollerton, general mechanical superintendent of the Chicago, Rock Island & Pacific. The proceedings contain the full text of the reports, discussion and addresses and an index of the subjects brought up at each convention since 1893, when the association was organized. The subjects for discussion which will be presented at the next convention and the committees having them in charge are also given.

COMMUNICATIONS

COLLEGE MEN AND THE RAILROADS

STATE COLLEGE, Pa., October 21, 1913.

TO THE EDITOR:

There are many answers to this question. "Because there are plenty of recruits to fill the ranks, and when one drops out it is a pretty sure indication that he lacks stability of purpose," says a railroad official. "Because he is required to spend years doing the work of a machinist rather than applying directly what he has spent four years to acquire," adds a college teacher. "Because he can get a better job," replies a special apprentice. Each may be in part right, yet somewhere there is something radically wrong.

The railroad can hardly excuse itself by saying that it does not secure the graduates of the desired mental make-up and personal qualities and that the college alone should bear the brunt of any unfavorable results. On the other hand, the technical school has no right to maintain that, although it should confine itself to fundamentals, its very existence demands practical instruction along certain lines, as in stationary practice, but the obligation does not concern itself with railroad mechanical problems, although 10 to 20 per cent. of the students going out may enter some line of railroad service. While such diverse opinions too commonly control the situation, the two main interests concerned do not come together in close working relations. In the meantime the special apprentice takes a place with more immediate promise and better pay—and the ranks are filled up again. Is not this a conservative statement of the situation? What is the first step in bettering the condition?

Your correspondent in the October issue gives a remedy which I would modify as follows: Make the special apprentice course three years, instead of two as suggested, six months of the total to be taken during summer vacations, as is being tried out successfully. If he gives evidence of being the type of man qualified for advancement, make it worth his while to remain; if he is not, tell him so. The result will be a sifting process, as it now is, but the method will be more business-like.

Seven students from different colleges began summer work last June in the shops of a certain railroad. By September, but one of their number was still in the employ of the company. Two said that the city air did not agree with them in the summer, although they appeared to be in perfect health and had passed the physical examination; but the master mechanic, a well known railroad engineer who was looking for young men of fixed purpose and mature judgment, was disappointed. The one who "made good" is asked to go with this company on finishing at college, receiving for the time spent in summer work credit on his three year special apprenticeship course. Unless, however, the company pays him a living wage, he will seek a place where he can soon pay off the debt of money borrowed to finish his college course. Having selected a man by the process of elimination, is it not a short sighted policy to pay him less than a fair living wage?

As pointed out in your editorial in the October number the engineering principles taught are not commonly applied to railroad mechanical problems. Moreover, the college professor or instructor is called on to suggest men for places with railroads the nature of the requirements of which he is confessedly ignorant. This is not right. The case cited above of the seven students doing summer work is an extreme one. The writer has known personally over two hundred undergraduates who have done good work and stuck to their jobs during two or three months in the summers between college years.

Under the title, "How Can the Colleges and Industries Cooperate?" I. L. Lee, executive assistant, Pennsylvania Railroad, presented at the last annual meeting of the Society for the Pro-

motion of Engineering Education, a composite of the views of the higher officials of that railroad.* The essence of the criticisms is summed up in the following:

"Let me be concrete. It is the experience of the Pennsylvania Railroad officers that graduates who come to them from technical schools are deficient in three general particulars:

- "1. Lack of practical experience and judgment.
- "2. An idea that they are far superior to the rest of mankind.
- "3. A certain narrowness of mind, inculcated through a too exclusive attention in college to mathematics and theoretical science, and a too great neglect of those broader subjects, such as political economy, history and general literature."

Here we have a frank statement worthy of serious consideration. The suggestion for bettering the college conditions, as made by Mr. Lee, proves that the railroad concerns itself with a solution. In close relation with the subject of this discussion, the writer would add the following comments suggested by Mr. Lee's discussion.

(1) The lack of practical experience would not seem to be as serious a charge as others which could be made. In the average span of life, the young man will have thirty or forty years of practical experience as against four years of study confined largely to theory. I take it that the central purpose of a general college training is to teach men to think for themselves, to develop self-mastery and to value things for their true worth; but it is not the place to train a specialist. Any American technical school which would today attempt to teach strictly within the limits of this purpose, without giving instruction in the practical applications of the science, would soon lose recognition, for the requirements of the commercial interests are justly exacting. New methods leading to a more experienced graduate are being adopted.

As an example, in addition to the practical instruction given at the Pennsylvania State College, each student is required to spend a total of 18 weeks in outside engineering employment during the summer months before he reaches his senior year. After a close study of results in mechanical engineering covering a period of three years, the writer is confident it is developing a more experienced young man with a better judgment and one who has a higher wage-earning value, even at the beginning of his apprenticeship.

(2) I have known but very few cases where the railroad organization did not soon level off the high places in the sense of superiority—better termed "big head" conceit—where such a weakness has been his heritage from a college training. Any college which fosters such a spirit is doing the young man a serious harm; while, on the other hand, if it develops self-assurance without over-confidence, the college has done a service.

(3) On the third count raised by Mr. Lee, it may be well to note what the colleges are now doing in their division of time for the different subjects taught. Below are given the average results of percentages of time allotted to group subjects in mechanical engineering courses in ten leading colleges of the country. This table was made up four years ago, but the few alterations since that time would change but slightly the averages here given.

Subjects.	Per cent. of total time course.
Languages and English.....	9.64
History and economics.....	2.53
Mathematics.....	11.91
Physics.....	7.20
Chemistry.....	5.81
Drawing.....	4.55
Shops.....	8.82
Mechanics.....	6.83
Metallurgy.....	1.01
Electrical engineering.....	3.97
Civil engineering.....	4.39

*Bulletin of the Society for the Promotion of Engineering Education, October, 1913.

Machine design.....	14.17
Strictly mechanical engineering subjects.....	16.05
Electives and special.....	3.12
Total.....	100.00

At the Pennsylvania State College, the combined percentage for language (including English), history and economics is eighteen, which represents more than the total for the combined mathematics and physics. It will be noted that this is higher than the corresponding percentage for the ten colleges mentioned. The student may not get enough English and economics, but it is certainly true that they do not get too much mathematics, physics and mechanics. The above percentages are not estimates; they are cold facts worthy of a critic's study.

It may be added that in the railroad mechanical engineering course of the above mentioned college, given in the last year and a half of the four in mechanical engineering, 11½ college credits out of 16 or 17 per cent. is strictly railroad work, part of the instruction being in the theory of locomotive operation, and locomotive, dynamometer-car and air brake tests. Only those expecting to go into railroad mechanical work take this course, and it is the underlying thought to make the instruction of a nature to bridge the gap between college and active railroad service but without over-specialization or at the expense of a single fundamental mechanical engineering subject. A few other colleges are doing as much or more.

But we must look deeper than what is being taught. As in most lines of engineering, so in railroad service, more men fail from lack of desirable personal characteristics than from a lack of technical knowledge. Back of any subject studied, is the personality of the teacher, and back of the lesson learned is the character of the student who is to assimilate the facts and apply them. How can the college do the most for the boy in four years, is a problem, and its obligations are equally exacting on the personal side as on the side of mental training.

Weighing in the balance of calm judgment the various considerations, one is led to believe that if the colleges will have on their teaching staffs men of directing force who are experienced in railroad mechanical work, and if the railroads will cooperate in a way to select and hold more men fitted for the service, then with these forces united to effect a closer working relation and sympathy between the two, there will result some notable changes in present day methods.

It may be in place to suggest a conference representing the joint interests, held possibly at one of the winter meetings of the railroad section of the American Society of Mechanical Engineers, where a discussion of conditions will open the way for a better understanding of the other man's problem.

ARTHUR J. WOOD,
Associate Professor Railroad Mechanical Engineering.

B—, Pa., October 28, 1913.

TO THE EDITOR:

My observation and experience with college men in railroad work has been that the majority of them when first leaving college and starting in real work, are not worth holding. There is no doubt but that the majority of college courses could be improved upon, and that they do not properly fit the man for railroad work. The majority of college men do not fully realize and appreciate what the word "Commencement," when applied to graduating exercises, really means.

A man spends four years at college intending to learn something. During these four years he gets the impression that he is going to learn everything, and generally graduates with the idea that he does know everything. The result is that it takes him about four years of hard work to find that he does not. A great many young men, while in college, have the idea that the world was made for them, and that while in college they are going to learn everything which they will possibly require when entering actual work. I believe the man who wrote the article appearing in the October issue of the *American En-*

gineer, and who signed his initials I. I. W. is one of these young men. For instance, towards the bottom of the first column on page 524, he states, "Any man who is a graduate Mechanical Engineer, if he is any good at all, can, with the right system, get all that is necessary out of the shops in two years." This to me is the height of egotism, as the shop is the basis of the mechanical department of a railroad. Any man who feels that he can work in a shop for two years and learn all that there is to be learned in regard to shop practice on railroads, should be bright enough to make a living without working.

In the second column on page 524, the writer speaks of the shop graduates being turned into the test department where they are given work far beneath their capabilities, such as odd drafting jobs, computing and tabulating road tests, etc. I have never seen a college graduate, either at the beginning or the end of his special apprentice course, properly tabulate a test, for the reason that he has not had the experience to teach him the various points to be brought out. I distinctly recall one special apprentice who intended to make a road test of a locomotive. He was of the usual type of college graduate and knew it all. The result was that he could not even start the test, because he would not be told how to do it, and it was necessary to take him off and put a regular apprentice from the shop on the job. The regular apprentice was willing to learn and willing to be told, with the result that today he is a thoroughly reliable and accurate man on this class of work. I call to mind another college graduate who started in the mechanical engineer's office as draftsman's apprentice. At the end of six months, he was discharged for the reason that he was not willing to be told.

If the college man expects and desires to make a success of railroad work, or any other work, he has got to start in at the bottom. You will find that when any man is given a position of responsibility, it is generally on account of his judgment, which comes only with years of hard work and actual contact with the subject in hand.

R. L. A.

CHICAGO, Ill., October 28, 1913.

TO THE EDITOR:

In connection with the discussion of the college-trained man and the railroads, it seems to me that the fault is with our educational system, and that we are beginning to realize it is evidenced by the advocacy of vocational education. We have an object lesson in the manner in which Germany and other countries are handling these questions. They assimilate the college man readily in the industrial life by making him fit in school for the particular vocation he elects to follow. When he reaches a certain degree of efficiency, his progress is more rapid and more certain than the man who has been deprived of such advantages.

There are comparatively few responsible official positions on the railroads. The competition for them is sharp, and great personal risk is necessary in some of the most desirable branches. There is also the necessity for social deprivation, great personal endurance, resourcefulness, and self-denial. Many who are ambitious have not all of these requisites, whether from the ranks or the college. More fail who are not college men than who are, as the proportions are greater.

When our railroads have progressed more in the refinements, when the rates will permit the same ratio of expenditure for maintenance and operation as are enjoyed in the older countries, there will then be less required of the individual official, and there will be more opportunities, with less responsibility at the foot of the ladder. The college man will then perhaps take a more lasting interest in the work. There will be greater opportunity for social enjoyment, as the first few years will in all probability be less arduous, subject him to fewer risks, and require less resourcefulness.

The railroads cannot change the existing conditions. It will come about in a natural evolution.

W. L. PARR,
Vice-President, Illinois Central.

TURNING DRIVING WHEEL TIRES

CLIFTON FORGE, Va., November 5, 1913.

TO THE EDITOR:

On page 336 of the June issue appeared a record for turning driving wheels made at the Richmond shops of the Chesapeake & Ohio on a new model driving wheel lathe furnished by the Niles-Bement-Pond Company. This reported a record of four 56-in. wheels turned in 2 hrs. 7 min. At the Clifton Forge Shops we have recently been able to considerably reduce this time on the same type of machine. In fact, the machine illustrated on page 336 is the one located at these shops and is the identical machine on which the following records were made. By careful attention to the details of every part of the work combined with the excellent facilities offered by the design of machine, we have been able to turn a set of four pairs of 56-in. driving wheels in 1 hr. 52 min., as is shown in the following table:

Pair No.	Time chucking. Min.	Time finishing. Min.	Time re-moving. Min.	Time floor to floor. Min.	Cutting speed. Ft. per min.	Diameter driving wheels.
1	3	20	5	28	15 to 17	56 in.
2	5	21	3	29	15 to 17	56 in.
3	4	24	3	31	15 to 17	56 in.
4	3	18	3	24	15 to 17	56 in.

Average time floor to floor, 28 minutes. Depth of cut, 5/16 in. Total time to turn complete set, 1 hour and 52 minutes.

On the same machine we have also been able to turn a set of six pairs of driving wheels from a Mallet engine in 2 hrs. 52½

Pair No.	Time chucking. Min.	Time finishing. Min.	Time re-moving. Min.	Time floor to floor. Min.	Cutting speed. Ft. per min.	Diameter driving wheels.
1	4.5	21	2	28.5	15 to 17	56 in.
2	7	22	2	31	15 to 17	56 in.
3	6	18	2.5	26.5	15 to 17	56 in.
4	3	21	4	28	15 to 17	56 in.
5	3	22	4	29	15 to 17	56 in.
6	4	23	2.5	29.5	15 to 17	56 in.

Average time floor to floor, 28.5 minutes. Depth of cut, ¼ in. Total time to turn complete set, 2 hours and 52.5 minutes.

min. These tires were extremely hard and we consider this record exceptionally good. The details of this record are also given herewith.

E. A. MURRAY,
Master Mechanic.

INNOVATIONS ON ARGENTINE PASSENGER CARS.—The Central Cordova is placing in service several new restaurant cars. An innovation is the introduction of pianolas in the cars so that the passengers may enjoy music while dining. Some of the private cars are also to be fitted with the same class of musical instruments.

MELTING POINT OF COMMERCIAL COPPER ALLOYS.—As very little information on the melting points of commercial brasses and bronzes can be found in either scientific or technical literature, tests of a few typical alloys were made by H. W. Gillett and A. B. Norton of the U. S. Bureau of Mines. The results, summarized, in Technical Paper No. 60, are as follows:

Alloy.	Approximate Composition.				Melting Point.	
	Copper.	Zinc.	Tin.	Lead.	Deg. Cent.	Deg. Fahr.
Gun metal	88	2	10	..	995	1825
Leaded gun metal.	85½	2	9½	3	980	1795
Red brass	85	5	5	5	970	1780
Low-grade red brass.	82	10	3	5	980	1795
Leaded bronze.	80	..	10	10	945	1735
Bronze with zinc.	85	5	10	..	980	1795
Half yellow-half red.	75	20	2	3	920	1690
Cast yellow brass.	67	31	..	2	895	1645
Naval brass	61½	37	1½	..	855	1570
Manganese bronze.	870	1600

The melting point given is the "liquidus," or point where the alloy is completely molten. The temperatures are thought to be accurate within plus or minus 10 deg. C., or plus or minus 20 deg. F.

HEAVIEST 2-8-0 TYPE LOCOMOTIVE

For Service Where 57 in. Drivers Allow the Desired Speed. Boiler Design Carefully Studied.

Twenty consolidation type locomotives recently delivered by the American Locomotive Company to the Wheeling & Lake Erie indicate that the possibilities of this wheel arrangement for moderate speed have by no means been exhausted. For service where speed no greater than can be obtained economically with 57 in. diameter drivers, these engines prove that it is not necessary to go to the Mikado type for tractive efforts between 50,000 lbs. and 60,000 lbs.

For an investigation of this design, a comparison can be made between the Wheeling & Lake Erie consolidations and the Mikado type built in 1912 for the Delaware, Lackawanna & Western.* The latter engine was designed on the same basis as the former and was built by the same builders. It also has what the builders call a 100 per cent. boiler.

Road	W. & L. E.	D. L. & W.
Type	2-8-0	2-8-2
Tractive effort, lbs.	55,900	57,100
Cylinders, in.	26 x 30	28 x 30
Driving wheels, diameter, in.	57	63
Boiler pressure, lbs.	185	180
Weight on drivers, lbs.	236,000	237,000
Total weight of engine, lbs.	266,500	312,500
Type of boiler	Wagon top	Strait top
Outside diameter of front end, in.	82	86½
Outside diameter of back end, in.	89	89½
Tubes, number and diameter	293—2	304—2

are capable of making and were built according to the builders' new standard boiler proportions.

These new proportions represent a radical change in boiler designing. All the variables, such as steam pressure, tube length, tube spacing, grate area, etc., are considered. It is expected that the new ratios will be given general publicity in the near future. A further investigation of the boiler shows that the consolidation has an even greater depth of throat, measuring the distance from the top of the grate to the bottom of the tubes than has the Mikado. This has been obtained by slightly raising the center of the boiler and taking full advantage of the reduced wheel diameter. This distance in the consolidation is 24¾ in. while in the Mikado it is 24 in. The center of the boiler of the consolidation is 124 in. above the rail against 120 for the Mikado.

Other interesting features in the design are a long main driving box, a Woodard engine truck, Fouldler design of main rod back end, screw reverse gear, and Vanadium cast steel main frames.

A fire brick arch was applied to one engine and the other engines are all arranged so that a stoker and arch tubes can be applied later if desired.

These engines have been put in service on the Toledo division



Powerful Consolidation Type Locomotive for the Wheeling & Lake Erie.

Flues, number and diameter	43—5½	43—5¾
Tube length, ft. and in.	15—6	21—0
Firebox, length, in.	114	108
Firebox, width, in.	84½	84½
Heating surface, tubes and flues, sq. ft.	3,293	4,593
Heating surface, firebox, sq. ft.	224	234
Heating surface, arch tubes, sq. ft.	27	27
Heating surface, total, sq. ft.	3,517	4,854
Superheating surface, sq. ft.	774	1,085
Grate area, sq. ft.	66.8	63.1

If 1,000 ft. piston speed per minute is selected as a basis for speed, the locomotive with 57 in. drivers will make 33 miles an hour and that with 63 in. drivers will make 37.5 miles an hour. As between these two engines it will be seen that in order to obtain 2.2 per cent. greater tractive effort at this increased speed, an increase in weight of over 21 per cent. has been necessary.

When an investigation of the boiler is made, it will be seen that the Mikado type has but 11 more 2 in. tubes than the consolidation and the 38 per cent. increased heating surface is made up principally by the tubes being 5 ft. 6 in. greater in length. As is well known, heating surface added on the front end of the tubes is not as valuable as would be indicated by this percentage increase and therefore the two boilers as steam producers are by no means in the same ratio as their heating surfaces. Both of these boilers were designed to furnish a constant supply of steam for any sustained speed the locomotive cylinders

between Brewster and Huron, Ohio, a distance of 72 miles. This division is composed of short broken grades. While all the engines are not yet in use, the difference of tonnage ratings between them and the consolidations which had previously been in use on this division, indicate that 20 of the new engines will supplant 27 of the former. The former engines have a tractive effort of 41,360 lbs. The new consolidations are handling 3,130 tons eastbound and 3,575 tons westbound at an average speed of 20 miles an hour. The old consolidations handled 2,310 tons eastbound and 2,645 tons westbound. The eastbound train loads have thus been increased 45.4 per cent. and westbound train loads 35.1 per cent.

General dimensions, weights and ratios are given in the following table:

<i>General Data.</i>	
Gage	4 ft. 8½ in.
Service	Freight
Fuel	Bit. coal
Tractive effort	55,900 lbs.
Weight in working order	266,500 lbs.
Weight on drivers	236,000 lbs.
Weight on leading truck	30,500 lbs.
Weight of engine and tender in working order	443,800 lbs.
Wheel base, driving	17 ft.
Wheel base, total	27 ft.
Wheel base, engine and tender	62 ft. 3 in.

*See *American Engineer*, September, 1912, page 459.

<i>Ratios.</i>	
Weight on drivers ÷ tractive effort.....	4.23
Total weight ÷ tractive effort.....	4.77
Tractive effort × diam. drivers ÷ equivalent heating surface*.....	680.00
Equivalent heating surface ÷ grate area.....	70.20
Firebox heating surface ÷ total heating surface, per cent.....	4.80
Weight on drivers ÷ equivalent heating surface*.....	50.30
Total weight ÷ equivalent heating surface*.....	57.00
Volume both cylinders, cu. ft.....	18.50
Equivalent heating surface ÷ vol. cylinders.....	253.00
Grate area ÷ vol. cylinders.....	3.60
<i>Cylinders.</i>	
Kind.....	Simple
Diameter and stroke.....	26 in. x 30 in.
<i>Valves.</i>	
Kind.....	Piston
Diameter.....	14 in.
Greatest travel.....	6½ in.
Outside lap.....	1 1/16 in.
Inside clearance.....	0 in.
Lead.....	18 in.
<i>Wheels.</i>	
Driving, diameter over tires.....	57 in.
Driving, thickness of tires.....	3½ in.
Driving journals, main, diameter and length.....	11 in. x 22 in.
Driving journals, others, diameter and length.....	10½ in. x 13 in.
Engine truck wheels, diameter.....	33 in.
Engine truck, journals.....	6½ in. x 12 in.
<i>Boiler.</i>	
Style.....	W. T.
Working pressure.....	185 lbs.
Outside diameter of first ring.....	83 9/16 in.
Firebox, length and width.....	114 in. x 84¾ in.
Firebox plates, thickness.....	¾ in. & ½ in.
Firebox, water space.....	5 in.
Tubes, number and outside diameter.....	293—2
Tubes, material and thickness.....	Steel, No. 11 B. W. G.
Flues—number and diameter.....	43—5½
Flues, material and thickness.....	Steel, No. 9 B. W. G.
Takes and flues, length.....	15 ft. 6 in.
Heating surface, tubes.....	3,293.4 sq. ft.
Heating surface, firebox.....	223.7 sq. ft.
Heating surface, total.....	3,517.1 sq. ft.
Superheater heating surface.....	77.4 sq. ft.
Grate area.....	66.75 sq. ft.
Smokestack, diameter.....	18 in.
Smokestack, height above rail.....	15 ft. 6 in.
<i>Tender.</i>	
Frame.....	13 in. & 10 in. channels
Wheels, diameter and material.....	33 in. rolled steel
Journals, diameter and length.....	6 in. x 11 in.
Water capacity.....	9,000 gals.
Coal capacity.....	15 tons

*Equivalent heating surface = 3,517 + (1.5 × 774) = 4,678 sq. ft.

FIRING UP LOCOMOTIVES

Any engine house foreman is familiar with the difficulties of firing up locomotives with wood; very frequently it is too wet to burn well and excessive quantities of oil have to be used in order to get the fire started, and there is also considerable expense attached to the unloading and piling of the wood at the engine house, as well as in putting it on the locomotive. The dust and splinters from the wood make both the engine house and the locomotives very untidy in appearance and placed as it usually is, either on the front end or in the gangway, it is very much in the way of machinists and boiler-makers who are working on the running repairs.

These difficulties have been largely overcome at the Norfolk & Western roundhouse at West Roanoke, Va., by the use of crude oil and shavings from the wood-working shop in the car department. Only sufficient oil is used to moisten the shavings and one bucketful is sufficient to light up one locomotive; a special bucket about 18 in. x 18 in. x 12 in. deep is used for this purpose. About 6 in. or 8 in. of coal is placed on the grate and the bucket of shavings is spread over this and lighted. The shop blower is then turned on and the locomotive has steam up ready to move out of the engine house in 30 minutes. It previously cost \$600 a day for men to prepare wood and place it on the locomotives, this expense now being entirely eliminated.

SIZE OF REDUCING VALVES.—A large percentage of the troubles experienced with steam pressure regulating or reducing valves can be traced directly to the use of valves too large for the service conditions they are required to meet.—*Power.*

OPERATION AND MAINTENANCE OF A LOCOMOTIVE DRIFTING DEVICE

BY P. SHEDDY

Compression was not a very serious factor on locomotives when slide valves were universal, but as higher steam pressures began to be used, objections to the slide valve began to multiply. But with the advent of the piston valve, especially in mountain territory, we were confronted with the problem of caring for compression in drifting. We found piston valve engines flattened driving wheels so badly in two or three months' service that it became necessary to turn them. With the Stevenson motion on slide valves, when drifting a distance of 20 to 60 miles, it was considered advisable, in order to save the heating, wear, and tear of valve motion as well as distribute the strain between the forward and back motion eccentrics, to drift at comparatively short cut-off. In this position slide valves relieved compression by raising from seat. Thus the steam chest became a receiver and the slide valve the counterpart of the drifting device.

The type of drifting device designed by me is arranged to connect the opposite ends of the cylinder when drifting and is intended to relieve the compression on the side of the advancing piston, forcing the air through the conduit, to counteract the vacuum that would be found on the opposite end of the cylinder. Tests have shown that this is accomplished, and when drifting at short cut-off (which is desirable) both the compression and

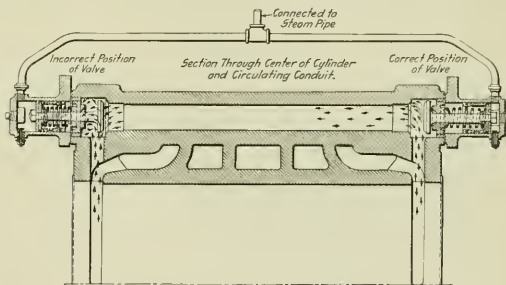

Section Through Drifting Valves and Passage Showing the Action for the Correct and Incorrect Positions.

vacuum are greatly reduced. This reduction can be carried to any desired degree by enlarging the conduit and valve openings, leaving only sufficient compression to serve as a cushion for the reciprocating parts.

By reference to the illustration showing drifting cards, an idea of the value of the drifting device can be obtained. The cards were taken at speeds of from 37 to 49 miles an hour with the lever in a 10-in. cut-off position. It will be noted that with the drifting device in operation as high as 86 per cent. of terminal compression is relieved.

I note in the specifications for new equipment some engines are equipped with a drifting device, others have vacuum valves, and some others have both. I am quite sure it will be found that, if the drifting device is properly designed, and in proportion to the size of the cylinder to which it is applied, the application of vacuum valve in addition to the drifting device would be superfluous.

In the first place, to put the vacuum valve in operation you must relieve the cylinder of air pressure. To do this the engine must be allowed to drift at full stroke. This is not desirable, as drifting should be possible and safe at any position the lever may be in when the steam is shut off. If the main valve is operated at any point short of full stroke, vacuum valves will pulsate and it will be found difficult to keep them in service. The momentum, and wear and tear of the valve motion, is increased at

the longer travels, but this is the only way the vacuum and compression can be relieved on piston valve engines by the use of vacuum valves. Furthermore, their use means the admission of cold air to the steam chest and cylinder. This condition, perhaps, may not be so objectionable on saturated steam engines, where the maximum heat of the steam chest is not over 350 deg., but on the superheated engines it appears to be bad practice. Admitting air through vacuum valves as a means of relief, even for a short period of time, will reduce the temperature of both cylinders and steam chest to a degree that will cause condensa-

tion. A number of tests in saturated steam engines, where temperatures were taken at from 300 to 350 degrees, showed a drop in temperature of 100 degrees or more when using relief valve, and a maximum drop of 39.5 deg. when using drifting valves. This result would be greatly magnified if taken on a superheated engine, especially in cold weather.

In connection with maintenance, I find the principal complaint has been on account of maintainers restricting the opening through the valves. There is no danger of getting too much opening, but great danger of too little. An illustration of this is seen in the accompanying drawing, which shows at the left how air gets behind the valves and, with the spring, causes a pulsating movement at every stroke of the piston, when there should be but one movement of the drifting valves to open when the throttle is closed and another movement to close when throttle is opened. The correct position is given at the right of the illustration on page 643.

Broken valves and worn seats are entirely due to a mistaken idea that it is the slam of the valve in closing that does this and the drifting valve travel is frequently shortened to cure this supposed trouble. This actually increases the trouble by making it a pulsating valve.

When engines are received from the builders, the drifting valve should be looked over to see that the parts and conduits are free from fins and of the intended size. It should not be less than 2 per cent. of the area of cylinder at any point.

It has been found advantageous to apply a 1/4-in. pet cock in the center of the conduit between the valves and make it a permanent fixture. This, when used, will show whether valves are tight when working steam and a leak of this pet cock would indicate that the valves were not seating properly.

We find in new engines that occasionally the cages which carry the drifting valves are sometimes out of line with the valve seat, and if in line, the bevel of seat is sometimes out of true with the face to which the cage is attached. When irregularities of this kind occur, it is a good idea to have a false plate fitted securely over the studs and cage. A reamer can then be used to make the seat true. When the cages and valves are applied, they should be tried by air pressure in the cage, using a two-way valve for the operation. This will admit of forcing the valve to its seat. The use of the two-way valve will allow this to be done as often as may be necessary. The cage should then be removed to see that the valve is properly seated. This method is used instead of grinding when there are indications of a leak, and in addition to seating the valve, will show that it is in line.

A VALUABLE INVENTION.—DOCTOR McWilliams, of this city, has taken out a patent for a stove for heating carriages of all kinds, which is one of the most valuable inventions which has ever been made. It is remarkable in its structure and may be sold for \$6 or \$8; and it consumes the most inconsiderable quantity of coal. This stove is now used in the cars of the Baltimore & Washington Railroad and gives entire satisfaction. The passengers are kept warm during the cold journey and are never annoyed by smoke, the stove being air tight.—*Extract from the Washington Mirror in the American Railroad Journal, January 30, 1836.*

RAILROADS IN WINTER.—It has been often urged as an objection against railroads that they cannot be kept open in winter in consequence of the obstructions occasioned by great falls of snow. As if to furnish a satisfactory experiment on this point, it has so happened that the present winter has been of unusual severity and the quantity of snow which has fallen has probably been greater than has been known for many years. It is therefore, with great pleasure that we understand that scarcely any interruptions in the travel upon the railroads leading from this city have taken place and that the practicability of keeping them open during the severest winter has been satisfactorily established.—*From the American Railroad Journal, February 20, 1836.*

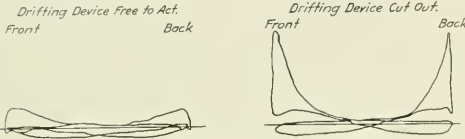

10	Cut off position of Reverse Lever	10
41	Speed Miles Per Hour	41
5.77	Mean Back Pressure on Piston Lbs. Sq. In.	72 Lbs.
100 H.P.	Total Back Power of Pistons in H.P.	126 H.P.
Percent Power Relieved by Action of Drifting Device.		
21%	Terminal Compression above Atmos. Lbs.	60 Lbs.
10 Lbs.	Percent of Terminal Compression Relieved by Action of Drifting Device.	80%



10	Cut Off Position of Reverse Lever	10
47	Speed Miles Per Hour	49
6.37	Mean Back Pressure on Piston Lbs. Sq. In.	10 Lbs.
130 H.P.	Total Back Power of Piston in H.P.	210 H.P.
Percent Power Relieved by Action of Drifting Device.		
38%	Terminal Compression above Atmos. Lbs.	60 Lbs.
11 Lbs.	Percent of Terminal Compression Relieved by Action of Drifting Device.	81%



10	Cut Off Position of Reverse Lever	10
38	Speed Miles Per Hour	37
48 Lbs.	Mean Back Pressure on Piston Lbs. Sq. In.	648 Lbs.
78 H.P.	Total Back Power of Pistons in H.P.	104 H.P.
Percent Power Relieved by Action of Drifting Device.		
25%	Terminal Compression above Atmos. Lbs.	47 Lbs.
6 1/2 Lbs.	Percent of Terminal Compression Relieved by Action of Drifting Device.	86%

Indicator Cards Showing Pressures With and Without a Drifting Device.

tion, with its expense and other evil effects, when the throttle is again opened.

I find that there is an erroneous idea in regard to the higher temperature maintained when using the drifting device instead of the vacuum valve, attributing it to more front end gases drawn into the steam chest with the drifting device than with the relief valve. This conclusion is a mistake. The drifting valves simply allow a free passage of air in the cylinder to pass back and forth, maintaining the temperature by the elimination of

MECHANICAL DEPARTMENT ORGANIZATION OF THE ERIE

BY R. S. MOUNCE

During the past year many changes have been made in the mechanical department organization of the Erie Railroad, and

There are two grand divisions of the locomotive department, each in charge of a mechanical superintendent, and the organization of the Erie Grand division, which is representative, is given. The car department is in charge of a mechanical superintendent. The following officers report directly to the general mechanical superintendent: Three mechanical superintendents; superintendent of locomotive operation; superintendent of piece

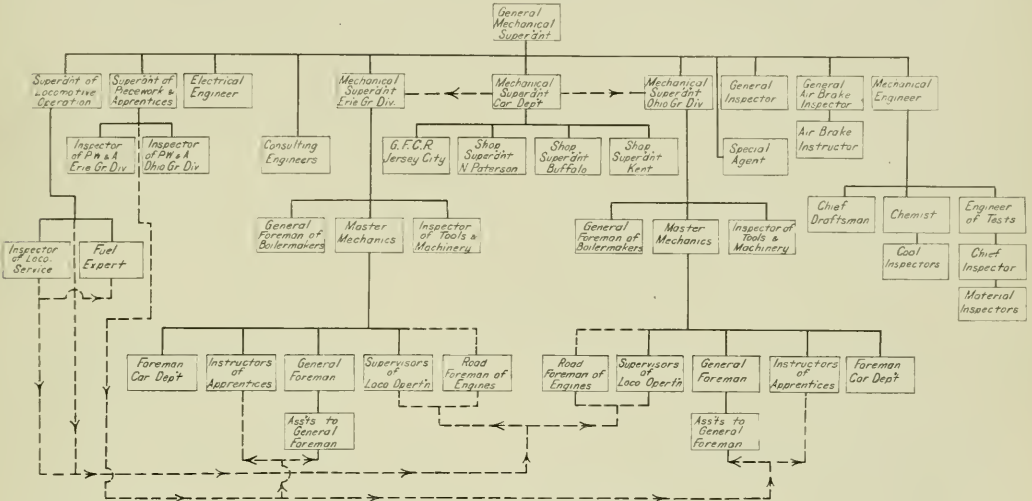

Note.—Dotted lines indicate divided jurisdiction.
Organization of the Mechanical Department of the Erie.

most of them have been in effect long enough to clearly indicate that they were wisely made. The accompanying diagrams show the present organization, the entire mechanical department having the general mechanical superintendent at its head.

work and apprentices; mechanical engineer; electrical engineer; general air brake inspector; general inspector; consulting engineers, and special agent. The two grand divisions of the locomotive department are

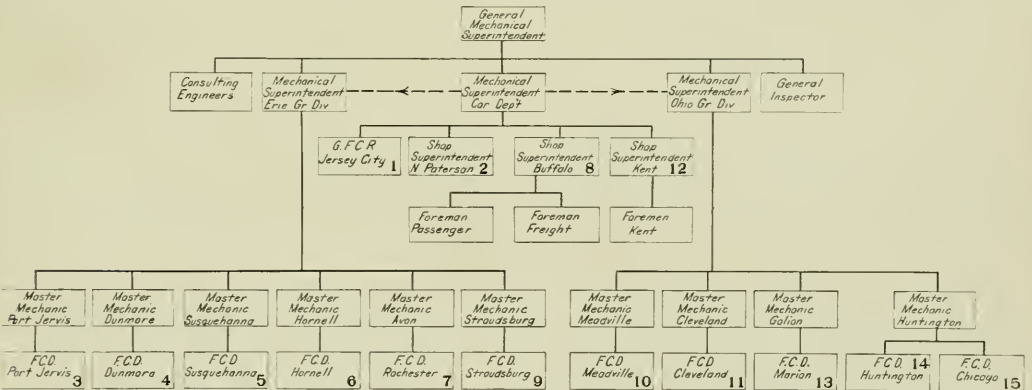

ASSISTANT FOREMEN CAR DEPARTMENT.
(Over 5 men.)

LEADING MEN.
(Over 5 men or less.)

- 1—Has jurisdiction over Penhorn, Weehawken, Paterson, Great Notch.
- 2—Has jurisdiction over Coalburg, Edgewater, Little Ferry.
- 3—Has jurisdiction over Lackawaxen, Deposit, Middletown, Greycourt, Campbell Hall, Newburg.
- 4—Has jurisdiction over Avoca, Jessup, Hawley, Honesdale.
- 5—Has jurisdiction over Carbondale, Forest City, Binghamton, Owego, Waverly, Elmira, Blossburg, Corning, Addison.
- 6—Has jurisdiction over Wellsville, Olean, Salamanca, Bradford, Johnsonburg, Brockwayville.
- 7—Has jurisdiction over Avon, Bath and Hammondsport.

- 8—Has jurisdiction over East Buffalo, Erie Dock, Susp. Bridge, N. Tonawanda, Black Rock, Attica, Dayton, Silver Springs.
- 9—Has jurisdiction over Beaver Lake, Moosie, Pocomo St.
- 10—Has jurisdiction over Jamestown, Shenango, Oil City, Corry.
- 11—Has jurisdiction over Randall, Phalanx, Brier Hill, Ferrona, Niles, Lisbon, New Castle.
- 12—Has jurisdiction over Akron, Creston, Sterling.
- 13—Has jurisdiction over Dayton, Mansfield, Maitland, Urbana, Durbin.
- 14—Has jurisdiction over Lima, Ohio City, Decatur, Kingsland, Bolivar, Rochester, De Long, N. Judson, Griffith, Kenton.
- 15—Has jurisdiction over Hammond.

Note.—Dotted lines indicate divided jurisdiction.

Organization of the Car Department.

the Erie, or eastern section, and the Ohio, or western section, each in charge of a mechanical superintendent, the first with headquarters at Jersey City, N. J., and the second at Cleveland, Ohio. Reporting to each mechanical superintendent are a general foreman of boilermakers, an inspector of tools and machinery, and the several division master mechanics. The first of these staff officers has jurisdiction over all matters pertaining to boiler work, and the second has to see that all tools are maintained according to the road's standards and also has charge of the installation of machine tools, boilers and other such details.

The mechanical superintendent in charge of the car department, whose headquarters are at Meadville, Pa., has complete and direct jurisdiction over the three shops where all the heavy car repairs are made, namely, North Paterson (passenger car repairs), Kent and Buffalo (freight and passenger car repairs), each of which is in charge of a shop superintendent; also over the general foreman of car repairs at Jersey City, who has charge of all the terminal passenger car work and that at the outlying points in the commuter territory, as well as the freight

operating department, report to the master mechanics on matters relating to the maintenance of locomotives. The fuel expert reports to the inspector of locomotive service as well as to the superintendent of locomotive operation. The coal inspectors are under the jurisdiction of the chemist, who reports to the superintendent of locomotive operation on fuel matters. This constitutes the fuel economy organization and it closely connects the mechanical and operating departments, thereby insuring the best results through proper co-operation.

The superintendent of piece work and apprentices has indirect jurisdiction over the assistants to the general foremen and the instructors of apprentices, who are on the master mechanics' staffs. The assistants to the general foremen look after the piece work at the several shops, and the instructors of apprentices are in charge of the technical and practical instruction of apprentices at the shops where apprentice schools have been established.

The mechanical engineer is located at Meadville. His staff includes the chief draftsman, chemist, engineer of tests and all material and coal inspectors. The electrical engineer looks

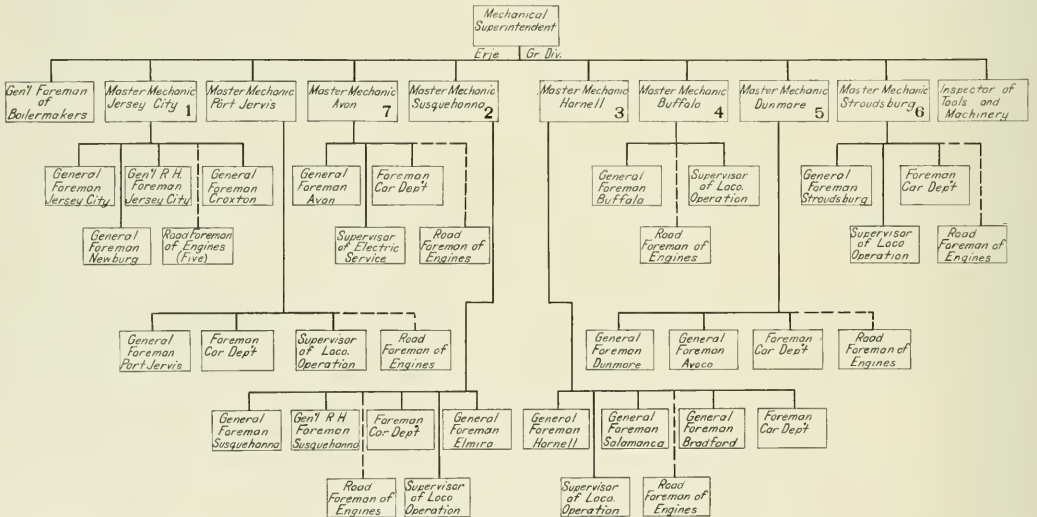

1—Has jurisdiction over Waldwick, Suffern, Paterson, Nyack, Campbell Hall, Weehawken, Midvale, West Orange, Caldwell, Little Falls, Harriman, Goshen, Pine Bush, Newark, 28th St., Sterling Forest, Grey-court, N. J. & N. Y.
 2—Has jurisdiction over Blossburg, Binghamton, Corning, Waverly.
 3—Has jurisdiction over Dunkirk, Olean, Brockwayville, Johnsburg.

4—Has jurisdiction over Attica, Castile, Tonawanda, Susp. Bridge, Gowanda, Dayton, Black Rock.
 5—Has jurisdiction over Hawley, Lackawanna.
 6—Has jurisdiction over Yatesville, Lodi, Passaic, Wortendyke, Butler, Beaver Lake, Middletown, Blairstown, Moosic, Edgewater, N. Paterson.
 7—Has jurisdiction over Rochester, Bath and Hammondsport.

Note:—Dotted lines indicate divided jurisdiction.

Organization of the Locomotive Department on the Erie Grand Division.

car work in this territory. The head of the department has charge of the minor car repair points through the heads of the locomotive department, or in other words, the foremen of the car department report directly to the master mechanics, and all instructions issued by the car department head are transmitted to them through the mechanical superintendents in charge of the locomotive department. This divided jurisdiction is shown by the dotted lines on the diagrams.

The superintendent of locomotive operation has direct jurisdiction over the inspector of locomotive service and the fuel expert, and the former have indirect jurisdiction over the supervisors of locomotive operation and the road foremen of engines. The supervisors of locomotive operation report directly to the master mechanics and their duties are principally along the lines of fuel economy, lubrication, tools and other supplies; the road foremen of engines, who are essentially in

after all electrical matters, including shop power installation and the electric lighting of passenger cars. The duties of the general air brake inspector are fully explained by his title. The general inspector has charge of all car department inspection and it is among his duties to see that all inspectors of new equipment are conversant with the standards and details called for by the specifications. The consulting engineers are car experts. The special agent is in charge of the details in connection with making improvements to insure safe working conditions at the several locomotive and car shops. He also keeps in touch with legislation concerning mechanical department matters in order to make sure that the requirements are strictly adhered to.

Since this reorganization has been in effect, marked improvements in the efficiency of the department as a whole have been manifest, fully warranting the many changes that were made.

FORMULA FOR SADDLE PIN OFFSET

All who have had anything to do with the designing and setting of the Stephenson link motion are familiar with the extreme sensitiveness of the valve events to any change in any of the parts composing the gear, from the connecting rod to the location of the lifting shaft. A change in the length or point of suspension of any element will have its effect on the motion of the valve, and this effect, being usually a bad one, calls for a modification of some or all of the other parts. To work this out on the drawing board is a slow process, and the usual method of securing a fair equalization of cut-off is to lay out the valve gear on the drawing board to general proportions and arrangement best suited to the design of the engine and then correct inequalities by erecting it on the locomotive and securing the equalization of the cut-off and the valve events by using an adjustable link saddle, whereby the offset of the saddle pin can be set in that position to secure the best movement of the valve.

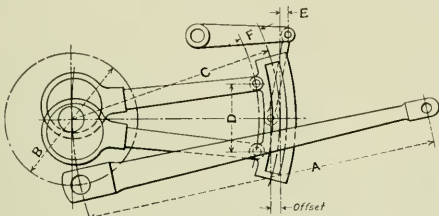

Diagram of Stephenson Valve Gear with Open Rods.

The regular saddle is then made, with the pin offset to correspond to that obtained, and is applied to the link. In short, the errors of design are corrected by the offset of the saddle pin.

As there was no formula by which this offset could be calculated for any given arrangement and proportion of the parts, O. W. Young, in charge of the valve designing for the American Locomotive Company, undertook to solve the problem and obtain, if possible, a formula by which the saddle pin offset could be calculated.

For this purpose he used the valve gear model at Schenectady, and set up, as a base gear, one having the following dimensions, as shown in the accompanying illustration:

Length of connecting rod = (A).....	96 in.
Stroke of piston = diameter of crank = (B)....	24 "
Radius of link = (C).....	48 "
Distance between points of attachment of eccentric rods to link = (D).....	12 "
Distance from point of support of link hanger to center of link = (E).....	1/2 "

This provided for all of the dimensions shown except F, the distance of the points of attachment of the eccentric rods from the center line of the link, the saddle pin offset, and the throw of the eccentric. With these general dimensions of the gear, he proceeded to find the saddle pin offset for different dimensions of F, varying by 1/4 in. increments from 1 3/4 in. to 4 in. with open and crossed eccentric rods, and with eccentric throws of 5 in. and 6 in. The results of these trials are given in the accompanying diagram:

For example, suppose we have a gear like that used for the base, where open eccentric rods are used, the throw of the eccentric is 5 in. and F equals 3 in. Then the vertical line at which the diagonal for open rods, for the 5-in. eccentric throw crosses the horizontal line from F equals 3 will indicate the saddle pin offset, which, in this case, is 5 5/8 in. Then 5 5/8 in. becomes the base figure for all gears having an eccentric throw of 5 in. and a distance F equal to 3 in. The formula is purely empirical, and is based on experimental observations extending through many

months in which all possible combinations of dimensions were used. The result of these observations was the development of the following rules:

FOR OPEN RODS.

For each 12 in. added to the dimension A, 1/16 in. should be added to the offset.

For each 2 in. added to dimension B, 1/32 in. is to be subtracted from the offset.

For each 12 in. added to dimension C, 1/16 in. is to be subtracted from the offset.

For each 1 in. added to dimensions D, 1/4 in. is to be subtracted from the offset.

When E = O, add 1/16 in. to the offset.

FOR CROSSED RODS.

For each 12 in. added to dimension A, 1/8 in. is to be added to the offset.

For each 2 in. added to dimension B, 1/16 in. is to be subtracted from the offset.

For each 12 in. added to dimension C, 1/8 in. is to be subtracted from the offset.

For each 1 in. added to dimension D, 1/4 in. is to be subtracted from the offset.

When E = O, add 1/8 in. to the offset.

The application of these rules can be best shown by a specific

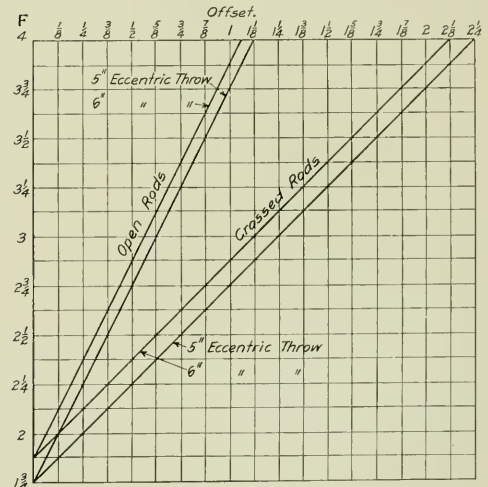

Curves for Determining the Base from Which the Proper Saddle Pin Offset Can Be obtained.

example. Suppose, then, a valve gear has been designed, in which

- A = Length of connecting rod = 108 in.
 - B = Crank diameter = 26 in.
 - C = Radius of link = 60 in.
 - D = Eccentric rod pin spacing = 13 in.
 - E = Distance of link hanger pin from center of link = 0 in.
- The eccentric rods are open and the eccentric throw is 5 in. Then, as before, the base figure is 5 5/8 in.
- For A, we have 108 - 96 = 12 in.; giving 1/16 in. to add.
 - For B, 26 - 24 = 2 in.; giving 1/32 in. to subtract.
 - For C, 60 - 48 = 12 in.; giving 1/16 in. to subtract.
 - For D, 13 - 12 = 1 in.; giving 1/4 in. to subtract.
 - For E = O, we have 1/16 in. to add.
- The solution then becomes:
 5 5/8 + 1/16 - 1/32 - 1/16 - 1/4 + 1/16 = 13/32 in.
 The proper offset for the saddle pin is, therefore, 13/32 in.
 For open eccentric rods if the offset is too much, the cut-off

will occur later at the front end of the cylinder rather than at the back; while, for crossed rods, too great an offset will give a greater cut-off at the back than at the front.

It is not claimed for these rules that the results will be the best attainable, but that they can be implicitly followed in a design and the engine will be square and perfectly satisfactory in its operation. It has been used repeatedly on what might be called freak gears, where, to the casual observer, the offset would appear normal, and the result has been satisfactory. Its promulgation is certainly of great value, and it will be found to be especially useful where engines are out of square and need a readjustment of their valve events.

SERVICE OF VANADIUM STEEL LOCOMOTIVE PARTS

Extended service tests of heat treated chrome-vanadium steel parts on large locomotives are showing this material to have decided advantages, both as regards strength and wearing quality. In addition to springs, frames, axles and piston rods, main rods and tires of this material are shown by recent reports to possess distinct and practical advantages.

In regard to main and side rods, the experience of several of the lines of the New York Central System is interesting. On the Michigan Central a comparison between the percentage of failures of vanadium rods on consolidation and Pacific type locomotives, built since 1910 and the failures of carbon steel rods on the same classes of engines built since 1906, taking into consideration in the latter case only those failures which occurred within a period of three years service or less, shows that the chrome-vanadium steel reduced the failures by over 80 per cent. The comparison includes 90 locomotives equipped with vanadium rods and 84 equipped with carbon steel rods. Of the former there have been but three failures or 6-tenths of 1 per cent. of the total. All of these were side rods. The failure of carbon steel rods in the same length of time amounted to 3½ per cent. and in the case of one lot of locomotives built in 1907, the failure of carbon rods in three years amounted to 10 per cent. Very similar results have also been given on the Lake Shore & Michigan Southern, the Lake Erie & Western, the Chicago, Indiana & Southern and the New York Central & Hudson River. Summarizing the records of all five of these roads it is found that out of a total of 757 road engines equipped with vanadium steel rods since 1910, the total number of rod failures to date amounted to only ¾ of 1 per cent. Most of these occurred on the earlier applications and appeared to be largely due to the fact that the locomotive builders at that time did not possess the heat treating equipment that they now use. The later rods were subjected to a double heat treatment with very noticeable improvement.

Last fall about 40 of the railroads of the country ordered heat treated, chrome-vanadium steel tires with a view to testing the wearing qualities as compared with ordinary carbon steel tires. These tires were made to the latest approved specifications based on data secured from extensive experiments and research carried on jointly by the tire makers and the American Vanadium Company. Contours of all the tires installed are being periodically taken by the American Vanadium Company's inspectors and careful record is kept of their performance.

Among the first tires to be applied there were some on locomotives running on the Chicago Junction Railway. Owing to the exceptionally short curves in the stock yards in Chicago, there are few roads in the country where switching conditions are harder on the tires than on this one. While none of these tires have been in service long enough to show ultimate results, progress service reports of those first applied present some interesting comparisons. An example is a six wheel switching locomotive to which the heat treated chrome-vanadium tires were applied on December 3, 1912. This engine has a total weight in working order of 142,500 lbs. It has 20 in. x 26 in.

cylinders and 51 in. diameter wheels. A new set of carbon steel tires were applied at practically the same time to a sister engine working in identical service.

Contours taken of the tires with a tire contour machine in October, after 10 months service showed a maximum tread wear of 7/32 in. with a minimum of 3/16 in. on the chrome-vanadium tires. The flanges were in excellent condition. The carbon steel tires were applied on December 27, 1912 and on September 10, after about 10 months service they had to be turned. At that time they showed a maximum tread wear of ½-in. and had made 34,570 constructive miles, figured on the railway company's basis. The vanadium tires had made 32,750 miles. This gives 9,360 miles for 1/16 in. of tread wear on the vanadium tires and 4,320 miles per 1/16 in. wear with carbon tires. The carbon tires had to be turned to 50⅝ in. diameter which represented a ⅝ in. loss in thickness of metal from wear and turning and gives only 3,475 miles for 1/16 in. total loss in thickness after the first turning.

The vanadium tires were made at the Latrobe Works of the Railway Steel Spring Company to the chemical and physical specifications prepared by the American Vanadium Company. They were subjected to a very careful heat treatment.

STANDARD GAGE TRACKS THROUGH SHOP BUILDINGS

BY PAUL R. DUFFEY

In building new shops or additions to old ones it is a great mistake to make no provision for a standard gage track from end to end of the center section. Such a track will permit the yard crane or wrecking crane to enter and unload any heavy machinery, as well as to place it on the foundations. Many large machine and smith shops are without this feature and when such machines as large steam hammers, bolt headers, punches and shears, wheel lathes, planers, etc., have to be installed and assembled by hand much money and labor is expended which might have been avoided by a little more foresight.

Not long ago a very large steam hammer was to be installed in a fair sized smith shop, and the nearest track available for unloading the parts of the hammer was so close to the machine shop that a crane could not turn more than two feet without striking the shop wall. It was therefore necessary to unload the parts about 120 feet from the foundation in the smith shop, which necessitated skidding and rolling the various parts, some weighing over ten tons, over the entire distance. Such work requires considerable time as well as skill in manipulating the parts to keep them from upsetting. The time consumed in setting up this machine with one machinist and from three to seven helpers was about twelve days, whereas if there had been a track through the shop the crane could have handled the work in about two days, with an estimated saving of at least \$60. Such cases arise at some time almost everywhere and if such a track were installed, even if only used a few times a year, it would be a paying investment.

CHARLESTON & CINCINNATI RAILROAD.—We are highly gratified to learn that the Legislature of Kentucky has adopted an enlarged and liberal policy in relation to the Charleston & Cincinnati Railroad. Let the people build railroads where they will and if necessary aid them in all great national works.—*From the American Railroad Journal, February 13, 1836.*

MONOPOLY IN 1836.—Our New Jersey friends, notwithstanding their dread of monopoly, and in particular, of the Camden & Amboy Railroad and Delaware and Raritan Canal, have determined by their representatives in State Legislature assembled, not to abate the nuisance; in other words, the "proposition" of the united companies to sell out to the state has been rejected. *From the American Railroad Journal, February 20, 1836.*

CAR DEPARTMENT

FREIGHT CARS DAMAGED BY IMPROPER LOADING

A statement regarding the damage caused to the doors, etc. of freight equipment by the cars being improperly loaded has been issued by the Niagara Frontier Car Inspection Association. This statement covers several thousand cars and includes photographs and statements in detail as to the condition in which a large number of them were found. It is signed by J. C. Fritts, master car builder, Delaware, Lackawanna & Western; T. J. O'Donnell, arbitrator, Niagara Frontier Inspection Association, and W. H. Sitterly (chairman), general car inspector, Pennsylvania Railroad, and is as follows:

"We feel that the manner in which loads are placed in box cars

adjusted indicates that 70 per cent. of the total number was on account of lading being against the side doors, which in many cases were pushed completely off of their fastenings, resulting in more or less damage. It is believed that the question of bad loading has more to do with defective side doors than any other one item. It was, therefore, resolved at this meeting that the attention of the General Managers' Association be called to this condition through the heads of our various mechanical departments with a view of obtaining concerted action on all roads throughout the country, not only in educating the shippers, but the agents as well.

"In addition to the large expense incurred and the delay to freight, the most important feature of the defective door is the liability of serious accident due to doors and lading falling on



A Shipment of Fulwood Shifted at the Doorway for Lack of Proper Protection.



The Effect of a Lack of Doorway Protection on a Shipment of Feed in Bags.

at the loading points is responsible in a large measure for the condition of the box car doors and fastenings. No regard or respect is given the Master Car Builders' Association Loading Rules, and we believe that the situation should be canvassed thoroughly and that the superintendent or the agent having jurisdiction where closed cars are loaded should instruct the shipper in the proper method of loading and use his best efforts without antagonizing the shipper to induce him to place the proper means of securing the load in the car to prevent its coming in contact with the side doors. This will result in cutting down the large expense incurred, reduce the number of cars now being placed on shop tracks for repairs, and insure the lading reaching its destination at an earlier date than it now does, with consequent satisfaction to the shipper.

"A careful check of several thousand cars set out to have loads

adjacent tracks, and it is felt that all of the annoyance and trouble complained of could be reduced to a minimum, provided the necessary attention is given at the initial point of loading. It should be understood that the mechanical department will take the necessary steps to place the doors and fastenings in good condition, co-operating with the traffic department to bring about the desired results in this respect.

"We further feel that it would be well to have a representative from the mechanical department meet with the superintendent and the agents at the agents' meetings to take up the proper interpretation of the loading rules and to educate the agents as to what is necessary in the line of protecting the different kinds of commodities loaded in closed cars. Agents should have impressed upon them the importance of this as well as the serious conditions that exist in many instances on account of

the non-compliance with the Master Car Builders' rules.

"In the Niagara Frontier Inspection district, comprising thirteen roads, the monthly average number of cars that require switching from the yard to the transfer tracks and repair tracks to have the lading adjusted because of negligence in providing proper



Door Burst Open by the Shifting of a Shipment of Barrels.

blocking is 8,000. This not only delays the freight but is an extra expense both in switching and adjusting the loads, as well as in maintenance. The condition seems to be becoming worse rather than better."

DEVELOPMENT OF STEEL PASSENGER EQUIPMENT

While the extensive use of metal for passenger train car construction was considered as early as 1854, it was not until about 40 years later that it began to receive serious consideration. According to a committee on Steel Passenger Cars, which reported at the 1908 meeting of the Master Car Builders' Association, the most important reasons which brought the desirability of introducing steel passenger cars prominently before the railways were:

- (1) The burning of wooden cars in wrecks, and the frequent destruction of human life by fire.
- (2) The splintering of the large wooden sills, etc., when the cars were wrecked, causing injury and death.
- (3) The scarcity of lumber suitable for sills, stringers, etc., and the threatened exhaustion of such material.
- (4) In collision with steel freight cars, which were being introduced in great numbers, the passenger equipment was more liable to destruction than was the case with the wooden freight cars.

(5) Increased speeds, greater train lengths, and larger capacity cars.

Then too, the rapidly increasing use of electric motor cars in subway and elevated service, where the passengers cannot easily leave the cars in case of accident, and the danger from fire where electric power is used, suggested the use of non-inflammable materials in the construction of these cars. This was undoubtedly largely responsible for the development of the all-steel passenger train car.

The movement received its great impetus in the East because of the electrification of the steam roads entering New York City and the possible dangers if wooden equipment were to be used in connection with the use of electric power in the long tunnels. In the West, on the Harriman Lines, steel cars were introduced because of the belief that they would not only prove safer but also that they would be more economical to maintain than wooden equipment.

The publicity departments of the roads which first started to introduce the steel equipment were not slow to realize the advertising value of having all-steel cars on their limited trains and this undoubtedly had some considerable influence in inducing the other roads, particularly those in competitive territory, to adopt such equipment for their better class trains.

The steel frame, side door suburban cars used by the Illinois Central to handle the World's Fair traffic in 1893 are generally regarded as the forerunners of the all-steel passenger car in this country. In the same year the Pressed Steel Car Company built 35 steel underframe cars for the Northwestern Elevated of Chicago. Then followed a steel frame car for the Interborough Rapid Transit Company of New York, a steel car on the Second Avenue Elevated Line in 1904, and the building of 300 all-steel cars for the New York subway in the same year. A steel baggage car was put in service on the Erie in 1904. In the winter of 1904-5 the Long Island introduced 134 steel suburban cars in its electric service, and the Erie added a steel postal car and a steel express car to its equipment. In 1906 the New York Central put in service 125 steel motor cars (these were the first cars built of steel along the lines of a modern steel coach), the New Haven two steel postal cars, the Long Island an all-steel passenger coach, while both the Pennsylvania and the Southern Pacific built experimental all-steel passenger coaches for through traffic. The Pennsylvania also introduced a steel baggage car late in the year.

The year 1907 marked the introduction of a steel postal car on the Southern Pacific, the building of a steel Pullman car, 40 steel passenger cars for the Hudson & Manhattan, a steel postal car and a passenger coach on the Union Pacific, five steel postal cars and a steel passenger car on the Pennsylvania, and 50 more all-steel cars for the Interborough.

The M. C. B. report at the 1908 convention showed that there were about 380 all-steel cars in service or under construction for steam roads at that time, and commented on the fact that the greatest development was shown in the East because of the desirability of having fireproof cars for use on the electrified portions of the roads entering New York City, with their long tunnels. By January 1, 1909, there were 629 all-steel and 673 steel underframe cars in service in this country, and on January 1, 1913, there were 7,271 all-steel cars and 3,296 steel underframe cars.—*Railway Age Gazette*.

LARGEST MARINE TURBINES.—A start has been made at Clydebank with the work of putting the turbines on board the new Cunard line steamer *Aquitania*. The total weight of these turbines is 1,400 tons. To enable them to be lowered into the hull of the ship one of the four funnels was not placed in position. The low pressure turbines are the largest ever constructed, each weighing about 425 tons. There are over a million turbine blades, which, if placed end to end, would reach over 140 miles.—*The Engineer*.

STEEL FRAMING FOR BOX CARS*

Development and Service of This Type; Necessity of Well Selected Lumber for Sheathing.

BY R. W. BURNETT,

General Master Car Builder, Canadian Pacific, Montreal, Que.

This paper deals with the superstructure details of the steel frame box car and the information and data presented are based on the writer's experience on the Canadian Pacific system with the design, construction and maintenance of 30,000 cars of this type, which represent an investment of \$30,000,000.

Credit is due to C. A. Seley, formerly mechanical engineer of the Rock Island Lines, for designing the first outside sheathed steel superstructure box cars that were constructed in large numbers. The introduction of steel into the superstructure of the box car, and the development of the outside sheathed steel superstructure in particular, were discussed so thoroughly by Mr. Seley in his comprehensive paper before the Franklin Institute in January, 1910, that I have thought it unnecessary to go over this same ground, but will review only briefly the de-

velopment of the box car from the all-wood car through the intermediate stages of steel underframe cars.

being carried on a rigid frame and not held together by the strains resulting from its weight, as in the old trussed cars, has a tendency to develop slack in the superstructure. This in turn affects the roof and sheathing. One principal trouble with outside sheathed cars is, that, after they have been in service a comparatively short time, the sheathing frequently loosens at the end sill and at the side sills near the bolsters with resultant leakage of grain.

There were some steel frame box cars built previous to 1909, but the writer has been able to secure data on only the outside sheathed types. Of these 2,700 were in service on the Norfolk & Western, of which the first 100 were built in 1902; the owners state that they were satisfactory and the same type has been purchased on subsequent orders. The Rock Island and Frisco



Canadian Pacific Steel Frame Box Car with Corrugated Metal Sheathing.

velopment of the box car from the all-wood car through the intermediate stages of steel underframe cars.

The original wooden car, with the single spring draft rigging having the cheek castings bolted to the sills, gave little if any more trouble than modern equipment, due principally to the shorter trains, less density of traffic and to the use of link and pin couplers which compelled gentler handling of trains than is prevalent today. The steel underframe car was built mainly to secure a stronger center construction for the attachment of draft rigging and to get away from the trouble caused by wooden sills breaking and splitting, broken draft bolts, etc.

While having many advantages over the old wooden car, the steel underframe car developed some troubles peculiar to itself, the most important being due to the fact that the body

lines had in service at that date approximately 5,000 cars similar to the Norfolk & Western, and these also appear to have given satisfaction as the owners have reordered the same type several times. All of these, however, were outside sheathed and as regards leakage at the sills, had comparatively little advantage over the wooden cars. Recently both of these lines have purchased some inside sheathed cars. The Frisco car of this type is fully described in the *Railway Age Gazette*, October 3, 1913, and in the *Railway Age Gazette, Mechanical Edition*, October, 1913, p. 555.

In 1908 the Canadian Pacific designed its first steel frame inside sheathed box car. This car avoided the disadvantage of the outside sheathed car, something which had not been accomplished by the steel frame cars constructed up to that time, and at once obtained a further reduction in weight and provided for cheapness of maintenance by the use of steel superstructure,

*A paper read before the American Society of Mechanical Engineers at the annual meeting, December 3, 1913.

without the additional lumber required by the outside sheathed car. With practically no preliminary experimenting 500 of these cars were built, and since then over 30,000 have been built similar to the first cars, with the exception of several refinements of details, such as corner and door posts, end doors and side plates, and the joining of flooring and lining. These changes have not affected the general design of the car, but are the improvements that have been introduced from time to time to reduce weight and simplify the construction.

ADVANTAGES OF THE STEEL FRAME CAR.

The steel frame inside sheathed car has several advantages over the types previously used, notably in that the tare is low in proportion to the capacity. There is such a variation in the figures used for the cost of hauling per ton mile, that no attempt is made to say what the saving would amount to, but certainly the advantage of having a car equal, if not superior to other cars in all respects, and weighing from 1,000 to 5,000 lbs. less, will appeal to all traffic and operating men. Not only is there that much less dead weight to haul when the car is empty or partly loaded, but additional lading can frequently be carried. The actual limit on the paying load that can be carried in a properly designed car is the total weight on the axles. Thus, a car having 5 in. x 9 in. axles with such a tare weight that, when deducted from the capacity of the axles, allows the car to be safely loaded to 88,000 lbs. could, if dead weight be reduced by 3,000 lbs. safely carry a paying load of 91,000 lbs. and retain the same strength. Thus the actual ca-



Hopper Bottom in Connection with Metal Sheathing.

capacity of the car is increased almost 4 per cent., with a better ratio of paying to dead load.

It had been thought necessary to assist the wooden type of superstructure by heavy roof construction, some going so far as to use different methods of diagonal bracing, but with the steel car it has been found that there is no appreciable local movement of the framing in the heaviest service which makes a simple proposition of the roof as it has only to take care of itself. This presents a simpler problem to roof designers, making it possible to design a roof much lighter, without necessity for the use of purlins or ridge poles to strengthen the car. It is obvious that unnecessary weight in the roof raises the center of

gravity, increases the tare weight and cost and has other disadvantages.

In explanation of the local movement of this style of framing, it is well to mention tests we have made in jacking up this type of car, which demonstrated that the car would take a gentle twist from end to end, allowing the bolsters to be slightly out of the same plane horizontally. This twisting was accomplished without any perceptible local distortion of the sides or ends. The capacity for twisting is a condition to be desired as it allows a car to adjust itself to uneven track conditions.

In addition to being 5½ in. narrower than the distance over the outside of the sheathing of a wooden car, the superstructure of the Canadian Pacific car is protected by the framing, so that



Interior of Canadian Pacific Corrugated Metal Sheathed Box Car.

a side swipe that would do serious damage to an outside sheathed car frequently does not touch the lining and is resisted by the framing without damage to the posts or braces. Frequently it is found that a side swipe that would almost demolish the sides of a wooden car only bends the steel framing, and in making repairs, the lining is merely removed, posts and braces straightened and the original lining replaced, the whole cost being the comparatively small labor charge. Jacking frames are being installed at all of our principal repair points for all classes of steel cars, and while not original with the Canadian Pacific, they have been amplified to better take care of steel frame box cars. With these frames, many jobs that would require the car to be cut apart, taking several days, can be done in a few hours without cutting the rivets. With modern steel frame cars, these jacking frames are as much a necessity as the blacksmith shop or any other part of the shop.

It is difficult to clean an outside sheathed car properly when it is unloaded, on account of grain lodging between the framework and also on account of the opening where the posts and braces meet at the bottom becoming obstructed, resulting in grain being retained between the sheathing and lining with resultant complaints from shippers. All of this is overcome by the clean joining of the lining and the floor in the steel frame cars, and it is believed a change of this kind would have come years sooner if designers had kept in close touch with service conditions. One advantage of the steel frame car is that outside of possible repairs due to wreck damage and to wear and tear of couplers, wheels, brake shoes and journal bearings, the car does not deteriorate more rapidly in service than when stored.

SELECTION AND TREATMENT OF LUMBER.

The grading of lumber for use in these cars is an item that has received much consideration. Yellow pine or fir has so far been the principal lumber used, although we have experimented

to some extent with spruce, but although it has the advantage of being lighter, it seems to be more difficult to dry spruce sufficiently for this purpose. Great pains have been taken to avoid knots that are too large or numerous and while it is generally desirable to have lumber as free from knots as possible, I have never in the inspection of many hundreds of cars, seen where a knot had fallen out. It is, however, desirable to have lumber as free from sap and shakes as possible and thoroughly dry.

When the first of these cars were built outside of the Canadian Pacific shops we had considerable difficulty in getting the lumber properly dried, due to lack of both experience and facilities on the part of the car companies. We have about 3,000

more than 10 per cent. must not be used until further dried.

The variable condition of the lumber when taken from the yard makes it necessary to use careful judgment as to the length of time it should be kept in the kiln. At the Angus shops of the Canadian Pacific this responsibility falls on the wood-mill foreman, whose constant attention to this feature makes him the man best fitted for the purpose. The average moisture loss reported by the test department for lumber used on cars now building at the Angus shops is 5.25 per cent., which shows that we are getting very satisfactory results from the kilns. A number of tests were made last year on lumber taken from the yard. These tests showed a moisture loss of between

REPORT OF MOISTURE IN LUMBER FOR LINING BOX CARS.

Built by..... At.....
 C. P. R. Equip. Order No..... For..... Number of Cars.....
 Report No.....

Moisture determination strictly in accordance with C. P. R. Spec. No. 243 C.
 Samples obtained every other day during construction, with a minimum of one sample for each one hundred cars built. Result of each test must be promptly recorded on this sheet and sent to R. W. BURNETT, Gen'l M. C. E., Montreal.

Lab. No.	Date of Sample	Cars Completed	Car Nos. Represented	Moisture Per Cent	Average To Date	Orig. Width Inches	Shrinkage Inches	Average To Date Inches	REMARKS

Signed

Engineer of Tests.

FORM USED ON THE CANADIAN PACIFIC FOR REPORTS OF THE MOISTURE DETERMINATION IN LUMBER.

cars on which the lumber has shrunk and given them a bad appearance, but this result was expected, as when the cars were built the lumber was quite green. The sheathing on these cars could be tightened for less than \$4 per car, but very few have been tightened, owing to receipt of practically no reports of loss or damage to lading due to the shrinkage; also as they do not frequently reach our main repair tracks, being shopped only for such repairs as wheels or wreck damage, we have not considered it advisable to shop the cars for a defect which is

25 and 30 per cent., which shows the importance of drying lumber properly. The accompanying form is used for reporting results of tests both at Angus and outside shops.

Due largely to our insistence, nearly all of the car plants in the country are now equipped with dry kilns, and any possible additional cost of drying lumber in excess of what has been considered good practice in the past would be less than one dollar per car. Such drying would make the car side practically the same as one board so that it is absurd that the possible shrinkage of lumber should be considered as any reason for this type of car not being built. It has been claimed that lumber can be so dried that it will swell and bulge, but we have never found this to occur. We have had cases where lumber slightly moist has dried more rapidly on the inside, due to that side not being painted, and made the outside of the boards slightly convex, with tight joints that could be easily mistaken for swelling, whereas the opposite is the case. We have kept a car with very green lumber in the passenger car shop under a high temperature for over a month until the lumber was absolutely bone dry, and then put it outside with doors open through four weeks of spring weather, during which it rained almost constantly, with a result that there was no closing of the cracks that could be detected. This further proves that there is nothing to be feared from lumber being too dry.

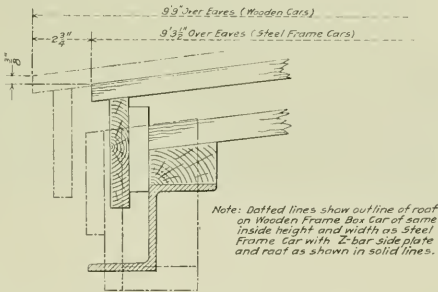

Roof Clearances on Steel Frame and Wooden Box Cars.

almost entirely a matter of appearance. The lining shrinks as much in two months of summer weather as it ever will.

The lining should not be matched before drying, as it warps and curls, rendering it difficult to make a tight joint. The rough size of lumber should be at least 1/4 in. greater than the finished dimensions. In establishing limits for drying lumber no information or data whatever could be secured, and after experimenting we came to the conclusion that a piece of this lining of full cross-section subjected to a temperature averaging 170 deg. F. for 96 hours should not lose more than 6 per cent. in weight and that lumber represented by samples losing

The defects in the sheathing that must be most closely watched are shakes or splits that extend obliquely downward into the car. These must be knifed in with paste before the car is painted. The edges of the lining should be painted, and we have found this can be done more easily and thoroughly by dipping the boards and putting them through between two rubber scrapers, which removes the surplus paint, leaving the edge thoroughly coated. This gives a thin coat of paint on the inside of the car which is an advantage in causing the lumber to dry more uniformly, and diminishes the tendency to warp. Narrow boards have the advantage of having less tendency to warp, and also if the lumber should not be thoroughly dry, there is less total shrinkage for each board making the space

between the edges narrower. The steel work and roofing are painted the same as on other cars. This considerable space has been given to the grading, drying and painting of lumber, as we have found that these factors have required much more attention than everything else in connection with the car.

DEVELOPMENT OF A STANDARD CAR.

The development of the inside sheathed car has been so rapid and the experience with it so uniformly satisfactory, that I feel safe in saying that its introduction in such large numbers on so many roads in so short a time indicates more nearly a tendency toward the adoption of a standard car than has any distinct type of car outside of patented cars for special service. It is certain that there will be no backward movement to a wooden superstructure, and that this car with possible modifications will remain a standard car unless some superior type of car is developed. It is the writer's opinion that no committee will ever develop a car that will be adopted as standard, but that the nearest we will ever get to a standard is what may be developed by one or two persons given a free hand, and the merit of which is so pronounced that it forces itself upon the country.

With the use of structural steel there is less necessity of carrying special parts in stock on account of repairs being largely a question of labor, and it seems that with this type of car the necessity from a repair standpoint for a standard car is decreasing. This is further borne out by the fact that for the 30,000 new cars of this type we have ordered no material for repairs and carry none in stock outside of material common to all cars, except lining; of the lining, our stock amounts to practically nothing. We save out sufficient of the parts from cars destroyed to make up our stock of repair parts, but have found it necessary to use very little of this. There are, of course, many valid reasons why cars should be made to standard inside dimensions and outside clearances.

To look at the matter in another way, the wheels, axles, journal bearings, journal boxes, couplers, brakes, safety appliances, etc., which constitute the removable and perishable parts, are all standard and when it is remembered that nearly all of the remaining parts of the cars are standard rolled shapes which are easily obtained either from the mill or from stock in all principal cities, it is apparent that we now have, in effect, a standard car or at least a car of standard parts. A car of different dimensions would not increase the cost of maintenance as long as standard shapes are used; nor would it if every lot of cars is designed differently, as long as proper strength is maintained, and any change in design would usually be to increase the strength. In other words, to keep a car as close as possible to standard and reduce the cost of maintenance, rolled shapes should be used in preference to pressed shapes where possible.

It is my belief that the people who are urging the adoption of a standard car for maintenance reasons have in mind the remaining wooden cars for the maintenance of which large quantities of timbers and castings have to be kept in stock. It is of vital importance that the parts be standardized if that style of construction were to be continued. It should not be overlooked that in a car constructed with rolled shapes, these parts seldom need renewal, even when the car is wrecked, as they can easily be straightened or formed to the original shape at any car repair point, while wood would have to be replaced and pressed shapes would call for special dies to reform them. With a wooden box car the amount of material necessary to carry in stock and use for repairs increases rapidly with the age of the car, while with a steel frame box car, outside of parts common to all cars, it does not increase.

WIND RESISTANCE.

The wind resistance on the steel frame box cars with inside sheathing is slightly greater than on a smooth outside sheathed

car, but on the other hand, it is less than on any ordinary type of stock car. The difference in the effect of wind resistance between box and stock cars has never been great enough to require any distinction between them as to the number of cars that could be hauled in a train of either, and is really a refinement that not even a dynamometer car can detect. A small change in the angle or velocity of the wind, trucks somewhat out of square, etc., affect the haulage of the train too much to enable any satisfactory figure for the difference in the wind resistance of the various types of cars to be determined. There is a certain stretch of track of about 40 miles on the western plains, without a curve and practically level, where high winds are frequent, on which the hauling capacity of locomotives is dependent principally upon the wind, and yet even there it was found practically impossible to distinguish between the wind resistance of stock and box cars. From this, it is evident that the wind resistance of steel frame inside sheathed box cars



End Construction and End Doors of Canadian Pacific Steel Frame Box Cars.

as compared with outside sheathed cars may properly be ignored.

CORRUGATED STEEL LINING.

In the summer of 1911, we lined a steel frame box car with corrugated steel and found it to be as simple a matter as lining with wood. We lapped and riveted the sheets, which were No. 13 gage, between the door and end, and had the corrugations on the side and end coincide, pressing into special corrugated angles in the corners to break the joints. At the floor, we straightened out about 4 in. of the corrugation and formed it in an angle that rests on the side sill, and on this the ends of the floor boards were superimposed, making a very tight joint. After 18 months of general service this car was brought in and on examination found to be in as good shape as when constructed. It was interesting to note that when inspected,

the paint sealing the joints where the side sheets lapped was in no place seal broken, indicating that there is no material wearing or deflection of the sides. The paint was in perfect condition, there still being some gloss, indicating that in the use of steel there is no disadvantage as far as the painting is concerned. Different methods of lining with steel could be followed, and I am convinced that if experience proves that there is no damage to be feared from heat, cold or sweating, steel lining will be largely used. But, I am also convinced that the use of steel lining with any insulation will never be extensively used, as it adds to the cost and weight without affording any protection to the lading, which is not secured by the wood lining. An advantage of this construction is shown in one of the illustrations in the application of hoppers under the door openings, which were made without alterations to sills or cross bearers.*

END CONSTRUCTION.

In the end of the car we use two 4 in. Z-bar end posts of 8.2 lbs. per ft., with 1 3/4 in. lining, which gives good service, but we intend to use on future cars two 5 in. end posts of 11.6 lbs. per ft., with 2 3/8 in. lining for a height of 4 ft. and 1 3/4 in. lining above. This, we feel, will amply protect any lading. If a car gets such rough handling that wheels, rails or similar lading would break through, it is better to have the boards broken than to distort the posts, as the lining can be replaced at any repair track with a minimum expense, while distorted posts would require sending the car to a steel car repair point. The single thickness end lining makes convenient the application of single thickness, grain-tight end doors.

SERVICE RESULTS.

Out of 30,000 of these cars, 29 have been destroyed. Based on the length of time in service, this would average a loss of approximately one car per 1,000 per year. Of the cars destroyed, 15 were burned and 14 were destroyed in wrecks, 10 cars being destroyed on foreign lines. As the loss of cars by fire is in no way affected by the details of construction, I will eliminate them from the calculations. This then, based on the length of time in service would give about one-half car per 1,000 per year destroyed in wrecks.

A conservative estimate shows that there are now in service approximately 65,000 steel superstructure cars, including those of the outside sheathed type, and of this number 30,000 belong to the Canadian Pacific.

TRAIN LIGHTING INSTRUCTION CAR

Continuing in its policy of instructing employees in their several lines of duty, the Pennsylvania Railroad has just placed in service a train lighting instruction car. This company has in all at the present time no less than eight distinct axle-driven systems, in addition to the large number of straight storage equipments. The instruction car seems to offer the most efficient means of furnishing uniform instructions to yard electricians and others concerned with the maintenance and operation. The

present intention is that the car will be sent to the different points at which electrical forces are maintained, and the men at such points will be given lectures and demonstrations on the operation and maintenance of all the various equipments.

The apparatus installed consists of a 32-cell storage battery, a 15-k.w. Curtis turbo-generator, a variable speed motor with necessary controlling apparatus for driving the axle generators and the following generators with their regulating equipment: Newbold, Moskowitz, Bliss, Safety and Gould. One end of the car has been partitioned off and equipped as an office and sleep-

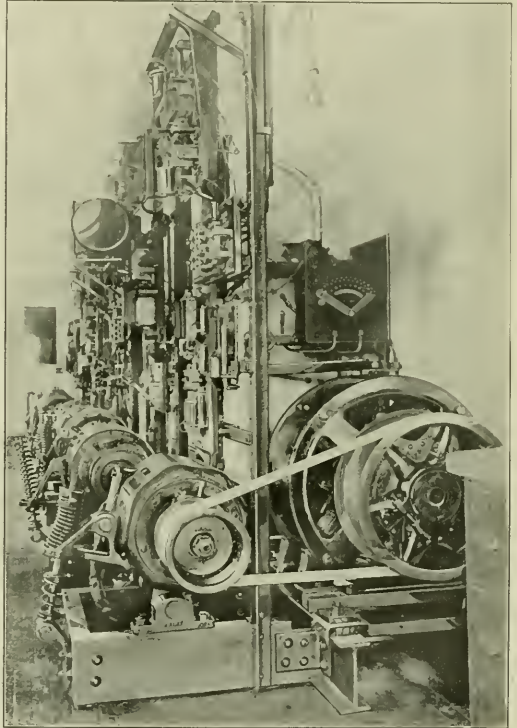

Arrangement of Axle Driven Equipments in the Instruction Car.

ing quarters for the instructor. The storage battery is placed within the car in order that the cells may be used in demonstrating as well as for lighting the car; the usual battery boxes under the car are omitted.

The compartments for the cells are lined with sheet lead and arranged with ventilators through the car roof to conduct away the gases and fumes given off when the batteries are on charge. In one corner is installed a 15-k.w. turbo-generator set, as

*For description of Canadian Pacific hopper bottom box car with wood lining see *Railway Age Gazette*, Mechanical Edition, July, 1913, page 386.

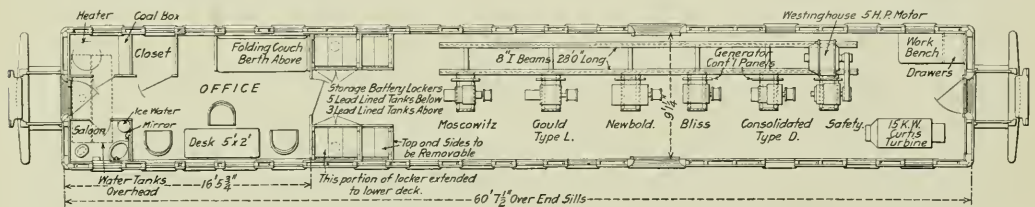

Plan of Train Lighting Instruction Car on the Pennsylvania Railroad.

formerly used on all Pennsylvania limited trains. In this case the usual switching devices are replaced by two single-pole automatic circuit breakers, giving both overload and underload protection to the machine. The field rheostat and meters are mounted on the side of the car. Connections are such that the turbo-generator can be used for driving the motor, charging the batteries, and lighting the car, though, under ordinary conditions, the motor will be driven from the yard power lines. The axle generators are mounted on rocker shafts and are equipped with springs for regulating the belt tension as is done in actual service. Immediately back of each machine is an angle iron framework on which the corresponding regulating apparatus is mounted, the equipment in each case being identical with that installed on passenger cars. Each generator is connected through suitable switching devices to the lamp load and batteries, enabling the operator to demonstrate the apparatus

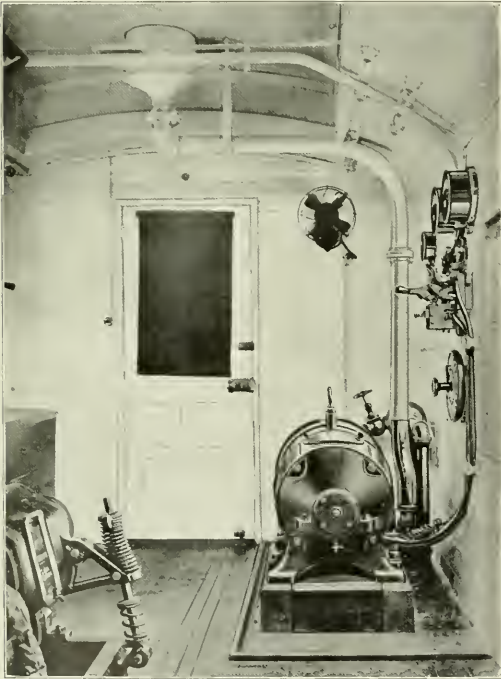

Turbine and Generator at One End of the Car.

under all conditions of load. The lamps used for this are banked in porcelain receptacles on the ceiling of the car. The driving motor is of the interpole type, and is mounted on an iron framework equipped with rollers, which enable the operator to move the motor equipment along an I beam track for belting up to any one of the six generators. The control panel for this machine is secured to the movable framework and moves with the motor.

The operator's office contains a folding couch, upper berth, clothes closet and toilet, the finish throughout being white enamel. With the instruction car in operation it is intended that all employees, in both the mechanical and operating departments whose duties have to do with the car lighting shall be instructed in the care and operation of the various equipments, with the two-fold object of educating those interested and securing uniformity in their work.

REPAIR TRACK NOTES

BY A REPAIRMAN

In spite of all that has been said during the past two or three years regarding the increasing expenditures for the maintenance of freight cars, a great many railway men do not seem able to see beyond the question of first cost. Of course, it must be admitted that a few dollars per car increase in the first cost makes a very considerable total when several thousand cars are being ordered, but if the best of everything is not used the saving made in the first cost may be much more than offset in maintenance charges in a comparatively short time. If a device of inferior design or construction were to fail once and then be replaced, conditions would not be nearly so bad, but this is almost never the case. If, for example, a door becomes disabled when on a foreign line, the weak points of the door fixtures are not brought out and remedied in making the repairs. The door is replaced in kind and another failure may take place at any moment. It is this perpetuating of devices that are not capable of giving good service that is one of the greatest causes of car maintenance expense.

* * * * *

Where is the logic in placing a steel roof at the top of a wooden superstructure? If the roof stays on the car at all during the switching that is common in all modern yards, it will very soon start leaking; at least, that has been my experience. I am not by this condemning the steel roof by any means, but I do not believe that a roof of this type has yet been perfected nor that they have any place on cars with wooden superstructures.

* * * * *

The arch bar truck has given good service on American railroads, but it should have no place under modern freight equipment. Even provided that it is possible to keep nuts on the bolts, an arch bar is likely to crack and fail on the road at any time, tearing up the track and causing a wreck which blocks traffic. This type of truck has had its day, and should be kept out of modern freight service.

ARE STEEL PASSENGER TRAIN CARS NEEDED?

While steel passenger train cars may be desirable from many points of view, there is a considerable question in the minds of many as to the advisability of unnecessarily expending money for them when it might far better be spent in other ways which will go to the very root of things and eliminate the causes which are responsible for the accidents. After all, the number of lives that may be saved by the use of such equipment is only an extremely small percentage of the lives lost annually on railroads. For instance, for the year ended June 30, 1912, 318 passengers were killed and 16,386 injured, while 3,235 employees were killed and 50,079 injured, and 6,632 other persons were killed and 10,710 injured. Only 3.1 per cent. of those killed and 21.2 per cent. of those injured were passengers, and this is the class to which the introduction of steel cars will be of greatest benefit. Furthermore, less than one-half of the passengers killed were in collisions or derailments. The others were killed or injured largely because of want of care on the part of the victims themselves.

If laws are to be enacted forcing the roads to equip with steel passenger cars, it would hardly seem necessary, or even advisable in many cases, to require such cars except on roads or divisions where the traffic is heavy and is operated at high speed. Where trains are operated at slow speed, or are few in number and small, as they are on many roads or on some divisions and branches of large systems, it is useless to require all-steel cars. The money could be better spent in providing safeguards to prevent accidents.—*Railway Age Gazette*.

STEEL UNDERFRAME BOX CARS*

Tabular Comparison of Several Underframes;
Reasons for More Effort Toward Standardization.

BY GEORGE W. RINK,
Mechanical Engineer, Central Railroad of New Jersey, Jersey City, N. J.

It is surprising, in view of the interchange of steel underframe box cars among the railroads, that more has not been accomplished during the past five years toward standardization in design of the various component parts, particularly those which affect the cost of maintenance and require constant repairs due to wear and unavoidable accidents.

During the year 1912, there were built 107,887 box cars of various capacities and dimensions, all varying vastly in detail design of important parts which require frequent renewal, thus making it necessary for all railway storehouses to carry an unnecessarily large stock of repair parts running into very large sums of money. Standards have been adopted by the Master Car Builders' Association which have in large measure reduced the amount of stock necessary to carry. I believe the time has arrived to introduce additional standards affecting the main-

the result that large sums of money are now being spent by railroads in making repairs to these cars by reinforcing broken center and draft sills, applying larger capacity draw gears and attachments, and heavier sills. It is not alone the larger locomotives we are using today which has called for a more thorough investigation of the subject of car design and construction, but also the severe shocks which cars are receiving in classification yards. Also the superstructure of box cars should receive just as much attention as the underframe, for how can the roofs be kept in alignment on cars having wood side posts and braces and loose tie rods? The roof is bound to work loose, resulting in leaks which prevent the use of the car for certain commodities.

The application of steel center sills to old cars will no doubt prolong their life. This is now being done by almost every railroad on cars built just prior to the advent of all-steel underframe box cars, but care should be taken to see that sufficient metal is provided to withstand the present service requirements, keeping in view a margin of safety for the future, as no doubt it would be desirable to maintain in service for at least ten years cars to which these steel center sills are applied.

Railway officials in charge of car repairs have seen the results of poor designing and light construction of the earlier steel underframe cars, and during the past three years have materially assisted in the development of the art by insisting upon the production of a stronger car, one that will hold together in all kinds of service with the minimum cost of repairs.

The accompanying tables, numbered 1 to 4, have been compiled to show interesting information on the subject of center sill constructions for 14 different cars, the types of underframes used in which are shown in outline in Fig. 1. The heavy lines in the drawings indicate the cover plates used which appear to be a general practice among designers. This is considered by many to be a very desirable feature and besides adding to the rigidity of the structure as a whole, increases the net area of the section and therefore reduces the fiber stress to within reasonable figures.

The strains which an underframe has to withstand vary, and depend a great deal on the design and arrangement of the body bolsters, side sills and body framing. With substantial side sills and body bolsters, compressive strains can be transmitted by the latter and thus part of the compressive load can be taken care of by the side sills. However, there is a limit to the load the side sills can take care of which is based on the ratio of length to the least radius of gyration, the length being considered as the maximum distance between adjacent floor beams. In the case of cars with wood body side framing it would appear desirable to provide sufficient area at the smallest section of the center sills to take care of end strains, allowing the side sill to carry only its proportion of the vertical loads due to lading, weight of superstructure and an allowance for vibration.

In the case of box cars with steel side frames there is no question about the ability of the frame structure to carry considerably greater loads, both vertically and due to end shock, on account of the diagonal braces assisting in transmitting the strain throughout the side. For this reason some designers do not consider it necessary to use continuous cover plates on the center sills, but use rolled steel sections for these sills, having

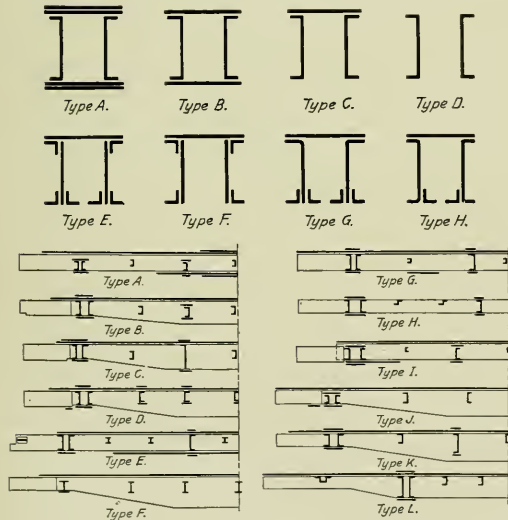

Fig. 1.

tenance of box cars which can also be applied to all types of freight cars used in interstate business.

It is reasonable to assume that every railroad manager desires to purchase cars built in a substantial manner. In the absence of standard construction and because of competition, the car builders, when asked to furnish estimates and designs, will sometimes figure on material too light for the service. This, however, is not the fault of the car builder, since, from my own experience, I know that they will gladly add the material where needed, provided they are paid a fair price for the car.

From my observation of steel underframe box cars, I must conclude that engineers did not understand the importance of low fiber stresses in the early designs of steel underframes; sufficient attention was not given to the tremendous impact blow which the center sills and car framing have to resist, with

*An extract from a paper read before the American Society of Mechanical Engineers at the annual meeting, December 3, 1913.

TABLE 1.—DATA AT CENTER FOR CARS WITH WOOD SIDE FRAMES.

Road.	Sill Type.	Section Type.	Depth over Flanges, In.	Web Plate, In.			Bottom Angle, In.		Cover Plate, In.		Minimum Area, Sq. In.	Neutral Axes.		Section Moduli.		Max. Stress due to Vertical Loads, Lbs. per Sq. In.	Compression due to End Shock, Lbs. per Sq. In.	Compression due to Eccentricity, Lbs. per Sq. In.	Maximum Com-bined Compression, Lbs. per Sq. In.	Center Line of Gravity above or below Neutral Axis, In.	$\frac{1}{A} + \frac{e}{A}$
				Web Plate, In.	Outside Top Angle, In.	Outside.	Inside.	Top.	Bottom.	Xc		Xt	Sc	St							
															Outside.						
D. L. & W...	A	A	12	2-1/4x19	2-1/4x19	32.12	6.21	6.79	154.16	141.	9851c	9338	9402	12787	3.29	0.054	
C. R. R.....	A	15	1-3/8x20 1/2	1-3/8x20 1/2	36.23	7.67	8.20	208.24	196.0	7421c	8279	701	16401	4.87	0.029	
N. Y. O. & W. B	G	24	3/4	3 3/4 fl.	3 1/2x3x3/8	3 1/2x3x3/8	3 1/2x3x3/8	1-3/4x20 1/4	1-3/4x20 1/4	27.67	12.74	11.51	212.57	235.28	8462c	10842	2455	21759	1.74	0.0442	
P. & R.....	C	E	26	3/8	4x4x 1/2	4x4x 1/2	4x4x 1/2	1/4x22 1/4	...	45.01	13.06	13.19	377.69	373.97	7645f	6664	5012	17190	6.31	0.038	
B. & A.....	D	E	22	1/4	3x3x3/8	3x3x3/8	3x3x3/8	1/4x20 1/4	...	26.84	10.18	12.07	213.77	180.30	5514c	11177	3410	23514	4.49	0.0485	
C. & N. W....	E	B	15	3/8x20	3/8x20	33.12	7.51	8.24	173.73	158.34	10584f	9056	6321	15607	2.43	0.058	
Un. Pac.....	F	E	30 1/2	3/4	3x3x3/8	3x3x3/8	3x3x3/8	1/4x20 1/2	...	32.09	15.26	15.49	317.92	313.2	14123f	9346	5671	23583	6.01	0.049	

TABLE 2.—DATA AT CENTER FOR CARS WITH STEEL SIDE FRAMES.

Road.	G Sill Type.	C Section Type.	Depth over Flanges, In.	Web Plate, In.			Bottom Angle, In.		Cover Plate, In.		Minimum Area, Sq. In.	Neutral Axes.		Section Moduli.		Max. Stress due to Vertical Loads, Lbs. per Sq. In.	Compression due to End Shock, Lbs. per Sq. In.	Compression due to Eccentricity, Lbs. per Sq. In.	Maximum Com-bined Compression, Lbs. per Sq. In.	Center Line of Gravity above or below Neutral Axis, In.	$\frac{1}{A} + \frac{e}{A}$
				Web Plate, In.	Outside Top Angle, In.	Outside.	Inside.	Top.	Bottom.	Xc		Xt	Sc	St							
															Outside.						
C. & O.....	A	15	1/8x19 3/4	...	25.96	6.	9.31	150.03	96.69	10973c	7704	7345	11331	2.56	0.095	
Erie.....	H	D	15	18.73	7.092	7.908	80.0	71.72	20311c	10678	10275	20714	4.158	0.1112	
Can. Pac.....	H	D	15	18.73	7.092	7.902	80.0	71.72	30311c	10678	13270	17719	5.408	0.1287	
Wabash.....	J	C	15	1/8x20	...	26.05	5.98	9.33	151.04	96.8	10887c	7677	6806	11758	5.14	0.091	
Frisco.....	J	E	26	1/4	3x3x3/4	3x3x3/8	3x3x3/8	1/4x20	...	26.89	12.38	13.87	235.53	210.23	8725c	7437	747	16909	.88	0.04	
U. P.....	K	G	27 3/4	3/4	3 3/8 fl.	3 1/2x3x3/8	3 1/2x3x3/8	1/4x23	...	28.78	13.94	14.06	261.67	259.43	9053f	6949	3829	19831	2.80	0.053	
P. R. R.....	L	H	20	3/8	4 fl.	4 fl.	4x4x3/8	3/8x2	...	35.91	9.55	10.82	258.58	228.34	10606c	5569	2266	18441	2.93	0.039	

TABLE 3.—DATA AT BOLSTER FOR CARS WITH WOOD SIDE FRAMES.

Road.	Sill Type.	Section Type.	Depth over Flanges, In.	Web Plate, In.			Bottom Angle, In.		Cover Plate, In.		Minimum Area, Sq. In.	Neutral Axes.		Section Moduli.		Compression due to Vertical Loads, Lbs. per Sq. In.	Compression due to End Shock, Lbs. per Sq. In.	Compression due to Eccentricity, Lbs. per Sq. In.	Maximum Com-bined Compression, Lbs. per Sq. In.	Center Line of Gravity above or below Neutral Axis, In.	$\frac{1}{A} + \frac{e}{A}$
				Web Plate, In.	Outside Top Angle, In.	Outside.	Inside.	Top.	Bottom.	Xc		Xt	Sc	St							
															Outside.						
D. L. & W....	A	B	12	1/4x19	1/4x19	24.20	6.25	6.25	103.11	103.11	12396	8728	2124	3.00	.07		
C. R. R.....	A	C	15	1/4x20 1/2	...	23.91	6.33	8.92	134.27	95.28	12547	2109	14656	below	.048		
N. Y. O. & W. B	G	15	3/4	3 3/4 fl.	3 1/2x3x3/8	3 1/2x3x3/8	3 1/2x3x3/8	1/4x21 1/4	...	25.00	8.42	6.83	119.84	147.76	12000	5238	17238	2.58	.057		
P. & R.....	C	E	11 1/4	3/8	4x4x 1/2	4x4x 1/2	4x4x 1/2	1/4x22 1/2	...	36.18	5.91	5.59	124.68	131.82	8291	1911	10202	below	.033		
B. & A.....	D	E	12 3/4	1/4	3x3x3/8	3x3x3/8	3x3x3/8	1/4x20 1/4	...	23.90	6.28	6.84	110.31	101.13	12553	4331	16883	1.46	.055		
C. & N. W....	E	C	15	3/8x20	...	27.30	5.76	9.61	164.24	98.44	10989	18986	29975	6.23	.099		
Un. Pac.....	F	F	12 3/4	3/4	3x3x3/8	3x3x3/8	...	1/4x20 1/2	...	19.08	5.11	8.01	97.61	62.33	15719	19901	35620	4.135	.118		

TABLE 4.—DATA AT BOLSTER FOR CARS WITH STEEL SIDE FRAMES.

Road.	G Sill Type.	C Section Type.	Depth over Flanges, In.	Web Plate, In.			Bottom Angle, In.		Cover Plate, In.		Minimum Area, Sq. In.	Neutral Axes.		Section Moduli.		Compression due to Vertical Loads, Lbs. per Sq. In.	Compression due to End Shock, Lbs. per Sq. In.	Compression due to Eccentricity, Lbs. per Sq. In.	Maximum Com-bined Compression, Lbs. per Sq. In.	Center Line of Gravity above or below Neutral Axis, In.	$\frac{1}{A} + \frac{e}{A}$
				Web Plate, In.	Outside Top Angle, In.	Outside.	Inside.	Top.	Bottom.	Xc		Xt	Sc	St							
															Outside.						
C. & O.....	A	15	1/8x19 3/4	...	25.96	6.	9.31	150.03	96.69	7704	11500	19204	5.56	0.095		
Erie.....	H	D	15	19.8	7.5	7.5	83.4	83.4	10101	9100	19201	3.75	0.095		
Can. Pac.....	H	D	15	19.8	7.5	17.5	83.4	83.4	10101	11990	22091	below	0.110		
Wabash.....	I	C	15	1/8x20	...	26.05	5.98	9.33	151.04	96.8	7677	10620	18297	5.14	0.091		
Frisco.....	J	E	13 3/4	1/4	3x3x3/4	3x3x3/8	3x3x3/8	1/4x20	...	22.34	6.93	7.19	108.01	104.1	8953	8760	17713	below	0.088		
Un. Pac.....	K	G	13	3/4	3 3/8 fl.	3 1/2x3x3/8	3 1/2x3x3/8	1/4x23	...	23.03	6.86	6.39	103.54	111.16	8684	4174	12858	4.56	0.063		
P. R. R.....	L	H	11	3/8	4 fl.	4 fl.	4x4x3/8	3/8x24	...	30.68	5.38	5.99	125.8	113.0	6513	2194	8707	2.24	0.043		

a much smaller net area than what is considered good practice by others.

In order to properly analyze the stresses in underframes a standard method of comparison should be made. Cars do not fail as a rule because of the weight of lading, but principally because of strains transmitted through the coupler. The magnitude of the end shocks that underframes have to withstand was investigated in tests conducted prior to 1902, on the Lake Shore & Michigan Southern with a dynamometer car having a capacity of 300,000 lbs. It was found that the tensile and buffing strains, with an engine having a tractive effort of 36,000 lbs., were from 50,000 to 70,000 lbs., and 80,000 to 150,000 lbs. respectively, depending upon the skill of the engineer in manipulating the engine, the train remaining intact. In coupling an engine to its train, buffing strains from 65,000 to 142,000 lbs. were obtained. Thirty cars moving at about 6½ miles an hour, and coupling to ten loaded cars with brakes set, gave a shock of 376,492 lbs. It would appear from the above results that provisions should be made in designing a steel underframe box car to take care of an impact blow of 350,000 lbs. transmitted throughout all sills.

It would therefore seem advisable to assume an end strain of 200,000 lbs. on the center sills of box cars with steel side frames and 300,000 lbs. for box cars with wood side frames for the reasons previously mentioned. If the center line of the coupler was directly on a line with the neutral axis of the section to be analyzed, the stress per square inch on the center sills due to end shocks would be equal to the buffing force *B* divided by the area *A* of the section. Referring to the tables, the area of the sills is given both at the center line of the car and near the bolster. The eccentricity *e*, or the distance from the center line of the draw gear to the neutral axis is also given for these sections. The stress at the bolster due to eccentricity equals

$\frac{Be}{S_t}$ when the center line of the draw gear is below the neutral axis, and $\frac{Be}{S_e}$ when the center line is above the neutral axis.

The combined stress at the bolster equals $\frac{B}{A} + \frac{Be}{S_t}$ or

$\frac{B}{A} + \frac{Be}{S_e}$, depending upon the location of the center line of the draw gear.

At the center line of the car, compression stress due to the lading equals $\frac{M}{S_e}$. Stress due to eccentricity equals

$\frac{Be}{S_e}$. Stress due to end shock equals $\frac{B}{A}$. When the center line

of the draw gear at the center of the car is below the neutral axis, the combined stress equals $\frac{M}{S_e} + \frac{Be}{S_e} + \frac{B}{A}$, and if the center

line is above, the combined stress equals $\frac{M}{S_e} + \frac{Be}{S_e} + \frac{B}{A}$. The

ratio of stress to the end strain is obtained by the formula $\frac{1}{A} + \frac{e}{S}$, in which *S* represents the section modulus, *S_t* to be

used if the center line of the draw gear is below and *S_e* if above, the neutral axis. The Car Construction Committee of the Master Car Builders' Association recommends that the above ratio on new cars should not exceed 0.06. They also recommend a minimum center sill area of 24 sq. in.

Tables 1 and 2 give the maximum stress on center sills due to vertical loading, which was obtained by assuming a uniform load distributed throughout the sill. Calculations are based on the weight of car body, *A*, the lading, *B*, and the oscillation *C*. The car body weight *A*, carried on center sills was taken at

20,000 lbs., except for the Philadelphia & Reading box car, in which the weight used was 24,000 lbs. (assumed as two-thirds of the total weight of the car body and the underframe). The lading *B* for 60,000 lbs. capacity cars was assumed as 66,000 lbs., for 80,000 lbs. capacity cars was assumed as 88,000 lbs., and for 100,000 lbs. capacity cars was assumed as 110,000 lbs. The oscillation *C* was taken at 20 per cent. of the sum of the lading and the weight of the car body.

The calculations for center sill load for box cars with wood

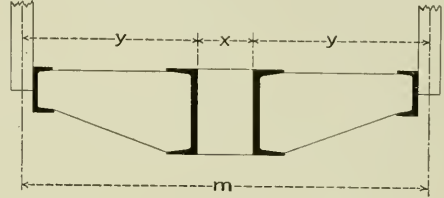

Fig. 2.

side frames were made as follows: Load per square inch of floor space

$$w = \frac{A + B + C}{lm}$$

Total uniform load on center sills, $W' = wl(x + y)$

where (see Fig. 2),

l = length over centers of end posts, in inches,

m = distance over centers of side posts, in inches,

x = spacing of center sills,

y = distance from back of center sill to center of side post, in inches.

The calculations for center sill load for box cars with steel

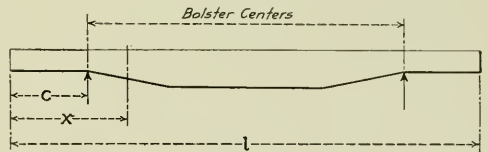

Fig. 3.

side frames were made as follows: (See Fig. 3.) Load per square inch of floor space

$$w_1 = \frac{\frac{A}{3} + B + C}{lm}$$

Total uniform load on center sills $W' = w_1l(x + y)$

Bending moment of center sills

$$M = \frac{W'}{2} \left(\frac{l}{4} - c \right)$$

M = maximum bending moment at center of car

c = distance from center line of bolster to center of end post, in inches

$\frac{M}{S_e}$ = compression per square inch

$\frac{M}{S_t}$ = tension per square inch

Bending moment at any point *x* =

$$Mx = \frac{W'}{2} (x - c) - \frac{Px^2}{2}$$

where

x = distance in inches from center of end post to any section between bolster and center of car

P = load per lineal inch of sill.

In making the calculations for the Pennsylvania Railroad box car, it was assumed that the cross bearers transmitted to the center sills a certain proportion of the weight of the car body, thus producing an additional bending moment in the center sills.

TABLE 5.—DATA FOR AREAS AND STRESSES IN CENTER SILLS.

	AREA OF CENTER SILLS.					
	At Center.			At Bolster.		
	Min.	Max.	Aver.	Min.	Max.	Aver.
36 ft. cars, wood frame...	26.84	45.01	33.37	23.09	36.18	26.64
36 ft. cars, steel frame...	18.73	26.05	22.19	19.80	26.05	22.72
40 ft. cars, wood frame...	32.09	33.25	32.60	19.08	27.30	23.19
40 ft. cars, steel frame...	26.89	35.91	30.52	22.34	30.68	25.35

	MAXIMUM COMBINED STRESS.					
	At Center.			At Bolster.		
	Min.	Max.	Aver.	Min.	Max.	Aver.
36 ft. cars, wood frame...	13505	23514	18274	10202	21124	16020
36 ft. cars, steel frame...	10539	20714	15182	18297	23069	20409
40 ft. cars, wood frame...	15607	23583	19595	29975	35620	32798
40 ft. cars, steel frame...	16909	19831	18393	8767	17713	13093

From Tables 1 to 4 are obtained the data in Table 5. For the 36 ft. cars with wood body framing, it would appear that the averages shown for the area and stress both at the bolster and the center of the car approach figures which are safe for general practice. For the 36 ft. cars with steel body framing, the average stress per square inch behind the bolster is too high for safe practice and should be reduced by increasing the area. The low combined stress at the center of the car is due to the center line of the coupler being located about 5 in. below the neutral axis, which reduces the compression due to direct end shock. At the center of the car the stress due to lading alone is also too high for safe operation. For the 40 ft. cars with wood body framing, the average stress per square inch is entirely too high and should be reduced by increasing the area of the section and cutting down the eccentric load due to end shock; this also applies to the section at the center of the car. In the 40 ft. cars with steel body framing, the maximum combined stress at the center of the car is a trifle high.

In all of these cases it is well to note that the relation of the center line of the coupler to the neutral axis has an important bearing on the strength of the sills. At the center of a car with fish-belly type sills the center line of the coupler is usually above the neutral axis, which adds to the total combined compression; whereas, with structural steel sills, the coupler center line being below the neutral axis, will counteract somewhat the compression due to impact. This leads me to believe that nothing is gained by making the depth of fish-belly sills at the center any greater than is required to take care of the vertical loads. It will also appear that a fish-belly type sill is necessary for all types of cars mentioned of 80,000 and 100,000 lbs. capacity, except 36 ft. steel side frame cars, which will render good service when using a center sill construction of plates and channels. For body bolsters, it is general practice to use two pressed steel channels spaced at various distances apart with cover plates top and bottom. The best designs have a spacing of 6 in. to 8 in. between webs. For crossbearers, a variety of designs exist, the later types consisting of heavy I-beams passing directly through the center sill web plate and extending the width of the car between side sills. This plan is also followed out on the intermediate floor beams and makes a neat and substantial arrangement. The general practice is to use a pressed steel channel with top and bottom cover plate.

For draft sills, the practice is, where structural steel channels are used for center sills, to extend them to the end sill to serve as draft sills. It has been customary when fish-belly type center sills are used, to provide pressed steel Z-shape draft sills and splice them to the center sill web plates projecting through the bolster. There is a tendency on the part of designers today to do away with the splice by extending the web plates of center sills and providing outside angles to form the draft sill using a continuous cover plate. Where pressed steel center sills

and cover plates are used, the practice has been followed of extending this construction to the end sill, bringing the cover plate too near the end of the sill. This construction requires the use of web plates about 5/16 in. thick, so as to provide sufficient bearing area for draft lug rivets. I believe that when draft sills have sufficient net area behind the bolster stop, that considerations of economical construction would warrant dispensing with the splice, as in view of the additional cost of a splice on 1,000 cars, the expense of its application is not warranted when considering the number of sill failures likely to occur due to its omission.

As to draft gears, data regarding the type used have not been tabulated. It is sufficient to say that of the cars enumerated, six were equipped with spring draft gears and nine with friction gears. The impact blow resulting from cars coming together is practically absorbed by the draft gear. Friction gears are more efficient in this respect, absorbing a much greater percentage of total energy than spring gears. Owing to the large variety of gears in service, necessitating numerous designs of draft lugs, key attachments, etc., it would appear that, if a standard arrangement of draft gear and all appliances connected therewith were adopted by all railroads, it would result in great economy of maintenance. This should include striking plates and carry irons which on a large number of cars are not of sufficient strength, due to the arrangement of the end sills.

It is surprising that more has not been done in the way of standard construction of box cars. The large expenses which railroads are now compelled to face, due to repairs of freight cars could be partially reduced if standard designs were in use throughout the country. Repairs would be facilitated, due to the use of standard materials throughout for various types of cars, fewer cars would be held up at car repair shops awaiting material from foreign roads, and interchange of cars would not be a hardship to any railroad, as all cars would be of equal strength. Also drawing room expenses would be reduced both for the railroad and car builder, and repair parts could be produced by cheaper methods than those followed at present, due to the elimination of a variety of designs and shapes, principally castings and pressed steel parts.

THE COST OF ELECTRIFICATION.—The cost of everything electric is enormous. The cost of the electric locomotive is at least double that of the steam locomotive, which they are supposed to replace, and before electric locomotives can be operated it is necessary to incur a large additional outlay for power houses, transmission systems, track preparation and all of the other apparatus and material which is necessary to complete an electric system. One estimate which has been brought to my attention provides an investment of about \$200,000 for each steam locomotive displaced, or about ten times the cost of each of the latter. As there are about 70,000 locomotives in the United States, representing an investment of about one billion, four hundred million dollars, I am sure you will agree with me that some exceptionally favorable return must be apparent before they will all be discarded; especially so when their replacement involves an expenditure of many times their present value. It is true that the demand is rarely made that an entire cross country line be operated by electric power, but that such operations be confined to the larger cities. Such an installation, however, except under particularly favorable conditions, involves not only a proportionately heavier investment for the electric plant, but requires the establishment of two locomotive terminals, one each side of the city, and an additional stop at each of the termini for an exchange of the steam for an electric locomotive or vice versa. Even if the railways could stand the burden of the cost, it is doubtful if the traveling public would tolerate frequent delays of this kind.—D. F. Crawford before the International Society for the Prevention of Smoke.

SHOP PRACTICE

MISCELLANEOUS SHOP KINKS

BY JOHN TODD,
Machine Shop Foreman, Erie Railroad, Galion, Ohio.

DRIVING WHEEL STAND.

The horse or stand shown in Fig. 1 is used for holding mounted driving wheels while the tires are being put on or removed. It is made of heavy material to withstand rough usage and the weight of heavy drivers. The legs are $3\frac{1}{2}$ in. x 1 in., the top bar 6 in. x $1\frac{1}{4}$ in., and the braces $3\frac{1}{2}$ in. x $\frac{1}{2}$ in.

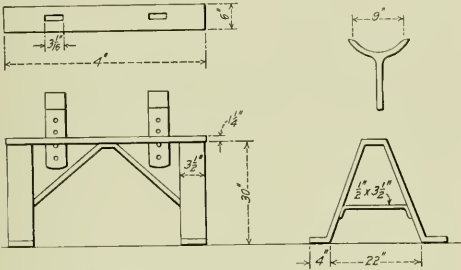

Fig. 1—Stand for Holding Mounted Driving Wheels.

The top bar is slotted to receive the axle supports, which are rounded to the shape of the axle and keep it from rolling off. They are held by pins which pass through one of the four holes, and in this way provide for the different diameters of drivers.

TESTING MACHINE FOR BOYER SPEED RECORDERS.

An outline of a machine that is used to calibrate and test Boyer speed recorders is shown in Fig. 2. It was originated by the tool room foreman at Galion, being constructed with a friction disc to give the varying speeds. The disc *A* is held in a wrought iron frame and is driven by an 8-in. pulley *B*. A 5-in. friction wheel *C*, which is made up of a leather disc between two plates,

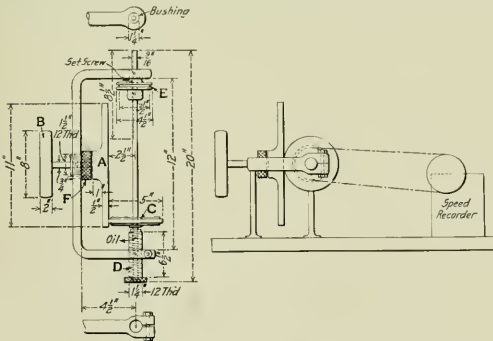

Fig. 2—Speed Recorder Testing Machine.

is rigidly fastened to the shaft that rotates in the arms of the frame. This shaft is free to slide in its bearings, the lower end of the shaft, as shown in the illustration, being held in the screw bearing *D* by two collars. This bearing is threaded in the frame and by screwing it in or out the friction wheel is moved over the disc, thus regulating the speed of pulley *E*, which drives the

speed recorder. When the correct speed has been attained this bearing is clamped, as indicated by the split end on the frame, to prevent the shaft from working in or out. The pulley *E* is free to slide on the shaft and is driven by a set screw through its hub, which has a sliding fit in the keyway in the shaft. It is held in position by two collars, one formed by the machine itself and the other by an arm fastened to the base. The friction pulley is held in the screw bearing *F*, which regulates the bearing pressure between the disc and the friction pulley *C*. This bearing is kept from rotating by a pin which extends through it and the frame. The machine is driven in this specific case from an emery wheel by a $1\frac{1}{4}$ -in. belt, with which a speed of from one to 100 m. p. h. may be obtained. The machine runs smoothly and gives very good results, showing no vibration of the pen on the recording chart.

DEVICE FOR PRESSING IN HOSE CONNECTIONS.

The device shown in Fig. 3 is used for applying the coupling connections to blower hose, washout hose, pneumatic tool hose, etc. It is made up of two 5-in. blocks drilled out a little smaller

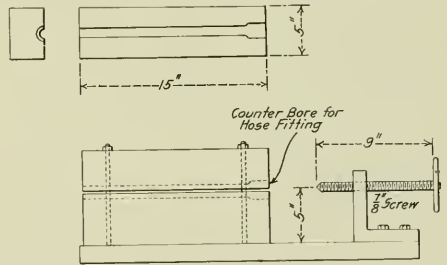

Fig. 3—Apparatus for Pressing in Hose Connections.

than the hose so as to firmly grip it. One end is counterbored to allow for the expansion of the hose when the connection is forced in by the $\frac{7}{8}$ -in. screw operating in the angle support. This device is used on hose from $\frac{1}{2}$ in. to $2\frac{1}{2}$ in. in diameter with good results. The two blocks are clamped together by a $\frac{3}{8}$ -in. stud located at each corner, and there is very little chance of the hose slipping.

JIG FOR SPLITTING ARCH TUBE PROSSERS.

The jig shown in Fig. 4 is used for splitting arch tube prossers. It consists of the mandrel *A* and the two blocks *B* and *C*,

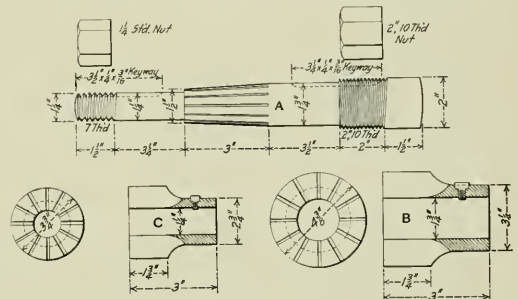

Fig. 4—Jig for Splitting Arch Tube Prossers.

which are split as shown and act as guides to the saw used for cutting the prosser. The mandrel is made with a tapered sec-

tion to correspond to the taper in the prosser, and the latter is forced on lightly to insure an even bearing. The guide block *B* is placed on the large end, and *C* on the small end of the mandrel. Both are held by a set screw key which slides in the keyways shown so that the slots will be in line with each other. After the prosser has been placed on the mandrel, these split guides are forced against the end of it by their corresponding nuts, gripping the prosser firmly between them. The work is done on a milling machine with a $\frac{3}{32}$ in. saw, and the same jig can be used to make 2-in. prossers as well.

FILTER FOR SHOP DRINKING WATER

BY PAUL R. DUFFEY

A very simple and efficient filter, having a capacity of about 30 gals. per hour under ordinary conditions, is shown in the illustration. It consists of a cast iron body and head, a wrought iron yoke for holding the head in place, a screw for the yoke, a rubber gasket, a rod for holding the filter stone and a suitable composition stone.

A very good filter stone may be purchased, or one which gives satisfactory results may be made of a good grade of fire clay. In making a stone, a set of molds of the size required are set on a smooth ramming board. A sufficient amount of fire clay and water is then mixed until the mass has the consistency of

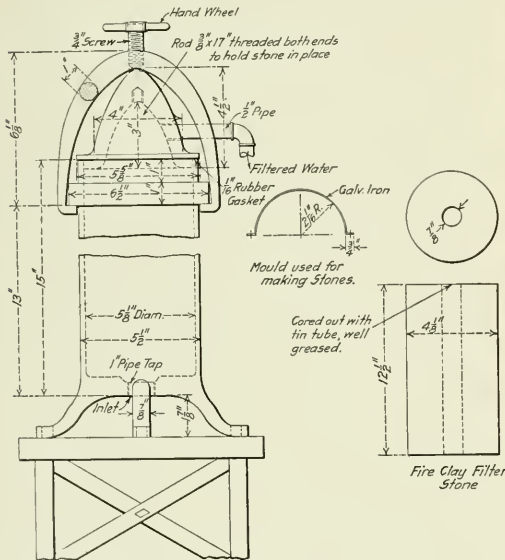

Filter and Filter Stone for Shop Drinking Water.

dough, when the molds are filled and the material is rammed until no open spaces are left. The stone should then be placed in a warm place for several days till it hardens sufficiently to permit the removal of the forms, when it is placed in a suitable kiln and baked until the desired degree of hardness is reached.

When the filter is in use, water enters at the bottom inlet pipe and passes upward between the inside wall of the filter body and the outside of the stone. The water before passing out at the top must work its way through the stone, thus leaving the sediment on the outside face of the latter, which should be cleaned frequently.

PREPARING HARD GREASE FOR JOURNAL BOX CELLARS

BY H. E. BLACKBURN,

Apprentice Instructor, Erie Railroad, Dunmore, Pa.

In preparing the grease cakes for driving and truck box cellars with the device illustrated, a wooden former of the correct radius is placed in the cast iron box and supports the perforated plate. The grease is then placed above the perforated

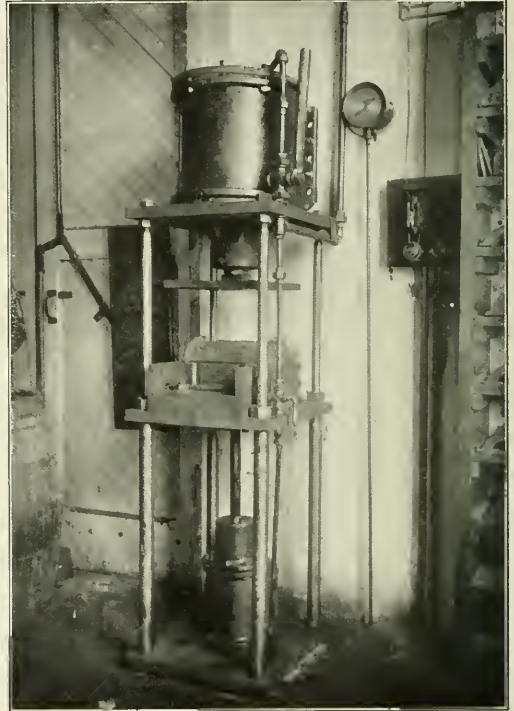

Device for Filling Hard Grease Cellars.

plate and rammed down by the square plate on the piston rod of the driver brake cylinder. When the cake is formed to the required size it is ejected from the box by means of a ram on the piston rod of the 6 in. brake cylinder shown at the bottom of the apparatus.

CONCRETE REFLECTORS.—Concrete reflectors are to be used in the lock chambers of the Pedro Miguel Lock of the Panama Canal in preference to the enamelled steel reflectors, the choice being determined by the lower price of the former, by the more suitable light distribution effected, and by the restricted head room which prevents the use of projecting fittings.—*The Engineer*.

OCTOBER ANTHRACITE SHIPMENTS.—The total shipments of anthracite coal from Pennsylvania in October were 6,665,321 tons, as against 6,338,194 tons in October, 1912, a decrease of 327,127 tons. The amount of coal on hand at tidewater shipping ports increased 25,418 tons, from 577,805 tons on September 30, to 603,223 tons on October 31. The total shipments of anthracite coal in the first ten months of 1913 were 57,620,079 tons.

GRINDING WHEELS AND THEIR USE

First Prize Article in the Competition on Grinding. Instructions for Selection, Care and Use.

BY WALTER R. HEDEMAN

In a large railroad shop it is most advisable to make a careful study of the material, size and shape of grinding wheels and to ascertain the best combination for each class of work. The results can be put in the form of a set of instructions and reference tables for the guidance of all concerned.

In one of the largest railroad locomotive and car repair shops of the country, a study of this kind was made with the results shown in the accompanying table. This table permits the proper wheel for any class of work to be readily obtained and, in connection with the instruction pamphlet, has resulted in a surprising improvement in the quality of work performed on these machines and a very great saving in time.

It will be seen in the table that grinding wheels are used in practically all the different shops. They have been installed in both the iron and brass foundries where they are used to grind castings on which no finish has been allowed; also in the blacksmith shop, where they are used to grind the flash off of machine-made forgings. In the pattern shop considerable work which was previously done by filing is now done on an emery wheel, and of course in the machine shop, piston rods, valve stems, and guides, as well as a large amount of work which was formerly done by hand filing are now finished on grinders.

The instructions prepared cover the purchase and care of all abrasive grinding wheels, and are as follows:

Size and Grade: Size, shape and grade of wheel is to be determined by the machine on which it is to be used and the work to be done.

The grade is to be selected in accordance with the following table and the scale shown on page 665:

Class of work.	Grade letter.	Wet or dry grinding.
Brass castings (large).....	G+ to H	Dry
Brass castings (small).....	H to I	Dry
Car wheels.....	G+ to I+	Dry
Cast iron.....	F to H	Dry
Drop forgings.....	G+ to H+	Dry
Wrought iron.....	H+ to H	Dry
Steel castings.....	G+ to H	Dry
Toot steel (hardened).....	I to J	Wet or dry

Test of Wheels Before Mounting: All grinding wheels are to be tested before mounting by tapping lightly with a hammer; if the wheel does not ring with a clear tone, it should not be used.

Preferred Sizes: Wherever possible, the diameter and thickness of wheel should be in accordance with the following table (sizes marked with a star to be given special preference):

New wheel.			Take off			
Diam. In.	Thickness In.	Diam. of shaft. In.	R. P. M.	Surface speed. Ft. per min.	Wheel at diam. In.	Diam. flanges. In.
8	1½	¾	2,865	6,000	5	4
12*	2	1	1,910	6,000	8	6
18*	3	1¾	1,273	6,000	12	9
24*	4	2	955	6,000	16	12
30*	4	2½	764	6,000	18	15
36*	4	3	637	6,000	24	18

Speed: The maximum surface speed of grinding wheels must in no case exceed 6,000 ft. per minute.

The maximum surface speed should be not less than 3,600 ft. per minute.

Arbor Holes: The arbor holes in all grinding wheels should be at least .005 in. larger than standard size of the spindle; in no case should a grinding wheel be forced on the spindle.

Flanges: The standard flanges for grinding wheels are given in one of the illustrations. The diameter of flanges is to be not less than one-half the diameter of the wheel. Flanges are to be recessed and have a true bearing on the wheel at the outer edge of flanges only. Inside flanges are to be keyed on the shaft.

Grinding wheels must never be run without the proper size of flanges.

Compressible Washers: Compressible washers of pulp, rubber, or leather, slightly larger than the flanges, must be placed between the grinding wheel and both flanges, to distribute the pressure evenly when the flanges are tightened up.

Tightening Flanges: Flanges are to be tightened only enough to hold the wheels firmly. Never apply any unnecessary force. A man with a 2-ft. wrench can exert a pressure of 1½ tons on a

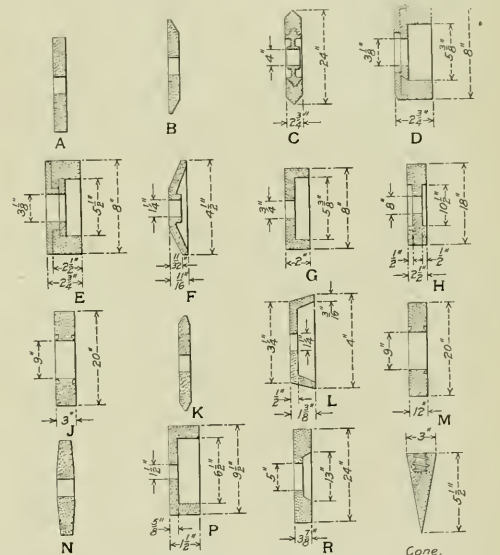

Shapes and Identifying Letters as Given in the Second Column of the Table on the Next Page.

wheel having a 1½-in. spindle. This is sufficient to break any grinding wheel.

Speed Table: The number of revolutions per minute of the spindle, for the different diameters of grinding wheels, is to be in accordance with the following table:

Diameter of wheel. Inches.	Minimum R. P. M. for a surface speed of 4,000 ft.	Standard R. P. M. for a surface speed of 5,000 ft.	Maximum R. P. M. for a surface speed of 6,000 ft.
1.....	15,279	19,099	22,918
2.....	7,639	9,549	11,459
3.....	5,093	6,366	7,639
4.....	3,820	4,775	5,730
5.....	3,056	3,820	4,584
6.....	2,546	3,183	3,820
7.....	2,183	2,728	3,274
8.....	1,910	2,387	2,865
10.....	1,528	1,910	2,272
12.....	1,273	1,592	1,910
14.....	1,091	1,364	1,637
16.....	955	1,194	1,432
18.....	849	1,061	1,273
20.....	764	955	1,146
22.....	694	868	1,042
24.....	637	796	955
26.....	586	733	879
28.....	546	683	819
30.....	509	637	764
32.....	477	596	716
34.....	449	561	674
36.....	424	531	637
38.....	402	503	603
40.....	382	478	573

Speed Regulation: Countershaft and spindle pulleys are to be arranged to give 6,000 ft. surface speed for the largest grinding wheel used on any particular machine.

When a grinding wheel which has been worn down to such diameter that its surface speed falls below 3,600 ft. per minute, the speed of spindle should be increased to give the small diameter of wheel a surface speed of 6,000 ft. In place of changing the speed of the spindle to suit the diameter of grinding wheels as they wear down, it is preferable, where shop conditions permit, to remove the partly worn wheel to another machine whose

spindle is such that the surface speed of 6,000 ft. may be maintained.

Operators should not be permitted to use grinding wheels until the foreman in charge has ascertained, by use of speed indicator, that the speed is correct.

Safety Stops: To prevent the use of large diameter grinding wheels on machines where the spindle speed is adjusted for small diameter wheels, a safety stop should be placed in some fixed point of the machine, as shown in the illustration.

Notices on Machines: Each machine is to have a notice hung

* SIZE, SHAPE, USE, ETC., OF GRINDING WHEELS.

Wheel No.	Shape. (See Outside diam. In.)	Face. In.	Bore. In.	Number of wheels in service.	Material.	Machine.	Work used on.	Shop.	
1	B	8	1/2	1	Carbondite.	Higley saw grinder.	Cold saws.	Machine.	
2	A	10	1/2	1	Carbondite.	Single floor grinder.	Twist drills.	Machine.	
3	A	12	3/4	5	Carbondite.	B. & S. Universal grinder.	Cutters.	Machine.	
4	D	8	2/4	3 1/2	Emery.	Sellers twist drill grinder.	Drills.	Machine, boiler and erecting shops.	
5	C	24	2 1/4	4	Emery.	Sellers No. 1 tool grinder.	Large tools.	Machine.	
6	E	8	2 1/4	3 1/2	Emery.	Sellers twist drill grinder.	Drills.	Machine, boiler and erecting shops.	
7	A	3	1 1/16	17/32	3	Emery.	Sellers twist drill grinder.	Drills.	Machine, boiler and erecting shops.
8	R	24	3 3/8	5	1	Carbondite.	Norton gap grinder.	Piston rods.	Machine.
9	J	20	3	9	8	Emery.	Springfield wet tool grinder.	Large tools.	Machine, boiler, axle shops and brass foundry.
10	A	36	4	24	6	Emery.	Springfield wet tool grinder.	Large tools.	Machine, erecting shops and car repairing department.
11	A	12	2	1	16	Emery.	Double floor grinder.	Tools, small castings and general use.	Machine, erecting, boiler, pattern shops, brass foundry and pass. car dept. polishing room.
12	A	12	3/8	1	1	Carbondite.	Double floor grinder.	Small tools.	Machine.
13	A	12	3/4	5	1	Carbondite.	Morse Universal grinder.	Tools, pins, etc.	Machine.
14	A	6	3/8	1/2	1	Carbondite.	Morse motor attachment.	Tools, pins, etc.	Machine.
15	A	12	3/32	1	1	Ela-tic.	Slack cut-off saw.	Tool steel.	Machine.
16	A	8	1/2	1 1/4	1	Carbondite.	Walker tool grinder.	Surfacing tools.	Machine.
17	K	12	3/8	1	1	Carbondite.	Double floor grinder.	Reading tools.	Machine.
18	L	4	1 1/8	1 1/4	1	Carbondite.	Walker tool grinder.	Tools.	Machine.
19	F	4 1/2	11/16	1 1/4	1	Carbondite.	Walker tool grinder.	Guides.	Machine.
20	M	20	12	9	1	Emery.	Springfield guide bar grinder.	Guides.	Machine.
21	N	20	12	3	1	Emery.	Springfield guide bar grinder.	Guides.	Machine.
22	A	4	6	1	1	Emery.	Swing frame grinder.	Rods.	Machine.
23	A	2 1/2	6	1	1	Carbondite.	Swing frame grinder.	Rods.	Machine.
24	A	7	6	1 1/2	1	Emery.	Swing frame grinder.	Rods.	Machine.
25	A	4	5	1 1/2	1	Emery.	Swing frame grinder.	Rods.	Machine.
26	A	16	3	1	1	Emery.	Swing frame grinder.	Rods, links, brass journals.	Machine.
27	A	2 3/8	4	3/4	1	Carbondite.	Hammitt radius link grinder.	Links.	Machine.
28	A	2	4	3/4	1	Carbondite.	Hammitt radius link grinder.	Links.	Machine.
29	A	1 1/2	4	3/4	1	Carbondite.	Hammitt radius link grinder.	Links.	Machine.
30	A	2	3 1/2	1 1/2	1	Carbondite.	Link radius grinder.	Links.	Machine.
31	A	1 1/2	3 1/2	1 1/2	1	Carbondite.	Link radius grinder.	Links.	Machine.
32	A	1	3 1/2	1 1/2	1	Carbondite.	Link radius grinder.	Links.	Machine.
33	P	9 1/2	1 1/2	1 1/2	2	Emery.	Yankee twist drill grinder.	Drills.	Machine and erecting shops.
34	A	3 1/2	1 1/2	1 1/2	1	Carbondite.	Yankee twist drill grinder.	Drills.	Machine.
35	A	16	2	1 1/8	2	Emery.	Double floor grinder.	Tools, drills and general use.	Smith-shop.
36	A	26	4	2 1/2	1	Emery.	Wet tool grinder.	Large tools.	Smith-shop.
37	A	8	1 1/2	1 1/2	1	Carbondite.	Double floor grinder.	Bolt threading dies.	Bolt shop.
38	A	8	3/4	1 1/4	1	Carbondite.	Double floor grinder.	Bolt threading dies.	Bolt shop.
39	A	24	4	2 1/4	1	Carbondite.	Double floor grinder.	Castings.	Iron foundry.
40	G	8	2	3/4	2	Carbondite.	Mommert, Wolf & Dixon grinder.	Chisels.	Pattern shop.
41	A	3 1/2	1 1/4	1 1/4	1	Carbondite.	Mommert, Wolf & Dixon grinder.	Gauges.	Pattern shop.
42	A	3 1/2	5/16	1 1/4	1	Carbondite.	Mommert, Wolf & Dixon grinder.	Gauges.	Pattern shop.
43	A	3 1/2	3/8	1 1/4	1	Carbondite.	Mommert, Wolf & Dixon grinder.	Gauges.	Pattern shop.
44	A	3 1/2	7/16	1 1/4	1	Carbondite.	Mommert, Wolf & Dixon grinder.	Gauges.	Pattern shop.
45	A	3 1/2	1/2	1 1/4	1	Carbondite.	Mommert, Wolf & Dixon grinder.	Gauges.	Pattern shop.
46	Cone	3	5 1/2	1 1/2	1	Carbondite.	Mommert, Wolf & Dixon grinder.	Gauges.	Pattern shop.
47	A	26	1 1/2	6	1	Emery.	Woods knife grinder.	Flaner knives.	Planing mill.
48	B	10	1 1/2	15/16	1	Carbondite.	Covel saw grinder.	Wood saws.	Planing mill.
49	B	10	3/8	15/16	1	Carbondite.	Covel saw grinder.	Wood saws.	Planing mill.
50	A	10	1/4	15/16	1	Carbondite.	Covel saw grinder.	Wood saws.	Planing mill.
51	H	18	2 1/2	8	1	Emery.	Bridgeport No. 6 comb. tool grinder.	Wood tools.	Planing mill.
52	A	18	2 1/2	1 1/2	1	Emery.	Bridgeport No. 6 comb. tool grinder.	Wood tools.	Planing mill.
53	A	12	1 1/2	1 1/2	1	Emery.	Bridgeport No. 6 comb. tool grinder.	Wood tools.	Planing mill.
54	A	12	1 1/4	1 1/2	1	Emery.	Bridgeport No. 6 comb. tool grinder.	Wood tools.	Planing mill.
55	A	12	1	1 1/2	1	Emery.	Bridgeport No. 6 comb. tool grinder.	Wood tools.	Planing mill.
56	A	12	3/4	1 1/2	1	Emery.	Bridgeport No. 6 comb. tool grinder.	Wood tools.	Planing mill.
57	A	12	3/8	1 1/2	1	Emery.	Bridgeport No. 6 comb. tool grinder.	Wood tools.	Planing mill.
58	A	12	3/4	1 1/2	1	Emery.	Bridgeport No. 6 comb. tool grinder.	Wood tools.	Planing mill.
59	A	8	1	1 1/2	1	Emery.	Double floor grinder.	General use.	Test department.
60	A	8	3/4	1 1/2	1	Emery.	Double floor grinder.	General use.	Test department.
61	A	8	1/2	1 1/2	1	Carbondite.	Double floor grinder.	General use.	Test department.

directly in front in plain view of operator as shown in the illustration.

Dressing Wheel: Keep the wheel running true by frequent dressing. This should be done at least once each week. Work-

GRADE SCALE

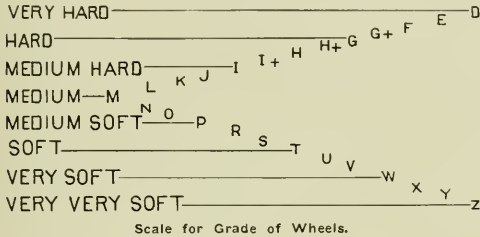

men are to notify the foreman when a wheel needs dressing.
Care of Journals: Journals should be carefully adjusted to prevent vibration. If not carefully watched, lost motion will ruin the journals and burst the wheels. Journals should be kept well lubricated to prevent running hot, as the expansion of the spindle may burst the wheel.

Protection Hoods: All grinding wheels over 8 in. diameter

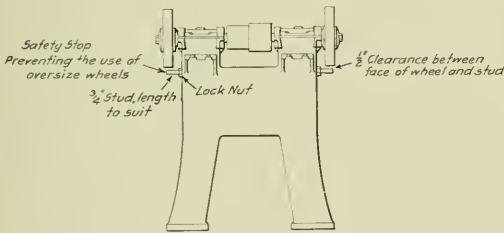

Safety Stops to Prevent the Use of Wheels That Are Too Large.

must be protected by suitable hoods made of either cast iron or steel plates to cover sides and edges of wheel, except at working points, as is shown in one of the illustrations.

Protection Shields: Glass protection shields should be used wherever possible. A leather spark brush can sometimes be used instead.

Use of Wheels Without Hoods: When it is necessary to use

SAFETY FIRST

MACHINE NO. -----

SPINDLE REV. PER MINUTE -----

DIAMETER OF NEW WHEEL ----- INCHES

TAKE OFF WHEEL AT ----- INCHES

NOTIFY FOREMAN WHEN WHEEL NEEDS DRESSING.

This notice to be placed on all grinding machines. Letters white on red back ground. Painted on tin, at least 7x12". Letters at least 3/8" in height with 3/8" spacing between lines.

Notice to Be Hung on Machines.

grinding wheels over 8 in. in diameter without protection hoods, the maximum amount of wheel that should project beyond the edge of flange is 2 in. This will necessitate the use of several sizes of flanges as the wheels wear down.

Use of Wheels: Always use the face of grinding wheels, for grinding any kind of work.

Rests: All rests must be kept adjusted as close as possible to the wheel, and should not be more than 1/4 in. away from it.

Use of Goggles: When it is not practicable to use protection shields, all grinding wheel operators should be required to wear goggles.

Wet Grinding: Grinding Wheels used in wet grinding must never be left over night partly immersed in water.

Rules for Calculating Speed and Diameter of Pulleys: Speed of grinding spindle being given to find the proper speed for the

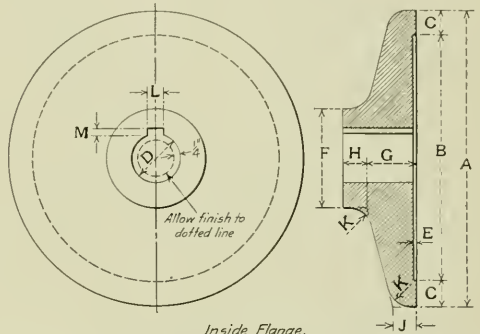

Inside Flange.

Diameter of Wheel	A	B	C	D	E	F	G	H	J	K	L	M
8"	4"	3 1/2"	7/16"	3/4"	1/16"	1 1/2"	3/4"	3/8"	3/8"	3/8"	3/32"	3/32"
12"	6"	5"	1/2"	1"	1/16"	2"	1"	1/2"	1/2"	1/2"	5/16"	7/64"
18"	9"	7 1/2"	3/4"	1 1/2"	3/16"	3 1/2"	1 3/4"	3/8"	3/8"	7/8"	7/16"	5/32"
24"	12"	10"	1"	2"	1/16"	4"	2"	1"	1"	1"	1/2"	5/32"
30"	15"	12 1/2"	1 1/2"	2 1/2"	3/8"	5"	2 1/2"	1 1/4"	1 1/4"	1 1/4"	3/8"	3/16"
36"	18"	15"	1 1/2"	3"	1/8"	6"	3"	1 1/2"	1 1/2"	1 1/2"	1/4"	5/32"

** Bore Flange to Suit Shaft to Which Applied.*

Recommended Inside Flange.

countershaft: Multiply the number of revolutions a minute of the grinding spindle by the diameter of its pulley, and divide this product by the diameter of the driving pulley on the countershaft.

Speed of countershaft being given to find the diameter of pulley for the line shaft: Multiply the number of revolutions a minute of the countershaft by the diameter of the tight and loose pulleys,

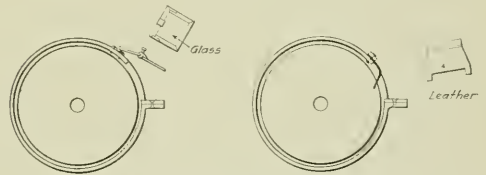

Protection Shields for Grinding Wheels.

and divide the products by the number of revolutions a minute of the line shaft.

The speed of countershaft being given to find the diameter of pulley to drive the grinding spindle: Multiply the number of revolutions a minute of the grinding spindle by the diameter of its pulley, and divide the product by the number of revolutions a minute of the countershaft.

General principle used to determine speeds in diameters: The diameter of any driven pulley multiplied by its speed always equals the diameter of the driving pulley multiplied by its speed.

To find the surface speed in feet per minute of any grinding

wheel: Divide the number of revolutions of the wheel by 12, and multiply the result by 3.1416 times the diameter of the grinding wheel.

Accident Prevention: It is the desire of the management to reduce the number of accidents to a minimum, and it will be the duty of master mechanics and foremen to personally see that these instructions are strictly carried out in connection with all grinding wheels under their supervision.

Report of Accidents: In addition to any instructions covering

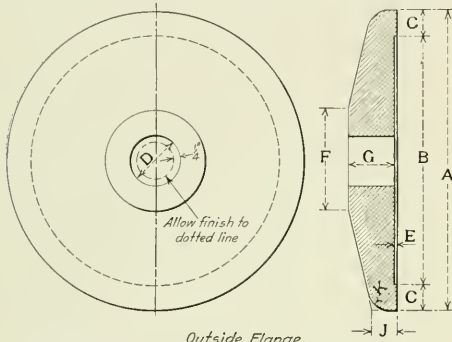

Outside Flange.

Diameter of Wheel	A	B	C	D*	E	F	G	J	K
8"	4"	3 1/8"	7/16"	3/4"	1/16"	1/16"	1 1/2"	3/8"	3/8"
12"	6"	5"	1/2"	1"	1/16"	2"	1"	1/2"	1/2"
18"	9"	7 1/2"	3/4"	1 1/2"	1/16"	3 1/2"	1 1/2"	7/8"	7/8"
24"	12"	10"	1"	2"	1/16"	4"	2"	1"	1"
30"	15"	12 1/2"	1 1/4"	2 1/2"	1/16"	5"	2 1/2"	1 1/4"	1 1/4"
36"	18"	15"	1 1/2"	3"	1/16"	6"	3"	1 1/2"	1 1/2"

* Bore Flange to Suit Shaft to Which Applied.

Recommended Outside Flange.

regular accident reports now in force, a complete report of all accidents caused by use of grinding wheels must be made immediately to the office of the mechanical engineer, stating the nature of injury, the probable cause, the speed at which wheel was running, and whether all details of these instructions were carried out.

SHOP OUTPUT*

BY J. H. TINKER,

Superintendent of Motive Power, Chicago & Eastern Illinois, Danville, Ill.

Shop efficiency or output must be based on some uniform method and a great number of things must be taken into consideration before it is possible to fairly compare the output of different shops. Otherwise there is a possibility of considerable misunderstanding. Suppose a superintendent of motive power compared the output of his shops with the output of the shops of a superintendent of motive power of another road whose figures were not nearly as large, what would the latter do? He would naturally call on his master mechanic or shop superintendent for an explanation as to why he could not do as well as his neighbor. The shop officials would probably be criticized and placed in an embarrassing position while in reality they might be getting 100 per cent. efficiency from the shop and men. If a detailed comparison or some uniform method of showing the output was adopted by these two roads, the output would, no doubt, be on a par with the shop with which the comparison was made.

When making comparisons of this kind the following items

*Abstract of paper presented at the November meeting of the Western Railway Club.

should be considered: The general lay-out of the shops and machinery; the number of men employed in all of the shops (average per pit); the number of pits operated; the average number of machines per pit; the amount of finished stock material; the facilities and method of handling; the class of repairs; the size or tractive power of the locomotives; the organization; and the wage system, whether piece work or day work.

Taking the majority of the above items for a basis to work from, the following statement was prepared showing the number of locomotives turned out of Oaklawn shops, at Danville, Illinois, for the years 1912 and 1913, taking into consideration only classes 1, 2 and 3 repairs:

Month and Year.	MONTHLY EFFICIENCY OF OAKLAWN SHOPS.													
	Class number of repairs.			Total	Tractive power in thousands of pounds.			Total T. P. output per month.	Number of men employed.	No. of men per 1000 lb. T. P. output	Number of pits operated.	Number of engines per pit operated.	Number of men per engine output.	
	1	2	3		1	2	3							
Jan., 1912..	4	11	3	18	119	356	95	570	682	1.19	16	1.20	42.6	37.9
Jan., 1913..	1	5	10	14	32	118	297	447	607	1.35	15	.93	40.4	43.3
Feb., 1912..	6	9	7	22	193	304	200	693	699	1.01	15	1.46	46.6	31.8
Feb., 1913..	2	9	6	17	50	332	197	569	622	1.09	15	1.13	41.4	36.6
Mar., 1912..	4	10	4	18	108	324	109	541	550	1.02	13	1.38	42.3	30.6
Mar., 1913..	1	8	8	17	25	206	281	602	602	1.00	14	1.21	43.0	35.4
April, 1912..	0	1	1	2	0	38	25	63	250	4.00	4	.50	62.5	125.0
April, 1913..	5	6	6	17	156	200	183	542	668	1.23	13	1.30	51.4	39.3
May, 1912..	0	1	4	5	0	15	125	140	265	1.90	4	1.25	66.1	53.0
May, 1913..	6	5	4	15	181	199	105	465	585	1.26	14	1.07	41.8	39.0
June, 1912..	1	3	3	7	25	112	100	237	444	1.87	9	.77	49.3	63.4
June, 1913..	7	4	18	25	149	300	700	620	638	1.16	16	1.12	38.8	34.4
July, 1912..	3	9	4	16	73	276	129	473	712	1.30	19	1.84	37.5	44.4
July, 1913..	6	5	11	22	183	169	457	809	750	0.92	22	1.00	34.1	34.0
Aug., 1912..	7	8	5	20	206	293	188	687	713	1.03	19	1.05	37.5	35.6
Aug., 1913..	6	11	8	25	191	409	383	983	819	0.83	23	1.09	35.6	32.7
Sept., 1912..	4	6	12	22	133	183	76	384	676	1.60	14	.86	44.0	51.3
Sept., 1913..	4	8	13	25	113	269	495	877	825	0.94	23	1.09	35.9	33.0
Oct., 1912..	3	7	5	15	83	226	128	437	572	1.30	13	1.15	44.0	38.3
Oct., 1913..
Nov., 1912..	1	6	5	12	17	183	162	362	572	1.44	12	1.00	43.5	43.5
Nov., 1913..
Dec., 1912..	6	5	7	18	147	173	200	526	566	1.07	13	1.38	43.5	31.4
Dec., 1913..

The following is our repair classification list:

Class 1.—New boiler or fire-box complete, new flues and general repairs to the machinery.

Class 2.—Heavy repairs to the machinery, flues reset, one-half side sheets, new front and back flue sheet, new crown or door sheet, tires new or turned.

Class 3.—Light repairs to the machinery, flues new or reset, tires new or turned.

Class 4.—Covers all repairs not included in Classes 1, 2 and 3, where expenses for labor and material exceed \$125.

Class X.—Covers accident repairs and may be used in connection with Classes 1, 2, 3 and 4, or separately when the repairs made include the damaged parts only.

Any repairs made where the expense for labor and material is less than \$125 are considered "Running Repairs," including new patches on the side of the flue sheet not considered in Class 2 repairs, and new extension front ends not considered under Class 2 repairs.

Class 4 repairs have not been taken into consideration, yet a number of this class of repairs were turned out where the cost would run from \$600 to \$800 on account of the engine meeting with an accident immediately after receiving general repairs and could not be classified otherwise, not receiving new boiler, fire-box or flues. The average number of engines turned out of the shop for Class 4 repairs is about eight per month.

In analyzing the output at the Oaklawn shops it will be noticed that for the month of August, 1913, there is an increase over the corresponding month a year ago of 25 per cent. (43 per cent. increase in tractive power) with only 14 per cent. increase in men employed, 21 per cent. in pits operated and 37 per cent. in engines per pit, with an increase of only a fraction of over 3 1/2 per cent. in the shop payrolls. This increase in output has been accomplished by the methods as later explained.

A shop schedule or accounting system will increase shop effi-

ciency. It has not been tried on our road other than to set an estimated date for the engine to be completed, painting this date on a board and hanging it on the engine, so that each foreman will know when the engine is expected to go out. The work is specialized as much as possible. The shops also get out all finished parts, such as driving boxes, shoes and wedges, flues, etc., for all the roundhouses on the system where there are no machines. All repair parts are furnished from the Danville shops. The back shop forces also handle the repairs to all stationary boilers, pumps, air compressors, etc., on the system, as well as handing derrick cars, Lidgerwoods, steam shovels, gravel spreaders and center plows. In addition, all tools and other machinery are sent to these shops for overhauling. All jacks, air tools, etc., for the entire system are repaired at Danville and the statement shown above includes all men employed. If such employees as handle this special work had been deducted the number of men per pit would be considerably less than that shown.

Efficiency means a great deal more than eliminating lost motion. A man may become so mechanical that he is useless along other lines. The output of a shop depends greatly upon the system of handling, and most any system is good that cuts out lost motion or duplication of work, following the different parts through the various departments, etc. However, the conditions in one shop might be so different from those in another that a system adopted in the one would not be effective in the other.

The following is a synopsis of the movement of an engine through our shops:

1. Engines are reported for the back shop by the division master mechanic for the class of repairs that are needed, and a work report is furnished the superintendent of motive power, covering the general condition of the engine, and he in turn sets the date he is ready to accept the engine for repairs.

2. Engine arrives at shop; if under steam, the fire is knocked out, the cinders dumped and the engine thoroughly blown off by air on the pit before it is taken in the shop. All the tools are removed and stencilled, and are replaced on the engine when it is repaired.

3. The tank is disconnected from the engine and sent to the power house, where the coal is unloaded and used for stationary boiler purposes; it is then turned over to the tank shop for repairs.

4. The engine is thoroughly inspected and all missing, broken or worn out castings are reported to the shop superintendent, who in turn furnishes the store department with material cards covering all the material that is needed to make these repairs. These cards designate where this material is to be delivered, *i. e.*, to what machine, etc. These cards are dropped in a box provided for this purpose, and are gathered by the store department twice each day and the material is sent directly to the machine where it is to be finished, thereby avoiding unnecessary handling.

5. The engine is taken in the shop and stripped, the parts being placed outside of the shop in front of the pit. We have four gains of six pits each in the machine shop. The gang foreman is advised as to the class of repairs the engine is to receive.

6. The gang foreman notifies the stripping gang, which is composed of two machinists and four helpers, as to the amount of stripping the engine is to receive. The stripping gang raises and blocks all engines, cleans all of the work and delivers the different materials to the various shops or special benches where the work is to be done.

7. After the engine has been placed on blocks the steam pipe gang removes the front end, dome cap and stand pipe. The flues are removed and sent to the flue cleaning shed to be repaired; the boiler is also thoroughly inspected for cracks and the flue sheets are examined.

8. All driving boxes are delivered to a special gang, where they are thoroughly inspected and repaired, re-brassed, planed and bored, ready for fitting to the journals. All driving box work is handled in one end of the shop, where the machinery for completing the boxes is located, and the boxes are passed along from one machine to another until finally completed. The gang foreman is then notified that the boxes are ready for fitting and mounting on the wheels.

9. The links and all the motion work are delivered to a special link gang, where the repairs are made so that the parts are completed ready for application to the engine. Special machinery for this work is located near the link gang.

10. All throttle rigging, steam pipes, steam-pipe joints, stand pipes and valves are taken to a special steam pipe gang, where they are thoroughly ground and repaired ready for use.

11. The rods, pins, collars and brasses are all delivered to a special rod gang located near the center of the shop, where the machinery adapted for repairing rods is located. This gang is provided with three air hoists (which cover their entire space) for handling the rods from one bench to another.

12. All wheels are thoroughly inspected; the pins and journals are calipered to determine if they will finish to a special size below the original (which on the axles is $\frac{3}{8}$ inch below original size, and on the crank pins $\frac{3}{16}$ in. below). These wheels are then removed to the quartering machine, where they are examined for the quarter and the stroke; if the pins are found to be out they are removed. If found to be only out of round from wear they are turned true, while on the quartering machine, by a special attachment. We, therefore, have our wheels in perfect quarter and stroke. The rods are all bored to fit the pins. After the wheels are quartered they are removed to the journal turning machine, where all the journals are tried for "true"; if not true they are turned and rolled. We do this work on an old wheel lathe that has been converted into a journal turning lathe by removing one face plate from the machine and using the other face plate for the driving pulley. Both journals are turned at the same time, and then rolled. We feel that our wheels come as near being perfect in quarter and stroke as it is possible to make them. The handling of these wheels is all done with our under-traveling crane, which places the wheels on the different machines.

13. After the wheels and all the material have been removed from the engine, the frames are placed on blocks, where they are thoroughly cleaned and white-washed so that any cracks in them may be detected.

14. Should the engine be in need of a new fire-box, it is taken to the boiler shop, the transfer being made by a transfer table. Another engine, in for general repairs, and which is to be out the same month, is then placed on the vacated pit.

15. All jacket work and pipe work is removed and delivered to the tin shop for renewal or repairs, each piece being stencilled or tagged, designating the engine to which it belongs.

16. All lagging is removed and put in bundles, properly tagged and taken to a shed for safe keeping, to be re-applied when needed. Old or broken pieces of lagging are put in a vat and steamed to a pulp and used again around flexible staybolt caps or places where a large piece of lagging cannot be used.

17. All cab trimmings and injectors are removed and taken to the brass room, to be either repaired or replaced.

18. All steam gages, governors, pops and air pumps are removed and placed in the air room, where they are repaired and tested. The pumps are given a working test before being re-applied. The pops are set by air pressure and tested by a gage. In addition the safety valves are set to the proper pressure upon the boiler, in accordance with the Interstate Commerce Commission requirements.

19. Cab, running-boards and pilot are removed and delivered to the cab department in the tank shop, where proper repairs are made and where they are painted before returning.

20. The engine has now been in the shop a sufficient length of time to have such work as the jaws filed, the spring rigging repaired, the shoes and wedges laid off and the boxes fitted, and the engine is ready to wheel. The engine is raised by an electric crane; the wheels are rolled under it and the shoes, wedges and binders are replaced. In the meantime the flues are being put in the boiler, all the cocks in the cab, and the washout plugs and dome caps applied, all of these being replaced by the time that the flues have been reported ready for test. A boilermaker then inspects the fire-box and boiler in accordance with Interstate Commerce rules and pronouncing the boiler work O. K., the gang foreman orders the lagging, jacket and cab replaced, also all the trimmings, injectors, etc. The rod foreman then applies the main rods so that the rollers can be placed under the engine for setting the valves; after this is done the parallel rods are applied, and the painter foreman is notified that the engine is ready for painting. After being painted, the engine is removed from the back shop to the roundhouse, where the tank is applied, and the roundhouse foreman is notified that it is ready to be fired up for the break-in trip.

21. The engine is turned over to the engine "tamer," who gives it a thorough inspection and breaking-in, reporting any defects or unfinished work to the shop superintendent, who has a special gang to look after this. The engine is then sent out on a break-in trip and if any defects develop the shop superintendent is again notified and sends his force to make the repairs. After these repairs are made the engine is turned over to the division to which it is assigned.

The output of a shop, of course, depends a great deal upon the organization. The operating conditions on the Chicago & Eastern Illinois (like a good many other railroads) the last six or seven years have been very disastrous to the shop organizations. It has been necessary to reduce the forces almost every year and in a great many cases the shops have been closed entirely on account of depression in business, and every time this is done the efficiency of the organization is lost and some of the best mechanics in the country have left the shops on account of the fluctuation in working conditions. In opening up the shops again it has been necessary to hire almost any one that comes along representing himself to be a mechanic. A great number of these men only work a sufficient length of time to get a "stake," which makes a condition that is hard on any kind of an organization. It has been found necessary at times to hire on an average of 25 men a day at the Danville shops in order to keep the force of men at a given number.

Taking it for granted that a man is a good mechanic, he will not develop to 100 per cent. efficiency to the company until he has been in the service a certain length of time, say one or two months, as there will be conditions with which he is not familiar and it takes time to educate him.

In addition, mechanical departments have experienced in the past a great many delays on account of shortage of material. This is not a reflection on the stores department but due to the fact that retrenchments were necessary and they could not order material far enough in advance to prevent shortages when the shops were again opened up.

It would be difficult to estimate the loss to any railroad company due to such fluctuation in working conditions. If the conditions would permit of working the shops uniformly the year around, the railroads would effect a great saving, and at the same time have the power in good condition, or comparatively so, all the time; in this way the mechanical department could figure on a certain number of engines falling due for the shop each month, whereas, during the past several years, the greater proportion of heavy locomotives has been put through the shops during the months of August, September, October, November and December, which in the regular order of events, makes them all fall due about the same time the following year, and this is a condition that works hardships on the mechanical and oper-

ating departments. The necessity of retrenchment curtailing the output of a shop in the summer months, prevents the repairs to other locomotives in the same class, making a shortage of power and congestion, which would make it inadvisable to shop these engines when due. To relieve a situation of this kind, it is occasionally necessary to advance the regular date of shopping to prepare the heaviest power for the service in winter months, and this necessarily increases the maintenance cost, also necessitates engines continuing in service longer than their condition would warrant, probably decreasing the miles run per failure, and unless these conditions are fully considered it is hard to get a fair comparison.

DISCUSSION.

A. R. Kipp, mechanical superintendent, Chicago division of the Soo Line, stated that the size of power and the grades over which the engines operate were features that must be considered when comparing shop output. For this reason the miles run or the ton miles would not be a fair basis on which to compare. He believed that by taking an average tractive effort unit, say 20,000 lbs. for example, and reducing other roads to that unit, that more comparable information could be obtained. If one road had an average tractive effort of 30,000 lbs., their factor would be 1.5, while another having an average tractive effort of 40,000 lbs. would have a factor of 2, and by reducing the output from average tractive effort down to one, the comparison would probably be as near as could be made.

The question was raised as to the method of inspecting crank pins and journal bearings. It was stated that in France this is done by washing the bearing surface carefully with kerosene, and placing the wheels on a track where they are run against each other at a speed of five or six miles an hour. In this way the jar will show the surface cracks by forcing the oil out of them showing a distinct line. It was also stated that in Europe considerable time had been saved in fire-box repairs by having extra sets of complete back ends so that when an engine was shopped for new fire-box sheets the whole back end could be substituted with the one held in stock; the old back end being repaired and held ready for another engine.

Mr. Tinker, in his closing remarks rather questioned the advisability of using any definite unit in comparing shop output, as there were so many different things to be considered, and the practice of the different shops varied to such an extent. He stated that the crank pins on his engines are carefully tested by wiping them with oil, and hitting them on the end with a sledge, believing that they would in this way show up the surface cracks as well as if they were run together, as stated above. Some roads remove the crank pins every five years, but he did not believe this was necessary, as the tests and the calipering would be sufficient test. As regards the replacing of the entire back ends, he stated that he had found this impossible to do, even with engines of the same class and in the same consignment, as they vary to such an extent that no two back ends were exactly alike.

SOAPSTONE PRODUCTION.—The production of soapstone in the United States in 1912 was greater than that of any other country, and also greater than that of all other countries combined, amounting to 25,981 tons.

CHILE AND INTERNATIONAL RAILWAYS.—The Chilean minister of industry recently announced in the Senate that the government would give no facilities for the construction of international railways as long as no commercial treaties between Chile and the neighboring countries existed.

RUST CAUSED BY PAINT.—Among the results of the experiments recently made by the German naval authorities for the purpose of finding some means of preventing the rusting of ships' plates was the discovery that in some cases color intended as a protection actually caused rust.—*The Engineer*.

WALSCHAERT VALVE GEAR GAGES

Accuracy in Machining Parts Will Make Later Setting Unnecessary. Instructions for Checking.

BY C. T. ROMMEL

It is an easy matter to lay out a Walschaert valve gear for each class of locomotive and locate any inherent defect in the design which can then be readily corrected. If after this is done, gages are made it will be possible to so construct the gear that practically no valve setting will be necessary after it is applied to the locomotive. By the use of the gages each man working on any part of the gear does his share toward the correct setting of the valve.

In the system which the writer has perfected, the gages are used for locating the spacing of the ports in the valve bushing, the width and spacing of the valve packing ring, the length of the valve stem and rod, the link, crosshead arm, radius bar, combination lever, union link and the location of the eccentric crank arm. These various gages are shown in the illustration with tables of dimensions as required for various classes of locomotives on the Baltimore & Ohio.

After the gear is assembled on the locomotive and it is known that all the parts for which gages are provided are correct, it only remains to find the correct length of the eccentric rod and of the reach rod which can be done in one revolution of the wheels. This system eliminates any necessity of obtaining centers and will give an absolutely correct steam distribution. It is advisable to place some distinguishing mark on the locomotive indicating that all parts of the valve gear have been made correct with the gages, as in this way any trouble thereafter developing with the valve gear can be easily located and overcome.

In connection with these gages the following simple instructions are all that are required to be issued to the valve setters.

INSTRUCTIONS.

It having been determined that the Walschaert valve gear is finished and assembled according to the gages, the motion will be square and give an equal steam distribution at all points

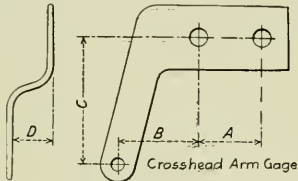

Class	Front.				Back.			
	A	B	C	D	A	B	C	D
A-3	3 3/8	3	1 1/2	4				
E-27B, E-27C	4 3/8	3 3/8	1 1/2	4 1/2				
Q-1, Q-1A, Q-1B, P-1, P-1A	4 3/8	1 1/2	10 1/2	3 3/8				
O-1	3	5 1/2	1 1/2	11				
O	3 3/8	4	3 3/8	2 1/2				
O-0DD	4 3/8	3 3/8	12 3/8	3 3/8	4 3/8	3 3/8	12 3/8	3 3/8
C-16	4 1/2	1 1/2	6 1/2	2 1/2				

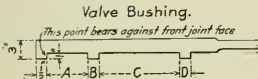

Class	A	B	C	D
A-3	7 1/2	2 1/2	24	1 1/2
E-27B, E-27C	7 1/2	2 1/2	27 1/2	1 1/2
Q-1, Q-1A, Q-1B, P-1, P-1A, P-1B	7 1/2	1 1/2	24	1 1/2
O-1	10 5/8	2 1/2	13 1/2	2 1/2
O	8 3/8	1 1/2	21	1 1/2
O-0DD				
C-16	7 1/2	1 1/2	14 1/2	1 1/2

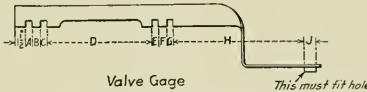

Class	A	B	C	D	E	F	G	H	J
A-3	3 3/8	1 1/2	3 3/8	22	3 3/8	1 1/2	3 3/8	100 3/8	1 1/2
E-27B, E-27C	4 3/8	1 1/2	3 3/8	24 3/8	3 3/8	1 1/2	3 3/8	100 3/8	1 1/2
Q-1, Q-1A, Q-1B, P-1, P-1A, P-1B	4 3/8	1 1/2	3 3/8	22	3 3/8	1 1/2	3 3/8	100 3/8	1 1/2
O-1	3 3/8	1 1/2	3 3/8	16 3/8	3 3/8	1 1/2	3 3/8	33	1 1/2
O	3 3/8	1 1/2	3 3/8	17 3/8	3 3/8	1 1/2	3 3/8		1 1/2
O-0DD									
C-16	3 3/8	1 1/2	3 3/8	13	3 3/8	1 1/2	3 3/8	36 1/2	1 1/2

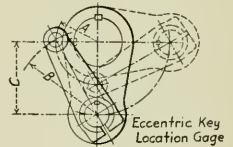

Class	Front.			Back.		
	A	B	C	A	B	C
A-3	8 3/8	1 1/2	13			
E-27B, E-27C	8 3/8	1 1/2	15			
Q-1, Q-1A, Q-1B, P-1, P-1A, P-1B	8 3/8	1 1/2	16			
O-1	7 1/2	1 1/2	16	7 1/2	1 1/2	16
O						
O-0DD	15 1/2	1 1/2	14	15 1/2	1 1/2	14
C-16	6 3/8	1 1/2	12			

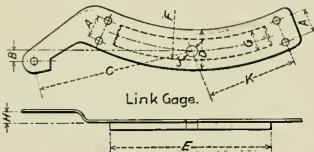

Class	Front.											Back.										
	A	B	C	D	E	F	G	H	J	K												
A-3	3 3/8	8 1/2	25	7	24 1/2	5 7/8	3	0	3 1/2	13 3/8												
E-27B, E-27C	3 3/8	5	26	6	25	6 3/8	2 3/8	1 1/2	3 3/8	14 3/8												
Q-1, Q-1A, Q-1B, P-1, P-1A, P-1B	3 3/8	8	27	34 1/2	5 1/2	3	0	3 3/8	13 3/8													
O-1	3 3/8	6 1/2	24	6	25	6 1/2	2 3/8	1 1/2	3 3/8	12 3/8	3 3/8	6 3/8	24	6	22	6 1/2	2 3/8	1 1/2	3 3/8	14 3/8		
O	3	1 1/2	2 1/2	6	22 1/2	5 1/2	2 1/2	0	2 1/2	12 3/8	3	1 1/2	2 1/2	6	22 1/2	5 1/2	2 1/2	0	2 1/2	12 3/8		
O-0DD	3 3/8	8	24	7	23	7	3	0	3 1/2	13	3 3/8	7 1/2	7	23	7	3	0	3 1/2	13			
C-16	3 1/2	5 1/2	20	7	21	5 1/2	2 1/2	0	3	1 1/2												

Radius Bar.				Combination Lever.				Union Link.	
Class	Front.		Back.	Class	Front.		Back.	Front.	
	A	B			A	B		A	A
A-13	5 7/8	14		A-3	5 7/8	4 1/2		A-3	1 1/2
P-1, P-1A, Q-1	60	13		E-27B, E-27C	4 3/8	4 1/2		E-27B, E-27C	2 1/2
Q-1A, Q-1B	60	13		Q-1, Q-1A, Q-1B, P-1, P-1A	44 3/8	3 3/8		Q-1, Q-1A, Q-1B, P-1, P-1A	10 1/2
E-27B, E-27C	63	9		O-1	50	3 3/8	4 1/2	O-1	23 1/2
O-1	61	10	62	O	40 1/2	3	30 3/8	O	14 1/2
O	52	13	52	O-0DD	49	3 3/8	30 3/8	O-0DD	18
O-0DD	70	11 1/2	57	C-16	35 3/8	3 3/8		C-16	20 1/2
C-16	52	11							

Gages for Insuring Accuracy in Parts of Walschaert Valve Gear.

of cut-off. The object in issuing these instructions is to simplify the work in the shops and at the same time obtain a correct steam distribution.

After the pistons are applied and the front cylinder heads tightened, the striking points are obtained and marked on the guides so they can be easily seen. The main rods are then applied and made of such a length that the clearance will be equally divided on each end of the cylinder. This is very important if the desired valve movement is to be obtained.

After the main rod has been made the proper length the travel marks are also located on the guides. The port marks are also obtained and marked plainly on the valve stem.

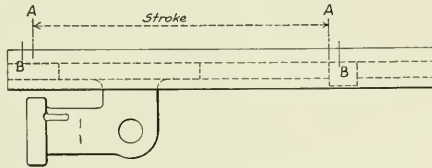
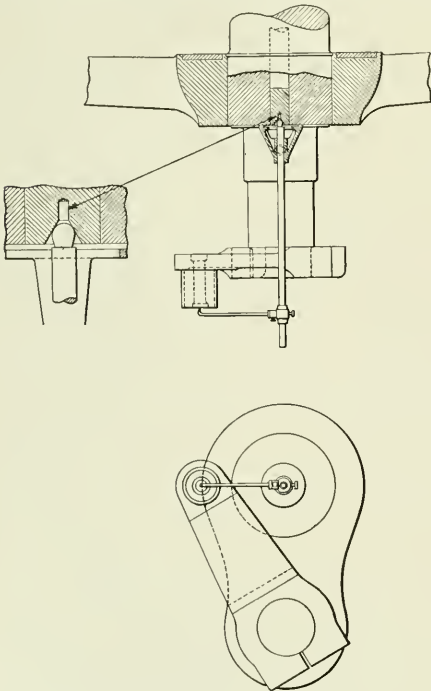

Diagram of Crosshead Travel.

On the diagram of crosshead shown above the travel marks are at A A. The striking points are at B B.

Place the reverse lever in the extreme forward motion and revolve the wheels by moving the engine ahead until the point of cut-off is located at the end of the cylinder then taking



Detail of Gage for Setting Return Crank.

steam. This is obtained by stopping the movement of the wheels at the exact point that the tram cuts the port mark on the valve stem. Measure from the travel mark to the same point on the crosshead from which the travel mark was obtained and note the distance, 22 in. for example. Then revolve the wheels in

the same direction until the cut-off is obtained at the opposite end of the cylinder and assume it is found to be 26 in. This indicates that the cut-off is out 4 in., and as all the parts except the eccentric rod have been gaged and are known to be correct, the next step is to obtain the proper length of the eccentric rod.

The cut-off on one end is 22 in., and on the other 26 in. To make this equal it must be $(22 + 26) \div 2$, or 24 in. Set the crosshead at 24 in. from either travel mark, disconnect the eccentric rod, place the tram on the valve stem, and move the link until the tram cuts the port mark, then measure the distance the link has been moved, which will give the necessary change in the length of the eccentric rod. Have these changes made and no further setting is necessary. Both sides of the engine are gone over in this manner. It is not necessary to go over the back motion.

While the wheels are revolving to obtain the cut-off, the maximum valve travel is also obtained to check up the length of the reach rod. The following table shows the lead, lap and valve travel on the different classes of engines.

AUTOGENOUS WELDING IN LOCOMOTIVE FIREBOXES

BY N. H. AHSIOULH

Autogenous welding has been used in the fireboxes of locomotives with varied degrees of success during the past few years. The difficulty which has been the hardest to overcome, is the fracturing of plates due to the contraction of the cooling parts; the strain produced causes the fracture of adjacent welds or the weld which is cooling. This has been very discouraging and is the primary cause of the very slow progress being made in the application by this method of patches and part sheets to locomotive fireboxes.

It is idle to assume that any flat sheet, stayed rigidly in all directions, can be heated and allowed to cool without leaving a strain in the iron as a result of the cooling off process; much less can we cut a hole of any shape in a side sheet, fit in a flat patch and weld around the four sides successfully. In the few instances where patches of this kind have been considered a success it is because the welded seam was strong enough to withstand the strain. Sooner or later these welds, or the sheets adjacent to them, will show cracks due to this strain. The trend of modern boiler making is toward the making of all parts to fit in their proper places with no unnatural strains anywhere in the boiler. The practice of welding patches and sheets in fireboxes, without means of perfectly compensating for the contraction of cooling autogenous welds, is directly opposed to perfect boiler work. In shops where a study of the means to compensate for this contraction has been made are found the only perfect and successful firebox welds.

In various articles upon this subject in technical journals, the assertion has been made that the success or failure of work of this nature depends entirely on the ability of the operator. In part this is true, but the majority of defective welds are caused by the inability of the workmen to make a patch or a sheet and arrange it for welding, in such a manner that the contraction due to the cooling off process is perfectly compensated for. The writer has had very gratifying success in the application of patches and part sheets to wide fireboxes in oil burning locomotives, operating in alkali water districts, and will endeavor to explain the methods and the preparation of the parts for welding.

Considering first the actual operation of welding, the edges of the sheets are made with a bevel of 60 deg., the bottom edges of the bevels touching, thus giving an opening of 120 deg. This opening is larger than the common practice of 90 deg., for the

reason that the torch flame should be at right angles with the part being heated, and the larger the angle of the opening, the less movement of the torch is necessary to keep it at right angles. This is shown in Fig. 1. To make a successful weld both sides of the V'd portion must be heated uniformly with the flux; this is almost impossible with a 90 deg. opening. This can be proved by breaking such a completed weld when it will be noticed that the flux has fused with only one side of the part, to within approximately 1/8 in. from the face of the sheet,

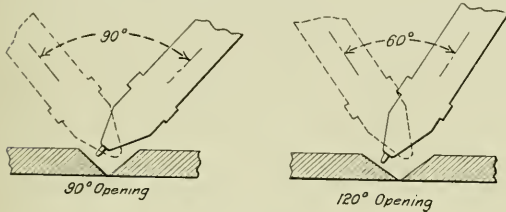

Fig. 1.

and the weld is perfect for the remaining 1/8 in. to the face of the sheet. This is caused by the fact that the nearer the face of sheet, the greater the angle of opening becomes as the weld is made; the greater the angle of opening, the more perfect the weld is. The practice of reinforcing welds in many shops, is proof of the foregoing assertion; this method is to build up the weld 1/8 in. to 1/4 in. higher than the face of the sheets adjacent to it. The writer is making perfect welds from the bottom of the V'd parts and finds no reinforcement is necessary where the sheet is welded the full thickness using a 120 deg. opening.

In the operation of welding, the torch flame is rotated in the bottom of the V'd part, heating both sides uniformly until the

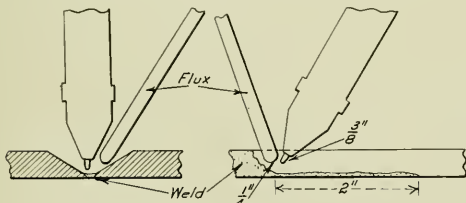

Fig. 2.

metal melts and the edges are fused. Care must be exercised so that the radius of the action of the flame is confined to the very edges of the beveled portions. This is repeated until about 2 in. of the bottom of the V'd part is fused; the stick of flux material, which is 1/4 in. round Swedish iron is then brought into play and is held adjacent to the torch flame and allowed to heat uniformly with the sheet; the distances are shown in Fig. 2. When the sheet and flux are heated to the proper amount the flux is placed against the heated sheet and the flame is moved along the sheet slowly for the 2 in. distance, the stick of flux



Fig. 3.

following the flame and melting off enough iron to cover the previously welded portion 1/16 in. thick. The stick of flux is then removed for a few seconds while the burner is slowly moved back over the added material and the edges A', Fig. 3, are smoothed over and welded to the V'd out part. The oper-

ation of adding metal is repeated successively for the 2 in. distance, Fig. 3, until the welded portion is flush with the sheet, and the succeeding 2 in. distances are welded in the same manner. As the flame will heat the metal to the proper consistency only 1/16 in. deep, care is necessary so that only 1/16 in. is added at a time. The operation of adding only 1/16 in. in conjunction with the heating of the metal to the proper consistency, is the secret of successful autogeneous welding. As the metal gradually heats it approaches the consistency of wax, having a glassy appearance, and this is the proper time to fuse the stick of flux and the sheet; this point is reached just a moment before the metal begins to run. Many operators make the mistake of heating the iron beyond this point to one at which oxidization takes place and little white particles of slag can

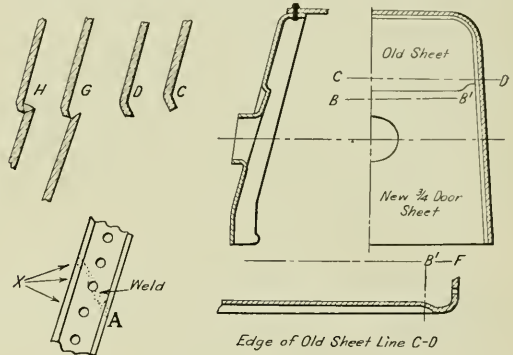

Fig. 4.

then be seen floating in the molten metal; these are the cause of pinholes in the weld after cooling.

A method by which an operator can determine the proper degree of heat at which to fuse the flux and sheet is to make an experimental weld directly overhead, in which case if the sheet is heated too much the iron will melt and drop. By practicing in this manner, successful welds can be made without heating the metals to a temperature which is too high. When heating, it must be borne in mind that the sheet must be at the proper temperature before the metal of the flux is fused with it. The burner flame should be directed on the sheet 1/4 in. ahead of the moving stick of flux, to prevent the metal in the

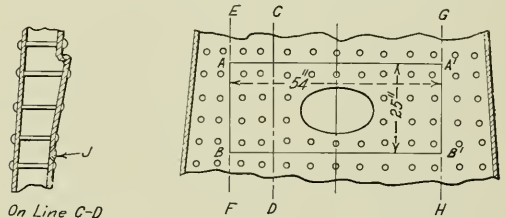

Fig. 5.

flux coming in contact with the sheet when the latter has not the proper degree of heat. On account of the metal in the stick heating more rapidly than the metal in the sheets, it has a tendency to run off on the sheet before the latter has become hot enough to fuse properly. This is a common fault and can be proved by breaking any weld which has proved defective in service; the metal will show in layers which are not fused, proving that the stick was too hot and the metal in the sheet too cold.

The patches and sheets illustrated are all in successful serv-

ice, and have been given no attention whatever since leaving the shop; a large number are in oil burning fireboxes. A door sheet is shown in Fig. 4. This sheet was applied to a wide firebox boiler to change it from two door holes to one. The old sheet was ripped above the door holes and removed, and the side flanges were ripped diagonally as at *A*. The edge of the old sheet from *B* to *B'* was heated by using a flange dog; a 1 in. flange was turned at an angle of 60 deg., as shown at *C*; the edge of the flange was chipped as shown at *D*, and the sides of the new door sheet were heated and set back from *B'* to *F*, thus allowing the sheet to fit along the edge of the flange *D* and also keeping the side flanges lined up properly. From *B'* to *F* and across on the face of the flange *A* the sheet was V'd out on the fire side to a 120 deg. opening, and from *B'* to *B* it was chipped as shown at *G*, this being a reverse bevel.

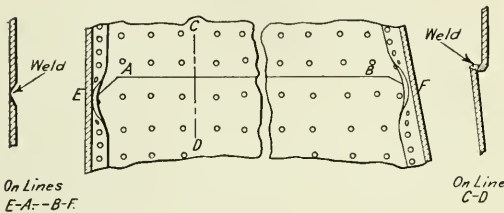

Fig. 6.

From the flange *A* to *B* it was welded on the right and left sides, and from *B* to *B'* was welded as shown at *H*. In this firebox, as no gas was available immediately after the sheet was fitted up and ready to weld, the mudring rivets, flange rivets except those marked *X* and the ashpan work were all finished before the welding of the seams was started. There were no leaks during the hydrostatic test, and none in the door sheet after the locomotive was in service.

A patch on a door sheet which was changed from two door holes to one is shown in Fig. 5. The door sheet was ripped around the two door holes, as shown, and the edge of the opening *A*, *B*, *A'*, *B'* was flanged at 60 deg. and chipped as at *D*, Fig. 4. From *B* to *B'* the edge *J*, Fig. 5, was chipped at an angle of 60 deg.; the perpendicular flanges at *B* and *B'* were

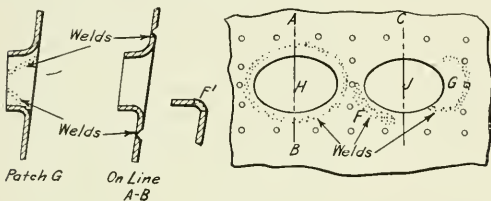

Fig. 7.

tapered from 2 in. above the bottom to meet the sheet flush at the corners. The bottom edge of the patch was chipped at 60 deg. bevel, opening toward the fire, the sides and top being chipped a reverse bevel and fitted up as at *G*, Fig. 4. The first welding was done from *B* to *B'*, raising the patch 1½ in. at *B* to allow for the contraction as the weld cooled. From *B* to *A* was next welded; then from *B'* to *A'*, from *A* to *A'* was welded last. As the opening in the backhead sheet was ripped the same size as in the firebox sheet, the water side of this patch was welded except from *B* to *B'*; this served the purpose also of annealing the previous weld on the fire side. This was a perfectly welded patch, showing no leaks at the hydrostatic test nor in service since.

The renewal of three-fourths of a side sheet is shown in Fig.

6. The old sheet was ripped, leaving 3 in. of each end under the flue and door sheet flanges as shown. One inch of the edge of the old sheet from *A* to *B* was flanged out toward the fire at an angle of 60 deg. and chipped as at *D*, Fig. 4. The flanges of the flue and door sheets were heated and turned at *F* and *E*, to facilitate the operation of welding the ends of the side sheet seam. The new side sheet was laid out and all the holes punched, and the sheet chipped with a reverse bevel from *A* to *B*; the bevel was chipped on the fire side from *E* to *A* and from *B* to *F* and these, being flush welds, were made first. The flanges of the flue and door sheets were heated and turned to their original positions, covering the flush welds. The rivets in the flue sheet and door sheet flanges were next applied and the seams calked; the mudring rivets were applied, and while the work of applying the ashpan was in progress, the weld from *A* to *B* was made; the staybolts were applied last. At the hydrostatic test no leaks developed, nor have there been any in service.

The door sheet shown in Fig. 7 had two door holes, and the one marked *H* had 27 cracks in the knuckle of the flange; an entire door collar was welded in. The weld was 1½ in. from the flange, this short distance compensating for the contraction while cooling. Door hole *J* had ten cracks 1 in. long in the knuckle at *F*. This knuckle was V'd out 1½ in. wide at the top and ¼ in. wide at the bottom, thus removing most of the defective portion of the sheet; the opening was then welded as shown at *F'*. The rivets in the door flange were not removed adjacent to this particular weld. The patch *G* was ripped, as shown in the drawing, using diagonal seams across the flange. This patch was welded with a flush weld, its nearness to the knuckle of the flange compensating for the contraction while cooling, and the diagonal seam compensating for the contraction on the flange. There were no leaks either in the hydrostatic test or in service.

These illustrations cover a wide range of patches or sheets, which could be placed in any firebox. In all of them the contraction of cooling welds is compensated for, either by the location of the patch, by the method of turning out the edges, or by diagonal seams across the flanges. The writer has applied very many more patches and part sheets than those referred to in this article, having only shown enough here to illustrate the methods common to all of this class of work in locomotive fireboxes. All work is tested out with a 10 lb. sledge, and also, wherever possible, by pouring kerosene on one side of the weld in the evening; if the weld is defective the kerosene will be through to the other side of the sheet in the morning. Many failures were experienced while attempts were being made to weld patches in the same plane as the sheet. Since adopting "box" weld to compensate for contraction, perfect results have been the rule, there never having been a leak nor a failure of any sort in this kind of weld.

CHANGES IN AN OLD BRIDGE.—To accommodate electric power cables which will cross the river Seine on the 300-year-old Pont Neuf, Paris, a trench 4 ft. wide and 7.5 ft. deep is being cut through the solid masonry and flint rock concrete of the bridge structure.—*The Engineer*.

CONTINUOUS BRAKES IN ENGLAND.—As yet the only freight trains in England which are equipped with continuous brakes are what are known as "piped goods," consisting of insulated cars or "wagons." These trains run at a high speed, and their loading is therefore limited.

RAILWAYS AND CANALS.—Canals are necessarily inferior to railways as a means of transport, because their capital cost is higher, their carrying capacity is smaller, they only cater for low-class goods in bulk, and they can only reach the ultimate point of production or consumption by the supplementary use of wagons or railway cars.

NEW DEVICES

LINK SIDE BEARING TRUCK

It is claimed by a number of experts on car design that it is advisable to abandon the loaded center plate scheme in car construction, thereby eliminating truck bolsters and center plates, and to carry the load at four points directly to the truck side frames. These men state that it is useless trying to balance a

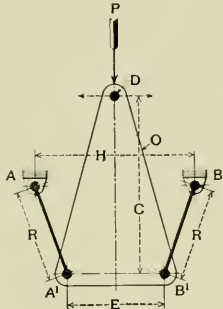

Fig. 1—Diagram of Link Side Bearing.

load of 100,000 to 200,000 lbs. on two central points at each end of the car and on an area so small that a lubricant is hard to retain even were they lubricated. This feature, as well as for avoiding all trouble with side bearings, has led to the design of

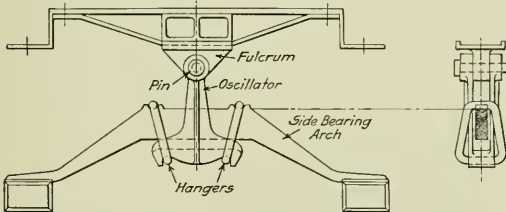

Fig. 2—Application of Link Device to Six-Wheel Truck.

trucks which support the load of the car by links or similar construction on each side frame.*

Fig. 1 illustrates the general principle of a link motion device of this type that has been designed by A. Stoikowitz, of Mont-

*For description of the Summers side bearing truck see *American Engineer*, April, 1912, pages 193 and 194.

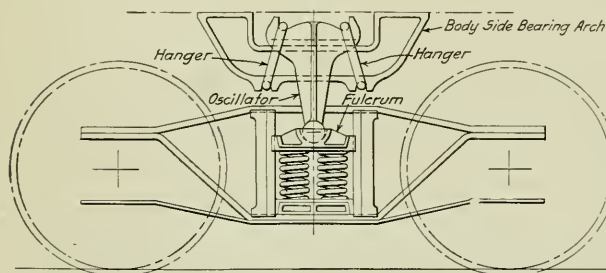

Fig. 3—Standard Truck With Weight of Body Transferred Through the Side Bearings.

real, Que. *A* and *B* represent fulcrum points for the links *R* which support oscillator *O* at points *A'* and *B'*. Point *D* will travel on a straight line, when certain approximate proportions between the dimensions *R*, *H*, *E*, and *C* are met. The movement of point *D* denotes the side bearing travel which is comparatively small, and as the angular movement of the pivot points is correspondingly small and lever *C* is greater than *R*, the frictional resistance resulting from these points will be small and can be safely neglected. As the load is being carried on what might be called a floating support, the oscillator *O* provides for a nearly frictionless horizontal and radial truck movement on a curve (Figs. 2 and 3), while the links or hangers *R* also allow sufficient lateral movement of the car body, as is the case in a swing motion truck. Furthermore if *D* is pivoted

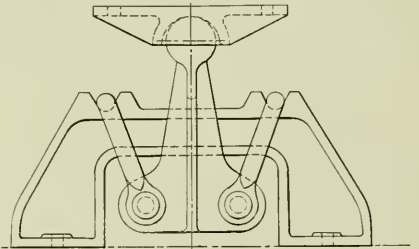
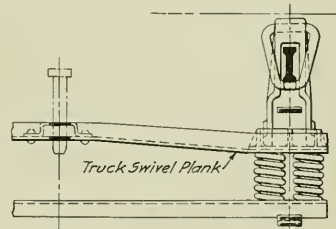

Fig. 4—Link Principle Applied to Ordinary Side Bearing.

to its fulcrum by a pin, it will form an effective anti-telescoping device, as, in case of an accident, it will prevent the cars being lifted from their respective trucks.

Fig. 2 shows the application of this device to a six-wheel passenger truck; the oscillator is U shaped and straddles the side bearing arch as shown; the hangers are of the solid link type and engage both the oscillator and the side bearing arch. The anti-telescoping feature is applied by pivoting the top of the oscillator to the side bearing fulcrum by means of a 2 in. pin. This pin is under double shear and would require an enormous force to tear a truck from its body, provided all the details involved are of equal or greater strength.

Fig. 3 illustrates a standard arch bar truck with bolsters and center plates eliminated and the entire load carried by the side bearings only. A truck swivel plank is substituted for the bolster to provide a swivel point for the truck center. The side bearing fulcrums are riveted to the swivel plank and placed over the truck springs, which arrangement transmits the load directly to the side frames. The king pin hole in the swivel plank



is slotted to allow a lateral movement of the car body on the link hangers, thereby embodying the general features of a swing motion truck.

Fig. 4 shows the application of this link motion principle as an ordinary side bearing, which is secured to the truck bolster and intended to replace the common plate or roller side bearing. As dirt has no effect on this side bearing the design can be entirely open; in fact it admits a great variety in the construction of hangers, oscillator or base, depending on the conditions.

In order to prove the theoretical correctness of a bolsterless truck, Mr. Stoikowitz analyzes three cases to which any truck bolster is subjected caused by the different conditions of service. Referring to Fig. 5, there is a clearance between both side bear-

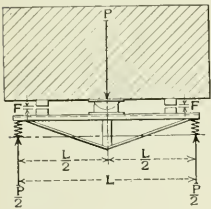

Fig. 5.

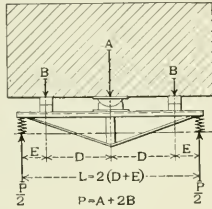

Fig. 6.

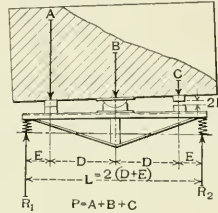

Fig. 7.

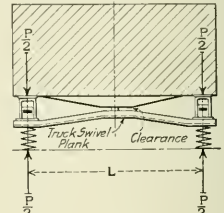

Fig. 8.

ings; the load is being carried by the center plates only. Undoubtedly this case requires a bolster capable of supporting a concentrated load P at its center and should be sufficiently rigid to maintain clearance F under all conditions of service. As this clearance will vary from $\frac{1}{8}$ in. to $\frac{1}{2}$ in., it is evident that the rocking motion of the car body is directly proportional to twice this clearance, which will produce an unfavorable pounding action on side bearings and truck springs.

Fig. 6 represents a common condition to be found on cars after they have been some time in service and illustrates the obvious uselessness of a bolster strong enough to support a concentrated load. There is no clearance between side bearings, caused either by the deflection of the truck bolster, the body bolster or both, by defective center plates or by many other causes. Evidently this case fails to make use of the total carrying capacity of the bolster in a proportion, as the central force A decreases and the two side forces B increase. As the distance E is small compared with distance D , and considering the worst

case of $B = \frac{P}{2}$, the resulting bending moment for this point, being $\frac{PE}{2}$, is very small as compared with the bending moment

in Fig. 5, which is $\frac{PL}{4}$.

But as there is no clearance between the side bearings, the rocking tendency of the car body is greatly retarded or absorbed by the truck springs.

Fig. 7 shows the load unequally distributed and has the same general properties as Fig. 6 with the additional disadvantage of compressing the truck springs unevenly; that is, reaction R_1 will be greater than reaction R_2 . It has been attempted by the use of some cradle arrangement to throw a proportionate part of the load toward the light side, but the theoretical correctness of such an arrangement is questioned; the only remedy is equal distribution of load.

Fig. 8 represents the idea of supporting the load directly over the truck springs, thus eliminating truck bolsters and center plates. As there is no side bearing clearance, the rocking tendency of the car body and the resulting pounding action is greatly

retarded. With the load unequally distributed it is equivalent to the case shown in Fig. 7 in compressing the truck springs unevenly, but this condition will happen in exceptional cases only and will have no appreciable effect upon this bolsterless truck.

Some of the general advantages claimed for this link side bearing in connection with a bolsterless truck are that it solves in a simple manner the side bearing problem, and that when applied to freight trucks it will reduce the dead weight of each car and reduce the wheel flange and rail wear with a corresponding decrease in draft resistance and chance of derailments. When applied to passenger equipment, it gives a nearly frictionless side bearing combined with an anti-telescoping device.

Patents have been applied for on this design by A. Stoik-

owitz, Montreal. It is manufactured by the Link Side Bearing Company, 314 Hammond building, Hammond, Ind.

QUICK ACTING LEVER VISE

A new lever vise has been designed by Fisher & Norris, Trenton, N. J. This vise combines quick acting qualities with great strength and reliability. The body is made of gun metal and the jaws are faced with tempered tool cast steel. The bar is solid and the operating mechanism consists of four small pieces in addition to the lever and a small bar spring. These parts are made of the best material and are easily assembled or re-

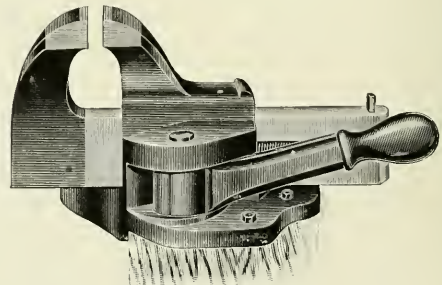

Fisher Quick Acting Vise.

moved if necessary. They are so arranged that when the lever is pulled forward in the locked position the jaws are held firmly in place and cannot possibly be released until the lever is pushed back. The vise holds equally well for filing or chipping, and for bench work has proven to be a most satisfactory time saving appliance.

VENEZUELA CENTRAL RAILWAY EXTENSION.—The directors of the Venezuela Central Railway Company, Ltd., have received advices from their manager in Caracas that the extension of the railway from Soapire to Santa Teresa has been opened to public traffic.

YOUNG LOCOMOTIVE SUPERHEATER

Ends of Unit Pipe Expanded in Holes in Small Steel Plate Header. Pipes Welded at Return Bends.

The Young locomotive superheater is of the fire tube type and consists of any required number of double loop unit pipes arranged in enlarged boiler flues set in horizontal rows across the upper part of the boiler in the same manner generally used in the Schmidt design. The two ends of each unit connect to a steel plate header located near the top of the front end, adjacent to the front tube sheet. This header is divided in two compartments, one for saturated steam and the other for superheated. The former has a direct connection with the end of the dry pipe and the latter opens into a cast iron Tee head which connects to the steam pipes leading to the cylinder. A steel plate box encloses the part of the superheater in the front end and is fitted with a damper in the bottom in the same general arrangement customarily employed on other fire tube superheaters.

There are six features of particular interest in the design which has been patented by C. D. Young, engineer of tests,

welded in place and contains an opening or manhole of a size to permit the dry pipe to pass through it. This opening is closed by a specially constructed sealed cover. There is a reinforcing plate at the front face of the drum and the Tee head connects to it with a ground joint of the usual type. The Tee head is arranged for connections to the steam pipes which lie in a vertical plane parallel to the center of the boiler and will permit the removal of the head without disturbing the lower connections of the steam pipes. The holes in the bottom of the header for connection to the unit pipes are formed the same as the boiler tube holes in the front tube sheet and the unit pipes are connected to them in the same manner as boiler tubes by means of a Prosser or roller expander. Beading, of course, is not necessary, as there is but little tendency for them to pull out and it is only necessary to make a steam tight joint. There are hand holes in the upper part of each of the compartments, that are closed by a

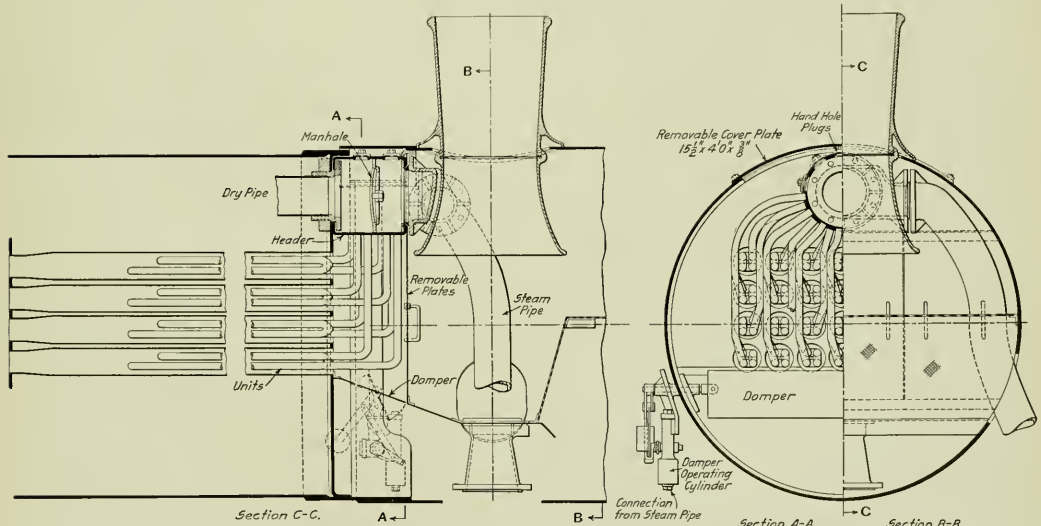

Sections Showing Small Header and the Arrangement of the Units of the Young Superheater.

Pennsylvania Railroad. These are the use of a small steel plate header; the connecting of the ends of the unit pipe to the header by means of an expanded joint; a steel connection instead of a cast steel return bend at the ends of the loops in the unit pipes; the arrangement of units so that any one can be removed with the removal of but one other if it is in the upper rows and no other if it is in the bottom rows; arrangement of dry pipe so that it may be removed without disturbing any of the superheater units, and arrangements for tightening the unit pipes to the header without disturbing any of the front end apparatus or appliances.

The header is in the form of a drum of sufficient diameter to allow the dry pipe to pass through it. It is secured in place on the front tube sheet in the location occupied by a Tee head in a saturated steam locomotive and has a steam tight connection to the end of the dry pipe as is shown in the illustration. The plate dividing it in two compartments is

special type of hand hole plug which can be inserted from the outside and is sealed by a copper gasket or ring. This type of plug has been in successful use on superheaters in stationary practice for many years. Above the whole header a section of the front end sheet is cut out and fitted with a removable cover plate which will permit access to the top of the header from the outside of the locomotive. In addition to the hand holes in the upper part of the header there are also small openings diametrically opposite the entrance of each of the unit pipes. These are closed with a small plug, the design of which is similar to the special hand hole plug already referred to.

The method of inserting a unit is to remove one of the hand holes and the small plugs from the openings directly opposite the two joints. A Prosser or roller expander is then inserted in the hand hole and properly placed and an extension is inserted through the small opening and con-

nected to the roller. An air drill or hammer can then be used on the outside and the joints properly made.

When it is necessary to remove a unit, either of two methods can be used. A flue cutter can be inserted in the same manner as the expander and the pipe is cut off even with the joint, or a flue pusher can be used pushing the flue from the sheet. The ends in the latter case are swaged down to a gage below the size of the hole before being replaced. As will be seen in the illustration, the vertical section of the unit pipe at the front are offset to each side and so arranged that it is possible to remove the units from the two bottom rows without interfering with any of the others and it is also possible to remove unit pipes from either of the top rows by the removal of one other unit. If a unit is removed by cutting off, the slight loss in length is made up by changing the position of one of the bends slightly. This can be done cold without damage to the pipes. The flue pusher method of removal, however, is to be preferred.

In place of using cast steel return bends into which the unit pipes are screwed or welded, this design employs a welded joint between the two sections of pipes. This joint is made by first bending the ends of the pipe to an angle of about 45 deg. and then sawing them off on a line parallel to the axis. These two parts are then brought together and electrically welded. This construction is used at all of the return bends.

The damper operating mechanism is of the customary form which closes the damper by means of a counter weight when the throttle is closed and opens it only by steam pressure on the opening of the throttle.

Removable plates are arranged in the front of the damper box to facilitate cleaning and the removal or examination of any of the connections.

This superheater is being built by the Power Specialty Company, 111 Broadway, New York.

TERRY TRAIN LIGHTING SET

A 25-k. w. non-condensing turbo-generator set for head-end electric train lighting has recently been developed by the Terry Steam Turbine Company, Hartford, Conn. The turbine and generator, connected by flexible shaft, are mounted on a common base with all moving parts so guarded that there is little possibility of danger to passers-by. The set is intended for installation in the baggage car, and weighs 3,400 lbs. Running at 3,000 r. p. m.,

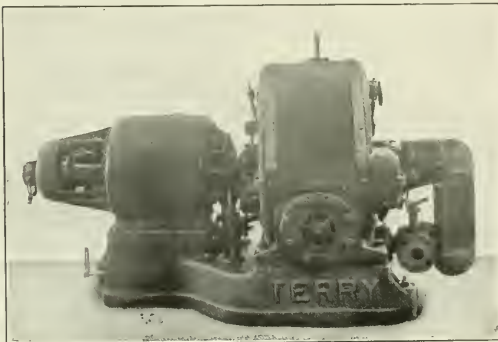

Turbine and Generator for Train Lighting.

it gives current at 125 volts. The set, being entirely self-contained, embodies features of ruggedness, reliability in operation, and freedom from repairs.

Because of the rocking motion of the car, forced feed lubrica-

tion is used, thus giving a positive flooding of the journals and maintaining the best efficiency. An emergency governor provides complete control of the speed and voltage. The lagging on the turbine and the protective casing over the governor mechanism prevent injury to those working in the car or passing through it.

Among the special features of this turbine are the indestructible rotating element, which is so rugged that the masses of water passed through it, when the turbine is started up cold, cause no trouble. The full power of the machine may be obtained in less than a minute under adverse conditions.

CAB WINDOW VENTILATOR

One of the greatest annoyances to a locomotive engineer in the winter time is the collection of frost on the cab window, requiring him to keep his side window open for the observation of signals. In order to overcome this, and to provide ventilation

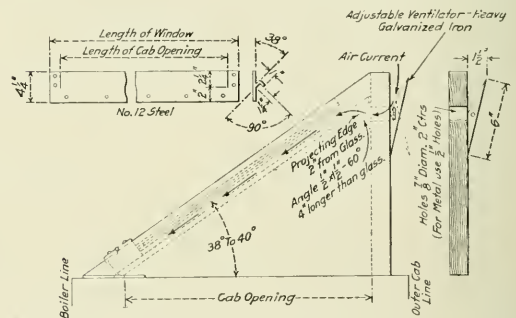

View Showing the Relation of the Ventilator to the Cab Window.

in front of the cab when the window is closed, the window shown in the accompanying illustration has been invented by Charles M. Goodrich, Clinton, Iowa. The window is set out at an angle of 38 to 40 deg. from the point where the cab meets the boiler. A

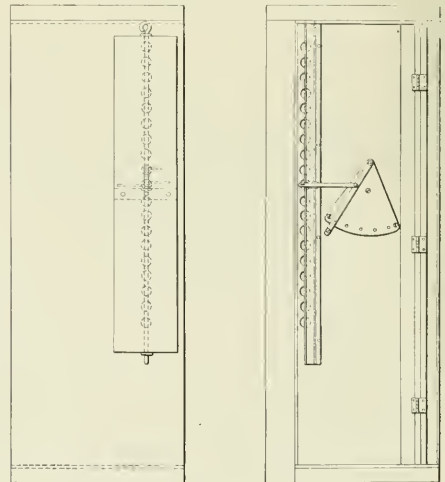

Goodrich Cab Window Ventilator.

series of $\frac{1}{8}$ -in. holes are placed in the extended side of the cab just inside of the window, through which air is forced by an adjustable ventilator. A small vane is placed on the inside edge

of these holes to further guide the air against the inside surface of the glass. By doing this, the temperature of the air on both sides of the glass will be kept very nearly the same, and condensation in cold weather will be prevented. The ventilator is pivoted so that the amount of air passed through these holes may be regulated. There are six positions of adjustment from the totally closed position to the maximum opening. The ventilator is operated through a series of small levers and a quadrant, as indicated in the drawing. This window does not in any way interfere with the passage of a man from the cab to the running-board, and it has found extensive use on some large railways operating west of Chicago.

ACME COMBINATION FLAT TURRET LATHE

A turret lathe that is adaptable to both bar and chucking work, having a maximum capacity for bar work of $3\frac{1}{4}$ in. in diameter and 36 in. long, while all classes of chucking work up to 16 in. in diameter may be machined, is shown in the illustration. In the photograph the machine is shown as fitted for

bar work, but this design can also be furnished as a plain machine without the bar equipment if desired. Among the prominent features of this machine is the single pulley drive; the rigidity of the head, it being cast solid with the bed, thereby obtaining a permanent alinement of the spindle with the vees and cross slide; the cross sliding turret with its long and narrow dovetailed guides; the positive automatic chuck with hardened and ground parts, the simplex roller feed, the reversing power cross and longitudinal feeds, and centralized control and safety stops in all directions.

The machine may be driven by a $3\frac{1}{2}$ in. belt over a 12 in. single pulley which should run at a constant speed of 600 r. p. m. A positive automatic chuck is especially designed to hold the work accurately and may be opened and closed while the machine is running by the long lever at the front of the head. It is so designed that the work does not have end motion, while the chuck is being closed, thereby providing accurate shoulder lengths. The jaws do not collapse and short work may be performed without danger of tilting. An adjustment of $1/16$ in. in diameter, larger or smaller, allows for small variations. The simplex roller feed is simple in design and operation, as only one adjustment is necessary. It is operated by the same lever that actuates the automatic chuck. Both

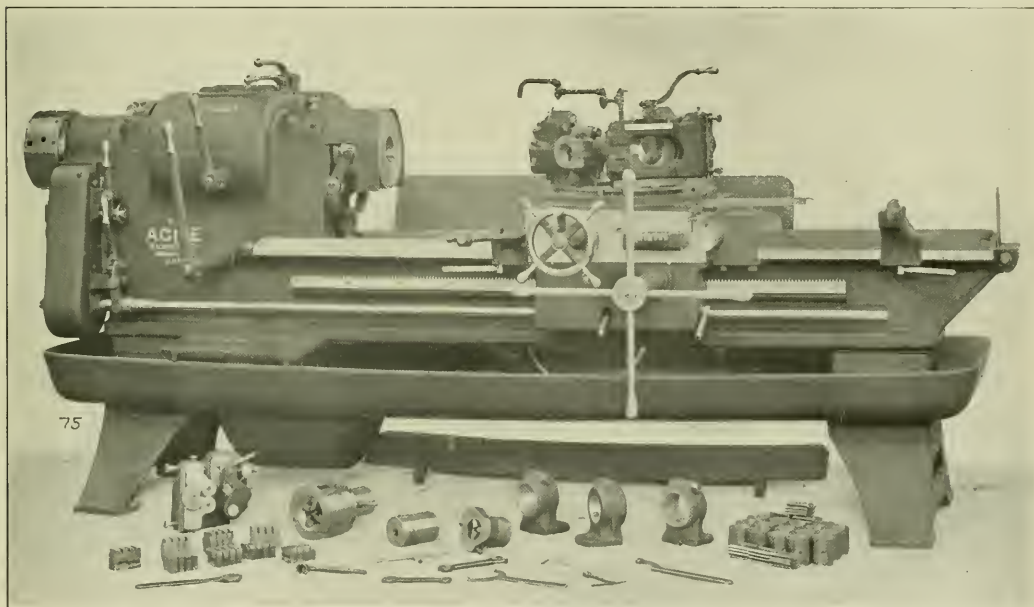

Acme Combination Flat Turret Lathe with Bar Equipment.

the longitudinal and cross feeds are of the gear type. All feed changes are obtainable by the lower lever and can be reversed through the upper lever, both being located on the front of the head stock.

One of the most important features of the design is the centralized control, this being arranged so that the time between operations has been reduced to a minimum. The various levers, such as the longitudinal turnstile, cross feed hand wheel, cross and longitudinal stops and power feed levers, binder handle and stock stop are directly in front of the operator. A 5 h. p. constant speed motor that has a speed of from 1,200 to 1,800 r. p. m., is recommended for use with this machine by the manufacturers. It is built by the Acme Machine Tool Company, Cincinnati, Ohio.

This machine is provided with 12 longitudinal feed stops and 8 cross feed stops. One independent stop is provided for each turret face. Six auxiliary stops which are operated by the knob on the front of the slide, can also be used in any com-

bination desired with the independent stops. The stops are arranged to trip the power feed in either direction, and in doing chuck work as many as seven different lengths may be turned without indexing the turret. Nine different spindle speeds are obtained through the adjustment of gears in the head which run in an oil bath. The speeds ranging from 14 to 285 r. p. m. are obtained quickly without noise, being controlled by two of the levers that will be seen to be conveniently located at the front of the head.

The machine is provided with 12 longitudinal feed stops and 8 cross feed stops. One independent stop is provided for each turret face. Six auxiliary stops which are operated by the knob on the front of the slide, can also be used in any com-

NATIONAL COUPLER RELEASE RIGGING

A release rigging which employs a minimum number of parts necessary to operate the uncoupling mechanism of an M. C. B. top lift coupler is shown in the illustration. This consists of an operating lever of 1 in. round bar, bent to the shape shown, and two malleable iron brackets riveted to the end sill. The side movement of the coupler head is allowed by the slip connection of the lever in the eye of the coupler lock and the draft gear movement by the slot in the bracket located nearest the coupler, with the outer bracket acting as the center of rotation. When

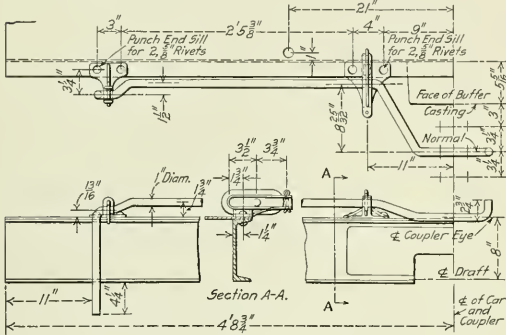

National Coupler Release Rigging.

releasing the coupler by hand, the operating lever rotates in the two brackets and the movable bearing in the inside bracket allows an adjustment so that the coupler lock is lifted at the angle which is the best suited to the particular type of coupler being operated.

It will be seen that the lever has a three point bearing, viz.: in each of the two brackets and in the coupler lock eye. This obviates the necessity of setting the lever handle back against the sill face to prevent sagging of the reach arm and makes it possible to design the lever with a good clearance between the



Coupler Release Rigging on a Hopper Car.

handle and the sill face. In this way the handle is allowed to accommodate itself, in the case of interchange coupler applications to the difference in the height of the eye of the coupler lock as well as the cases where the coupler sags from its original position.

It will be noticed that the lever has a limited movement in

this bracket so that an abnormal forward movement of the coupler, as in the case of the coupler becoming detached from the draft gear, will result in the lever tending to unlock the coupler and release the adjoining car, preventing the coupler from being entirely pulled out of the end sill and falling to the track.

It will be noted that the lever is simply a 1 in. round steel bar from end to end, bent to fit the particular car to which it is applied. In case it becomes distorted in service, the removal of the two cotter pins which hold the lever in the brackets will allow it to be disconnected from the car. By using the lever on the opposite end of the car as a pattern, it is an easy matter to bend it back to its original shape without the use of any special dies.

There is a slight offset in the operating lever near the outside bracket which holds it in the same position laterally at all times, thus insuring the desired amount of forward and backward movement within the slotted bracket.

This rigging is manufactured by the National Railway Devices Company, 490 Old Colony building, Chicago, Ill.

COLLAPSIBLE STAKE POCKET

A new stake holding device for freight cars has recently been developed by the U. S. Metal and Manufacturing Company, New York. The device can be applied to a car in the same position where the strap or cast pocket is now attached. The advantages claimed for this type of stake pocket are, that when not in use it drops to the side of the car, thereby increasing the inside width of the car for such forms of lading as lumber, structural shapes,

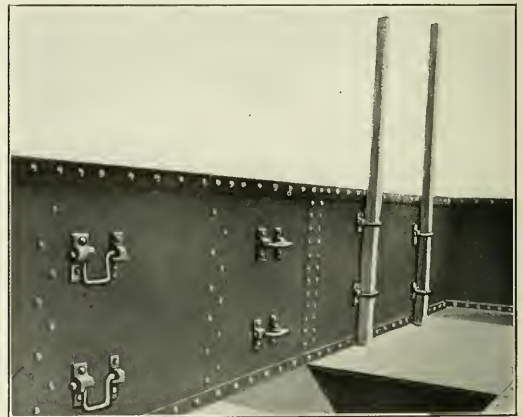

Collapsible Stake Pocket Applied to a Car.

pipng, pig-iron, etc., and it also prevents damage to the pockets or lading in loading and unloading. When loading material requiring stakes, the pockets are raised to a horizontal position and moved to the rest lug on the right, after which the stakes are applied. The pockets are strong, of simple construction and always available for stakes of M. C. B. dimensions. A large percentage of the old type pockets are constantly out of repairs; they are expensive to maintain and facilities for repairs are not provided at loading points, resulting in the improper application of stakes or stakes that do not meet the M. C. B. requirements. It is claimed that the breaking load of the stake over the round section of this pocket is 18 per cent. greater than that over the square edge of the strap pocket. The round section also makes the driving of the stake easier, as well as more secure. The pockets have been thoroughly tested out in actual service for over a year with excellent results.

NEWS DEPARTMENT

The roundhouse of the Minneapolis, St. Paul & Sault Ste. Marie at Portage, Wis., was burned on November 12.

The Chicago & Alton coal chutes at Kansas City, Mo., were destroyed by fire on November 13, together with several freight cars.

The car shops of the Boston & Maine at Fitchburg, Mass., were damaged by fire on the evening of November 10; loss, including damage to eight passenger cars, \$60,000.

James J. Hill, L. W. Hill and a party of officials and directors of the Hill roads, took part in the formal opening of Glacier National Park for the winter season on November 5.

A shipbuilding firm at Philadelphia has a contract to build a vessel 350 ft. long and 50 ft. beam, to be used as a car ferry between Key West, Fla., and Havana, a distance of about 80 miles.

A press despatch from Prague, Austria, November 20 reports that Jules Vedrines, the French aviator, on that day flew from Nancy, France, across Germany without descending, and landed near Prague at 2:20 p. m. The distance covered was about 400 miles.

The proceedings of the New York Railroad Club for the meeting of October 17, contain in addition to the paper and discussion on Vanadium steel in locomotive construction a full list of the membership of the club with titles and addresses, and also an index of the proceedings from 1895 to date.

The "Santa Fe De Luxe" train, the 63-hour train to Southern California on the Atchison, Topeka & Santa Fe, will begin its third winter season on December 9, and will leave Chicago every Tuesday during the winter months. The train this year will be composed wholly of new cars.

In the subways of New York City, operated by the Interborough Rapid Transit Company, 15 barrels of grease are used each month to lubricate rails on curves; this for the purpose not only of reducing the wear due to friction, but to prevent the disagreeable noises which otherwise would annoy passengers. The tracks on the curve at Times Square are greased five times every twenty-four hours.

Two all-steel business cars to be used by officers of the Pennsylvania Railroad to transact railroad business while traveling will soon be finished at the Altoona shops. By the use of the business cars last year Pennsylvania officers, while traveling 159,517 miles, were able to conduct the affairs of the railroad just as if they had been in their own offices. With these cars finished, the Pennsylvania will have four steel office cars.

The office of the Weather Bureau at Washington has issued a memorandum concerning the floods which occurred in Ohio and Indiana last March, and it is estimated that the total money loss by these floods was \$163,000,000. This includes loss to railroad, telegraph and telephone lines and to farms and farm property, including prospective crops. The latter alone amounted to about \$11,000,000. Of the total amount more than 70 per cent. was sustained in Ohio and Indiana.

A study of the economic cost of the smoke nuisance in Pittsburgh was undertaken in connection with the smoke investigation in March, 1912. The work was begun by Dr. C. W. A. Veditz. The Mellon Institute of Industrial Research & School of Specific Industry has just issued smoke investigation bulletin No. 4, prepared by John J. O'Connor, Jr., and dealing with this sub-

ject. Estimates are made of the cost of the smoke nuisance to the various types of industry in the community as well as the loss due to imperfect combustion, and an itemized bill showing the partial cost to the people of Pittsburgh is included, the total of which is \$9,944,740.

CHANGE IN LIGHTING OF NEW HAVEN CARS

The indirect lighting system of the Merchants' Limited, one of the New Haven road's five-hour trains between Boston and New York, is to be supplemented by the installation of tungsten lights along the beam on the lower deck of each car; this to increase the light for reading purposes, concerning which there has been some complaint. When first installed the inverted globes suspended from the ceiling of the cars each contained one 100-Watt tungsten lamp. By displacing these with three 50-Watt lamps an increase of 50 per cent. in the amount of light was obtained, but even with this change we are informed, some of the regular users of the trains complained of difficulty in reading in the "soft radiance" that pervades the cars.

SAFETY OF RAILWAY TRAVEL

There is an exaggerated idea of the danger of railway travel. There are a number of cities and some entire states in which records of the causes of deaths have been compiled by the Census Bureau. These are embraced in what is termed the registration area, which includes twenty-two states and the larger cities in fifteen other states. The registration area is estimated by the United States Census Bureau to embrace 63.1 per cent. of the total population of the United States. For the calendar year 1911, the Census Bureau reported 42,331 cases of accidental death, exclusive of railway accidents, in the registration area. As bearing on the comparative safety of different ways of travel, it may be noted that, as compared with 318 deaths of passengers from railway accidents in the entire United States, there were, in the registration area, 1,883 deaths from street-car accidents, 1,291 from automobile accidents, and 2,237 from accidents in connection with other vehicles. The total number of deaths in the registration area from accidents in connection with street cars, automobiles, and other vehicles in the calendar year 1911 was 5,411, or more than the total number of passengers, railway employees, and all other persons, excepting trespassers, killed in railway accidents of all kinds in the twelve months ended June 30, 1912, including accidents in railway shops.—*W. W. Finley.*

THE FIRST PULLMAN CAR

Fifty-six years ago J. L. Barnes, of Chanute, Kan., was a conductor on the first Pullman car ever run. He made the trip between Bloomington, Ill., and Chicago, over the Chicago & Alton on the night of September 1, 1857, and one of his passengers was George M. Pullman. Mr. Barnes recalls that Mr. Pullman on the next morning was somewhat doubtful as to the ultimate success of his invention. Mr. Barnes is 78 years old and it would probably be rather unfair to visit him with the punishment to which he is clearly entitled, but he told how he stood idly by and permitted the first Pullman porter in history to maltreat a passenger with a whisk broom and collect the original Pullman tip. He was a husky lad of 22 summers at that time and his muscles were in a good state of vigor, but he did not interfere.

The car was a remodelled day coach and there were four compartments, eight berths, four upper and four lower. The

people of Bloomington, little reckoning that history was being made in their midst, did not come down to the station to see the car. There was no crowd and the car, lighted by candles, moved away in solitary grandeur, if such it might be called.

Mr. Barnes retired as division superintendent of the Atchison, Topeka & Santa Fe in 1910, after a railroad service covering fifty-six years.—*Exchange*.

THE COURSE IN RAILROADING

Walker M. Van Riper, who has made a study of legislation affecting railroads and public service corporations, tells this: "At a time when the legislature of the new state of Arizona was passing a big batch of bills affecting railroads, a young man called on President Wilde of the University of Arizona, and asked him if a course of instruction in the railroad business could be had in the university. The president said perhaps it could be arranged, and the young man then asked how long it would take and how much it would cost.

"That depends on how much you want to learn," President Wilde told him. "If you want to learn as much as a division superintendent knows, it will take 10 years and cost you \$10,000. If you want to know as much about the railroad business as the Arizona legislature knows, it will take 15 minutes and will cost you 75 cents."—*St. Louis Post Dispatch*.

APPEALING TO TRESPASSERS DIRECT

On the Baltimore & Ohio a trackwalker patrolling the road, or a section foreman or one of his workmen when meeting a person tramping along the tracks, whether it be a confirmed holo or a respectable citizen like a mill employe, points out to him the danger which lurks in this careless practice. The appeal is backed up by information as to the number of lives that are sacrificed and the permanent injuries that occur each year as a result of people using the railroad as a public highway. The maintenance of way department has a representative on the safety committees of the company, and through these officers the men at work on the tracks are made acquainted with accident statistics. Already there has been an appreciable reduction in the number of deaths and serious injuries. The Claims Department of the road attributes this in large measure to the efforts of the track forces in calling attention to the dangerous practice. Recently a trackwalker was passing a factory adjacent to the right of way just as the factory operatives were coming out. Four young women started up the tracks towards their homes, walking on one of the main tracks. The trackwalker impressed upon the women the danger they were assuming, fortifying his statement by telling them that Miss Pearl Williamson, having assumed the same risk, had lost her life, Miss Williamson having been the twelfth person killed in the same manner on that division during the past year. Presenting the matter with due force he convinced his audience, and now the employes have discontinued using the tracks as a highway.

RECORDS OF TWO ENGINEMEN

H. W. McMaster, general manager of the Wheeling & Lake Erie, has called attention to the remarkable records of two of the enginemen on that road.

Michael Donivan entered the service of the Wheeling & Lake Erie as an engineer on March 11, 1883, and after over 30 years

of continuous service with very few vacations, he resigned, effective October 31, 1913. The records show that during the full period of his employment he never had occasion to go to the superintendent's or master mechanic's office on a matter of discipline, and so far as can be learned he was never even reprimanded by any officer connected with either the transportation or mechanical departments. The only entries on his record are of a commendatory nature and wherein credit marks were allowed; and now at the age of 55 he leaves railroad service in perfect physical condition.

Another man of long service with the company is Ira Cowen, who has been an engineman since November 5, 1881. He was born in 1842, and after having served for three years in the army during the Civil War, was for 17 years in the service of the Atlantic & Great Western, as fireman for two years and engineman for 15 years, leaving that company to go to the Wheeling & Lake Erie with a clear record. During his 32 years on the Wheeling & Lake Erie his service has been continuous, with the exception of a slight interruption brought about by an injury sustained while riding on a train as a passenger. Mr. Cowen has filled the position of engineman for 47 years, without a demerit mark being placed against his record.

MEETINGS AND CONVENTIONS

American Museum of Safety.—A conference on safety and sanitation is to be held in Rumford Hall in the Chemical building, 50 East Forty-first street, New York, December 10, 11 and 12. This conference is to be held under the auspices of the American Museum of Safety, and will be in connection with the International Exposition of Safety and Sanitation. This movement is a part of the educational work now being done to decrease accidents and suffering, and to increase industrial efficiency. Among the subjects to be discussed are Industrial Accidents; Accident Prevention and the Public; Industrial Hygiene; Employer and Employee, and The Coming Generation.

The following list gives names of secretaries, dates of next or regular meetings, and places of meeting of mechanical associations.

- AIR BRAKE ASSOCIATION.—F. M. Nellis, 53 State St., Boston, Mass.
 AMERICAN RAILWAY MASTER MECHANICS' ASSOC.—J. W. Taylor, Karpen building, Chicago.
 AMERICAN RAILWAY TOOL FOREMEN'S ASSOCIATION. A. R. Davis, Central of Georgia, Macon, Ga.
 AMERICAN SOCIETY FOR TESTING MATERIALS.—Prof. E. Marburg, University of Pennsylvania, Philadelphia, Pa.
 AMERICAN SOCIETY OF MECHANICAL ENGINEERS.—Calvin W. Rice, 29 W. Thirty-ninth St., New York.
 CAR FOREMEN'S ASSOCIATION OF CHICAGO.—Aard Kline, 841 North Fifthth Court, Chicago; 2d Monday in month, Chicago.
 CHIEF INTERCHANGE CAR INSPECTORS' AND CAR FOREMEN'S ASSOCIATION.—S. Skidmore, 946 Richmond street, Cincinnati, Ohio.
 INTERNATIONAL RAILWAY FUEL ASSOCIATION.—C. G. Hall, 922 McCormick building, Chicago. Convention, May 18-22, 1914, Chicago.
 INTERNATIONAL RAILWAY GENERAL FOREMEN'S ASSOCIATION.—William Hall, 829 W. Broadway, Wichita, Mich.
 INTERNATIONAL RAILROAD MASTER BLACKSMITHS' ASSOCIATION.—A. L. Woodworth, Lima, Ohio. Convention, August 18-20, 1914, Milwaukee, Wis.
 MASTER BOILER MAKERS' ASSOCIATION.—Harry D. Vought, 95 Liberty St., New York. Convention, May 25-28, 1914, Philadelphia, Pa.
 MASTER CAR BUILDERS' ASSOCIATION.—J. W. Taylor, Karpen building, Chicago.
 MASTER CAR AND LOCOMOTIVE PAINTERS' ASSOC. OF U. S. AND CANADA.—A. P. Danc, E. & M., Reading, Mass.
 RAILWAY STOREKEEPERS' ASSOCIATION.—J. P. Murphy, Box C, Collinwood, Ohio.
 TRAVELING ENGINEERS' ASSOCIATION.—W. O. Thompson, N. V. C. & H. R., East Buffalo, N. Y.

RAILROAD CLUB MEETINGS

Club.	Next Meeting.	Title of Paper.	Author.	Secretary.	Address.
Canadian	Dec. 9	First Aid to the Injured.....	L. R. Johnson.....	Jas. Powell.....	Room 13, Windsor Hotel, Montreal.
Central	Jan. 9			H. D. Vought.....	95 Liberty St., New York.
New York	Dec. 19	Annual Christmas Smoker.....	H. D. Vought.....	95 Liberty St.,	New York.
Pittsburgh	Dec. 19	Locomotive Boiler Design.....	A. W. Whitford.....	F. B. Anderson.....	207 Penna. Station, Pittsburgh, Pa.
Richmond	Dec. 8		E. D. Hotchkiss.....	F. O. Robinson.....	C. & O. Ry., Richmond, Va.
St. Louis	Dec. 12	Efficiency in Handling Railway Equipment.	J. R. Cavanaugh.....	B. W. Frantenthal.....	Union Station, St. Louis, Mo.
Western	Dec. 16	Locomotive Boiler Inspection.....	Frank McManamy.....	Jos. W. Taylor.....	Karpen Bldg., Chicago, Ill.

PERSONALS

It is our desire to make these columns cover as completely as possible all the changes that take place in the mechanical departments of the railways of this country, and we shall greatly appreciate any assistance that our readers may give us in helping to bring this about.

GENERAL

J. F. ENRIGHT, superintendent of motive power and car department of the Denver & Rio Grande, with headquarters at Denver, Colo., has had his jurisdiction extended over the Western Pacific.

W. J. FREY has been appointed supervisor of materials of the Lake Shore & Michigan Southern, with headquarters at Cleveland, Ohio, succeeding H. W. Gardner, resigned.

GEORGE H. FUNK, formerly superintendent of fuel economy of the Chesapeake & Ohio, has been appointed chief smoke inspector for all the railroads entering Cincinnati, Ohio.

JOHN KRUTTSCHNITT has been appointed mechanical inspector of the Illinois Central, with headquarters at Chicago.

MASTER MECHANICS AND ROAD FOREMEN OF ENGINES

HUGH D. MACKENZIE, whose appointment as division master mechanic of the Intercolonial Railway, with headquarters at Stellarton, N. S., was announced in the November number, was born July 22, 1864, at Churchville, Pictou county, N. S., and was educated in the public schools of Moncton, N. B. He began railway work on July 24, 1881, with the Intercolonial Railway as a machinist apprentice, remaining in that position until 1886, and then for twelve years was machinist. He was appointed charge hand at Moncton, N. B., in 1898, and the following year became mechanical foreman at Stellarton, N. S., remaining in that position until 1909, when he was appointed general locomotive foreman at Moncton, N. B., which position he held at the time of his recent appointment as division master mechanic of the same road, with headquarters at Stellarton, N. S., as above noted.



H. D. Mackenzie.

WALTER U. APPLETON, whose appointment as general master mechanic of the Intercolonial and the Prince Edward Island railways, with headquarters at Moncton, N. B., was announced in the November number, was born January 29, 1878, at Moncton, and was educated in the public schools. He began railway work on October 13, 1890, with the Canadian Government Railways as a junior clerk. From 1895 to 1899 he was apprentice machinist and then was clerk, for one year, becoming machinist in 1901. Two years later he was made chief clerk to the superintendent of motive power, remaining in that position until 1907. He was appointed assistant to superintendent of motive power in 1909, which position he held at the time of his recent appointment as general master mechanic, as above noted.

ROBERT F. BYERS, formerly shop foreman of the National Railway of Mexico, at Aguascalientes, Mex., has been appointed master mechanic of the Central Dominicano Railway, with headquarters at Porto Plata, Dominican Republic.

EDWARD M. SWEETMAN, whose appointment as master mechanic of the Southern Railway, with headquarters at Princeton, Ind., was announced in the November number, was born February 22,



E. M. Sweetman.

1874, at Joplin, Mo., and was educated in the common schools. He began railway work on October 16, 1898, with the East Tennessee, Virginia & Georgia line of the Southern Railway as an apprentice. In 1905 he was promoted from machinist to air brake foreman, and in January, 1907, he was made erecting shop foreman. The following April he became roundhouse foreman, and three months later was transferred to Asheville, N. C., as general foreman, remaining in that position until September, 1907, when he was appointed master mechanic, in the Memphis division, with headquarters at Sheffield, Ala. On January 15, 1910, he was transferred in the same capacity to the Birmingham division, which position he held at the time of his recent appointment as master mechanic on the St. Louis division, with headquarters at Princeton, Ind., as above noted.

JAMES WESLEY GIBBS, who has been appointed master mechanic of the Southern Railway, with headquarters at Sheffield, Ala., as was announced in the November number, was born on August 31, 1873, in Rutherford county, N. C., and was educated in the High School, at Clyde, N. C. He began railway work in 1900 as a machinist on the Southern Railway, at Spencer, and three months later was made roundhouse foreman at the same place, remaining in that position until July, 1906; the following month he was promoted to engineer on the Asheville division. In March, 1908, he was made roundhouse foreman at Atlanta, Ga., later becoming general foreman at Asheville, N. C., on the same road. He was appointed master mechanic of the Virginia & South Western, in October, 1911, with headquarters at Bristol, Tenn., which position he held at the time of his recent appointment as master mechanic of the Southern Railway at Sheffield, Ala., as above noted.



J. W. Gibbs.

ELMER E. COPE has been appointed road foreman of engines of the Buffalo, Rochester & Pittsburgh, in charge of territory, East

Salamanca to Punxsutawney and Clearfield, with headquarters at Du Bois, Pa.

HENRY GRIFFITH has been appointed road foreman of engines of the Buffalo, Rochester & Pittsburgh, in charge of the Indiana branch and territory south of Punxsutawney, with headquarters at Punxsutawney, Pa.

J. W. HACKETT, roundhouse foreman of the Forth Worth & Denver City at Amarillo, Tex., has been appointed master mechanic of the Houston Belt & Terminal, with headquarters at Houston, succeeding M. D. Stewart, resigned.

H. B. HAYES, master mechanic of the Alabama Great Southern at Birmingham, Ala., has been appointed master mechanic of the Cincinnati, New Orleans & Texas Pacific at Somerset, Ky., succeeding Joseph Quigley, resigned.

L. L. MOEBECK has been appointed road foreman of engines of the Northern Pacific, with headquarters at East Grand Forks, Minn.

T. E. MULLEN has been appointed division foreman of the Atchison, Topeka & Santa Fe at Seligman, Ariz.

CAR DEPARTMENT

F. C. CORP has been appointed car foreman of the El Paso & Southwestern, at Douglas, Ariz., succeeding F. A. Linn.

ALFRED HERBSTER has been appointed traveling car foreman of the Lake Shore & Michigan Southern, with headquarters at Cleveland, Ohio, succeeding W. J. Frey, promoted.

A. B. McDONALD, general car foreman of the Intercolonial Railway at Moncton, N. B., has been appointed superintendent of car shops at Moncton.

GEORGE EDWARD SMART, who has been appointed master car builder of the Intercolonial and the Prince Edward Island railways, with headquarters at Moncton, N. B., as announced in the November number, was born December 23, 1873, at Edinburgh, Scotland, and was educated in the public schools. He began railway work in August, 1893, with the Grand Trunk, and held various positions on that road until 1897, when he was promoted to car inspector. From 1904 to 1906, he was general inspector of heating and lighting on the eastern lines of the Canadian Pacific, and then to 1909, was general car inspector on the eastern lines of the same road. In 1909 he was made division car foreman in charge of passenger and freight car work on the eastern division of the Canadian Pacific, which position he held at the time of his recent appointment as master car builder of the Canadian government railways as above noted.

SHOP AND ENGINE HOUSE

J. J. ANDERSON has been appointed machine shop foreman of the Seaboard Air Line at Jacksonville, Fla.

J. H. ARBUCKLE has been appointed shop apprentice instructor of the Atchison, Topeka & Santa Fe at Cleburne, Tex., succeeding A. E. Fairweather.

A. M. BAIRD has been appointed assistant superintendent of the locomotive shops of the Atchison, Topeka & Santa Fe, at Topeka, Kan., succeeding R. F. Whalen.

L. E. BODINE has been appointed foreman boilermaker of the Rock Island Lines at Pratt, Kan., succeeding J. W. Greenly, promoted.

J. L. DUFNER has been appointed shop apprentice instructor of the Atchison, Topeka & Santa Fe at Albuquerque, N. M., succeeding E. L. Wood.

JOHN C. FRYE has been appointed general foreman of the Seaboard Air Line at Tampa, Fla.

WILLIAM KEININGER has been appointed foreman of the boiler shop of the Atchison, Topeka & Santa Fe at Topeka, Kan., succeeding A. M. Baird.

THOMAS G. KNIGHT has been appointed night roundhouse foreman of the Rock Island Lines at Biddle, Ark., succeeding H. T. Gibbons.

BERNARD LEE has been appointed roundhouse foreman of the Buffalo, Rochester & Pittsburgh at East Salamanca, N. Y.

JOHN H. REICH has been appointed shop apprentice instructor of the Atchison, Topeka & Santa Fe at Topeka, Kan., succeeding George Elliott.

W. P. RIDLING has been appointed acting night roundhouse foreman of the Rock Island Lines at Dalhart, Tex.

HORACE S. ROSSER has been appointed general foreman of the Seaboard Air Line at Jacksonville, Fla.

PURCHASING AND STOREKEEPING

E. A. CLIFFORD has been appointed junior assistant general purchasing agent of the Atchison, Topeka & Santa Fe, with office at Chicago, Ill., succeeding J. J. Conn, promoted.

J. J. CONN has been appointed senior assistant general purchasing agent of the Atchison, Topeka & Santa Fe, with headquarters at Chicago, succeeding F. E. Connors, promoted.

F. E. CONNORS, assistant general purchasing agent of the Atchison, Topeka & Santa Fe, at Chicago, has been appointed assistant to vice-president in charge of stores, with headquarters at Topeka, Kan.

N. M. RICE, general storekeeper of the Atchison, Topeka & Santa Fe at Topeka, Kan., has been appointed chief purchasing officer of the St. Louis & San Francisco, with headquarters at St. Louis, Mo. Mr. Rice will be in charge of purchases and stores, and will have supervision and care of all material, fuel, supplies and stationery in the possession of the receivers.

F. C. TURNER has been appointed division storekeeper of the Northern Pacific at Pasco, Wash., in place of J. C. Vollmer, resigned.

OBITUARY

JACOB JOHANN, from 1892 to 1897 superintendent of machinery of the Chicago & Alton, died recently at his home in Springfield, Ill. He was born at Rheinabern, Bavaria, Germany, on November 15, 1830. He began railway work in November, 1858, and to July, 1861, was assistant to master mechanic on the Missouri Pacific; subsequently for about four years he was master mechanic of the shops on the Southwest branch at Pacific City, Mo. From March, 1865, to May, 1868, he was general master mechanic of the Missouri Pacific, and from April, 1870, to January, 1872, held the same position on that road. In October, 1872, he was appointed general master mechanic of the Chicago & Canada Southern, and from June, 1874, to November, 1884, was general master mechanic of the Wabash, St. Louis & Pacific, and then to May of the following year was superintendent of motive power and machinery of the same road. From July to November, 1885, he was master mechanic of the Missouri, Iowa & Nebraska, now part of the Chicago, Burlington & Quincy, and then to December, 1886, was master mechanic of the Chicago & Atlantic, now part of the Erie. He was appointed superintendent of motive power and rolling stock of the Texas & Pacific at Marshall, Tex., in December, 1886, remaining in that position until June, 1888; subsequently he had charge of the Chicago office of the Safety Car Heating & Lighting Company, and from November 5, 1892, to February, 1897, he was superintendent of machinery of the Chicago & Alton. Previous to entering railway service he was for 12 years employed in various locomotive work.

EFFICIENCY TESTS ON THE PENNSYLVANIA.—During August, 1913, on the Pennsylvania, the conformity of engines with speed regulations was tested in 6,570 cases, with 21 failures.

SUPPLY TRADE NOTES

The Quigley Furnace Company has moved its general offices from Springfield, Mass., to 105 West Fortieth street, New York.

The J. Faessler Manufacturing Company, Moberly, Mo., has moved its St. Louis, Mo., office from 810 Olive street to the Railway Exchange building.

Charles A. Eggert, who for the past 12 years has been with the Consolidated Car Heating Company, has been made sales engineer of the Railway Utility Company, Chicago.

Horace L. Winslow has disposed of his interest in the Okadee Company. He will give his time exclusively to the Horace L. Winslow Company, Inc., owners of the Winslow locomotive boiler washing and refilling system, which has been installed on a number of leading railroads. The offices of Horace L. Winslow Company, Inc., will remain at 990 Old Colony building, Chicago.

The Easton Car & Construction Company, Easton, Pa., a new concern, has purchased all the stock, rights, plants, office records, equipment and good-will of the Ernst-Wiener Company, New York. W. E. Farrell is the leading spirit in the new company. While the change in ownership is complete the business will be conducted as heretofore. The Easton Car & Construction Company will make industrial railway equipment, including cars, track, and other appurtenances, and, as a new venture, will make plate, tank and structural steel up to 1/2 in. in thickness. The company has a newly erected plant at Easton, Pa., which is completely equipped with new special machinery specially adapted to the manufacture of the Ernst-Wiener products. Everything will be sold hereafter under the trade name of the Easton Car & Construction Company.

Adelbert B. Stetson, consulting engineer for the Bucyrus Company, South Milwaukee, Wis., and formerly vice-president of that company, died on October 27, aged 72 years. Mr. Stetson became connected with the Bucyrus Company in 1888, when he was made superintendent of the old plant at Bucyrus, Ohio. He later had charge of the construction of the new plant at South Milwaukee, Wis., and was subsequently general superintendent for ten years, being chosen vice-president of the company in 1901. He resigned in 1904 to devote his entire time to various dredging and gold-mining interests with which he had been identified for a number of years. Subsequently, however, he again became associated with the Bucyrus Company as consulting engineer, in which capacity he remained until his death. During the past year he gave considerable time to the supervision of gold-dredging operations in Idaho, and while engaged in this work a severe illness made it necessary for him to return to Milwaukee, where an operation was performed which resulted in his death. Mr. Stetson was one of the first Americans to be identified with the construction of the Panama canal.

A corporation has been formed with a New York state charter to engage in the manufacture on an extensive scale of a full line of Diesel engines, both stationary and marine. The company has strong American backing and also to a large extent that of the Swedish capitalists who now control the Swedish Diesel Motor Company. The new corporation will take over the plant and organization of the McIntosh & Seymour Company of Auburn, New York, well known as builders of steam engines. The present steam engine business will also be continued as heretofore. The name of the new company is McIntosh & Seymour Corporation. The Board of Directors is as follows: Marcus Wallenberg, president Stockholms Enskilda Bank, Stockholm, Sweden; Frank A. Vanderlip, president National City Bank, New York; Thatcher M. Brown, Brown Bros. & Co., New York; Edwin S. Church, Auburn, N. Y.; J. A. Seymour, Auburn, N. Y.; Franklin B. Kirkbride, New York; Oscar Lamm,

Stockholm, Sweden, and Philip W. Henry, New York. The general counsel is W. M. Coleman, New York, N. Y. Edwin S. Church, formerly superintendent of the Akron plant, International Harvester Company, will be executive head of the new corporation; J. A. Seymour, president of the McIntosh & Seymour Company, will be vice-president, in charge of engineering. The initial capitalization will be \$2,200,000.

Edwin S. Woods, head of the railway supply firm of Edwin S. Woods & Co., Chicago, Ill., died on November 15 at the home of his parents in Chicago. He was the son of Major John L.

Woods, who was formerly president of the Allen Paper Car Wheel Company and western representative of the Railway Steel Spring Company, and is now with the Buckeye Steel Castings Company. Edwin S. Woods organized the company, of which he was president in 1903, and was previously vice-president of the Kindl Car Truck Company, Chicago. It is announced that the business of the company will be continued along the same lines as previously. Mr. Woods was 42 years of age, and well known among

railway and railway supply men throughout the country.

E. E. Hudson, sales manager of the Primary Battery department of Thomas A. Edison, Inc., Orange, N. J., has been made fourth vice-president of that company. Mr. Hudson will continue as heretofore in charge of the sales of the Primary Battery department, with headquarters at Orange, N. J. Mr. Hudson entered the signal supply business in July, 1898, with the Edison Manufacturing Company, as chief clerk in the Primary Battery department. He remained with that company until June, 1902, when he left to become treasurer of the Peerless Fashion Company. After a few months he resigned that position and went to the United States Steel Corporation as accountant in the comptroller's department.

This position he retained until December, 1903, when he was made secretary and treasurer of the Battery Supplies Company, Newark, N. J. In 1905 he was made also sales manager of that company. In 1908 he returned to the Edison company upon the absorption of the Battery Supplies Company, as assistant manager of sales in the Primary Battery department. He was made manager of sales of that department in February, 1909, which position he retained until his election as fourth vice-president of the company, as mentioned above.



Edwin S. Woods.



E. E. Hudson.

CATALOGS

EMERY GRINDERS.—Several sizes of grinders suitable for abrasive wheels of all kinds are illustrated in a leaflet from the Canton Foundry & Machine Company, Canton, Ohio. In each case the machine is illustrated; a table of dimensions is given and the price lists of the various parts are included.

BOILER CLEANERS.—A booklet bearing the title of, "Economic Steam Production," prepared by G. L. Simonds & Co., 115 South La Salle street, Chicago, contains valuable engineering data in connection with the relation of soot to boiler efficiency which has never before been published. It deals principally with the advantages of the Vulcan soot cleaner and is fully illustrated.

BALL BEARINGS.—A brief discussion of ball bearings and their application to axle lighting generators is contained in a booklet prepared by the Hess-Bright Manufacturing Company, Philadelphia, Pa. Illustrations are included showing sectional views of the generators and the recommended methods of mounting the journal. The construction throughout is thoroughly described.

TURRET LATHES.—The 3¼ in. x 36 in. Acme combination turret lathe is illustrated in a catalog being sent out by the Acme Machine Tool Company, Cincinnati, Ohio. The various parts of the machine are fully described and specifications for machines with equipment for chucking work or for bar work are included. This machine is illustrated and briefly described elsewhere in this issue.

CURTIS TURBINES.—All the latest developments in the Curtis steam turbines are fully explained in an attractive catalog being issued by the General Electric Company, Schenectady, N. Y. Turbines from 100 Kw. to 2,500 Kw. capacity and for driving 60 cycle generators at 3,600 r. p. m. are shown. The bulletin is profusely illustrated, showing details of turbine construction, path of steam flow, and a number of typical installations.

VOLTAGE REGULATOR.—The KR system of voltage regulation, which comprises a booster, combined with an automatic regulator so as to continually reverse the excitation of the booster, but with varying periodicity, is fully illustrated and described in bulletin No. 4972 from the General Electric Company, Schenectady, N. Y. This system has been designed to successfully handle larger fluctuations of voltage than the standard method.

BLACKSMITH SHOP EQUIPMENT.—General Catalog No. 179 from the Buffalo Forge Company, Buffalo, N. Y., contains over 300 pages in which are illustrated an extensive line of forges of all sizes and types, blowers of the centrifugal type, hand and power operated drills, combination wood workers, bending machines, hand and power operated shears and punches, hoods, heating furnaces, fans, pumps, etc. Each equipment is accompanied by a table giving sizes, weight and prices.

TRAVELING ELECTRIC HOISTS.—Bulletin No. 301 from Pawling & Harnischfeger Company, Milwaukee, Wis., is devoted to a very complete description of the type U electric traveling hoist, manufactured by this company. The various parts are illustrated and described in detail and sketches are given showing the dimensions and clearances required for its application. This type of hoist uses plain spur gears throughout and employs the splash oil system for lubricating all bearings.

ELECTRIC FURNACES.—A folder which illustrates and describes the construction and operation of electric furnaces for the efficient heat treatment of carbon, high speed and alloy steels is being issued by the Hoskins Manufacturing Company, 463 Lawson avenue, Detroit, Mich. This shows a number of sizes and arrangements of electric furnaces. Accurate pyrometers constructed ruggedly enough to withstand the every day work of the hardening room are used in connection with the furnaces and are described in the leaflet.

MACHINE TOOLS.—The Progress Reporter for September, issued by the Niles-Bement-Pond Company, 111 Broadway, New York, mentions and illustrates a number of the latest designs of large machine tools furnished by this company. This includes some very large lathes for turning projectiles and guns, a Niles-Bement-Pond multiple spindle milling machine, a large planer and a 20-33 ft. extension boring mill, as well as a 4 ft. horizontal surface grinder, a 22 in. vertical surface grinder, a disc grinder and a vertical shaper from Pratt & Whitney.

MILLING MACHINES.—The Cincinnati Milling Machine Company, Cincinnati, Ohio, is issuing a new general catalog on its very complete line of column and knee type milling machine, plain, universal and vertical, both cone driven and high power with single pulley drive. This catalog contains 127 pages, is 8½ in. x 11 in. in size and is fully illustrated, showing the large and well equipped shops of the company, the complete machines as well as photographs and drawings of the various more important parts of the various types described. The section of the catalog devoted to the description of the universal type of milling machine is particularly complete and interesting.

LIGHT LOCOMOTIVES.—Locomotives weighing from two to five tons and for gages from 18 in. to 56½ in. with or without cab, are illustrated and described in a catalog prepared by the Bell Locomotive Works, Inc., Yonkers, N. Y. These employing a small vertical boiler with copper tubes and use oil as fuel. The engine is a two-cylinder, high-pressure, double-acting type, built in one unit, one end being geared to and supported by one main axle while the other end is hung from the main frame by a strap. The boiler and fuel and water tanks are supported on a sub-frame that is carried by springs from the main frame that rests directly on the axles. These locomotives are especially adapted for subway and tunnel work.

ONYGRAPH.—The onygraph is a machine devised for cutting steel in irregular forms following the lines of a drawing placed on an adjacent tracing table. The cutting is done by means of an oxy-acetylene machine cutting torch connected to one part of a pantagraph frame, another part of which is extended out and in a suitable location for following the lines of a drawing. The machine is motor propelled so that it can be driven at a uniform, predetermined speed best calculated for the thickness of the metal to be cut. This instrument is fully illustrated and described in Bulletin No. 1, of the Davis-Bournonville Company, 30 Church street, New York. Illustrations are included, showing several complicated and difficult shapes that have been cut in this machine.

BALDWIN FORTY THOUSANDTH LOCOMOTIVE.—Locomotive No. 8661, of the Pennsylvania lines west of Pittsburgh, which is one of thirty similar engines recently built by the Baldwin Locomotive Works, is the forty thousandth locomotive turned out by this company. It is a class K-3-s, Pacific type engine and is briefly described and illustrated in a pamphlet being issued by the Baldwin Locomotive Works, Philadelphia, Pa., in honor of this event. This pamphlet includes a brief history of the Baldwin Works, which has now been in continuous operation for eighty-two years. In connection with this history are a number of interesting illustrations of early locomotives built by this company as well as some of the more recent ones. The plants of the company at Philadelphia, Eddystone and Chicago, as well as the plant of the Standard Steel Works Company, are illustrated and their size and arrangement briefly discussed. A table included in this section shows that, based on an annual capacity of 2,500 locomotives, there are 19,000 men employed, each working ten hours a day. There are eighty-five buildings comprised in the works which give a total floor area of over sixty-four acres. The works consume over 6,000 net tons of iron and steel a week and over 2,500 net tons of other material during the same period.





