

# Applications of Pointers (1A)

---

Copyright (c) 2024 - 2010 Young W. Lim.

Permission is granted to copy, distribute and/or modify this document under the terms of the GNU Free Documentation License, Version 1.2 or any later version published by the Free Software Foundation; with no Invariant Sections, no Front-Cover Texts, and no Back-Cover Texts. A copy of the license is included in the section entitled "GNU Free Documentation License".

Please send corrections (or suggestions) to [youngwlim@hotmail.com](mailto:youngwlim@hotmail.com).  
This document was produced by using LibreOffice.

## n-d access of a 1-d array

- **2-d** array access of a **1-d** array
- **3-d** array access of a **1-d** array
- Accessing a **contiguous 1-d** array
- Accessing a **non-contiguous 1-d** arrays
  
- Accessing **static** allocated arrays
- Accessing **dynamically** allocated arrays

---

## 2-d array access of a 1-d array

# Array of Pointers

```
int    a [4] ;  
int *  b [3] ;
```

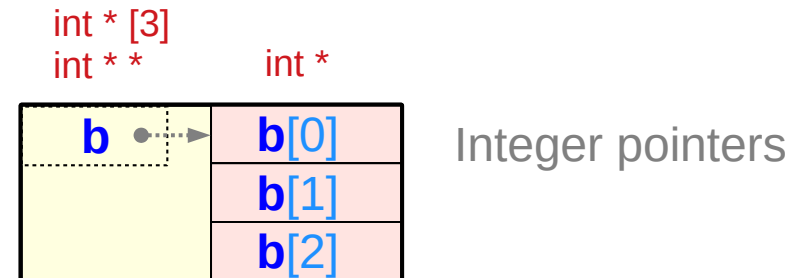
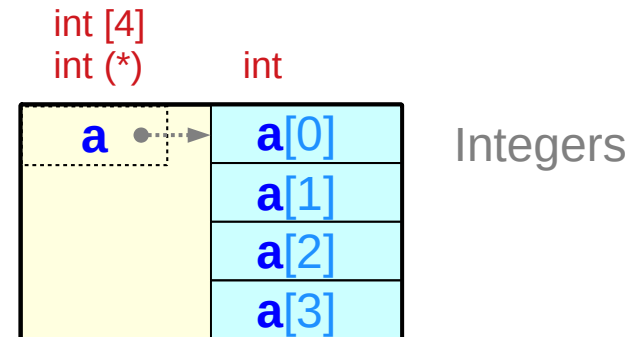
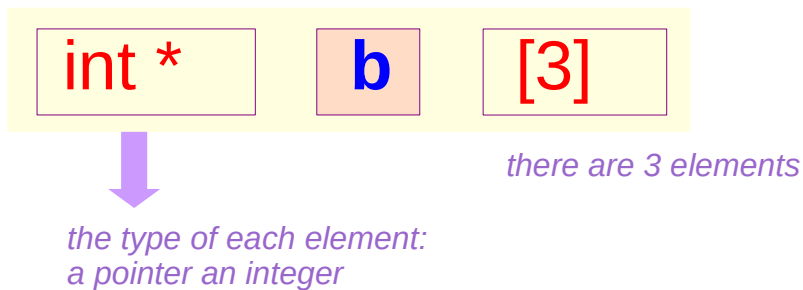
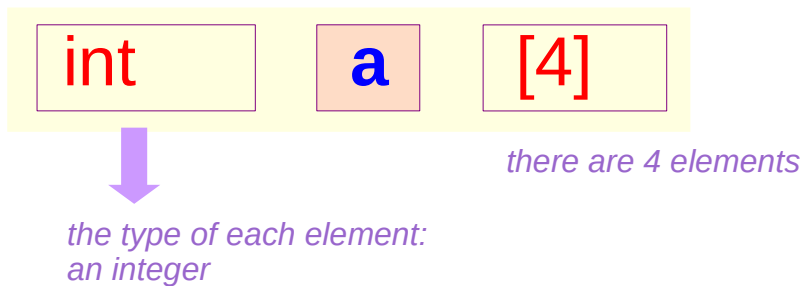

# Array of Pointers – a type view

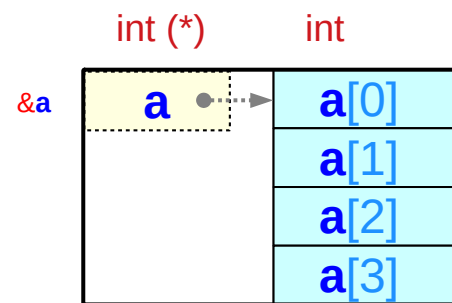
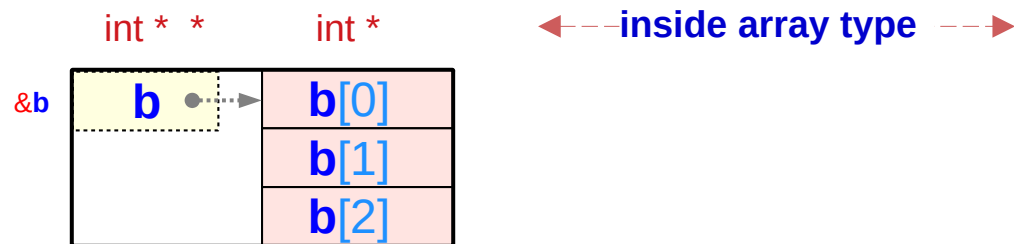
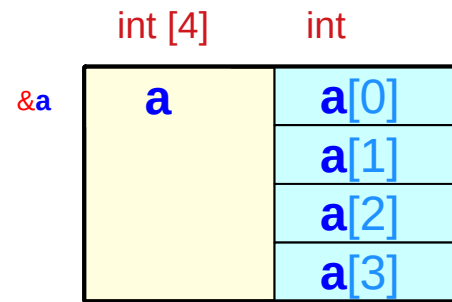
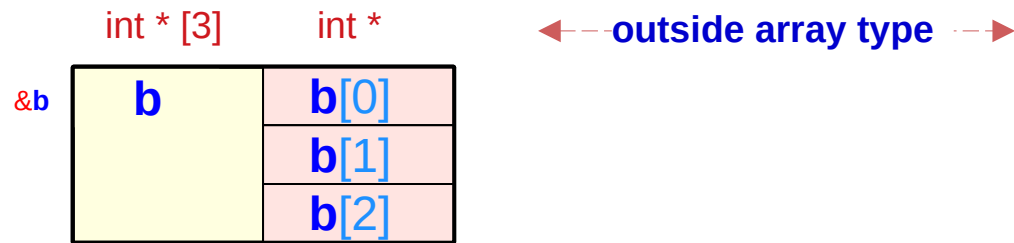
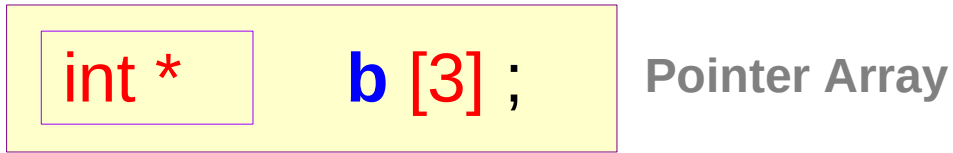

# Array of Pointers – a variable view

```
int * b [3] ;
```

Pointer Array

```
int a [4] ;
```

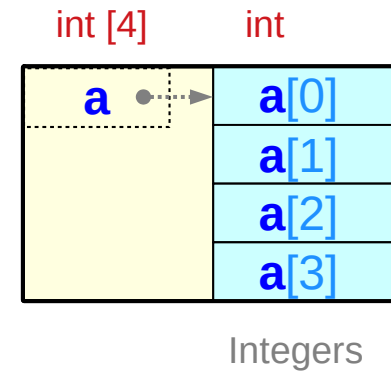
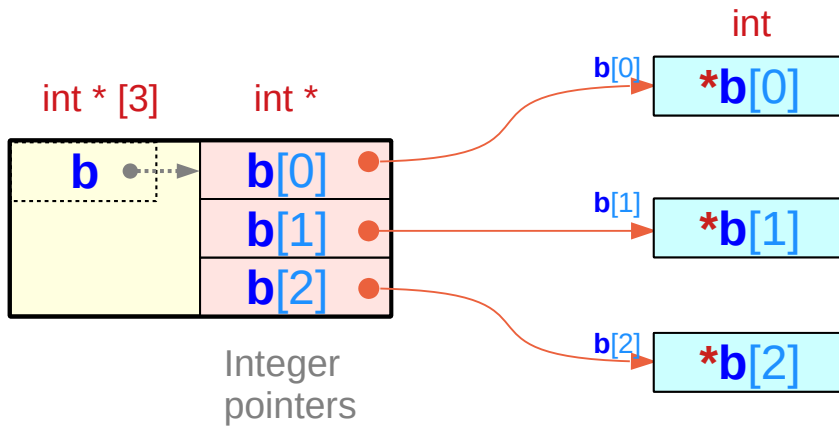

# Assigning a 1-d array name

int \*

b [3] ;

Pointer Array

int

a [4] ;

assignment

b[0] = a (= &a[0])

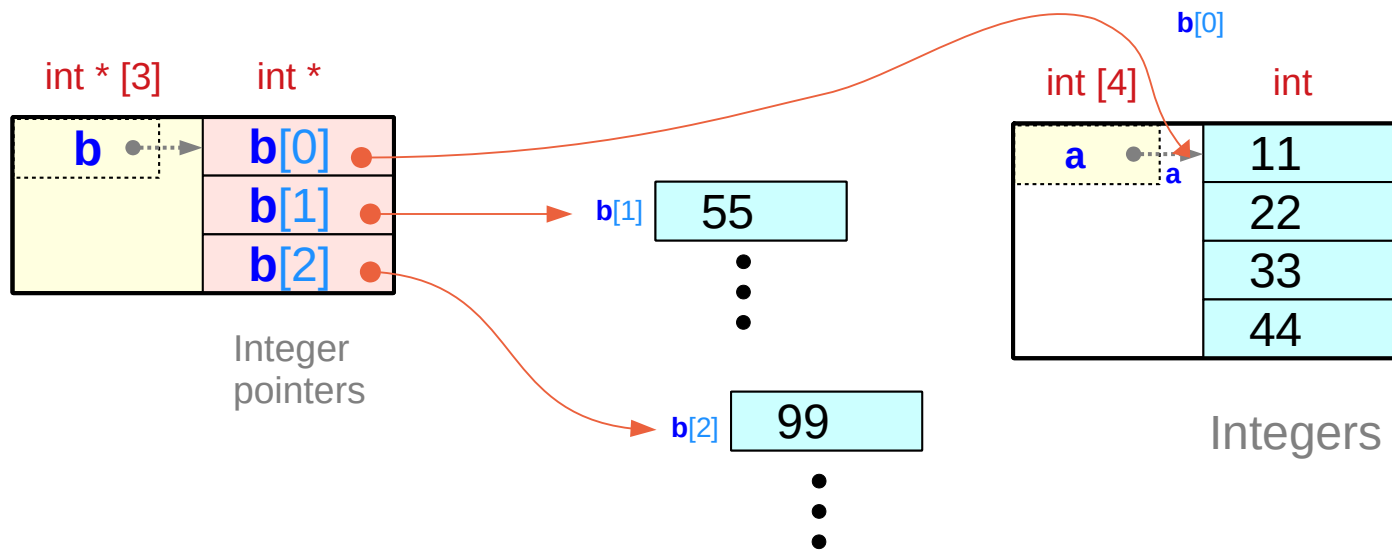



# Assigning a 1-d array name – equivalence

int \*

b [3] ;

Pointer Array

int

a [4] ;

assignment

b[0] = a (= &a[0])

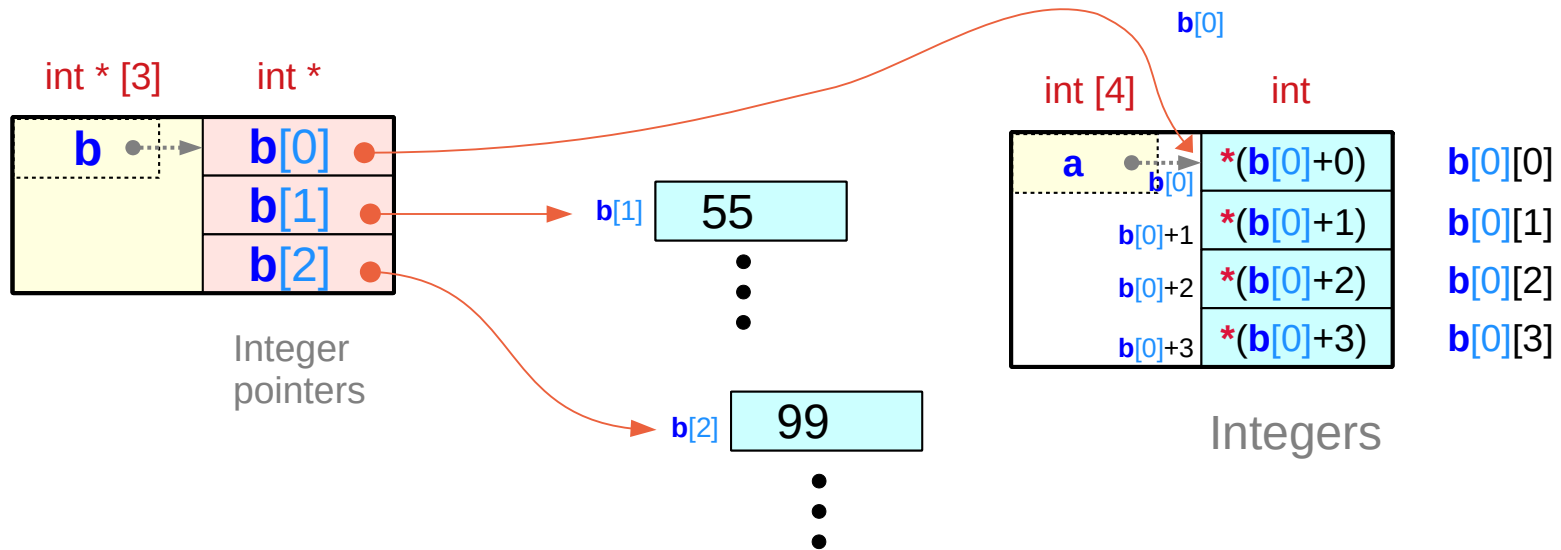

# Array of Pointers – extended dimension

`int *`

`b [3] ;`

Pointer Array

`int`

`a [4] ;`

array name `b`

assignment

`b[0] = a (= &a[0])`

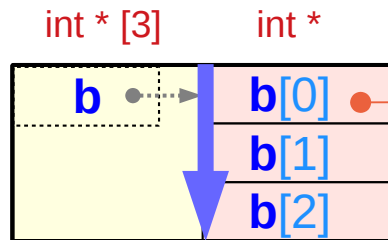

1<sup>st</sup> dim

array name `b[0]`

`int [4]`

`int`

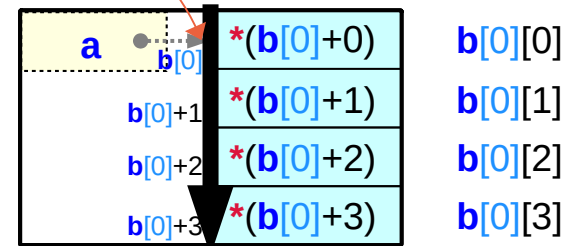

2<sup>nd</sup> dim

```
a[0] ≡ b[0][0] ≡ *(* (b+0) +0)
a[1] ≡ b[0][1] ≡ *(* (b+0) +1)
a[2] ≡ b[0][2] ≡ *(* (b+0) +2)
a[3] ≡ b[0][3] ≡ *(* (b+0) +3)
```

# 2-d access of 1-d arrays

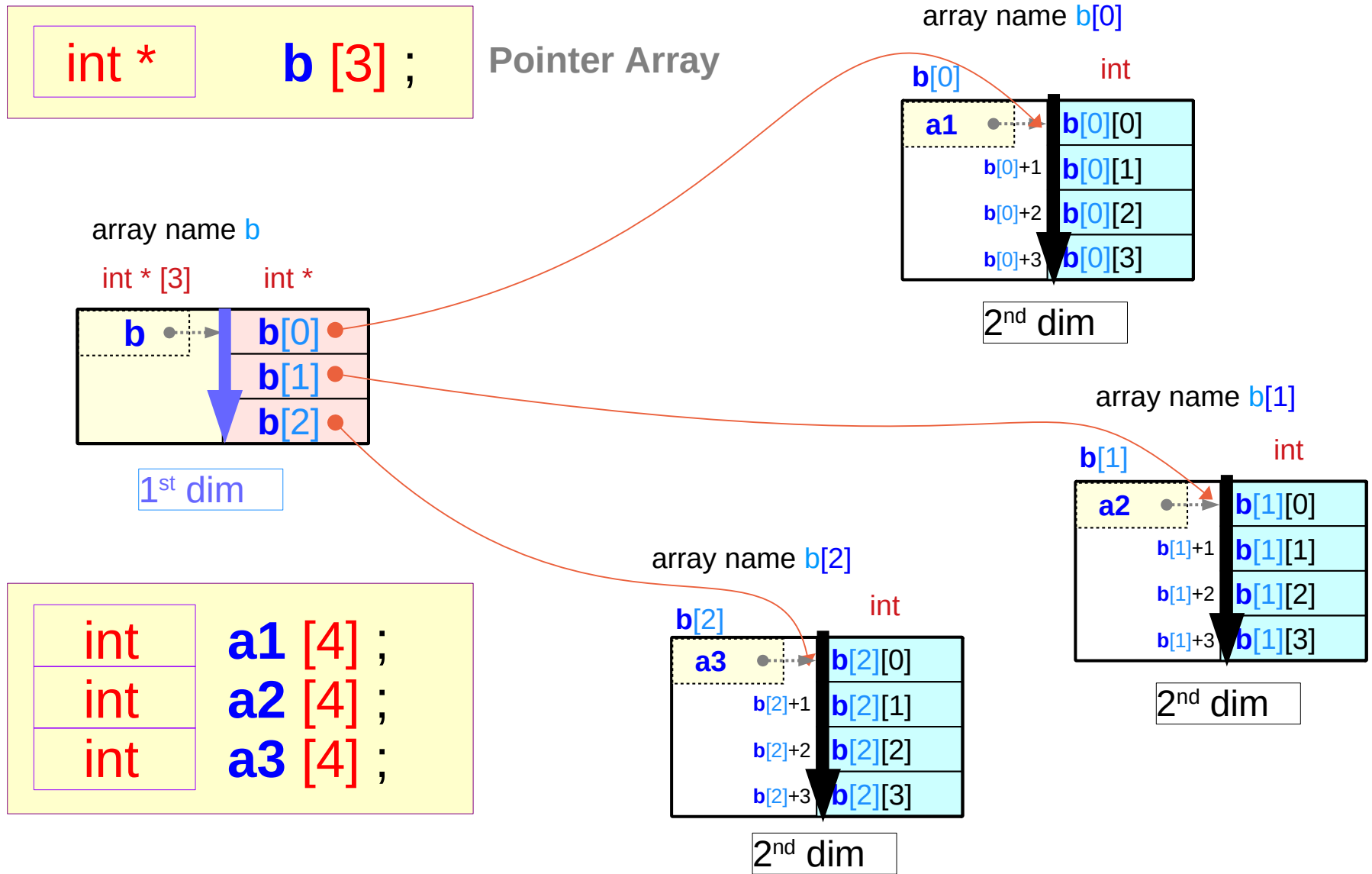

# 2-d access of a 1-d array

int \*

b [3] ;

Pointer Array

int \*

a [3\*4] ;

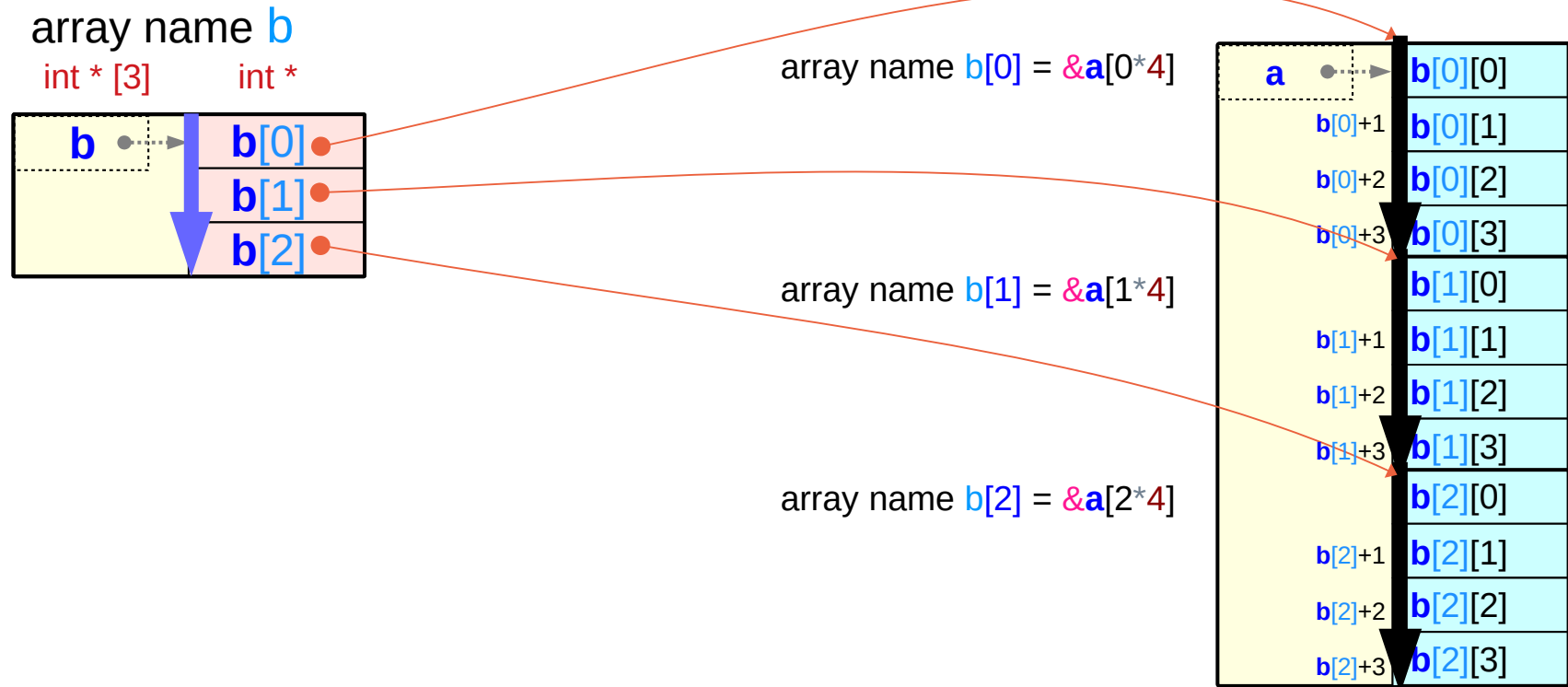

# 2-d access of a 1-d array – pointer array assignment

```
int * b [2*3] ;  
int a [2*3*4] ;
```

```
b[j] = &a[j*4] (= a+j*4)
```

```
b[j] + k = a+j*4 + k  
*(b[j] + k) = *(a+j*4 + k)
```

```
b[j][k] ≡ a[j*4 + k]
```

```
j = [0:5]      k = [0:3]
```

```
j*4+k = [0:23]
```

constraint : contiguous b[i][j] over j

## 2-d access of a 1-d array

```
b[i][j]      ≡    *( b[i] + j )  
              ↕              ↕  
a[i*4+j]    ≡    *( a+i*4 + j )
```

## 1-d access of a 1-d array

constraint : contiguous a[i\*4+j] over j

---

## 3-d array access of a 1-d array

# 3-d access of a 1-d array (1)

```
int **   c [2] ;  
int *    b [2*3] ;  
int      a [2*3*4] ;
```

```
int *    b [2*3] ;  
int      a [2*3*4] ;
```

$b[j] = \&a[j*4] \quad (= a+j*4)$

$b[j] + k = a+j*4 + k$   
 $*(b[j] + k) = *(a+j*4 + k)$

$b[j][k] \equiv a[j*4 + k]$

$j = [0:5] \quad k = [0:3]$   
 $j*4+k = [0:23]$

```
int **   c [2] ;  
int *    b [2*3] ;
```

$c[i] = \&b[i*3] \quad (= b+i*3)$

$c[i] + j = b+i*3 + j$   
 $*(c[i] + j) = *(b+i*3 + j)$

$c[i][j] = b[i*3 + j]$

$c[i][j] + k = b[i*3 + j] + k$   
 $*(c[i][j] + k) = b[i*3 + j][k]$   
 $c[i][j][k] = a[(i*3 + j)*4 + k]$

$c[i][j][k] \equiv a[(i*3+j)*4+k]$

$i = [0:1] \quad j = [0:2] \quad k = [0:3]$   
 $(i*3+j)*4+k = [0:23]$

# 3-d access of a 1-d array (2)

int **	<b>c</b> [2] ;
int *	<b>b</b> [2*3] ;
int	<b>a</b> [2*3*4] ;

$$\begin{aligned} \mathbf{a[k]} &\equiv *(\mathbf{a+k}) \\ \mathbf{b[j][k]} &\equiv *(*(\mathbf{b+j})+k) \\ \mathbf{c[i][j][k]} &\equiv *(*(*(\mathbf{c+i})+j)+k) \end{aligned}$$

constraint : contiguous a[i], b[i], c[i]

## Assignments

$$\begin{aligned} \mathbf{c[i]} &= \&\mathbf{b[i*3]} \quad (= \mathbf{b+i*3}) \\ \mathbf{b[j]} &= \&\mathbf{a[j*4]} \quad (= \mathbf{a+j*4}) \end{aligned}$$

Initializing pointer arrays **b** and **c**



## 3-d access of a 1-d array

$$\begin{aligned} \mathbf{c[i][j][k]} &\equiv *(\mathbf{c[i][j]} + k) \\ \mathbf{b[i*3+j][k]} &\equiv *(\mathbf{b[i*3+j]} + k) \\ \mathbf{a[(i*3+j)*4 + k]} &\equiv *(\mathbf{a+(i*3+j)*4 + k}) \end{aligned}$$

## 1-d access of a 1-d array



# 3-d access of a 1-d array (3)

int **	<b>c</b> [2] ;
int *	<b>b</b> [2*3] ;
int	<b>a</b> [2*3*4] ;

**a**[k] ≡ **\***(**a**+k)  
**b**[j][k] ≡ **\***(**\***(**b**+j)+k)  
**c**[i][j][k] ≡ **\***(**\***(**\***(**c**+i)+j)+k)

**((c[i])[j])[k]**  
≡ **((b+i\*3)[j])[k]** ←  
≡ **(b[i\*3+j])[k]**  
≡ **(a+(i\*3+j)\*4)[k]** ←  
≡ **a[(i\*3+j)\*4+k]**

**c[i] = &b[i\*3] = b+i\*3**

**b[j] = &a[j\*4] = a+j\*4**

**\***(**\***(**\***(**c**+i)+j)+k)  
≡ **\***(**\***(**b**+i\*3+j)+k)  
≡ **\***(**b**[i\*3+j]+k)  
≡ **\***(**a**+(i\*3+j)\*4+k)  
≡ **a**[(i\*3+j)\*4+k]

# Equivalence relations in pointer array assignments

$$\begin{aligned}c[i] &= \&b[i*3] = b+i*3 \\ b[j] &= \&a[j*4] = a+j*4\end{aligned}$$

substitute  $c[i]$  in  $*(c[i]+j)$

substitute  $b[m]$  in  $*(b[m]+k)$

$$m = i*3+j$$



$$\begin{aligned}c[i][j] &= *(c[i]+j) \\ &= *(b+i*3+j) = b[i*3+j]\end{aligned}$$

$$\begin{aligned}b[m][k] &= *(b[m]+k) \\ &= *(a+m*4+k) = a[m*4+k]\end{aligned}$$

$$c[i][j][k] = b[i*3+j][k] = a[(i*3+j)*4+k]$$

$$\begin{aligned}c[i] &= \&b[i*3] = b+i*3 \\ b[j] &= \&a[j*4] = a+j*4\end{aligned}$$

substitute  $c[i]$  in  $(c[i])[j]$

substitute  $b[m]$  in  $(b[m])[k]$

$$m = i*3+j$$



$$\begin{aligned}c[i][j] &= (b+i*3)[j] \\ &= *(b+i*3+j) = b[i*3+j]\end{aligned}$$

$$\begin{aligned}b[m][k] &= (a+m*4)[k] \\ &= *(a+m*4+k) = a[m*4+k]\end{aligned}$$

$$c[i][j][k] = b[i*3+j][k] = a[(i*3+j)*4+k]$$

# Integer array **a** and pointer arrays **b**, **c**

```
int ** c [2] ;
int * b [2*3] ;
int a [2*3*4] ;
```

divide 2·3·4 elements of **a** into  
six (= 2·3) partitions  
each partition has 4 elements

divide 2·3 elements of **b** into  
two (= 2) partitions  
each partition has 3 elements

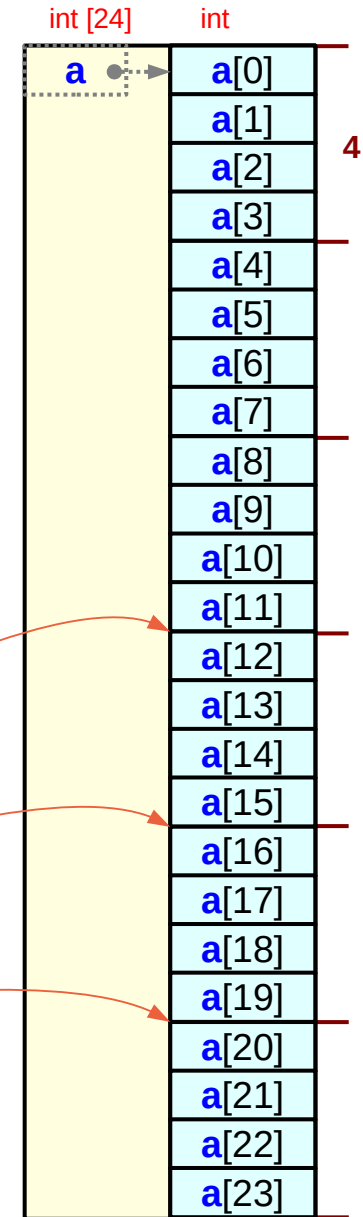
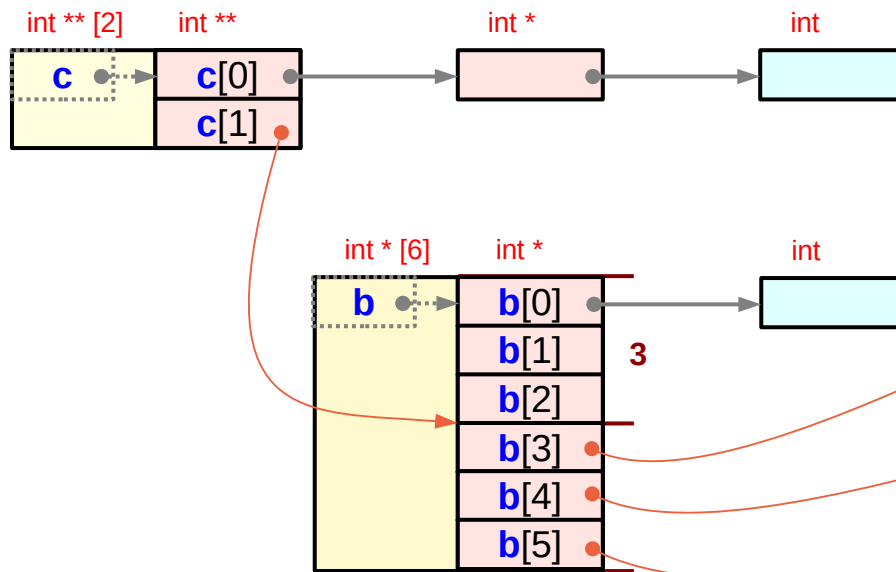

# Pointer array initializations

int **	<b>c</b> [2] ;
int *	<b>b</b> [2*3] ;
int	<b>a</b> [2*3*4] ;

$$c[i] = \&b[i*3] \quad (= b+i*3)$$

each element of **c** handles **3** elements of **b**  
→ **3**-element partitions in **b**

$$b[j] = \&a[j*4] \quad (= a+j*4)$$

each element of **b** handles **4** elements of **a**  
→ **4**-element partitions in **a**

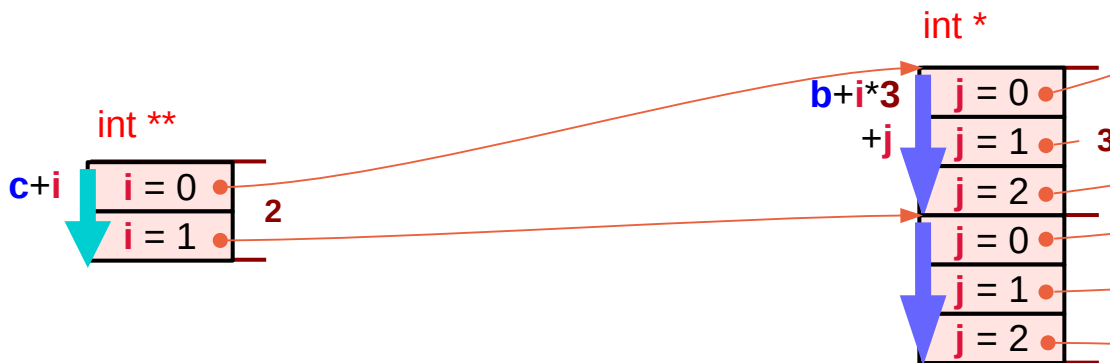

skipping **i** elements from **c**  
= skipping **i\*3** elements from **b**  
= skipping **i\*3\*4** leaf elements from **a**

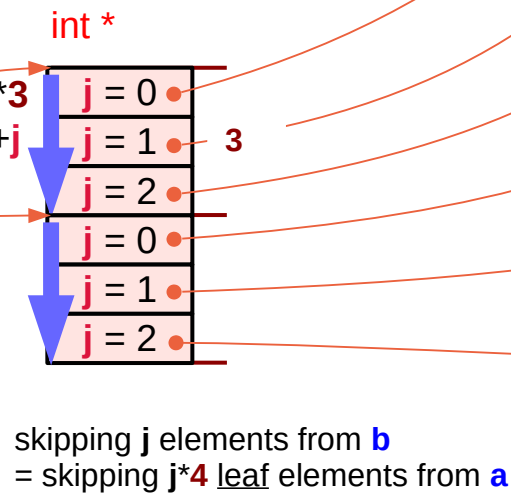

skipping **j** elements from **b**  
= skipping **j\*4** leaf elements from **a**

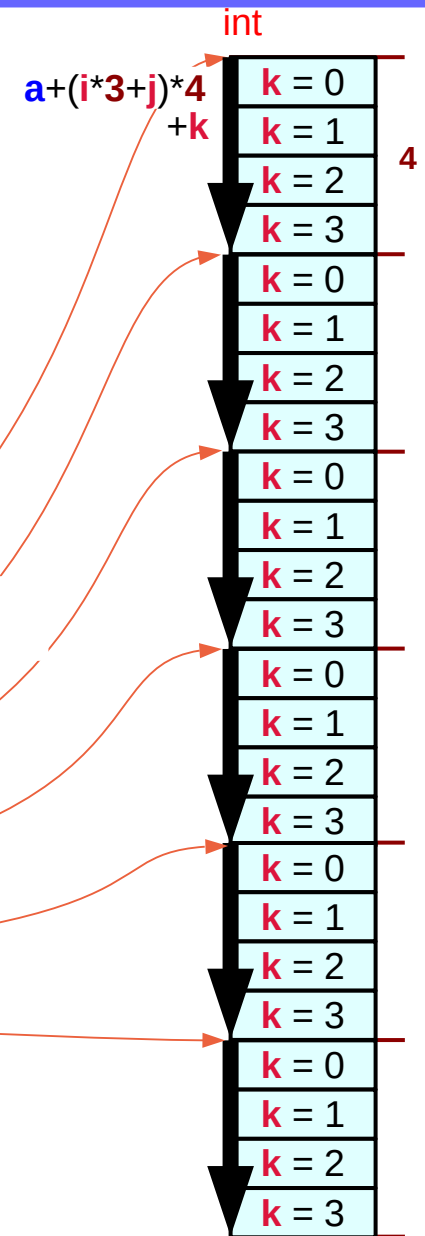

# Partitioning arrays **a** and **b**

int **	<b>c</b> [2] ;
int *	<b>b</b> [2*3] ;
int	<b>a</b> [2*3*4] ;

## Assigning pointer array

```

b[j] = &a[j*4] (= a+j*4)
c[i] = &b[i*3] (= b+i*3)
    
```

```

c[0] = &b[0*3]; (= b + 0*3)
c[1] = &b[1*3]; (= b + 1*3)
    
```

```

b[0] = &a[0*4]; (= a + 0*4)
b[1] = &a[1*4]; (= a + 1*4)
b[2] = &a[2*4]; (= a + 2*4)
b[3] = &a[3*4]; (= a + 3*4)
b[4] = &a[4*4]; (= a + 4*4)
b[5] = &a[5*4]; (= a + 5*4)
    
```

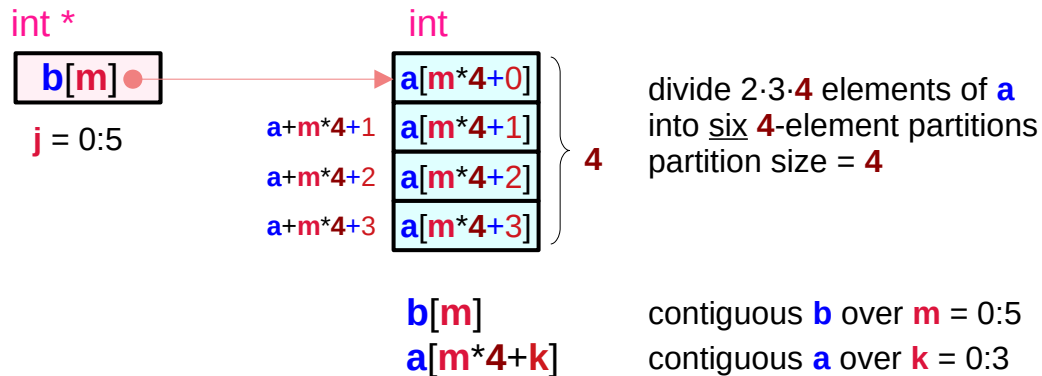
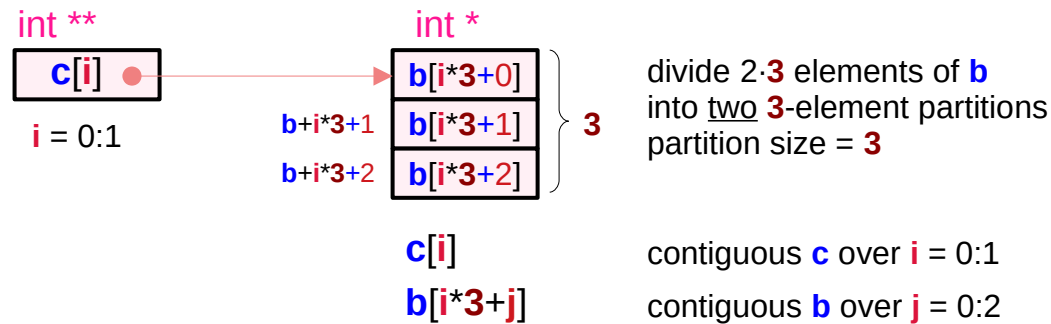

# Skipping leaf elements

int **	<b>c</b> [2] ;
int *	<b>b</b> [2*3] ;
int	<b>a</b> [2*3*4] ;

$$\mathbf{b[j] = \&a[j*4] \quad (= a+j*4)}$$

skipping 1 element in **b**  
= skipping **4** leaf elements in **a**

$$\mathbf{c[i] = \&b[i*3] \quad (= b+i*3)}$$

skipping 1 element in **c**  
= skipping **3** elements in **b**  
= skipping **3\*4** leaf elements in **a**

$$\mathbf{c[i][j][k] \equiv a[(i*3 + j)*4+k]}$$

skipping **i\*3+j** elements from **b**  
+ skipping **k** leaf elements from **a**  
= skipping **(i\*3+j)\*4+k** leaf elements from **a**

$$\mathbf{c[i][j] \equiv b[i*3 + j]}$$

skipping **i** elements from **c**  
+ skipping **j** elements from **b**  
= skipping **i\*3+j** elements from **b**

# Contiguous constraints for $c[i][j][k]$

int **	<b>c</b> [2] ;
int *	<b>b</b> [2*3] ;
int	<b>a</b> [2*3*4] ;



$b[j] = \&a[j*4] (= a+j*4)$   
 $c[i] = \&b[i*3] (= b+i*3)$



$c[i][j][k] \equiv$   
 $a[(i*3 + j)*4+k]$

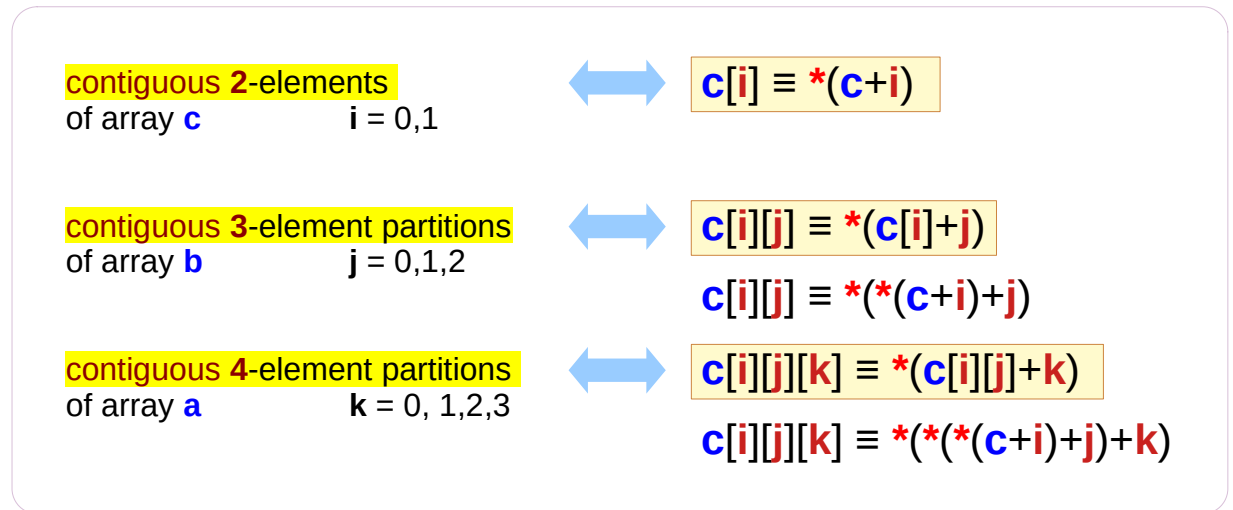
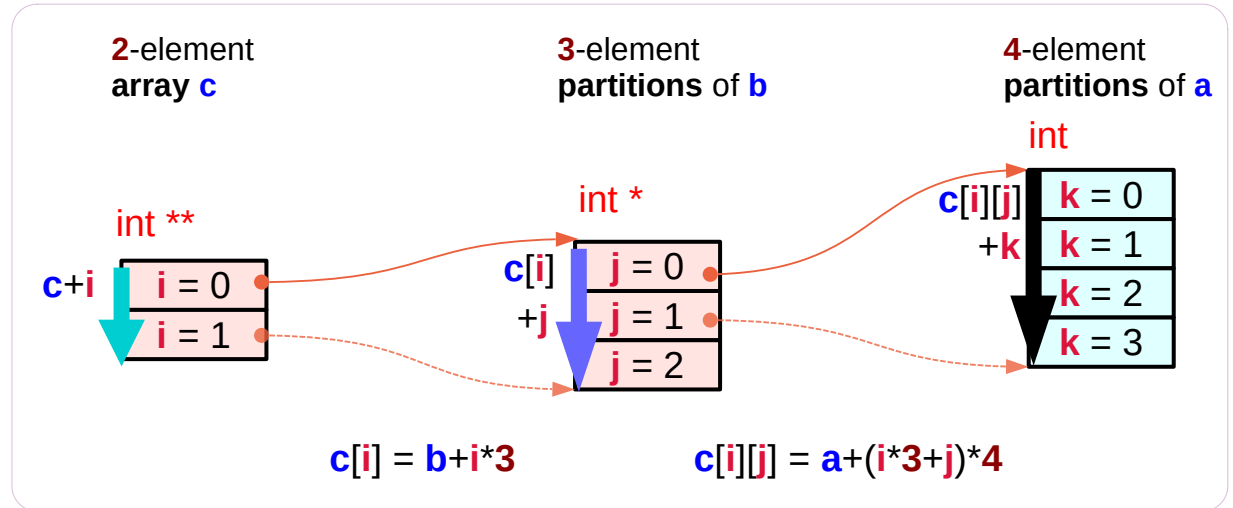

# Minimal constraints and implementations

```
int c [2];    int b [2*3];    int c [2*3*4];
```

```
c[0] = &b[0*3];    b[0] = &a[0*4];  
c[1] = &b[1*3];    b[1] = &a[1*4];  
                  b[2] = &a[2*4];  
                  b[3] = &a[3*4];  
                  b[4] = &a[4*4];  
                  b[5] = &a[5*4];
```

```
int c [2];    int b1 [3];    int a1 [4];  
              int b2 [3];    int a2 [4];  
                          int a3 [4];  
                          int a4 [4];  
                          int a5 [4];  
                          int a6 [4];
```

```
c[0] = &b1[0];    b1[0] = &a1[0];  
c[1] = &b2[0];    b1[1] = &a2[0];  
                  b1[2] = &a3[0];  
                  b2[0] = &a4[0];  
                  b2[1] = &a5[0];  
                  b2[2] = &a6[0];
```

contiguous  
2-element  
array **c**

contiguous  
2·3-element  
array **b**

contiguous  
2·3·4-element  
array **a**

*minimal constraints*

contiguous  
2-element  
array **c**

two contiguous  
3-element  
partitions of **b**

six contiguous  
4-element  
partitions of **a**

two contiguous  
3-element  
arrays **bi**

six contiguous  
4-element  
arrays **ai**



---

## Accessing a **contiguous 1-d** array

- **1-d** array access
- **2-d** array access
- **3-d** array access

# Accessing an int array **a** as a **1-d** array

```
int    a [2*3*4] ;
```



```
a [k]
```

k = 0,1, ...,23

```
int a [2*3*4] ;
```

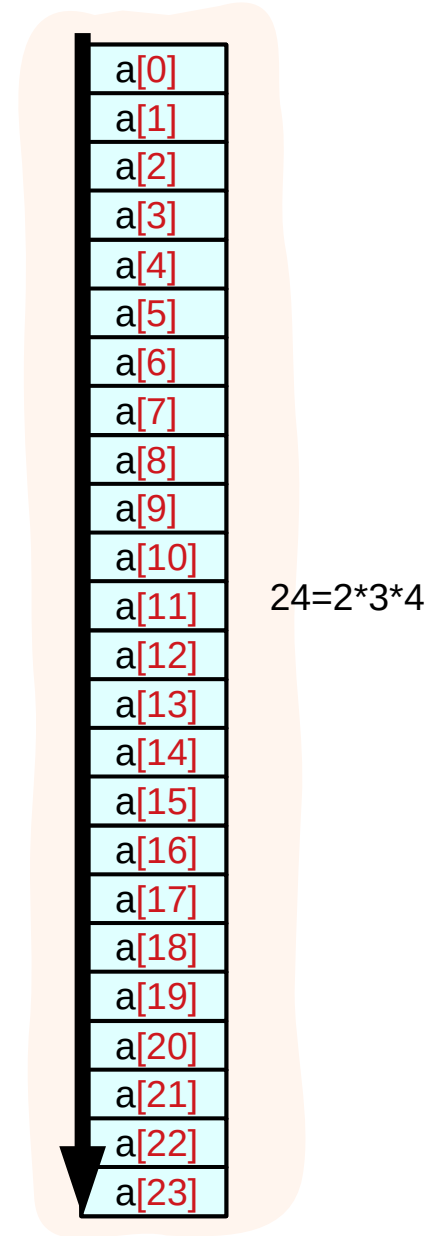

```
c[i][j][k] ≡ *(* (c+i)+j)+k    int ** c[2] ;  
b[j][k]    ≡ *(b+j)+k         int * b[2*3] ;  
a[k]       ≡ *(a+k)           int a[2*3*4] ;
```

# Accessing an int array **a** as a 2-d array using **b**

```
int    a [2*3*4] ;
int *  b [2*3] ;
```

```
b[j] = &a[j*4];
```

**a, b** take actual memory locations

$$b[j][k] \equiv a[j*4 + k]$$

$j = 0, 1, 2, 3, 4$   
 $k = 0, 1, 2, 3$

```
c[i][j][k] ≡ *(* (c+i)+j)+k    int ** c[2] ;
b[j][k]    ≡ *(* (b+j)+k)      int * b[2*3] ;
a[k]       ≡ *(a+k)            int a[2*3*4] ;
```

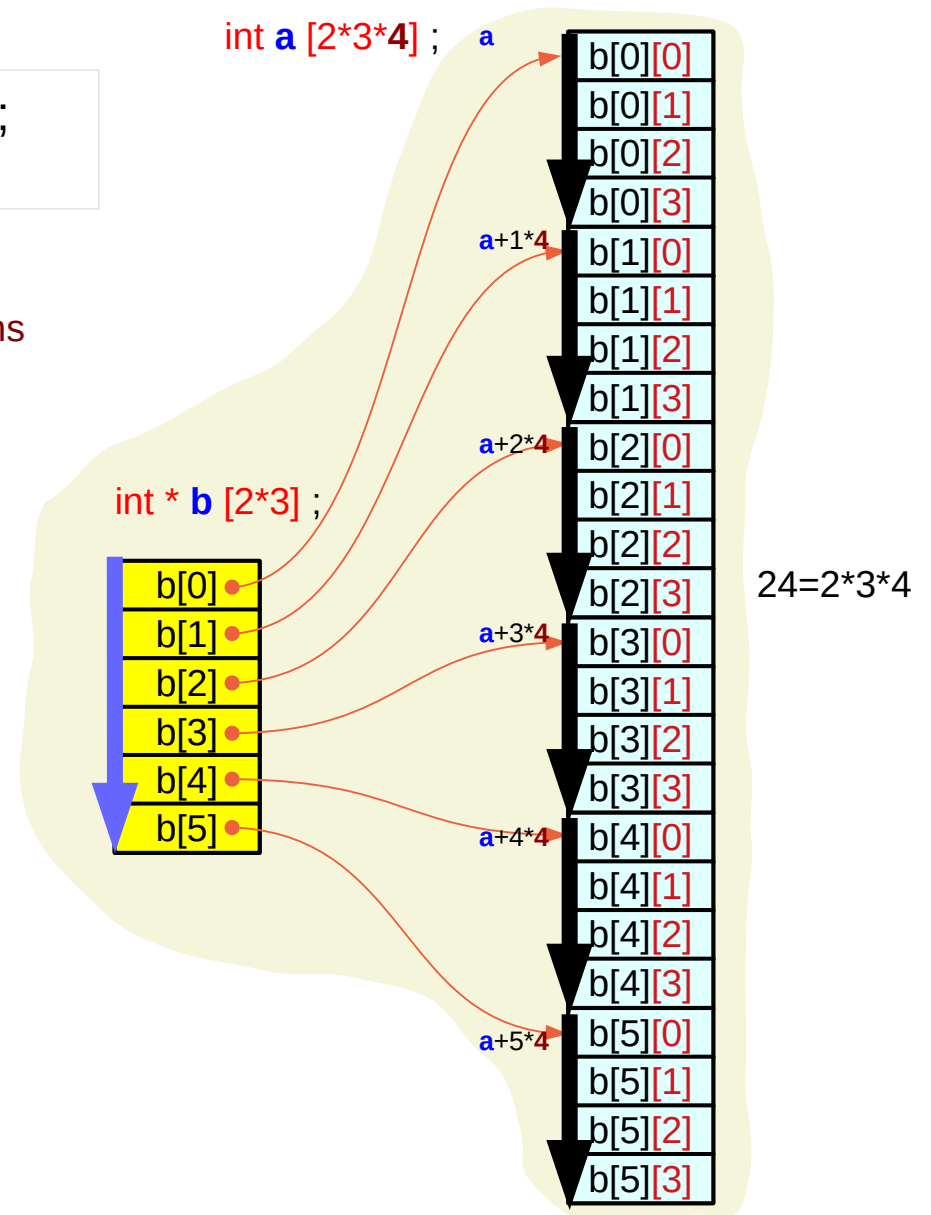

# Accessing an int array **a** as a 3-d array

```
int    a [2*3*4] ;
int *  b [2*3]  ;
int ** c [2]    ;
```

```
c[i] = &b[i*3];
b[j] = &a[j*4];
```

**a**, **b**, **c** take actual memory locations

$$c[i][j][k] \equiv a[(i*3+j)*4+k]$$

$i = 0, 1$   
 $j = 0, 1, 2$   
 $k = 0, 1, 2, 3$

```
c[i][j][k] ≡ *(*(*c+i)+j)+k
b[j][k]    ≡ *(*b+j)+k
a[k]       ≡ *(a+k)

int ** c[2] ;
int *  b[2*3] ;
int a[2*3*4] ;
```

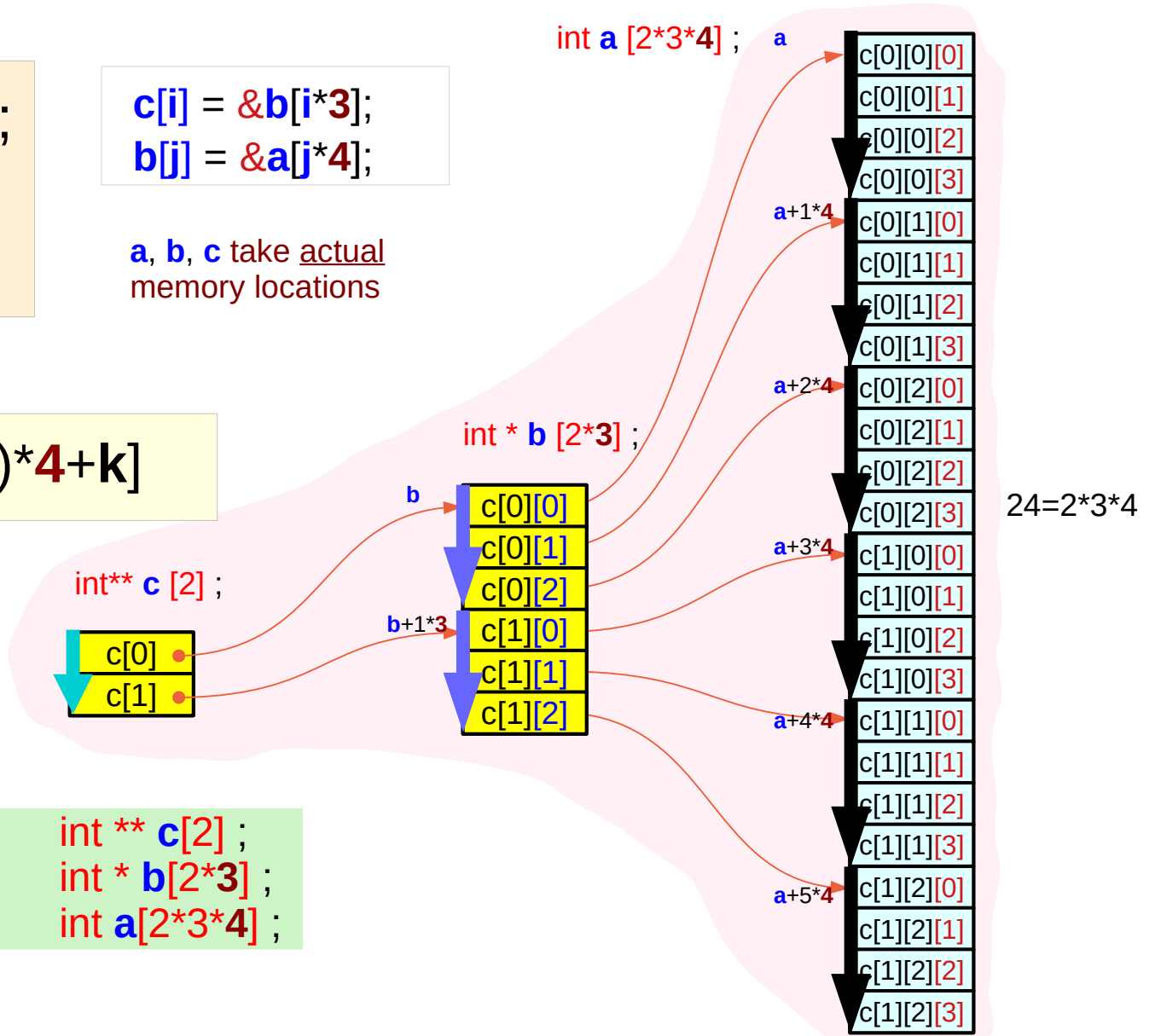

---

## Accessing a **non-contiguous 1-d** arrays

- ◆ **3-d** array access

# Accessing non-contiguous 1-d arrays as a 3-d array (1)

```
int    a [2*3*4] ;
int *  b [2*3]  ;
int ** c [2]    ;
```

```
c[i] = &b[i*3];
b[j] = &aj[0];
```

not c expressions

**aj, b, c** take actual memory locations

```
int a1 [4];
int a2 [4];
int a3 [4];
int a4 [4];
int a5 [4];
int a6 [4];
```

```
c [i][j][k]
```

i = 0, 1  
j = 0, 1, 2  
k = 0, 1, 2, 3

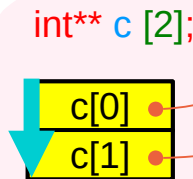

int\* b [2\*3];

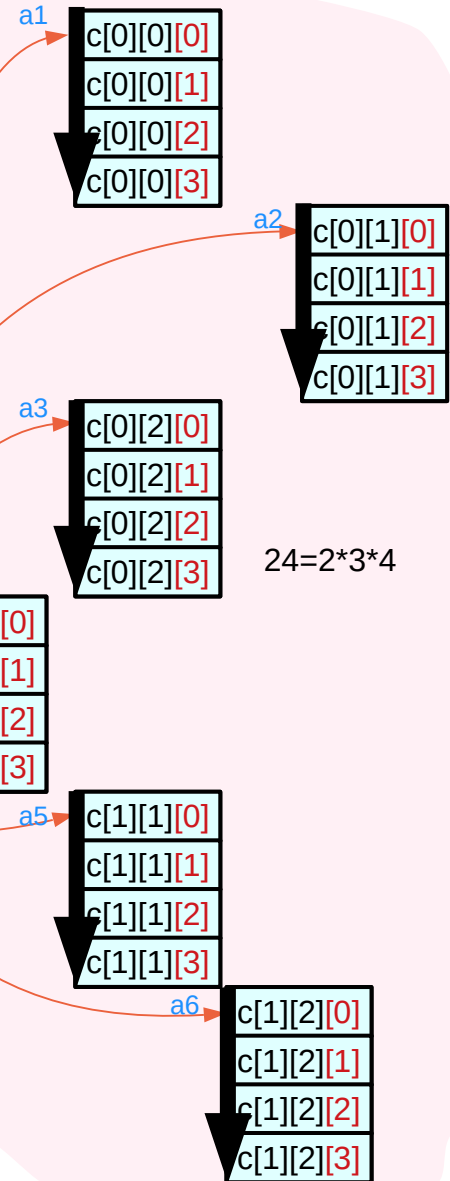
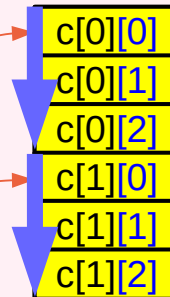

Because the physical **allocation** of array **c** and **b**,  
the **contiguous constraints** can be **relaxed**  
contiguous **c[i][j][k]** only for **k=0,1,2,3**

# Accessing non-contiguous 1-d arrays as a 3-d array (2)

```
int    a [2*3*4] ;
int *  b [2*3] ;
int ** c [2] ;
```

not c expressions

```
c[i] = &bi[0];
bi[j] = &aj[0];
```

not c expressions  
aj, bi, c take actual memory locations

```
int a1 [4];
int a2 [4];
int a3 [4];
int a4 [4];
int a5 [4];
int a6 [4];

int b1 [3];
int b2 [3];
```

```
c [i][j][k]
```

i = 0, 1  
j = 0, 1, 2  
k = 0, 1, 2, 3

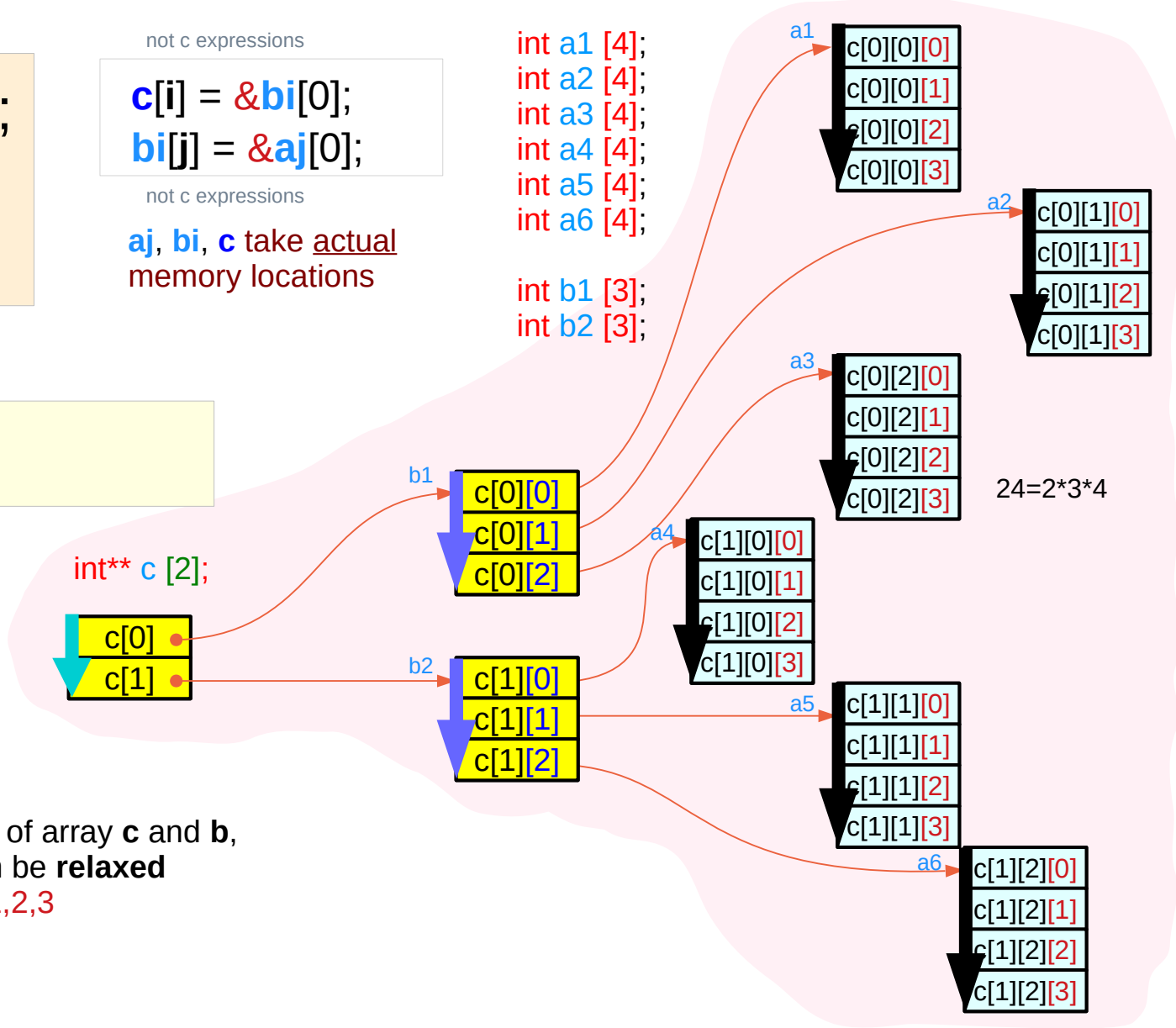
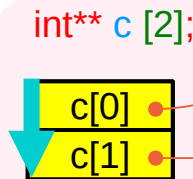

Because the physical **allocation** of array **c** and **b**,  
the **contiguous constraints** can be **relaxed**  
contiguous  $c[i][j][k]$  only for  $k=0,1,2,3$

---

Accessing **statically** allocated arrays

Accessing **dynamically** allocated arrays



# Using arrays **a**, **b**, **c** – statically allocated

```

int **   c [2] ;
int *    b [2*3] ;
int      a [2*3*4] ;
    
```

static memory allocation

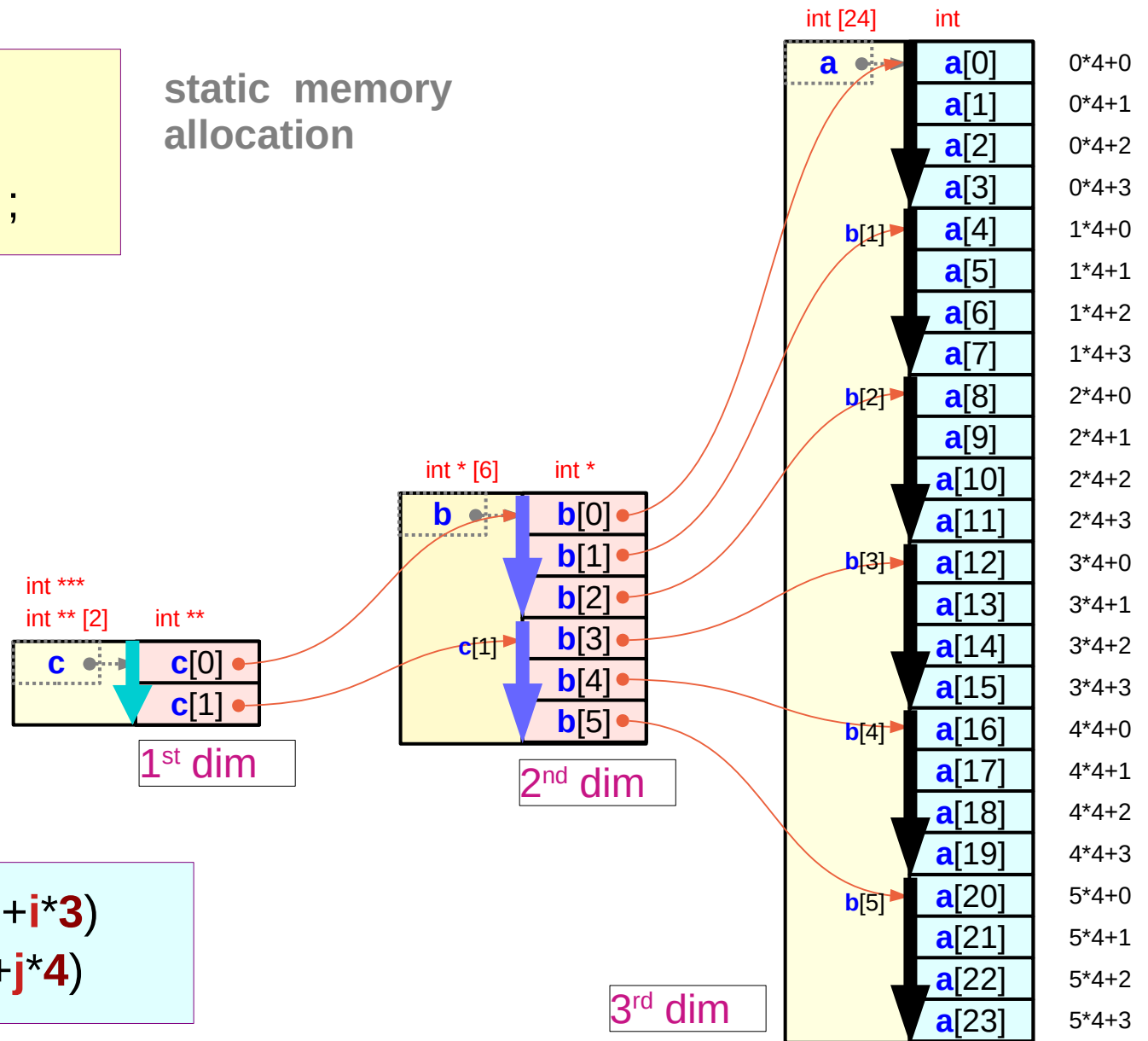

# Using pointer **a**, **b**, **c** – dynamically allocated

```

int *** c = (int ***) malloc(2 * sizeof(int **));
int ** b = (int **) malloc(2*3 * sizeof(int *));
int * a = (int *) malloc(2*3*4 * sizeof(int));
    
```

dynamic memory allocation

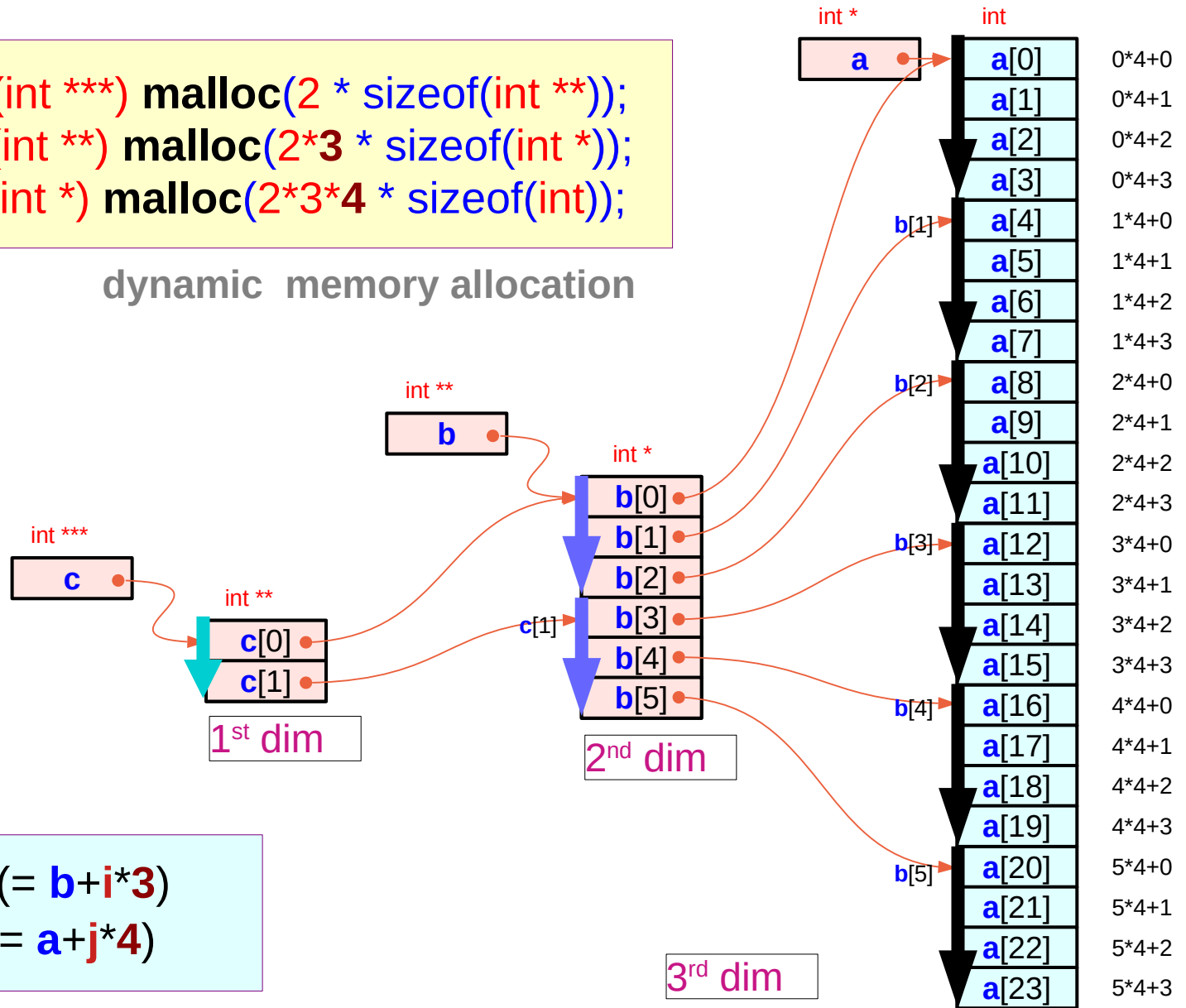

```

c[i] = &b[i*3] (= b+i*3)
b[j] = &a[j*4] (= a+j*4)
    
```

# Static v.s. dynamic allocation (1)

int **	<b>c</b>	[2];
int *	<b>b</b>	[2*3];
int	<b>a</b>	[2*3*4];

## static memory allocations

type(**c**) = int \*\* [2] → int \*\*\*

type(**b**) = int \* [2\*3] → int \*\*

type(**a**) = int [2\*3\*4] → int \*

sizeof(**c**) = 2 \* sizeof(int \*\*)

sizeof(**b**) = 2\*3 \* sizeof(int \*)

sizeof(**a**) = 2\*3\*4 \* sizeof(int)

value(**c**[i]) = **b** + 3\*i

value(**b**[j]) = **a** + 4\*j

int ***	<b>c</b>	= (int ***) malloc(2 * sizeof(int **));
int **	<b>b</b>	= (int **) malloc(2*3 * sizeof(int *));
int *	<b>a</b>	= (int *) malloc(2*3*4 * sizeof(int));

## dynamic memory allocations

type(**c**) = int \*\*\*

type(**b**) = int \*\*

type(**a**) = int \*

sizeof(**c**) = 4 bytes on 32-bit system

sizeof(**b**) = 4 bytes on 32-bit system

sizeof(**a**) = 4 bytes on 32-bit system

value(**c**[i]) = **b** + 3\*i

value(**b**[j]) = **a** + 4\*j

**c**[i] = **&b**[i\*3] (= **b**+i\*3)

**b**[j] = **&a**[j\*4] (= **a**+j\*4)

# Static v.s. dynamic allocation (2)

- static allocation

```
int ** c [2];
int * b [2*3];
int a [2*3*4];
```

- dynamic allocation

```
int *** c = (int ***) malloc(2 * sizeof(int **));
int ** b = (int **) malloc(2*3 * sizeof(int *));
int * a = (int *) malloc(2*3*4 * sizeof(int));
```

```
c[i] = &b[i*3] (= b+i*3)
b[j] = &a[j*4] (= a+j*4)
```

$c[i][j][k]$

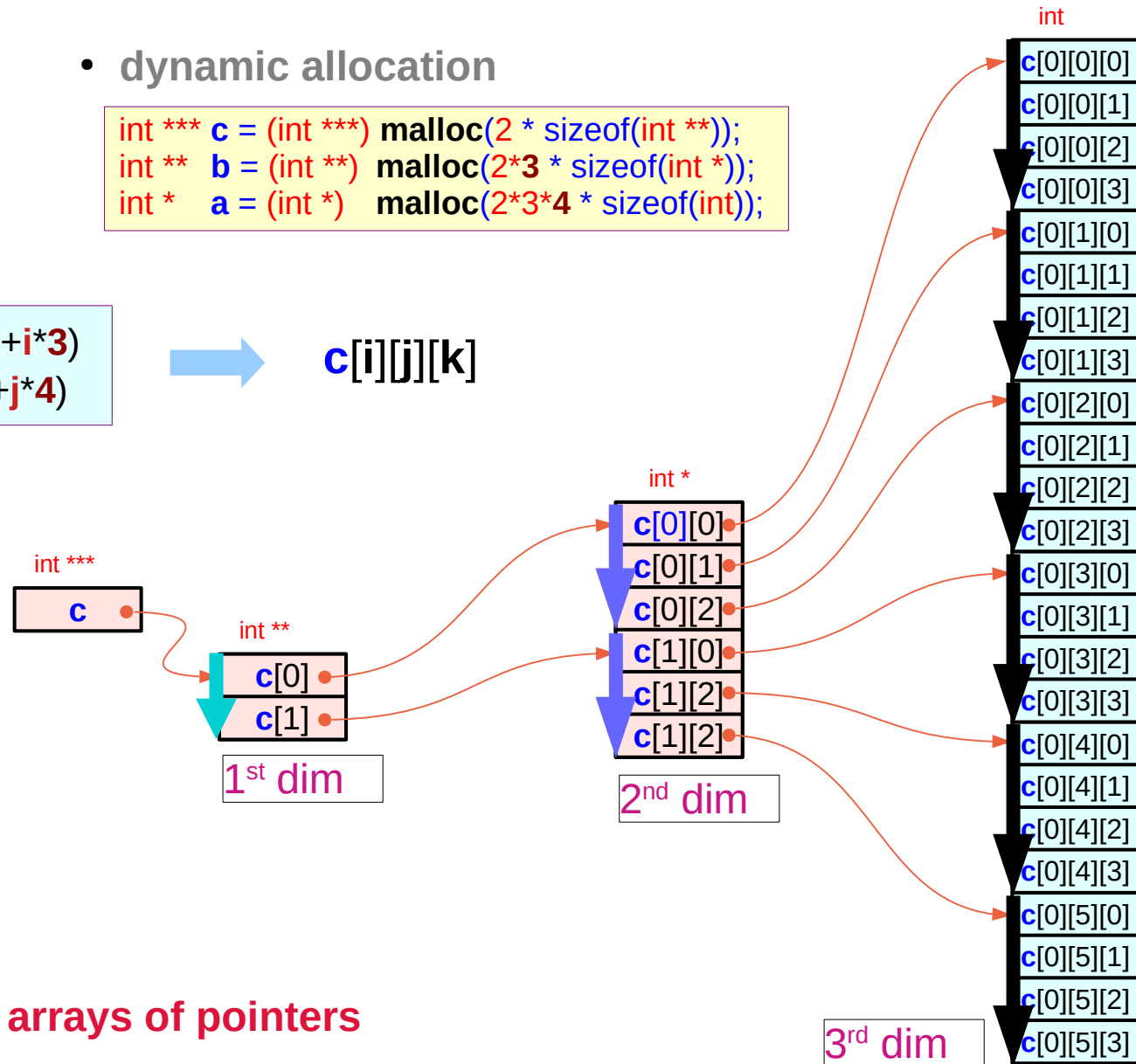

# Static v.s. dynamic allocation (3)

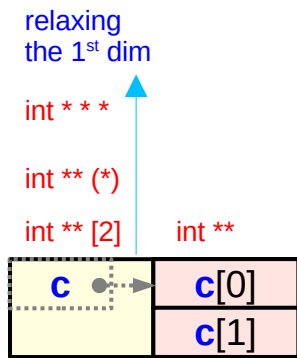

```
int ** c [2];
```

static memory allocation

```
int *** c = (int ***) malloc(2 * sizeof(int **));
```

```
malloc(2 * sizeof(int **));
```

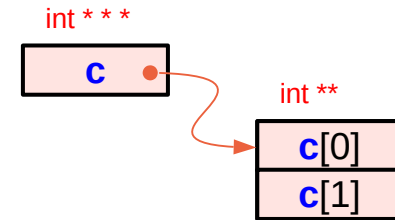
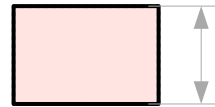

```
int *** c = (int ***) malloc(2 * sizeof(int **));
```

dynamic memory allocation

# Static v.s. dynamic allocation (4)

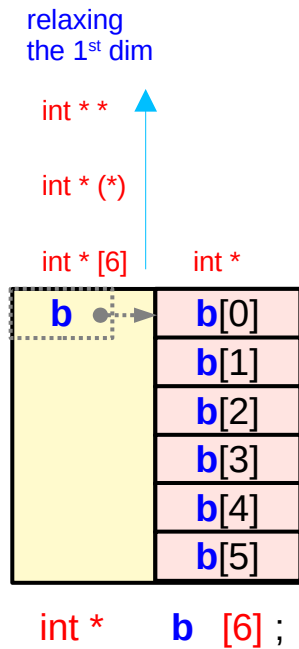

static memory allocation

```
int ** b = (int **) malloc(6 * sizeof(int *));
```

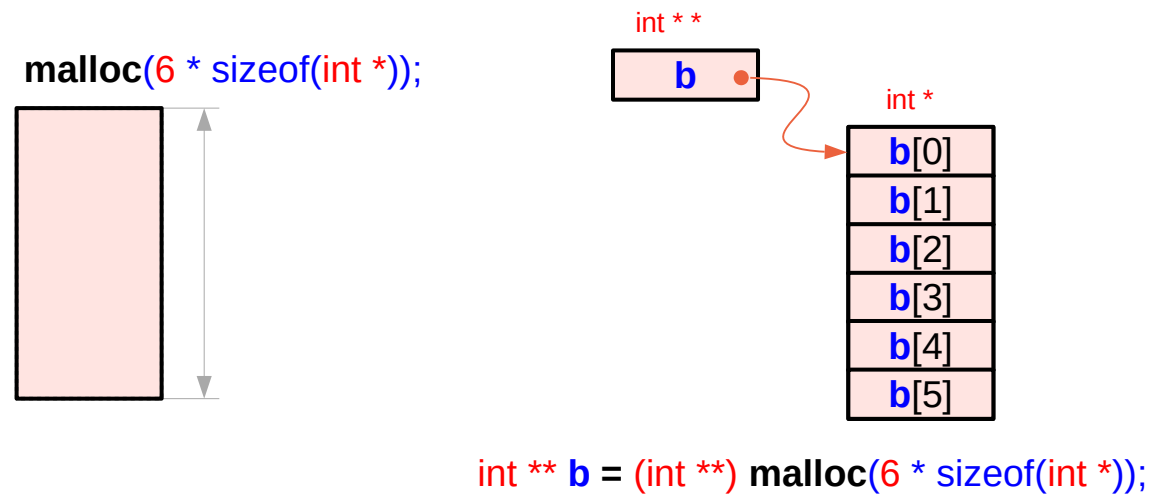

dynamic memory allocation

# Static v.s. dynamic allocation (5)

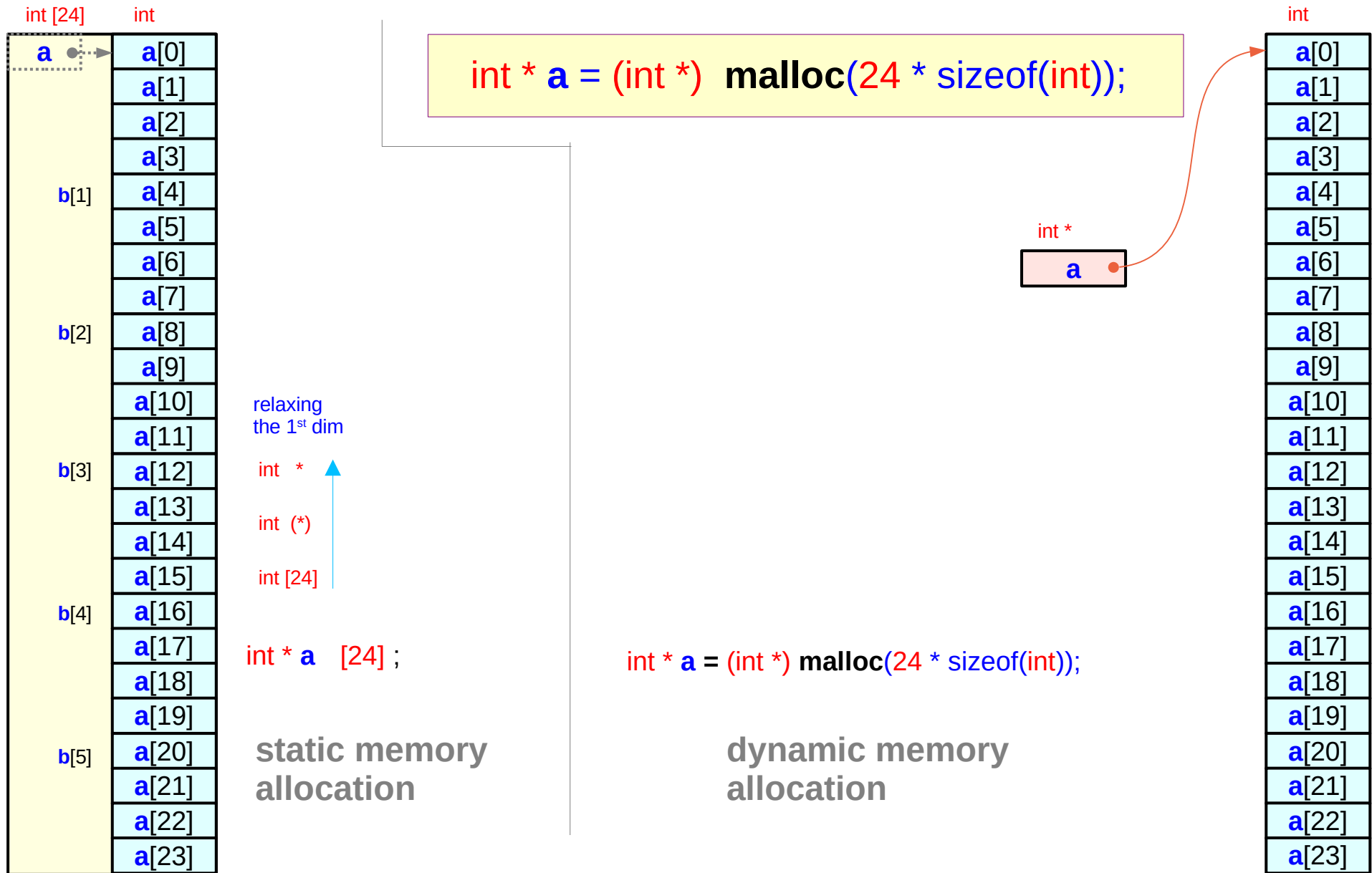

---

**&** address-of operator

**\*** dereference operator



# Address-of operator and dereferencing operator

*the address of a variable :  
address-of operator **&***

*the content at an address :  
dereferencing operator **\****

**& variable** :  
*returns the address of a variable*

**variable** *has memory locations  
whose value can be changed  
by an assignment*

**(variable must be an lvalue)**

**\* address** :  
*returns the value at the address*

**\* address** *has memory locations  
whose value can be changed  
by an assignment*

**(\* address is an lvalue)**

# Ivalue and rvalue in assignments

Left Hand Side = Right Hand Side  
**LHS** = **RHS**

```
int a, b = 10 ;  
int * p, q = &a ;
```

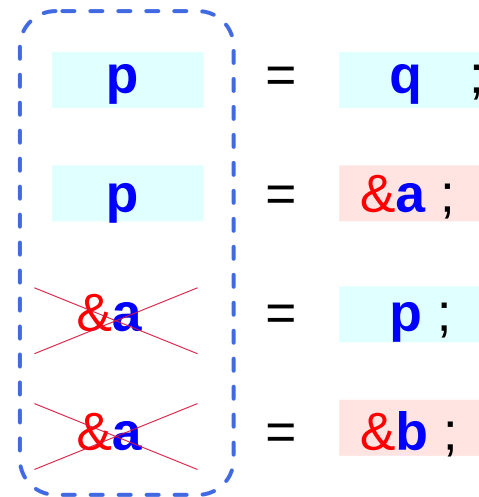
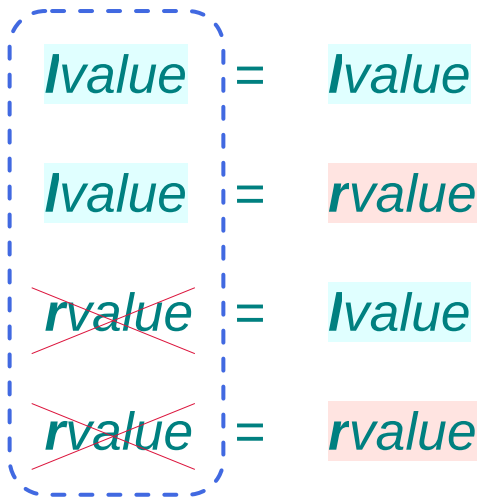

in the **LHS**, only **lvalue** can exist  
**rvalue** can exist only in the **RHS**

<b>a, b, p, q</b>	: lvalues	... variables	... RW
<b>*p, *q</b>	: lvalues	... variables	... RW
<b>&amp;a, &amp;b</b>	: rvalues	... constants	... RO

# Ivalue and rvalue with \* and & operators

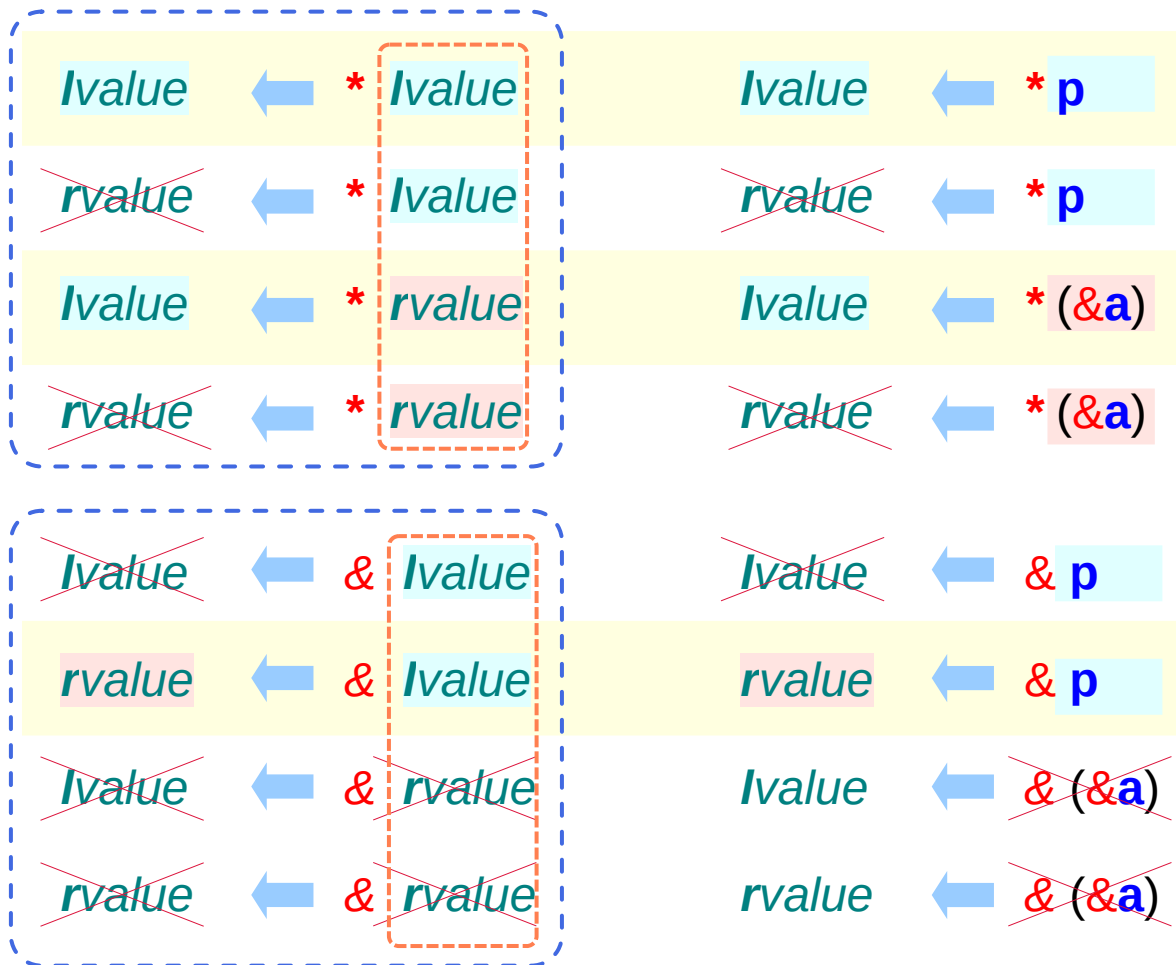

```
int a = 10 ;
int * p = &a ;
```

\* can be applied to either an **lvalue** variable or a **rvalue** address

\* **operand** becomes an **lvalue** variable thus can be applied successively.

& can be applied to only an **lvalue** variable and returns only an **rvalue** address

`a, p` : lvalues ... variables ... RW  
`*p` : lvalues ... variables ... RW  
`&a` : rvalues ... constants ... RO

# Address-of and dereference operators

## Primitive Data Type

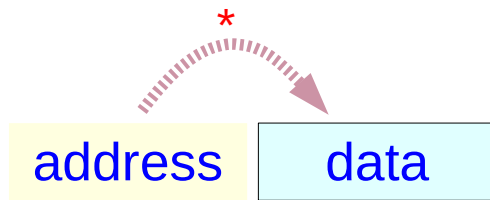

*Ivalue* **p**     *Ivalue* **\*p**  
pointer            variable

*rvalue* **&a**     *Ivalue* **a**  
constant           variable

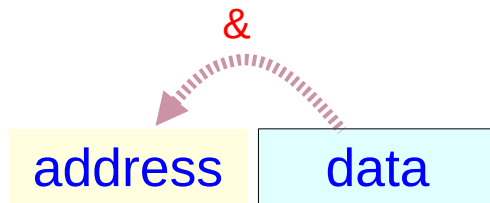

*rvalue* **&a**     *Ivalue* **a**  
constant           variable

## Pointer Data Type

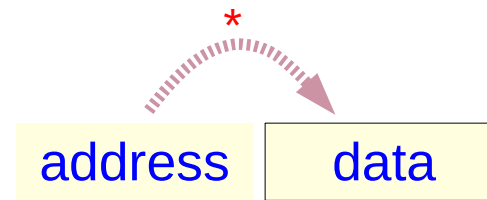

*Ivalue* **q**     *Ivalue* **\*q**  
double pointer   pointer

*rvalue* **&q**     *Ivalue* **q**  
constant         double pointer

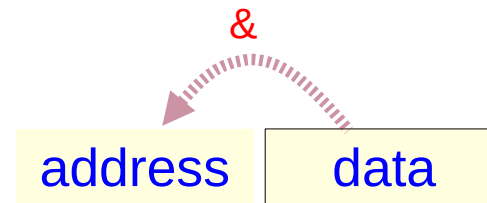

*rvalue* **&q**     *Ivalue* **q**  
constant         double pointer

```
int a;  
int * p;  
int ** q;
```

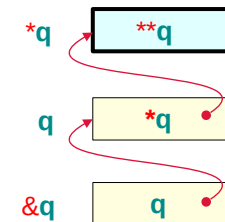
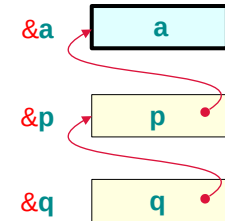

# C operators : & and \*

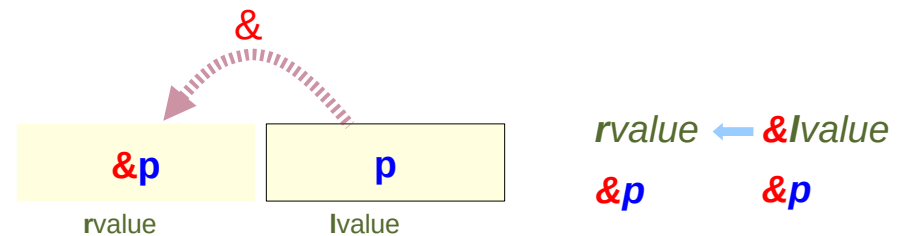
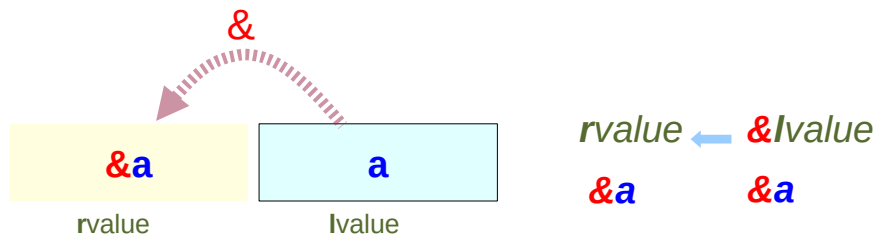
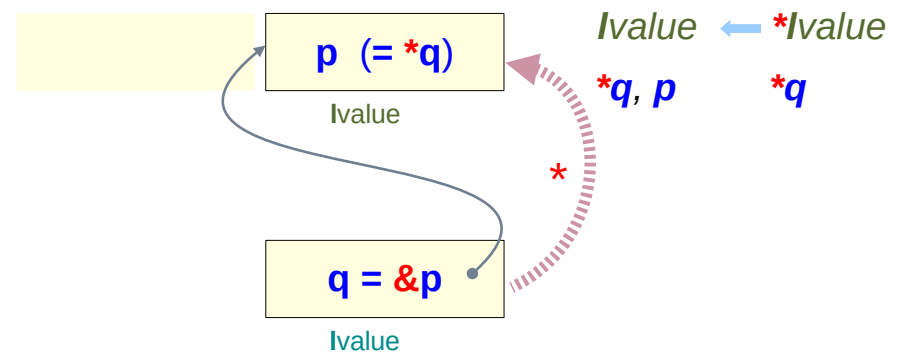
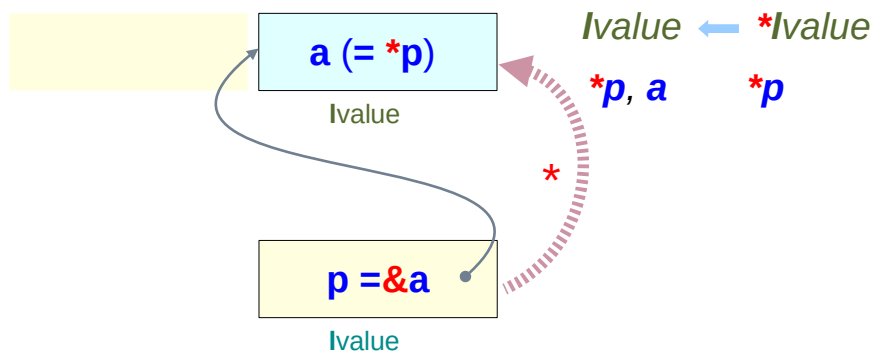
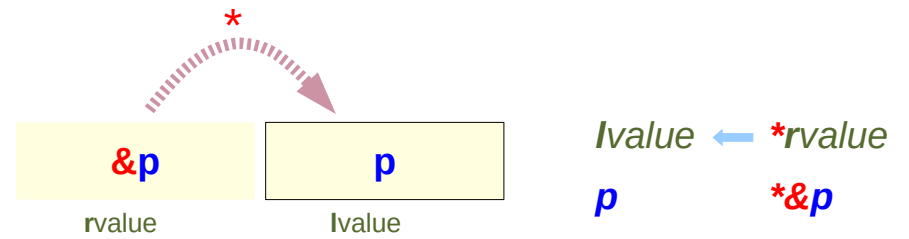
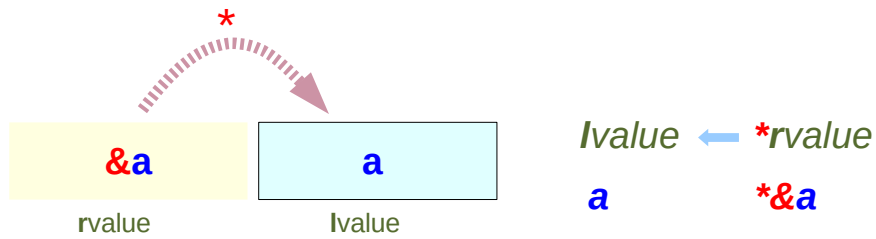

# Mathematical operators : $\bar{\&}$ and $\bar{*}$

## Address-of operation

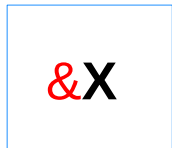

C Expressions

=

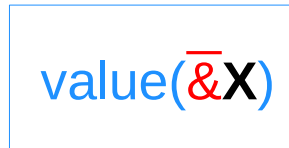

Mixed Expressions

rvalue

rvalue  
 $\bar{\&}X$

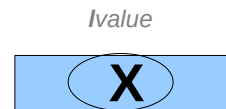

lvalue

$\bar{\&}X$  evaluates the address value of a variable  $X$

$\bar{\&}$  is a mathematical operator (the inverse operator of  $*$ )

$$\text{value}(\bar{\&}X) = \text{value}(\text{value}(\bar{\&}X)) = \text{value}(\bar{\&}X) = \bar{\&}X$$

## De-reference operation

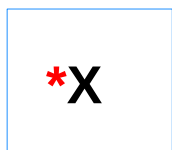

C Expressions

=

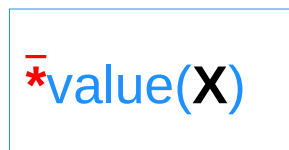

Mixed Expressions

lvalue



rvalue

lvalue



rvalue



lvalue

$X$  must be evaluated to an address before de-referencing

lvalue must be evaluated to rvalue

# & and \* operators in terms of $\bar{\&}$ and $\bar{*}$

## Two step Address-of operation

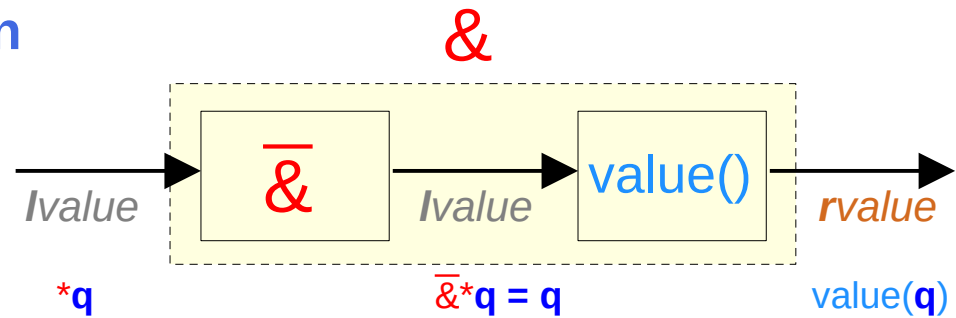

## Two step De-reference operation

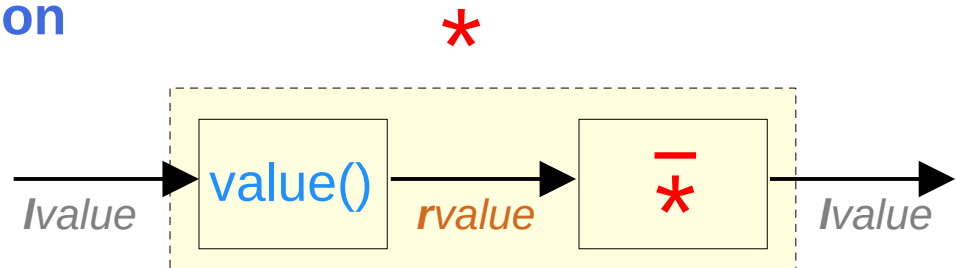
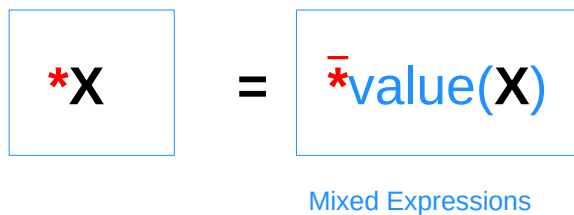

# & and \* operators in terms of $\bar{\&}$ and $\bar{*}$

## Address-of operation

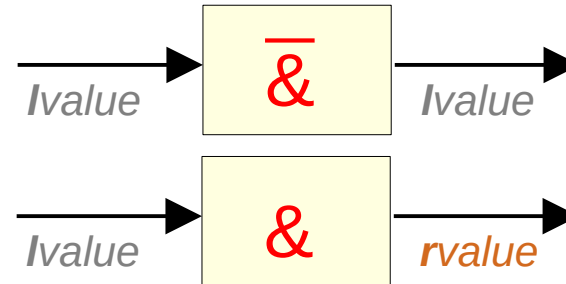

## De-reference operation

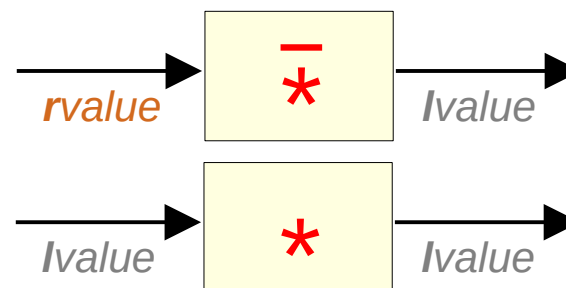
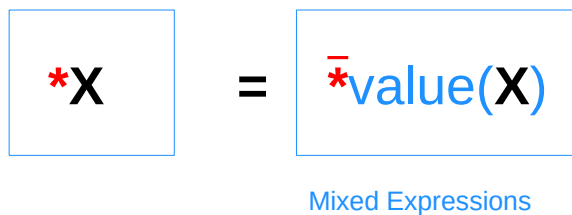



# Inverse operators $\bar{*}$ and $\&$

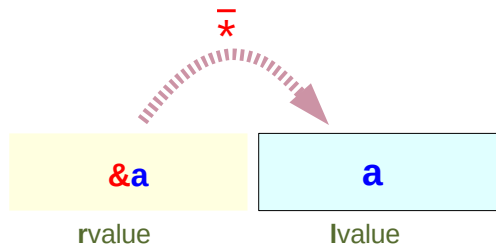

$lvalue = \bar{*}rvalue$   
 $a \leftarrow \bar{*}\&a$

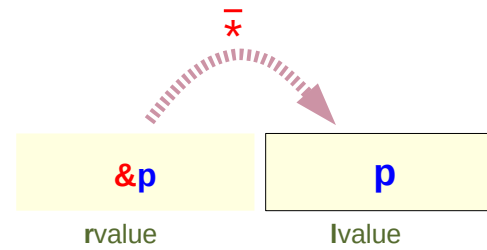

$lvalue = \bar{*}rvalue$   
 $p \leftarrow \bar{*}\&p$

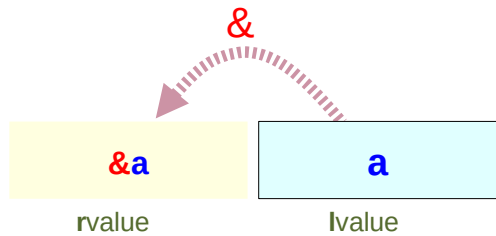

$rvalue = \&lvalue$   
 $\&a \leftarrow \&a$

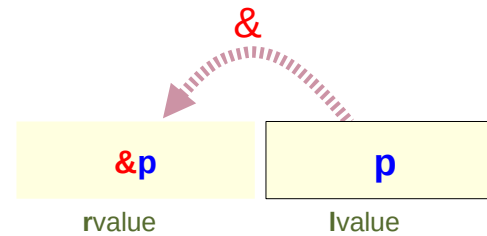

$rvalue = \&lvalue$   
 $\&p \leftarrow \&p$

# Inverse operators $\bar{\&}$ and $\bar{*}$

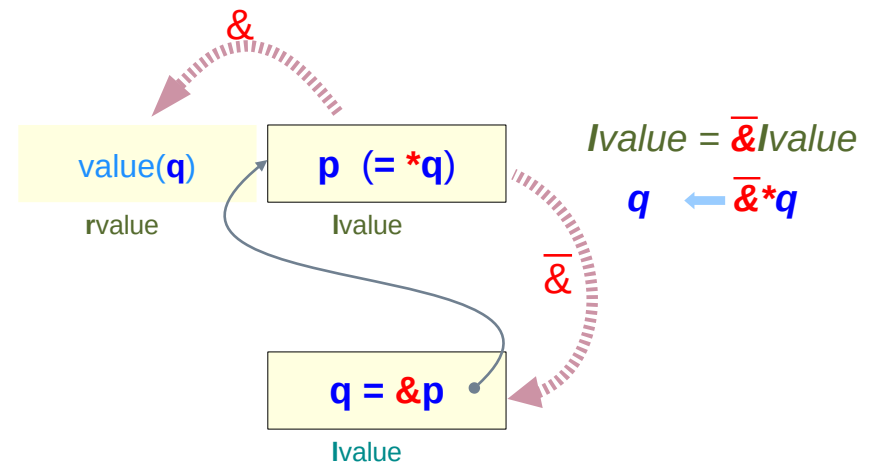
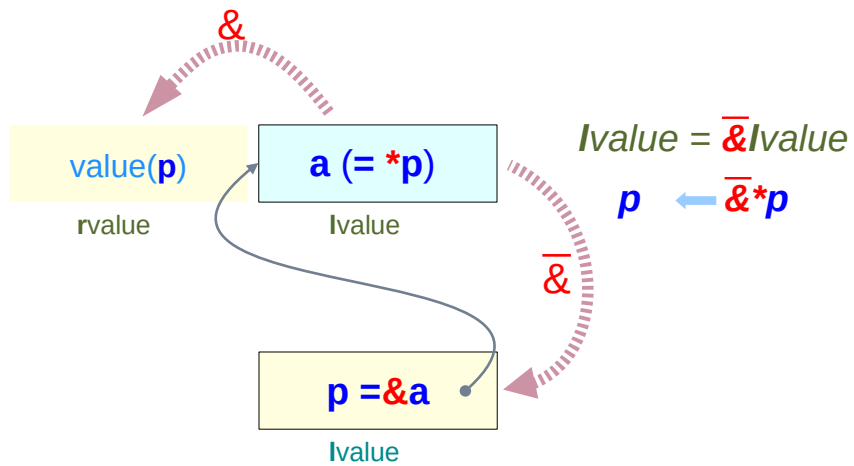
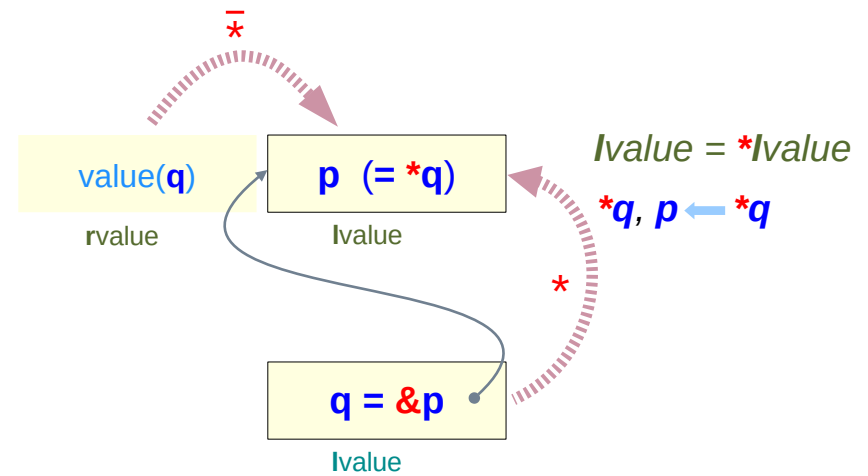
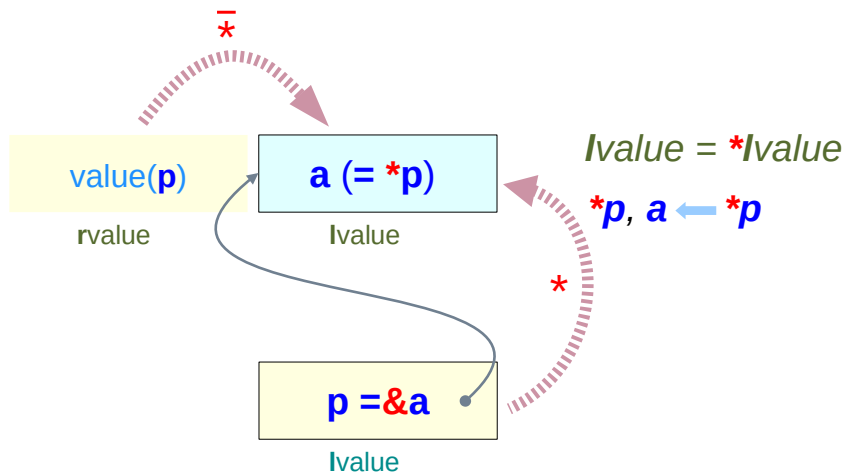

# & and mathematical &

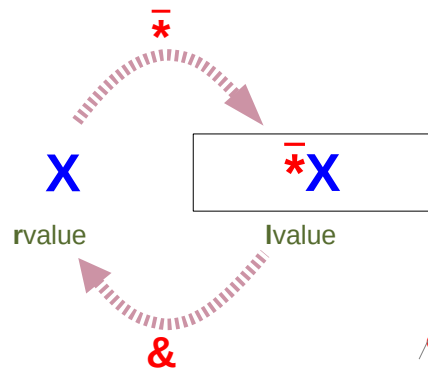

$$\cancel{\&} \bar{*} X = X$$

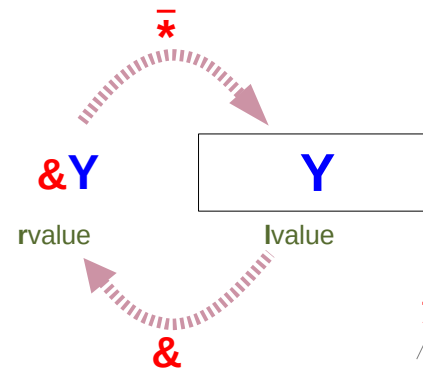

$$\cancel{\bar{*}} \& Y = Y$$

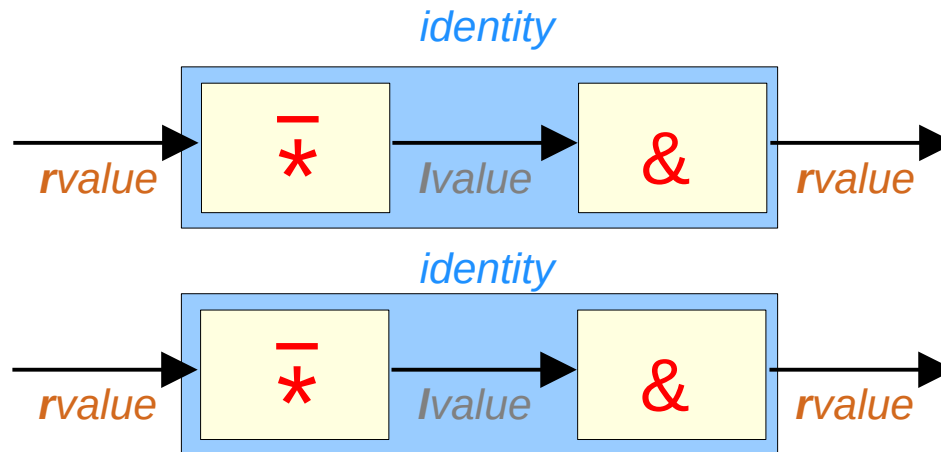

# & and mathematical &

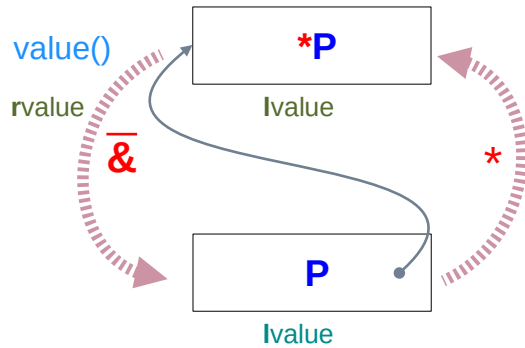

$$\cancel{\&} * P = P$$

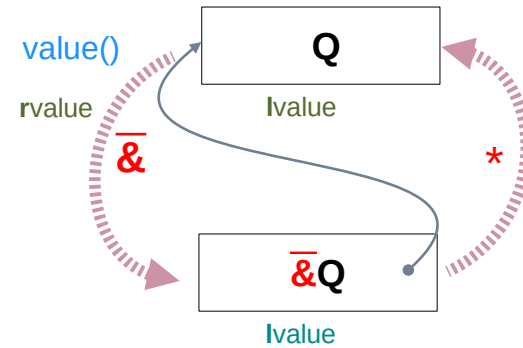

$$* \cancel{\&} Q = Q$$

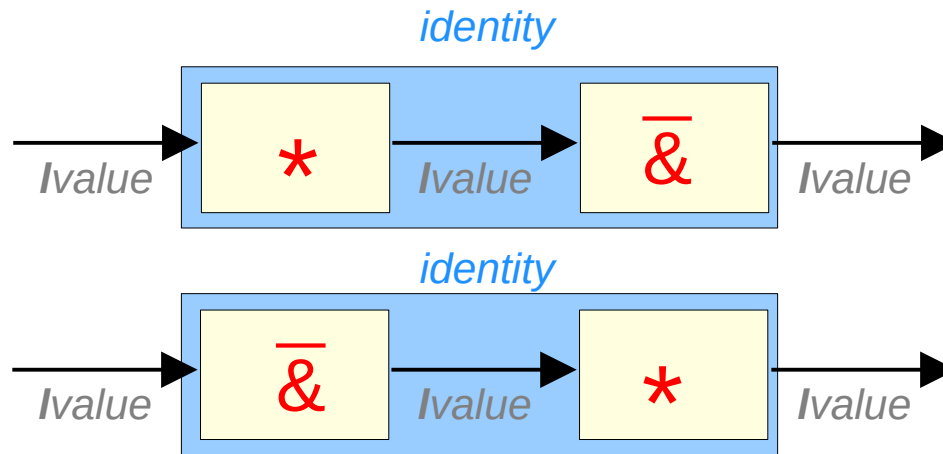

# Byte addresses of sub-arrays in an array

~~&(&(&(c[i])[j])[k])~~

## & C operator

can be applied to only **lvalue** variable

returns **address value**

thus, the above expression is **not** possible

successive application of & is **not** possible

In contrast, **\*p** becomes a lvalue variable

**\*** operator can be applied successively.

# Finding sub-array sizes

```
int c [2][3][4] ;
```

$\text{sizeof}(\text{c}^{[2][3][4]}[\text{i}][\text{j}][0]) = \text{sizeof}(\text{int})$

$\text{sizeof}(\text{c}^{[2][3][4]}[\text{i}][0]) = 4 * \text{sizeof}(\text{int})$

$\text{sizeof}(\text{c}^{[2][3][4]}[\text{i}]) = 3 * 4 * \text{sizeof}(\text{int})$

$\text{sizeof}(\text{c}^{[2][3][4]}) = 2 * 3 * 4 * \text{sizeof}(\text{int})$

# Pointer increments and byte addresses

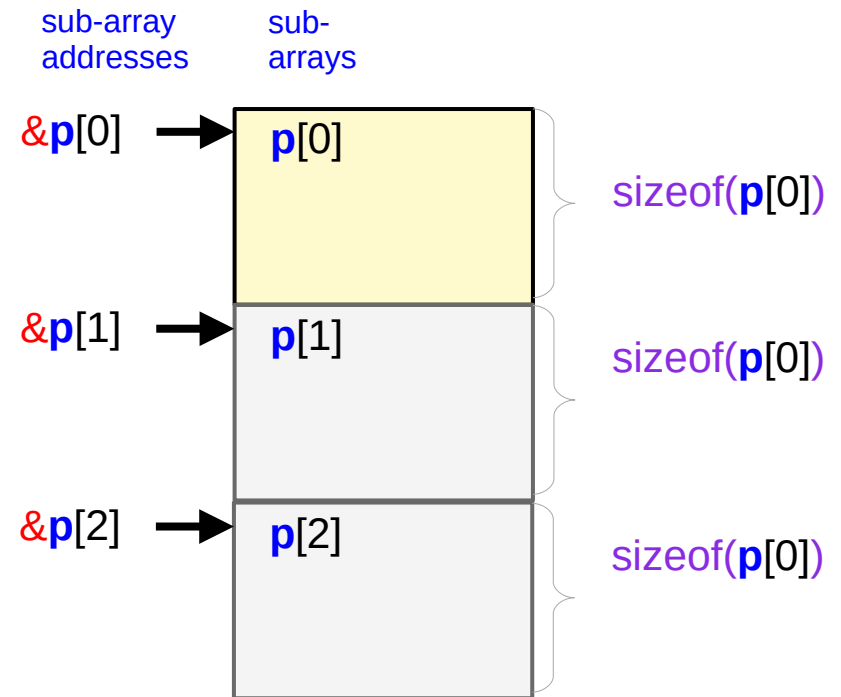
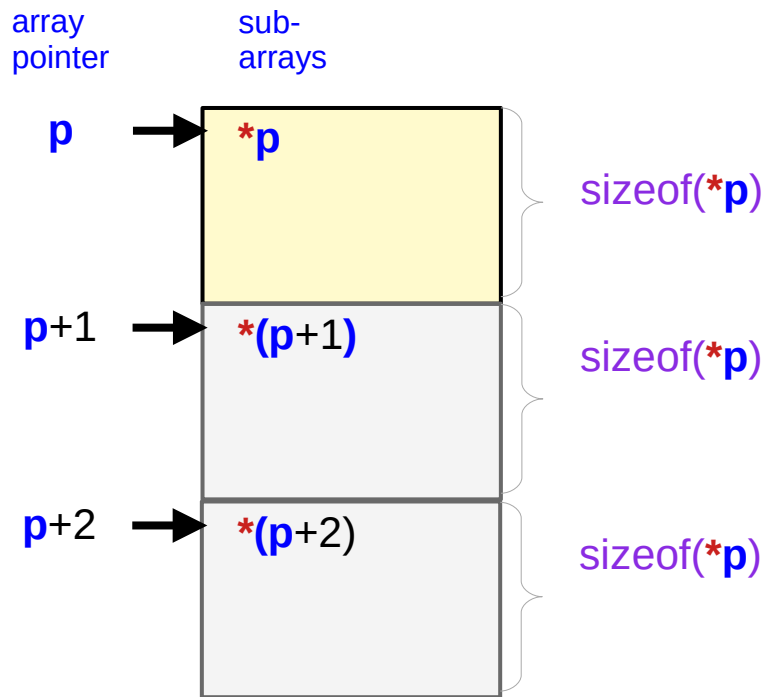

byte address      byte address      byte size

$$\text{value}(\mathbf{p+i}) = \text{value}(\mathbf{p}) + \mathbf{i} * \text{sizeof}(*\mathbf{p})$$

math expression with an explicit size information

$$(\mathbf{p+i})\text{sizeof}(*\mathbf{p})$$

byte address      byte address      byte size

$$\text{value}(\mathbf{\&p[i]}) = \text{value}(\mathbf{p}) + \mathbf{i} * \text{sizeof}(\mathbf{p[0]})$$

math expression with an explicit size information

$$(\mathbf{\&p[i]})\text{sizeof}(*\mathbf{p})$$

# Byte addresses of subarrays $\&c[i]$ , $\&c[i][j]$ , $\&c[i][j][k]$

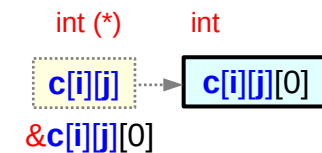
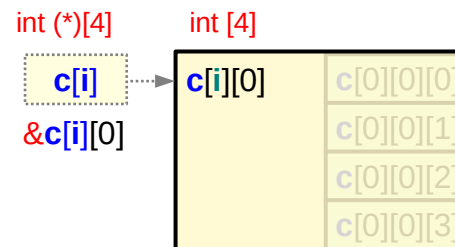
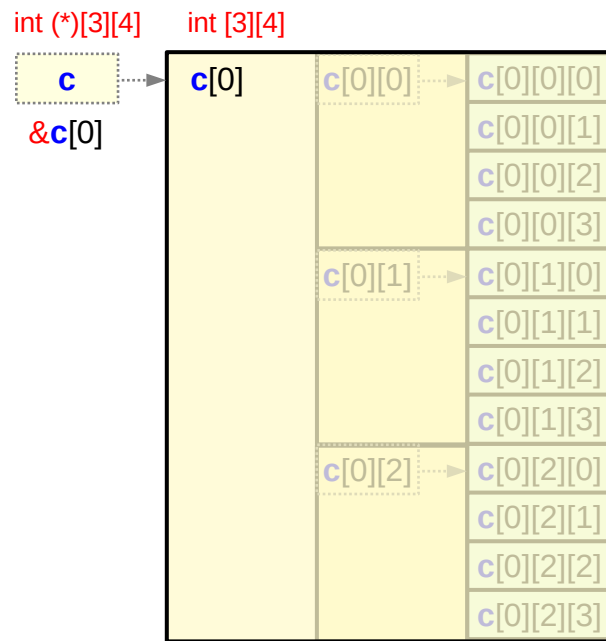

$i = 0:1$   
 $j = 0:2$   
 $k = 0:3$

$$\begin{aligned} \text{value}(\&c[i]) &= \text{value}(c+i) \\ &= \text{value}(c) + i * \text{sizeof}(*c) \\ &= \text{value}(c) + i * \text{sizeof}(c[0]) \\ &= \text{value}(c) + i * \text{sizeof}(\text{int}) * 3 * 4 \end{aligned}$$

skip  $i$  elements of  $*c$  from  $c$

$$(c + i)_{3 \cdot 4 \cdot 4}$$

$$\begin{aligned} \text{value}(\&c[i][j]) &= \text{value}(c[i]+j) \\ &= \text{value}(c[i]) + j * \text{sizeof}(*c[i]) \\ &= \text{value}(c[i]) + j * \text{sizeof}(c[i][0]) \\ &= \text{value}(c[i]) + j * \text{sizeof}(\text{int}) * 4 \end{aligned}$$

skip  $j$  elements of  $*c[i]$  from  $c[i]$

$$(c[i] + j)_{4 \cdot 4}$$

$$\begin{aligned} \text{value}(\&c[i][j][k]) &= \text{value}(c[i][j]+k) \\ &= \text{value}(c[i][j]) + k * \text{sizeof}(*c[i][j]) \\ &= \text{value}(c[i][j]) + k * \text{sizeof}(c[i][j][0]) \\ &= \text{value}(c[i][j]) + k * \text{sizeof}(\text{int}) \end{aligned}$$

skip  $k$  elements of  $*c[i][j]$  from  $c[i][j]$

$$(c[i][j] + k)_{1 \cdot 4}$$



# Address replications and subarray addresses

## Address Replication

transferring pointing address to the pointer that references itself

$$\&X = X$$

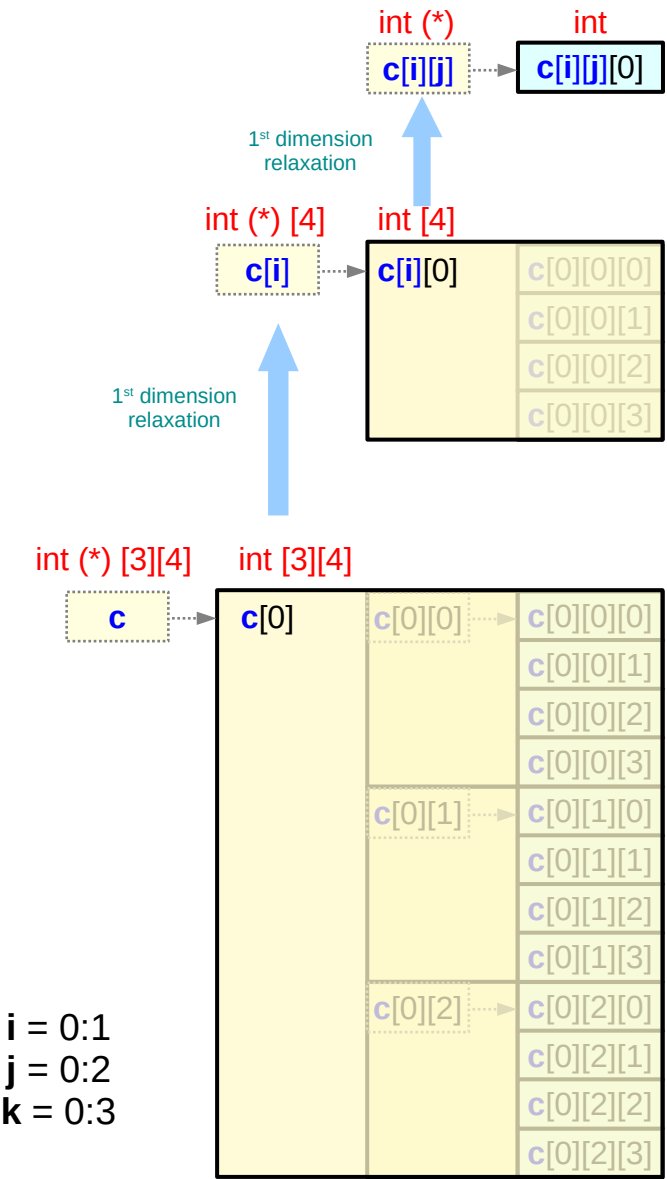
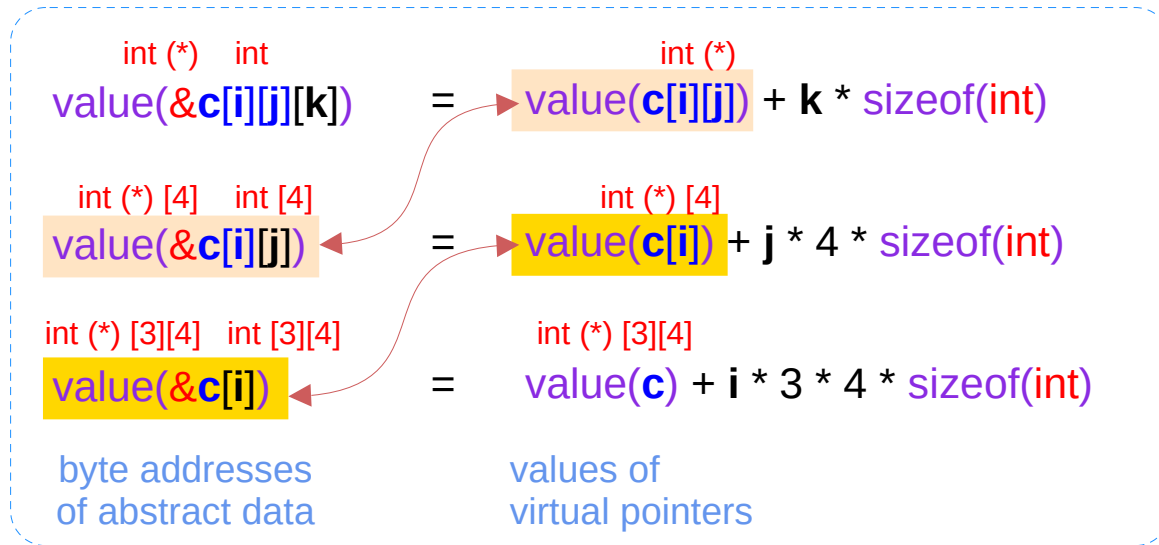

# Address replications in a multi-dimensional array

```
int c [2][3][4] ;
```

## equivalences

```
c[i][j] ≡ &c[i][j][0]
c[i]   ≡ &c[i][0]
c      ≡ &c[0]
```

## address replication

```
value(c[i][j]) = value(&c[i][j])
value(c[i])    = value(&c[i])
value(c)       = value(&c)
```

**c, c[0], c[0][0] :**  
these virtual pointers have  
the same address value

a physical location  
has a unique address



$c \equiv \&c[0]$

$c[0] \equiv \&c[0][0]$

$c[0][0] \equiv \&c[0][0][0]$

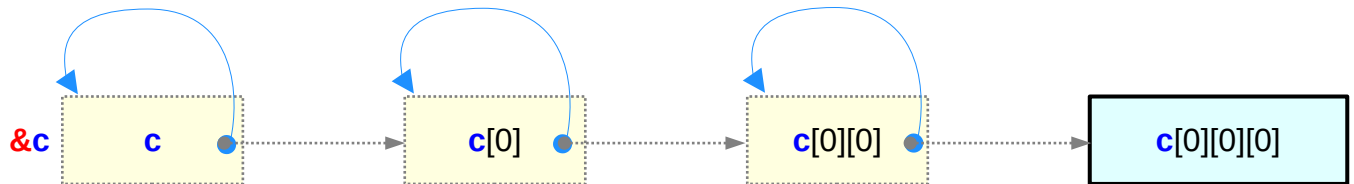
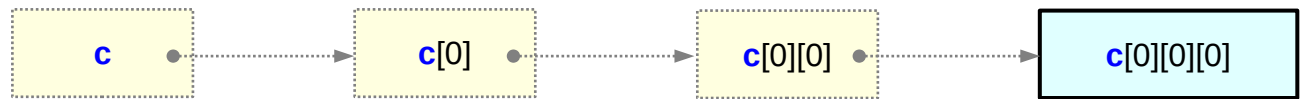

all have the same address value



all have the same starting address

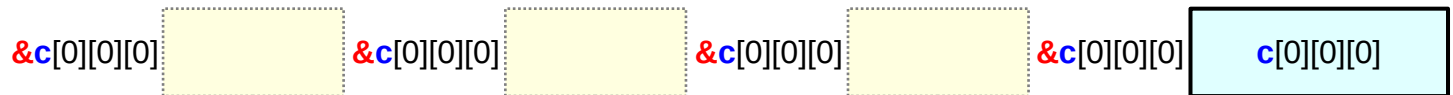

# Referencing sub-arrays

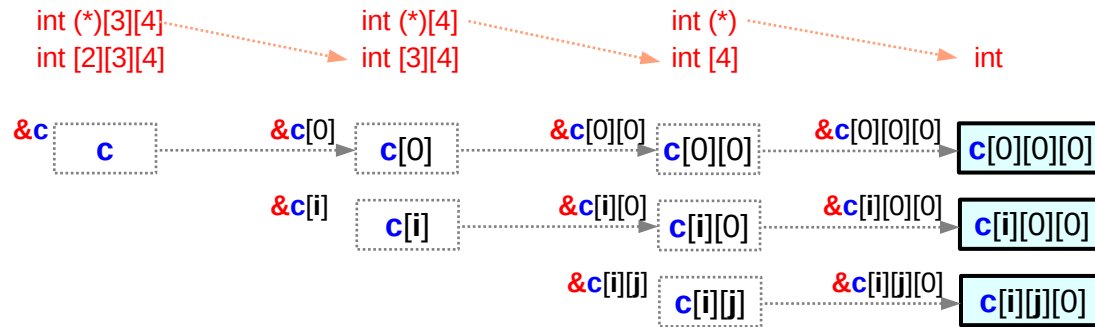

## equivalence relations

$c[i][j] \equiv *(c[i]+j)$      $\&c[i][j] \equiv (c[i]+j)$      $\&c[i][0] \equiv c[i]$   
 $c[i] \equiv *(c+i)$      $\&c[i] \equiv (c+i)$      $\&c[0] \equiv c$

## address replication

$value(c[i][j]) = value(\&c[i][j]) = value(c[i]+j) = *value(c[i]+j)$   
 $value(c[i]) = value(\&c[i]) = value(c+i) = *value(c+i)$

$c[i], c[i][0]$  point to the same data  $c[i][0][0]$   
 $c, c[0], c[0][0]$  point to the same data  $c[0][0][0]$

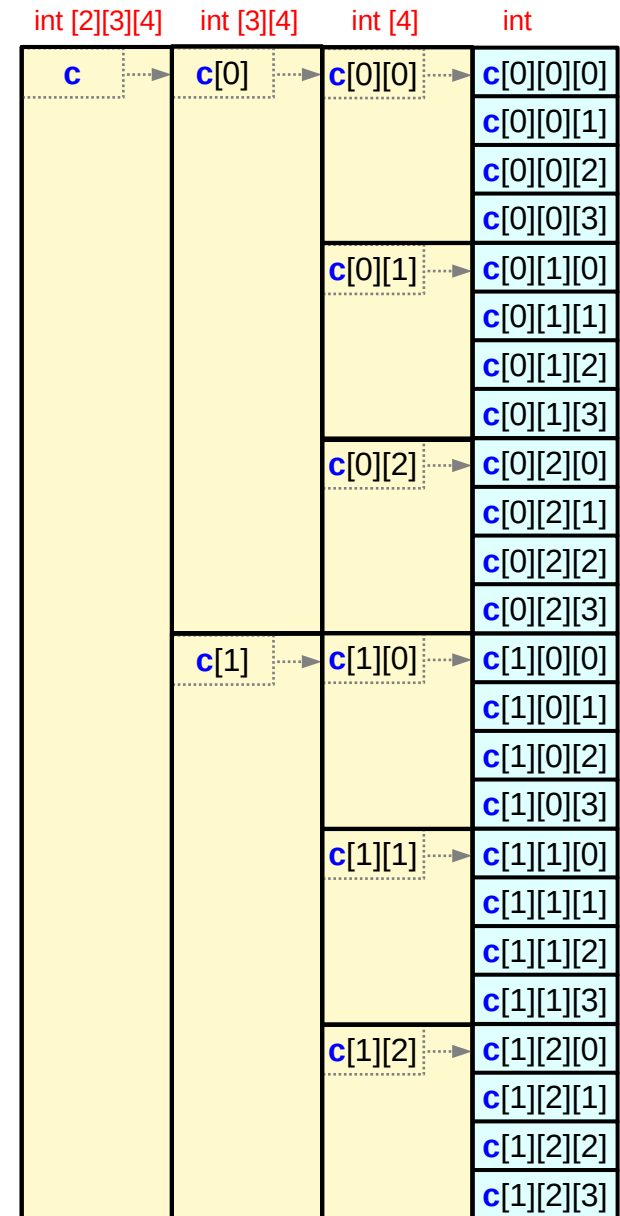

# Types, sizes, and values of sub-arrays

`int c [2][3][4];`      static allocation

```
value(c) = value(c[0]) = value(c[0][0]) = &c[0][0][0]
           value(c[0][1]) = &c[0][1][0]
           value(c[0][2]) = &c[0][2][0]
           value(c[1]) = value(c[1][0]) = &c[1][0][0]
           value(c[1][1]) = &c[1][1][0]
           value(c[1][2]) = &c[1][2][0]
```

```
sizeof(c)    = 2*3*4 * sizeof(int)
sizeof(c[i]) = 3*4 * sizeof(int)
sizeof(c[i][j]) = 4 * sizeof(int)
```

```
type(c)      = int [2][3][4]
              int (*)[3][4]
type(c[i])   = int [3][4]
              int (*)[4]
type(c[i][j]) = int [4]
              int (*)
```

**pointers to arrays**

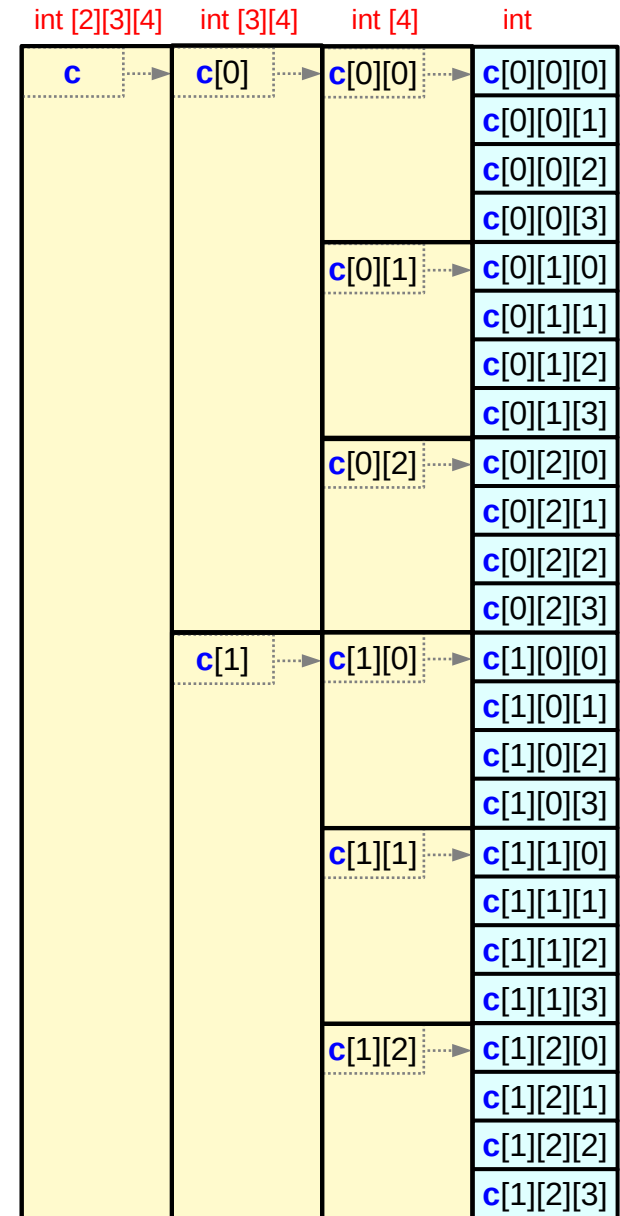

# Using multi-dimensional arrays

---

## **Pointer Array Approach**

– using explicit pointers

## **Array Pointer Approach**

– using implicit pointers

# Two types of 3-d array accesses

## Pointer Array Approach (arrays of pointers)

### Pointer Chain Type I

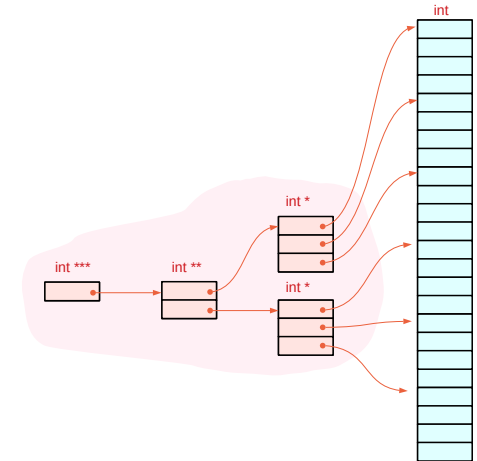
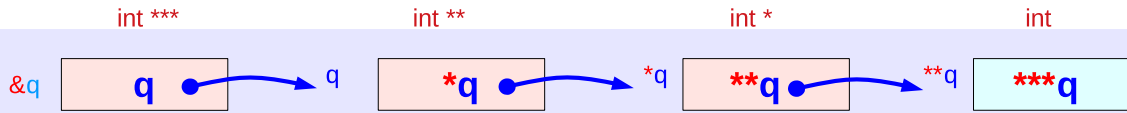

## Array Pointer Approach (pointers to arrays)

### Pointer Chain Type II

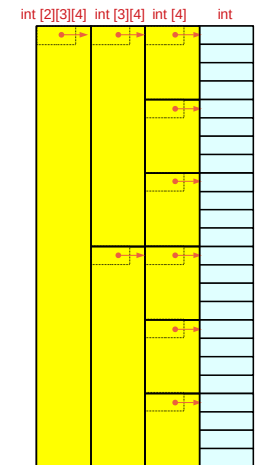
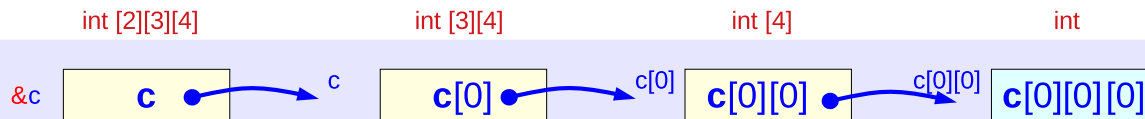

# Pointer addition – **math** and **c** expressions

## Accessing $c[i][j][k]$

– unified  $c$  expressions

skip  $i$  elements  
of  $c[i]$  from  $c$

$(c + i)$

skip  $j$  elements  
of  $c[i][j]$  from  $c[i]$

$(c[i] + j)$

skip  $k$  elements  
of  $c[i][j][k]$  from  $c[i][j]$

$(c[i][j] + k)$

## Pointer Array Approach

$(c + i)_{1 \cdot 4}$

$\text{sizeof}(*c) = 1 \cdot 4$

$(c[i] + j)_{1 \cdot 4}$

$\text{sizeof}(*c[i]) = 1 \cdot 4$

$(c[i][j] + k)_{1 \cdot 4}$

$\text{sizeof}(*c[i][j]) = 1 \cdot 4$

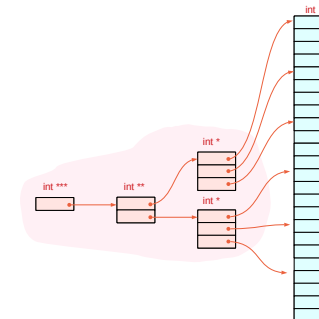

## Array Pointer Approach

$(c + i)_{3 \cdot 4 \cdot 4}$

$\text{sizeof}(*c) = 3 \cdot 4 \cdot 4$

$(c[i] + j)_{4 \cdot 4}$

$\text{sizeof}(*c[i]) = 4 \cdot 4$

$(c[i][j] + k)_{1 \cdot 4}$

$\text{sizeof}(*c[i][j]) = 1 \cdot 4$

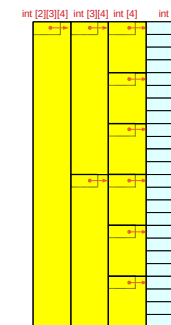

# Accessing $c[i][j][k]$ element

## Accessing $c[i][j][k]$

skip  $i$  elements  
of  $c[i]$  from  $c$

$$(c + i)$$

skip  $j$  elements  
of  $c[i][j]$  from  $c[i]$

$$(c[i] + j)$$

skip  $k$  elements  
of  $c[i][j][k]$  from  $c[i][j]$

$$(c[i][j] + k)$$

## Pointer Array Approach

skip  $i * \text{sizeof}(\text{int}^{**})$   
(=  $i*4$ ) bytes from  $c$

$$(c + i)_{1.4}$$

skip  $j * \text{sizeof}(\text{int}^*)$   
(=  $j*4$ ) bytes from  $c[i]$

$$(c[i] + j)_{1.4}$$

skip  $k * \text{sizeof}(\text{int})$   
(=  $k*4$ ) bytes from  $c[i][j]$

$$(c[i][j] + k)_{1.4}$$

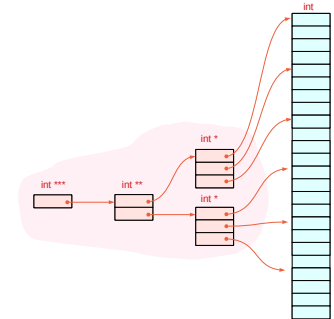

## Array Pointer Approach

skip  $i * \text{sizeof}(\text{int} [3][4])$   
(=  $i*3*4*4$ ) bytes from  $c$

$$(c + i)_{3.4.4}$$

skip  $j * \text{sizeof}(\text{int} [4])$   
(=  $j*4*4$ ) bytes from  $c[i]$

$$(c[i] + j)_{4.4}$$

skip  $k * \text{sizeof}(\text{int})$   
(=  $k*4$ ) bytes from  $c[i][j]$

$$(c[i][j] + k)_{1.4}$$

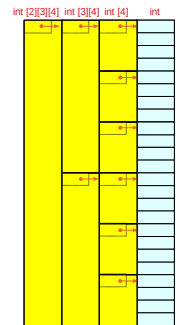



# Accessing $c[i][j][k]$ – Pointer Array Approach

## Pointer Array Approach

skip  $i * \text{sizeof}(\text{int}^{**})$   
=  $i * 4$  bytes from  $c$

$(c + i)_{1..4} \rightarrow c[i]$

skip  $j * \text{sizeof}(\text{int}^*)$   
=  $j * 4$  bytes from  $c[i]$

$(c[i] + j)_{1..4} \rightarrow c[i][j]$

skip  $k * \text{sizeof}(\text{int})$   
=  $k * 4$  bytes from  $c[i][j]$

$(c[i][j] + k)_{1..4} \rightarrow c[i][j][k]$

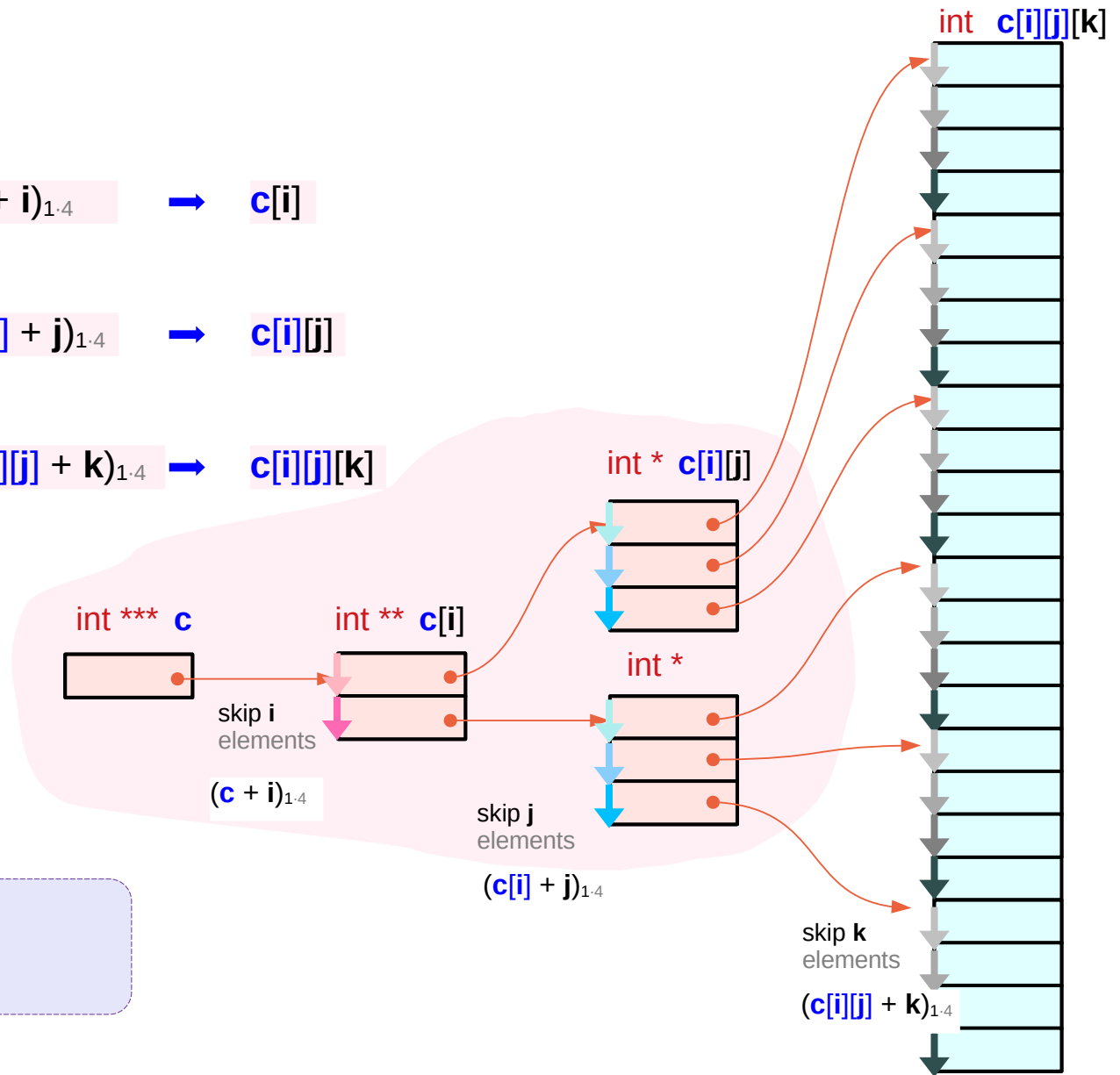

$\text{sizeof}(c[i][j][k]) = \text{sizeof}(\text{int}) = 4$   
 $\text{sizeof}(c[i][j]) = \text{sizeof}(\text{int}^*) = 4$   
 $\text{sizeof}(c[i]) = \text{sizeof}(\text{int}^{**}) = 4$

# Accessing $c[i][j][k]$ – Array Pointer Approach

## Array **Pointer** Approach

skip  $i * \text{sizeof}(\text{int } [3][4])$   
 $= i * 3 * 4 * 4$  bytes from  $c$

$(c + i)_{3 \cdot 4 \cdot 4} \rightarrow c[i]$

skip  $j * \text{sizeof}(\text{int } [4])$   
 $= j * 4 * 4$  bytes from  $c[i]$

$(c[i] + j)_{4 \cdot 4} \rightarrow c[i][j]$

skip  $k * \text{sizeof}(\text{int})$   
 $= k * 4$  bytes from  $c[i][j]$

$(c[i][j] + k)_{1 \cdot 4} \rightarrow c[i][j][k]$

- *subarray partitioning*
- *address replication*

### size information

$\text{sizeof}(c[i][j][k]) = \text{sizeof}(\text{int}) = 4$   
 $\text{sizeof}(c[i][j]) = \text{sizeof}(\text{int } [4]) = 4 * 4$   
 $\text{sizeof}(c[i]) = \text{sizeof}(\text{int } [3][4]) = 3 * 4 * 4$

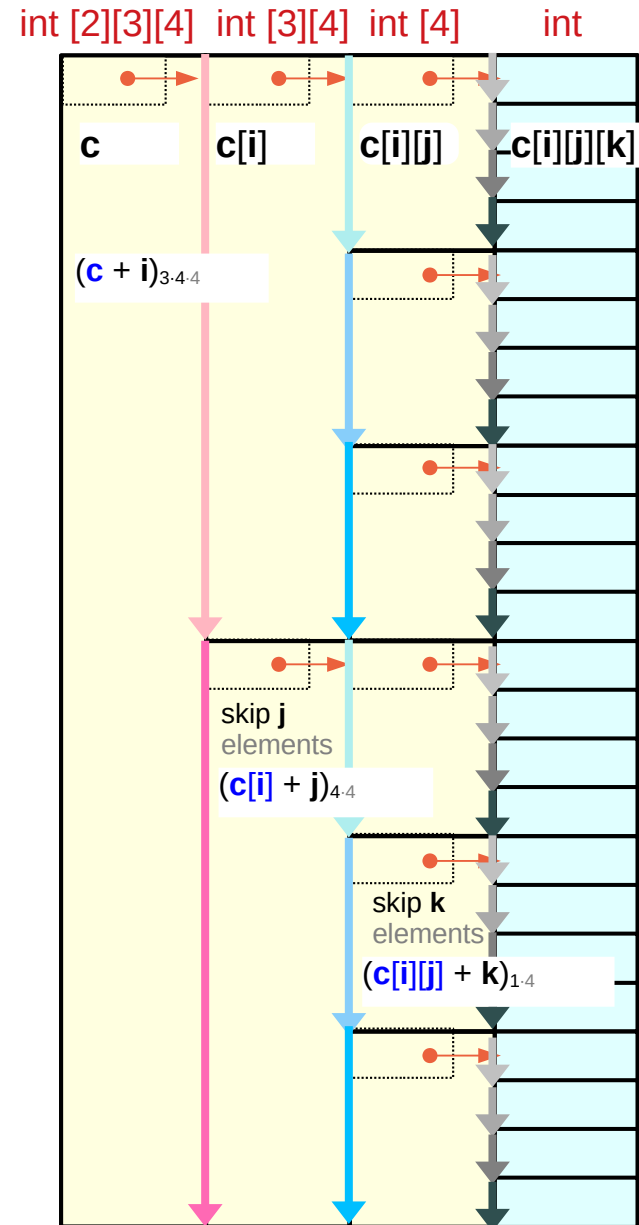

# Array element address – Pointer Array Approach

## equivalence relations – c expressions

$$\begin{aligned}\&c[i][j][k] &= (c[i][j] + k) \\ \&c[i][j] &= (c[i] + j) \\ \&c[i] &= (c + i)\end{aligned}$$

$$\begin{aligned}c[i][j][k] &= *(c[i][j] + k) \\ c[i][j] &= *(c[i] + j) \\ c[i] &= *(c + i)\end{aligned}$$

## size information

$$\begin{aligned}\text{sizeof}(c[i][j][k]) &= \text{sizeof}(\text{int}) = 4 \\ \text{sizeof}(c[i][j]) &= \text{sizeof}(\text{int} *) = 4 \\ \text{sizeof}(c[i]) &= \text{sizeof}(\text{int} **) = 4\end{aligned}$$

## address fetch – math expressions

$$\begin{aligned}\text{value}(c[i][j]) &\Rightarrow *value(c[i] + j)_{1.4} = *value(c[i] + j * 4) && \leftarrow \text{sizeof}(*c[i]) \\ \text{value}(c[i]) &\Rightarrow *value(c + i)_{1.4} = *value(c + i * 4) && \leftarrow \text{sizeof}(*c)\end{aligned}$$

## address of c[i][j][k] – math expressions

$$\begin{aligned}\&c[i][j][k] &= \text{value}(c[i][j] + k)_{1.4} \\ &= \text{value}(*value(c[i] + j)_{1.4} + k * 4) \\ &= \text{value}(*value(*value(c + i)_{1.4} + j * 4) + k * 4) \\ &= \text{value}(*value(*value(c + i * 4) + j * 4) + k * 4)\end{aligned}$$
$$\begin{aligned}\leftarrow \&c[i][j][k] &\equiv (c[i][j] + k) \\ \leftarrow c[i][j] &\equiv *(c[i] + j) \\ \leftarrow c[i] &\equiv *(c + i)\end{aligned}$$

# Array element address – Array Pointer Approach

## equivalence relations – c expressions

$$\begin{aligned} \&c[i][j][k] &= (c[i][j] + k) \\ \&c[i][j] &= (c[i] + j) \\ \&c[i] &= (c + i) \end{aligned}$$

$$\begin{aligned} c[i][j][k] &= *(c[i][j] + k) \\ c[i][j] &= *(c[i] + j) \\ c[i] &= *(c + i) \end{aligned}$$

## size information

$$\begin{aligned} \text{sizeof}(c[i][j][k]) &= \text{sizeof}(\text{int}) = 4 \\ \text{sizeof}(c[i][j]) &= \text{sizeof}(\text{int}[4]) = 4 * 4 \\ \text{sizeof}(c[i]) &= \text{sizeof}(\text{int}[3][4]) = 3 * 4 * 4 \end{aligned}$$

## address replication – math expressions

$$\begin{aligned} \text{value}(c[i][j]) &= \text{value}(\&c[i][j]) &\Rightarrow & \text{value}(c[i] + j)_{4 \cdot 4} = \text{value}(c[i]) + j * 4 * 4 &\leftarrow & \text{sizeof}(*c[i]) \\ \text{value}(c[i]) &= \text{value}(\&c[i]) &\Rightarrow & \text{value}(c + i)_{3 \cdot 4 \cdot 4} = \text{value}(c) + i * 3 * 4 * 4 &\leftarrow & \text{sizeof}(*c) \end{aligned}$$

## address of c[i][j][k] – math expressions

$$\begin{aligned} \&c[i][j][k] &= \text{value}(c[i][j] + k)_{1 \cdot 4} &\leftarrow & \&c[i][j][k] \equiv c[i][j] + k \\ &= \text{value}(c[i] + j)_{4 \cdot 4} + k * 4 &\leftarrow & \&c[i][j] \equiv c[i] + j &\leftarrow & c[i][j] & \text{address replication} \\ &= \text{value}(c + i)_{3 \cdot 4 \cdot 4} + j * 4 * 4 + k * 4 &\leftarrow & \&c[i] \equiv c + i &\leftarrow & c[i] & \text{address replication} \\ &= \text{value}(c) + i * 3 * 4 * 4 + j * 4 * 4 + k * 4 \end{aligned}$$

- address replication
- combining size and address information

# Accessing $c[i][j][k]$ via byte addresses

## Pointer Array Approach

$$\begin{aligned}\&c[i][j][k] &= \text{value}( (c[i][j] + k)_{1 \cdot 4} ) &= \text{value}( c[i][j] + k * 4 ) \\ \&c[i][j] &= \text{value}( (c[i] + j)_{1 \cdot 4} ) &= \text{value}( c[i] + j * 4 ) \\ \&c[i] &= \text{value}( (c + i)_{1 \cdot 4} ) &= \text{value}( c + i * 4 )\end{aligned}$$

$$\begin{aligned}c[i][j][k] &= *value( c[i][j] + k * 4 ) \\ &= *value( *value( c[i] + j * 4 ) + k * 4 ) \\ &= *value( *value( *value( c + i * 4 ) + j * 4 ) + k * 4 )\end{aligned}$$

$$\begin{aligned}c[i][j][k] &= *value( c[i][j] + k * 4 ) \\ c[i][j] &= *value( c[i] + j * 4 ) \\ c[i] &= *value( c + i * 4 )\end{aligned}$$

three memory accesses for  $c[i][j][k]$

## Array Pointer Approach

$$\begin{aligned}\&c[i][j][k] &= \text{value}( (c[i][j] + k)_{1 \cdot 4} ) &= \text{value}( c[i][j] + k * 4 ) \\ \&c[i][j] &= \text{value}( (c[i] + j)_{4 \cdot 4} ) &= \text{value}( c[i] + j * 4 * 4 ) \\ \&c[i] &= \text{value}( (c + i)_{3 \cdot 4 \cdot 4} ) &= \text{value}( c + i * 3 * 4 * 4 )\end{aligned}$$

$$\begin{aligned}c[i][j][k] &= *value( c[i][j] + k * 4 ) \\ &= *value( *value( c[i] + j * 4 * 4 ) + k * 4 ) \\ &= *value( *value( *value( c + i * 3 * 4 * 4 ) + j * 4 * 4 ) + k * 4 ) \\ &= *value( value( value( c + i * 3 * 4 * 4 ) + j * 4 * 4 ) + k * 4 ) \\ &= *value( c + i * 3 * 4 * 4 + j * 4 * 4 + k * 4 )\end{aligned}$$

$$\begin{aligned}c[i][j][k] &= *value( c[i][j] + k * 4 ) \\ c[i][j] &= *value( c[i] + j * 4 * 4 ) \\ c[i] &= *value( c + i * 3 * 4 * 4 )\end{aligned}$$

address replication

single memory access for  $c[i][j][k]$

# Equivalence relations in $c[i][j][k]$

## Pointer Array Approach

$$\begin{aligned}\&c[i][j][k] &= \text{value}(c[i][j] + k * 4) &= \text{value}(c[i][j]) + k * 4 \\ \&c[i][j] &= \text{value}(c[i] + j * 4) &= \text{value}(c[i]) + j * 4 \\ \&c[i] &= \text{value}(c + i * 4) &= \text{value}(c) + i * 4\end{aligned}$$

different semantics !  
be careful in mixed c and math expressions

$$\begin{aligned}c[i][j][k] &\neq *value(c[i][j]) + k * 4 \\ c[i][j] &\neq *value(c[i]) + j * 4 \\ c[i] &\neq *value(c) + i * 4\end{aligned}$$

$$\begin{aligned}c[i][j][k] &= *value(c[i][j] + k * 4) \\ c[i][j] &= *value(c[i] + j * 4) \\ c[i] &= *value(c + i * 4)\end{aligned}$$

## Array Pointer Approach

$$\begin{aligned}\&c[i][j][k] &= \text{value}(c[i][j] + k)_{1 \cdot 4} &= \text{value}(c[i][j]) + k * 4 \\ \&c[i][j] &= \text{value}(c[i] + j)_{4 \cdot 4} &= \text{value}(c[i]) + j * 4 * 4 \\ \&c[i] &= \text{value}(c + i)_{3 \cdot 4 \cdot 4} &= \text{value}(c) + i * 3 * 4 * 4\end{aligned}$$

different semantics !  
be careful in mixed c and math expressions

$$\begin{aligned}c[i][j][k] &\neq *value(c[i][j]) + k * 4 \\ c[i][j] &\neq *value(c[i]) + j * 4 * 4 \\ c[i] &\neq *value(c) + i * 3 * 4 * 4\end{aligned}$$

$$\begin{aligned}c[i][j][k] &= *value(c[i][j] + k * 4) \\ c[i][j] &= *value(c[i] + j * 4 * 4) \\ c[i] &= *value(c + i * 3 * 4 * 4)\end{aligned}$$

# Accessing $c[i][j][k]$

```
int c [L][M][N] ;
```

```
c[i]      ≡ *(c + i)
c[i][j]   ≡ *(c[i] + j)
c[i][j][k] ≡ *(c[i][j] + k)
```

```
&c[i]      ≡ (c + i)
&c[i][j]   ≡ (c[i] + j)
&c[i][j][k] ≡ (c[i][j] + k)
```

equivalence relations

multiple indirections

address replications

$c[i]$	$\equiv$	$*(c+i)$	$\equiv$	$*(c+i)$	$\equiv$	$(c+i)$
$c[i][j]$	$\equiv$	$*(c[i]+j)$	$\equiv$	$*(*(c+i)+j)$	$\equiv$	$((c+i)+j)$
$c[i][j][k]$	$\equiv$	$*(c[i][j]+k)$	$\equiv$	$*(*(*(c+i)+j)+k)$	$\equiv$	$((((c+i)+j)+k)$ $\rightarrow *(c+i+j+k)$

Pointer Array Approach

Array Pointer Approach

# Conditions for $c[i][j][k]$

## Equivalence relations in $c[i][j][k]$

$$\begin{aligned}c[i][j][k] &\equiv *(c[i][j] + k) \\ *(c[i][j] + k) &\equiv *(*c[i] + j) + k \\ *(*c[i] + j) + k &\equiv *(*(*c + i) + j) + k\end{aligned}$$

$$\begin{aligned}c[i][j][k] &\equiv (c[i][j] + k) \\ c[i][j] &\equiv (c[i] + j) \\ c[i] &\equiv (c + i)\end{aligned}$$

## Pointer Array Approach

$$\begin{aligned}c[i][j][k] &\equiv (c[i][j] + k) \\ c[i][j] &\equiv (c[i] + j) \\ c[i] &\equiv (c + i)\end{aligned}$$



contiguous 4  $c[i][j][k]$ 's     $4 * (\text{int } 4 \text{ bytes})$   
contiguous 3  $c[i][j]$ 's     $3 * (\text{int } * 4 \text{ or } 8 \text{ bytes})$   
contiguous 2  $c[i]$ 's     $2 * (\text{int } ** 4 \text{ or } 8 \text{ bytes})$

## Array Pointer Approach

$$\begin{aligned}c[i][j][k] &\equiv (c[i][j] + k) \\ c[i][j] &\equiv (c[i] + j) \\ c[i] &\equiv (c + i)\end{aligned}$$



contiguous 4  $c[i][j][k]$ 's     $4 * (\text{int } 4 \text{ bytes})$   
contiguous 3  $c[i][j]$ 's     $3 * (\text{int } [4] 4*4 \text{ bytes})$   
contiguous 2  $c[i]$ 's     $2 * (\text{int } [3][4] 3*4*4 \text{ bytes})$



# Skipping leaf elements

## Continuity Constraints

$$\begin{aligned}c[i][j][k] &\equiv (c[i][j] + k) \\ c[i][j] &\equiv (c[i] + j) \\ c[i] &\equiv (c + i)\end{aligned}$$



contiguous  $c[i][j][k]$  over  $k=0:3$   
contiguous  $c[i][j]$  over  $j=0:2$   
contiguous  $c[i]$  over  $i=0:1$

## Pointer Array Approach

$(c[i][j] + k)_{1..4}$  skip  $k * 4$  bytes from  $c[i][j]$   
 $(c[i] + j)_{1..4}$  skip  $j * 4$  bytes from  $c[i]$   
 $(c + i)_{1..4}$  skip  $i * 4$  bytes from  $c$

$k$  leaf elements       $k * 4$  bytes  
 $j * 4$  leaf elements       $j * 4 * 4$  bytes  
 $i * 3 * 4$  leaf elements       $i * 3 * 4 * 4$  bytes

## Array Pointer Approach

$(c[i][j] + k)_{1..4}$  skip  $k * 4$  bytes from  $c[i][j]$   
 $(c[i] + j)_{4..4}$  skip  $j * 4*4$  bytes from  $c[i]$   
 $(c + i)_{3..4}$  skip  $i * 3*4*4$  bytes from  $c$

$k$  leaf elements       $k * 4$  bytes  
 $j * 4$  leaf elements       $j * 4 * 4$  bytes  
 $i * 3 * 4$  leaf elements       $i * 3 * 4 * 4$  bytes

---

## 3-d Access `c[i][j][k]`

# Accessing $c[i][j][k]$ – Conditions

## General requirements

```
c[i][j][k] = *(c[i][j]+k)
c[i][j]    = *(c[i]+j)
c[i]       = *(c+i)
```

```
&c[i][j][k] = c[i][j]+k
&c[i][j]    = c[i]+j
&c[i]       = c+i
```

```
&c[i][j][0] = c[i][j]
&c[i][0]    = c[i]
&c[0]       = c
```

## Pointer array approach

```
int** c[2];
int*  b[2*3];
int   c[2*3*4];
```

```
c[i][j][k] :: int
c[i][j]    :: int *
c[i]       :: int **
```

```
c[i] ← &b[i*3]
b[j] ← &a[j*4]
```

## Hierarchical Pointer Arrays

## Array pointer approach

```
int c[2][3][4];
```

```
c[i][j][k] :: int
c[i][j]    :: int [4]
c[i]       :: int [3][4]
```

```
c ← &c[0][0][0]
c[i] ← &c[i][0][0]
c[i][j] ← &c[i][j][0]
```

## Virtual Array Pointers

# Accessing $c[i][j][k]$ – Pointer Array Approach (1)

$c[i] \leftarrow \&b[i*3]$   
 $b[j] \leftarrow \&a[j*4]$

$[2][3][4]$



$c[i] \equiv *(c + i)$   
 $c[i][j] \equiv *(c[i] + j)$   
 $c[i][j][k] \equiv *(c[i][j] + k)$

$\&c[i] \equiv (c + i)$   
 $\&c[i][j] \equiv (c[i] + j)$   
 $\&c[i][j][k] \equiv (c[i][j] + k)$

$b[j] \equiv (a + j*4)$

$*(b[j]+k) = *(a+j*4+k);$

$b[j][k] \equiv a[j*4+k]$

$c[i] \equiv (b + i*3)$

$*(c[i]+j) = *(b+i*3+j);$

$c[i][j] \equiv b[i*3+j]$

$*(c[i][j]+k) = *(b[i*3+j]+k);$



$c[i][j] \equiv (a + (i*3+j)*4)$

$*(c[i][j]+k) = *(a+(i*3+j)*4+k);$

$c[i][j][k] \equiv a[(i*3+j)*4+k]$

```

int** c[2];
int* b[2*3];
int a[2*3*4];
    
```

# Accessing `c[i][j][k]` – Pointer Array Approach (2)

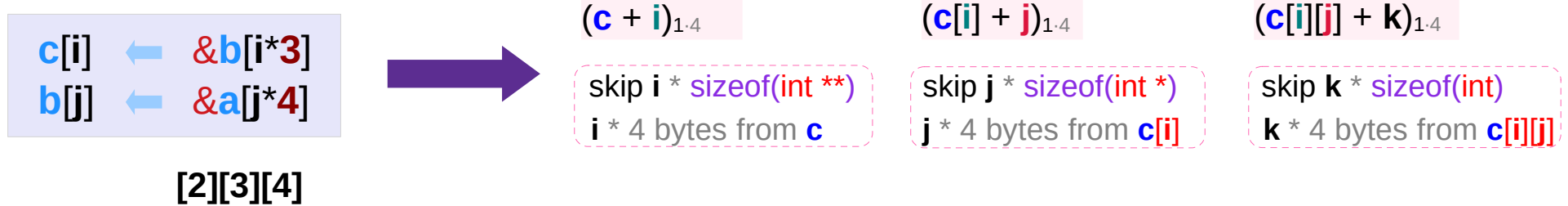

`b[j]`  $\equiv (a + j * 4)$   
 skip  $j$  elements of `b`      skip  $j * 4$  elements of `a`

`c[i]`  $\equiv (b + i * 3)$   
 skip  $i$  elements of `c`      skip  $i * 3$  elements of `b`

`b[j][k]`  $\equiv a[j * 4 + k]$   
 skip  $j$  elements of `b` + skip  $k$  elements of `a`

`c[i][j]`  $\equiv b[i * 3 + j]$   
 skip  $i$  elements of `c` + skip  $j$  elements of `b`      skip  $i * 3$  elements of `b` + skip  $j$  elements of `b`

`c[i][j]`  $\equiv (a + (i * 3 + j) * 4)$   
 skip  $i * 3 * 4$  elements of `a` + skip  $j * 4$  elements of `a`

```

int** c[2];
int*  b[2*3];
int   a[2*3*4];
    
```

`c[i][j][k]`  $\equiv a[(i * 3 + j) * 4 + k]$   
 skip  $i * 3 * 4$  elements of `a` + skip  $j * 4$  elements of `a` + skip  $k$  elements of `a`

# Accessing $c[i][j][k]$ – Array Pointer Approach (1)

$c$	←	$\&c[0][0][0]$
$c[i]$	←	$\&c[i][0][0]$
$c[i][j]$	←	$\&c[i][j][0]$



$c[i]$	$\equiv$	$*(c + i)$
$c[i][j]$	$\equiv$	$*(c[i] + j)$
$c[i][j][k]$	$\equiv$	$*(c[i][j] + k)$

$\&c[i]$	$\equiv$	$(c + i)$
$\&c[i][j]$	$\equiv$	$(c[i] + j)$
$\&c[i][j][k]$	$\equiv$	$(c[i][j] + k)$

**[2][3][4]**

$value(c)$	$=$	$\&c[0][0][0]$
$value(c[i])$	$=$	$\&c[i][0][0]$
$value(c[i][j])$	$=$	$\&c[i][j][0]$
$value(c[i][j][k])$	$=$	$\&c[i][j][k]$



$sizeof(c)$	$=$	$2*3*4*sizeof(int)$
$sizeof(c[i])$	$=$	$3*4*sizeof(int)$
$sizeof(c[i][j])$	$=$	$4*sizeof(int)$
$sizeof(c[i][j][k])$	$=$	$sizeof(int)$



$value(c[i])$	$=$	$\&c[0][0][0] + i * 3*4*sizeof(int)$
$value(c[i][j])$	$=$	$\&c[i][0][0] + j * 4*sizeof(int)$
$value(c[i][j][k])$	$=$	$\&c[i][j][0] + k * sizeof(int)$



$\&c[i]$	$=$	$value(c) + i * sizeof(*c)$
$\&c[i][j]$	$=$	$value(c[i]) + j * sizeof(*c[i])$
$\&c[i][j][k]$	$=$	$value(c[i][j]) + k * sizeof(*c[i][j])$



$c[i]$	$\equiv$	$*(c + i)$
$c[i][j]$	$\equiv$	$*(c[i] + j)$
$c[i][j][k]$	$\equiv$	$*(c[i][j] + k)$

# Accessing $c[i][j][k]$ – Array Pointer Approach (2)

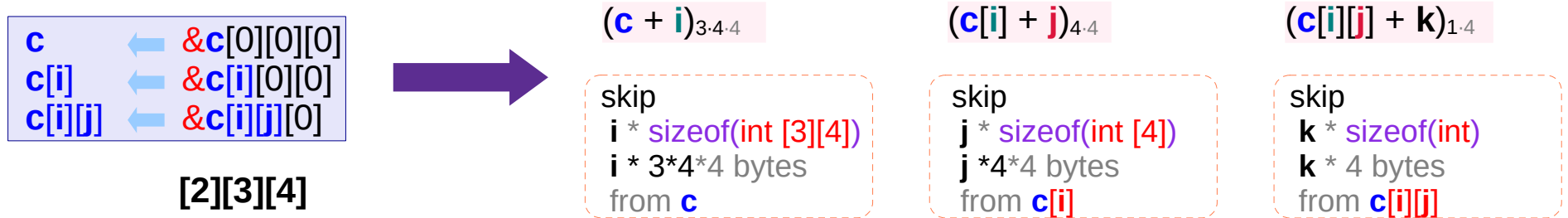

$$\text{value}(c[i]) = \&c[i][0][0]$$

$$\text{value}(c[i][j]) = \&c[i][j][0]$$

$$\text{value}(c[i][j][k]) = \&c[i][j][k]$$

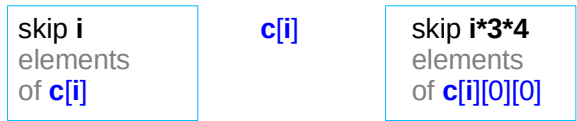
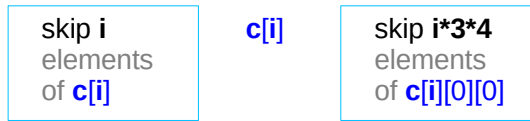
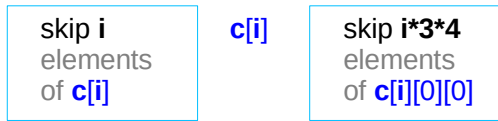

---

# Pointer Chain Types



# Pointer Chain Types

## Pointer Chain Type I

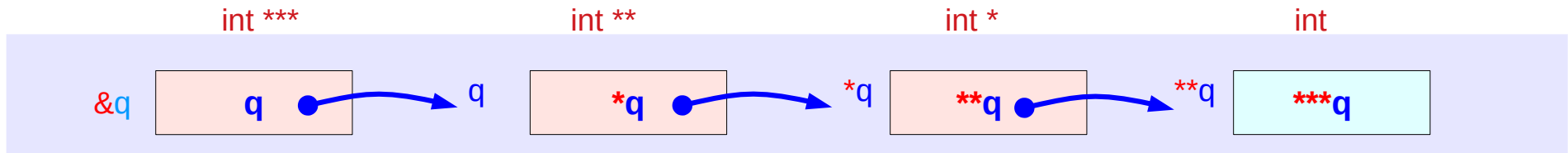

- **Pointer Array Approach** (index operations are handled by a user)

## Pointer Chain Type II

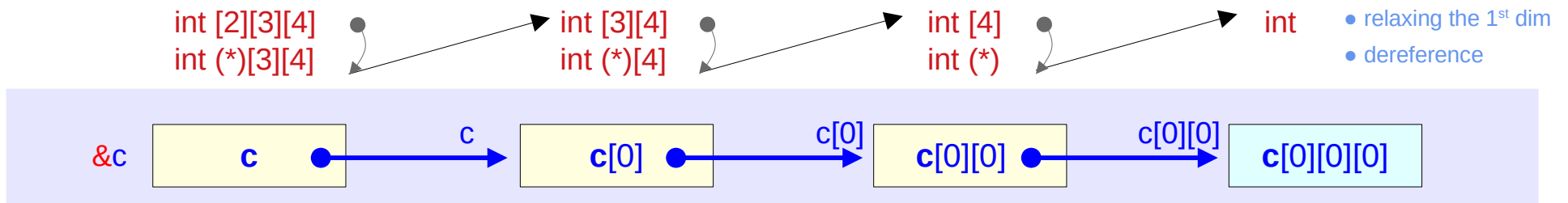

- **Array Pointer Approach** (index operations are handled by a compiler)

# Examples of two step dereferencing in type II

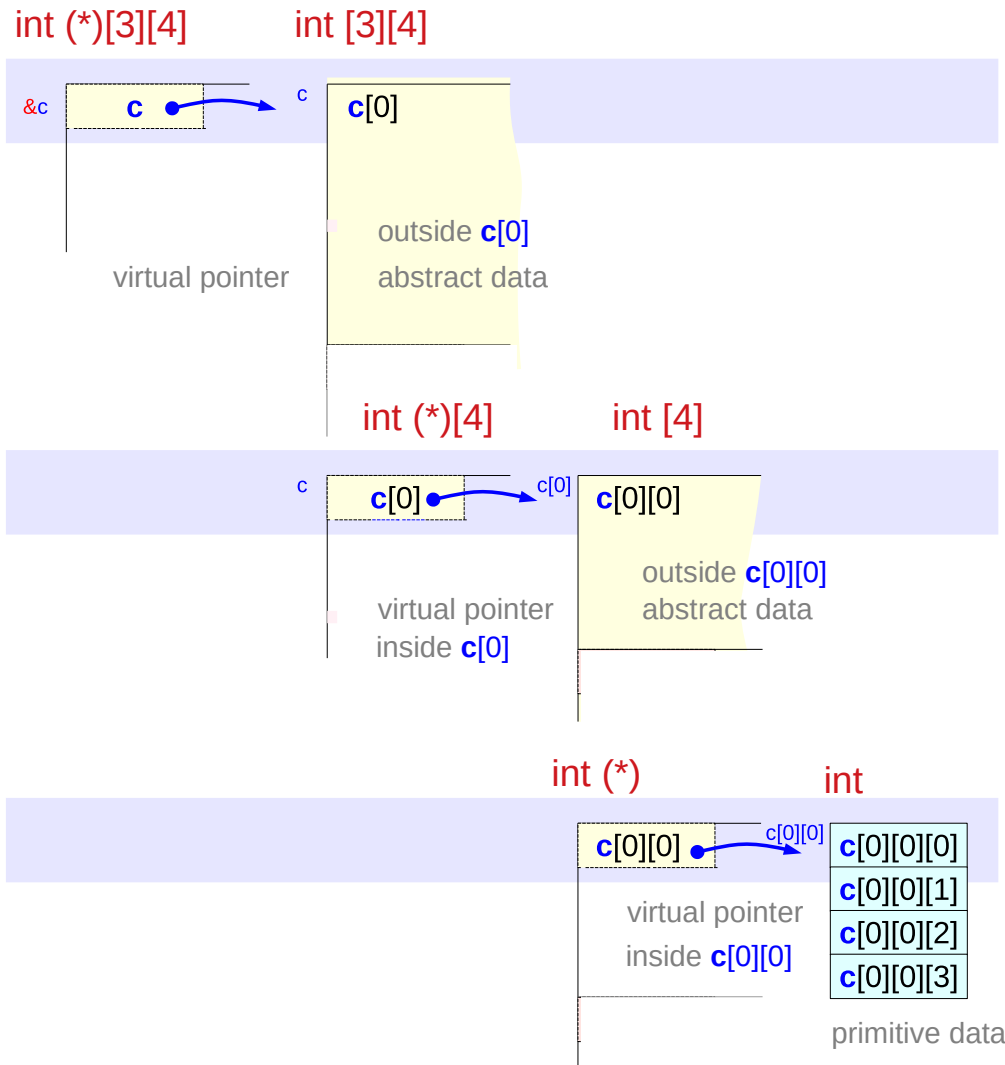

int [3][4]  
c[0]  
abstract data

relaxing  
the 1<sup>st</sup> dim

sizeof(c[0]) =  
3 \* sizeof(c[0][0])

within an array c[0]  
of int[3][4] type, c[0]  
can be relaxed to  
a pointer of  
int (\*)[4] type

$c[0][0] = *(c[0]+0)_{4,4}$   
Math Expression

int (\*)[4]  
c[0]  
virtual pointer

int [4]  
c[0][0]  
abstract data  
relaxing  
the 1<sup>st</sup> dim

sizeof(c[0][0]) =  
4 \* sizeof(c[0][0][0])

within an array c[0][0]  
of int [4] type, c[0][0]  
can be relaxed to  
a pointer of  
int (\*) type

$c[0][0][0] = *(c[0][0]+0)_{1,4}$   
Math Expression

int (\*)  
c[0][0]  
virtual pointer

int  
c[0][0][0]  
abstract data

# Pointer Chains in Type II (1)

## Pointer Chain Type II

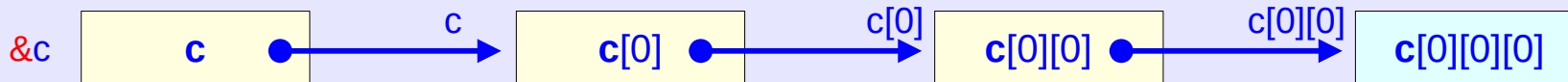
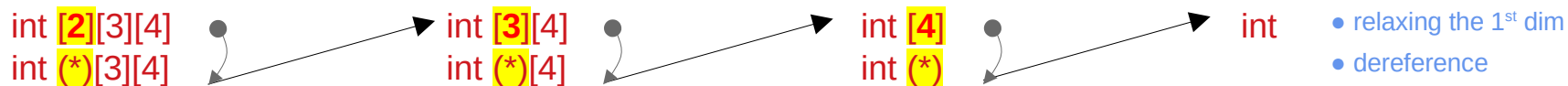

$c$  points to **2** elements  
 $\text{sizeof}(c) = 2 * \text{sizeof}(c[i])$   
 $c[i] \quad i=0,1$   
 $*(c+i)_{3,4,4}$

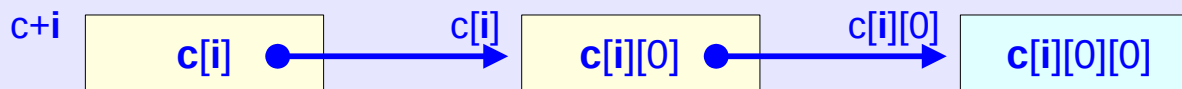

$c[i]$  points to **3** elements  
 $\text{sizeof}(c[i]) = 3 * \text{sizeof}(c[i][j])$   
 $c[i][j] \quad j=0,1,2$   
 $*(c[i]+j)_{4,4}$

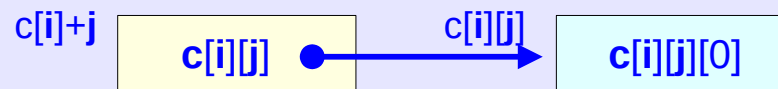

$c[i][j]$  points to **4** elements  
 $\text{sizeof}(c[i][j]) = 4 * \text{sizeof}(c[i][j][k])$   
 $c[i][j][k] \quad k=0,1,2,3$   
 $*(c[i][j]+k)_{1,4}$

# Pointer Chains in Type II (2)

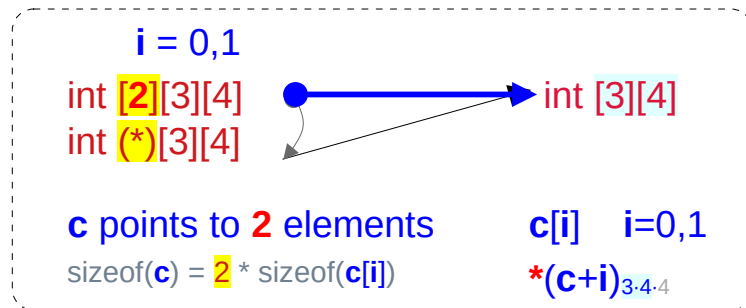

- relaxing the 1<sup>st</sup> dim
- dereference

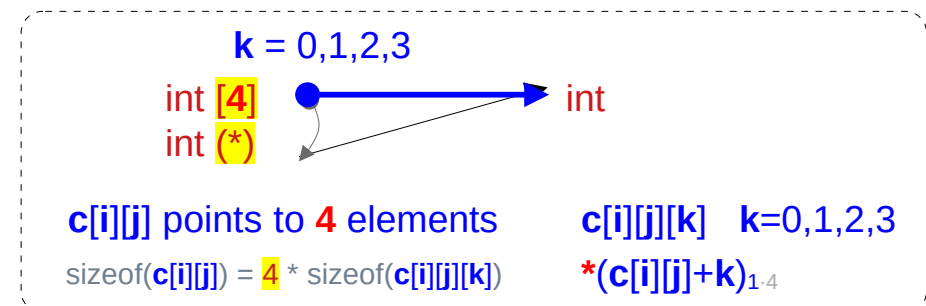
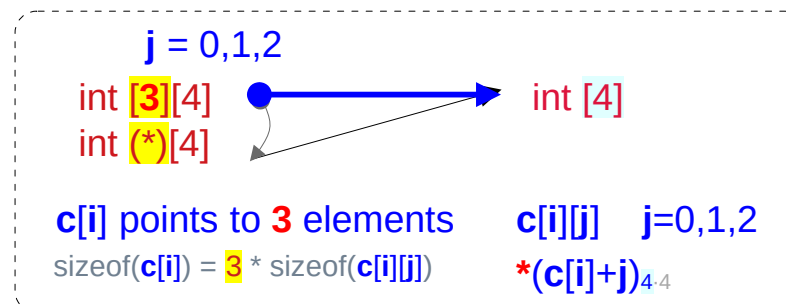

# Pointer Chain Type I – \* and & operators

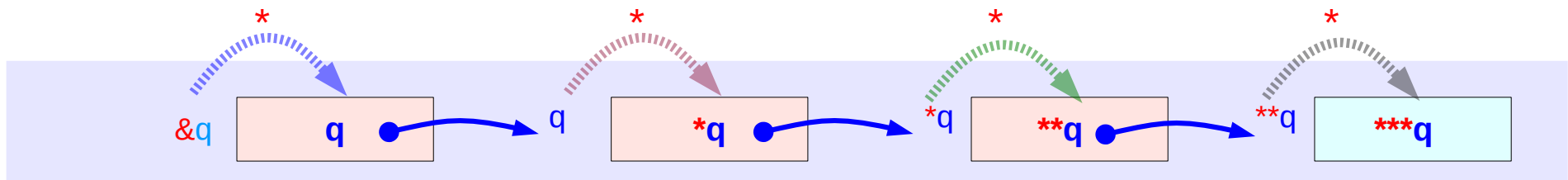

$$*(\&q) \equiv q$$

C expression  $*(\&q)$  equals to the variable  $q$

$$*(q) \equiv *q$$

C expression  $*(q)$  equals to the variable  $q$

$$*(*q) \equiv **q$$

C expression  $*(*q)$  equals to the variable  $**q$

$$**(**q) \equiv ***q$$

C expression  $**(**q)$  equals to the variable  $***q$

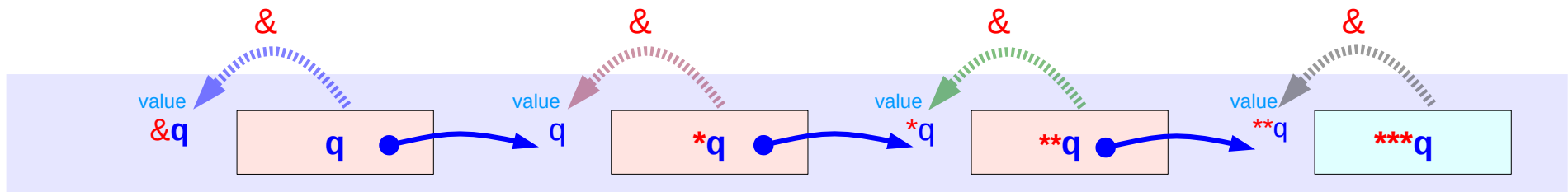

$$\&q \equiv \text{value}(\&q)$$

C expression  $\&q$  equals to  $\text{value}(\&q)$  which is the address value of a variable  $q$

$$\&(*q) \equiv \text{value}(q)$$

C expression  $\&(*q)$  equals to  $\text{value}(q)$  which is the address value of a variable  $*q$

$$\&(**q) \equiv \text{value}(*q)$$

C expression  $\&(**q)$  equals to  $\text{value}(*q)$  which is the address value of a variable  $**q$

$$\&(****q) \equiv \text{value}(**q)$$

C expression  $\&(****q)$  equals to  $\text{value}(**q)$  which is the address value of a variable  $***q$

# Pointer Chain Type II – \* and & operators

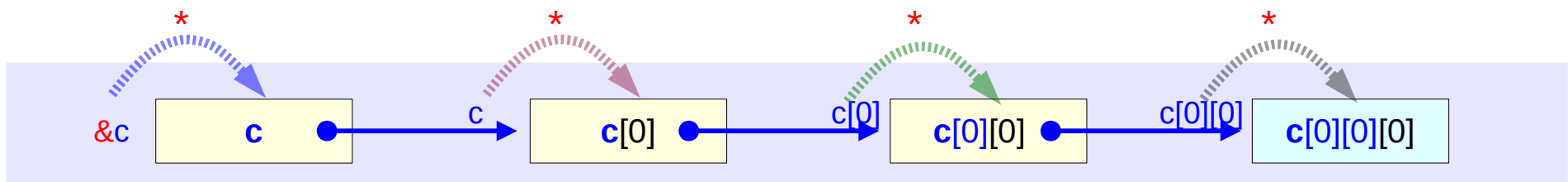

$$*(\&c) \equiv c$$

$$*(c) \equiv c[0]$$

$$*(c[0]) \equiv c[0][0]$$

$$*(c[0][0]) \equiv c[0][0][0]$$

(int (\*)[3][4]) **c** can be viewed as a pointer to (int [3][4]) **c[0]**

(int (\*)[4]) **c[0]** can be viewed as a pointer to (int [4]) **c[0][0]**

(int (\*)) **c[0][0]** can be viewed as a pointer to (int) **c[0][0][0]**

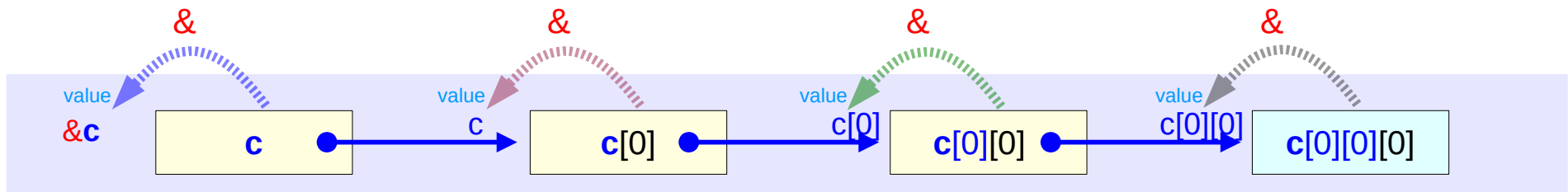

$$\&c \equiv \text{value}(\&c)$$

$$\&(c[0]) \equiv \text{value}(c)$$

$$\&(c[0][0]) \equiv \text{value}(c[0])$$

$$\&(c[0][0][0]) \equiv \text{value}(c[0][0])$$

(int (\*)[3][4]) **c** has the address value of (int [3][4]) **c[0]**

(int (\*)[4]) **c[0]** has the address value of (int [4]) **c[0][0]**

(int (\*)) **c[0][0]** has the address value of (int) **c[0][0][0]**

# Pointer Chain Type I – skipping elements

## Pointer Chain Type I

*multiple indirection*

*size: pointer size*

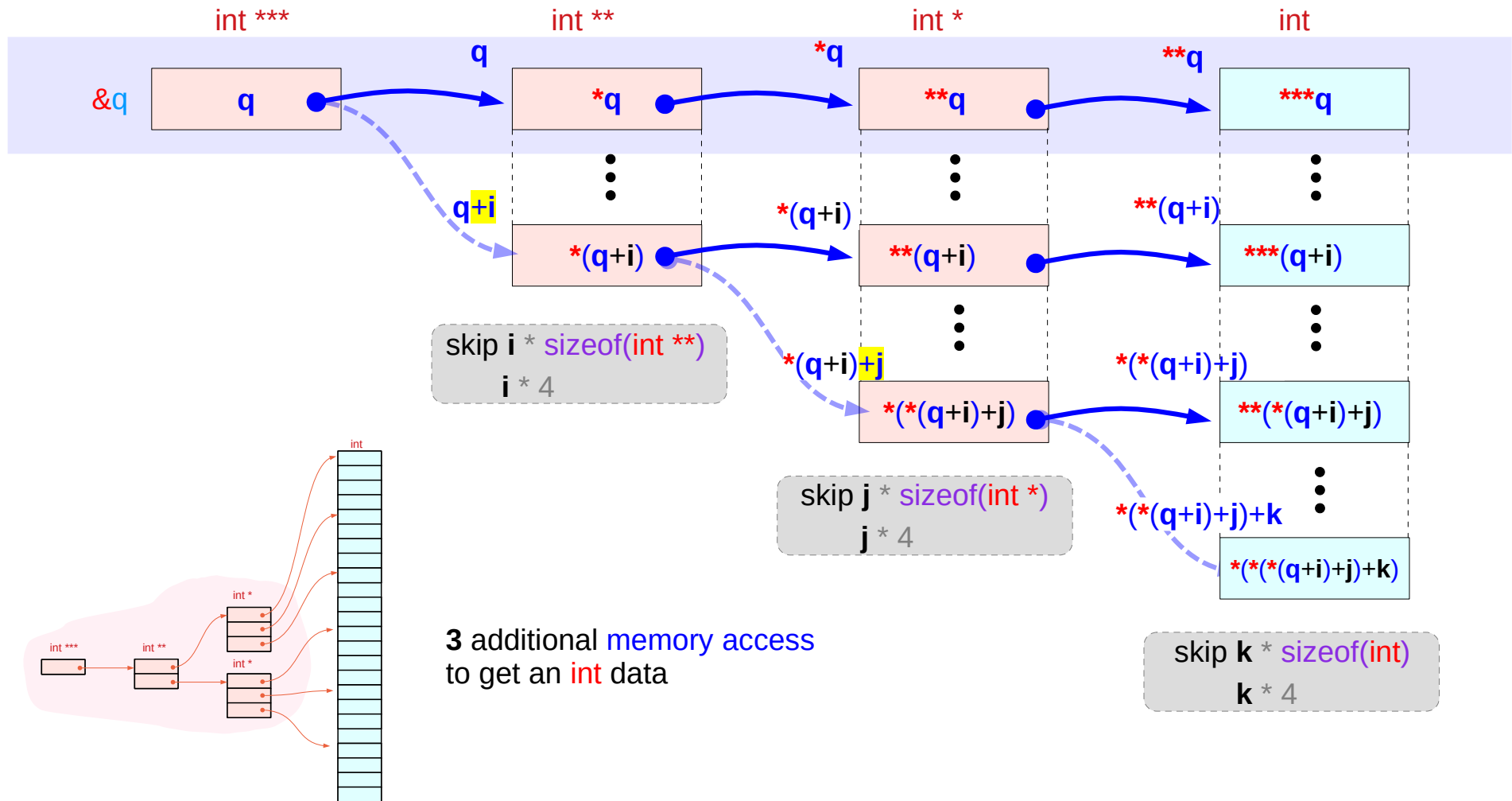

# Pointer Chain Type II – skipping elements

## Pointer Chain Type II

virtual pointer to an abstract data

size: abstract data size

int [2][3][4]  
int (\*)[3][4]

int [3][4]  
int (\*)[4]

int [4]  
int (\*)

int

- relaxing the 1<sup>st</sup> dim
- dereference

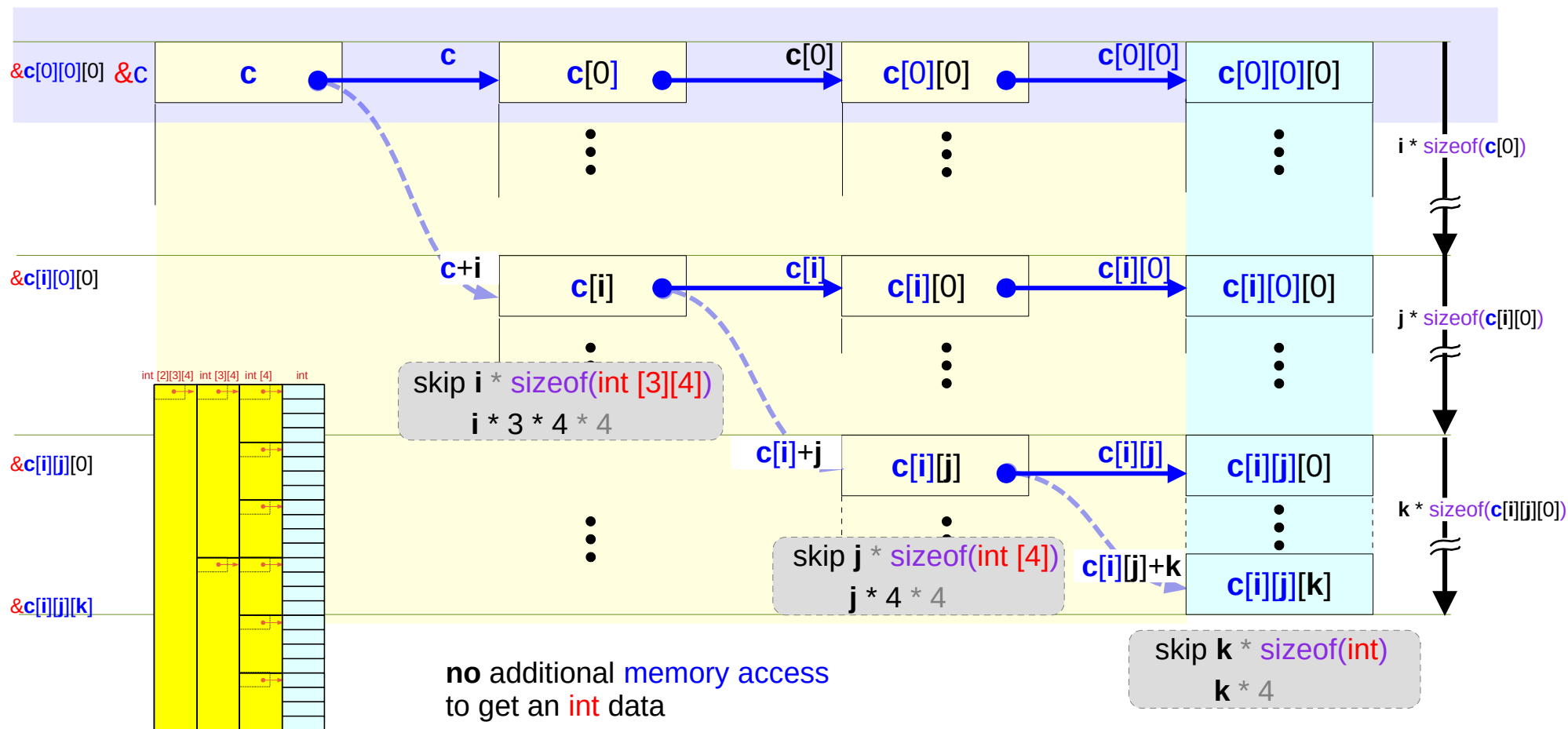



# Two step dereferencing in type II (1) – without skipping

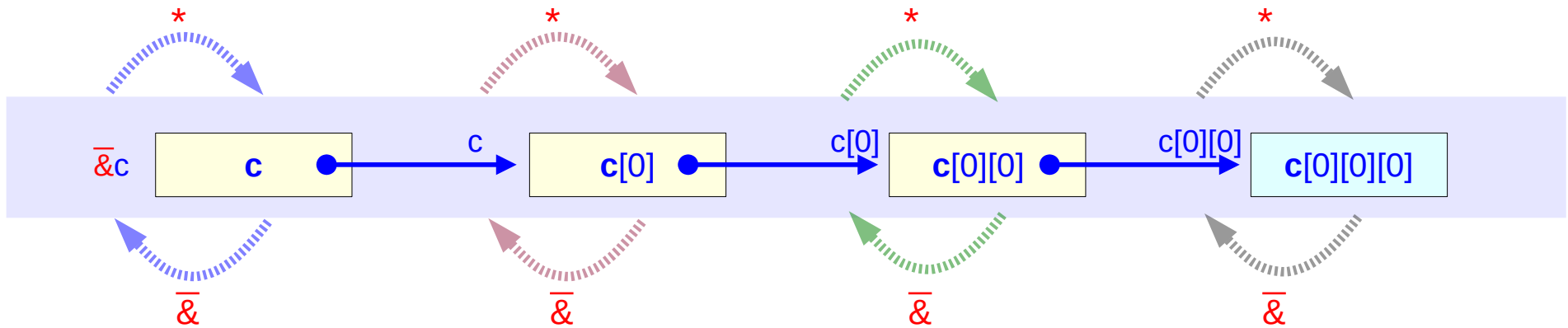
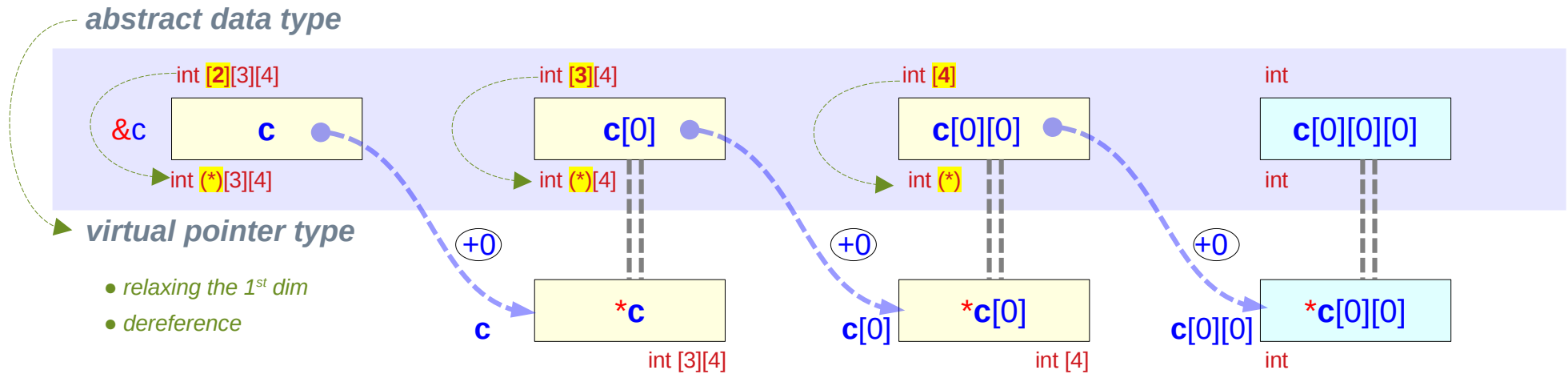

$\bar{\&}$  : mathematical & operator

# Two step dereferencing in type II (2) – with skipping

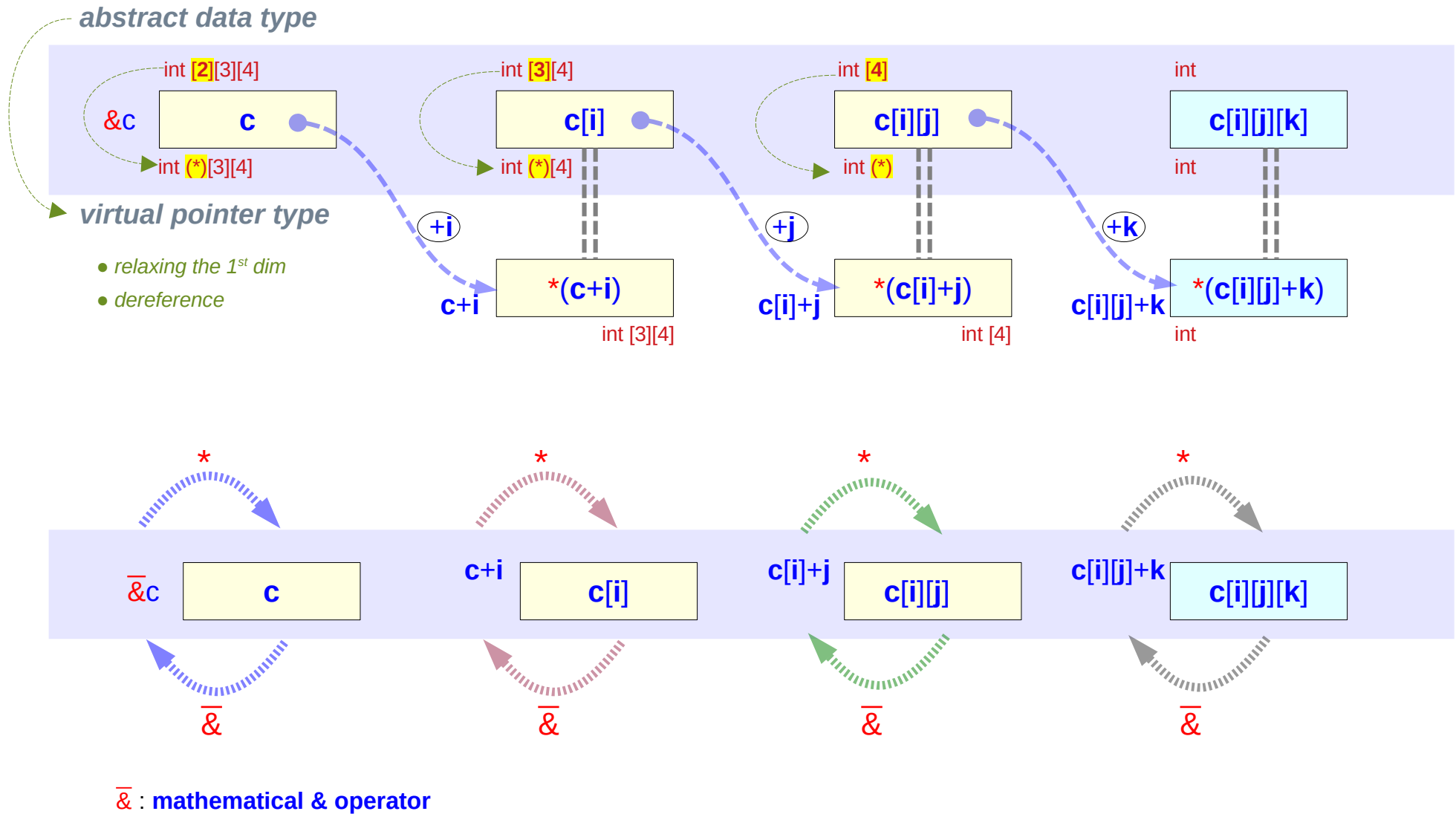

# Two step deferencing in type II (3)

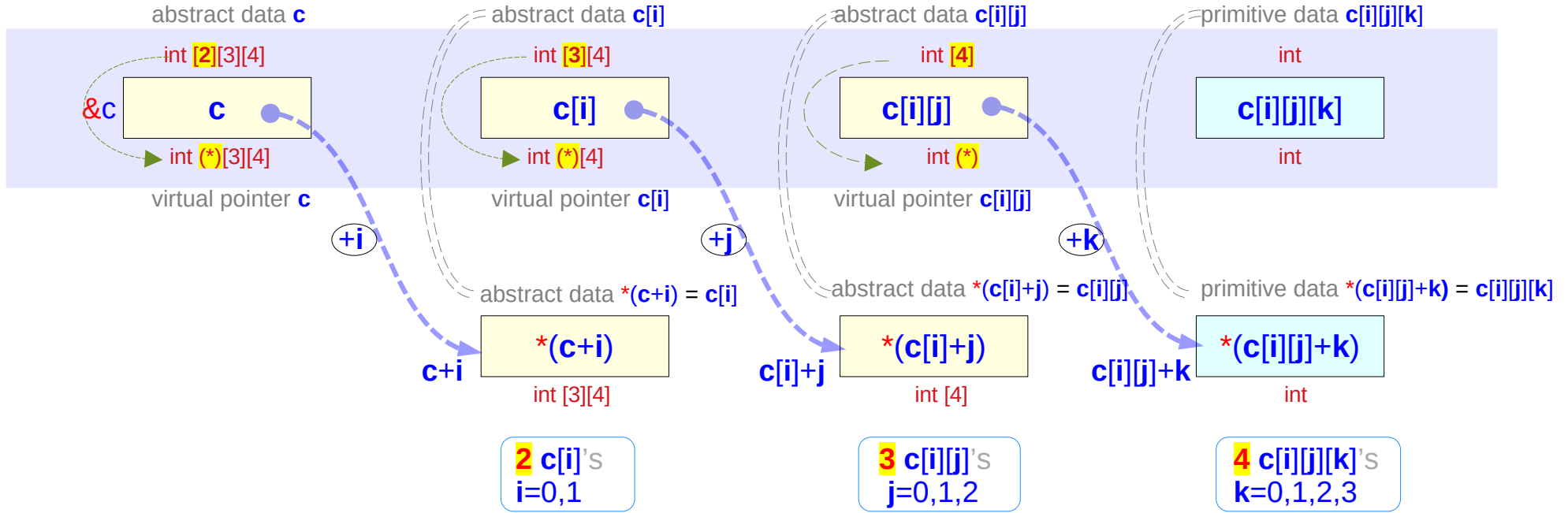

# Skipping elements

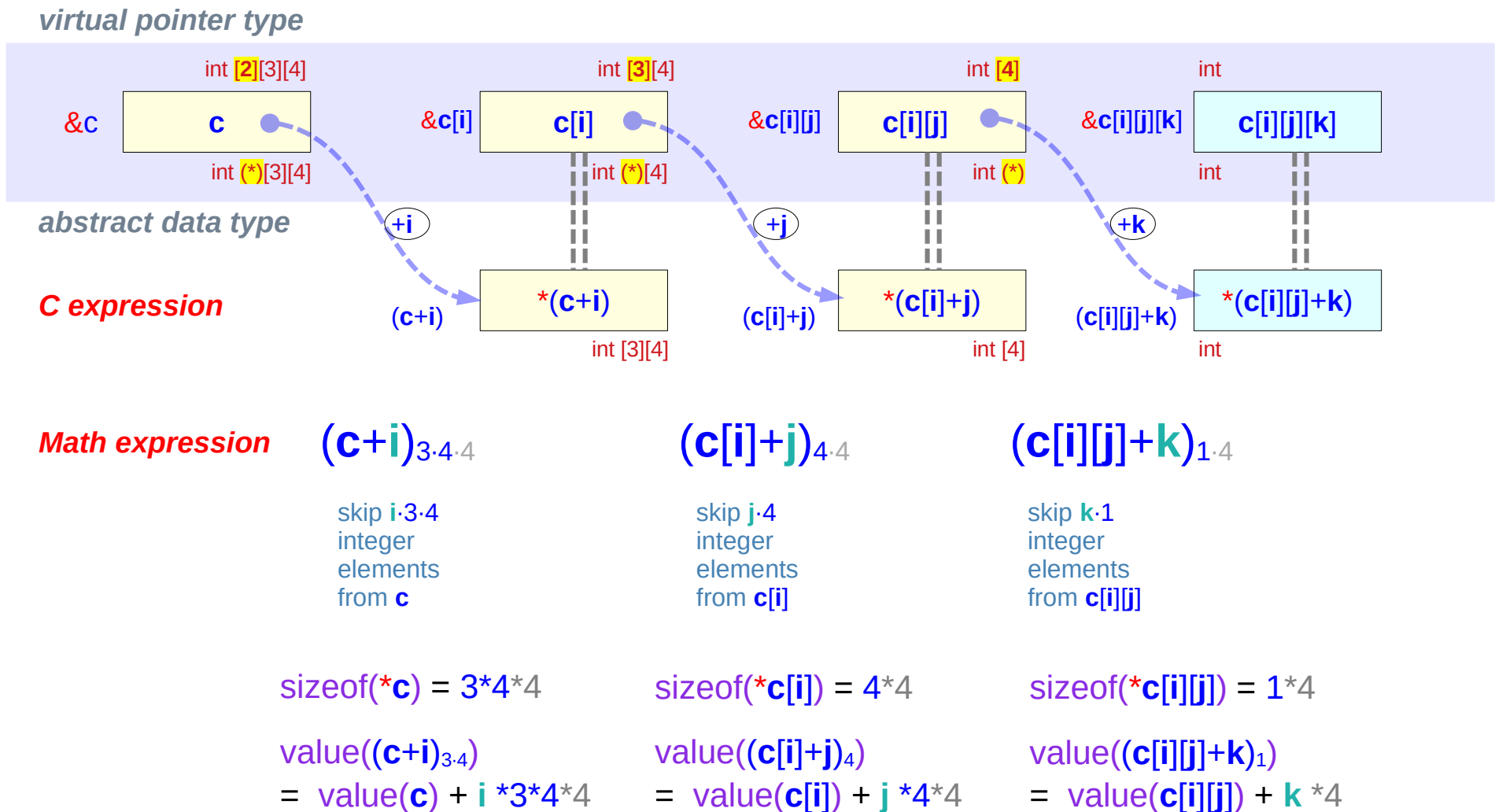

# Address replication

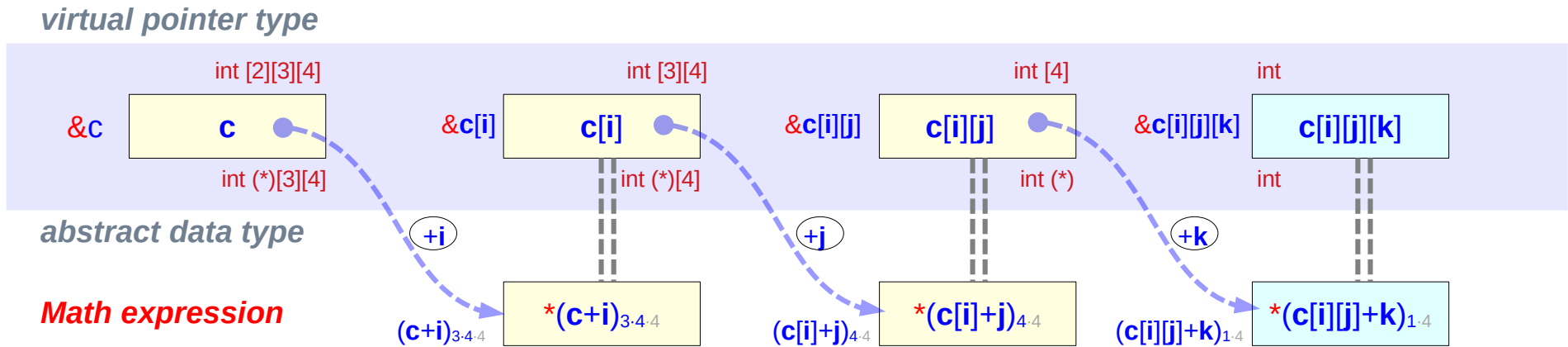

## equivalence relations – c expressions

$$\begin{aligned} c[i][j][k] &= *(c[i][j] + k) \\ c[i][j] &= *(c[i] + j) \\ c[i] &= *(c + i) \end{aligned}$$

$$\begin{aligned} \&c[i][j][k] &= (c[i][j] + k) \\ \&c[i][j] &= (c[i] + j) \\ \&c[i] &= (c + i) \end{aligned}$$

## address replication – math expressions

$$\begin{aligned} \text{value}(c[i][j]) &= \text{value}(c[i] + j)_{4 \cdot 4} \\ \text{value}(c[i]) &= \text{value}(c + i)_{3 \cdot 4 \cdot 4} \end{aligned}$$

# Applying address replication

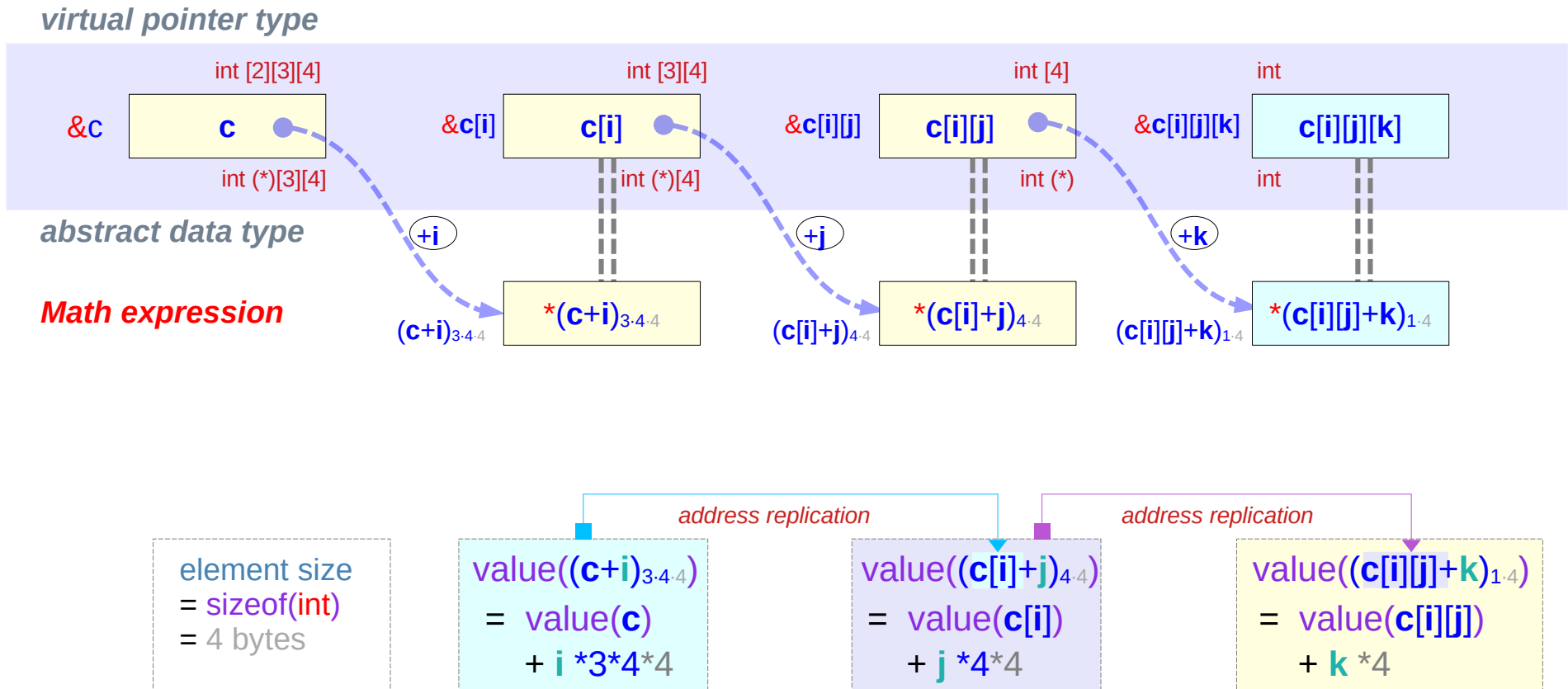

---

# const pointers

# const type, const pointer type (1)

```
const int * p;
```

```
int * const q ;
```

```
const int * const r ;
```



```
int * p;
```

```
int * q ;
```

```
int * r ;
```



*constant*    *must not be changed*  
*must not be updated*  
*must not be written*  
*must not be assigned*



# const type, const pointer type (2)

**const int** \* p ;

constant integer

\*p : constant integer value

int \* **const q** ;

constant pointer

q : constant (int \*) pointer

**const int** \* **const r** ;

constant integer

\*r : constant integer value

**const int** \* **const r** ;

constant pointer

r : constant (int \*) pointer

**const** [ ]

group with the following

# const type, const pointer type (3)

`const int *p;`

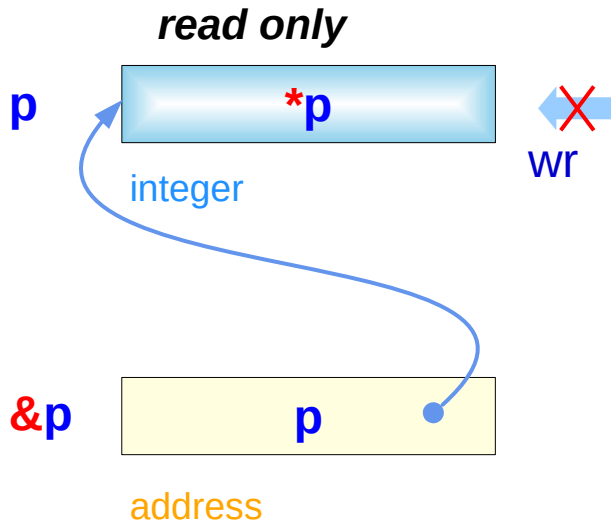

`int *const q;`

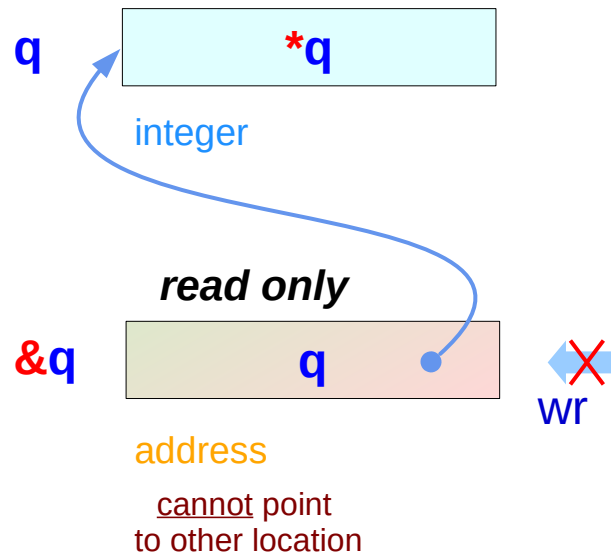

`const int *const r;`

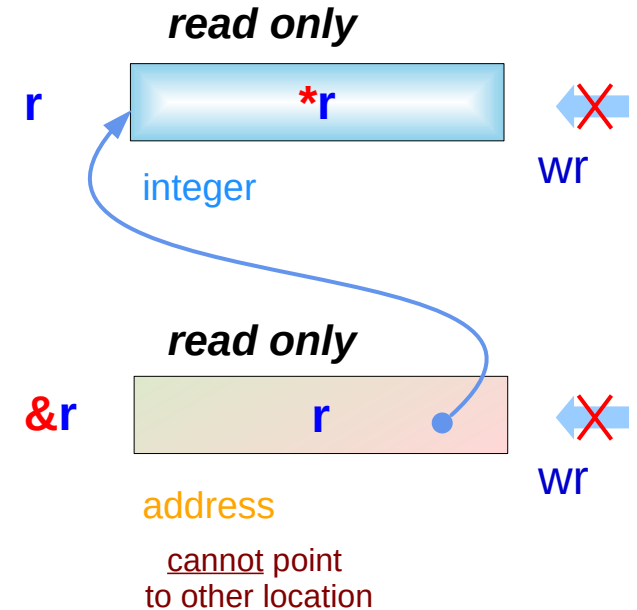

# const examples (1)

```
const int * pc;  
int * p, i;  
const int ic;
```

```
pc = &i; // (const int *) ← (int *)  
*pc = 5; // (const int) error
```

Writing to the writable memory location (i)  
is forbidden via **pc** ... (no harm, OK)

```
p = &ic; // (int *) ← (const int *) warning  
*p = 5; // (int)
```

Writing to the read only memory location (ic)  
is not forbidden via **p** ... (hazardous, not OK)

C A Reference Manual, Harbison & Steele Jr.

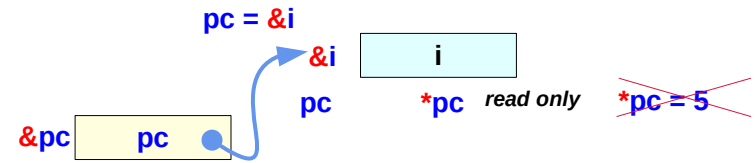

**pc** can point to **i**  
**\*pc** must be **const**

the same memory location  
that can be written via **i**  
cannot be written via **\*pc**

**\*pc** should not write  
the writable memory location

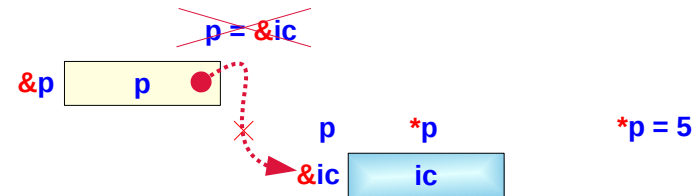

Assume **p** points to **const ic**

the same memory location  
that cannot be written via **ic**,  
can be written via **\*p**

thus **\*p** can write  
the **const** memory location

therefore, **p** should not point to **const ic**

# const examples (2)

```
const int * pc;  
    int * p, i = 5;  
const int ic = 7;
```

```
p = &i;  
pc = &ic
```

// more constrained type ← general type (O)

```
pc = &i; // (const int * ← int *)  
pc = p; // (const int * ← int *)
```

// general type ← more constrained type (X)

```
p = &ic; // (int * ← const int *) warning  
p = pc; // (int * ← const int *) warning
```

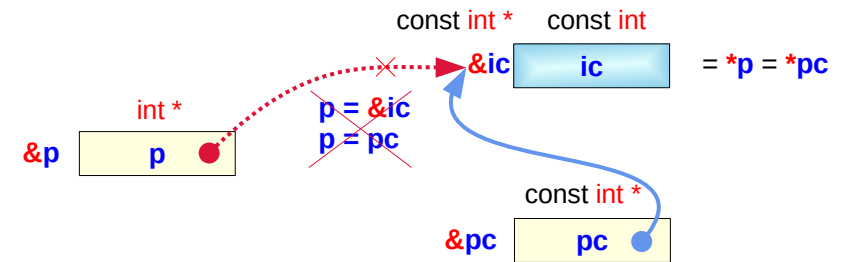
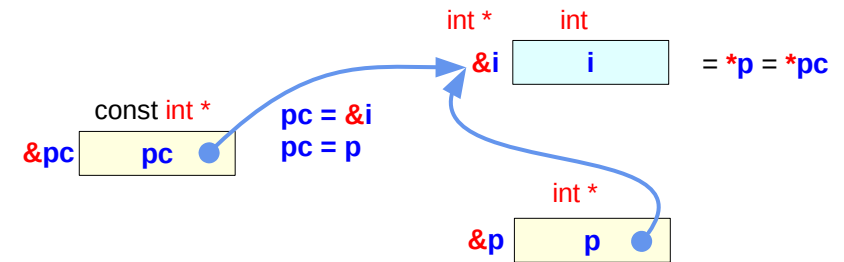

C A Reference Manual, Harbison & Steele Jr.

# const examples (3)

```
const int * pc;
      int * p, i;
const int ic;
```

```
p = &i; // (int *) ← (int *)
*p = 5; // (int)
pc = &i; // (const int *) ← (int *)
*pc = 5; // (const int) error
```

```
p = &ic; // (int *) ← (const int *) warning
*p = 5; // (int)
pc = &ic; // (const int *) ← (const int *)
*pc = 5; // (const int) error
```

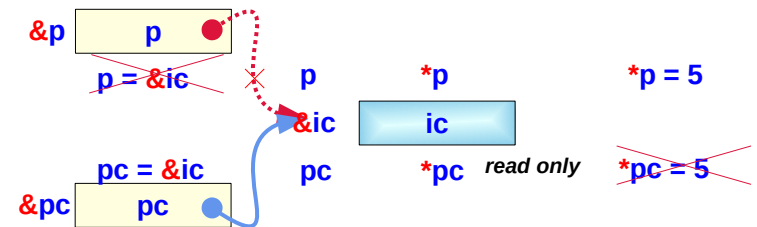
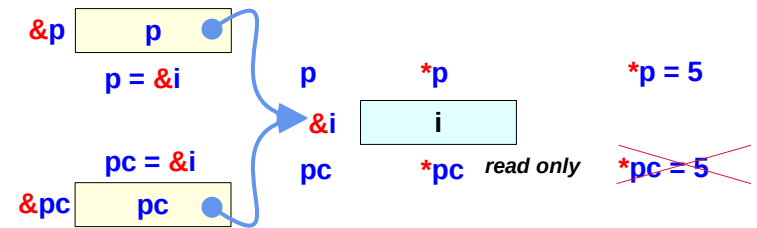
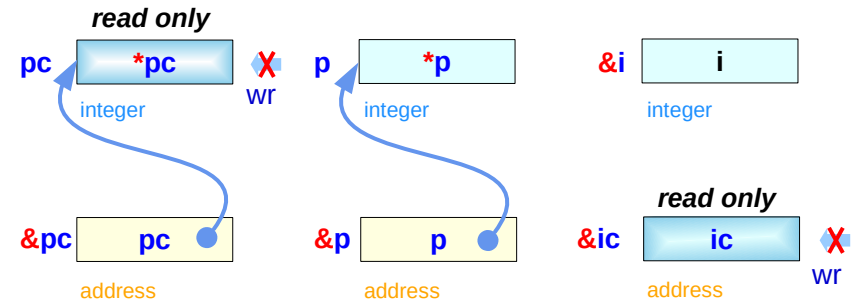

C A Reference Manual, Harbison & Steele Jr.

# const examples (4)

```
const int * pc;
      int * p, i;
const int ic;
```

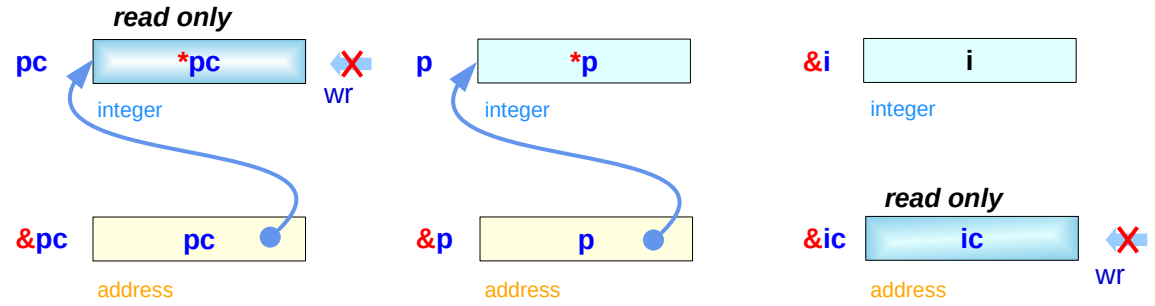

```
pc = p = &i;
pc = &ic
*p = 5;
*pc = 5;           // invalid   *pc :: cons int
```

```
pc = &i;           // (const int * ← int *)
pc = p;           // (const int * ← int *)
p = &ic;          // invalid (int * ← const int *)
p = pc;           // invalid (int * ← const int *)
p = (int *) &ic; // type cast
p = (int *) pc;  // type cast
```

C A Reference Manual, Harbison & Steele Jr.

## References

- [1] Essential C, Nick Parlante
- [2] Efficient C Programming, Mark A. Weiss
- [3] C A Reference Manual, Samuel P. Harbison & Guy L. Steele Jr.
- [4] C Language Express, I. K. Chun