

# Applications of Array Pointers (1A)

---

Copyright (c) 2010 - 2020 Young W. Lim.

Permission is granted to copy, distribute and/or modify this document under the terms of the GNU Free Documentation License, Version 1.2 or any later version published by the Free Software Foundation; with no Invariant Sections, no Front-Cover Texts, and no Back-Cover Texts. A copy of the license is included in the section entitled "GNU Free Documentation License".

Please send corrections (or suggestions) to [youngwlim@hotmail.com](mailto:youngwlim@hotmail.com).  
This document was produced by using LibreOffice.

---

# Multi-dimensional Array Pointers

# $(n-1)$ -d array pointer to a $n$ -d array

`int a[4];`                    **1-d** array  
`int (*p);`                    **0-d** array pointer        ( $p = a$ )

`int b[4][2];`                    **2-d** array  
`int (*q)[2];`                    **1-d** array pointer        ( $q = b$ )

`int c[4][2][3];`                    **3-d** array  
`int (*r)[2][3];`                    **2-d** array pointer        ( $r = c$ )

`int d[4][2][3][4];`                    **4-d** array  
`int (*s)[2][3][4];`                    **3-d** array pointer        ( $s = d$ )



the 1<sup>st</sup> dimension can be accessed by incrementing  $(n-1)$ -d array pointer

# $n$ -d array name and $(n-1)$ -d array pointer

```
int a[4];  
int (*p);
```

```
p = &a[0];  
p = a;
```

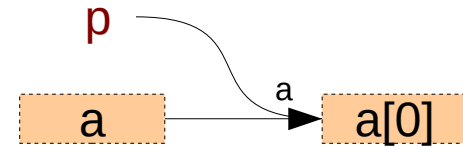

```
int b[4][2];  
int (*q)[2];
```

```
q = &b[0];  
q = b;
```

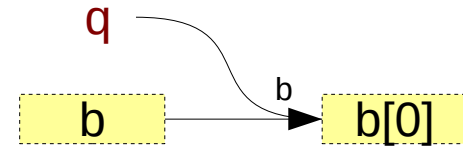

```
int c[4][2][3];  
int (*r)[2][3];
```

```
r = &c[0];  
r = c;
```

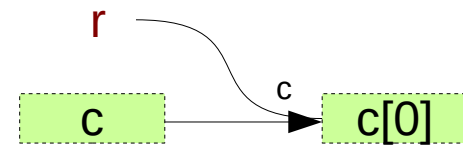

```
int d[4][2][3][4];  
int (*s)[2][3][4];
```

```
s = &d[0];  
s = d;
```

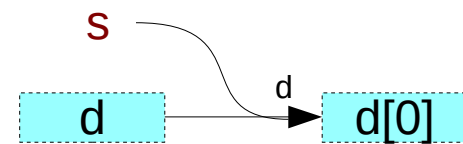

the 1<sup>st</sup> dimension can be accessed by incrementing  $(n-1)$ -d array pointer

# *n*-d array pointer to a *n*-d array

`int a [4] ;`                    **1-d** array  
`int (*p) [4];`                **1-d** array pointer        (`p = &a`)

`int b [4][2];`                **2-d** array  
`int (*q) [4][2];`            **2-d** array pointer        (`q = &b`)

`int c [4][2][3];`            **3-d** array  
`int (*r) [4][2][3];`        **3-d** array pointer        (`r = &c`)

`int d [4][2][3][4];`        **4-d** array  
`int (*s) [4][2][3][4];`    **4-d** array pointer        (`s = &d`)

# *n*-d array name and *n*-d array pointer

```
int a [4];  
int (*p) [4];
```

```
p = &a;
```

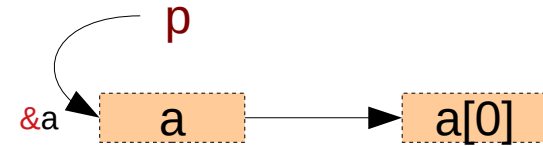

```
int b [4][2];  
int (*q) [4][2];
```

```
q = &b;
```

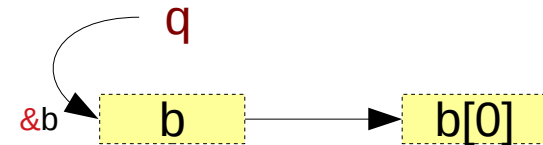

```
int c [4][2][3];  
int (*r) [4][2][3];
```

```
r = &c;
```



```
int d [4][2][3][4];  
int (*s) [4][2][3][4];
```

```
s = &d;
```

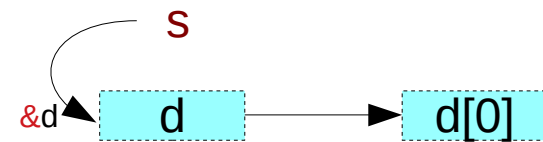

# multi-dimensional array pointers

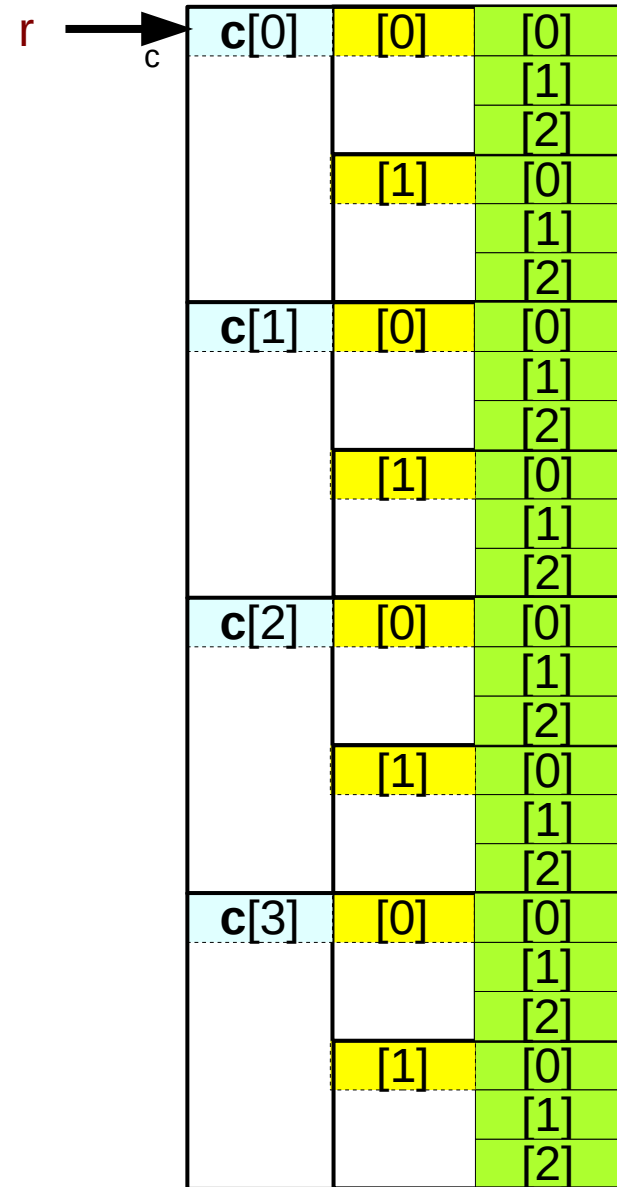
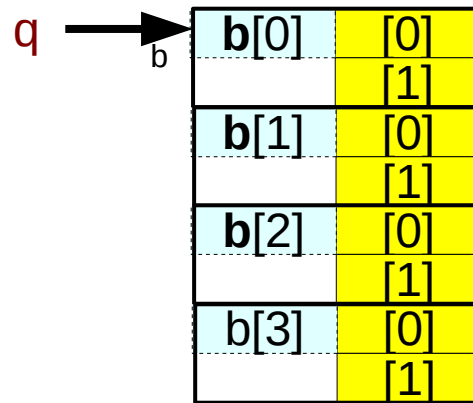
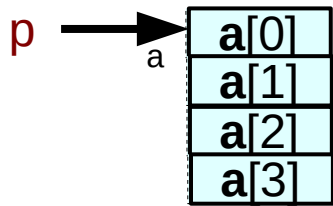

<code>int a[4];</code>	<b>1-d array</b>
<code>int (*p);</code>	<b>0-d array pointer</b>
<code>int b[4][2];</code>	<b>2-d array</b>
<code>int (*q)[2];</code>	<b>1-d array pointer</b>
<code>int c[4][2][3];</code>	<b>3-d array</b>
<code>int (*r)[2][3];</code>	<b>2-d array pointer</b>
<code>int d[4][2][3][4];</code>	<b>4-d array</b>
<code>int (*s)[2][3][4];</code>	<b>3-d array pointer</b>



# Initializing *n-d* array pointers

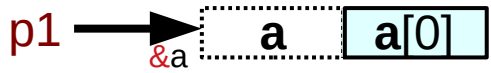

```
int a[4];
int (*p1)[4] = &a;
```

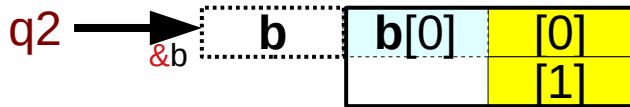

```
int b[4][2];
int (*q2)[4][2] = &b;
```

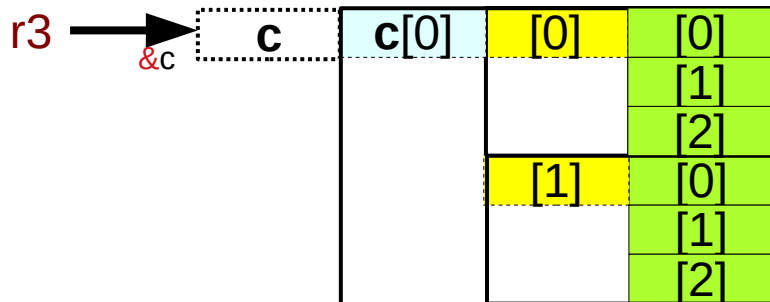

```
int c[4][2][3];
int (*r3)[4][2][3] = &c;
```

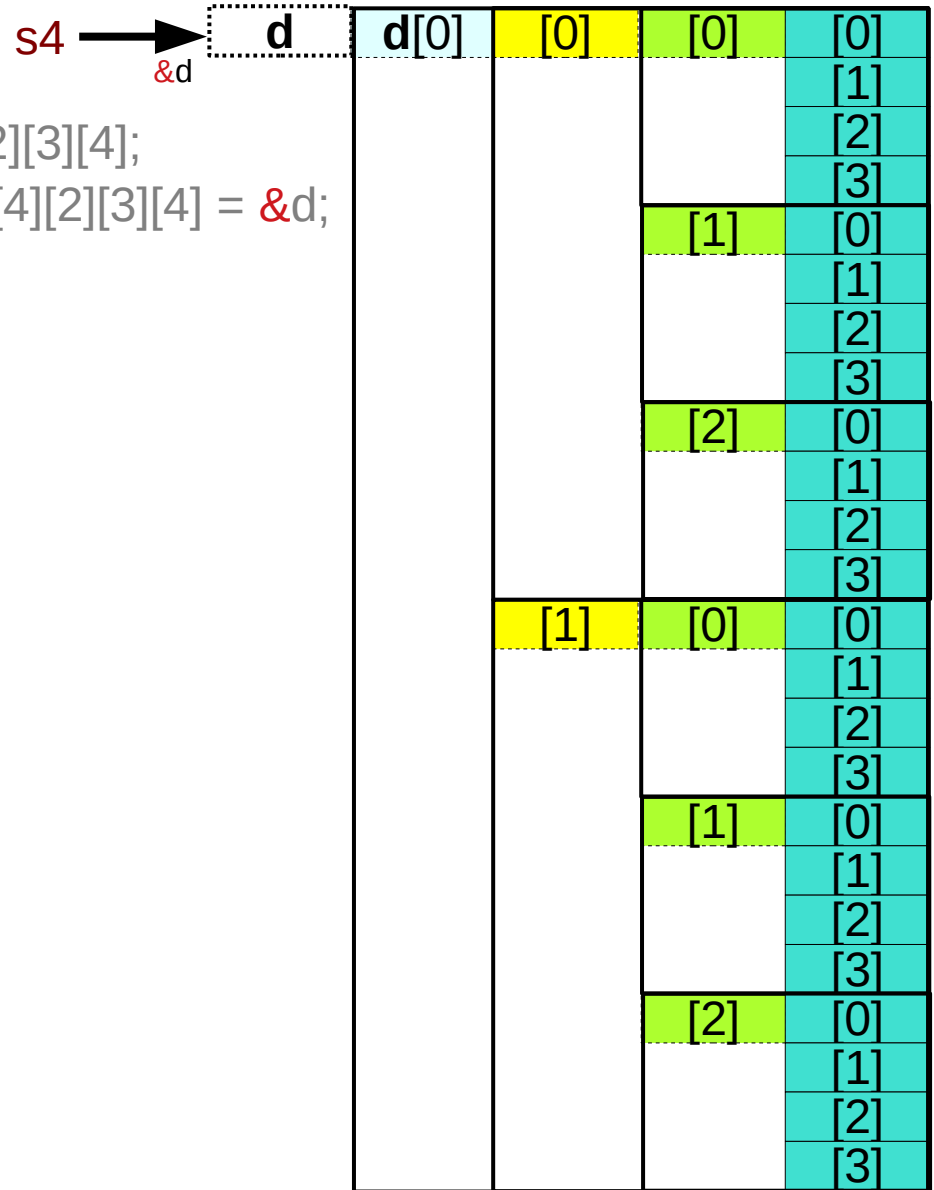

```
int d[4][2][3][4];
int (*s4)[4][2][3][4] = &d;
```

# Initializing $(n-1)$ -d array pointers

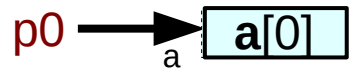

```
int a[4];
int (*p0) = a;
```

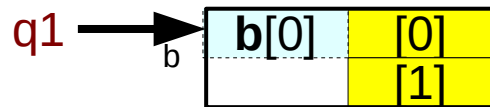

```
int b[4][2];
int (*q1)[2] = b;
```

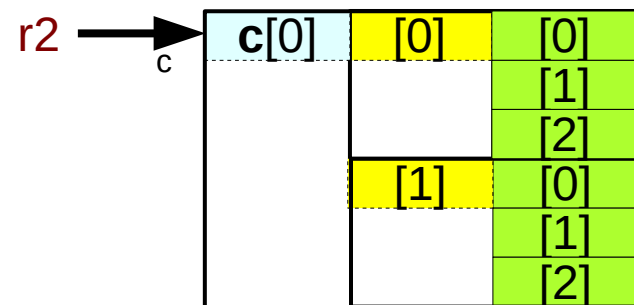

```
int c[4][2][3];
int (*r2)[2][3] = c;
```

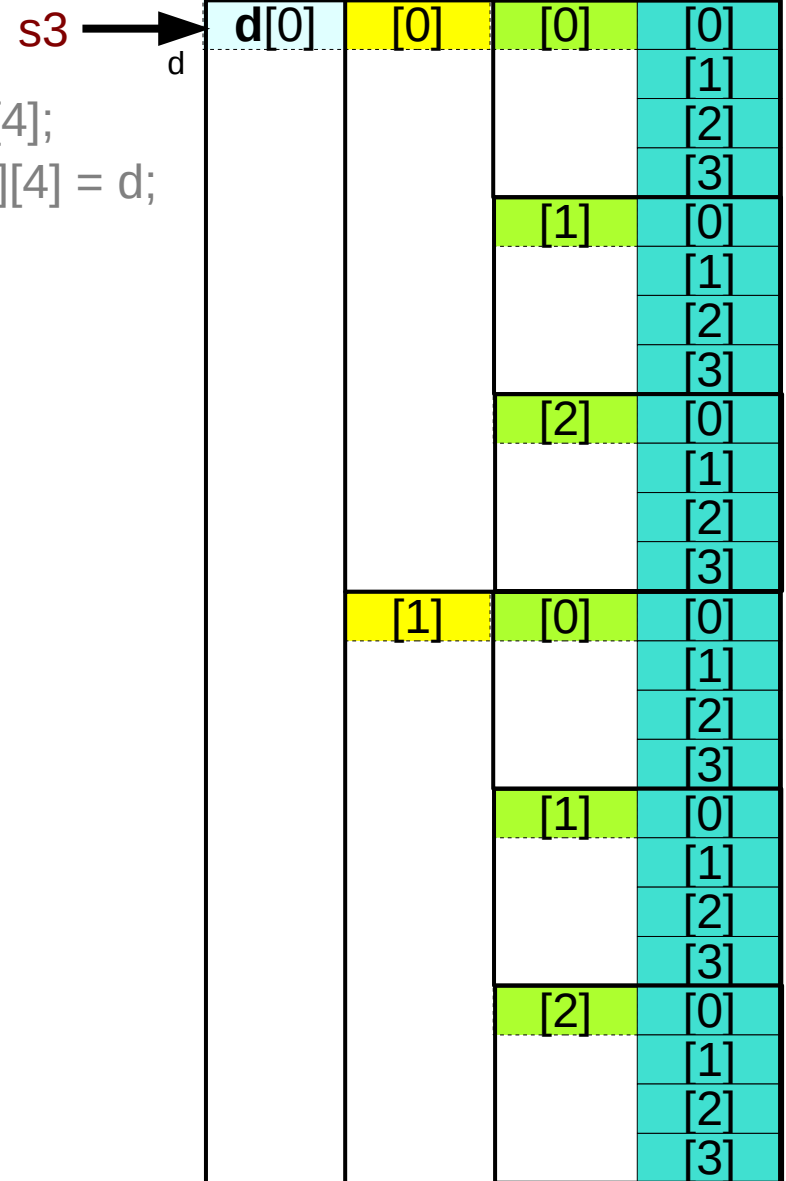

```
int d[4][2][3][4];
int (*s3)[2][3][4] = d;
```

# array pointers to multi-dimensional subarrays

```
int d[4][2][3][4];
int (*s)[2][3][4];
```

d	4-d array name	d[4][2][3][4]
	3-d array pointer	(*p)[2][3][4]
d[i]	3-d array name	d[i][2][3][4]
	2-d array pointer	(*q)[3][4]
d[i][j]	2-d array name	d[i][j][3][4]
	1-d array pointer	(*r)[4]
d[i][j][k]	1-d array name	d[i][j][k][4]
	0-d array pointer	(*s)

i,j,k are specific index values

i = [0..3], j = [0..1], k = [0..2]

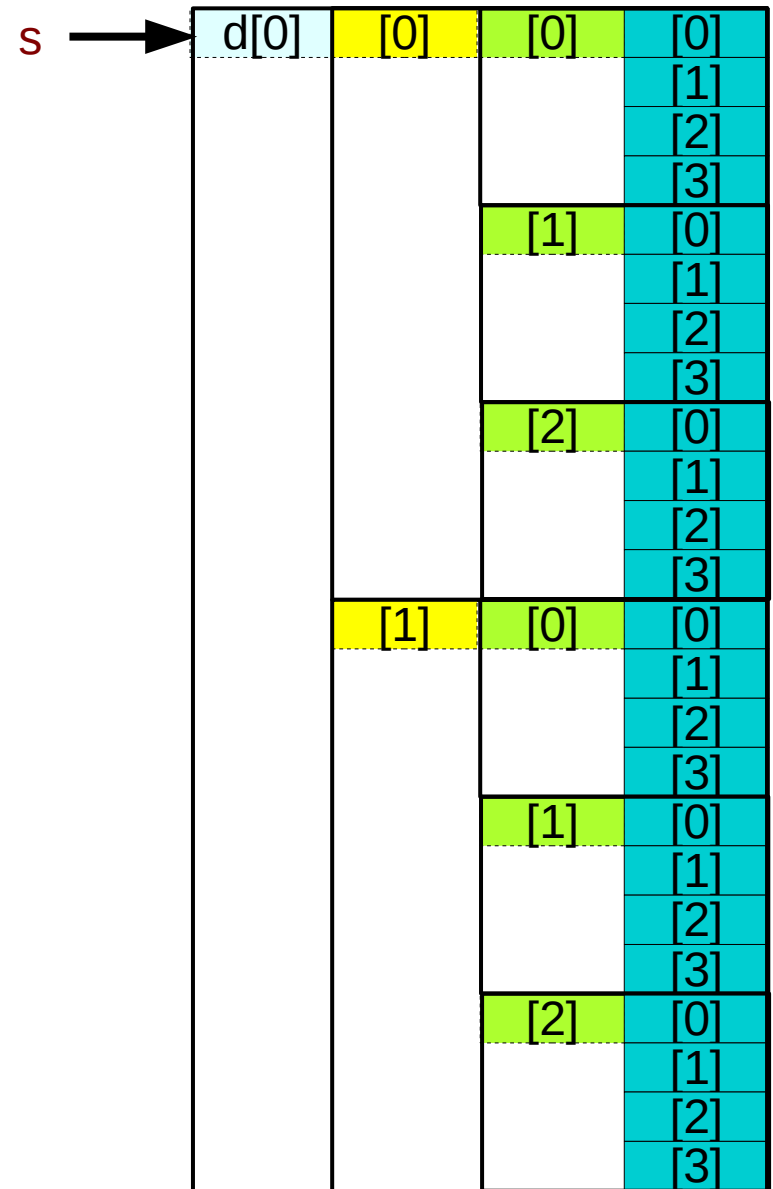

# Initializing array pointers to multi-dimensional subarrays

```
int d[4][2][3][4];  
int (*s)[2][3][4];
```

<code>d</code>	4-d array name 3-d array pointer	<code>d[4][2][3][4]</code> <code>(*p)[2][3][4]</code>	<code>p[i][j][k][l]</code> <code>int (*p)[2][3][4] = d;</code>
<code>d[i]</code>	3-d array name 2-d array pointer	<code>d[i][2][3][4]</code> <code>(*q)[3][4]</code>	<code>q[j][k][l]</code> <code>int (*q)[3][4] = d[i];</code>
<code>d[i][j]</code>	2-d array name 1-d array pointer	<code>d[i][j][3][4]</code> <code>(*r)[4]</code>	<code>r[k][l]</code> <code>int (*r)[4] = d[i][j];</code>
<code>d[i][j][k]</code>	1-d array name 0-d array pointer	<code>d[i][j][k][4]</code> <code>(*s)</code>	<code>s[l]</code> <code>int (*s) = d[i][j][k];</code>

`i = [0..3], j = [0..1], k = [0..2]`

# Passing multidimensional array names

```
int a[4];  
int (*p);
```

call  
**fun**a(a, ...);

prototype  
void **fun**a(int (\*p), ...);

```
int b[4][2];  
int (*q)[2];
```

call  
**fun**b(b, ...);

prototype  
void **fun**b(int (\*q)[2], ...);

```
int c[4][2][3];  
int (*r)[2][3];
```

call  
**func**(c, ...);

prototype  
void **func**(int (\*r)[2][3], ...);

```
int d[4][2][3][4];  
int (*s)[2][3][4];
```

call  
**fund**(d, ...);

prototype  
void **fund**(int (\*s)[2][3][4], ...);

# Double pointer to a 1-d array – a variable view (p, q)

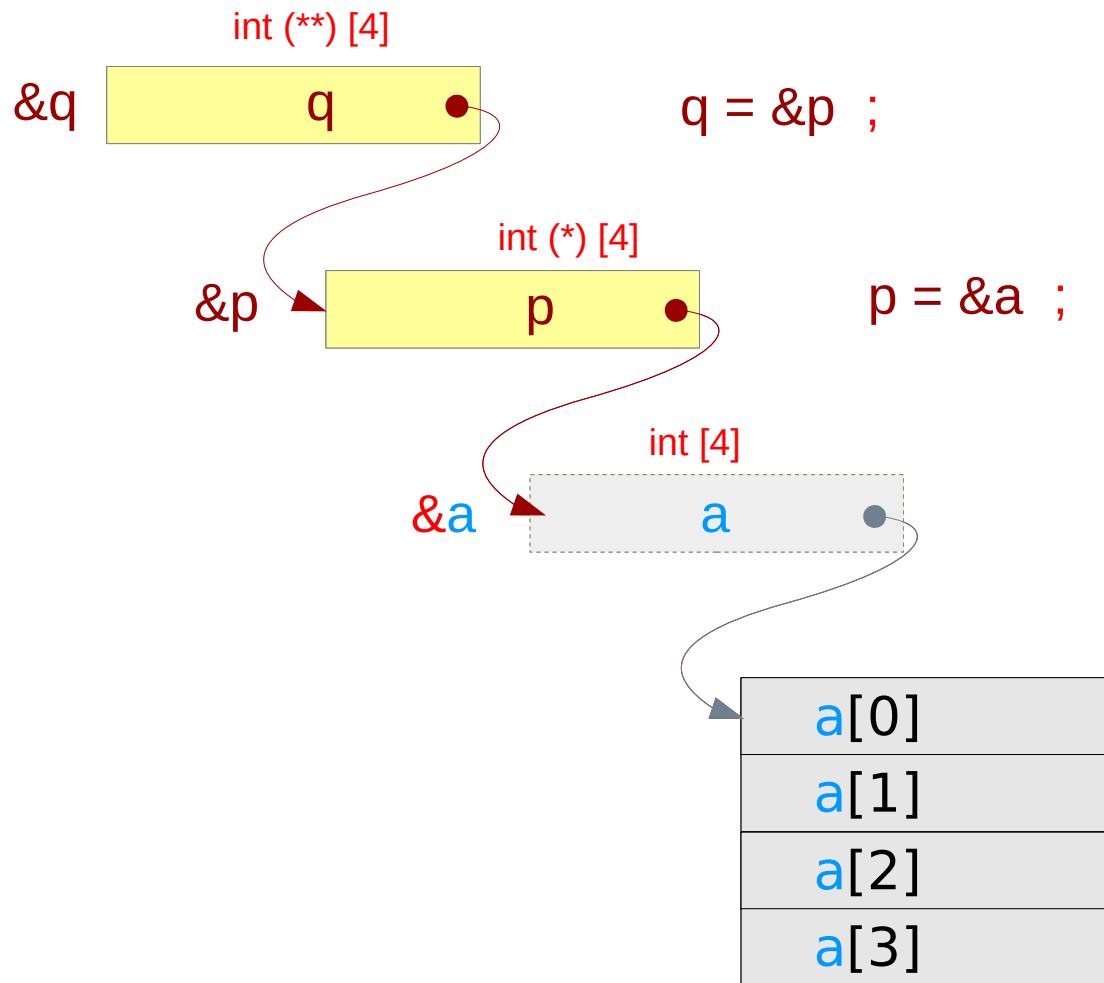

```
int a[4] ;  
int (*p) [4] = &a ;  
int (**q) [4] = &p ;
```

```
➡ p = &a ;  
➡ q = &p ;
```

# Double pointer to a 1-d array – a variable view (q)

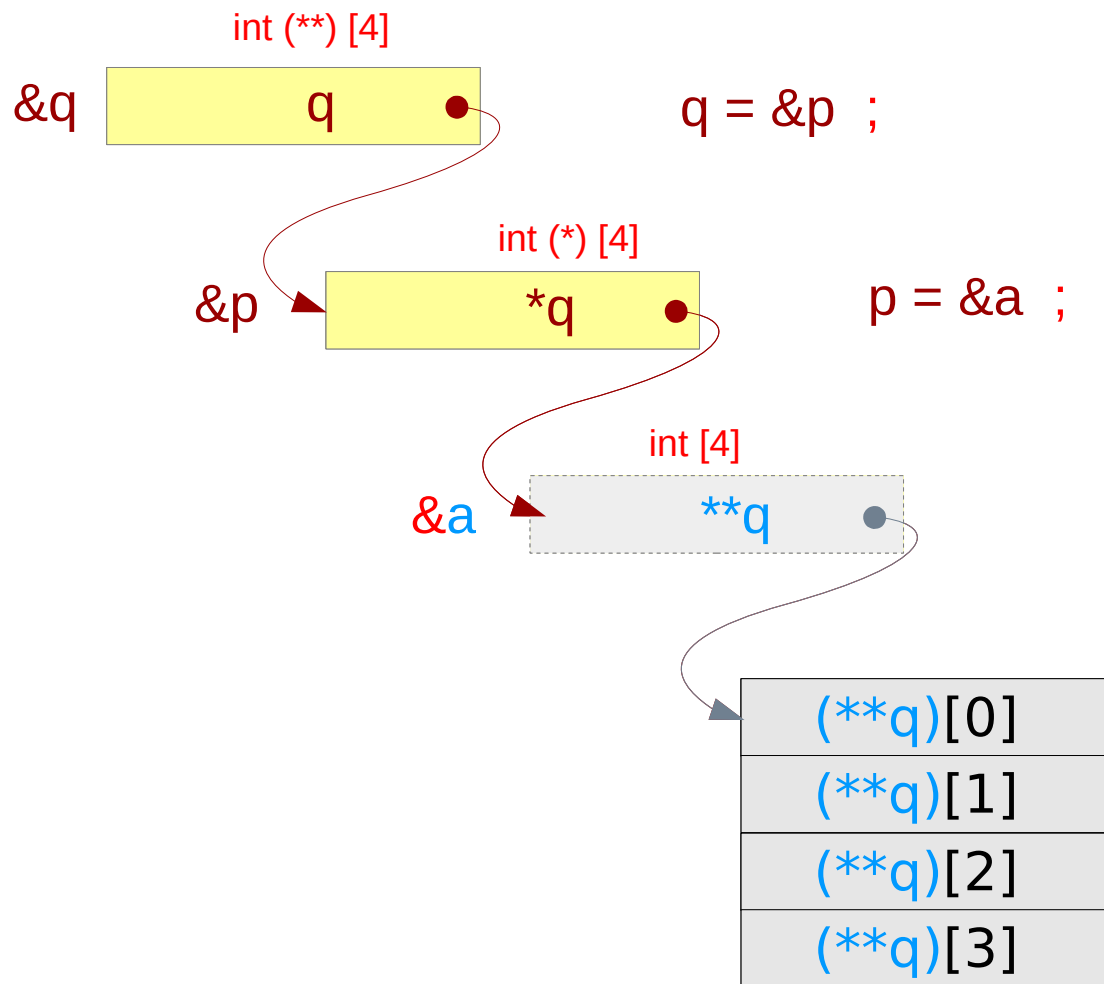

```
int a[4] ;  
int (*p) [4] = &a ;  
int (**q) [4] = &p ;
```

```
➔ p = &a ;  
➔ q = &p ;
```

# Double pointer to a 1-d array – a type view

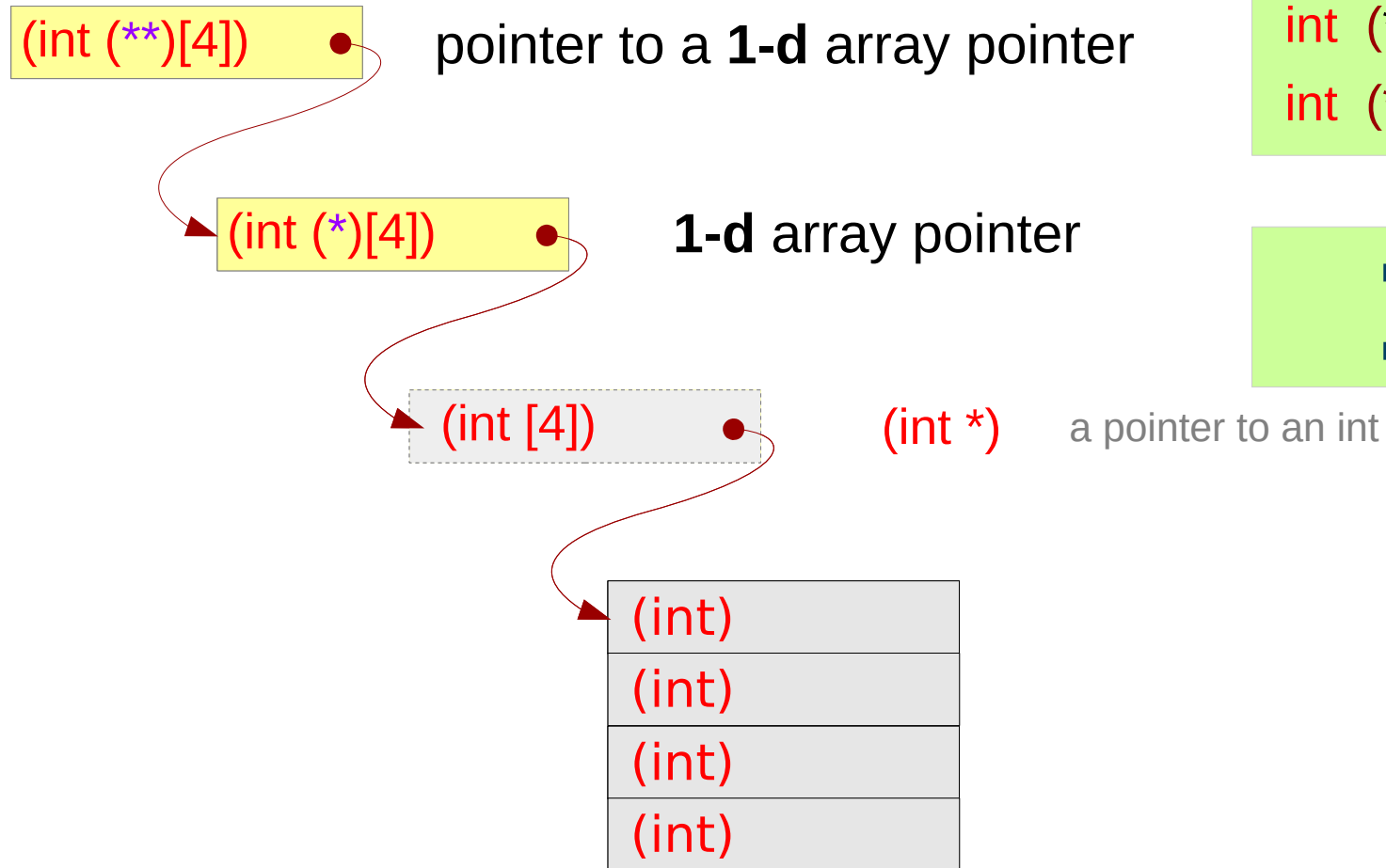

```
int a[4] ;  
int (*p) [4] = &a ;  
int (**q) [4] = &p ;
```

```
➔ p = &a ;  
➔ q = &p ;
```



---

# Virtual Array Pointers in Multi-dimensional Arrays

# 3-d array structure

- Hierarchical
- Nested Structure
- Virtual Array Pointers over
  - Contiguous
  - Linear Layout

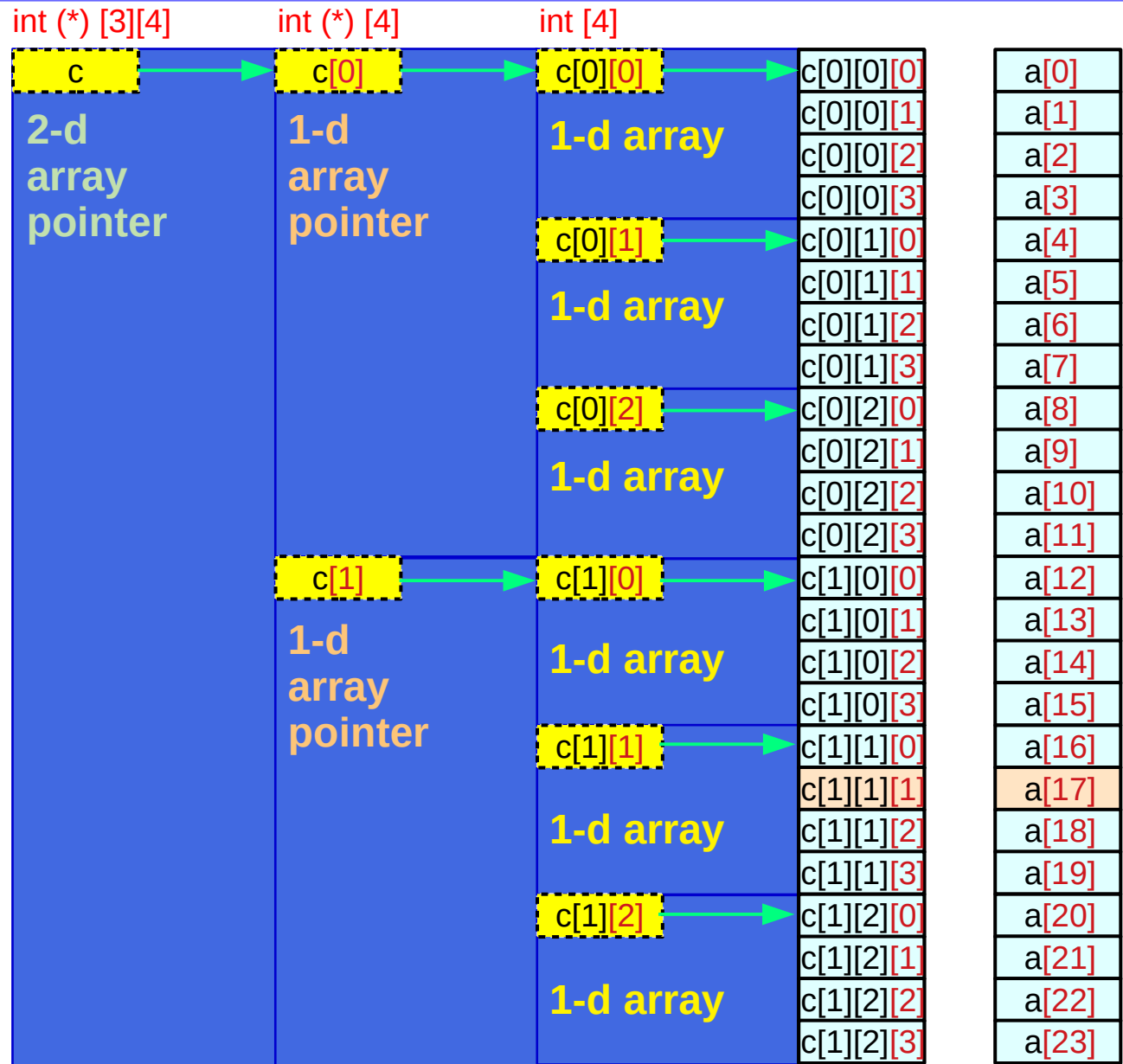

# Array **p** and virtual array pointer **p**

## Abstract data (array) **p**

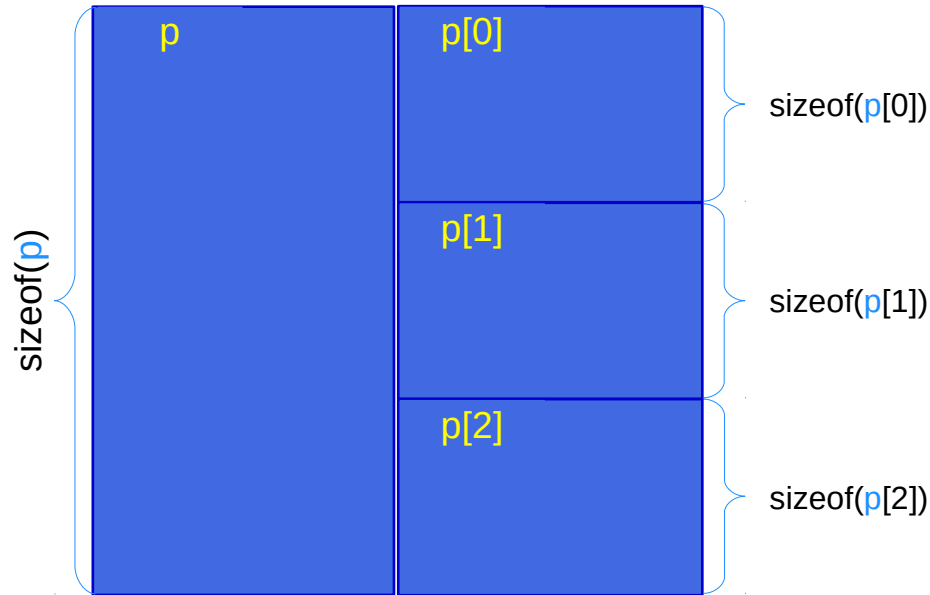

## Virtual array pointer **p**

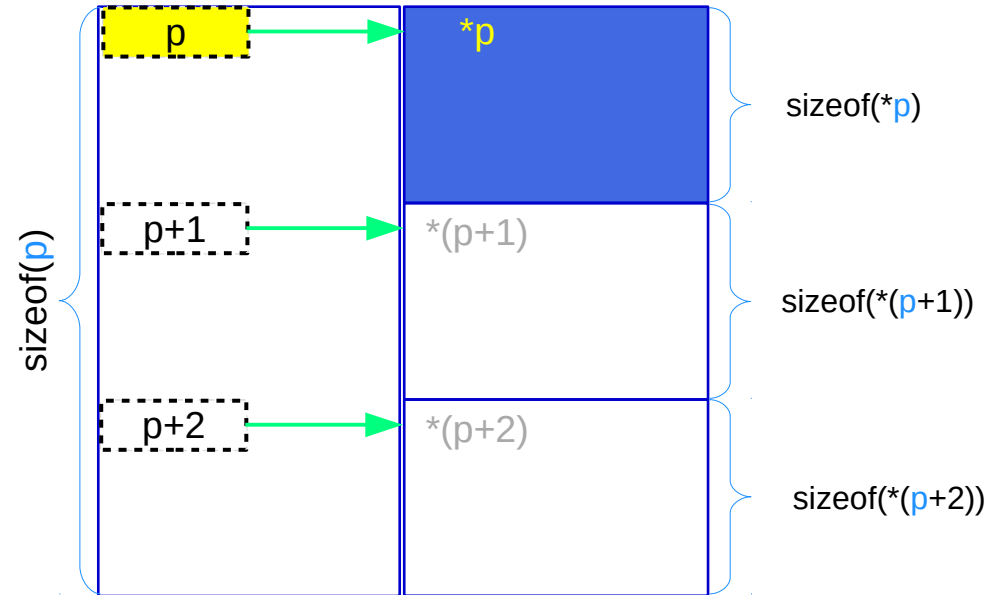

**p** is the name of an array and has a array pointer type but has a size of the array

**p** is a virtual array pointer

# Virtual array pointer to abstract data

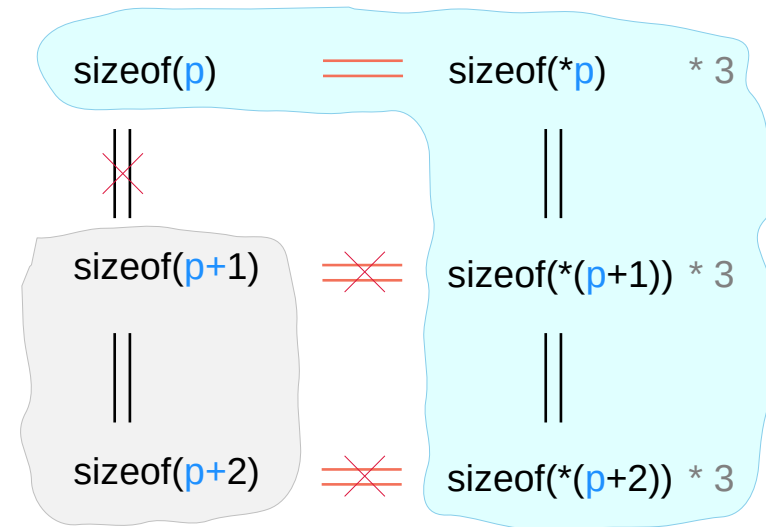
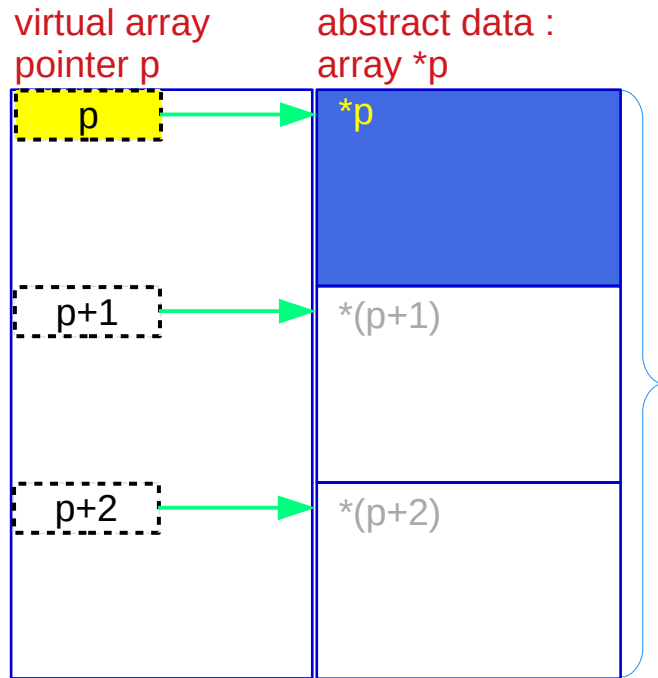

# Array **a** and pointer **a**

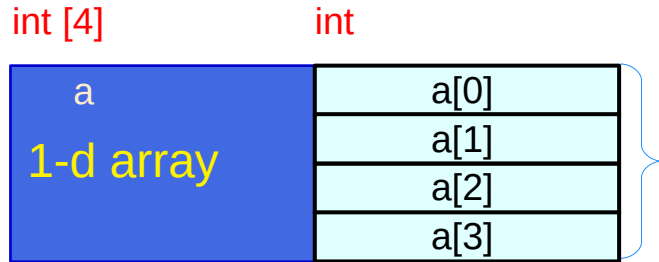

**1-d array **a**** specific array type

$\text{sizeof}(a)$

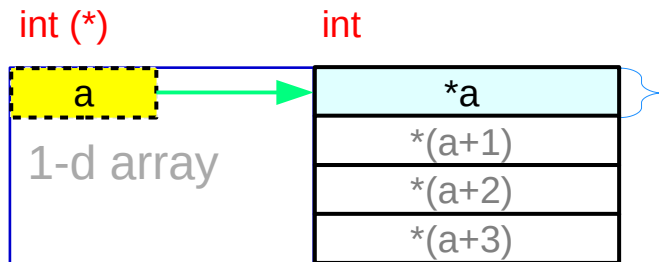

**pointer **a**** general pointer type

$\text{sizeof}(a) = \text{sizeof}(*a) * 4$

**a** is the name of a 1-d array and has a pointer type but has a size of the array

**a** is a virtual array pointer

# Array **b** and pointer **b**

**2-d array **b**** specific array type

`sizeof(b)`

`int [3] [4]`

`int [4]`



**1-d array pointer **b**** general pointer type

`sizeof(b) = sizeof(*b) * 3`

`int (*) [4]`

`int [4]`

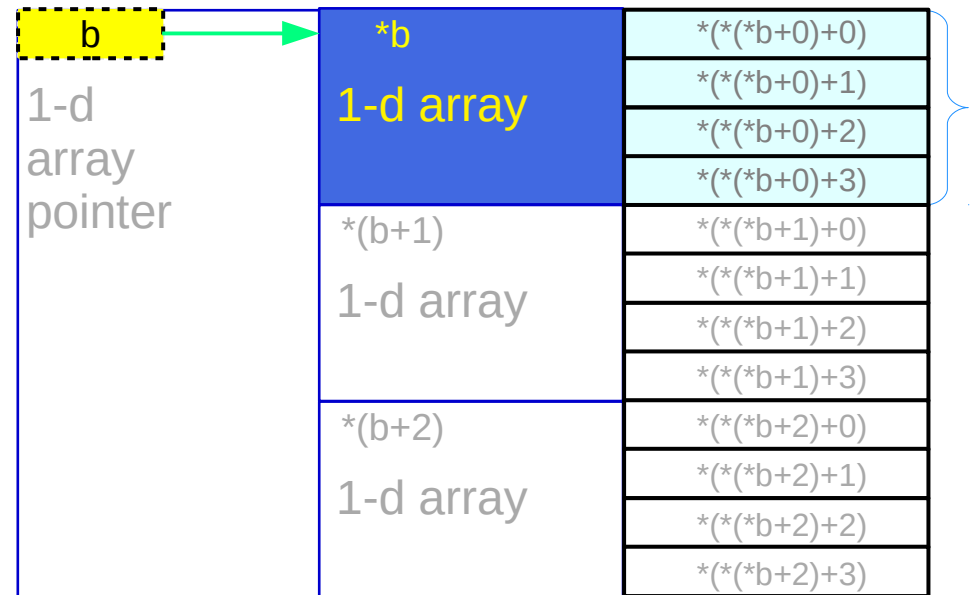

**b** is the name of a 2-d array and has a 1-d array pointer type but has a size of the array

**b** is a virtual array pointer

# Array c

## 3-d array c

specific array type

sizeof(c)

**c** is the name of a 3-d array and has a 2-d array pointer type but has a size of the array

**c** is a virtual array pointer

int [2][3][4]	int [3][4]	int [4]	
c 3-d array	c[0] 2-d array	c[0][0] 1-d array	c[0][0][0]
			c[0][0][1]
			c[0][0][2]
			c[0][0][3]
		c[0][1] 1-d array	c[0][1][0]
			c[0][1][1]
		c[0][1][2]	
		c[0][1][3]	
		c[0][2] 1-d array	c[0][2][0]
			c[0][2][1]
			c[0][2][2]
			c[0][2][3]
	c[1] 2-d array	c[1][0] 1-d array	c[1][0][0]
			c[1][0][1]
			c[1][0][2]
			c[1][0][3]
		c[1][1] 1-d array	c[1][1][0]
			c[1][1][1]
		c[1][1][2]	
		c[1][1][3]	
		c[1][2] 1-d array	c[1][2][0]
			c[1][2][1]
			c[1][2][2]
			c[1][2][3]

# Pointer c

## 2-d array pointer c

general pointer type

$\text{sizeof}(c) = \text{sizeof}(*c) * 2$

**c** is the name of a 3-d array and has a 2-d array pointer type but has a size of the array

**c** is a virtual array pointer

<code>int (*) [3][4]</code>	<code>int [3][4]</code>	<code>int [4]</code>	
<b>c</b>	<b>*c</b>	<b>*(*c+0)</b>	<code>*(*(*c+0)+0)</code>
2-d array pointer	2-d array	1-d array	<code>*(*(*c+0)+1)</code>
			<code>*(*(*c+0)+2)</code>
			<code>*(*(*c+0)+3)</code>
		1-d array	<code>*(*(*c+1)+0)</code>
			<code>*(*(*c+1)+1)</code>
			<code>*(*(*c+1)+2)</code>
		1-d array	<code>*(*(*c+1)+3)</code>
			<code>*(*(*c+2)+0)</code>
			<code>*(*(*c+2)+1)</code>
	2-d array	1-d array	<code>*(*(*c+2)+2)</code>
			<code>*(*(*c+2)+3)</code>
			<code>*(*(*c+1)+0)</code>
1-d array		<code>*(*(*c+1)+1)</code>	
		<code>*(*(*c+1)+2)</code>	
		<code>*(*(*c+1)+3)</code>	
1-d array		<code>*(*(*c+2)+0)</code>	
		<code>*(*(*c+2)+1)</code>	
		<code>*(*(*c+2)+2)</code>	
			<code>*(*(*c+2)+3)</code>



# Pointers to primitive data

**int \*p;**

**int i, j, k;**

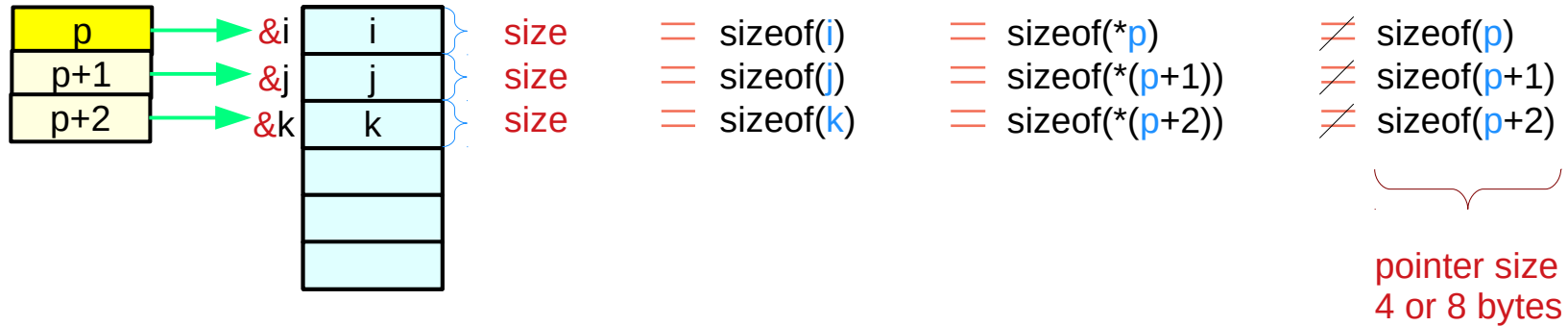

**double \*q;**

**double a, b, c;**

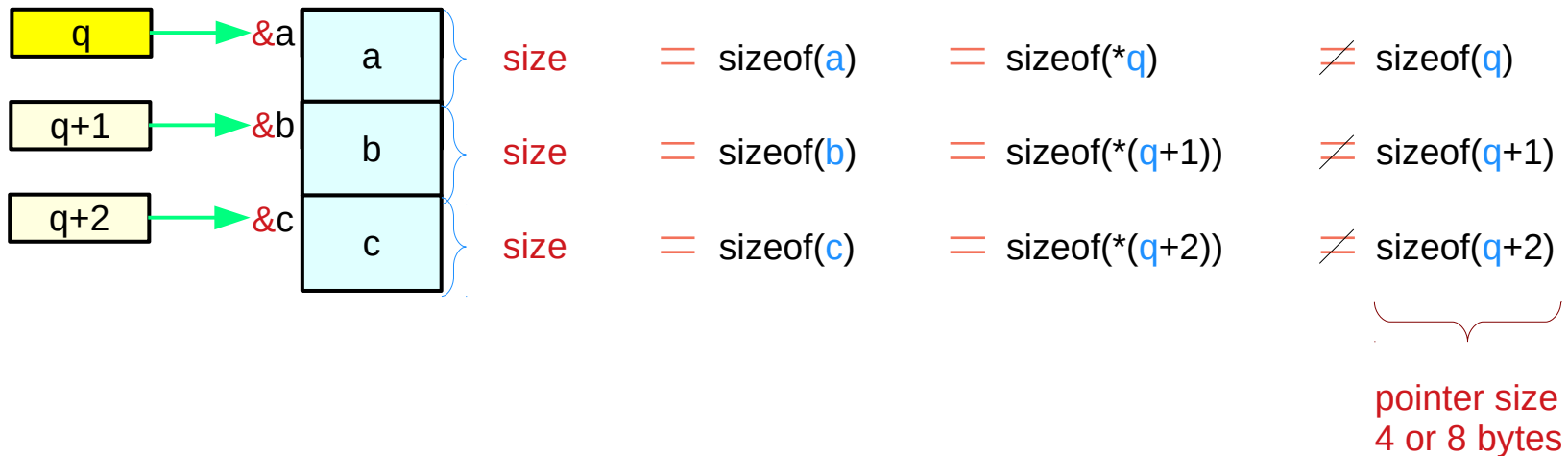

# Pointers to abstract data

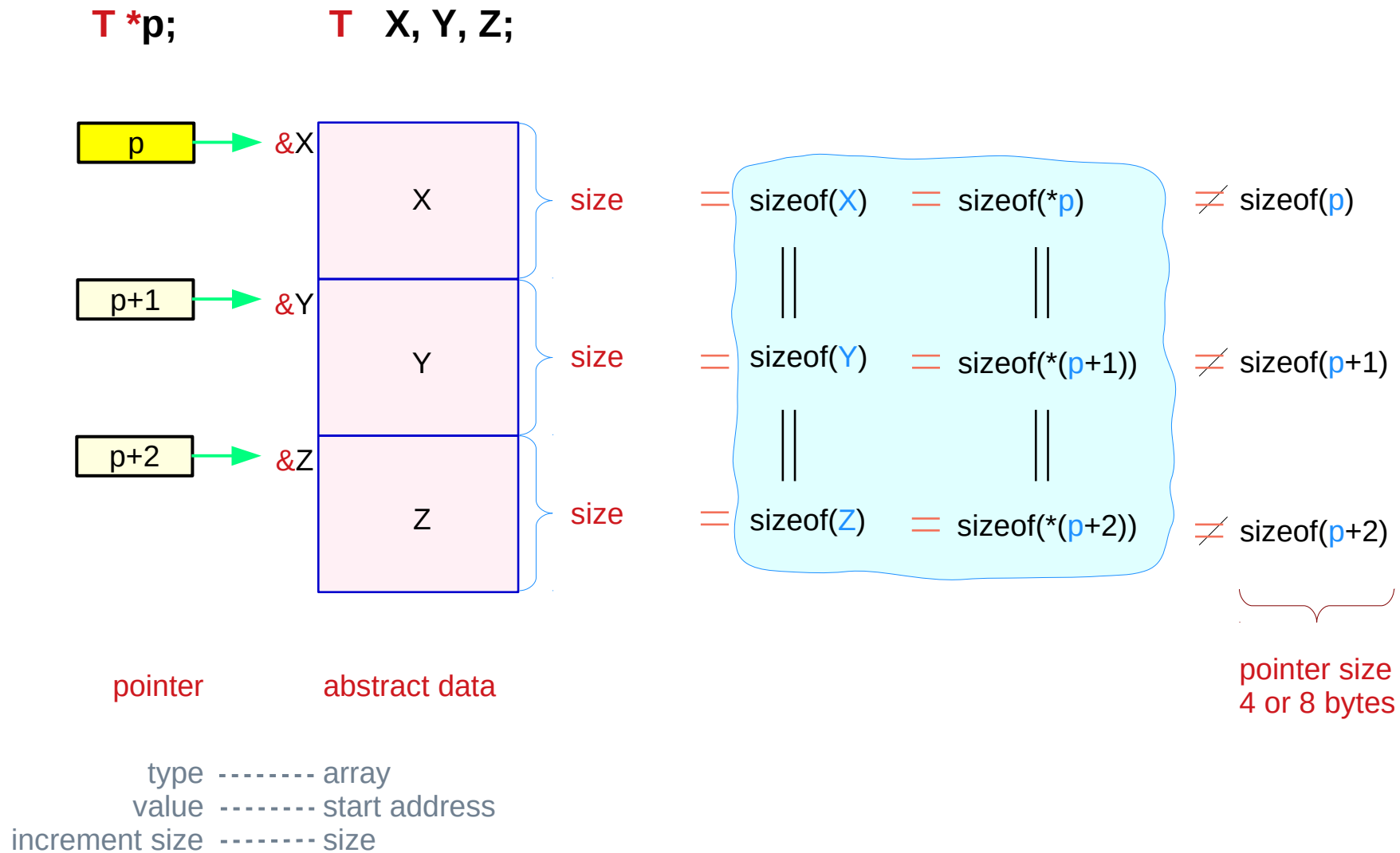

# Virtual pointers in a multi-dimensional array

$p[i] :: T1$        $*p[i], *p[i+1] :: T2$

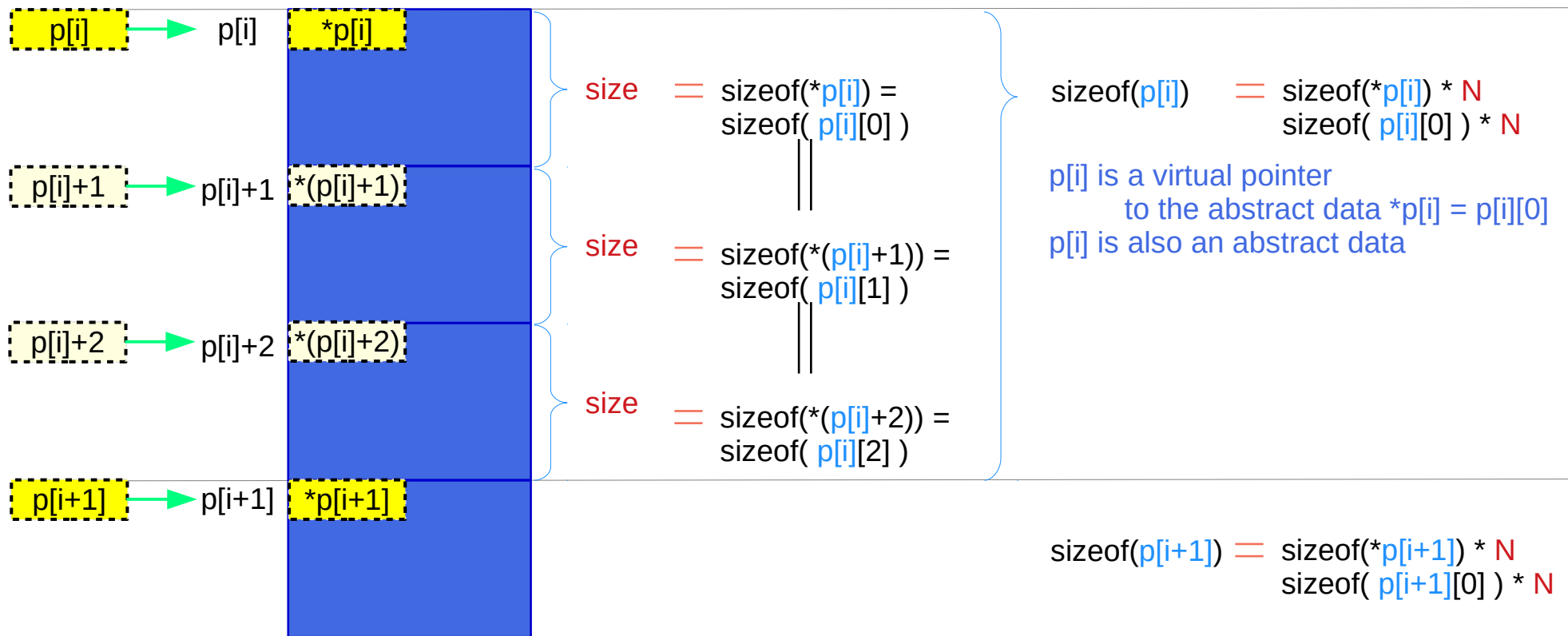

**T1**      **T2**  
 $\text{int} (*) [4]$        $\text{int} [4]$        $\subset \text{int} (*)$   
 $\text{int} (*) [3][4]$        $\text{int} [3][4]$        $\subset \text{int} (*) [4]$

# Virtual pointers in a multi-dimensional array

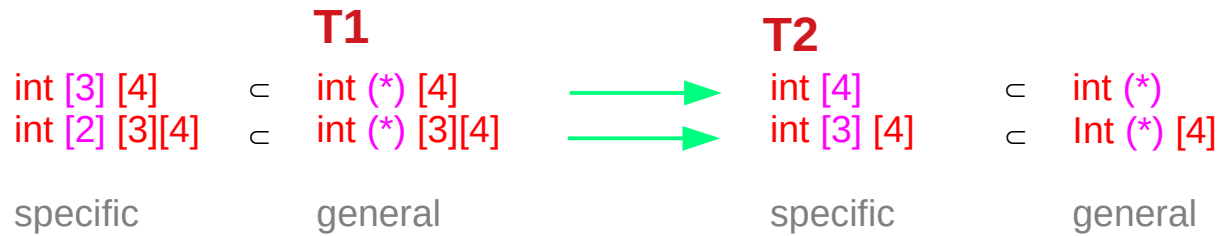

```
typedef int (*T1) [4];  
typedef int (*T1) [3][4];  
  
typedef int T2[4];  
typedef int T2[3][4];
```

**T1 a;**

**T2 b;**

T1 references T2  
T2 is a dereference of T1

T1 is a pointer type  
T2 is an array type  
T1 has one more dimension than T2

# Virtual array pointers – types, sizes, and values

<b>int c[2][3][4];</b>	<b>c[i][j]</b>	<b>c[i][j][0]</b>	
type	int [4] int (*)	int int	<ul style="list-style-type: none"> <li>abstract data type</li> <li>array pointer type</li> </ul>
size	sizeof(c[i][j]) =	sizeof(c[i][j][0]) * 4	= sizeof(int) * 4
value (address)	c[i][j] =	&c[i][j][0]	
<b>int c[2][3][4];</b>	<b>c[i]</b>	<b>c[i][0]</b>	
type	int [3][4] int (*)[4]	int [4] int (*)	<ul style="list-style-type: none"> <li>abstract data type</li> <li>array pointer type</li> </ul>
size	sizeof(c[i]) =	sizeof(c[i][0]) * 3	= sizeof(int) * 4 * 3
value (address)	c[i] =	&c[i][0]	
<b>int c[2][3][4];</b>	<b>c</b>	<b>c[0]</b>	
type	int [2][3][4] int (*)[3][4]	int [3][4] int (*)[4]	<ul style="list-style-type: none"> <li>abstract data type</li> <li>array pointer type</li> </ul>
size	sizeof(c) =	sizeof(c[0]) * 2	= sizeof(int) * 4 * 3 * 2
value (address)	c =	&c[0]	

# virtual array pointers c, c[i], c[i][j] – sizes

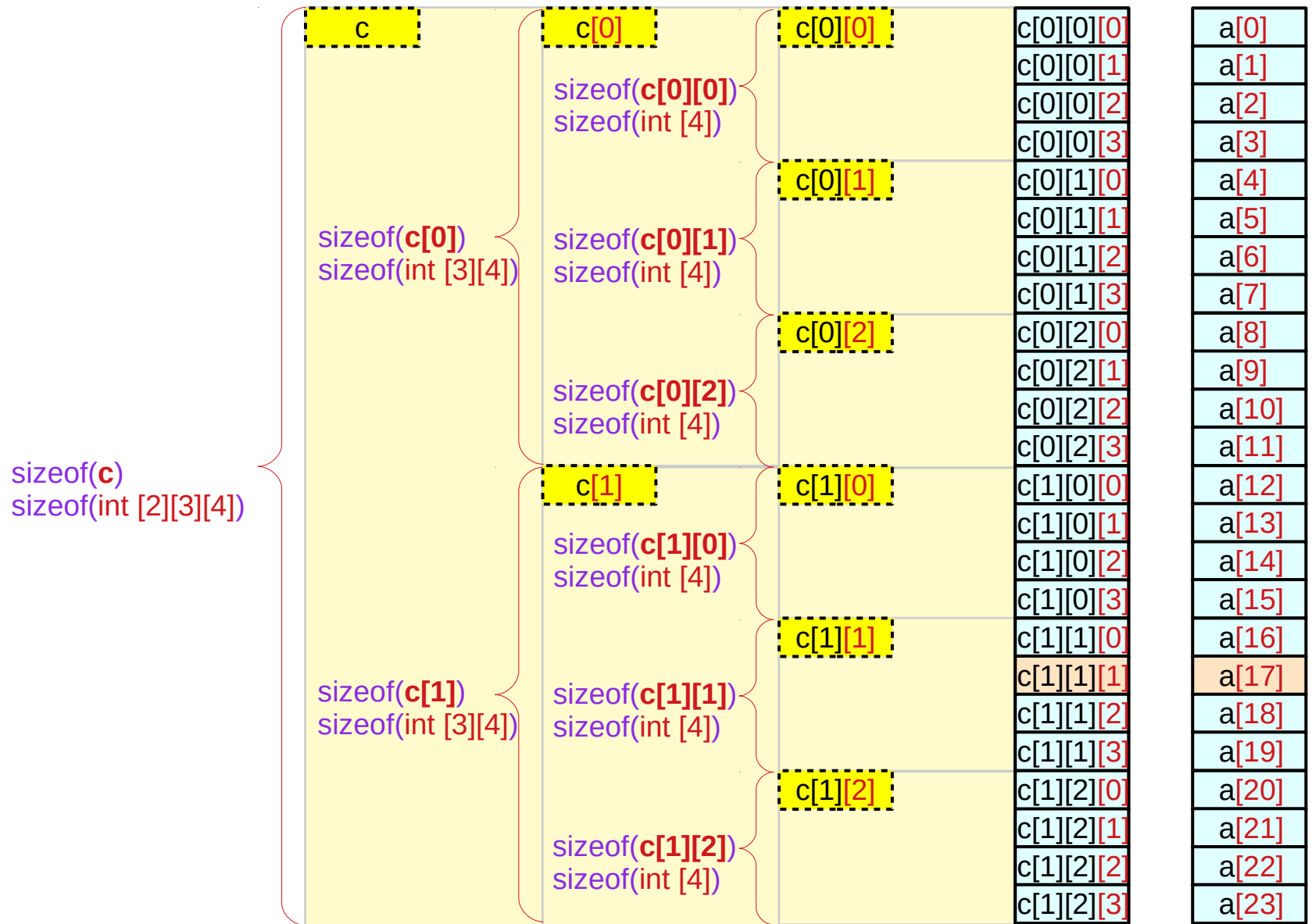

# Virtual array pointer $c$ , $c[i]$ , $c[i][j]$ – values (addresses)

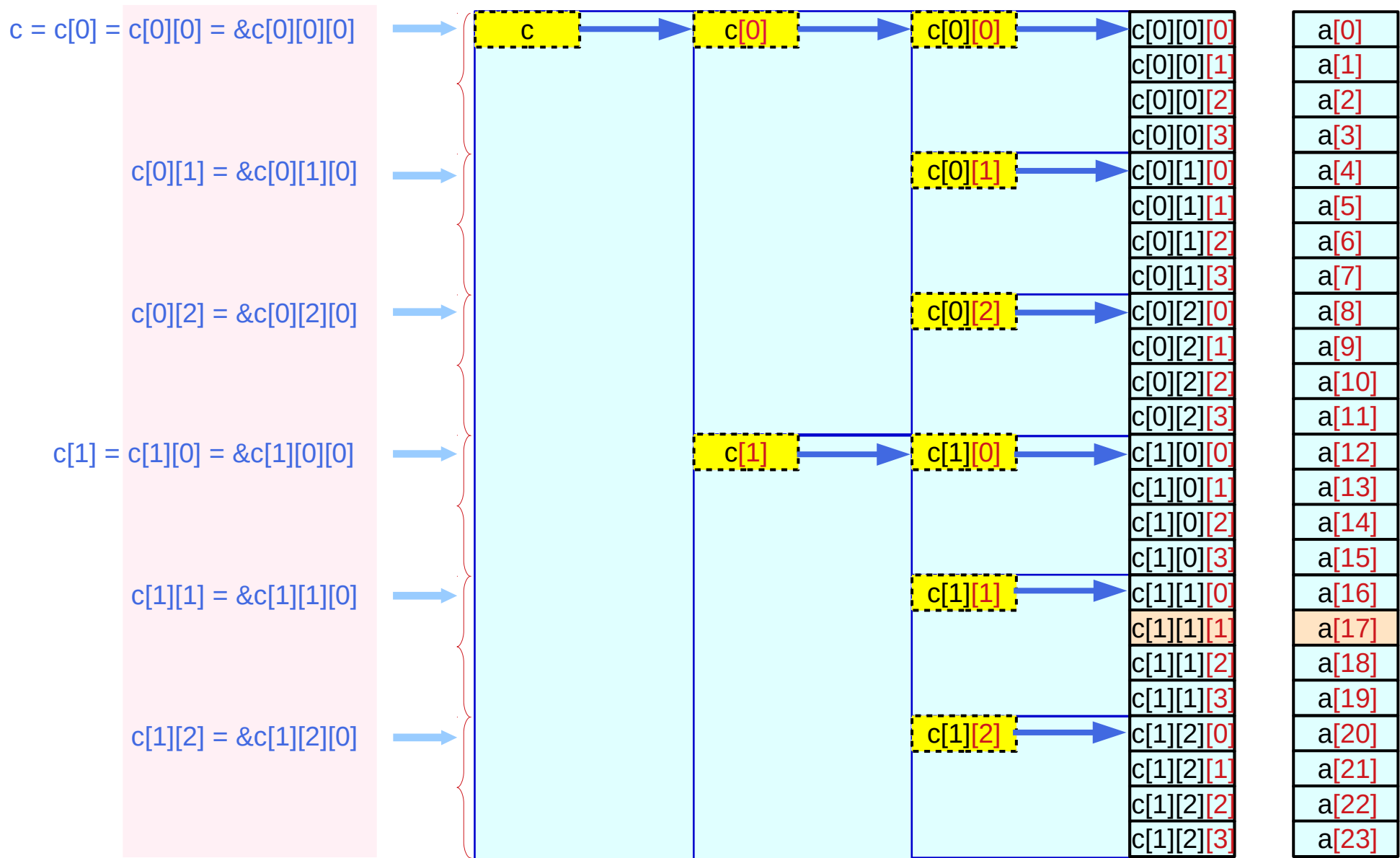

# Virtual array pointer $c$ , $c[i]$ , $c[i][j]$ – vertical displacement

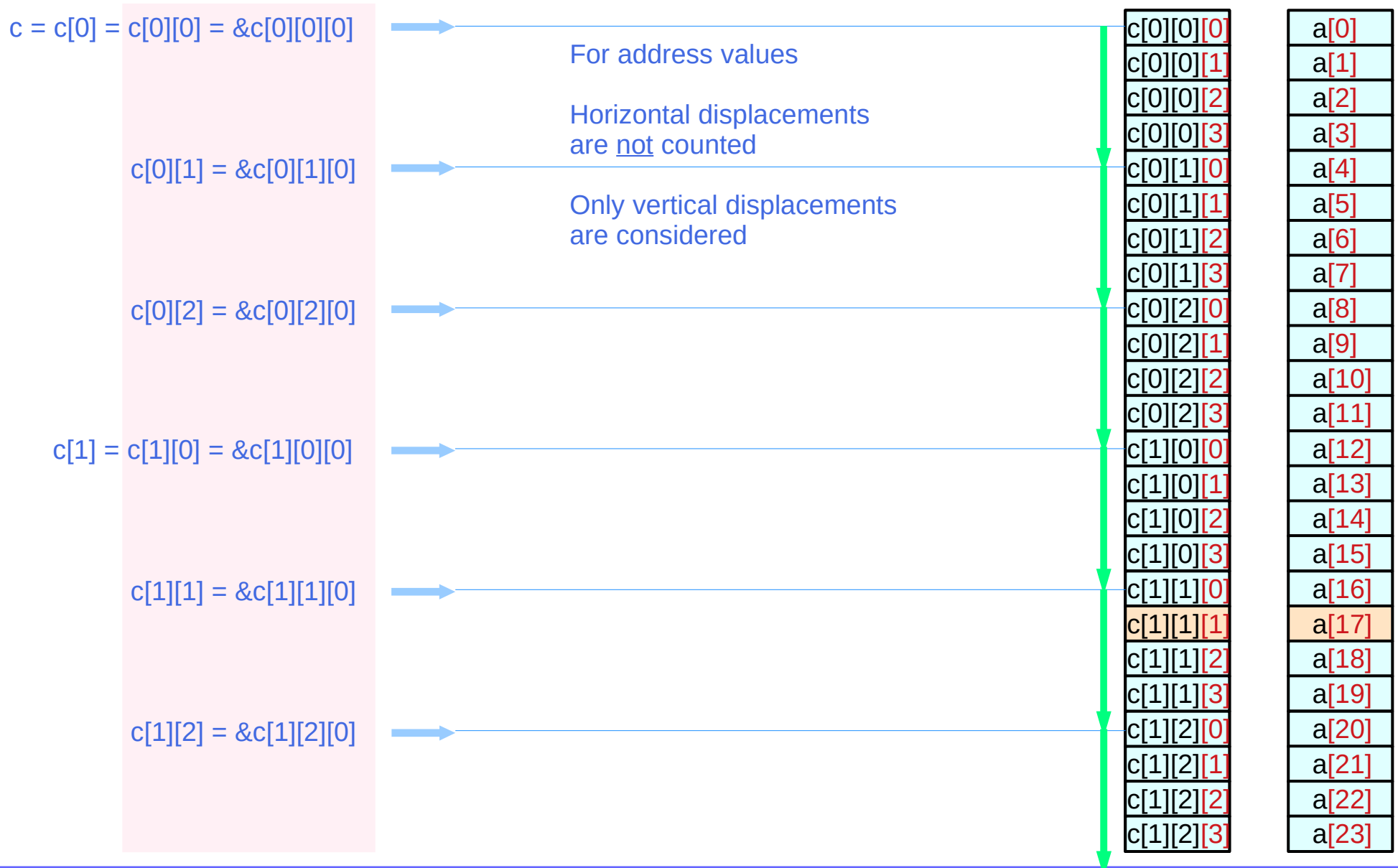



# Virtual array pointer c, c[i], c[i][j] – values and types

$c = c[0] = c[0][0] = \&c[0][0][0]$  means  $\rightarrow$   
 $c[0][1] = \&c[0][1][0]$  means  $\rightarrow$   
 $c[0][2] = \&c[0][2][0]$  means  $\rightarrow$   
 $c[1] = c[1][0] = \&c[1][0][0]$  means  $\rightarrow$   
 $c[1][1] = \&c[1][1][0]$  means  $\rightarrow$   
 $c[1][2] = \&c[1][2][0]$  means  $\rightarrow$

$value(c) = value(c[0]) = value(c[0][0]) = value(\&c[0][0][0])$ $type(c) \neq type(c[0]) \neq type(c[0][0]) = type(\&c[0][0][0])$ $int (*) [3][4] \quad int (*) [4] \quad int * \quad int *$
$value(c[0][1]) = value(\&c[0][1][0])$ $type(c[0][1]) = type(\&c[0][1][0])$ $int * \quad int *$
$value(c[0][2]) = value(\&c[0][2][0])$ $type(c[0][2]) = type(\&c[0][2][0])$ $int * \quad int *$
$value(c[1]) = value(c[1][0]) = value(\&c[1][0][0])$ $type(c[1]) \neq type(c[1][0]) = type(\&c[1][0][0])$ $int (*) [4] \quad int * \quad int *$
$value(c[1][1]) = value(\&c[1][1][0])$ $type(c[1][1]) = type(\&c[1][1][0])$ $int * \quad int *$
$value(c[1][2]) = value(\&c[1][2][0])$ $type(c[1][2]) = type(\&c[1][2][0])$ $int * \quad int *$

# Virtual array pointer c, c[0], c[0][0] – types and sizes

## Types – array pointers

`int (*) [3][4]`

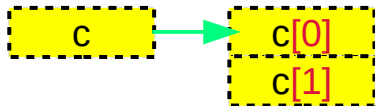

`int (*) [4]`

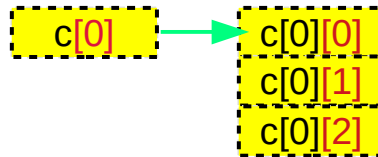

`int [4]`

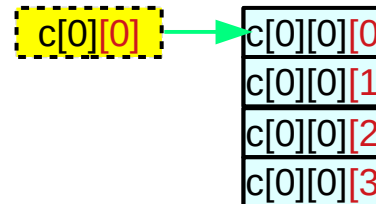

## Sizes – abstract data

`sizeof(c)`

`sizeof(c[0]) * 2`

`sizeof(c[0][0]) * 2 * 3`

`sizeof(c[0][0][0]) * 2 * 3 * 4`

`sizeof(int [2][3][4])`

`sizeof(int [2][3][4]) = 96`

`sizeof(int (*)[3][4]) = 4 / 8`

`sizeof(c[0])`

`sizeof(c[0][0]) * 3`

`sizeof(c[0][0][0]) * 3 * 4`

`sizeof(int [3][4])`

`sizeof(int [3][4]) = 48`

`sizeof(int (*)[4]) = 4 / 8`

`sizeof(c[0][0])`

`sizeof(c[0][0][0]) * 4`

`sizeof(int [4])`

`sizeof(int [4]) = 16`

`sizeof(int (*) = 4 / 8`

`sizeof(c[0][0][0])`

`sizeof(int)`

`sizeof(int) = 4`

# Abstract Data $c$ , $c[i]$ , $c[i][j]$ – start addresses and sizes

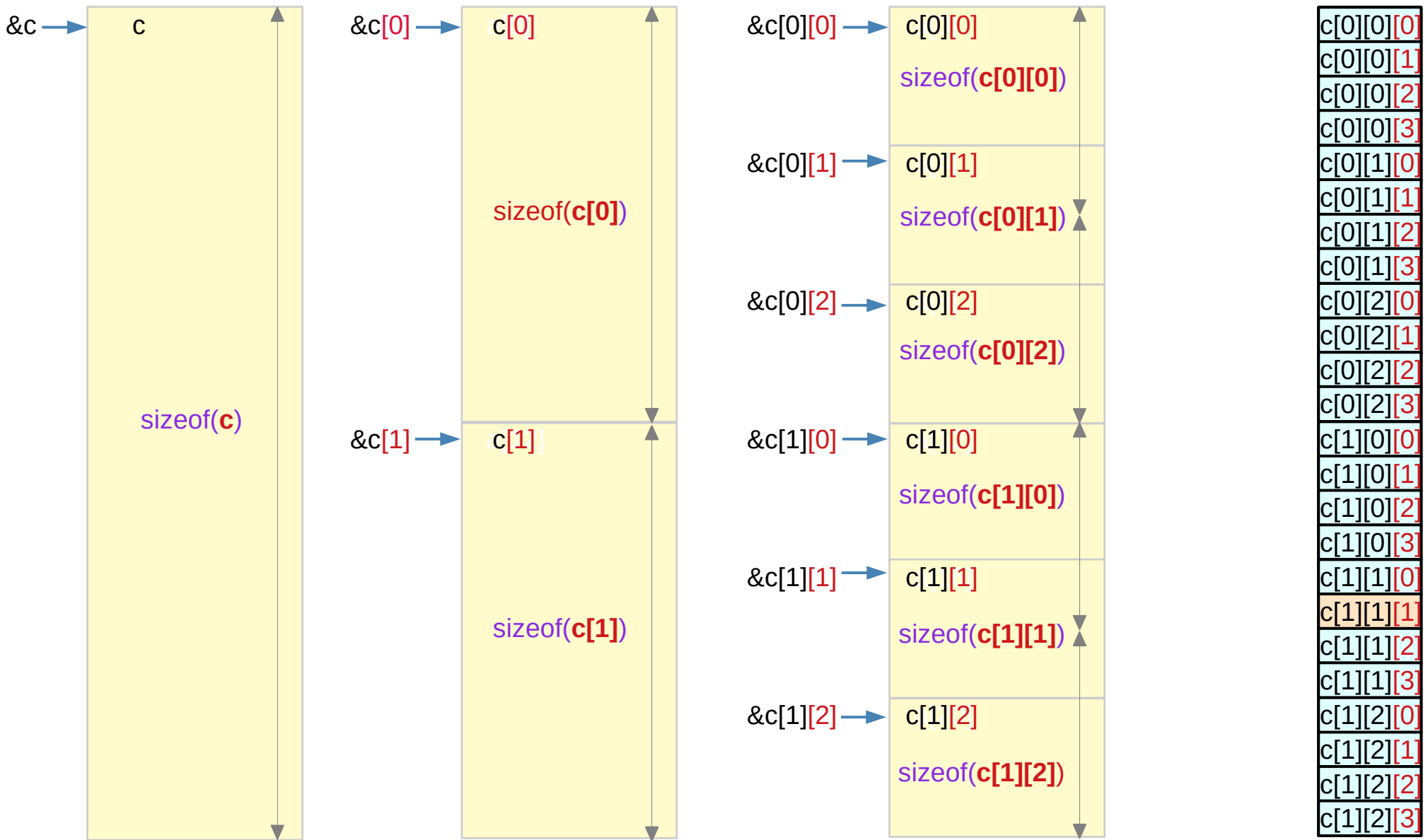

# Types in a multi-dimensional array

```
int c [2][3][4];
```

abstract data `int [2] [3][4]`  
array pointer `int (*) [3][4]`

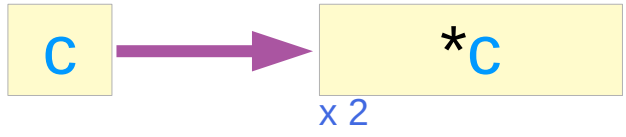

`int [3] [4]` abstract data  
`int (*) [4]` array pointer

abstract data `int [3] [4]`  
array pointer `int (*) [4]`

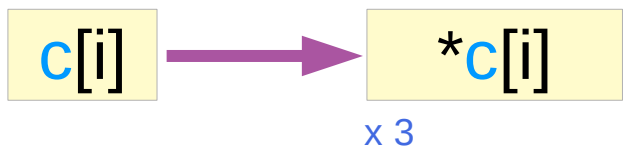

`int [4]` abstract data  
`int (*)` array pointer

abstract data `int [4]`  
array pointer `int (*)`

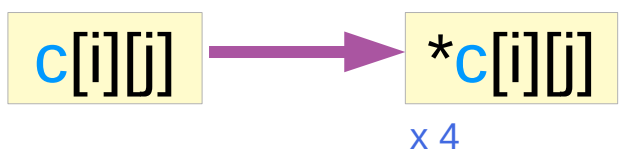

`int` primitive data

# Virtual array pointers and abstract data

```
int c [2][3][4];
```

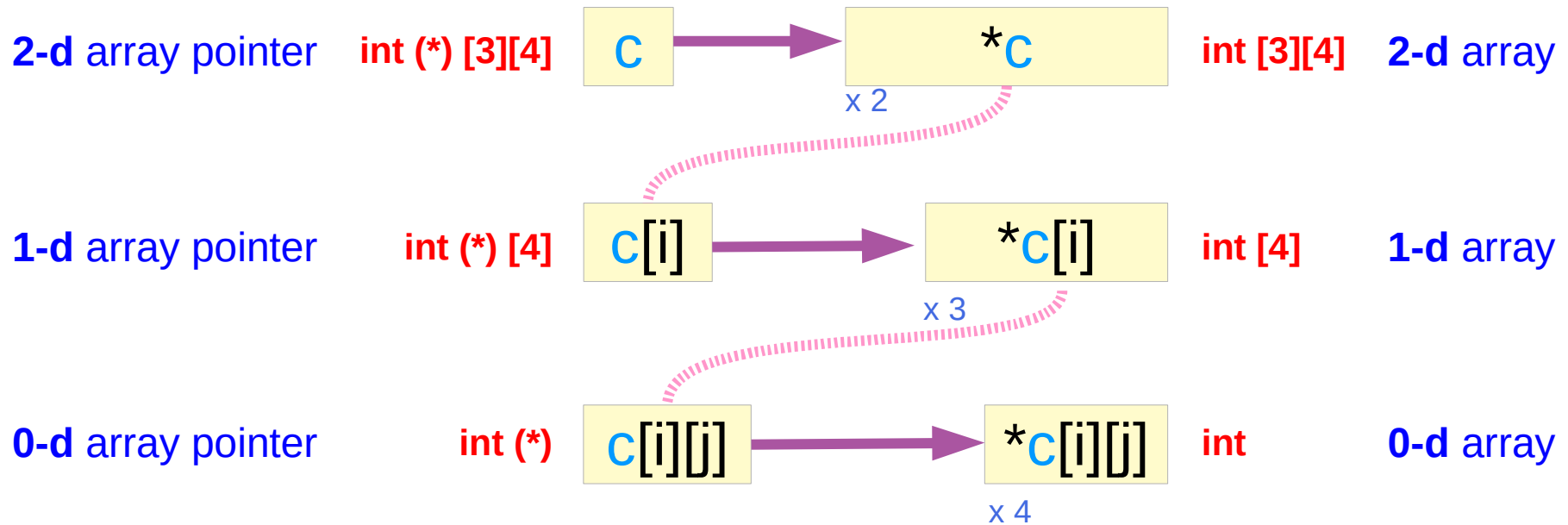

all these pointers are virtual, and take no actual memory locations

exploiting the **contiguity** of allocated memory locations

# Abstract Data Sizes

```
int c [2][3][4];
```

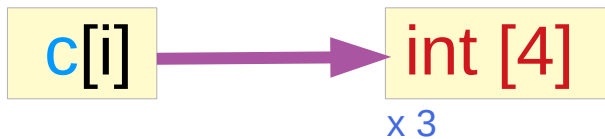
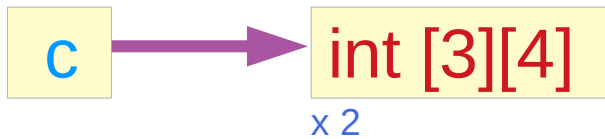

c, c[i], c[i][j] are virtual array pointers and they are also abstract data (arrays)

when sizes are considered, view them as abstract data (arrays)

the size of a pointer type is fixed  
Here, the sizes of virtual pointers are shown  
i.e, the sizes of different abstract data types

sizeof( c )	=	sizeof(int [2][3][4])
sizeof(*c)	=	sizeof(int [3][4])
sizeof( c[i] )	=	sizeof(int [3][4])
sizeof(*c[i] )	=	sizeof(int [4])
sizeof( c[i][j] )	=	sizeof(int [4])
sizeof(*c[i][j] )	=	sizeof(int)

all are sizes of arrays

# Virtual array pointer sizes and abstract data sizes

```
int c [2][3][4];
```

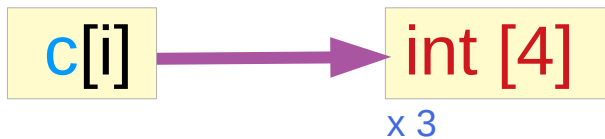
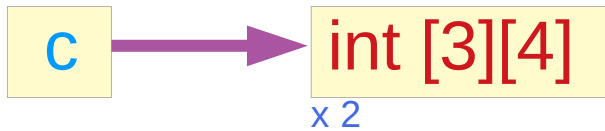

$$\text{size of a virtual array pointer} = \text{size of the pointed abstract data type} * \text{the number of such types}$$

$$\text{sizeof}( c ) = \text{sizeof}( *c ) * 2$$

$$\text{sizeof}( c[i] ) = \text{sizeof}( *c[i] ) * 3$$

$$\text{sizeof}( c[i][j] ) = \text{sizeof}( *c[i][j] ) * 4$$

# Sizes of array pointer types

```
int c [2][3][4];
```

c → int [3][4]

c[i] → int [4]

c[i][j] → int

not real array pointers  
virtual array pointers



c int (\*)[3][4]  
sizeof(int (\*) [3][4]) = pointer size ≠ sizeof(c)

c[i] int (\*) [4]  
sizeof(int (\*) [4]) = pointer size ≠ sizeof(c[i])

c[i][j] int [4]  
sizeof(int [4]) = pointer size ≠ sizeof(c[i][j])

4 bytes for 32-bit machines  
8 bytes for 64-bit machines



# Hierarchical nested array pointers

```
int c [2][3][4];
```

c points to a **2-d** array  
increment size:  $\text{sizeof}(\text{int}) * 2 * 3 * 4$

c[i] points to an **1-d** array  
increment size:  $\text{sizeof}(\text{int}) * 3 * 4$

c[i][j] points to an integer  
increment size:  $\text{sizeof}(\text{int}) * 4$

int (\*) [3][4]



int (\*) [4]

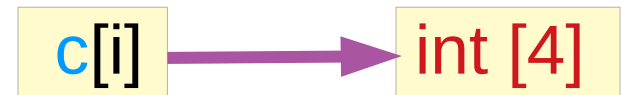

int (\*)



# Sub-array properties in multi-dimensional arrays

`int c [2][3][4];` → 3-d access `c [i][j][k]`

2-d array pointer	<code>c</code>	<code>int (*) [3][4]</code>
1-d array pointers	<code>c[i]</code>	<code>int (*) [4]</code>
0-d array pointers	<code>c[i][j]</code>	<code>int (*)</code>

# Hierarchical Sub-arrays in a 3-d array

```
int c [L][M][N];
```

```
c [i][j][k]
```

left-to-right associativity

Array Names and Types

Pointers to hierarchical sub-arrays

c	[i]	[j][k]
c[i]	[j]	[k]
c[i][j]	[k]	

c	3-d array names	int (*) [M][N]	2-d array pointer
c[i]	2-d array names	int (*) [N]	1-d array pointer
c[i][j]	1-d array names	int (*)	0-d array pointer

# General requirements for accessing $c[i][j][k]$

$c[i][j][k]$



$$\begin{aligned}\&c[i][j][k] &= c[i][j] + k \\ \&c[i][j] &= c[i] + j \\ \&c[i] &= c + i\end{aligned}$$

$$\begin{aligned}c[i][j][k] &= *(c[i][j] + k) \\ c[i][j] &= *(c[i] + j) \\ c[i] &= *(c + i)\end{aligned}$$

$$\begin{aligned}\&c[i][j][0] &= c[i][j] \\ \&c[i][0] &= c[i] \\ \&c[0] &= c\end{aligned}$$

$$\begin{aligned}c[i][j][0] &= *(c[i][j]) \\ c[i][0] &= *(c[i]) \\ c[0] &= *(c)\end{aligned}$$

# 3-d access pattern $c[i][j][k]$

## General requirements

$c[i][j][k]$



$\&c[i][j][k] = c[i][j] + k$   
 $\&c[i][j] = c[i] + j$   
 $\&c[i] = c + i$

$\&c[i][j][0] = c[i][j]$   
 $\&c[i][0] = c[i]$   
 $\&c[0] = c$

## Pointer array approach

```
int** c[2];  
int* b[2*3];  
int c[2*3*4];
```

$c[i][j][k] :: \text{int}$   
 $c[i][j] :: \text{int}^*$   
 $c[i] :: \text{int}^{**}$

$c[i] \leftarrow \&b[i*3]$   
 $b[j] \leftarrow \&a[j*4]$

**Explicit**  
Arrays of pointers with  
Multiple Indirection

## N-dim Array approach

```
int c[2][3][4];
```

$c[i][j][k] :: \text{int}$   
 $c[i][j] :: \text{int}[4]$   
 $c[i] :: \text{int}^*[4]$

$c[i][j] \leftarrow \&c[i][j][0]$   
 $c[i] \leftarrow \&c[i][0][0]$   
 $c \leftarrow \&c[0][0][0]$

**Implicit**  
Nested  
Virtual Array Pointers

# 3-d access pattern $c[i][j][k]$ – array pointer approach

## General requirements

$c[i][j][k]$



$\&c[i][j][k] = c[i][j] + k$   
 $\&c[i][j] = c[i] + j$   
 $\&c[i] = c + i$

$\&c[i][j][0] = c[i][j]$   
 $\&c[i][0] = c[i]$   
 $\&c[0] = c$

## N-dim array approach

$\text{int } c[2][3][4];$

$c[i][j][k] :: \text{int}$   
 $c[i][j] :: \text{int } [4]$   
 $c[i] :: \text{int } (*) [4]$   
 $c :: \text{int } (*) [3][4]$

$c[i][j] \leftarrow \&c[i][j][0]$   
 $c[i] \leftarrow \&c[i][0][0]$   
 $c \leftarrow \&c[0][0][0]$

**Implicit  
Nested  
Virtual Array Pointers**



# Using N-dimensional arrays

```
int c [2][3][4];
```



```
c [i][j][k];
```

## constraints

```
c ← &c[0][0][0]  
c[i] ← &c[i][0][0]  
c[i][j] ← &c[i][j][0]
```

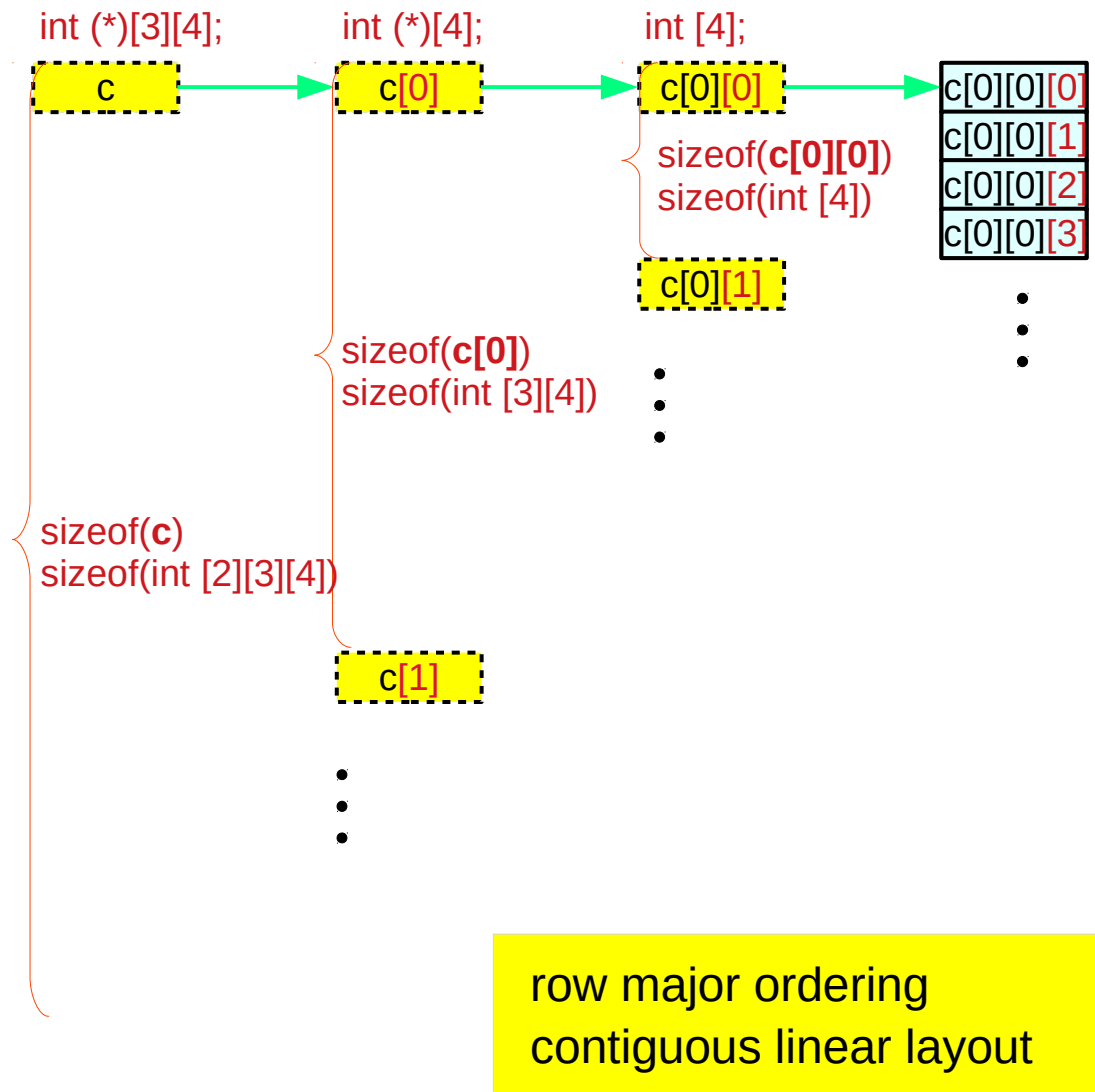

# Types of `c[i]` and `c[i][j]`

`c [i][j][k];`

`&c[i][j][0] = c[i][j]`  
`&c[i][0] = c[i]`  
`&c[0] = c`

`&c[i][j][k] = c[i][j]+k`  
`&c[i][j] = c[i]+j`  
`&c[i] = c+i`

`int c [2][3][4];`

`c[i]` virtual array pointer of the type `int (*) [4]`  
`c[i][j]` : the name of 1-d array with 4 integers `int [4]`

`c[i][j]` (virtual array) pointer of the type `int (*)`  
`c[i][j][k]` : an element of a 4-integer array `int`

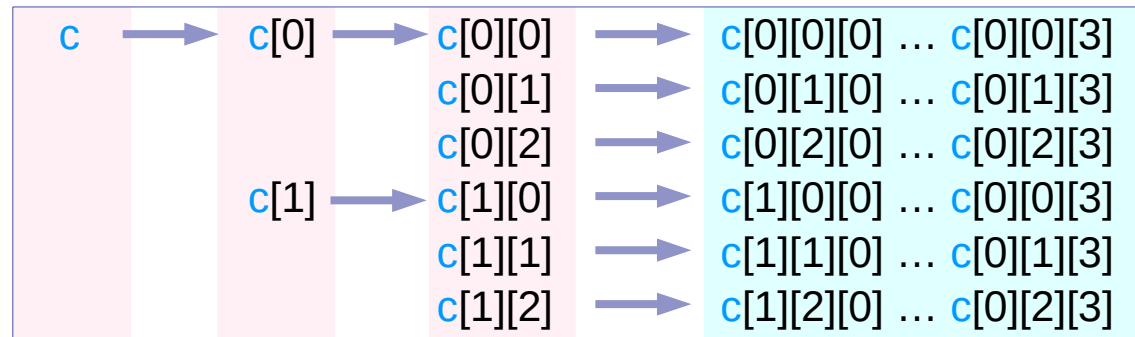

`int [2] [3][4]`   `int [3] [4]`   `int [4]`   `int ... int`  
`int (*) [3][4]`   `int (*) [4]`   `int (*)`   `int ... int`

pointers to a 2-d array   pointers to a 1-d array   1-d array names   leading element of 4-integer array



# Values of $c[i]$ and $c[i][j]$

$c[i][j][k];$

$\&c[i][j][0] = c[i][j]$   
 $\&c[i][0] = c[i]$   
 $\&c[0] = c$

$\&c[i][j][k] = c[i][j] + k$   
 $\&c[i][j] = c[i] + j$   
 $\&c[i] = c + i$

$\text{int } c[2][3][4];$

**virtual** array pointers

in each row in the following figure  
have the same value (address value)

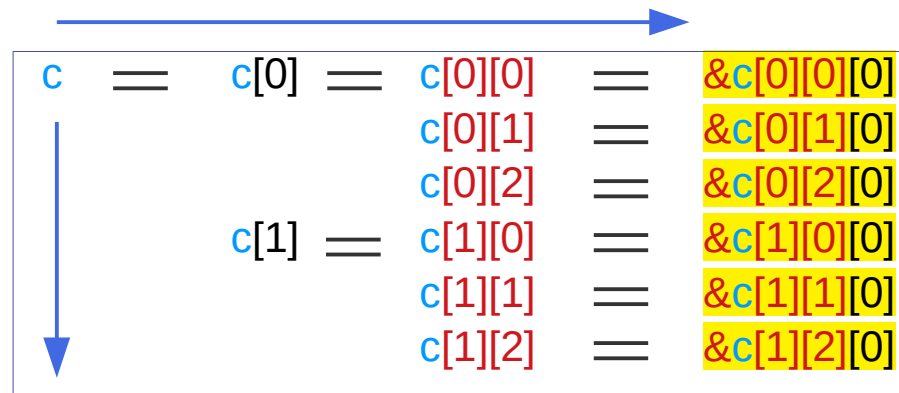

**Horizontal displacements** are not counted  
only **vertical displacements** are considered  
for address values

$c[i][j] = \&c[i][j][0]$   
 $c[i] = \&c[i][0][0]$   
 $c = \&c[0][0][0]$

# Finding address values of **c**, **c[i]**, **c[i][j]**

**c [i][j][k];**

$\&c[i][j][0] = c[i][j]$   
 $\&c[i][0] = c[i]$   
 $\&c[0] = c$

$\&c[i][j][k] = c[i][j] + k$   
 $\&c[i][j] = c[i] + j$   
 $\&c[i] = c + i$

**int c [2][3][4];**

$c[i][j] = \&c[i][j][0]$   
 $c[i] = \&c[i][0][0]$   
 $c = \&c[0][0][0]$

append [0] to the right

<b>c</b>	$\xrightarrow{+0}$	<b>c[0]</b>	$\xrightarrow{+0}$	<b>c[0][0]</b>	$\xrightarrow{+0}$	<b>&amp;c[0][0][0]</b>
				<b>c[0][1]</b>	$\xrightarrow{+0}$	<b>&amp;c[0][1][0]</b>
				<b>c[0][2]</b>	$\xrightarrow{+0}$	<b>&amp;c[0][2][0]</b>
		<b>c[1]</b>	$\xrightarrow{+0}$	<b>c[1][0]</b>	$\xrightarrow{+0}$	<b>&amp;c[1][0][0]</b>
				<b>c[1][1]</b>	$\xrightarrow{+0}$	<b>&amp;c[1][1][0]</b>
				<b>c[1][2]</b>	$\xrightarrow{+0}$	<b>&amp;c[1][2][0]</b>

int (\*) [3][4]    int (\*) [4]

int [4]

int

**c[i][j][0]** :  
leading  
elements  
of **c[i][j]**

**c[i][0][0]** :  
leading  
elements  
of **c[i]**

**c[0][0][0]** :  
leading  
elements  
of **c**

**&c[0][0][0]**  
**&c[0][1][0]**  
**&c[0][2][0]**  
**&c[1][0][0]**  
**&c[1][1][0]**  
**&c[1][2][0]**

**&c[0][0][0]**  
  
**&c[1][0][0]**

**&c[0][0][0]**

# Finding sub arrays for the leading elements $c[i][j][0]$

$c[i][j][k];$

```
&c[i][j][0] = c[i][j]
&c[i][0]    = c[i]
&c[0]      = c
```

```
&c[i][j][k] = c[i][j]+k
&c[i][j]    = c[i]+j
&c[i]       = c+i
```

$int\ c[2][3][4];$

```
c[i][j] = &c[i][j][0]
c[i]    = &c[i][0][0]
c       = &c[0][0][0]
```

delete [0] from the right

$\&c[0][0][0]$	$\underline{\underline{-[0]}}$	$c[0][0]$	$\underline{\underline{-[0]}}$	$c[0]$	$\underline{\underline{-[0]}}$	$c$
$\&c[0][1][0]$	$\underline{\underline{-[0]}}$	$c[0][1]$				
$\&c[0][2][0]$	$\underline{\underline{-[0]}}$	$c[0][2]$				
$\&c[1][0][0]$	$\underline{\underline{-[0]}}$	$c[1][0]$	$\underline{\underline{-[0]}}$	$c[1]$		
$\&c[1][1][0]$	$\underline{\underline{-[0]}}$	$c[1][1]$				
$\&c[1][2][0]$	$\underline{\underline{-[0]}}$	$c[1][2]$				

int

int [4]

int (\*) [4]

int (\*) [3][4]

$c[0][0][0]$  is the leading element of  $c[0][0]$ ,  $c[0]$ ,  $c$   
 $c[0][1][0]$  is the leading element of  $c[0][1]$   
 $c[0][2][0]$  is the leading element of  $c[0][2]$   
 $c[1][0][0]$  is the leading element of  $c[1][0]$ ,  $c[1]$   
 $c[1][1][0]$  is the leading element of  $c[1][1]$   
 $c[1][2][0]$  is the leading element of  $c[1][2]$

## multi-dimensional arrays

```
c[i][j] = &c[i][j][0]  
c[i]    = &c[i][0][0]  
c       = &c[0][0][0]
```

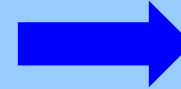

```
&c[i][j][0] = c[i][j]  
&c[i][0]    = c[i]  
&c[0]       = c
```

# Pointer reference and dereference relationship

```
c [i][j][k];
```

```
&c[i][j][0] = c[i][j]
&c[i][0]     = c[i]
&c[0]       = c
```

```
&c[i][j][k] = c[i][j]+k
&c[i][j]    = c[i]+j
&c[i]       = c+i
```

```
int c [2][3][4];
```

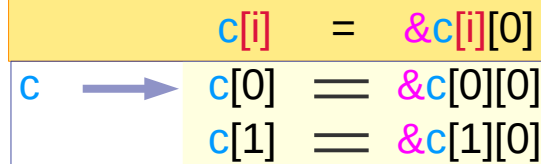
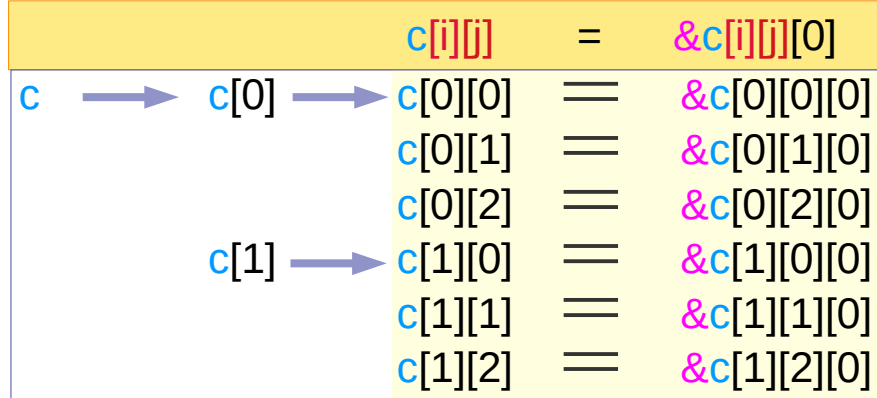
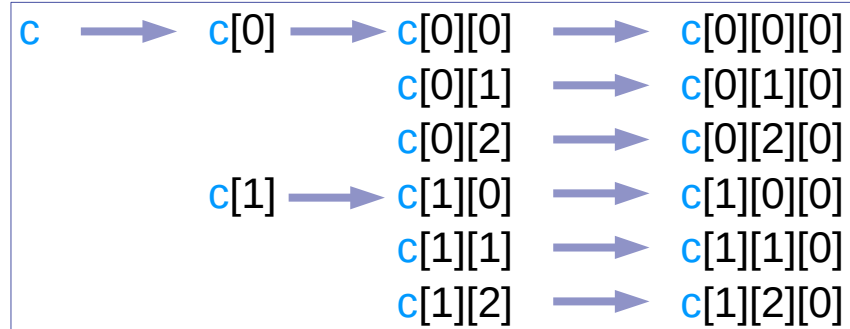

```
c = &c[0]
```

```
c == c[0]
```

# General requirements for `c[i][j][k]`

`c [i][j][k];`

`&c[i][j][0] = c[i][j]`  
`&c[i][0] = c[i]`  
`&c[0] = c`

`&c[i][j][k] = c[i][j]+k`  
`&c[i][j] = c[i]+j`  
`&c[i] = c+i`

`int c [2][3][4];`

`c[i][j]` virtual array pointer of the type `int (*)`  
`c[i][j][0]` : leading element of a 4-integer array `int`

`*(c[0][0]+0) = c[0][0][0]`  
`*(c[0][1]+0) = c[0][1][0]`  
`*(c[0][2]+0) = c[0][2][0]`  
`*(c[1][0]+0) = c[1][0][0]`  
`*(c[1][1]+0) = c[1][1][0]`  
`*(c[1][2]+0) = c[1][2][0]`

`c[0][0]` is the address of `c[0][0][0]`  
`c[0][1]` is the address of `c[0][1][0]`  
`c[0][2]` is the address of `c[0][2][0]`  
`c[1][0]` is the address of `c[1][0][0]`  
`c[1][1]` is the address of `c[1][1][0]`  
`c[1][2]` is the address of `c[1][2][0]`

`c[i]` virtual array pointer of the type `int (*) [4]`  
`c[i][j]` : a 4-element 1-d array name `int [4]`

`*(c[0]+0) = c[0][0]`  
`*(c[1]+0) = c[1][0]`

`c[0]` is the address of `c[0][0]`  
`c[1]` is the address of `c[1][0]`

`c[i][j] = &c[i][j][0]`  
`c[i] = &c[i][0][0]`  
`c = &c[0][0][0]`

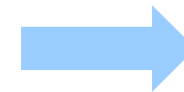

`&c[i][j][0] = c[i][j]`  
`&c[i][0] = c[i]`  
`&c[0] = c`

## multi-dimensional arrays

```
c[i][j] = &c[i][j][0]  
c[i]   = &c[i][0][0]  
c      = &c[0][0][0]
```



```
&c[i][j][0] = c[i][j]  
&c[i][0]   = c[i]  
&c[0]      = c
```

# c[0] = c[0][0] relation

`c [i][j][k];`

`&c[i][j][0] = c[i][j]`  
`&c[i][0] = c[i]`  
`&c[0] = c`

`&c[i][j][k] = c[i][j]+k`  
`&c[i][j] = c[i]+j`  
`&c[i] = c+i`

`int c [2][3][4];`

`c == c[0] == c[0][0] == &c[0][0][0]`

`value(c[0]) = &c[0][0][0]`

`value(c[0][0]) = &c[0][0][0]`

`type(c[0]) = int (*)[4]`

`type(c[0][0]) = int [4]`

`c[0] = c[0][0] means`  
`value(c[0]) = value(c[0][0])`

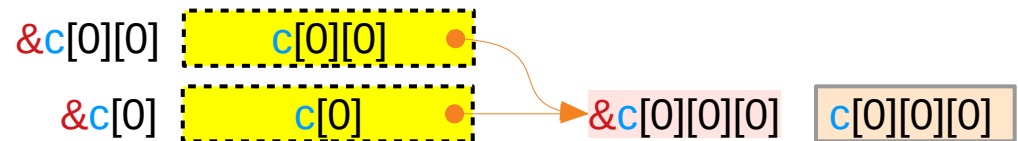

`c[i][j] = &c[i][j][0]`  
`c[i] = &c[i][0][0]`  
`c = &c[0][0][0]`



# Addresses and Values of $c[0]$ and $c[0][0]$

$c[i][j][k];$

$\&c[i][j][0] = c[i][j]$   
 $\&c[i][0] = c[i]$   
 $\&c[0] = c$

$\&c[i][j][k] = c[i][j] + k$   
 $\&c[i][j] = c[i] + j$   
 $\&c[i] = c + i$

$\text{int } c[2][3][4];$

$c \rightarrow c[0] \rightarrow c[0][0] = \&c[0][0][0]$

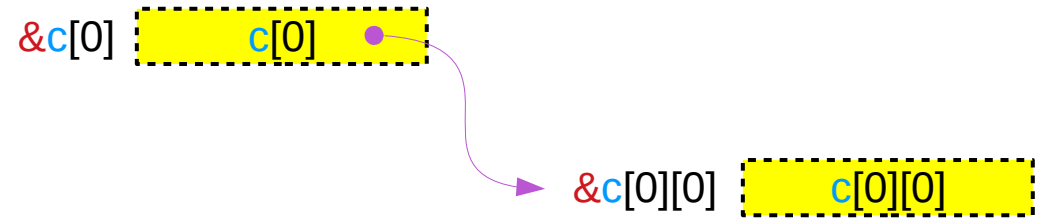

$c = c[0] = c[0][0] = \&c[0][0][0]$

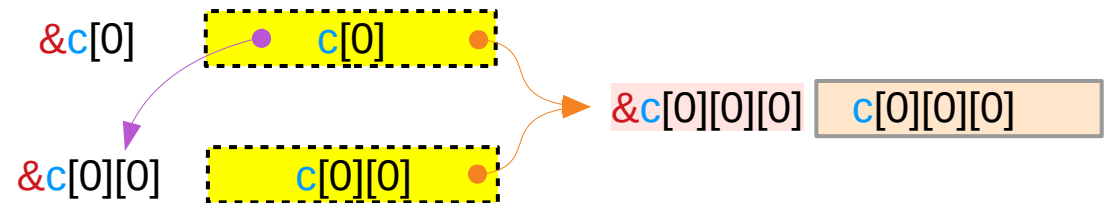

A virtual pointer's address and value are the same

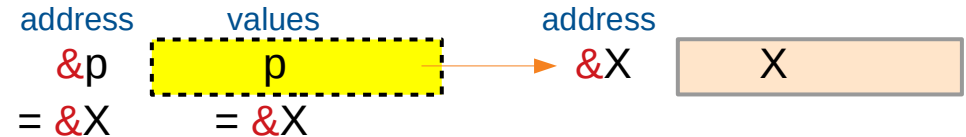

# c[0] and c[0][0] point to the same c[i][0][0]

c [i][j][k];

&c[i][j][0] = c[i][j]  
 &c[i][0] = c[i]  
 &c[0] = c

&c[i][j][k] = c[i][j]+k  
 &c[i][j] = c[i]+j  
 &c[i] = c+i

int c [2][3][4];

c[i][j] = &c[i][j][0]  
 c[i] = &c[i][0][0]  
 c = &c[0][0][0]

c = c[0] = c[0][0] = &c[0][0][0] ← value  
 int(\*)[3][4] int(\*)[4] int(\*) int ← type

c[1] = c[1][0] = &c[1][0][0] ← value  
 int(\*)[4] int(\*) int ← type

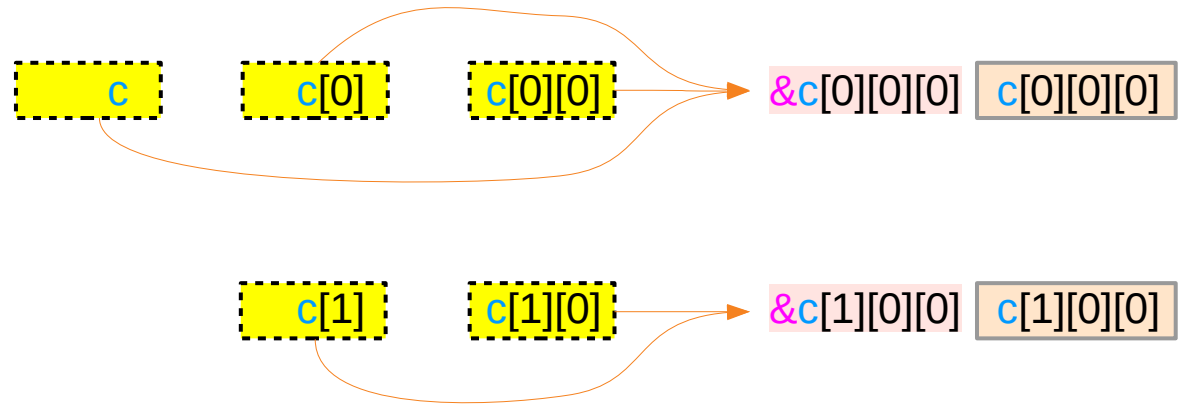

These virtual pointers have different types but the same value (address)

# &c[i][0] and &c[i][0][0] – equivalence relations

`c [i][j][k];`

`&c[i][j][0] = c[i][j]`  
`&c[i][0] = c[i]`  
`&c[0] = c`

`&c[i][j][k] = c[i][j]+k`  
`&c[i][j] = c[i]+j`  
`&c[i] = c+i`

`int c [2][3][4];`

`c[i][j] = &c[i][j][0]`  
`c[i] = &c[i][0][0]`  
`c = &c[0][0][0]`

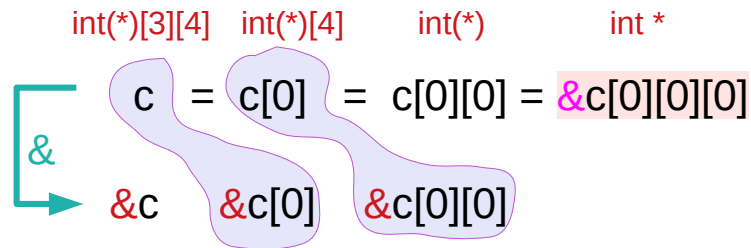

equivalences

`c ≡ &c[0],`  
`c[0] ≡ &c[0][0]`  
`c[0][0] ≡ &c[0][0][0]`

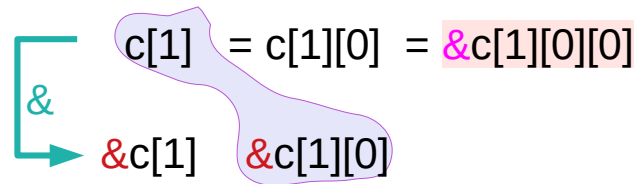

equivalences

`c[1] ≡ &c[1][0]`  
`c[1][0] ≡ &c[1][0][0]`

Horizontal displacements are not counted  
 only vertical displacements are considered  
 for address values

equivalences

`c ≡ &c[0],`  
`c[i] ≡ &c[i][0]`  
`c[i][0] ≡ &c[i][0][0]`

# $c[i] = \&c[i]$ and $c[i][0] = \&c[i][0]$

$c[i][j][k];$

$\&c[i][j][0] = c[i][j]$   
 $\&c[i][0] = c[i]$   
 $\&c[0] = c$

$\&c[i][j][k] = c[i][j] + k$   
 $\&c[i][j] = c[i] + j$   
 $\&c[i] = c + i$

$\text{int } c[2][3][4];$

$c[i][j] = \&c[i][j][0]$   
 $c[i] = \&c[i][0][0]$   
 $c = \&c[0][0][0]$

$c = c[0] = c[0][0] = \&c[0][0][0]$   
 $\parallel$   
 $\&c = \&c[0] = \&c[0][0]$

$c[1] = c[1][0] = \&c[1][0][0]$   
 $\parallel$   
 $\&c[1] = \&c[1][0]$

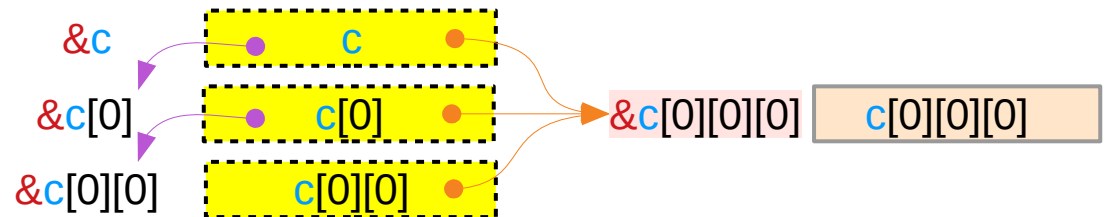

# $c[i] = \&c[i]$ and $c[i][0] = \&c[i][0]$

$c[i][j][k];$

$\&c[i][j][0] = c[i][j]$   
 $\&c[i][0] = c[i]$   
 $\&c[0] = c$

$\&c[i][j][k] = c[i][j] + k$   
 $\&c[i][j] = c[i] + j$   
 $\&c[i] = c + i$

$\text{int } c[2][3][4];$

$c[i][j] = \&c[i][j][0]$   
 $c[i] = \&c[i][0][0]$   
 $c = \&c[0][0][0]$

A virtual pointer's address and value are the same

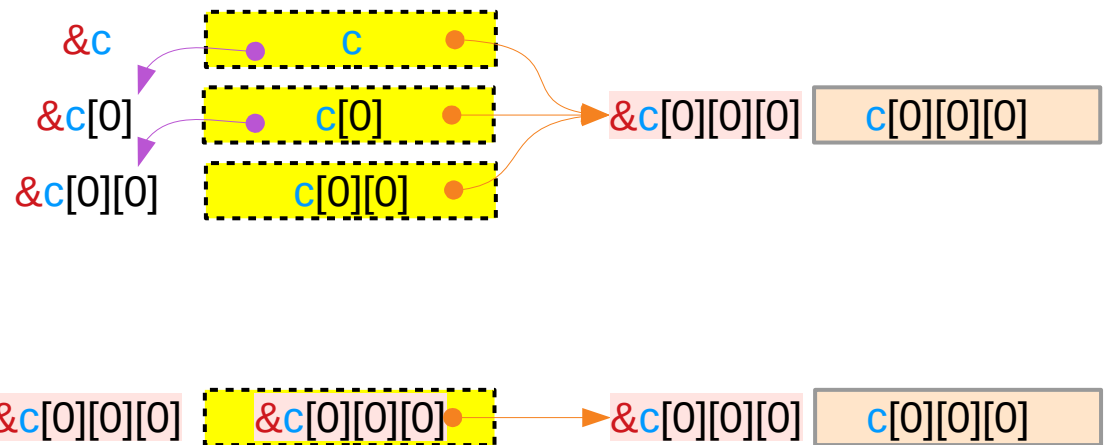
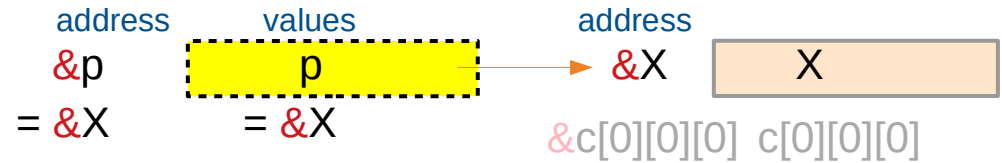

## Leading elements and array pointers

`c[0][0][0]` is the leading element of `c[0][0]`, `c[0]`, `c`

`c[0][1][0]` is the leading element of `c[0][1]`

`c[0][2][0]` is the leading element of `c[0][2]`

`c[1][0][0]` is the leading element of `c[1][0]`, `c[1]`

`c[1][1][0]` is the leading element of `c[1][1]`

`c[1][2][0]` is the leading element of `c[1][2]`

# Array Pointers to $c[i][0][0]$

$c[i][j][k];$

$\&c[i][j][0] = c[i][j]$   
 $\&c[i][0] = c[i]$   
 $\&c[0] = c$

$\&c[i][j][k] = c[i][j] + k$   
 $\&c[i][j] = c[i] + j$   
 $\&c[i] = c + i$

$\text{int } c[2][3][4];$

$c[i][j] = \&c[i][j][0]$   
 $c[i] = \&c[i][0][0]$   
 $c = \&c[0][0][0]$

$\&c[i][0][0] \equiv c[i][0]$

$\&c[i][0] \equiv c[i]$

$\&c[i] \equiv c + i$

virtual pointers:  
the address of a pointer is  
the same as its value

$= c + i * \text{sizeof}(*c)$   
 $= \&c[0][0][0] + i * 3 * 4$

delete [0] from the right

$\&c[0][0][0] \xrightarrow{-[0]} c[0][0] \xrightarrow{-[0]} c[0] \xrightarrow{-[0]} c$   
 $\&c[1][0][0] \xrightarrow{-[0]} c[1][0] \xrightarrow{-[0]} c[1]$

# Array Pointers to `c[i][j][0]`

`c [i][j][k];`

`&c[i][j][0] = c[i][j]`  
`&c[i][0] = c[i]`  
`&c[0] = c`

`&c[i][j][k] = c[i][j]+k`  
`&c[i][j] = c[i]+j`  
`&c[i] = c+i`

`int c [2][3][4];`

`c[i][j] = &c[i][j][0]`  
`c[i] = &c[i][0][0]`  
`c = &c[0][0][0]`

`&c[i][j][0] ≡ c[i][j]`

`&c[i][j] ≡ c[i] + j`

`= c[i] + j*sizeof(*c[i])`  
`= c + i*sizeof(*c) + j*4`  
`= &c[0][0][0] + i*3*4 + j*4`

delete [0] from the right

<code>&amp;c[0][0][0]</code>	<u><u><u>-[0]</u></u></u>	<code>c[0][0]</code>	<u><u>-[0]</u></u>	<code>c[0]</code>	<u><u>-[0]</u></u>	<code>c</code>
<code>&amp;c[0][1][0]</code>	<u><u>-[0]</u></u>	<code>c[0][1]</code>				
<code>&amp;c[0][2][0]</code>	<u><u>-[0]</u></u>	<code>c[0][2]</code>				
<code>&amp;c[1][0][0]</code>	<u><u>-[0]</u></u>	<code>c[1][0]</code>	<u><u>-[0]</u></u>	<code>c[1]</code>		
<code>&amp;c[1][1][0]</code>	<u><u>-[0]</u></u>	<code>c[1][1]</code>				
<code>&amp;c[1][2][0]</code>	<u><u>-[0]</u></u>	<code>c[1][2]</code>				



# Contiguity Constraints

c [i][j][k];

Virtual Array Pointers and Contiguity

# Using array pointers

```
int (*) [N], int (*) [M][N], int (*) [L][M][N], ...
```

# Array pointer approach for 3-d access patterns

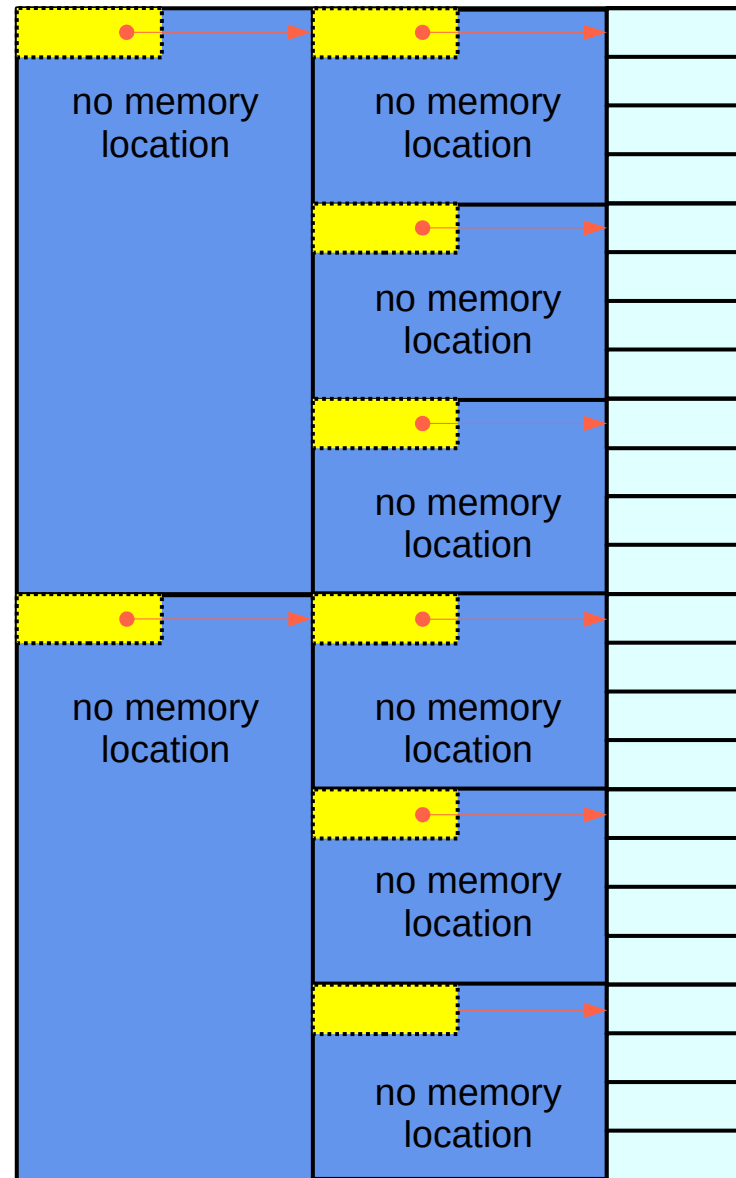

**Array Pointer Approach**  
**(pointer to arrays)**

# Array pointer approach – contiguity constraints

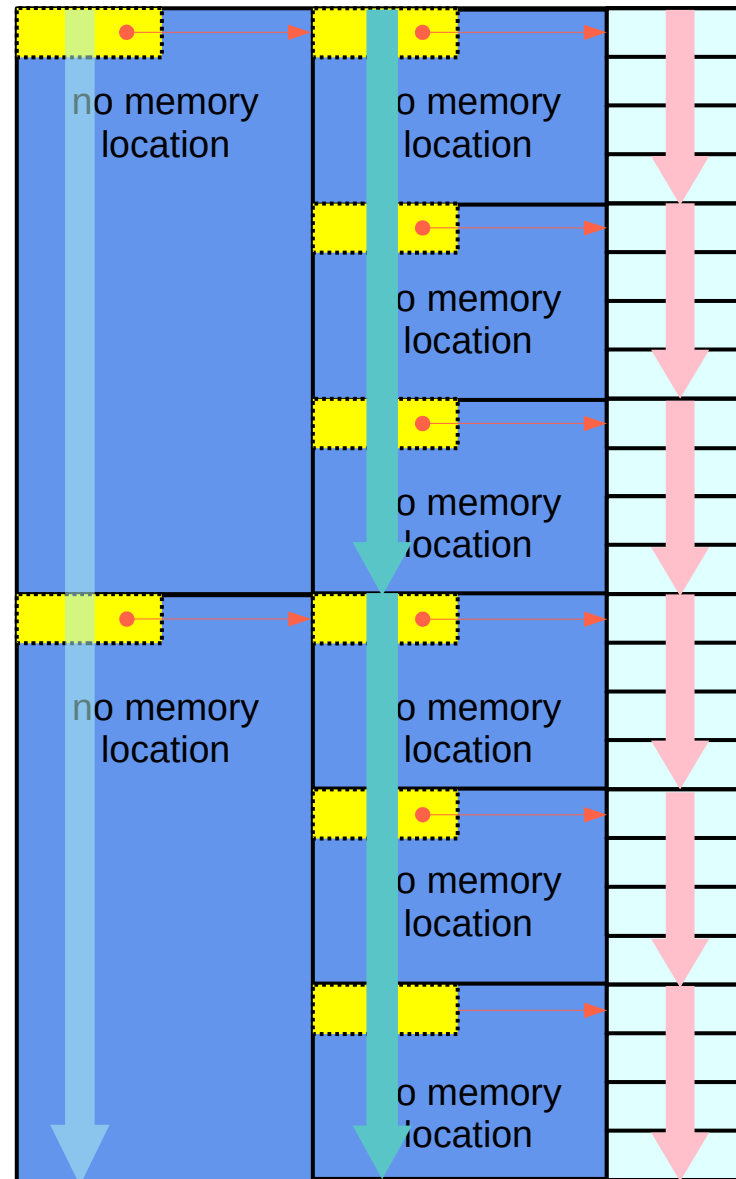

Array **Pointer** Approach  
(**pointer to arrays**)

# Three contiguity constraints

## Pointer Array Approach (array of pointers)

$c[i][j][k]$        $\rightarrow$      $*(c[i][j] + k)$   
 $*(c[i][j] + k)$      $\rightarrow$      $*(*(c[i] + j) + k)$   
 $*(*(c[i] + j) + k)$   $\rightarrow$   $*(**(*c + i) + j) + k)$

contiguous **int**      **int**  
contiguous pointers to **int**      **int \***  
contiguous double pointers to **int**      **int \*\***

the contiguity constraints are satisfied by allocating arrays of pointers

## Array Pointer Approach (pointer to arrays)

$c[i][j][k]$        $\rightarrow$      $*(c[i][j] + k)$   
 $*(c[i][j] + k)$      $\rightarrow$      $*(*(c[i] + j) + k)$   
 $*(*(c[i] + j) + k)$   $\rightarrow$   $*(**(*c + i) + j) + k)$

contiguous **1-d** array elements      **int**  
contiguous **1-d** array names      **int [4]**  
contiguous **1-d** array pointers      **int (\*) [4]**

The contiguity constraints are satisfied by row major ordered linear data layout

$$c[i][j][k] \equiv *(c[i][j] + k)$$

```

c[0][0][0] = *(c[0][0] + 0)
c[0][0][1] = *(c[0][0] + 1)
c[0][0][2] = *(c[0][0] + 2)
c[0][0][3] = *(c[0][0] + 3)
c[0][1][0] = *(c[0][1] + 0)
c[0][1][1] = *(c[0][1] + 1)
c[0][1][2] = *(c[0][1] + 2)
c[0][1][3] = *(c[0][1] + 3)

```

• •  
• •  
• •

contiguous 1-d  
array elements

**c[i][j] :: int \***  
contiguous 1-d  
array elements  
**int ... 4 elements**  
sizeof(c[i][j])  
sizeof(int) \* 4

Address Value

c[i][j] + k

&c[i][j][0] + k \* sizeof(\*c[i][j])

&c[i][j][0] + k \* sizeof(c[i][j][0])

&c[i][j][0] + k \* 4

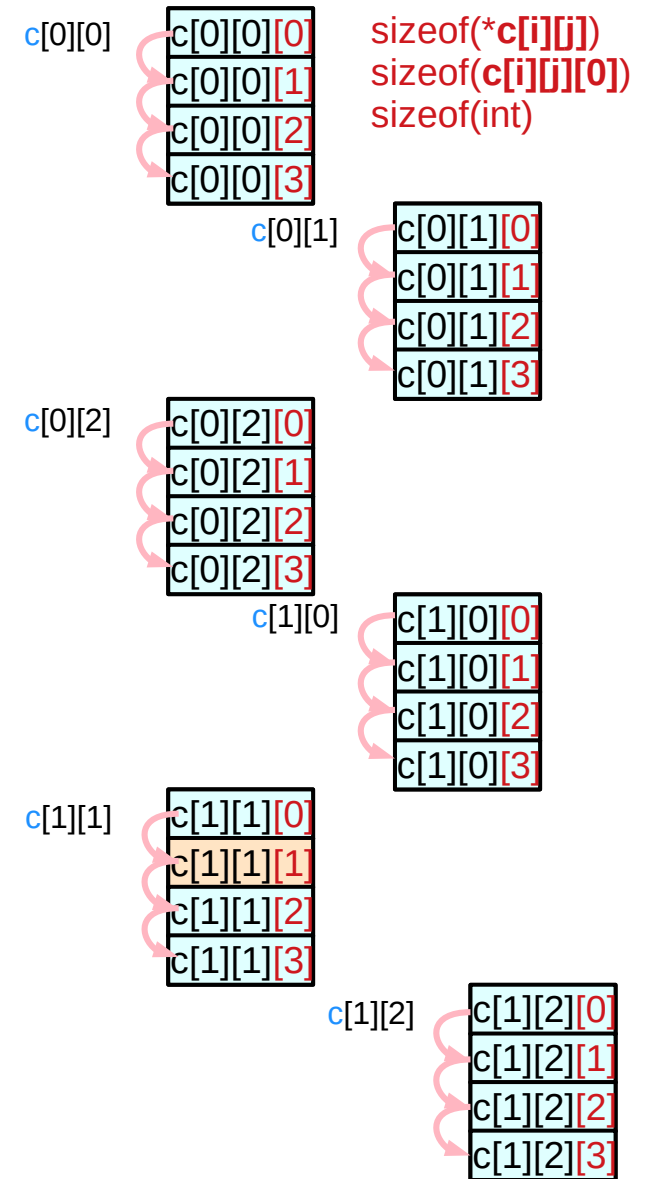

$$c[i][j] \equiv *(c[i] + j)$$

```

c[0][0] = *(c[0] + 0)
c[0][1] = *(c[0] + 1)
c[0][2] = *(c[0] + 2)
c[1][0] = *(c[1] + 0)
c[1][1] = *(c[1] + 1)
c[1][2] = *(c[1] + 2)

```

**c[i]** :: int (\*) [4]  
 contiguous 1-d arrays  
**int[4]** = int \* ... 3 arrays  
 sizeof(**c[i]**)  
 sizeof(**c[i][j]**) \* 3  
 sizeof(**c[i][j][k]**) \* 3 \* 4  
 sizeof(int) \* 3 \* 4

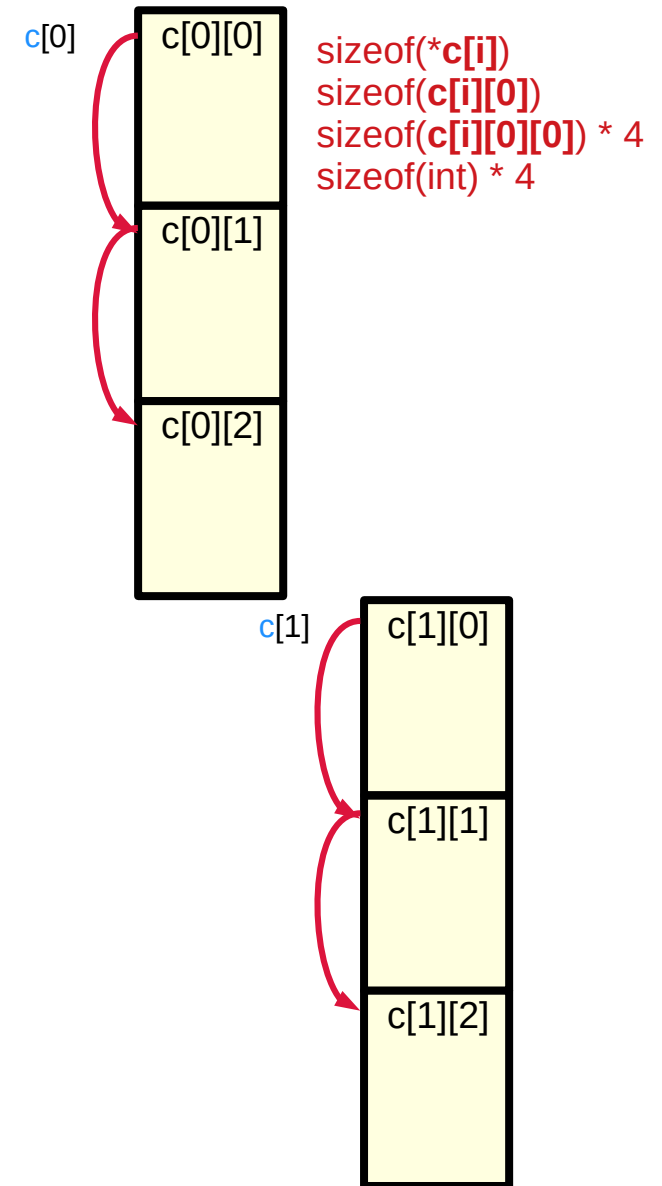

Address Value

$c[i] + j$

$\&c[i][0][0] + j * \text{sizeof}(*c[i])$

$\&c[i][0][0] + j * \text{sizeof}(c[i][0])$

$\&c[i][0][0] + j * 4 * 4$

$$c[i] \equiv *(c + i)$$

```
c[0] = *(c + 0)
c[1] = *(c + 1)
```

`c :: int (*) [3][4]`  
 contiguous  
 1-d array pointers  
`int (*) [4]` ... 2 array pointers  
`sizeof(c)`  
`sizeof(c[i]) * 2`  
`sizeof(c[i][j]) * 2 * 3`  
`sizeof(c[i][j][k]) * 2 * 3 * 4`  
`sizeof(int) * 2 * 3 * 4`

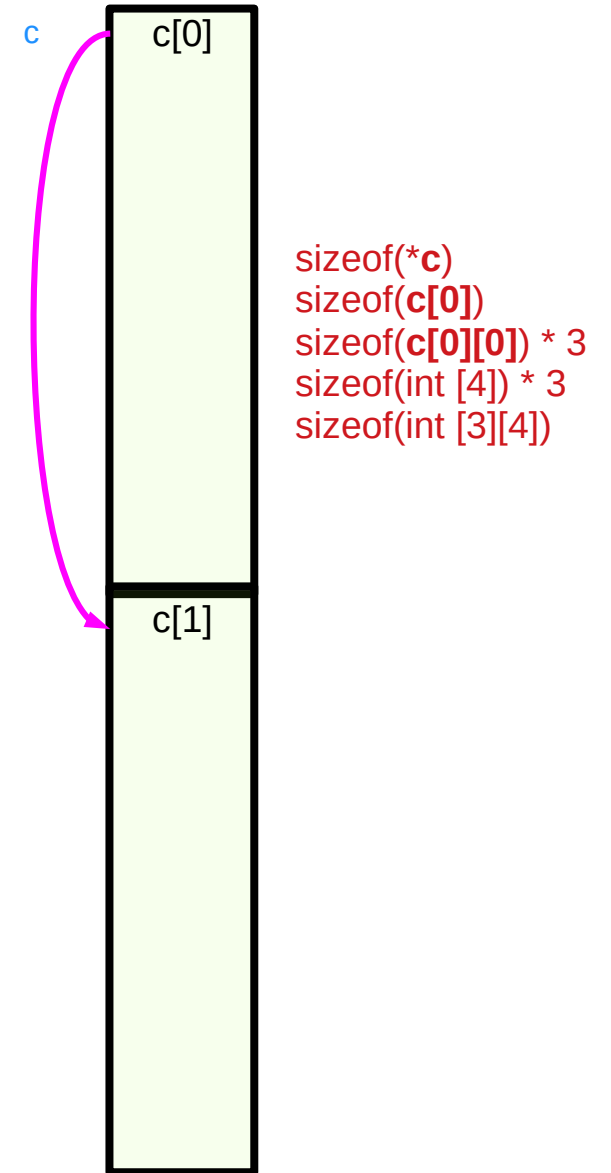

Address Value  
`c + i`  
`&c[0][0][0] + i * sizeof(*c)`  
`&c[0][0][0] + i * sizeof(c[0])`  
`&c[0][0][0] + i * 4 * 4 * 3`



$$c[i] \equiv *(c + i)$$

2-d array pointer  $c$   
 $\text{int } (*) [3][4]$

1-d array pointers  $c[i]$   
 $\text{int } (*) [4]$

0-d array pointers  $c[i][j]$   
 $\text{int } (*)$

$$c[i] \equiv *(c + i)$$

$$c[i][j] \equiv *(c[i] + j)$$

$$c[i][j][k] \equiv *(c[i][j] + k)$$

address value  $c + i$

$\&c[0][0][0] + i * \text{sizeof}(*c)$   
 $\&c[0][0][0] + i * \text{sizeof}(c[0])$   
 $\&c[0][0][0] + i * 4 * 4 * 3$

address value  $c[i] + j$

$\&c[i][0][0] + j * \text{sizeof}(*c[i])$   
 $\&c[i][0][0] + j * \text{sizeof}(c[i][0])$   
 $\&c[i][0][0] + j * 4 * 4$

address value  $c[i][j] + k$

$\&c[i][j][0] + k * \text{sizeof}(*c[i][j])$   
 $\&c[i][j][0] + k * \text{sizeof}(c[i][j][0])$   
 $\&c[i][j][0] + k * 4$

leading elements

$c[0][0][0]$

leading elements

$c[0][0][0]$

$c[1][0][0]$

leading elements

$c[0][0][0]$   
 $c[0][1][0]$   
 $c[0][2][0]$   
 $c[1][0][0]$   
 $c[1][1][0]$   
 $c[1][2][0]$

# Equivalence and contiguity

$$*(X+n) \equiv X[n]$$

contiguous index : n

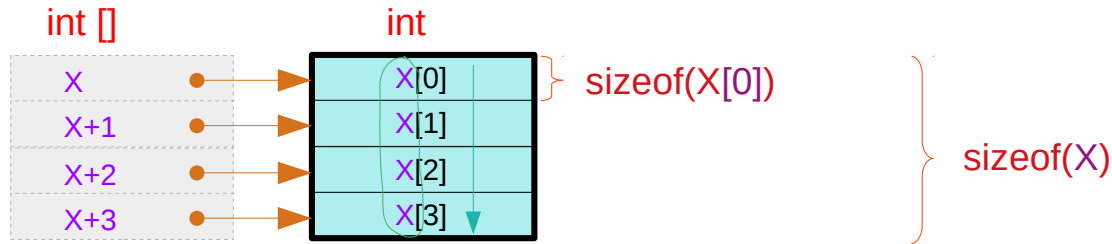

contiguous X[n] for a given X : **int X[4];**

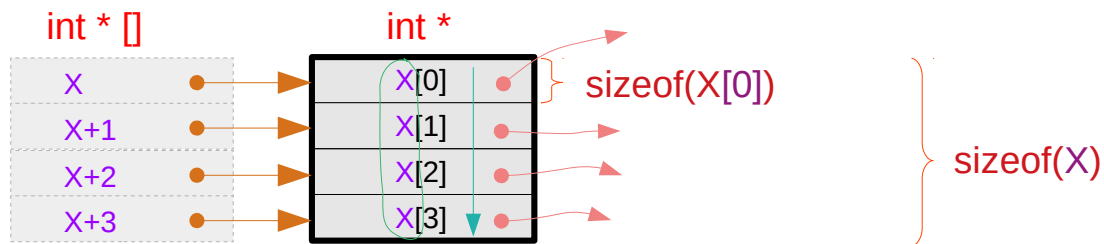

contiguous X[n] for a given X : **int \* X[4];**

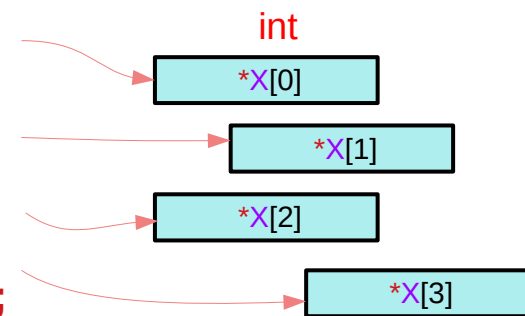

# Equivalence and contiguity

$$*(X+n) \equiv X[n]$$

contiguous index : n

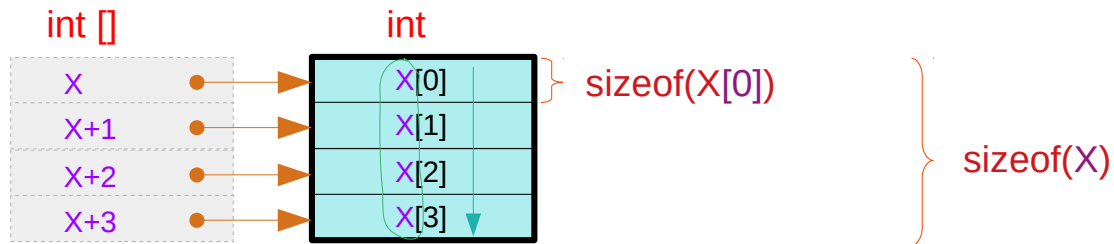

contiguous  $X[n]$  for a given  $X$  : **int X[4];**

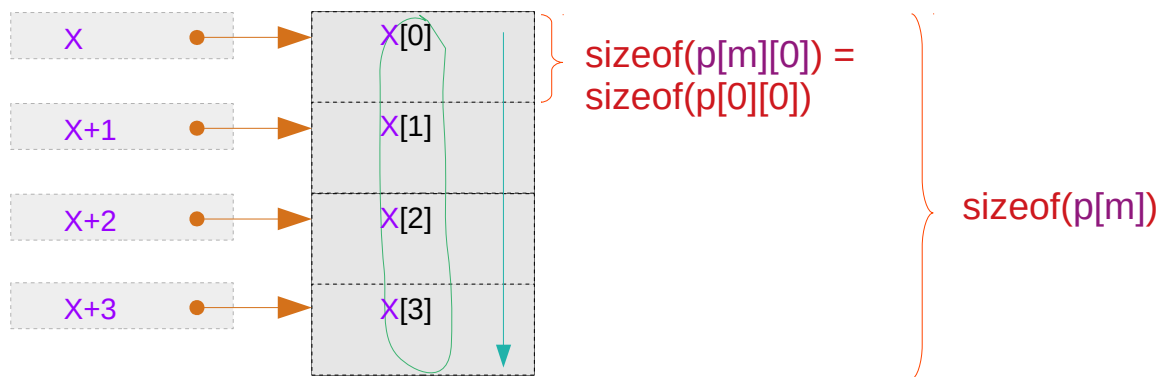

# Equivalence

By definition, contiguous memory locations are assumed

$$*(\mathbf{X} + \mathbf{n}) \equiv \mathbf{X}[\mathbf{n}]$$

contiguous index :  $n$

$$*(\mathbf{p}[\mathbf{m}] + \mathbf{n}) \iff \mathbf{p}[\mathbf{m}][\mathbf{n}]$$

$$\mathbf{X} = \mathbf{p}[\mathbf{m}] \quad \text{contiguous index : } \mathbf{n}$$

$$*(\mathbf{p} + \mathbf{m})[\mathbf{n}]; \iff \mathbf{p}[\mathbf{m}][\mathbf{n}];$$

$$\mathbf{X} = \mathbf{p} \quad \text{contiguous index : } \mathbf{m}$$

# For a given $p[m]$ – int pointer / pointer to int pointer

$$*(p[m]+n) \iff p[m][n]$$

for a given  $p[m]$  contiguous index :  $n$

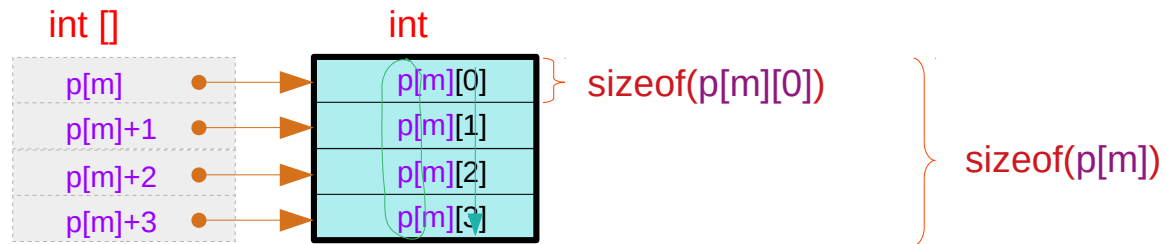

contiguous  $p[m][n]$  for a given  $p[m]$  : `int p[m][4];`

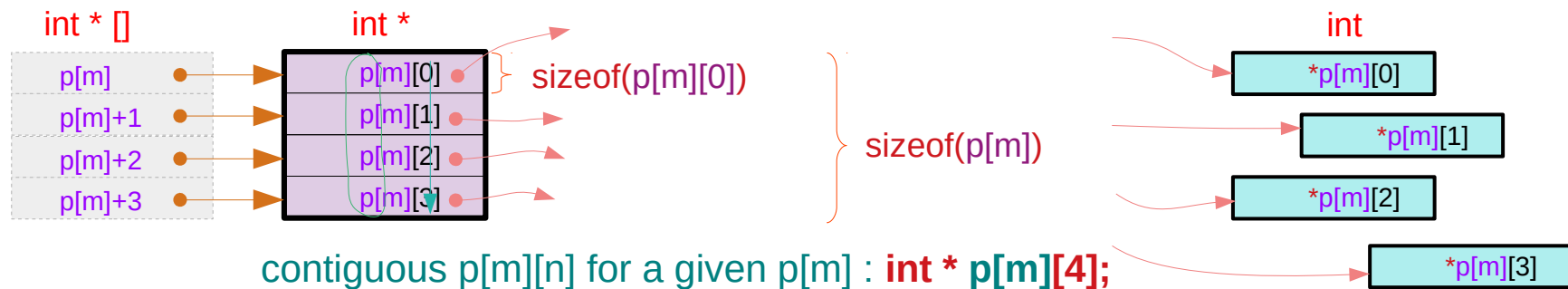

contiguous  $p[m][n]$  for a given  $p[m]$  : `int * p[m][4];`

# For a given $p[m]$ – pointer to an abstract data

$$*(p[m]+n) \longleftrightarrow p[m][n]$$

for a given  $p[m]$  contiguous index :  $n$

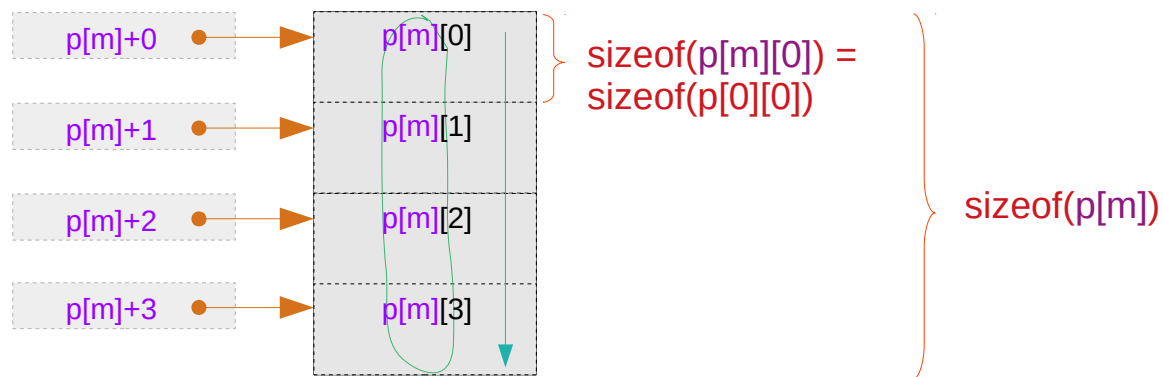
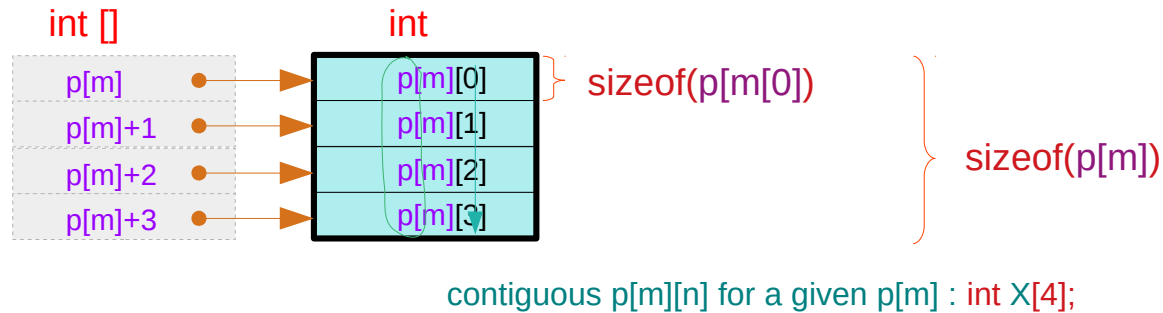

# Contiguity constraints

$$(*(\mathbf{p}+\mathbf{m}))[\mathbf{n}]; \iff \mathbf{p}[\mathbf{m}][\mathbf{n}];$$

for a given  $\mathbf{p}$       contiguous index :  $\mathbf{m}$

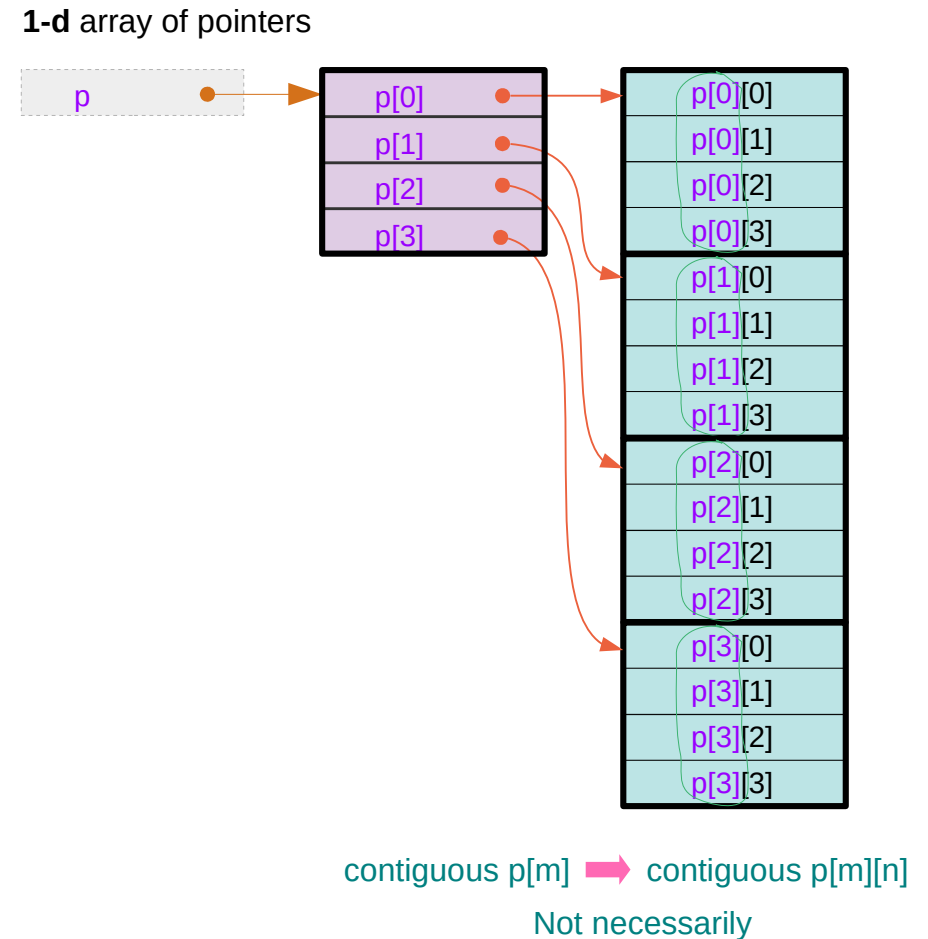
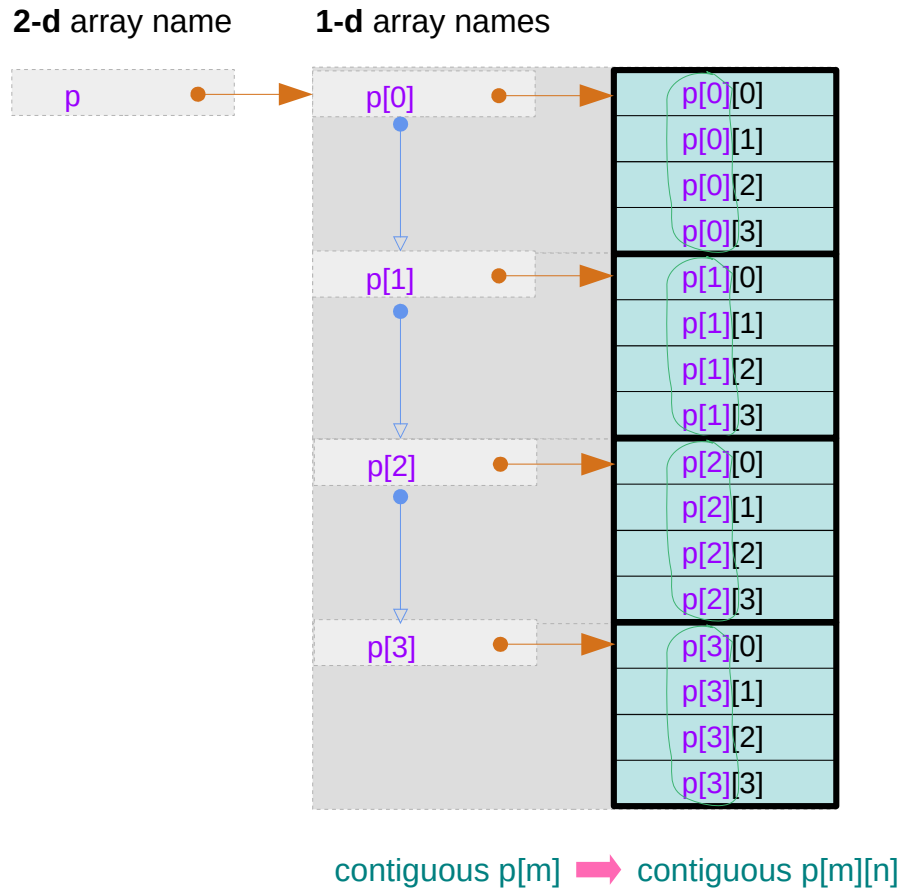

# Contiguity constraints – using array pointers

$$(*(\mathbf{p}+\mathbf{m}))[\mathbf{n}]; \iff \mathbf{p}[\mathbf{m}][\mathbf{n}];$$

for a given  $\mathbf{p}$       contiguous index :  $\mathbf{m}$

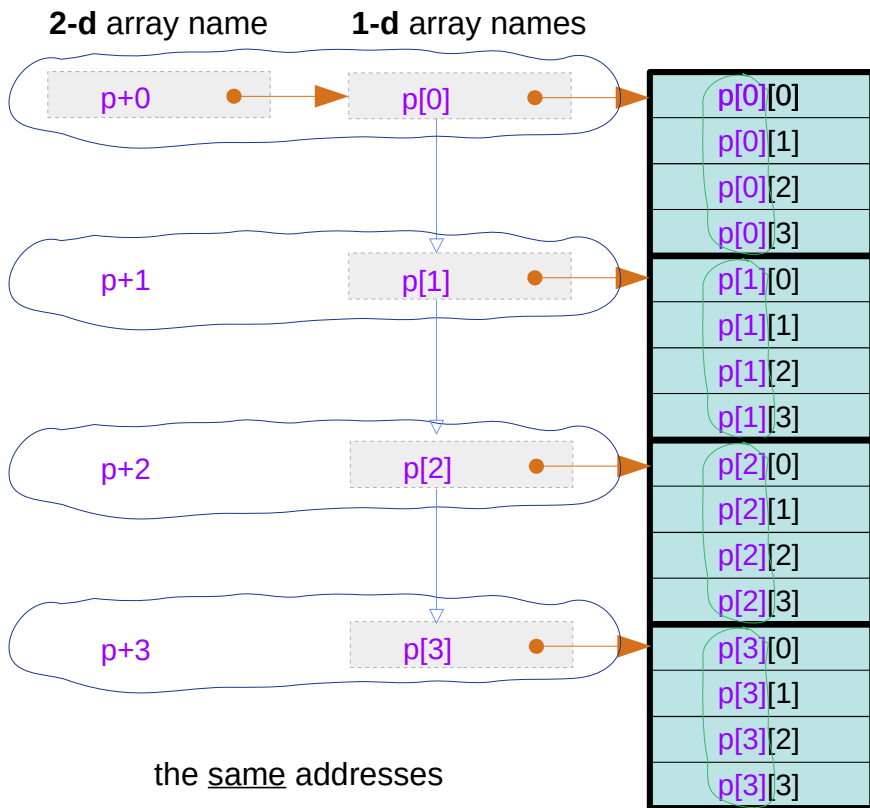

contiguous  $p[m]$   $\rightarrow$  contiguous  $p[m][n]$

## virtual array pointer

$$\begin{array}{l} \text{data} \\ p[0][0] = *(p[0]+0) \end{array} \xrightarrow{\text{addr}} (p[0]+0) = p[0] \xrightarrow{\text{addr}} p+0$$

$$\begin{array}{l} \text{data} \\ p[1][0] = *(p[1]+0) \end{array} \xrightarrow{\text{addr}} (p[1]+0) = p[1] \xrightarrow{\text{addr}} p+1$$

$$\begin{array}{l} \text{data} \\ p[2][0] = *(p[2]+0) \end{array} \xrightarrow{\text{addr}} (p[2]+0) = p[2] \xrightarrow{\text{addr}} p+2$$

$$\begin{array}{l} \text{data} \\ p[3][0] = *(p[3]+0) \end{array} \xrightarrow{\text{addr}} (p[3]+0) = p[3] \xrightarrow{\text{addr}} p+3$$

the same addresses

$\iff$  no real memory locations



# Contiguity constraints – using pointer arrays

$$(*(\mathbf{p}+\mathbf{m}))[\mathbf{n}]; \iff \mathbf{p}[\mathbf{m}][\mathbf{n}];$$

for a given  $\mathbf{p}$       contiguous index :  $\mathbf{m}$

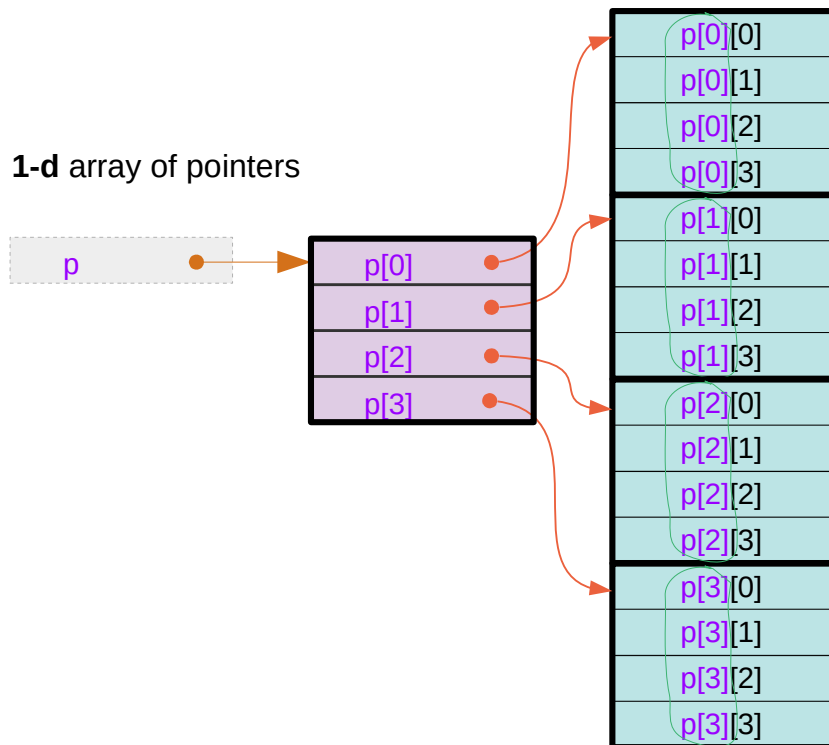

contiguous  $p[m]$   $\rightarrow$  contiguous  $p[m][n]$   
Not necessarily

the different addresses

data  $p[0][0] = *(p[0]+0)$       addr  $\rightarrow$   $(p[0]+0) = p[0]$       addr  $\rightarrow$   $p+0$

data  $p[1][0] = *(p[1]+0)$       addr  $\rightarrow$   $(p[1]+0) = p[1]$       addr  $\rightarrow$   $p+1$

data  $p[2][0] = *(p[2]+0)$       addr  $\rightarrow$   $(p[2]+0) = p[2]$       addr  $\rightarrow$   $p+2$

data  $p[3][0] = *(p[3]+0)$       addr  $\rightarrow$   $(p[3]+0) = p[3]$       addr  $\rightarrow$   $p+3$

# Contiguity constraints

$$*(p[m]+n) \iff p[m][n]$$

for a given  $p[m]$ , thus for a given  $m$ ,  
 $p[m][n]$  must be contiguous for all  $n$ .  
 $p[m][0], p[m][1], \dots, p[m][N-1]$

contiguous index :  $n$

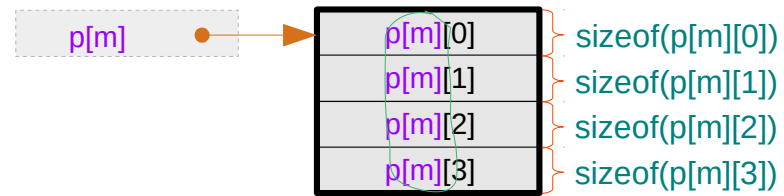

$$(*(p+m))[n]; \iff p[m][n];$$

for a given  $p$ ,  
 $p[m]$ 's must be contiguous for all  $m$ .  
 $p[0], p[1], \dots, p[M-1]$

contiguous index :  $m$

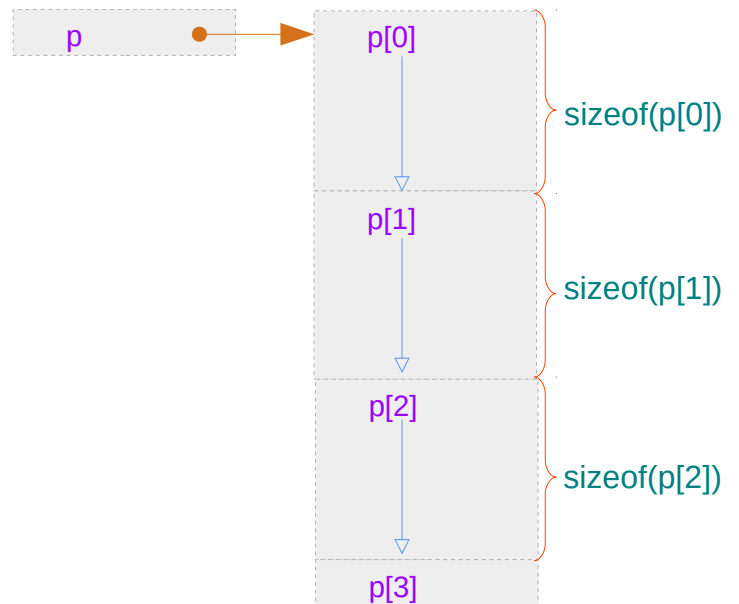

all  $p[m][n]$ 's must be contiguous for all  $m, n$

# Contiguity constraints

```
int a[M][N] ;
```

$(*(a+m))[n]$   $\longleftrightarrow$   $a[m][n]$   
 $*(a[m]+n)$   $\longleftrightarrow$   $a[m][n]$

```
int (*b)[N] ;
```

$(*(b+m))[n]$   $\longleftrightarrow$   $b[m][n]$   
 $*(b[m]+n)$   $\longleftrightarrow$   $b[m][n]$

```
int * c[M] ;
```

$(*(c+m))$   $\longleftrightarrow$   $c[m]$   
needs assignments

# Contiguity constraints

```
int a[M][N] ;
```

$(*(a+m))[n] \longleftrightarrow a[m][n]$

$a[0], a[1], \dots, a[M-1]$   
are contiguous

$*(a[m]+n) \longleftrightarrow a[m][n]$

$a[m][0], a[m][1], \dots, a[m][N-1]$   
are contiguous

```
int (*b)[N] ;
```

$(*(b+m))[n] \longleftrightarrow b[m][n]$

$b[0], b[1], \dots, b[M-1]$   
are contiguous

$*(b[m]+n) \longleftrightarrow b[m][n]$

$b[m][0], b[m][1], \dots, b[m][N-1]$   
are contiguous

# Contiguity constraints

```
int a[M][N] ;
```

$(*(a+m))[n] \longleftrightarrow a[m][n]$

$a[0], a[1], \dots, a[M-1]$   
are contiguous

$*(a[m]+n) \longleftrightarrow a[m][n]$

$a[m][0], a[m][1], \dots, a[m][N-1]$   
are contiguous

```
int * c[M] ;
```

$(*(c+m)) \longleftrightarrow c[m]$

$c[0], c[1], \dots, c[M-1]$   
are contiguous

$(*(c+m))[n] \longleftrightarrow c[m][n]$

$c[m][0], c[m][1], \dots, c[m][N-1]$   
are contiguous

a set of assignments of pointers  
are necessary for this contiguity

# Pointer Arrays vs Array Pointers

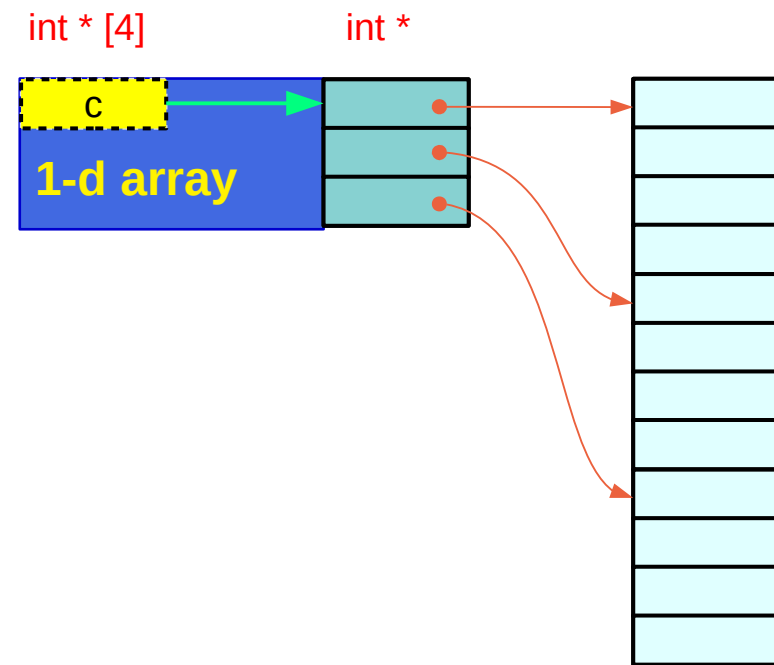
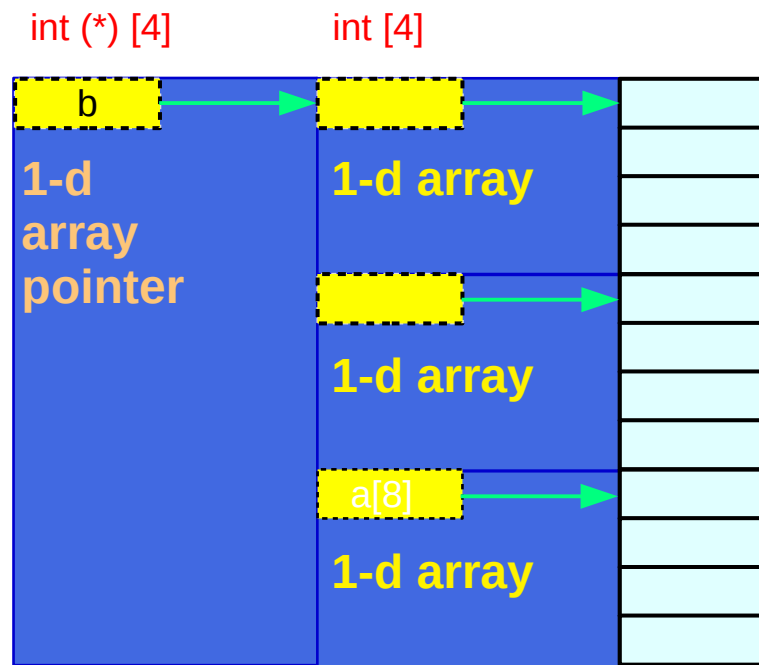

`int (*b)[N] ;`

`int * c[M] ;`

$(*(b+m))[n] \iff b[m][n]$   
 $*(b[m]+n) \iff b[m][n]$

$*(c+m) \iff c[m] \text{ or}$   
 $*(c+m)[n] \iff c[m][n]$

# Contiguous linear layout

```
int c [L][M][N];
```

L	M	N
<i>i</i>	<i>j</i>	<i>k</i>
$i * M * N$	$j * N$	<i>k</i>

Base Index = 0

Offset Index 1 (*i*=1)

Offset Index 2 (*j*=1)

Offset Index 3 (*k*=1)

$$(i * M * N + j * N + k)$$

$$((i * M + j) * N + k)$$

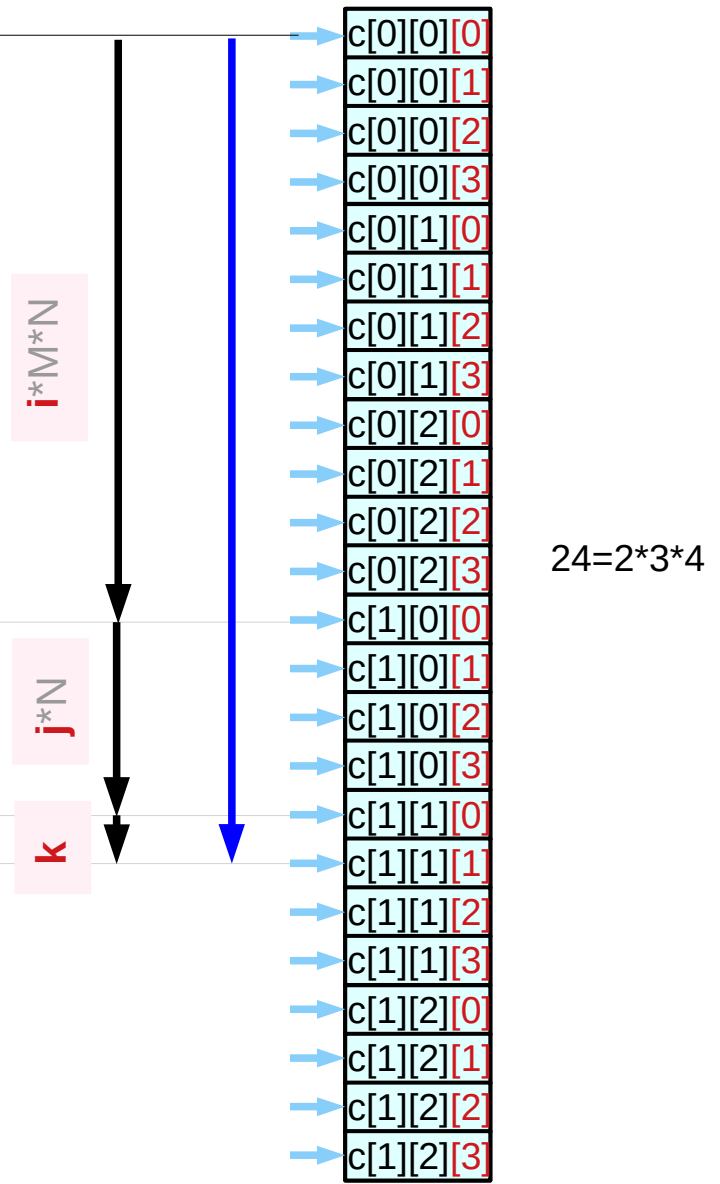

# Base and Offset Addressing

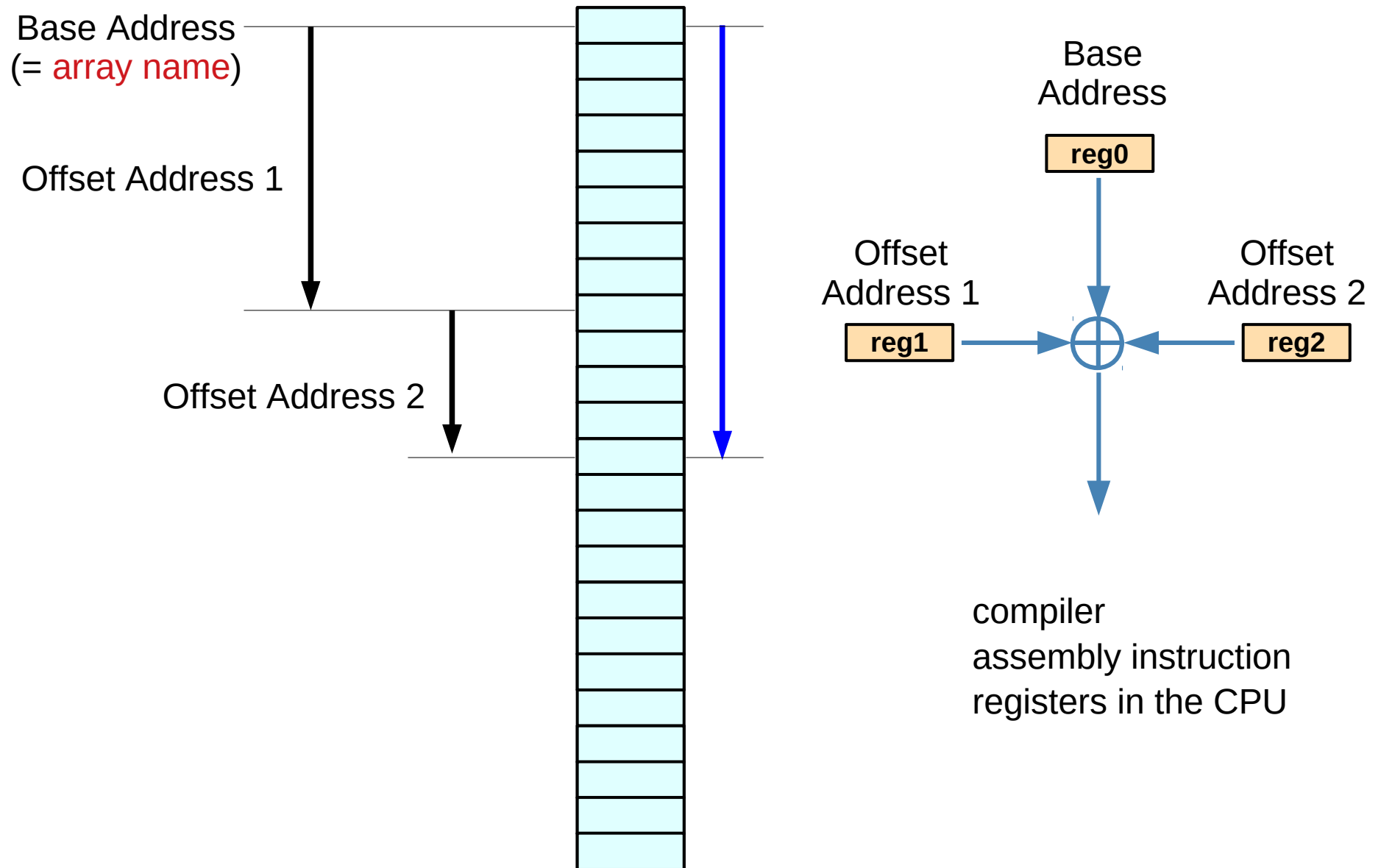



# Array Pointer Approach

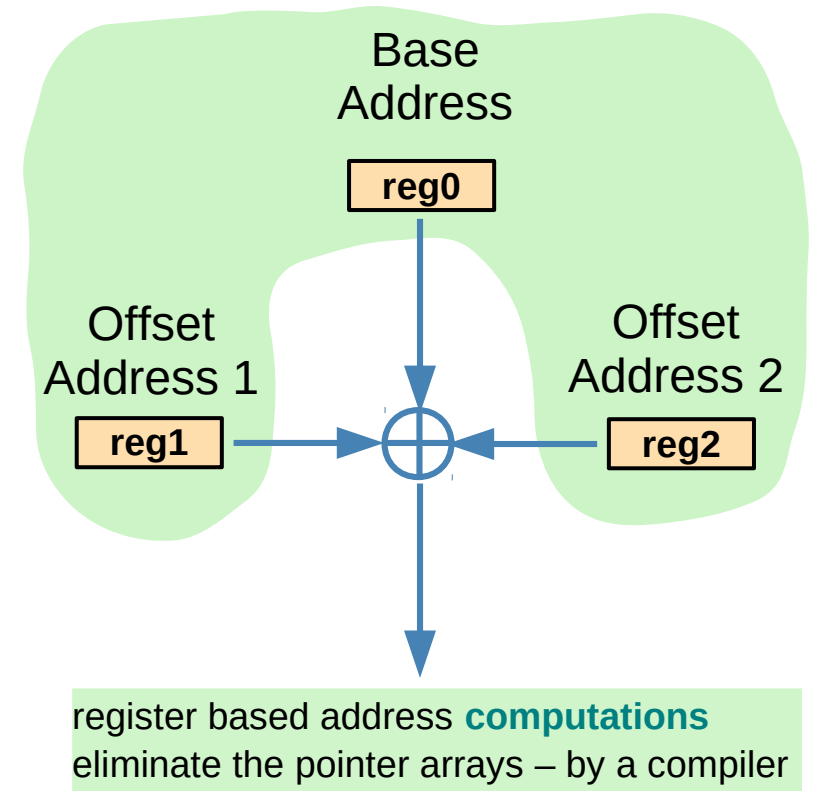
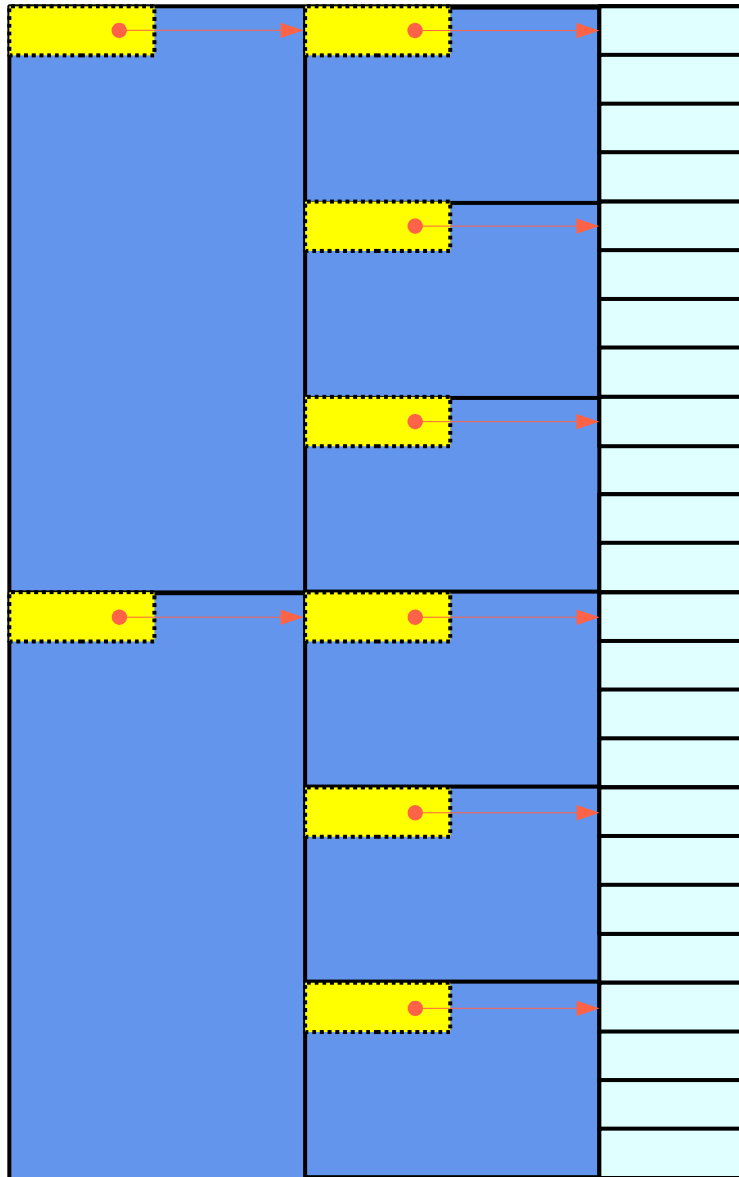

**Array Pointer Approach**  
**(pointer to arrays)**

## References

- [1] Essential C, Nick Parlante
- [2] Efficient C Programming, Mark A. Weiss
- [3] C A Reference Manual, Samuel P. Harbison & Guy L. Steele Jr.
- [4] C Language Express, I. K. Chun