

Applications of Pointers (1A)

Copyright (c) 2024 - 2010 Young W. Lim.

Permission is granted to copy, distribute and/or modify this document under the terms of the GNU Free Documentation License, Version 1.2 or any later version published by the Free Software Foundation; with no Invariant Sections, no Front-Cover Texts, and no Back-Cover Texts. A copy of the license is included in the section entitled "GNU Free Documentation License".

Please send corrections (or suggestions) to youngwlim@hotmail.com.
This document was produced by using LibreOffice.

n-d access of a 1-d array

- **2-d** array access of a **1-d** array
- **3-d** array access of a **1-d** array
- Accessing a **contiguous 1-d** array
- Accessing a **non-contiguous 1-d** arrays

- Accessing **static** allocated arrays
- Accessing **dynamically** allocated arrays

2-d array access of a 1-d array

Array of Pointers

```
int    a [4] ;  
int *  b [3] ;
```

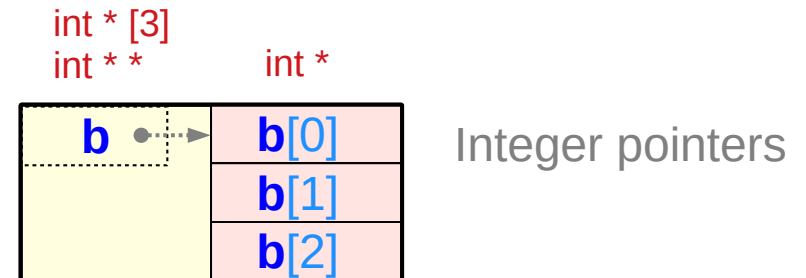
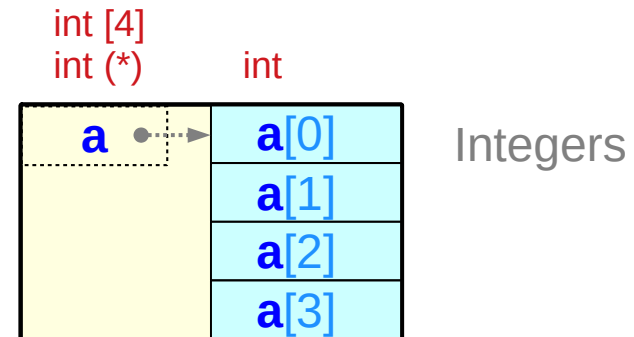
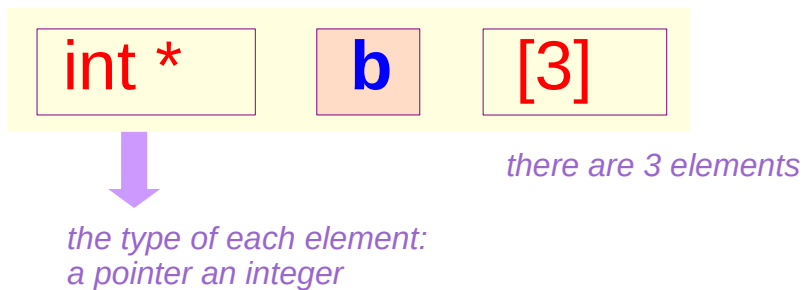
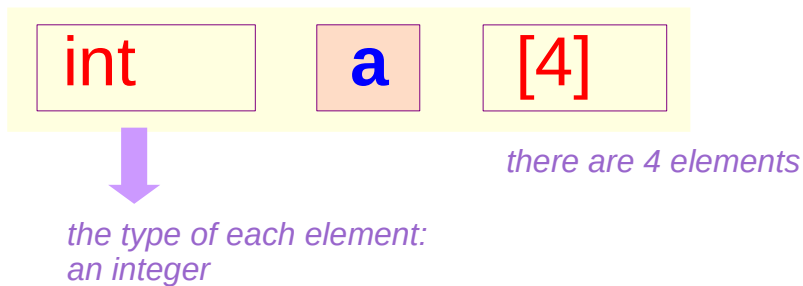

Array of Pointers – a type view

`int *` `b [3] ;` Pointer Array

`int` `a [4] ;`

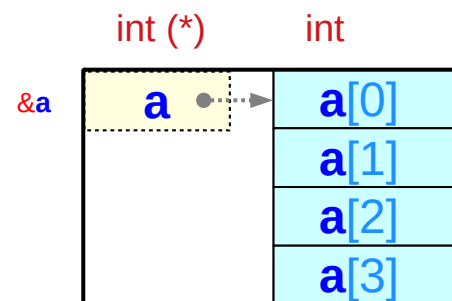
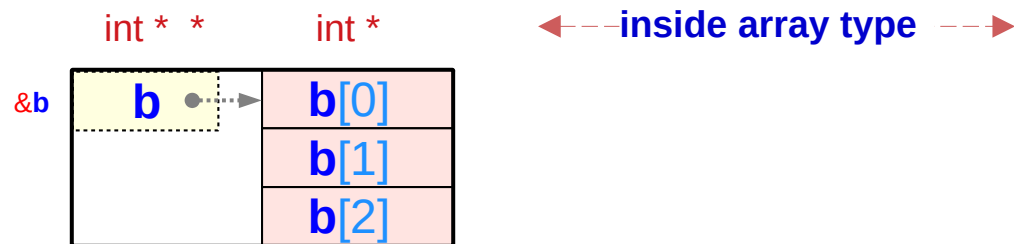
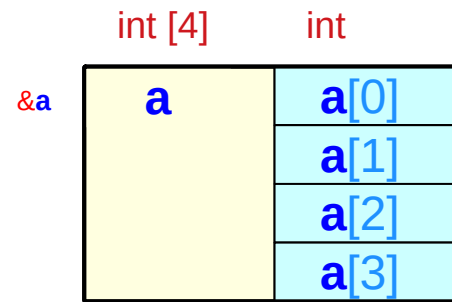
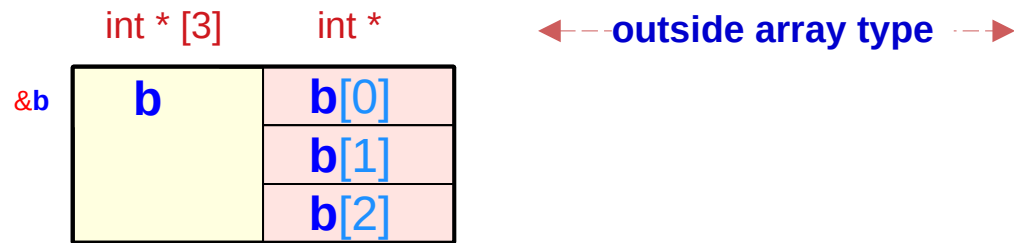

Array of Pointers – a variable view

```
int * b [3] ;
```

Pointer Array

```
int a [4] ;
```

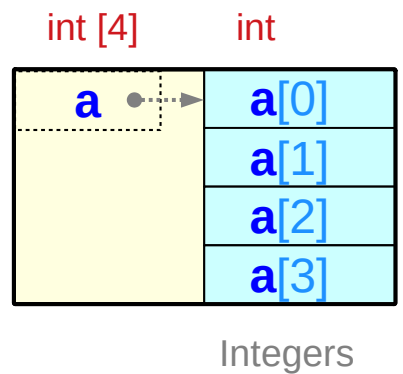
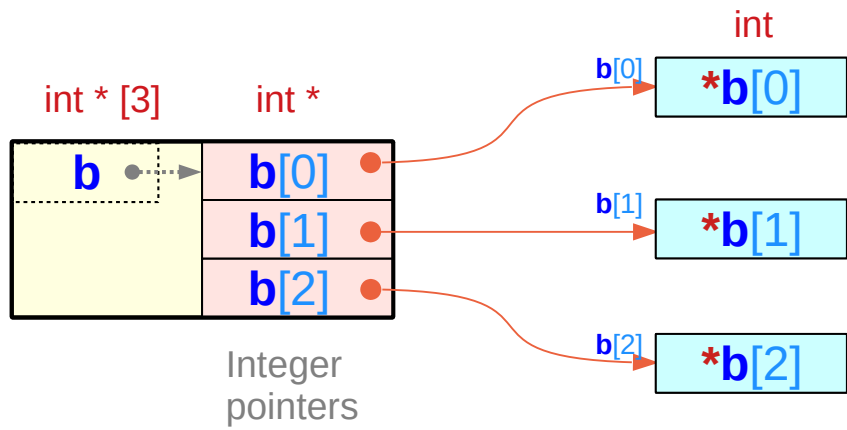

Assigning a 1-d array name

`int *`

`b [3] ;`

Pointer Array

`int`

`a [4] ;`

assignment

`b[0] = a (= &a[0])`

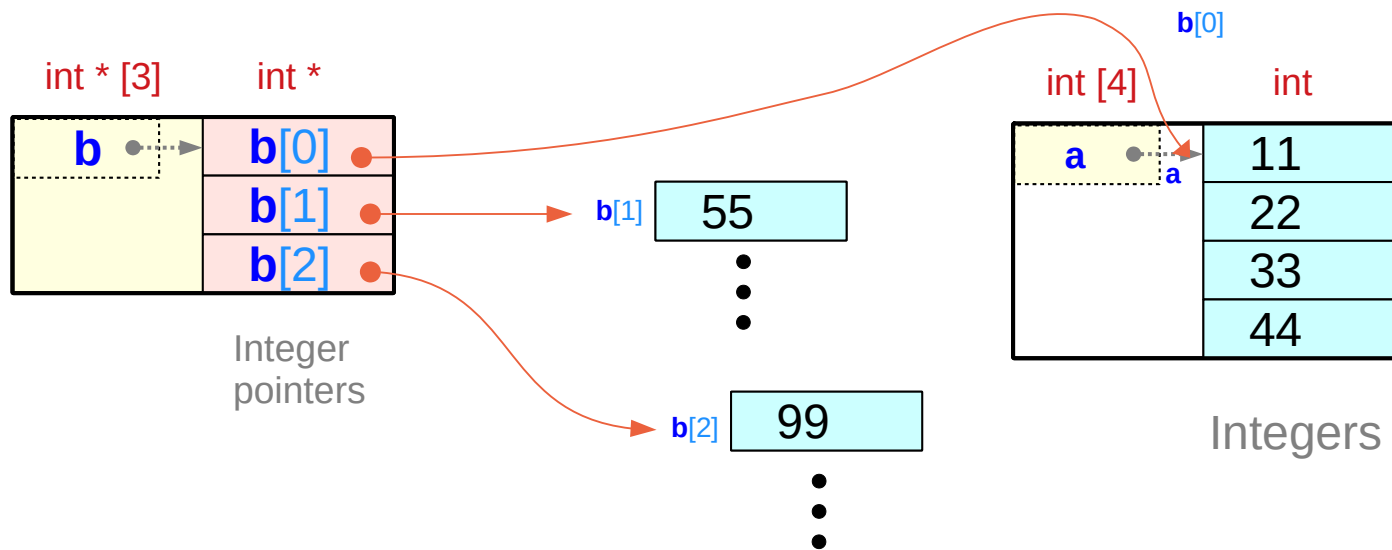

Assigning a 1-d array name – equivalence

`int *` `b [3] ;` Pointer Array

`int` `a [4] ;`

assignment

`b[0] = a (= &a[0])`

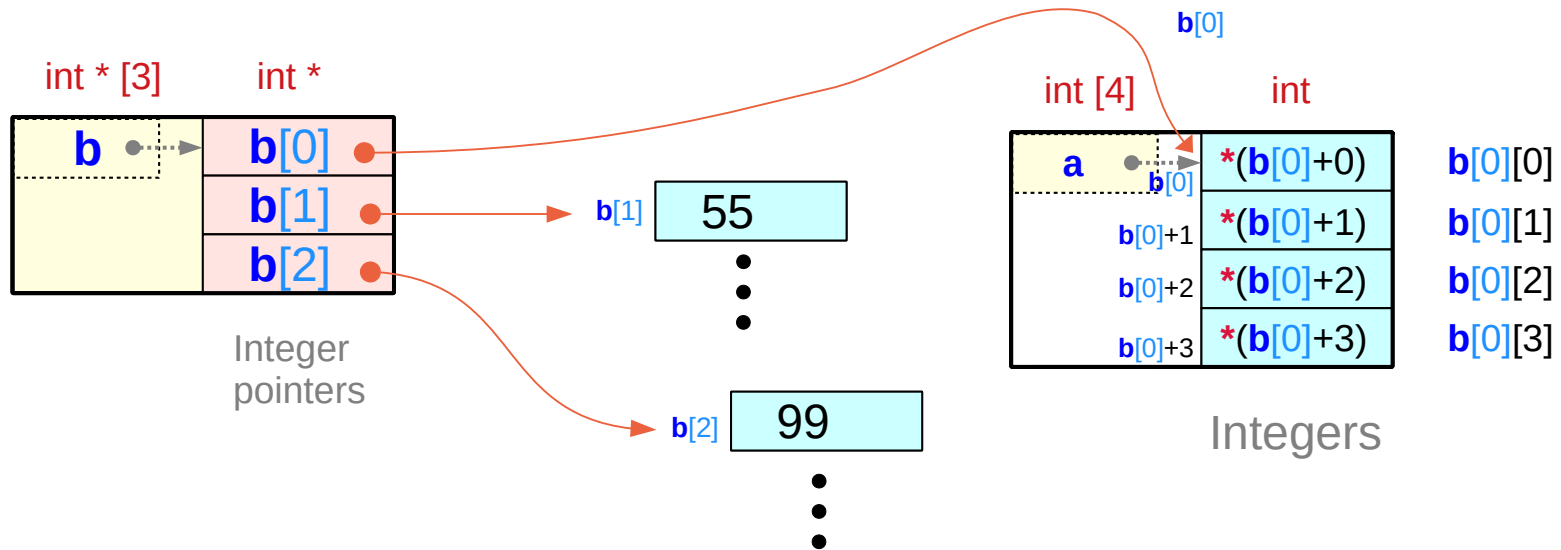

Array of Pointers – extended dimension

`int *`

`b [3] ;`

Pointer Array

`int`

`a [4] ;`

array name `b`

assignment

`b[0] = a (= &a[0])`

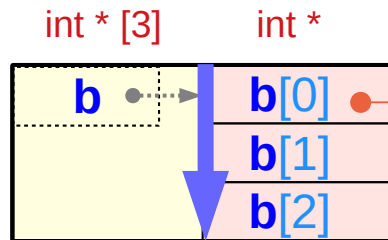

1st dim

array name `b[0]`

`int [4]`

`int`

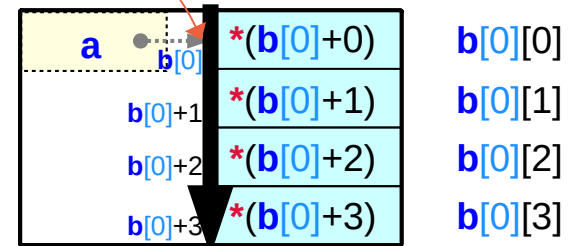

2nd dim

```
a[0] ≡ b[0][0] ≡ (*(b+0)+0)
a[1] ≡ b[0][1] ≡ (*(b+0)+1)
a[2] ≡ b[0][2] ≡ (*(b+0)+2)
a[3] ≡ b[0][3] ≡ (*(b+0)+3)
```

2-d access of 1-d arrays

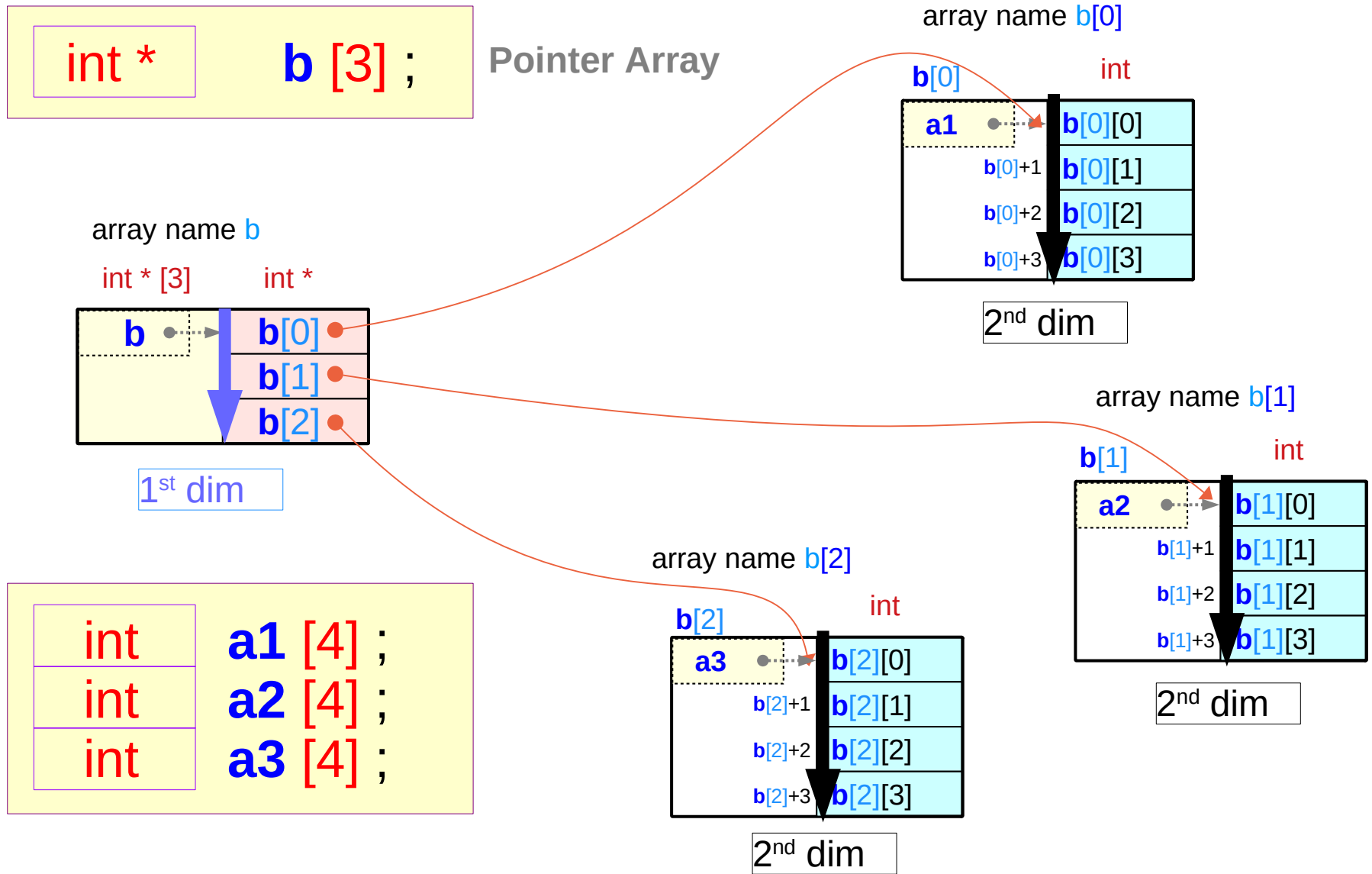

2-d access of a 1-d array

int *

b [3] ;

Pointer Array

int *

a [3*4] ;

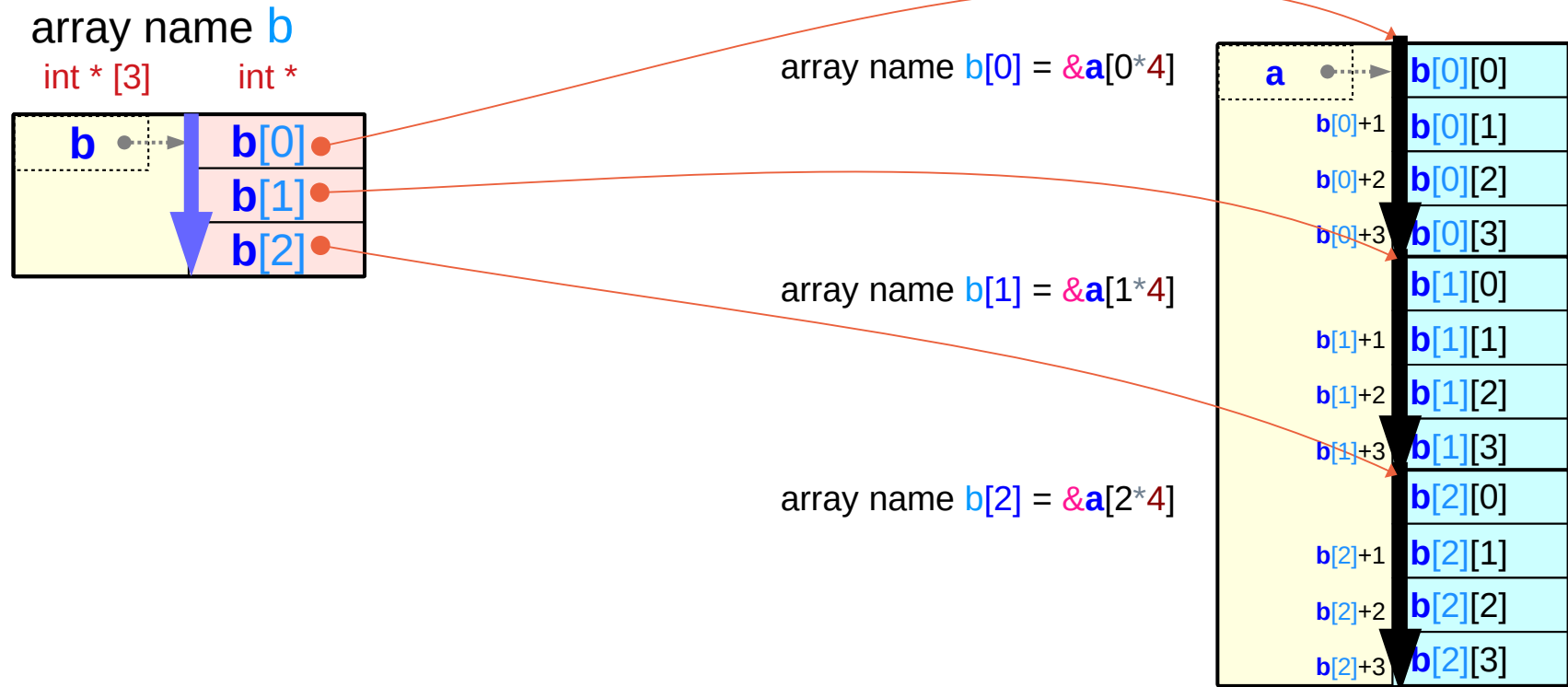

2-d access of a 1-d array – pointer array assignment

```
int * b [2*3] ;  
int a [2*3*4] ;
```

```
b[j] = &a[j*4] (= a+j*4)
```

```
b[j] + k = a+j*4 + k  
*(b[j] + k) = *(a+j*4 + k)
```

```
b[j][k] ≡ a[j*4 + k]
```

```
j = [0:5]      k = [0:3]
```

```
j*4+k = [0:23]
```

constraint : contiguous b[i][j] over j

2-d access of a 1-d array

```
b[i][j] ≡ *(b[i] + j)
```



```
a[i*4+j] ≡ *(a+i*4 + j)
```



1-d access of a 1-d array

constraint : contiguous a[i*4+j] over j

3-d array access of a 1-d array

3-d access of a 1-d array (1)

```
int **   c [2] ;  
int *    b [2*3] ;  
int      a [2*3*4] ;
```

```
int *    b [2*3] ;  
int      a [2*3*4] ;
```

```
b[j] = &a[j*4] (= a+j*4)
```

```
b[j] + k = a+j*4 + k  
*(b[j] + k) = *(a+j*4 + k)
```

```
b[j][k] ≡ a[j*4 + k]  
j = [0:5]      k = [0:3]  
j*4+k = [0:23]
```

```
int **   c [2] ;  
int *    b [2*3] ;
```

```
c[i] = &b[i*3] (= b+i*3)
```

```
c[i] + j = b+i*3 + j  
*(c[i] + j) = *(b+i*3 + j)
```

```
c[i][j] = b[i*3 + j]
```

```
c[i][j] + k = b[i*3 + j] + k  
*(c[i][j] + k) = b[i*3 + j][k]
```

```
c[i][j][k] = a[(i*3 + j)*4 + k]
```

```
c[i][j][k] ≡ a[(i*3+j)*4+k]  
i = [0:1]      j = [0:2]      k = [0:3]  
(i*3+j)*4+k = [0:23]
```

3-d access of a 1-d array (2)

int **	c [2] ;
int *	b [2*3] ;
int	a [2*3*4] ;

$$\begin{aligned} \mathbf{a[k]} &\equiv *(\mathbf{a+k}) \\ \mathbf{b[j][k]} &\equiv *(*(\mathbf{b+j})+k) \\ \mathbf{c[i][j][k]} &\equiv *(*(*(\mathbf{c+i})+j)+k) \end{aligned}$$

constraint : contiguous a[i], b[i], c[i]

Assignments

$$\begin{aligned} \mathbf{c[i]} &= \&\mathbf{b[i*3]} \quad (= \mathbf{b+i*3}) \\ \mathbf{b[j]} &= \&\mathbf{a[j*4]} \quad (= \mathbf{a+j*4}) \end{aligned}$$

Initializing pointer arrays **b** and **c**



3-d access of a 1-d array

$$\begin{aligned} \mathbf{c[i][j][k]} &\equiv *(\mathbf{c[i][j]} + k) \\ \mathbf{b[i*3+j][k]} &\equiv *(\mathbf{b[i*3+j]} + k) \\ \mathbf{a[(i*3+j)*4 + k]} &\equiv *(\mathbf{a+(i*3+j)*4 + k}) \end{aligned}$$

1-d access of a 1-d array

3-d access of a 1-d array (3)

int **	c [2] ;
int *	b [2*3] ;
int	a [2*3*4] ;

a [k]	≡ * (a +k)
b [j][k]	≡ * (* (b +j)+k)
c [i][j][k]	≡ * (* (* (c +i)+j)+k)

((c[i])[j])[k]	
≡ ((b+i*3)[j])[k]	←
≡ (b[i*3+j])[k]	
≡ (a+(i*3+j)*4)[k]	←
≡ a[(i*3+j)*4+k]	

c[i] = **&b**[i*3] = **b**+i*3

b[j] = **&a**[j*4] = **a**+j*4

* (* (* (c +i)+j)+k)	
≡ * (* (b +i*3+j)+k)	▶
≡ * (b [i*3+j]+k)	
≡ * (a +(i*3+j)*4+k)	▶
≡ a [(i*3+j)*4+k]	

Equivalence relations in pointer array assignments

$$\begin{aligned}c[i] &= \&b[i*3] = b+i*3 \\ b[j] &= \&a[j*4] = a+j*4\end{aligned}$$

substitute $c[i]$ in $*(c[i]+j)$

substitute $b[m]$ in $*(b[m]+k)$

$$m = i*3+j$$



$$\begin{aligned}c[i][j] &\stackrel{\text{substitute } c[i]}{=} *(c[i]+j) \\ &= *(b+i*3+j) = b[i*3+j]\end{aligned}$$

$$\begin{aligned}b[m][k] &\stackrel{\text{substitute } b[m]}{=} *(b[m]+k) \\ &= *(a+m*4+k) = a[m*4+k]\end{aligned}$$

$$c[i][j][k] = b[i*3+j][k] = a[(i*3+j)*4+k]$$

$$\begin{aligned}c[i] &= \&b[i*3] = b+i*3 \\ b[j] &= \&a[j*4] = a+j*4\end{aligned}$$

substitute $c[i]$ in $(c[i])[j]$

substitute $b[m]$ in $(b[m])[k]$

$$m = i*3+j$$



$$\begin{aligned}c[i][j] &\stackrel{\text{substitute } c[i]}{=} (b+i*3)[j] \\ &= *(b+i*3+j) = b[i*3+j]\end{aligned}$$

$$\begin{aligned}b[m][k] &\stackrel{\text{substitute } b[m]}{=} (a+m*4)[k] \\ &= *(a+m*4+k) = a[m*4+k]\end{aligned}$$

$$c[i][j][k] = b[i*3+j][k] = a[(i*3+j)*4+k]$$

Integer array **a** and pointer arrays **b**, **c**

```
int ** c [2] ;  
int * b [2*3] ;  
int a [2*3*4] ;
```

divide 2·3·4 elements of **a** into
six (= 2·3) partitions
each partition has 4 elements

divide 2·3 elements of **b** into
two (= 2) partitions
each partition has 3 elements

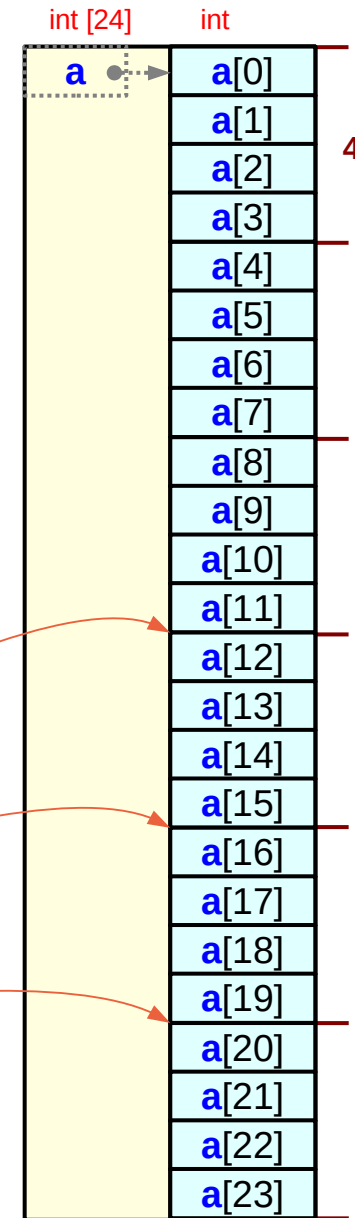
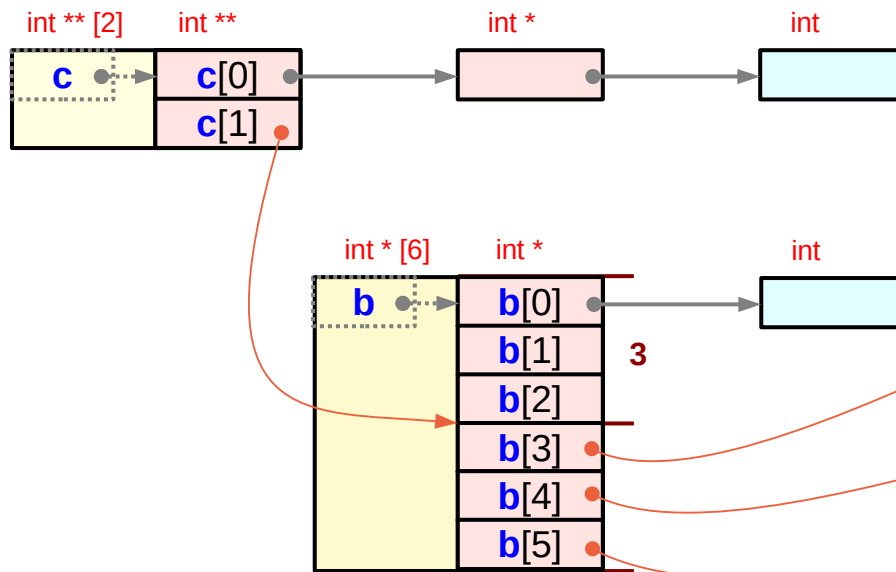

Pointer array initializations

int **	c [2] ;
int *	b [2*3] ;
int	a [2*3*4] ;

$$c[i] = \&b[i*3] \quad (= b+i*3)$$

each element of **c** handles **3** elements of **b**
 → **3**-element partitions in **b**

$$b[j] = \&a[j*4] \quad (= a+j*4)$$

each element of **b** handles **4** elements of **a**
 → **4**-element partitions in **a**

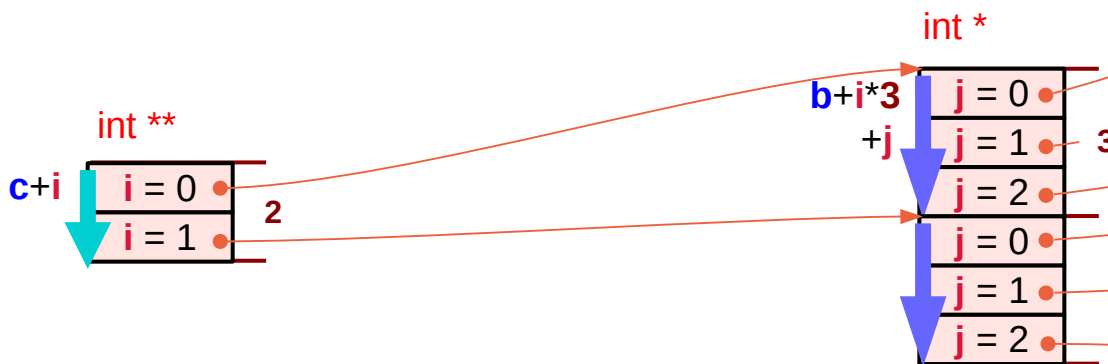

skipping **i** elements from **c**
 = skipping **i*3** elements from **b**
 = skipping **i*3*4** leaf elements from **a**

skipping **j** elements from **b**
 = skipping **j*4** leaf elements from **a**

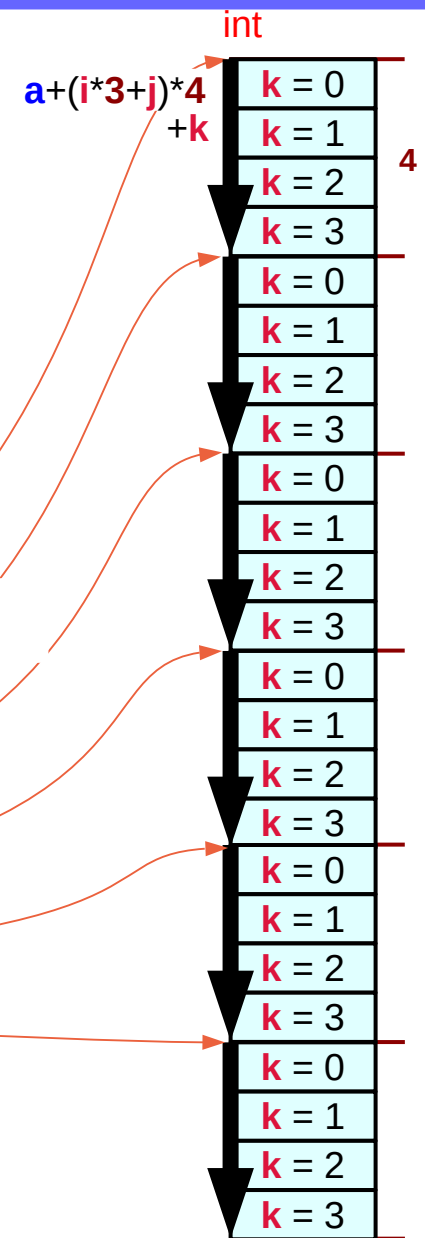

Partitioning arrays **a** and **b**

int **	c [2] ;
int *	b [2*3] ;
int	a [2*3*4] ;

Assigning pointer array

```

b[j] = &a[j*4] (= a+j*4)
c[i] = &b[i*3] (= b+i*3)
    
```

```

c[0] = &b[0*3]; (= b + 0*3)
c[1] = &b[1*3]; (= b + 1*3)
    
```

```

b[0] = &a[0*4]; (= a + 0*4)
b[1] = &a[1*4]; (= a + 1*4)
b[2] = &a[2*4]; (= a + 2*4)
b[3] = &a[3*4]; (= a + 3*4)
b[4] = &a[4*4]; (= a + 4*4)
b[5] = &a[5*4]; (= a + 5*4)
    
```

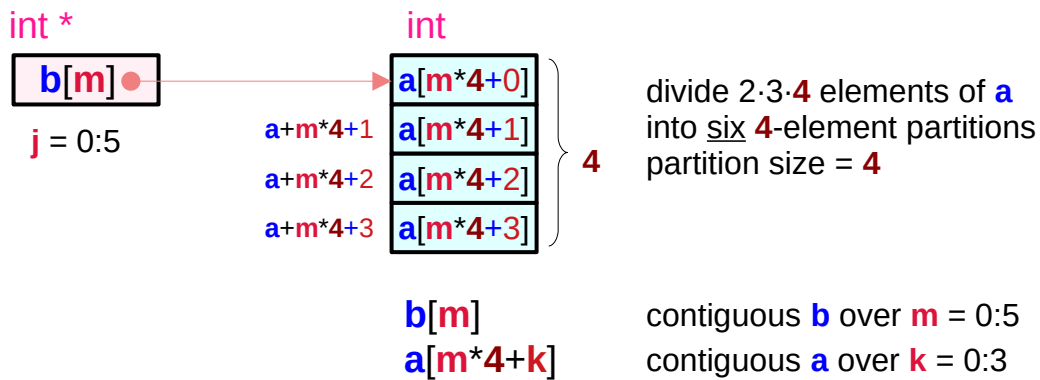
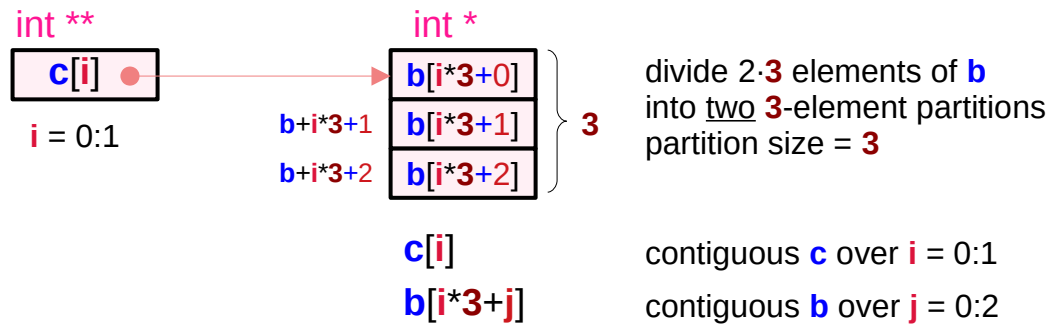

Skipping leaf elements

int **	c [2] ;
int *	b [2*3] ;
int	a [2*3*4] ;

$$\mathbf{b[j] = \&a[j*4] \quad (= a+j*4)}$$

skipping 1 element in **b**
= skipping **4** leaf elements in **a**

$$\mathbf{c[i] = \&b[i*3] \quad (= b+i*3)}$$

skipping 1 element in **c**
= skipping **3** elements in **b**
= skipping **3*4** leaf elements in **a**

$$\mathbf{c[i][j][k] \equiv a[(i*3 + j)*4+k]}$$

skipping **i*3+j** elements from **b**
+ skipping **k** leaf elements from **a**
= skipping **(i*3+j)*4+k** leaf elements from **a**

$$\mathbf{c[i][j] \equiv b[i*3 + j]}$$

skipping **i** elements from **c**
+ skipping **j** elements from **b**
= skipping **i*3+j** elements from **b**

Contiguous constraints for $c[i][j][k]$

int **	c [2] ;
int *	b [2*3] ;
int	a [2*3*4] ;



b [j]	= & a [j*4] (= a +j*4)
c [i]	= & b [i*3] (= b +i*3)



c [i][j][k]	≡
a [(i*3 + j)*4+k]	

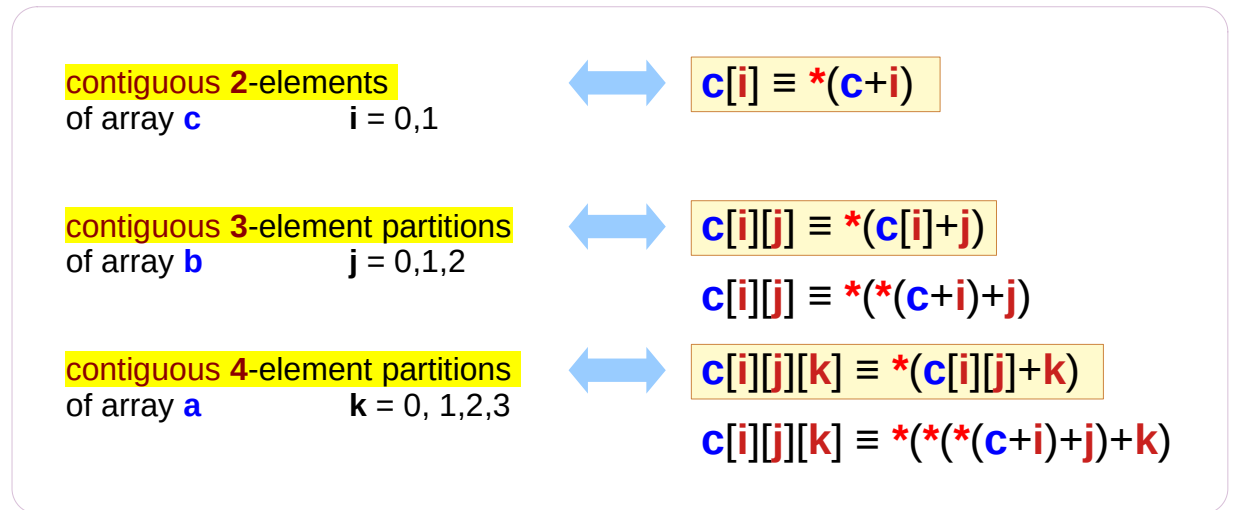
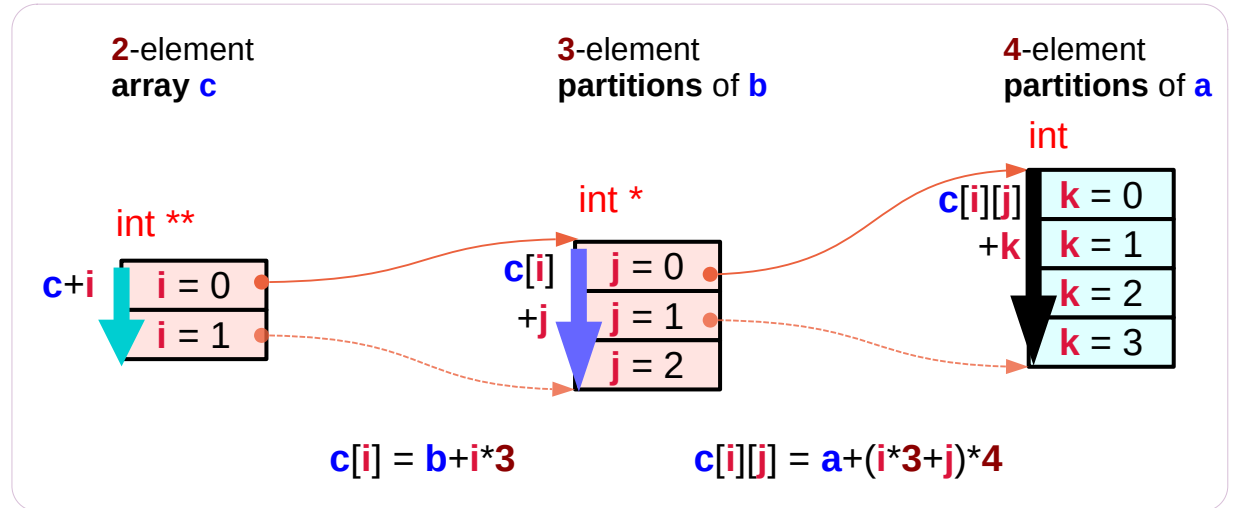

Minimal constraints and implementations

```
int c [2];      int b [2*3];  int c [2*3*4];
```

```
c[0] = &b[0*3];  b[0] = &a[0*4];  
c[1] = &b[1*3];  b[1] = &a[1*4];  
                b[2] = &a[2*4];  
                b[3] = &a[3*4];  
                b[4] = &a[4*4];  
                b[5] = &a[5*4];
```

```
int c [2];      int b1 [3];  int a1 [4];  
                int b2 [3];  int a2 [4];  
                int a3 [4];  
                int a4 [4];  
                int a5 [4];  
                int a6 [4];
```

```
c[0] = &b1[0];   b1[0] = &a1[0];  
c[1] = &b2[0];   b1[1] = &a2[0];  
                b1[2] = &a3[0];  
                b2[0] = &a4[0];  
                b2[1] = &a5[0];  
                b2[2] = &a6[0];
```

contiguous
2-element
array **c**

contiguous
2·3-element
array **b**

contiguous
2·3·4-element
array **a**

minimal constraints

contiguous
2-element
array **c**

two contiguous
3-element
partitions of **b**

six contiguous
4-element
partitions of **a**

two contiguous
3-element
arrays **bi**

six contiguous
4-element
arrays **ai**

Accessing a **contiguous 1-d** array

- **1-d** array access
- **2-d** array access
- **3-d** array access

Accessing an int array **a** as a **1-d** array

```
int    a [2*3*4] ;
```



```
a [k]
```

k = 0,1, ...,23

```
int a [2*3*4] ;
```

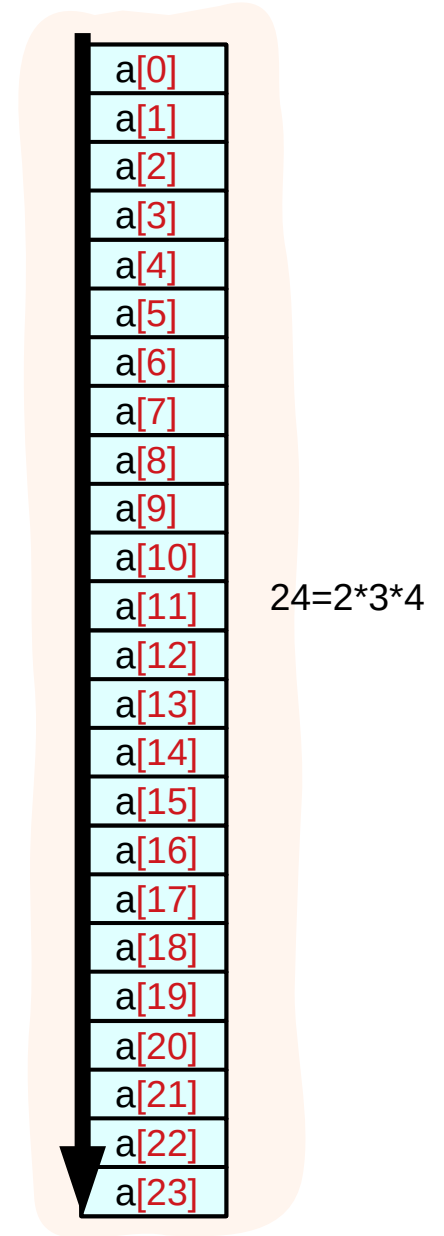

```
c[i][j][k] ≡ *(* (c+i)+j)+k    int ** c[2] ;  
b[j][k]    ≡ *(* (b+j)+k)      int * b[2*3] ;  
a[k]       ≡ *(a+k)            int a[2*3*4] ;
```

Accessing an int array **a** as a 2-d array using **b**

```
int    a [2*3*4] ;
int *  b [2*3] ;
```

```
b[j] = &a[j*4];
```

a, b take actual memory locations

$$b[j][k] \equiv a[j*4 + k]$$

$j = 0,1,2,3,4$
 $k = 0,1,2,3$

```
c[i][j][k] ≡ *(*((c+i)+j)+k)   int ** c[2] ;
b[j][k]    ≡ *(*((b+j)+k))      int * b[2*3] ;
a[k]       ≡ *(a+k)              int a[2*3*4] ;
```

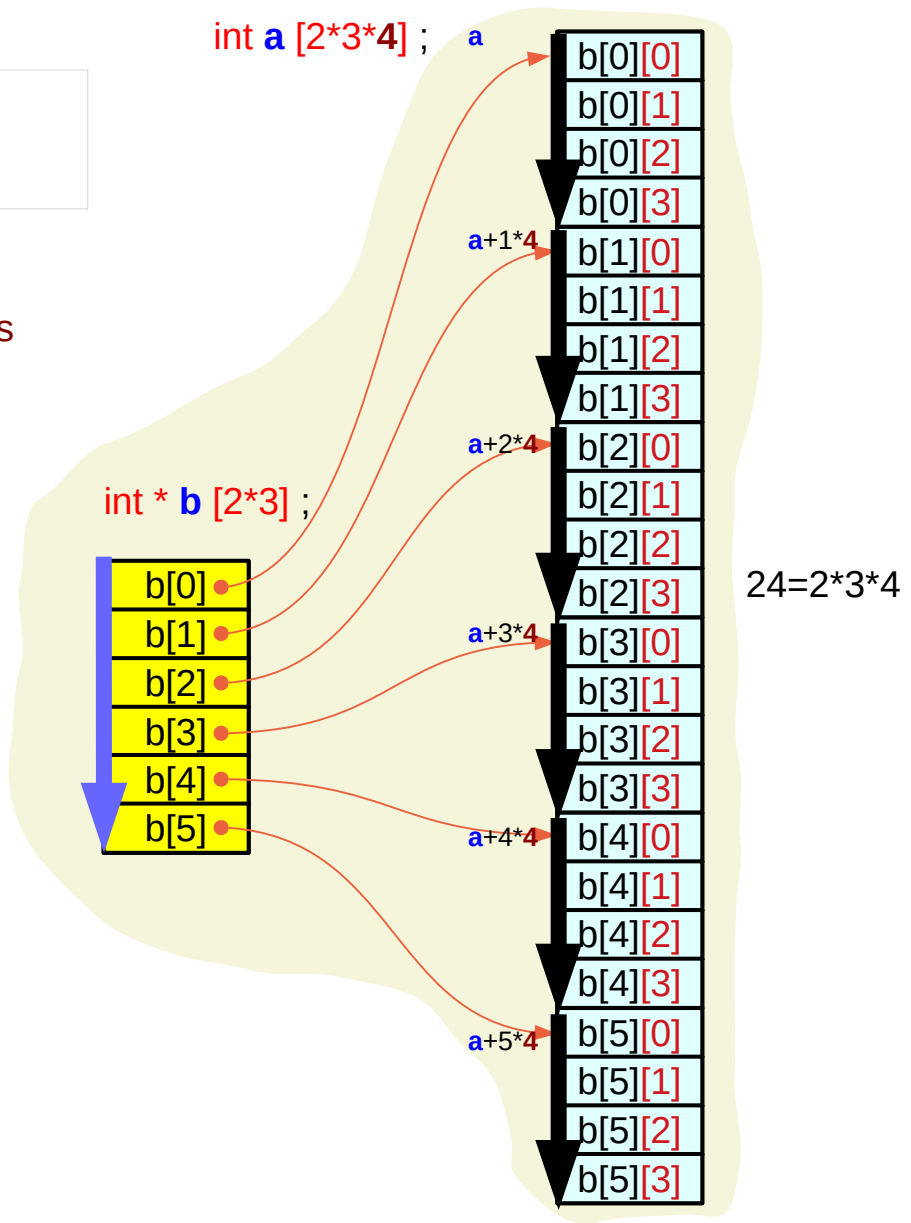

Accessing an int array **a** as a 3-d array

```
int    a [2*3*4] ;
int *  b [2*3]  ;
int ** c [2]    ;
```

```
c[i] = &b[i*3];
b[j] = &a[j*4];
```

a, **b**, **c** take actual memory locations

$$c[i][j][k] \equiv a[(i*3+j)*4+k]$$

$i = 0, 1$
 $j = 0, 1, 2$
 $k = 0, 1, 2, 3$

```
c[i][j][k] ≡ *(*(&c+i)+j)+k
b[j][k]    ≡ *(*(&b+j)+k)
a[k]       ≡ *(a+k)

int ** c[2];
int *  b[2*3];
int a[2*3*4];
```

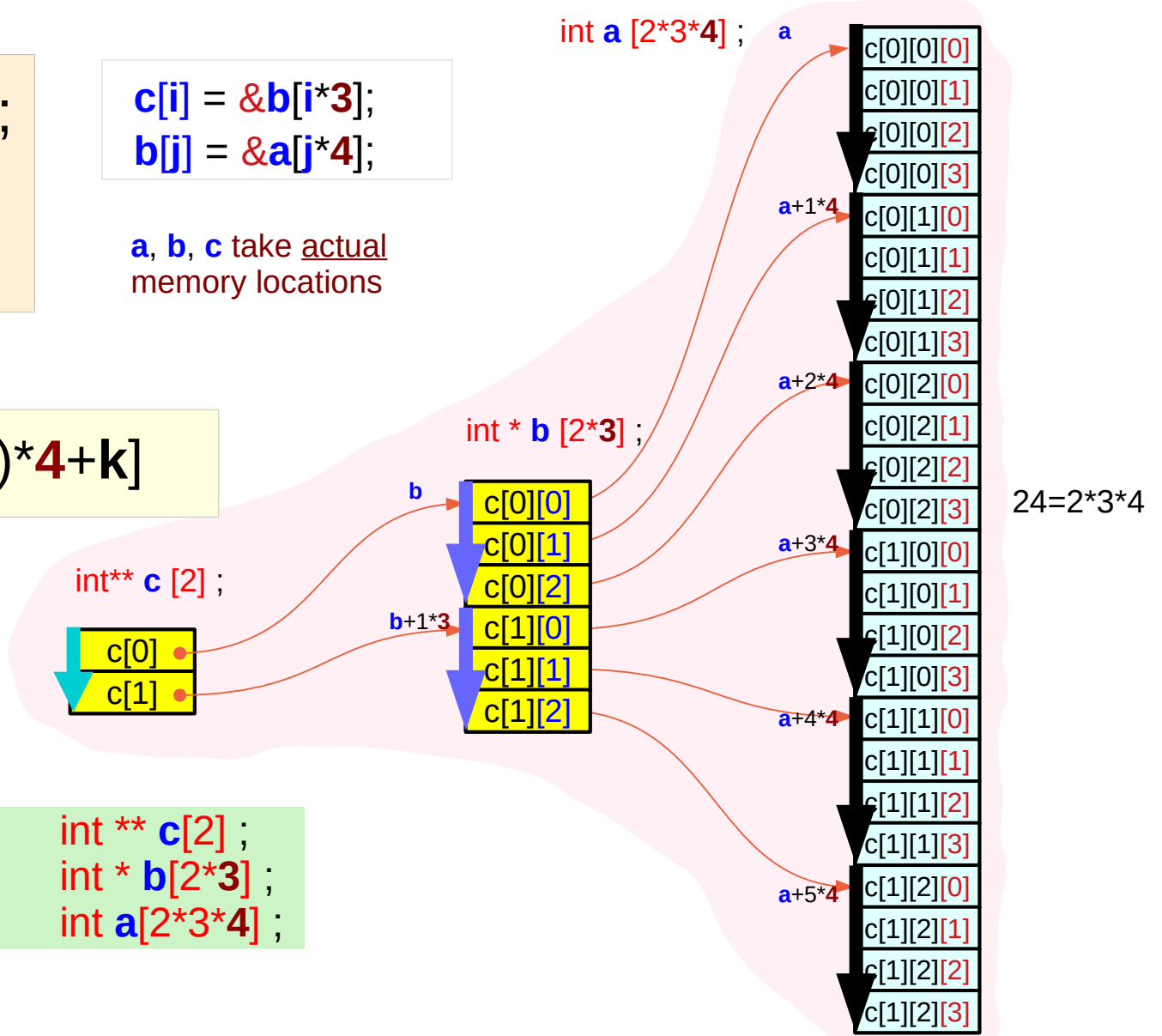

Accessing a **non-contiguous 1-d** arrays

- ◆ **3-d** array access

Accessing non-contiguous 1-d arrays as a 3-d array (1)

```
int    a [2*3*4] ;
int *  b [2*3] ;
int ** c [2] ;
```

```
c[i] = &b[i*3];
b[j] = &aj[0];
```

not c expressions

aj, b, c take actual memory locations

```
int a1 [4];
int a2 [4];
int a3 [4];
int a4 [4];
int a5 [4];
int a6 [4];
```

```
c [i][j][k]
```

i = 0, 1
j = 0, 1, 2
k = 0, 1, 2, 3

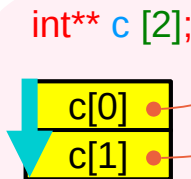

```
int* b [2*3];
```

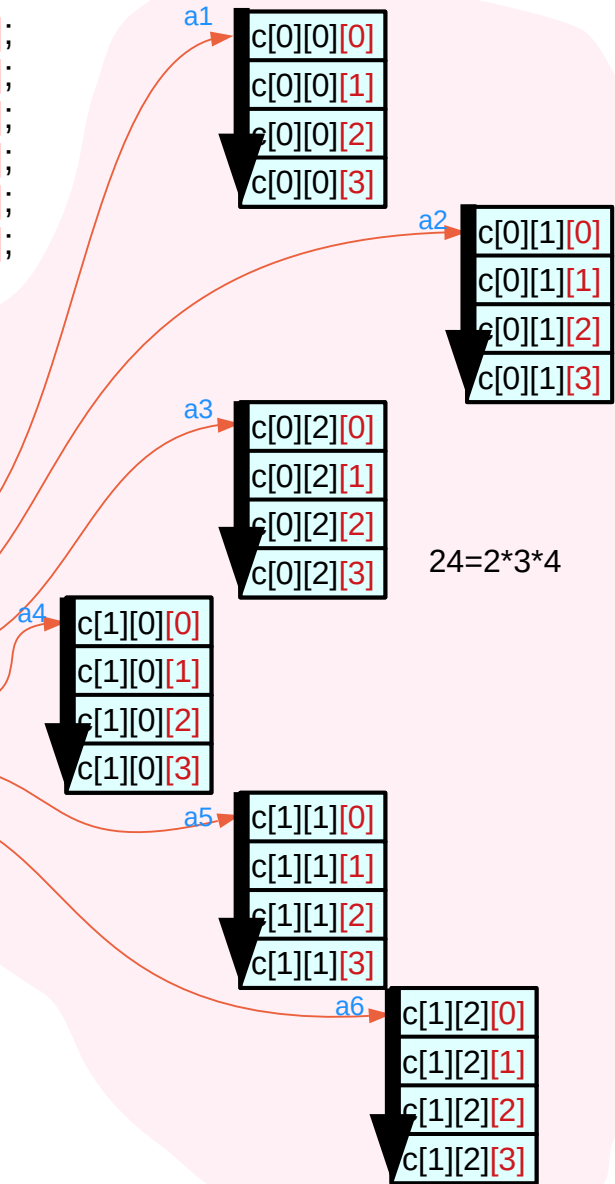
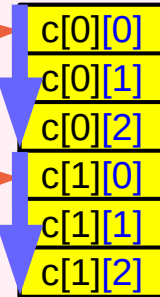

Because the physical **allocation** of array **c** and **b**,
the **contiguous constraints** can be **relaxed**
contiguous c[i][j][k] only for k=0,1,2,3

Accessing non-contiguous 1-d arrays as a 3-d array (2)

```
int    a [2*3*4] ;
int *  b [2*3] ;
int ** c [2] ;
```

not c expressions

```
c[i] = &bi[0];
bi[j] = &aj[0];
```

not c expressions

aj, bi, c take actual memory locations

```
int a1 [4];
int a2 [4];
int a3 [4];
int a4 [4];
int a5 [4];
int a6 [4];

int b1 [3];
int b2 [3];
```

```
c [i][j][k]
```

i = 0, 1
j = 0, 1, 2
k = 0, 1, 2, 3

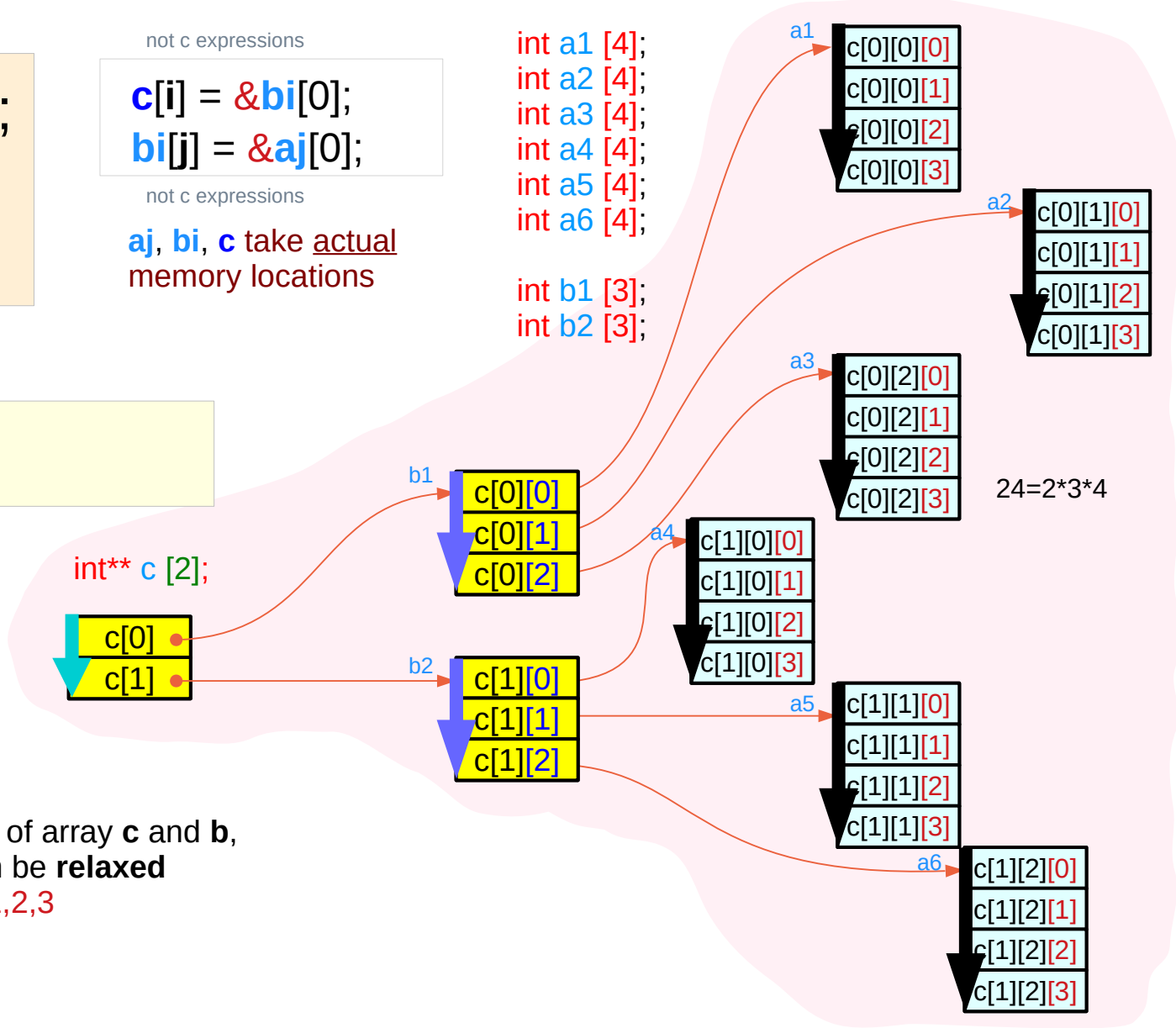
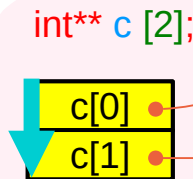

Because the physical **allocation** of array **c** and **b**,
the **contiguous constraints** can be **relaxed**
contiguous $c[i][j][k]$ only for $k=0,1,2,3$

Accessing **statically** allocated arrays

Accessing **dynamically** allocated arrays

Using arrays **a**, **b**, **c** – statically allocated

```

int **   c [2] ;
int *    b [2*3] ;
int      a [2*3*4] ;
    
```

static memory allocation

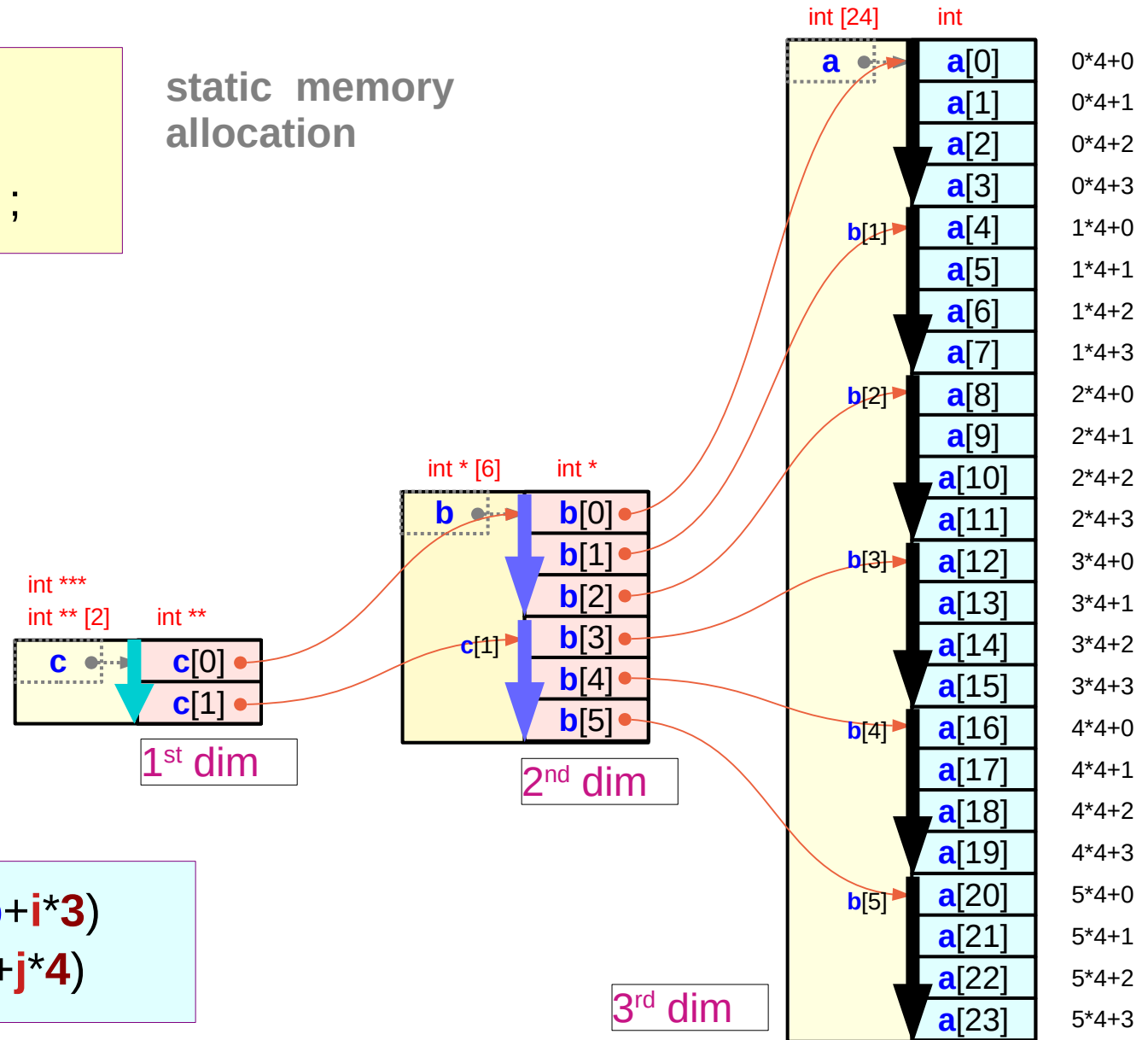

```

c[i] = &b[i*3] (= b+i*3)
b[j] = &a[j*4] (= a+j*4)
    
```

Using pointer **a**, **b**, **c** – dynamically allocated

```

int *** c = (int ***) malloc(2 * sizeof(int **));
int ** b = (int **) malloc(2*3 * sizeof(int *));
int * a = (int *) malloc(2*3*4 * sizeof(int));
    
```

dynamic memory allocation

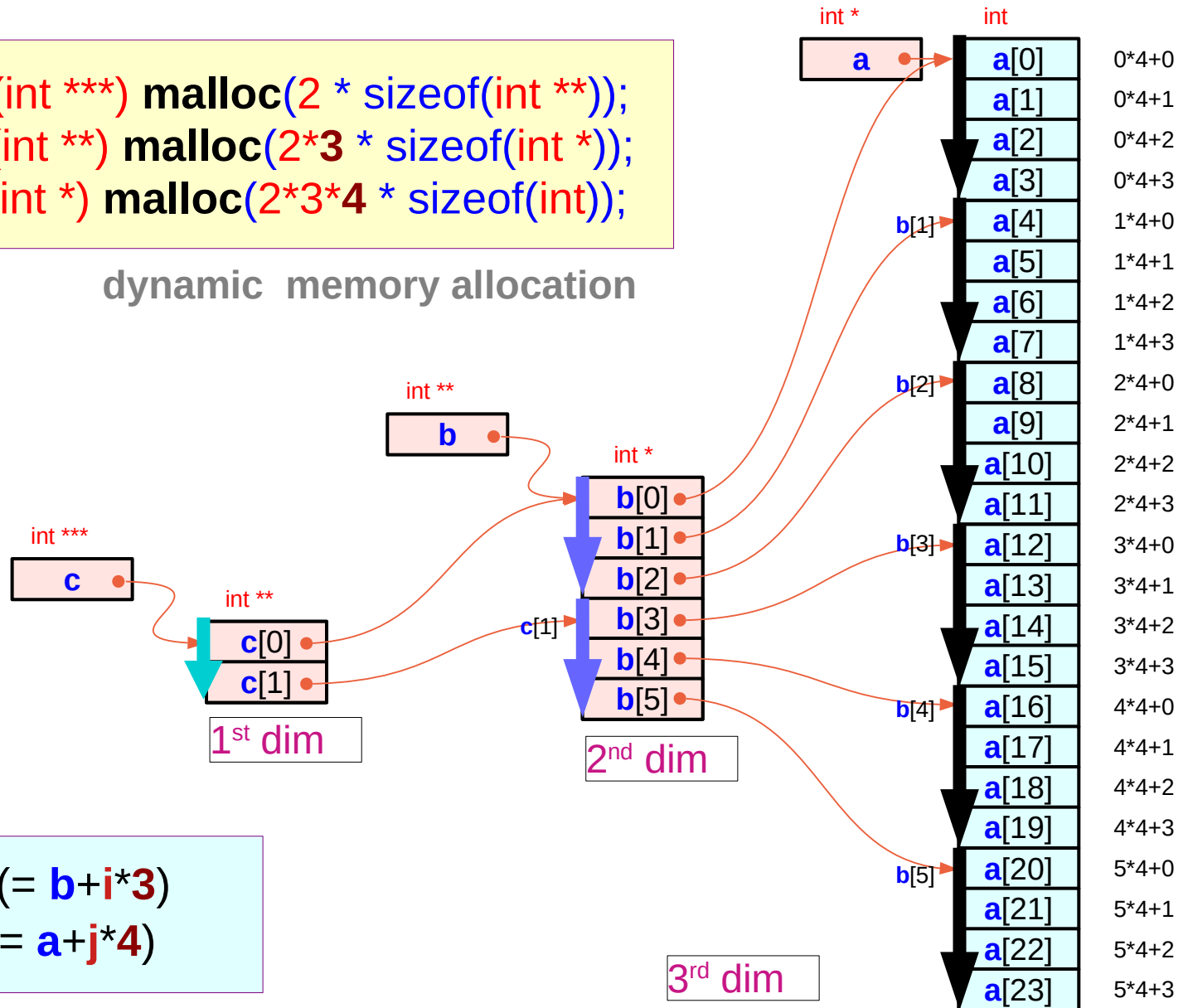

```

c[i] = &b[i*3] (= b+i*3)
b[j] = &a[j*4] (= a+j*4)
    
```

Static v.s. dynamic allocation (1)

int **	c	[2];
int *	b	[2*3];
int	a	[2*3*4];

static memory allocations

type(**c**) = int ** [2] → int ***
type(**b**) = int * [2*3] → int **
type(**a**) = int [2*3*4] → int *

sizeof(**c**) = 2 * sizeof(int **)
sizeof(**b**) = 2*3 * sizeof(int *)
sizeof(**a**) = 2*3*4 * sizeof(int)

value(**c**[i]) = **b** + 3*i
value(**b**[j]) = **a** + 4*j

int ***	c	= (int ***) malloc(2 * sizeof(int **));
int **	b	= (int **) malloc(2*3 * sizeof(int *));
int *	a	= (int *) malloc(2*3*4 * sizeof(int));

dynamic memory allocations

type(**c**) = int ***
type(**b**) = int **
type(**a**) = int *

sizeof(**c**) = 4 bytes on 32-bit system
sizeof(**b**) = 4 bytes on 32-bit system
sizeof(**a**) = 4 bytes on 32-bit system

value(**c**[i]) = **b** + 3*i
value(**b**[j]) = **a** + 4*j

c[i] = **&b**[i*3] (= **b**+i*3)
b[j] = **&a**[j*4] (= **a**+j*4)

Static v.s. dynamic allocation (2)

- static allocation

```
int ** c [2];
int * b [2*3];
int a [2*3*4];
```

- dynamic allocation

```
int *** c = (int ***) malloc(2 * sizeof(int **));
int ** b = (int **) malloc(2*3 * sizeof(int *));
int * a = (int *) malloc(2*3*4 * sizeof(int));
```

```
c[i] = &b[i*3] (= b+i*3)
b[j] = &a[j*4] (= a+j*4)
```

$c[i][j][k]$

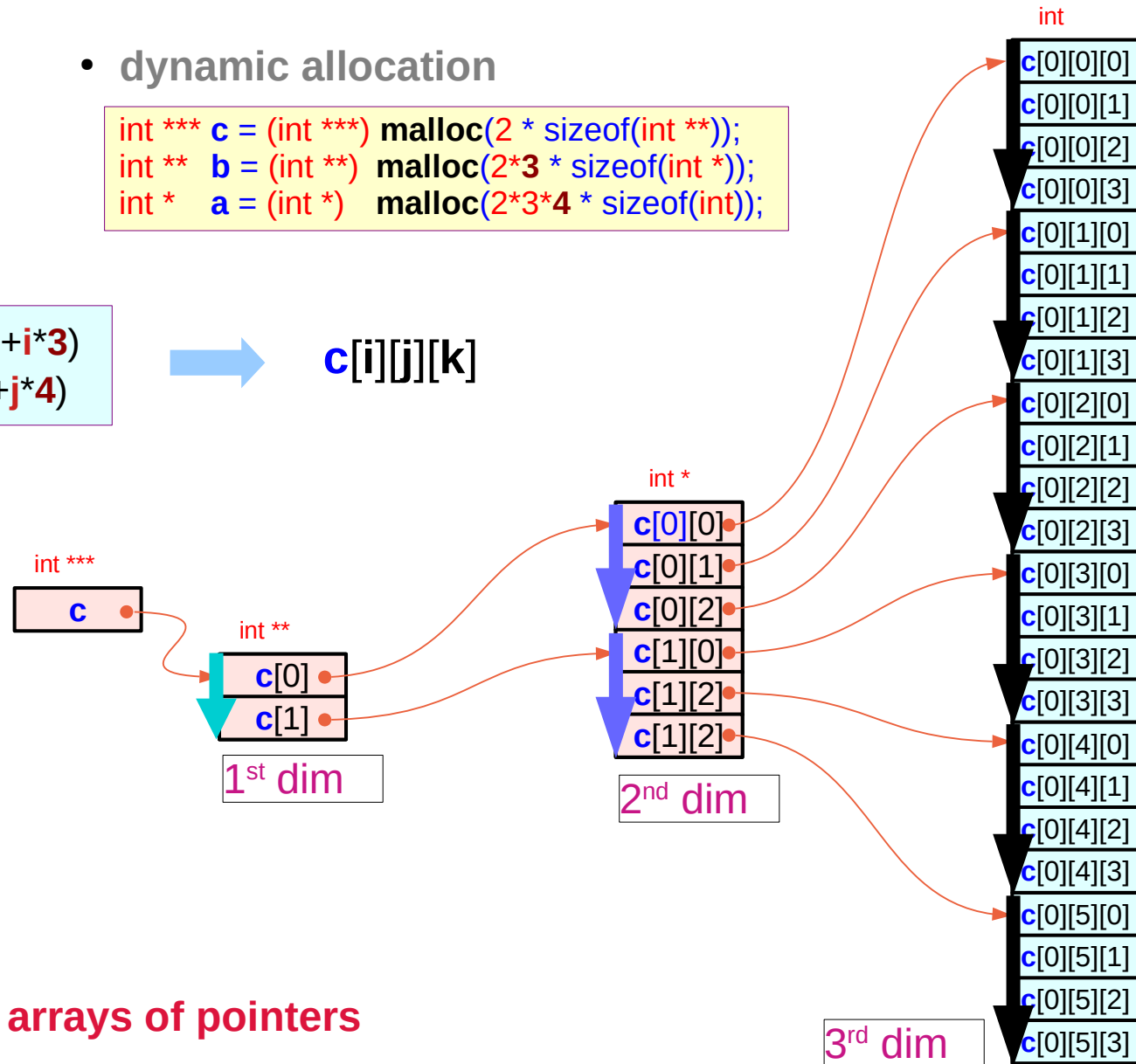

arrays of pointers

Static v.s. dynamic allocation (3)

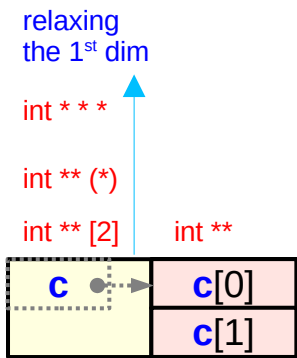

```
int ** c [2];
```

static memory allocation

```
int *** c = (int ***) malloc(2 * sizeof(int **));
```

```
malloc(2 * sizeof(int **));
```

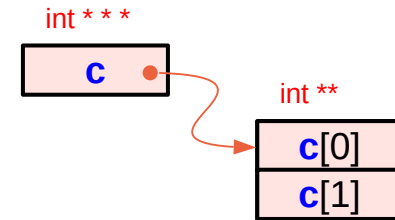
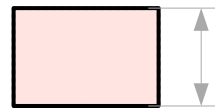

```
int *** c = (int ***) malloc(2 * sizeof(int **));
```

dynamic memory allocation

Static v.s. dynamic allocation (4)

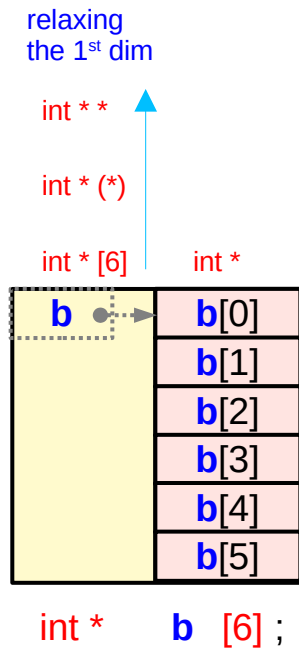

static memory allocation

```
int ** b = (int **) malloc(6 * sizeof(int *));
```

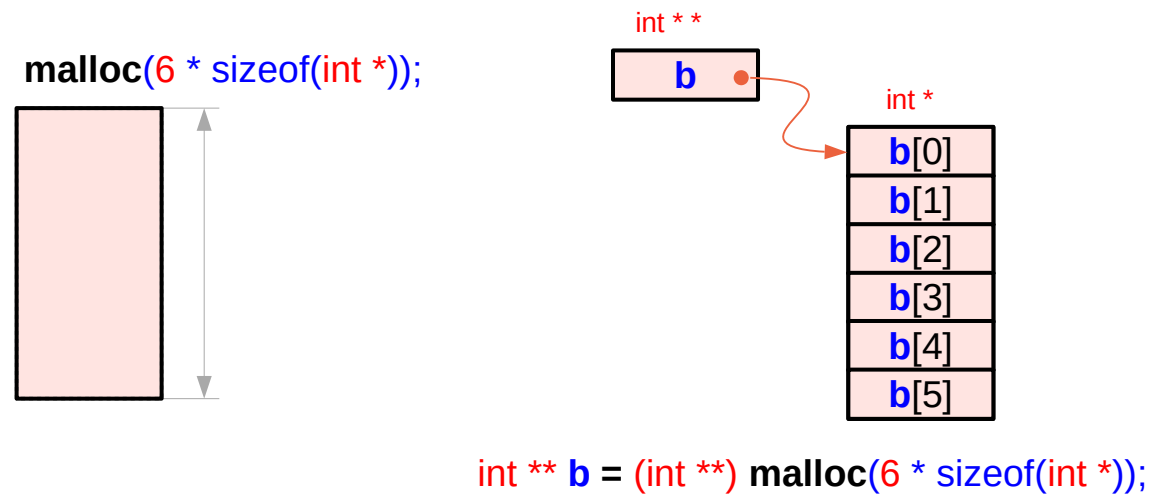

dynamic memory allocation

Static v.s. dynamic allocation (5)

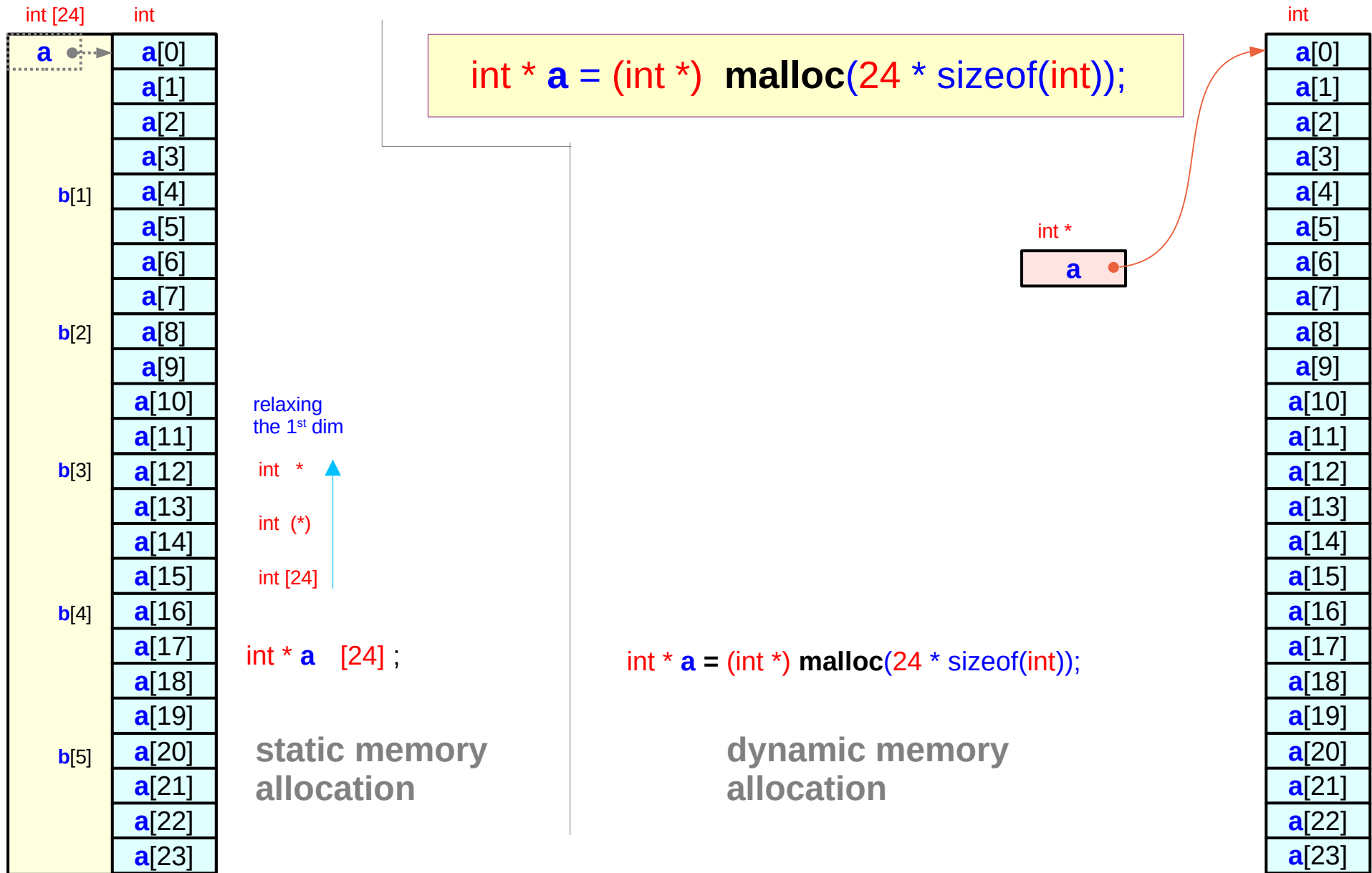

& address-of operator

* dereference operator

Address-of operator and dereferencing operator

*the address of a variable :
address-of operator **&***

*the content at an address :
dereferencing operator ******

& variable :
returns the address of a variable

variable *has memory locations
whose value can be changed
by an assignment*

(variable must be an lvalue)

*** address** :
returns the value at the address

*** address** *has memory locations
whose value can be changed
by an assignment*

(* address is an lvalue)

Ivalue and rvalue in assignments

Left Hand Side = Right Hand Side
LHS = **RHS**

```
int a, b = 10 ;  
int * p, q = &a ;
```

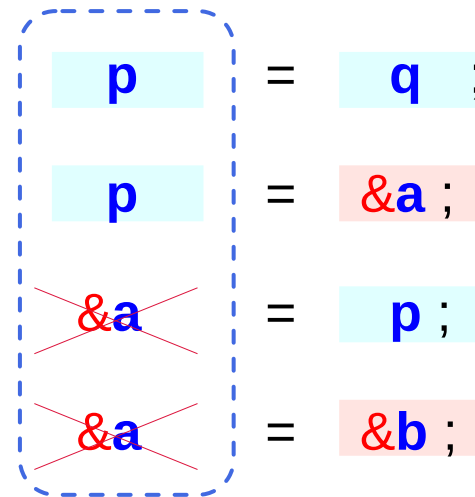
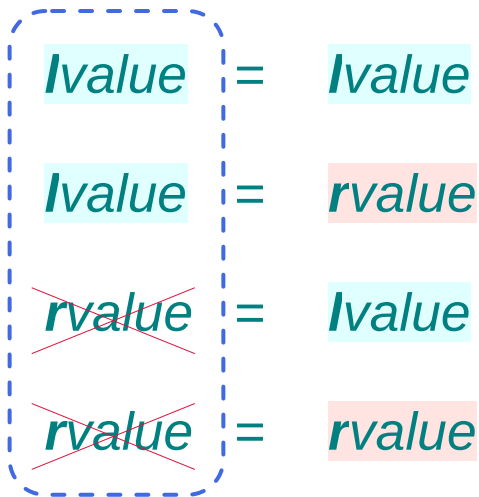

in the **LHS**, only **lvalue** can exist
rvalue can exist only in the **RHS**

a, b, p, q	: lvalues	... variables	... RW
*p, *q	: lvalues	... variables	... RW
&a, &b	: rvalues	... constants	... RO

Ivalue and rvalue with * and & operators

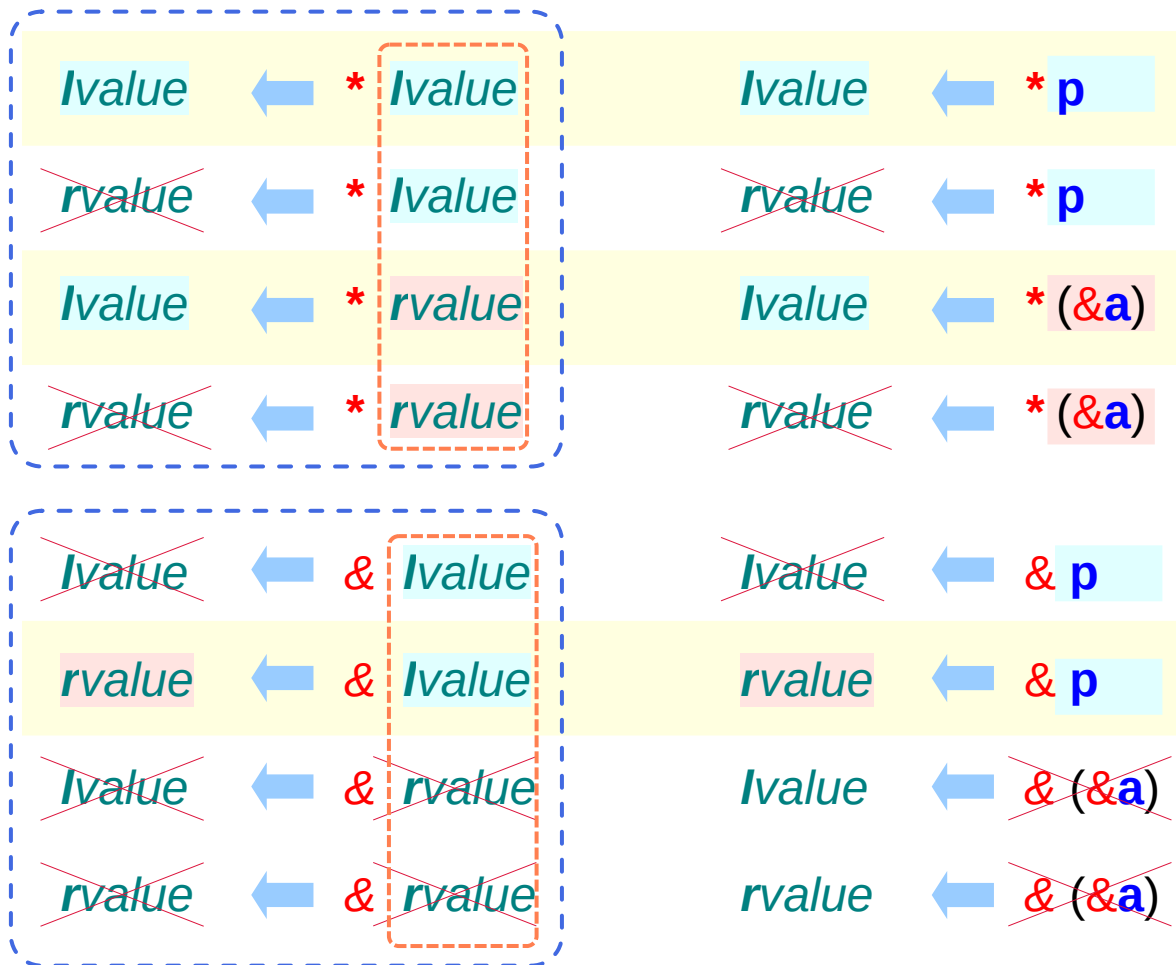

```
int a = 10 ;
int * p = &a ;
```

* can be applied to either an **Ivalue** variable or a **rvalue** address

* **operand** becomes an **Ivalue** variable thus can be applied successively.

& can be applied to only an **Ivalue** variable and returns only an **rvalue** address

`a, p` : lvalues ... variables ... RW
`*p` : lvalues ... variables ... RW
`&a` : rvalues ... constants ... RO

Address-of and dereference operators

Primitive Data Type

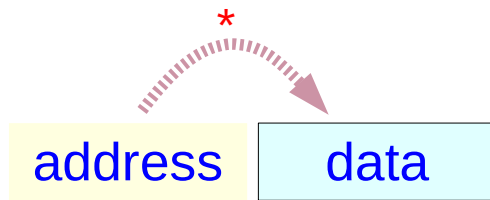

Ivalue **p** *Ivalue* ***p**
pointer *variable*

rvalue **&a** *Ivalue* **a**
constant *variable*

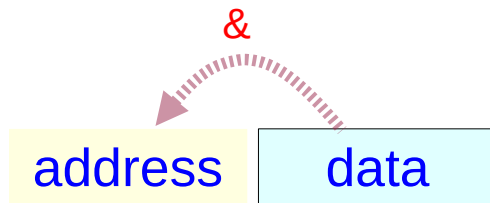

rvalue **&a** *Ivalue* **a**
constant *variable*

Pointer Data Type

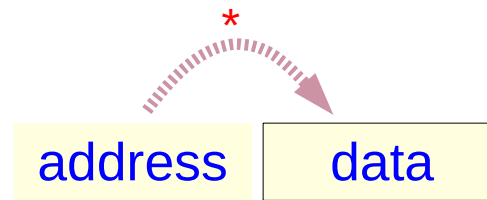

Ivalue **q** *Ivalue* ***q**
double pointer *pointer*

rvalue **&q** *Ivalue* **q**
constant *double pointer*

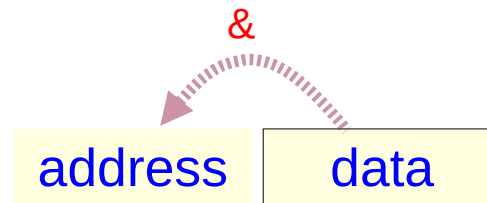

rvalue **&q** *Ivalue* **q**
constant *double pointer*

```
int a;
int * p;
int ** q;
```

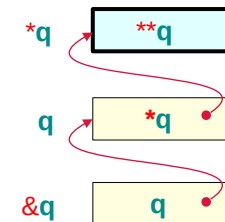
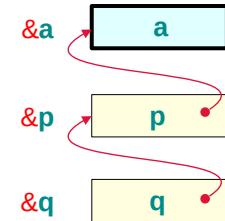

C operators : & and *

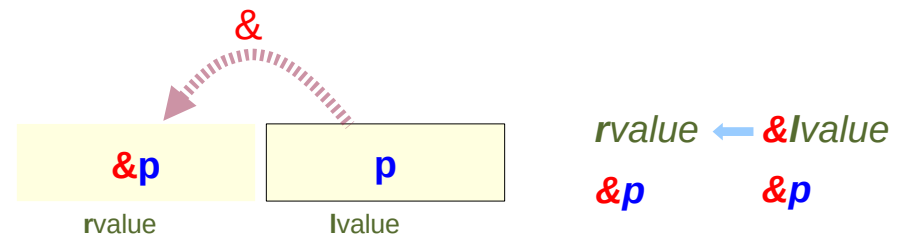
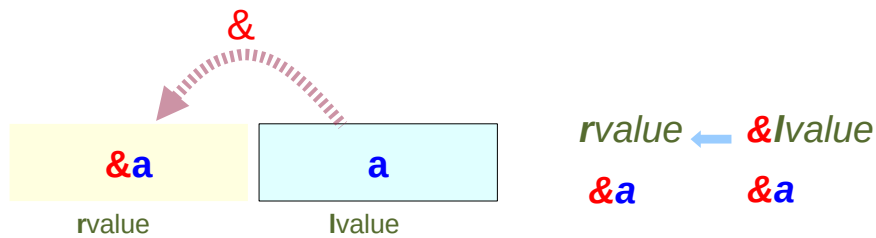
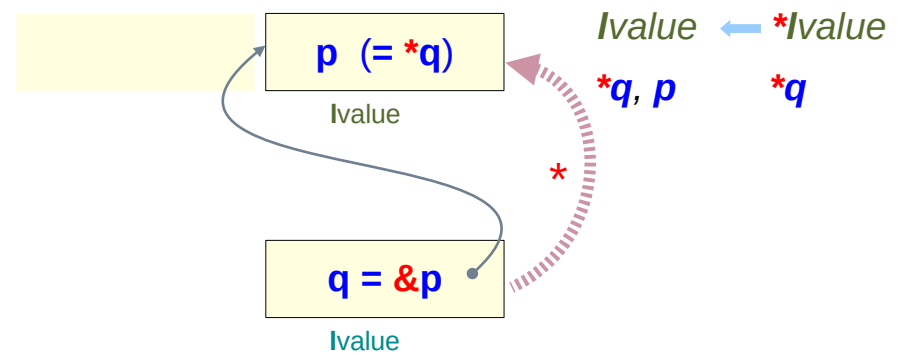
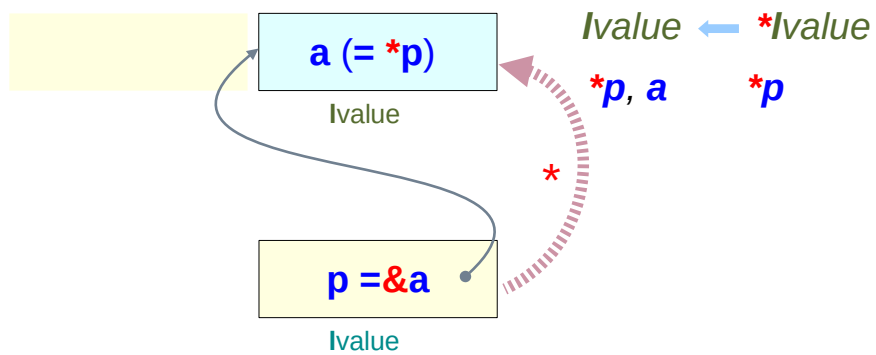
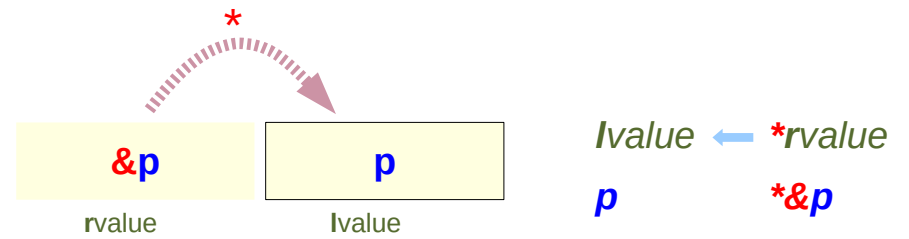
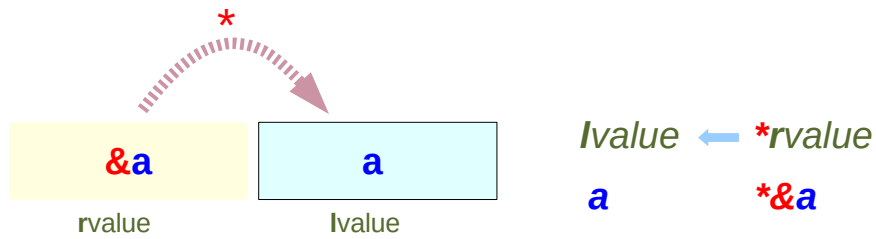

Mathematical operators : $\bar{\&}$ and $\bar{*}$

Address-of operation

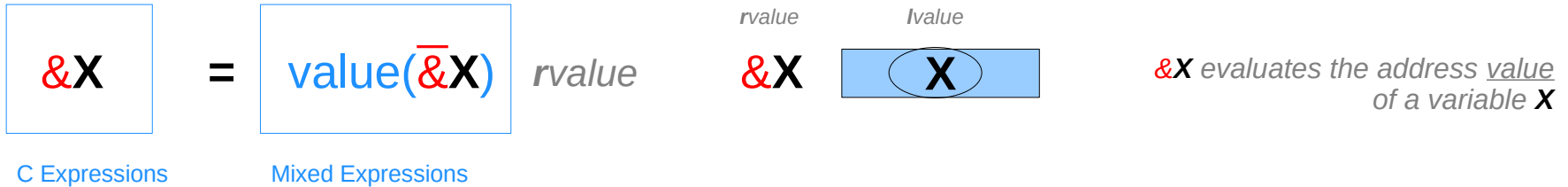

$\bar{\&}$ is a mathematical operator (the inverse operator of $*$)

$$\text{value}(\&X) = \text{value}(\text{value}(\bar{\&X})) = \text{value}(\bar{\&X}) = \&X$$

De-reference operation

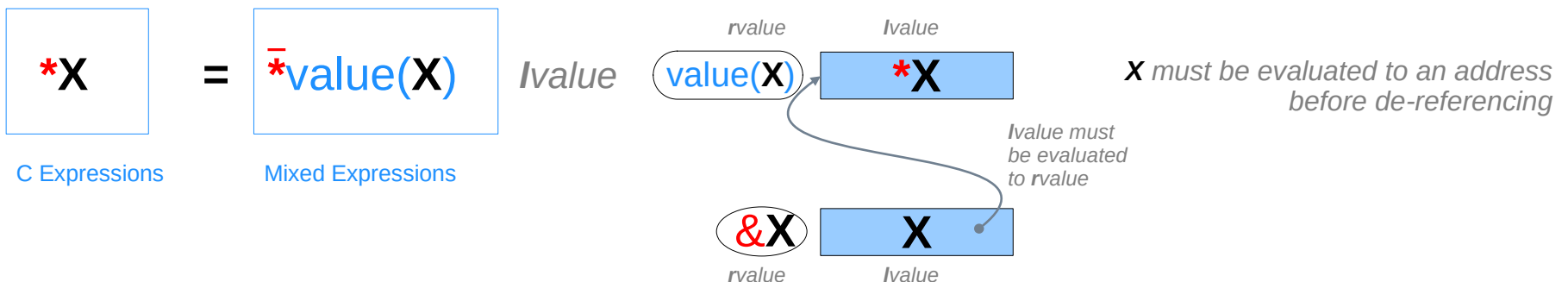

& and * operators in terms of $\bar{\&}$ and $\bar{*}$

Address-of operation

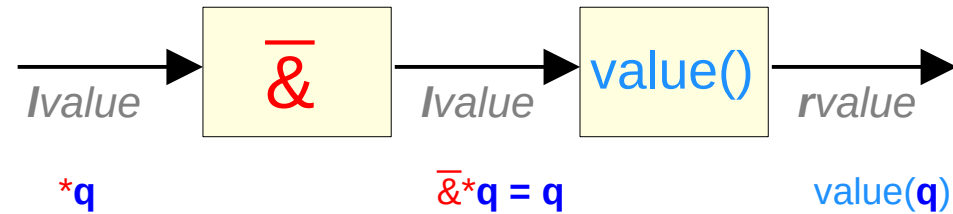

De-reference operation

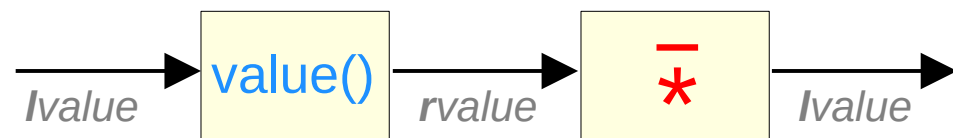
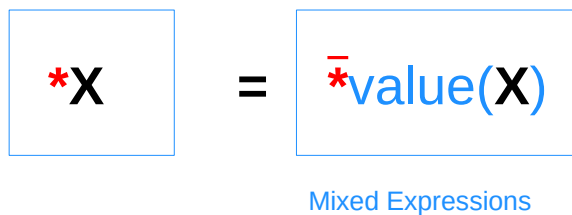

& and * operators in terms of $\bar{\&}$ and $\bar{*}$

Address-of operation

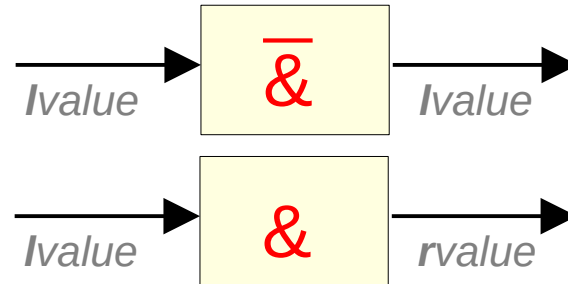

De-reference operation

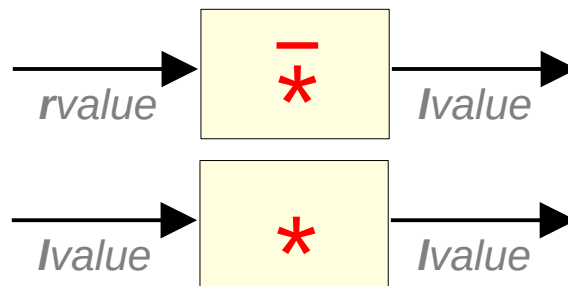
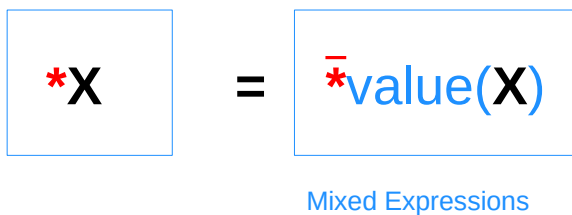

Inverse operators $\bar{*}$ and $\&$

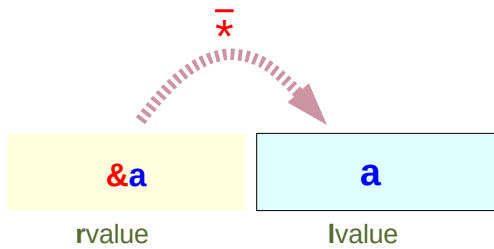

$lvalue = \bar{*}rvalue$
 $a \leftarrow \bar{*}\&a$

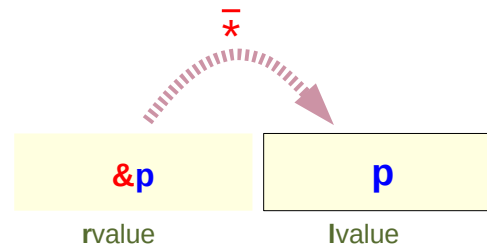

$lvalue = \bar{*}rvalue$
 $p \leftarrow \bar{*}\&p$

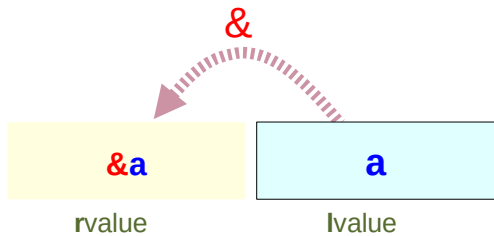

$rvalue = \&lvalue$
 $\&a \leftarrow \&a$

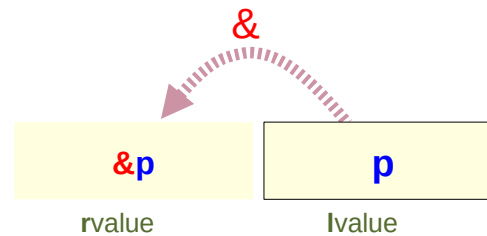

$rvalue = \&lvalue$
 $\&p \leftarrow \&p$

Inverse operators $\bar{\&}$ and $\bar{*}$

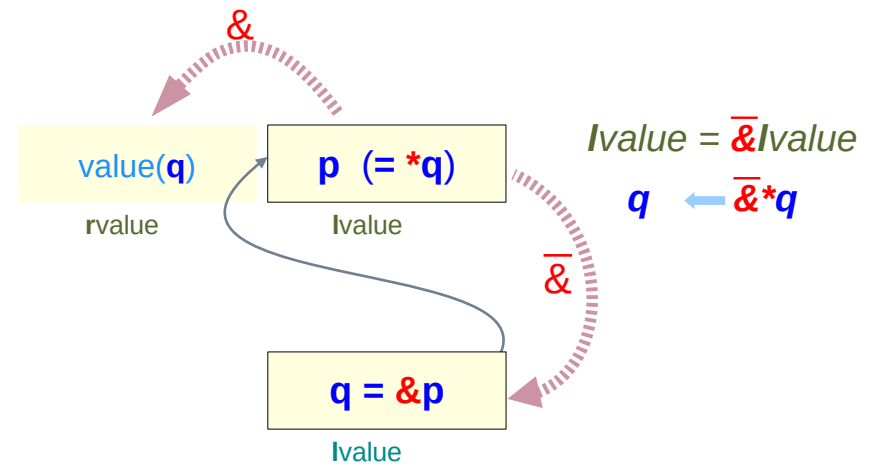
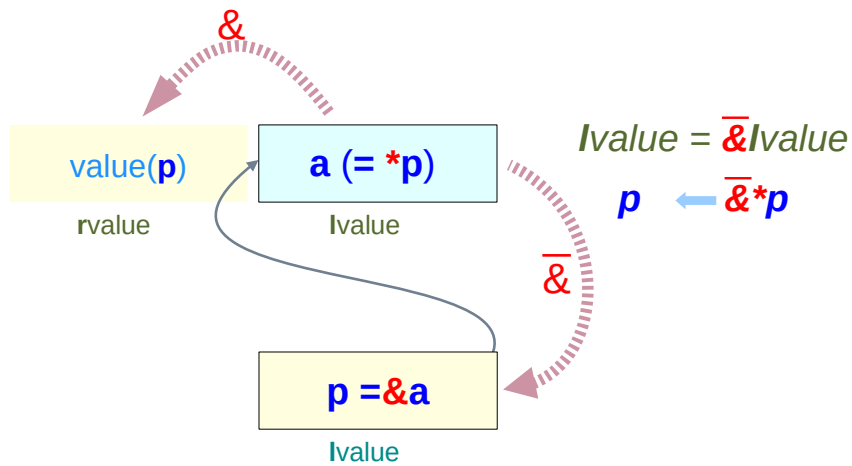
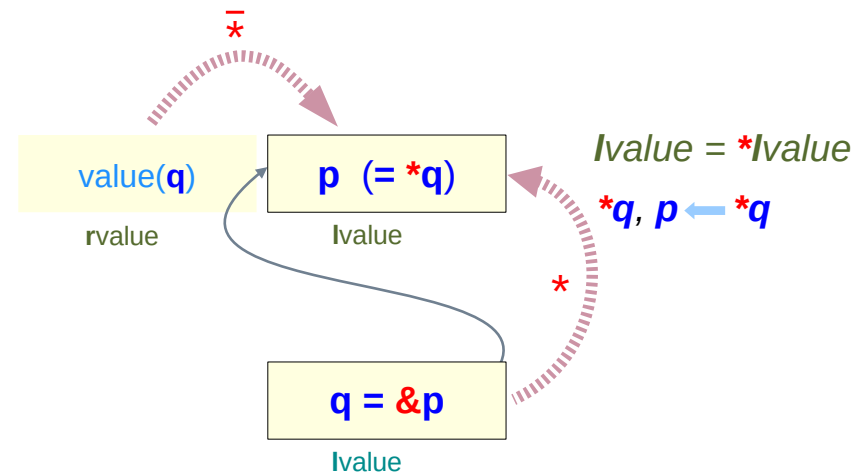
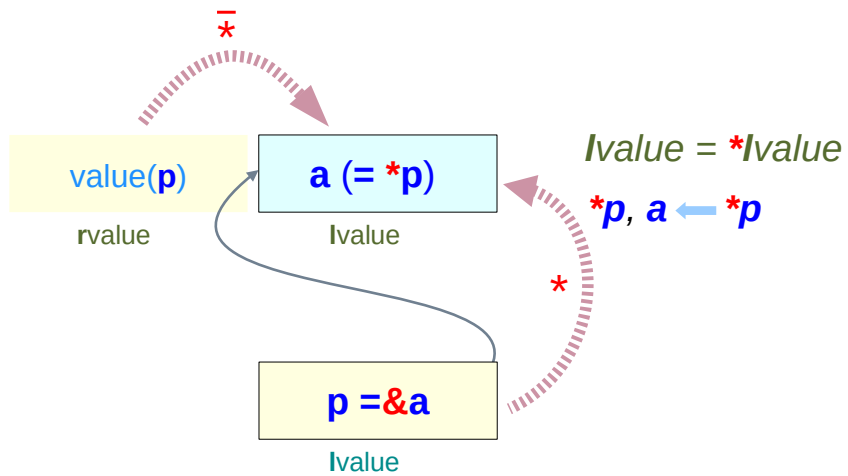

& and mathematical &

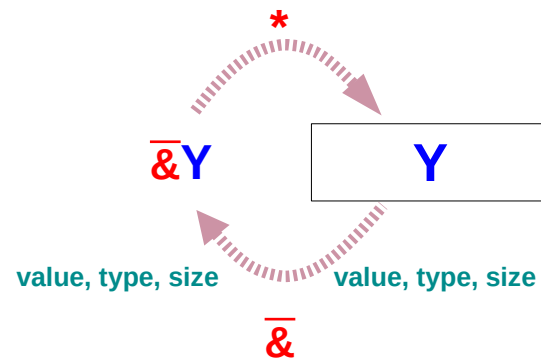
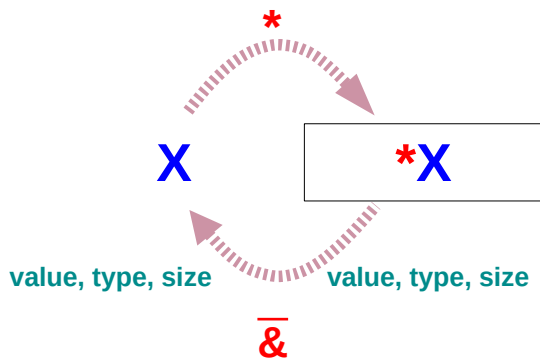
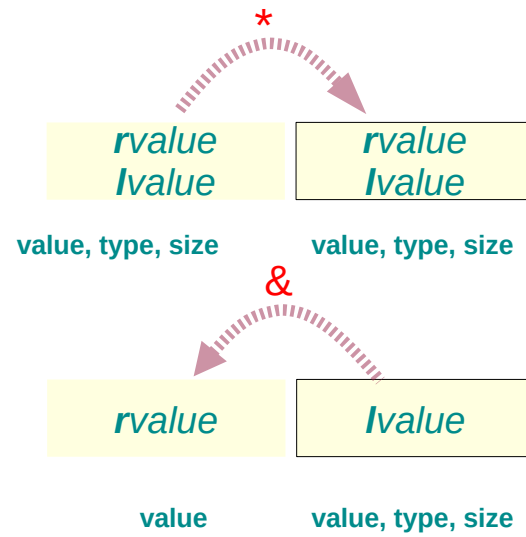
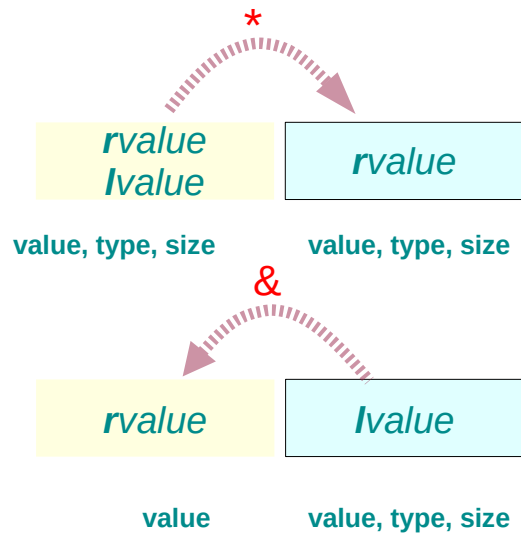

$X, Y, *X, \&Y$:
expressions
value, type, size

$$\cancel{\&} * X = X$$

$$\cancel{*} \& Y = Y$$

& and mathematical &

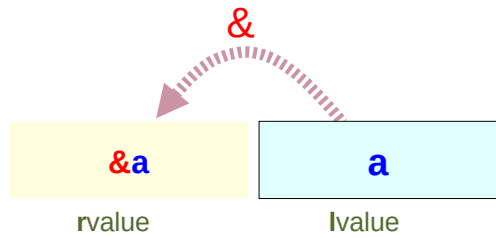

$rvalue = \&lvalue$
 $\&a \leftarrow \&a$

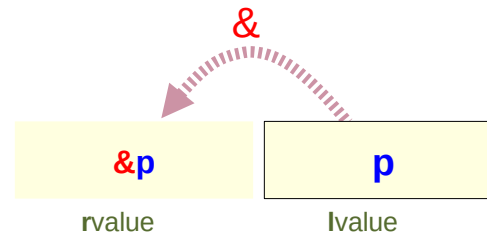

$rvalue = \&lvalue$
 $\&p \leftarrow \&p$

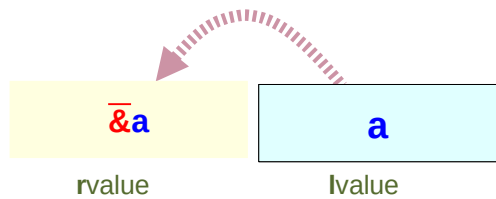

$rvalue = \&lvalue$
 $\&a \leftarrow \&a$

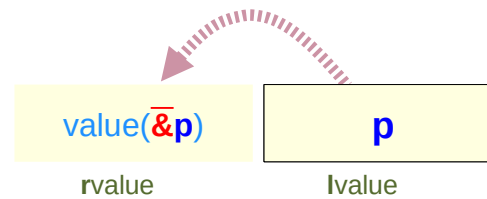

$rvalue = \&lvalue$
 $\&p \leftarrow \&p$

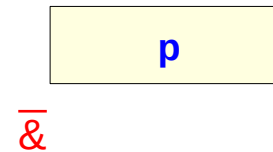
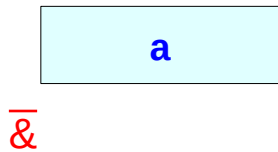

Byte addresses of sub-arrays in an array

~~&(&(&(c[i])[j])[k])~~

& C operator

can be applied to only **lvalue** variable

returns **address value**

thus, the above expression is **not** possible

successive application of & is **not** possible

In contrast, ***p** becomes a lvalue variable

***** operator can be applied successively.

Finding sub-array sizes

```
int c [2][3][4] ;
```

$\text{sizeof}(c[i][j][0]) = \text{sizeof}(\text{int})$

$\text{sizeof}(c[i][0]) = 4 * \text{sizeof}(\text{int})$

$\text{sizeof}(c[i]) = 3 * 4 * \text{sizeof}(\text{int})$

$\text{sizeof}(c) = 2 * 3 * 4 * \text{sizeof}(\text{int})$

Pointer increments and byte addresses

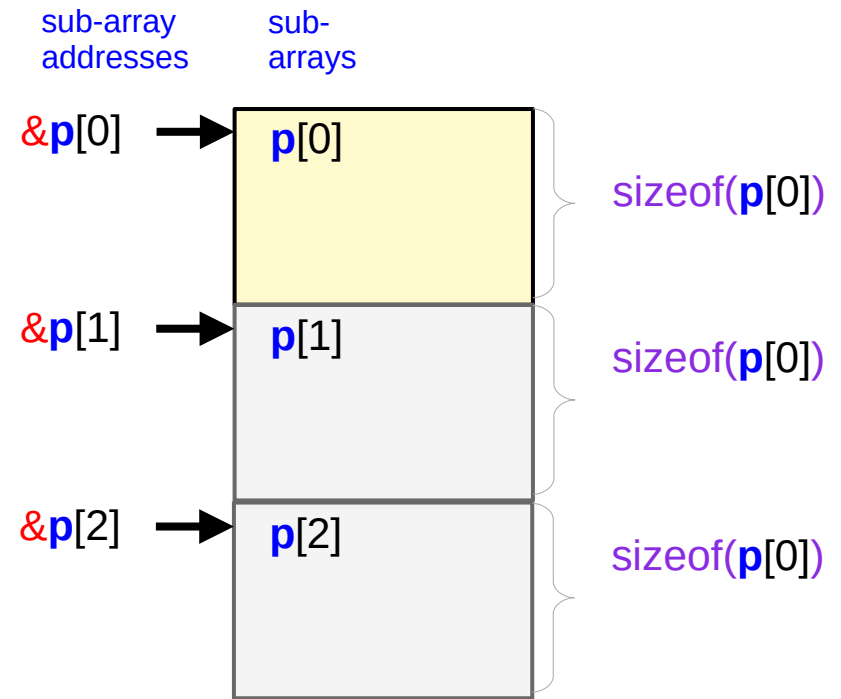
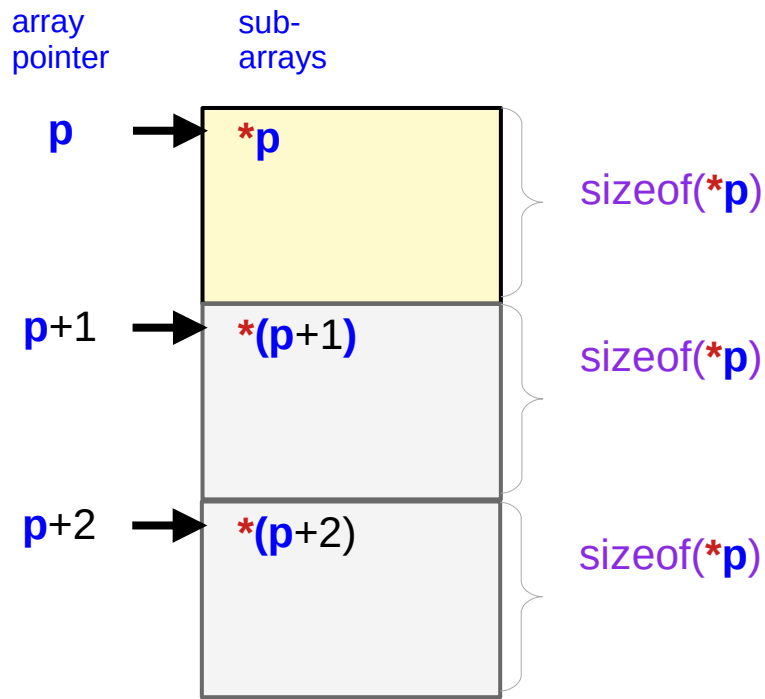

byte address byte address byte size

$$\text{value}(\mathbf{p+i}) = \text{value}(\mathbf{p}) + \mathbf{i} * \text{sizeof}(*\mathbf{p})$$

math expression with an explicit size information

$$(\mathbf{p+i})\text{sizeof}(*\mathbf{p})$$

byte address byte address byte size

$$\text{value}(\mathbf{\&p[i]}) = \text{value}(\mathbf{p}) + \mathbf{i} * \text{sizeof}(\mathbf{p[0]})$$

math expression with an explicit size information

$$(\mathbf{\&p[i]})\text{sizeof}(*\mathbf{p})$$

Byte addresses of subarrays $\&c[i]$, $\&c[i][j]$, $\&c[i][j][k]$

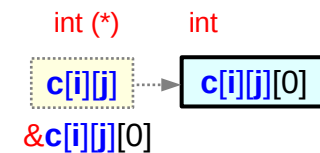
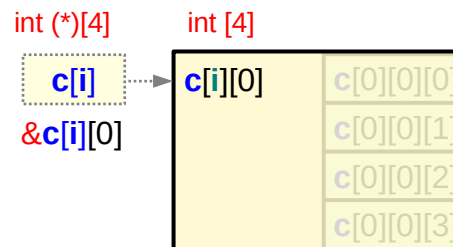
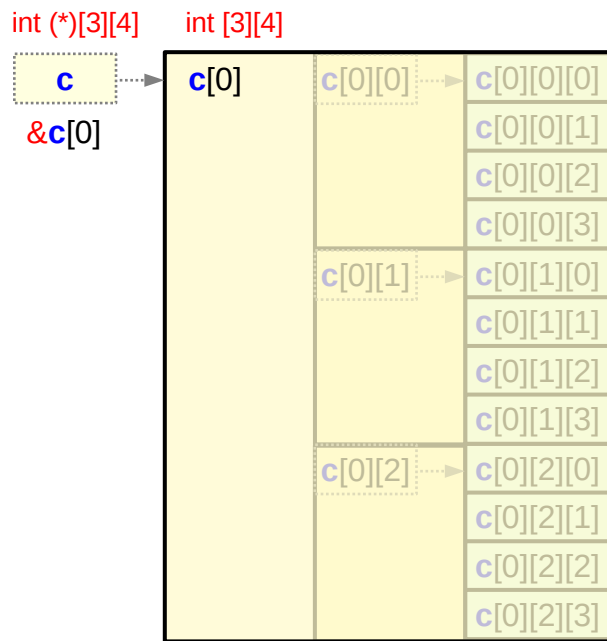

$i = 0:1$
 $j = 0:2$
 $k = 0:3$

$$\begin{aligned} \text{value}(\&c[i]) &= \text{value}(c+i) \\ &= \text{value}(c) + i * \text{sizeof}(*c) \\ &= \text{value}(c) + i * \text{sizeof}(c[0]) \\ &= \text{value}(c) + i * \text{sizeof}(\text{int}) * 3 * 4 \end{aligned}$$

skip i elements of $*c$ from c

$$(c + i)_{3 \cdot 4 \cdot 4}$$

$$\begin{aligned} \text{value}(\&c[i][j]) &= \text{value}(c[i]+j) \\ &= \text{value}(c[i]) + j * \text{sizeof}(*c[i]) \\ &= \text{value}(c[i]) + j * \text{sizeof}(c[i][0]) \\ &= \text{value}(c[i]) + j * \text{sizeof}(\text{int}) * 4 \end{aligned}$$

skip j elements of $*c[i]$ from $c[i]$

$$(c[i] + j)_{4 \cdot 4}$$

$$\begin{aligned} \text{value}(\&c[i][j][k]) &= \text{value}(c[i][j]+k) \\ &= \text{value}(c[i][j]) + k * \text{sizeof}(*c[i][j]) \\ &= \text{value}(c[i][j]) + k * \text{sizeof}(c[i][j][0]) \\ &= \text{value}(c[i][j]) + k * \text{sizeof}(\text{int}) \end{aligned}$$

skip k elements of $*c[i][j]$ from $c[i][j]$

$$(c[i][j] + k)_{1 \cdot 4}$$

Address replications and subarray addresses

Address Replication

transferring pointing address to the pointer that references itself

$$\&X = X$$

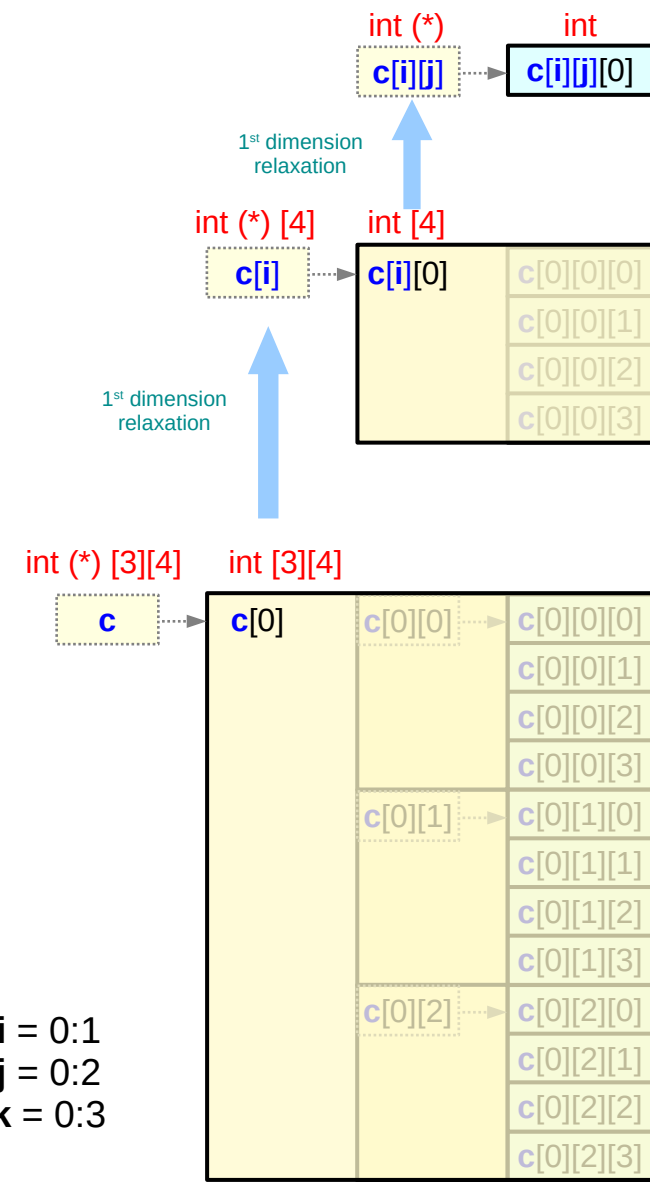
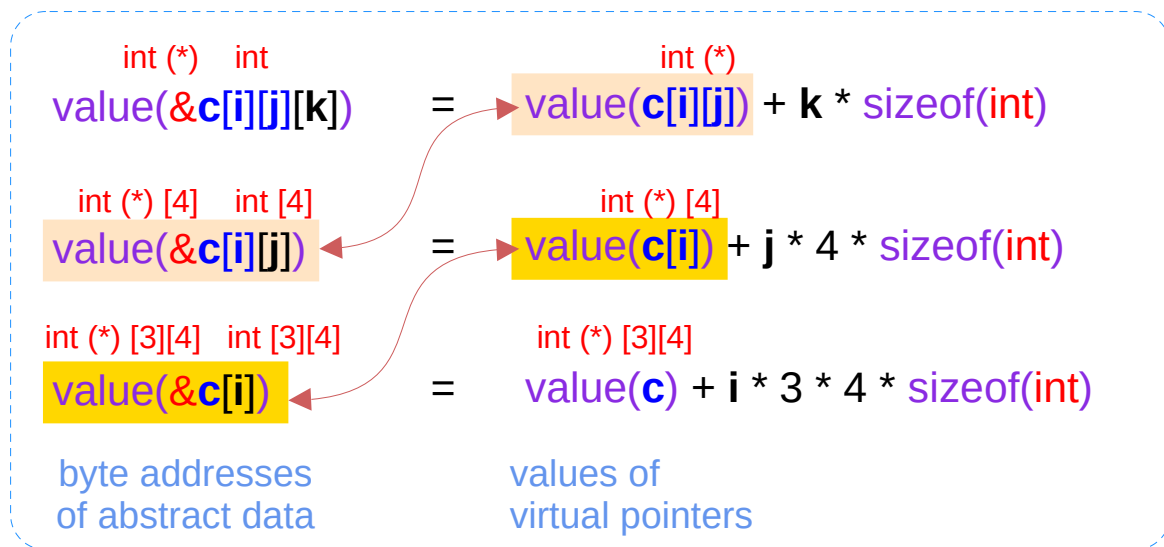

Address replications in a multi-dimensional array

```
int c [2][3][4] ;
```

equivalences

```
c[i][j] ≡ &c[i][j][0]
c[i]   ≡ &c[i][0]
c      ≡ &c[0]
```

address replication

```
value(c[i][j]) = value(&c[i][j])
value(c[i])    = value(&c[i])
value(c)       = value(&c)
```

c, c[0], c[0][0] :
these virtual pointers have
the same address value

a physical location
has a unique address



$c \equiv \&c[0]$

$c[0] \equiv \&c[0][0]$

$c[0][0] \equiv \&c[0][0][0]$

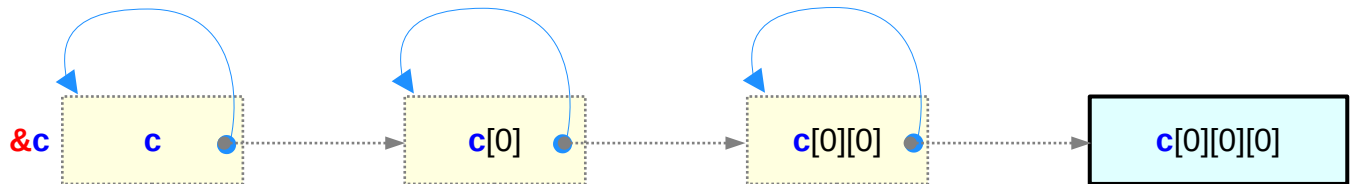
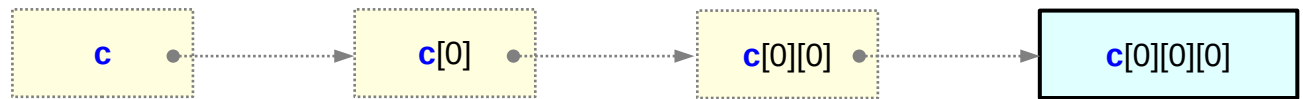

all have the same address value

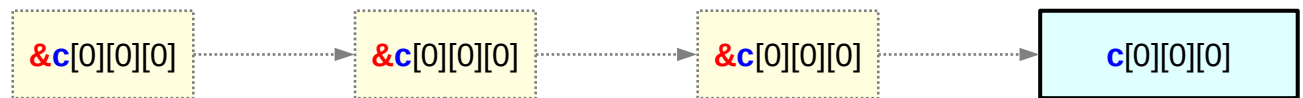

all have the same starting address

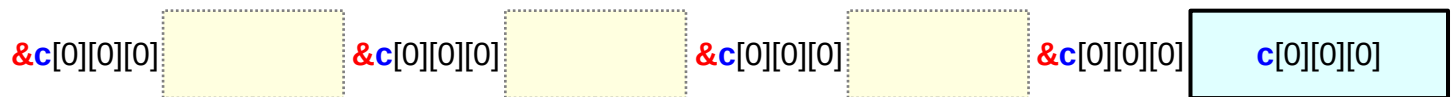

Referencing sub-arrays

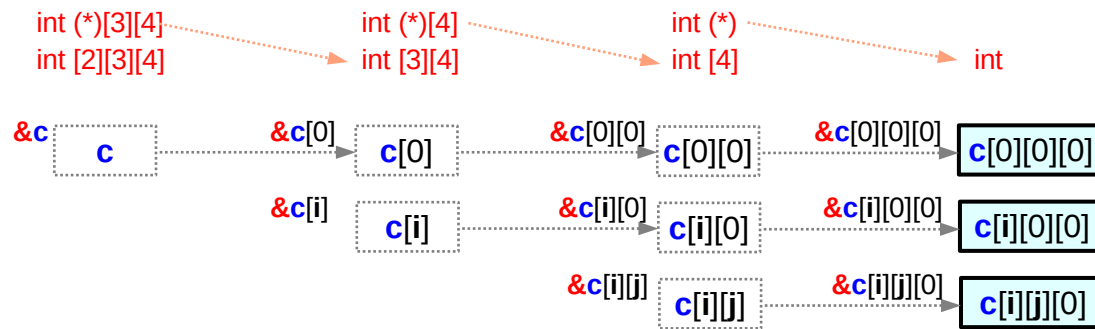

equivalence relations

$c[i][j] \equiv *(c[i]+j)$ $\&c[i][j] \equiv (c[i]+j)$ $\&c[i][0] \equiv c[i]$
 $c[i] \equiv *(c+i)$ $\&c[i] \equiv (c+i)$ $\&c[0] \equiv c$

address replication

$value(c[i][j]) = value(\&c[i][j]) = value(c[i]+j) = *value(c[i]+j)$
 $value(c[i]) = value(\&c[i]) = value(c+i) = *value(c+i)$

$c[i], c[i][0]$ point to the same data $c[i][0][0]$
 $c, c[0], c[0][0]$ point to the same data $c[0][0][0]$

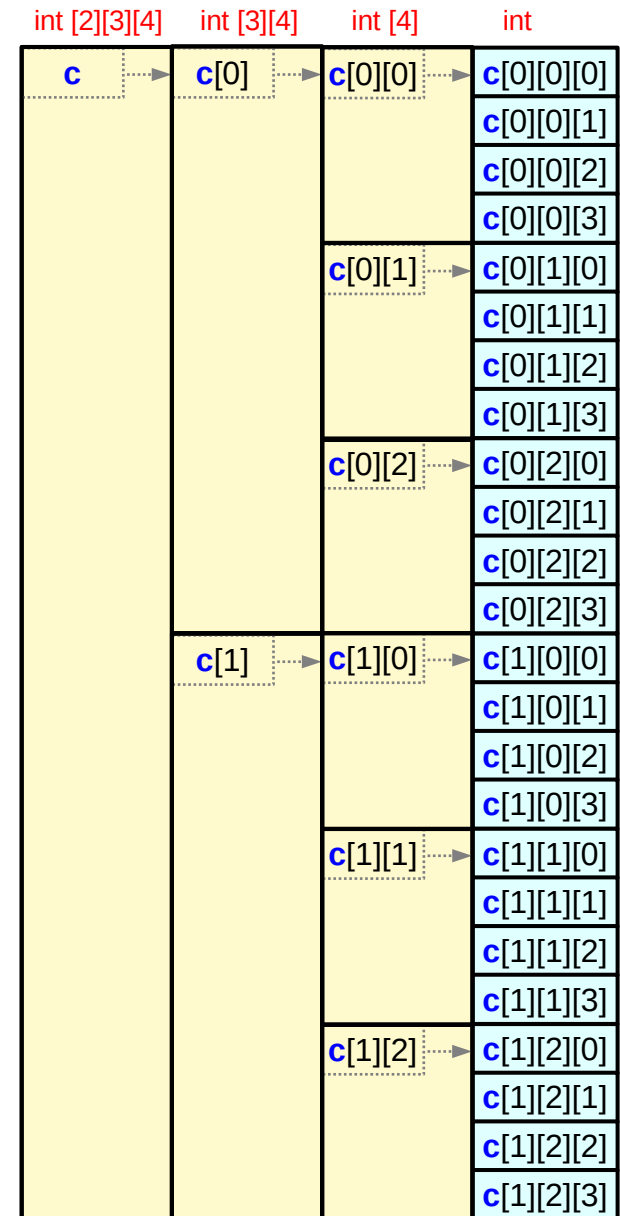

Types, sizes, and values of sub-arrays

```
int c [2][3][4] ;      static allocation
```

```
value(c) = value(c[0]) = value(c[0][0]) = &c[0][0][0]
value(c[0][1]) = &c[0][1][0]
value(c[0][2]) = &c[0][2][0]
value(c[1]) = value(c[1][0]) = &c[1][0][0]
value(c[1][1]) = &c[1][1][0]
value(c[1][2]) = &c[1][2][0]
```

```
sizeof(c)      = 2*3*4 * sizeof(int)
sizeof(c[i])   = 3*4 * sizeof(int)
sizeof(c[i][j]) = 4 * sizeof(int)
```

```
type(c)        = int [2][3][4]
                int (*)[3][4]
type(c[i])     = int [3][4]
                int (*)[4]
type(c[i][j])  = int [4]
                int (*)
```

pointers to arrays

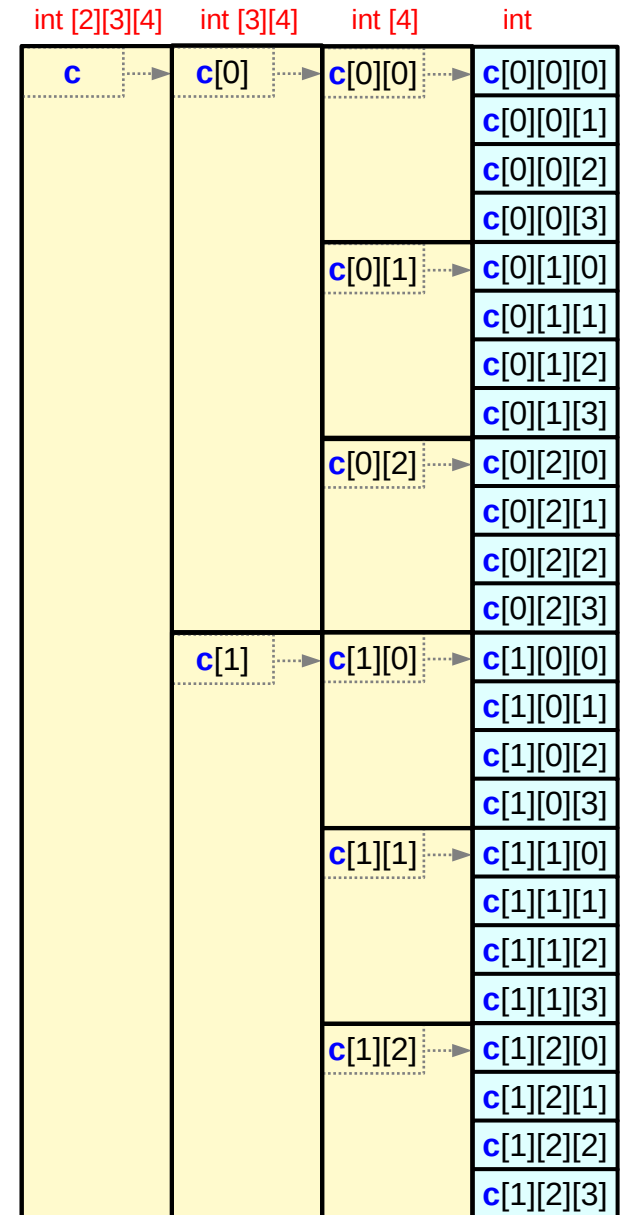

Using multi-dimensional arrays

Pointer Array Approach

– using explicit pointers

Array Pointer Approach

– using implicit pointers

Two types of 3-d array accesses

Pointer Array Approach (arrays of pointers)

Pointer Chain Type I

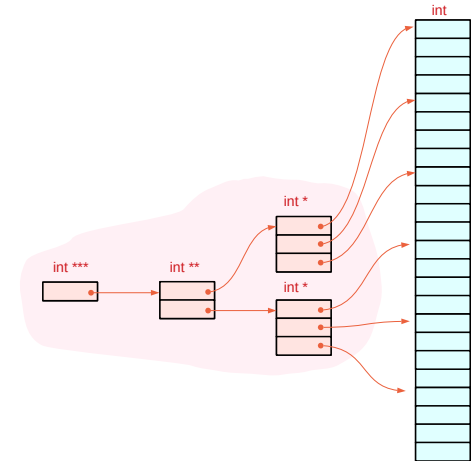
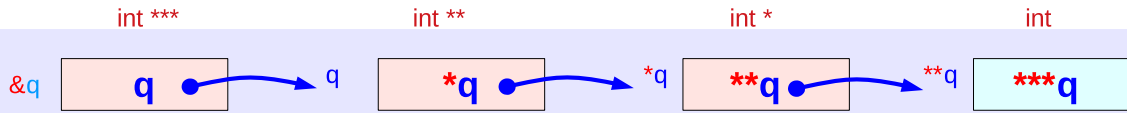

Array Pointer Approach (pointers to arrays)

Pointer Chain Type II

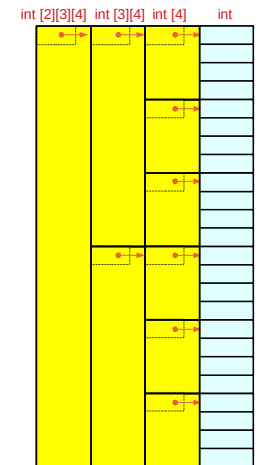
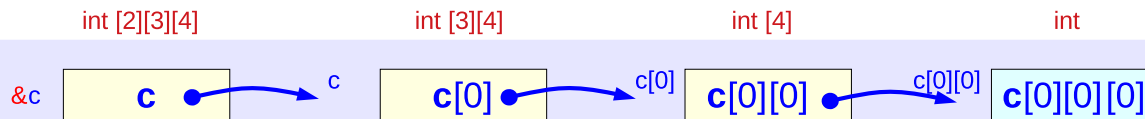

Pointer addition – **math** and **c** expressions

Accessing $c[i][j][k]$

– unified c expressions

skip i elements
of $c[i]$ from c

$(c + i)$

skip j elements
of $c[i][j]$ from $c[i]$

$(c[i] + j)$

skip k elements
of $c[i][j][k]$ from $c[i][j]$

$(c[i][j] + k)$

Pointer Array Approach

$(c + i)_{1 \cdot 4}$

$\text{sizeof}(*c) = 1 \cdot 4$

$(c[i] + j)_{1 \cdot 4}$

$\text{sizeof}(*c[i]) = 1 \cdot 4$

$(c[i][j] + k)_{1 \cdot 4}$

$\text{sizeof}(*c[i][j]) = 1 \cdot 4$

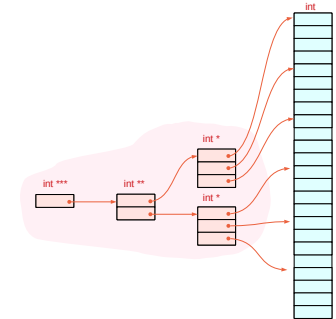

Array Pointer Approach

$(c + i)_{3 \cdot 4 \cdot 4}$

$\text{sizeof}(*c) = 3 \cdot 4 \cdot 4$

$(c[i] + j)_{4 \cdot 4}$

$\text{sizeof}(*c[i]) = 4 \cdot 4$

$(c[i][j] + k)_{1 \cdot 4}$

$\text{sizeof}(*c[i][j]) = 1 \cdot 4$

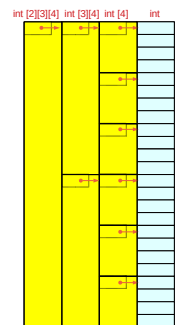

Accessing $c[i][j][k]$ element

Accessing $c[i][j][k]$

skip i elements
of $c[i]$ from c

$(c + i)$

skip j elements
of $c[i][j]$ from $c[i]$

$(c[i] + j)$

skip k elements
of $c[i][j][k]$ from $c[i][j]$

$(c[i][j] + k)$

Pointer Array Approach

skip $i * \text{sizeof}(\text{int}^{**})$
(= $i*4$) bytes from c

$(c + i)_{1.4}$

skip $j * \text{sizeof}(\text{int}^*)$
(= $j*4$) bytes from $c[i]$

$(c[i] + j)_{1.4}$

skip $k * \text{sizeof}(\text{int})$
(= $k*4$) bytes from $c[i][j]$

$(c[i][j] + k)_{1.4}$

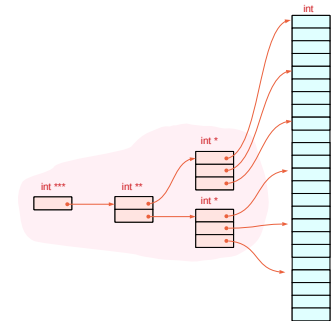

Array Pointer Approach

skip $i * \text{sizeof}(\text{int} [3][4])$
(= $i*3*4*4$) bytes from c

$(c + i)_{3.4.4}$

skip $j * \text{sizeof}(\text{int} [4])$
(= $j*4*4$) bytes from $c[i]$

$(c[i] + j)_{4.4}$

skip $k * \text{sizeof}(\text{int})$
(= $k*4$) bytes from $c[i][j]$

$(c[i][j] + k)_{1.4}$

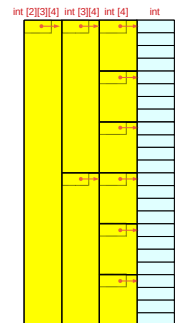

Accessing $c[i][j][k]$ – Pointer Array Approach

Pointer Array Approach

skip $i * \text{sizeof}(\text{int}^{**})$
= $i * 4$ bytes from c

$(c + i)_{1..4} \rightarrow c[i]$

skip $j * \text{sizeof}(\text{int}^*)$
= $j * 4$ bytes from $c[i]$

$(c[i] + j)_{1..4} \rightarrow c[i][j]$

skip $k * \text{sizeof}(\text{int})$
= $k * 4$ bytes from $c[i][j]$

$(c[i][j] + k)_{1..4} \rightarrow c[i][j][k]$

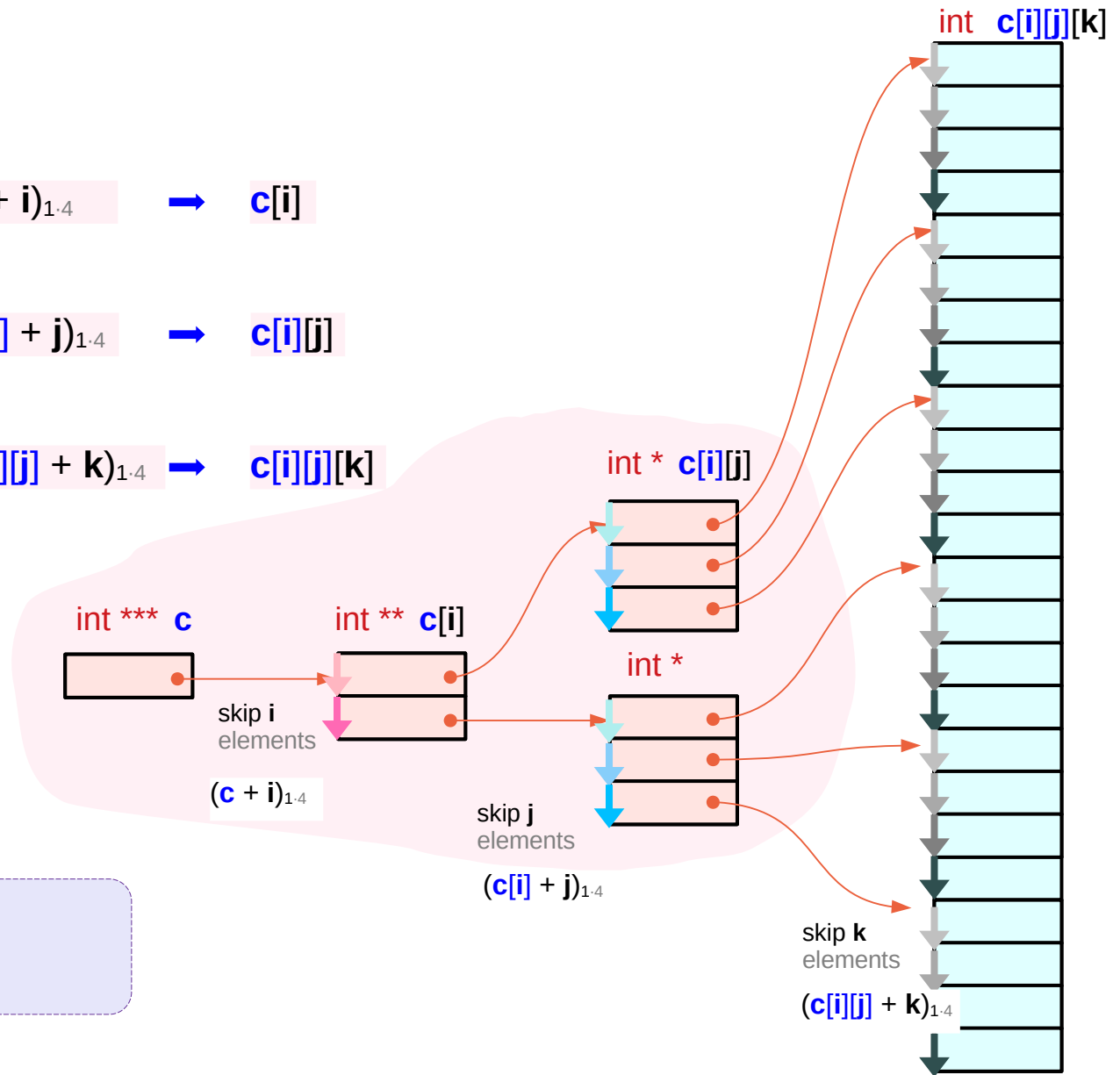

$\text{sizeof}(c[i][j][k]) = \text{sizeof}(\text{int}) = 4$
 $\text{sizeof}(c[i][j]) = \text{sizeof}(\text{int}^*) = 4$
 $\text{sizeof}(c[i]) = \text{sizeof}(\text{int}^{**}) = 4$

Accessing $c[i][j][k]$ – Array Pointer Approach

Array **Pointer** Approach

skip $i * \text{sizeof}(\text{int } [3][4])$
 $= i * 3 * 4 * 4$ bytes from c

$$(c + i)_{3 \cdot 4 \cdot 4} \rightarrow c[i]$$

skip $j * \text{sizeof}(\text{int } [4])$
 $= j * 4 * 4$ bytes from $c[i]$

$$(c[i] + j)_{4 \cdot 4} \rightarrow c[i][j]$$

skip $k * \text{sizeof}(\text{int})$
 $= k * 4$ bytes from $c[i][j]$

$$(c[i][j] + k)_{1 \cdot 4} \rightarrow c[i][j][k]$$

- *subarray partitioning*
- *address replication*

size information

$\text{sizeof}(c[i][j][k]) = \text{sizeof}(\text{int}) = 4$
 $\text{sizeof}(c[i][j]) = \text{sizeof}(\text{int } [4]) = 4 * 4$
 $\text{sizeof}(c[i]) = \text{sizeof}(\text{int } [3][4]) = 3 * 4 * 4$

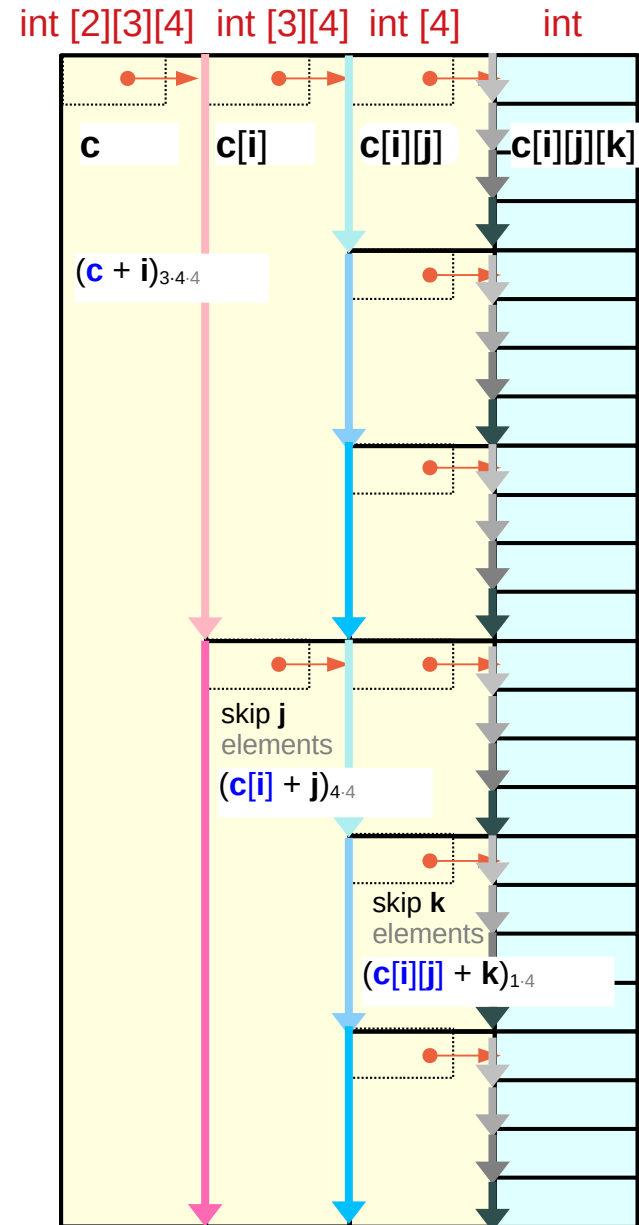

Array element address – Pointer Array Approach

equivalence relations – c expressions

$$\begin{aligned}\&c[i][j][k] &= (c[i][j] + k) \\ \&c[i][j] &= (c[i] + j) \\ \&c[i] &= (c + i)\end{aligned}$$

$$\begin{aligned}c[i][j][k] &= *(c[i][j] + k) \\ c[i][j] &= *(c[i] + j) \\ c[i] &= *(c + i)\end{aligned}$$

size information

$$\begin{aligned}\text{sizeof}(c[i][j][k]) &= \text{sizeof}(\text{int}) = 4 \\ \text{sizeof}(c[i][j]) &= \text{sizeof}(\text{int} *) = 4 \\ \text{sizeof}(c[i]) &= \text{sizeof}(\text{int} **) = 4\end{aligned}$$

address fetch – math expressions

$$\begin{aligned}\text{value}(c[i][j]) &\Rightarrow *value(c[i] + j)_{1.4} = *value(c[i] + j * 4) && \leftarrow \text{sizeof}(*c[i]) \\ \text{value}(c[i]) &\Rightarrow *value(c + i)_{1.4} = *value(c + i * 4) && \leftarrow \text{sizeof}(*c)\end{aligned}$$

address of c[i][j][k] – math expressions

$$\begin{aligned}\&c[i][j][k] &= \text{value}(c[i][j] + k)_{1.4} \\ &= \text{value}(*value(c[i] + j)_{1.4} + k * 4) \\ &= \text{value}(*value(*value(c + i)_{1.4} + j * 4) + k * 4) \\ &= \text{value}(*value(*value(c + i * 4) + j * 4) + k * 4)\end{aligned}$$
$$\begin{aligned}\leftarrow \&c[i][j][k] &\equiv (c[i][j] + k) \\ \leftarrow c[i][j] &\equiv *(c[i] + j) \\ \leftarrow c[i] &\equiv *(c + i)\end{aligned}$$

Array element address – Array Pointer Approach

equivalence relations – c expressions

$$\begin{aligned} \&c[i][j][k] &= (c[i][j] + k) \\ \&c[i][j] &= (c[i] + j) \\ \&c[i] &= (c + i) \end{aligned}$$

$$\begin{aligned} c[i][j][k] &= *(c[i][j] + k) \\ c[i][j] &= *(c[i] + j) \\ c[i] &= *(c + i) \end{aligned}$$

size information

$$\begin{aligned} \text{sizeof}(c[i][j][k]) &= \text{sizeof}(\text{int}) = 4 \\ \text{sizeof}(c[i][j]) &= \text{sizeof}(\text{int}[4]) = 4 * 4 \\ \text{sizeof}(c[i]) &= \text{sizeof}(\text{int}[3][4]) = 3 * 4 * 4 \end{aligned}$$

address replication – math expressions

$$\begin{aligned} \text{value}(c[i][j]) &= \text{value}(\&c[i][j]) &\Rightarrow \text{value}(c[i] + j)_{4 \cdot 4} &= \text{value}(c[i]) + j * 4 * 4 &\leftarrow \text{sizeof}(*c[i]) \\ \text{value}(c[i]) &= \text{value}(\&c[i]) &\Rightarrow \text{value}(c + i)_{3 \cdot 4 \cdot 4} &= \text{value}(c) + i * 3 * 4 * 4 &\leftarrow \text{sizeof}(*c) \end{aligned}$$

address of c[i][j][k] – math expressions

$$\begin{aligned} \&c[i][j][k] &= \text{value}(c[i][j] + k)_{1 \cdot 4} &\leftarrow \&c[i][j][k] \equiv c[i][j] + k \\ &= \text{value}(c[i] + j)_{4 \cdot 4} + k * 4 &\leftarrow \&c[i][j] \equiv c[i] + j &\leftarrow c[i][j] \text{ address replication} \\ &= \text{value}(c + i)_{3 \cdot 4 \cdot 4} + j * 4 * 4 + k * 4 &\leftarrow \&c[i] \equiv c + i &\leftarrow c[i] \text{ address replication} \\ &= \text{value}(c) + i * 3 * 4 * 4 + j * 4 * 4 + k * 4 \end{aligned}$$

- address replication
- combining size and address information

Accessing $c[i][j][k]$ via byte addresses

Pointer Array Approach

$$\begin{aligned}\&c[i][j][k] &= \text{value}((c[i][j] + k)_{1 \cdot 4}) &= \text{value}(c[i][j] + k * 4) \\ \&c[i][j] &= \text{value}((c[i] + j)_{1 \cdot 4}) &= \text{value}(c[i] + j * 4) \\ \&c[i] &= \text{value}((c + i)_{1 \cdot 4}) &= \text{value}(c + i * 4)\end{aligned}$$

$$\begin{aligned}c[i][j][k] &= *value(c[i][j] + k * 4) \\ &= *value(*value(c[i] + j * 4) + k * 4) \\ &= *value(*value(*value(c + i * 4) + j * 4) + k * 4)\end{aligned}$$

$$\begin{aligned}c[i][j][k] &= *value(c[i][j] + k * 4) \\ c[i][j] &= *value(c[i] + j * 4) \\ c[i] &= *value(c + i * 4)\end{aligned}$$

three memory accesses for $c[i][j][k]$

Array Pointer Approach

$$\begin{aligned}\&c[i][j][k] &= \text{value}((c[i][j] + k)_{1 \cdot 4}) &= \text{value}(c[i][j] + k * 4) \\ \&c[i][j] &= \text{value}((c[i] + j)_{4 \cdot 4}) &= \text{value}(c[i] + j * 4 * 4) \\ \&c[i] &= \text{value}((c + i)_{3 \cdot 4 \cdot 4}) &= \text{value}(c + i * 3 * 4 * 4)\end{aligned}$$

$$\begin{aligned}c[i][j][k] &= *value(c[i][j] + k * 4) \\ &= *value(*value(c[i] + j * 4 * 4) + k * 4) \\ &= *value(*value(*value(c + i * 3 * 4 * 4) + j * 4 * 4) + k * 4) \\ &= *value(value(value(c + i * 3 * 4 * 4) + j * 4 * 4) + k * 4) \\ &= *value(c + i * 3 * 4 * 4 + j * 4 * 4 + k * 4)\end{aligned}$$

$$\begin{aligned}c[i][j][k] &= *value(c[i][j] + k * 4) \\ c[i][j] &= *value(c[i] + j * 4 * 4) \\ c[i] &= *value(c + i * 3 * 4 * 4)\end{aligned}$$

address replication

single memory access for $c[i][j][k]$

Equivalence relations in $c[i][j][k]$

Pointer Array Approach

$$\begin{aligned} \&c[i][j][k] &= \text{value}(c[i][j] + k * 4) &= \text{value}(c[i][j]) + k * 4 \\ \&c[i][j] &= \text{value}(c[i] + j * 4) &= \text{value}(c[i]) + j * 4 \\ \&c[i] &= \text{value}(c + i * 4) &= \text{value}(c) + i * 4 \end{aligned}$$

different semantics !
be careful in mixed c and math expressions

$$\begin{aligned} c[i][j][k] &\neq *value(c[i][j]) + k * 4 \\ c[i][j] &\neq *value(c[i]) + j * 4 \\ c[i] &\neq *value(c) + i * 4 \end{aligned}$$

$$\begin{aligned} c[i][j][k] &= *value(c[i][j] + k * 4) \\ c[i][j] &= *value(c[i] + j * 4) \\ c[i] &= *value(c + i * 4) \end{aligned}$$

Array Pointer Approach

$$\begin{aligned} \&c[i][j][k] &= \text{value}(c[i][j] + k)_{1 \cdot 4} &= \text{value}(c[i][j]) + k * 4 \\ \&c[i][j] &= \text{value}(c[i] + j)_{4 \cdot 4} &= \text{value}(c[i]) + j * 4 * 4 \\ \&c[i] &= \text{value}(c + i)_{3 \cdot 4 \cdot 4} &= \text{value}(c) + i * 3 * 4 * 4 \end{aligned}$$

different semantics !
be careful in mixed c and math expressions

$$\begin{aligned} c[i][j][k] &\neq *value(c[i][j]) + k * 4 \\ c[i][j] &\neq *value(c[i]) + j * 4 * 4 \\ c[i] &\neq *value(c) + i * 3 * 4 * 4 \end{aligned}$$

$$\begin{aligned} c[i][j][k] &= *value(c[i][j] + k * 4) \\ c[i][j] &= *value(c[i] + j * 4 * 4) \\ c[i] &= *value(c + i * 3 * 4 * 4) \end{aligned}$$

Accessing $c[i][j][k]$

```
int c [L][M][N] ;
```

```
c[i]      ≡ *(c + i)
c[i][j]   ≡ *(c[i] + j)
c[i][j][k] ≡ *(c[i][j] + k)
```

```
&c[i]     ≡ (c + i)
&c[i][j]  ≡ (c[i] + j)
&c[i][j][k] ≡ (c[i][j] + k)
```

equivalence relations

multiple indirections

address replications

$c[i]$	\equiv	$*(c+i)$	\equiv	$*(c+i)$	\equiv	$(c+i)$
$c[i][j]$	\equiv	$*(c[i]+j)$	\equiv	$*(*(c+i)+j)$	\equiv	$((c+i)+j)$
$c[i][j][k]$	\equiv	$*(c[i][j]+k)$	\equiv	$*(*(*(c+i)+j)+k)$	\equiv	$((((c+i)+j)+k)$ $\rightarrow *(c+i+j+k)$

Pointer Array Approach

Array Pointer Approach

Conditions for $c[i][j][k]$

Equivalence relations in $c[i][j][k]$

$$\begin{aligned}c[i][j][k] &\equiv *(c[i][j] + k) \\ *(c[i][j] + k) &\equiv *(*c[i] + j) + k \\ *(*c[i] + j) + k &\equiv *(*(*c + i) + j) + k\end{aligned}$$

$$\begin{aligned}c[i][j][k] &\equiv (c[i][j] + k) \\ c[i][j] &\equiv (c[i] + j) \\ c[i] &\equiv (c + i)\end{aligned}$$

Pointer Array Approach

$$\begin{aligned}c[i][j][k] &\equiv (c[i][j] + k) \\ c[i][j] &\equiv (c[i] + j) \\ c[i] &\equiv (c + i)\end{aligned}$$



contiguous 4 $c[i][j][k]$'s $4 * (\text{int } 4 \text{ bytes})$
contiguous 3 $c[i][j]$'s $3 * (\text{int } * 4 \text{ or } 8 \text{ bytes})$
contiguous 2 $c[i]$'s $2 * (\text{int } ** 4 \text{ or } 8 \text{ bytes})$

Array Pointer Approach

$$\begin{aligned}c[i][j][k] &\equiv (c[i][j] + k) \\ c[i][j] &\equiv (c[i] + j) \\ c[i] &\equiv (c + i)\end{aligned}$$



contiguous 4 $c[i][j][k]$'s $4 * (\text{int } 4 \text{ bytes})$
contiguous 3 $c[i][j]$'s $3 * (\text{int } [4] 4*4 \text{ bytes})$
contiguous 2 $c[i]$'s $2 * (\text{int } [3][4] 3*4*4 \text{ bytes})$

Skipping leaf elements

Continuity Constraints

$$\begin{aligned}c[i][j][k] &\equiv (c[i][j] + k) \\c[i][j] &\equiv (c[i] + j) \\c[i] &\equiv (c + i)\end{aligned}$$



contiguous $c[i][j][k]$ over $k=0:3$
contiguous $c[i][j]$ over $j=0:2$
contiguous $c[i]$ over $i=0:1$

Pointer Array Approach

$(c[i][j] + k)_{1..4}$ skip $k * 4$ bytes from $c[i][j]$
 $(c[i] + j)_{1..4}$ skip $j * 4$ bytes from $c[i]$
 $(c + i)_{1..4}$ skip $i * 4$ bytes from c

k leaf elements $k * 4$ bytes
 $j * 4$ leaf elements $j * 4 * 4$ bytes
 $i * 3 * 4$ leaf elements $i * 3 * 4 * 4$ bytes

Array Pointer Approach

$(c[i][j] + k)_{1..4}$ skip $k * 4$ bytes from $c[i][j]$
 $(c[i] + j)_{4..4}$ skip $j * 4 * 4$ bytes from $c[i]$
 $(c + i)_{3..4}$ skip $i * 3 * 4 * 4$ bytes from c

k leaf elements $k * 4$ bytes
 $j * 4$ leaf elements $j * 4 * 4$ bytes
 $i * 3 * 4$ leaf elements $i * 3 * 4 * 4$ bytes

3-d Access `c[i][j][k]`

Accessing $c[i][j][k]$ – Conditions

General requirements

```
c[i][j][k] = *(c[i][j]+k)
c[i][j]    = *(c[i]+j)
c[i]       = *(c+i)
```

```
&c[i][j][k] = c[i][j]+k
&c[i][j]    = c[i]+j
&c[i]       = c+i
```

```
&c[i][j][0] = c[i][j]
&c[i][0]    = c[i]
&c[0]       = c
```

Pointer array approach

```
int** c[2];
int*  b[2*3];
int   c[2*3*4];
```

```
c[i][j][k] :: int
c[i][j]    :: int *
c[i]       :: int **
```

```
c[i] ← &b[i*3]
b[j] ← &a[j*4]
```

Hierarchical Pointer Arrays

Array pointer approach

```
int c[2][3][4];
```

```
c[i][j][k] :: int
c[i][j]    :: int [4]
c[i]       :: int [3][4]
```

```
c ← &c[0][0][0]
c[i] ← &c[i][0][0]
c[i][j] ← &c[i][j][0]
```

Virtual Array Pointers

Accessing $c[i][j][k]$ – Pointer Array Approach (1)

$c[i]$ ← $\&b[i*3]$
 $b[j]$ ← $\&a[j*4]$

$[2][3][4]$



$c[i] \equiv *(c + i)$
 $c[i][j] \equiv *(c[i] + j)$
 $c[i][j][k] \equiv *(c[i][j] + k)$

$\&c[i] \equiv (c + i)$
 $\&c[i][j] \equiv (c[i] + j)$
 $\&c[i][j][k] \equiv (c[i][j] + k)$

$b[j] \equiv (a + j*4)$

$*(b[j]+k) = *(a+j*4+k);$

$b[j][k] \equiv a[j*4+k]$

$c[i] \equiv (b + i*3)$

$*(c[i]+j) = *(b+i*3+j);$

$c[i][j] \equiv b[i*3+j]$

$*(c[i][j]+k) = *(b[i*3+j]+k);$



$c[i][j] \equiv (a + (i*3+j)*4)$

$*(c[i][j]+k) = *(a+(i*3+j)*4+k);$

```
int** c[2];  
int* b[2*3];  
int a[2*3*4];
```

$c[i][j][k] \equiv a[(i*3+j)*4+k]$

Accessing `c[i][j][k]` – Pointer Array Approach (2)

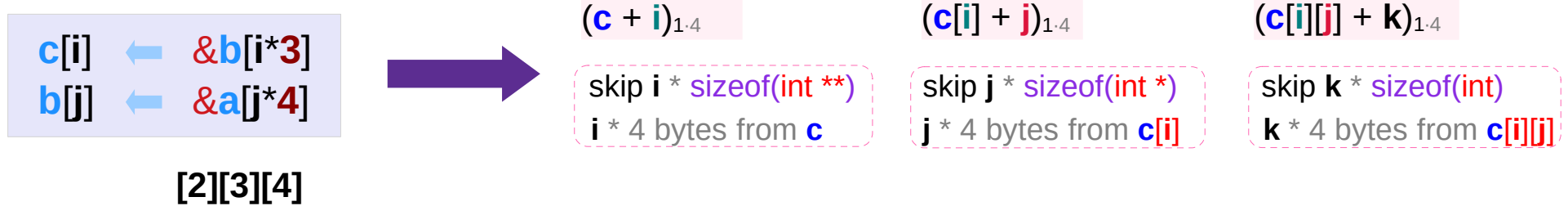

`b[j] ≡ (a+j*4)`
 skip `j` elements of `b` skip `j*4` elements of `a`

`c[i] ≡ (b+i*3)`
 skip `i` elements of `c` skip `i*3` elements of `b`

`b[j][k] ≡ a[j*4+k]`
 skip `j` elements of `b` + skip `k` elements of `a`

`c[i][j] ≡ b[i*3+j]`
 skip `i` elements of `c` + skip `j` elements of `b`

`c[i][j] ≡ (a+(i*3+j)*4)`
 skip `i*3*4` elements of `a` + skip `j*4` elements of `a`

```

int** c[2];
int* b[2*3];
int a[2*3*4];
    
```

`c[i][j][k] ≡ a[(i*3+j)*4+k]`
 skip `i*3*4` elements of `a` + skip `j*4` elements of `a` + skip `k` elements of `a`

Accessing $c[i][j][k]$ – Array Pointer Approach (1)

c	←	$\&c[0][0][0]$
$c[i]$	←	$\&c[i][0][0]$
$c[i][j]$	←	$\&c[i][j][0]$



$c[i]$	\equiv	$*(c + i)$
$c[i][j]$	\equiv	$*(c[i] + j)$
$c[i][j][k]$	\equiv	$*(c[i][j] + k)$

$\&c[i]$	\equiv	$(c + i)$
$\&c[i][j]$	\equiv	$(c[i] + j)$
$\&c[i][j][k]$	\equiv	$(c[i][j] + k)$

[2][3][4]

$value(c)$	$=$	$\&c[0][0][0]$
$value(c[i])$	$=$	$\&c[i][0][0]$
$value(c[i][j])$	$=$	$\&c[i][j][0]$
$value(c[i][j][k])$	$=$	$\&c[i][j][k]$



$sizeof(c)$	$=$	$2*3*4*sizeof(int)$
$sizeof(c[i])$	$=$	$3*4*sizeof(int)$
$sizeof(c[i][j])$	$=$	$4*sizeof(int)$
$sizeof(c[i][j][k])$	$=$	$sizeof(int)$



$value(c[i])$	$=$	$\&c[0][0][0] + i * 3*4*sizeof(int)$
$value(c[i][j])$	$=$	$\&c[i][0][0] + j * 4*sizeof(int)$
$value(c[i][j][k])$	$=$	$\&c[i][j][0] + k * sizeof(int)$



$\&c[i]$	$=$	$value(c) + i * sizeof(*c)$
$\&c[i][j]$	$=$	$value(c[i]) + j * sizeof(*c[i])$
$\&c[i][j][k]$	$=$	$value(c[i][j]) + k * sizeof(*c[i][j])$



$c[i]$	\equiv	$*(c + i)$
$c[i][j]$	\equiv	$*(c[i] + j)$
$c[i][j][k]$	\equiv	$*(c[i][j] + k)$

Accessing $c[i][j][k]$ – Array Pointer Approach (2)

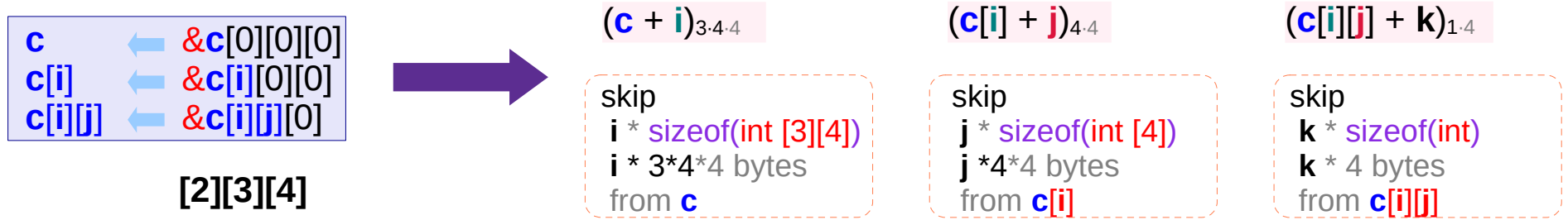

$$\text{value}(c[i]) = \&c[i][0][0]$$

$$\text{value}(c[i][j]) = \&c[i][j][0]$$

$$\text{value}(c[i][j][k]) = \&c[i][j][k]$$

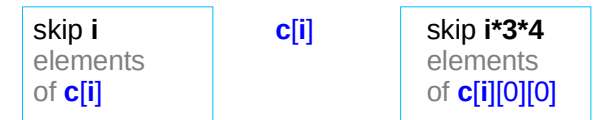
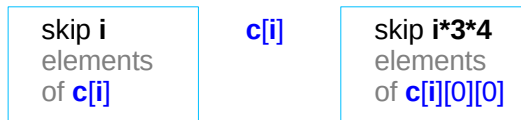
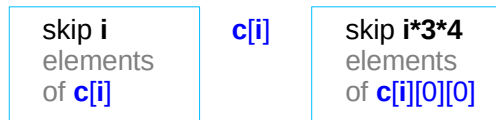

Pointer Chain Types

Pointer Chain Types

Pointer Chain Type I

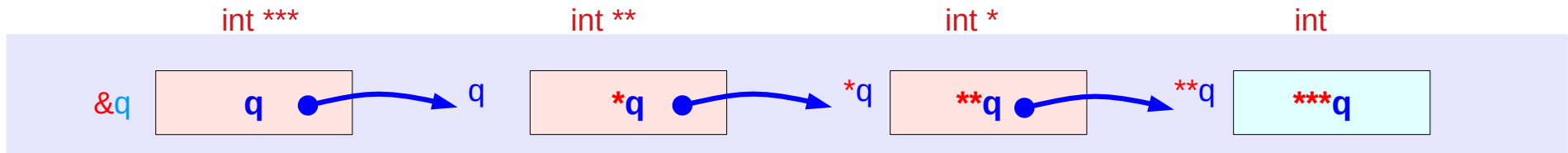

- **Pointer Array Approach** (index operations are handled by a user)

Pointer Chain Type II

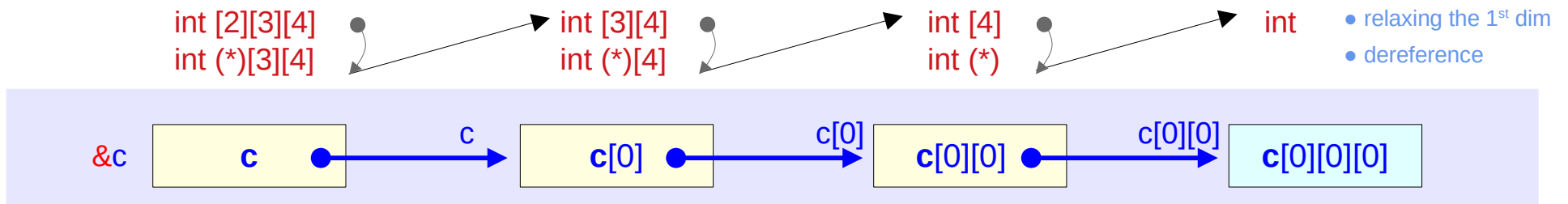

- **Array Pointer Approach** (index operations are handled by a compiler)

Examples of two step dereferencing in type II

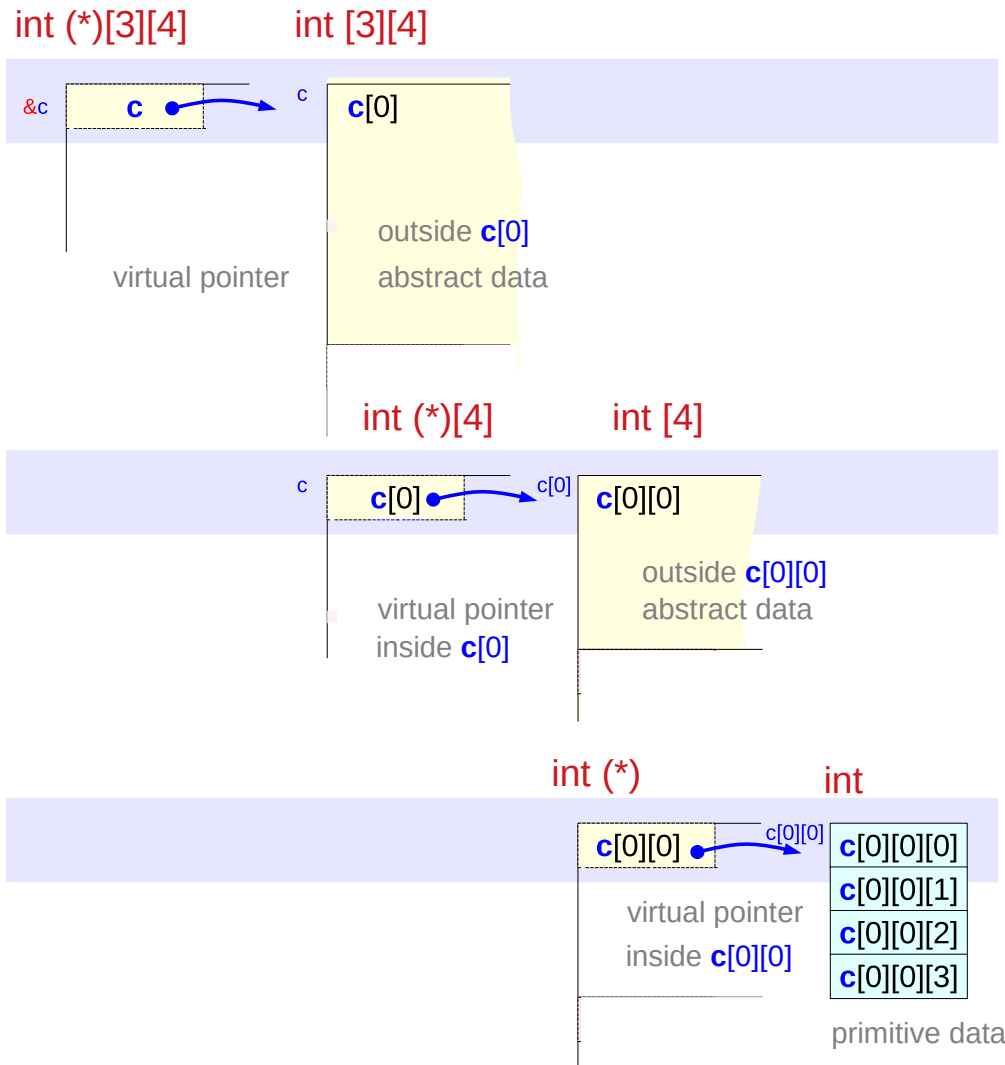

int [3][4]
c[0]
 abstract data

relaxing
 the 1st dim

sizeof(c[0]) =
3 * sizeof(c[0][0])

within an array c[0]
 of int[3][4] type, c[0]
 can be relaxed to
 a pointer of
 int (*)[4] type

c[0][0] = *(c[0]+0)_{4,4}
 Math Expression

int (*)[4]
c[0]
 virtual pointer

int [4]
c[0][0]
 abstract data
 relaxing
 the 1st dim

sizeof(c[0][0]) =
4 * sizeof(c[0][0][0])

within an array c[0][0]
 of int [4] type, c[0][0]
 can be relaxed to
 a pointer of
 int (*) type

c[0][0][0] = *(c[0][0]+0)_{1,4}
 Math Expression

int (*)
c[0][0]
 virtual pointer

int
c[0][0][0]
 abstract data

Pointer Chains in Type II (1)

Pointer Chain Type II

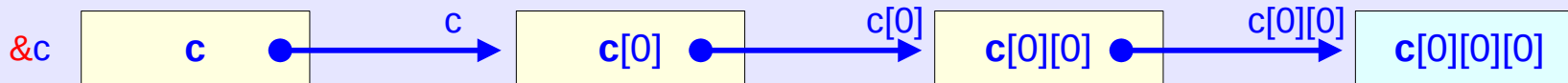
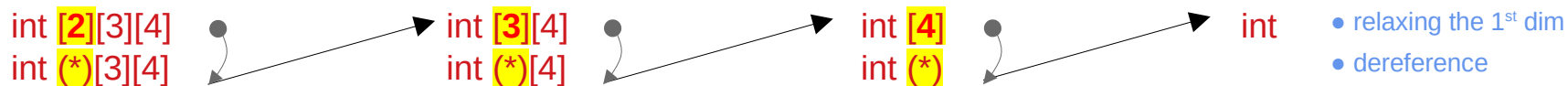

c points to **2** elements
 $\text{sizeof}(c) = 2 * \text{sizeof}(c[i])$

$c[i]$ $i=0,1$
 $*(c+i)_{3,4,4}$

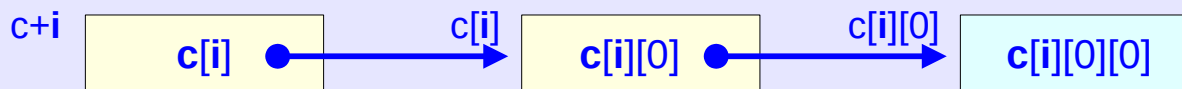

$c[i]$ points to **3** elements
 $\text{sizeof}(c[i]) = 3 * \text{sizeof}(c[i][j])$

$c[i][j]$ $j=0,1,2$
 $*(c[i]+j)_{4,4}$

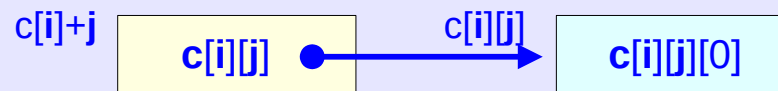

$c[i][j]$ points to **4** elements
 $\text{sizeof}(c[i][j]) = 4 * \text{sizeof}(c[i][j][k])$

$c[i][j][k]$ $k=0,1,2,3$
 $*(c[i][j]+k)_{1,4}$

Pointer Chains in Type II (2)

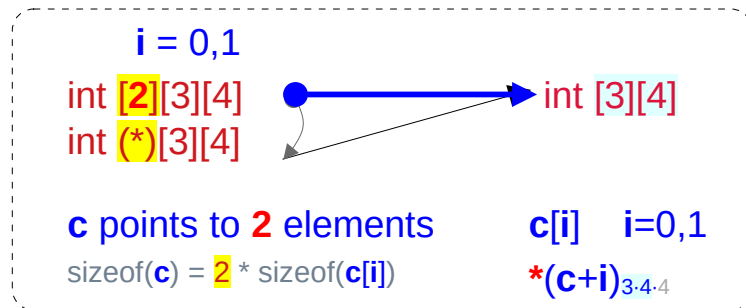

- relaxing the 1st dim
- dereference

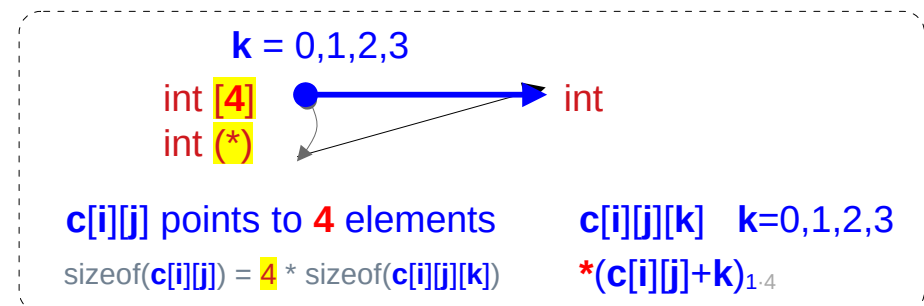
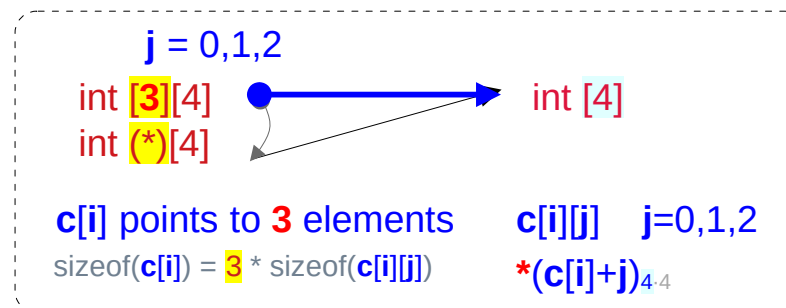

Pointer Chain Type I – * and & operators

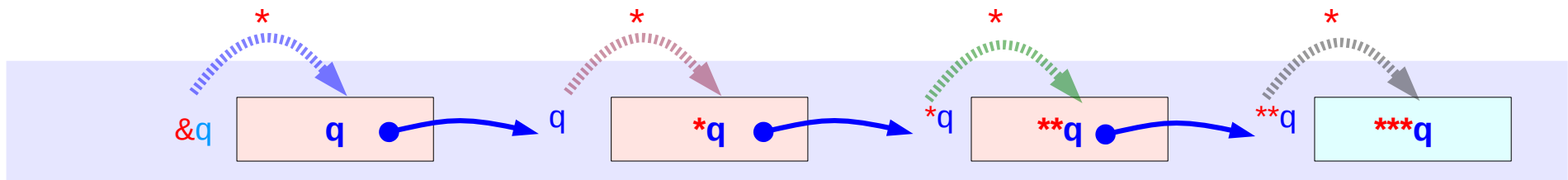

$$*(\&q) \equiv q$$

C expression $*(\&q)$ equals to the variable q

$$*(q) \equiv *q$$

C expression $*(q)$ equals to the variable q

$$*(*q) \equiv **q$$

C expression $*(q)$ equals to the variable $*q$

$$**(q) \equiv ***q$$

C expression $**(q)$ equals to the variable $***q$

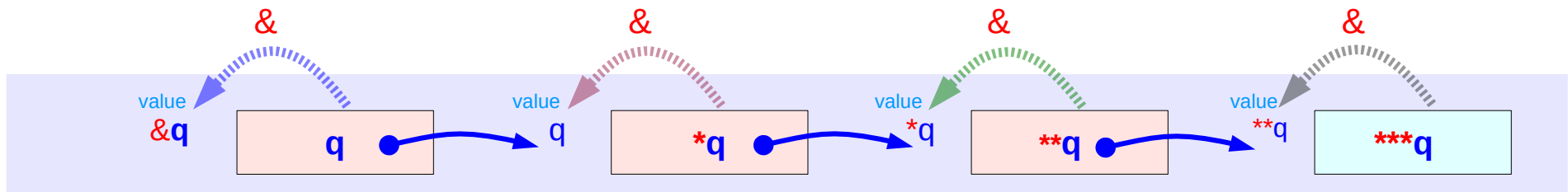

$$\&q \equiv \text{value}(\&q)$$

C expression $\&q$ equals to $\text{value}(\&q)$ which is the address value of a variable q

$$\&(*q) \equiv \text{value}(q)$$

C expression $\&(*q)$ equals to $\text{value}(q)$ which is the address value of a variable $*q$

$$\&(**q) \equiv \text{value}(*q)$$

C expression $\&(**q)$ equals to $\text{value}(*q)$ which is the address value of a variable $**q$

$$\&(**q) \equiv \text{value}(**q)$$

C expression $\&(**q)$ equals to $\text{value}(**q)$ which is the address value of a variable $***q$

Pointer Chain Type II – * and & operators

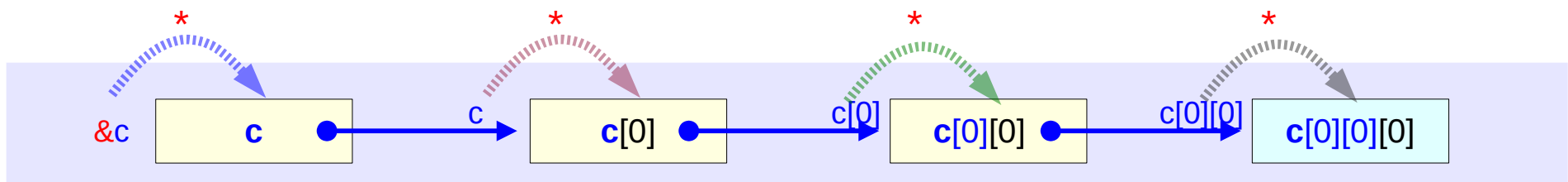

$$*(\&c) \equiv c$$

$$*(c) \equiv c[0]$$

$$*(c[0]) \equiv c[0][0]$$

$$*(c[0][0]) \equiv c[0][0][0]$$

(int (*)[3][4]) **c** can be viewed as a pointer to (int [3][4]) **c[0]**

(int (*)[4]) **c[0]** can be viewed as a pointer to (int [4]) **c[0][0]**

(int (*) **c[0][0]** can be viewed as a pointer to (int) **c[0][0][0]**

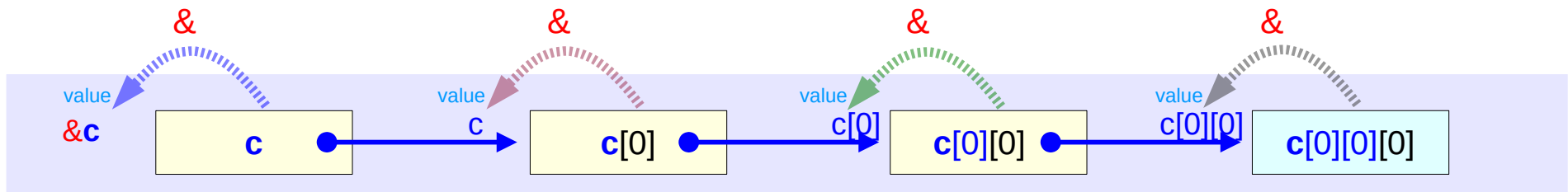

$$\&c \equiv \text{value}(\&c)$$

$$\&(c[0]) \equiv \text{value}(c)$$

$$\&(c[0][0]) \equiv \text{value}(c[0])$$

$$\&(c[0][0][0]) \equiv \text{value}(c[0][0])$$

(int (*)[3][4]) **c** has the address value of (int [3][4]) **c[0]**

(int (*)[4]) **c[0]** has the address value of (int [4]) **c[0][0]**

(int (*) **c[0][0]** has the address value of (int) **c[0][0][0]**

Pointer Chain Type I – skipping elements

Pointer Chain Type I

multiple indirection

size: pointer size

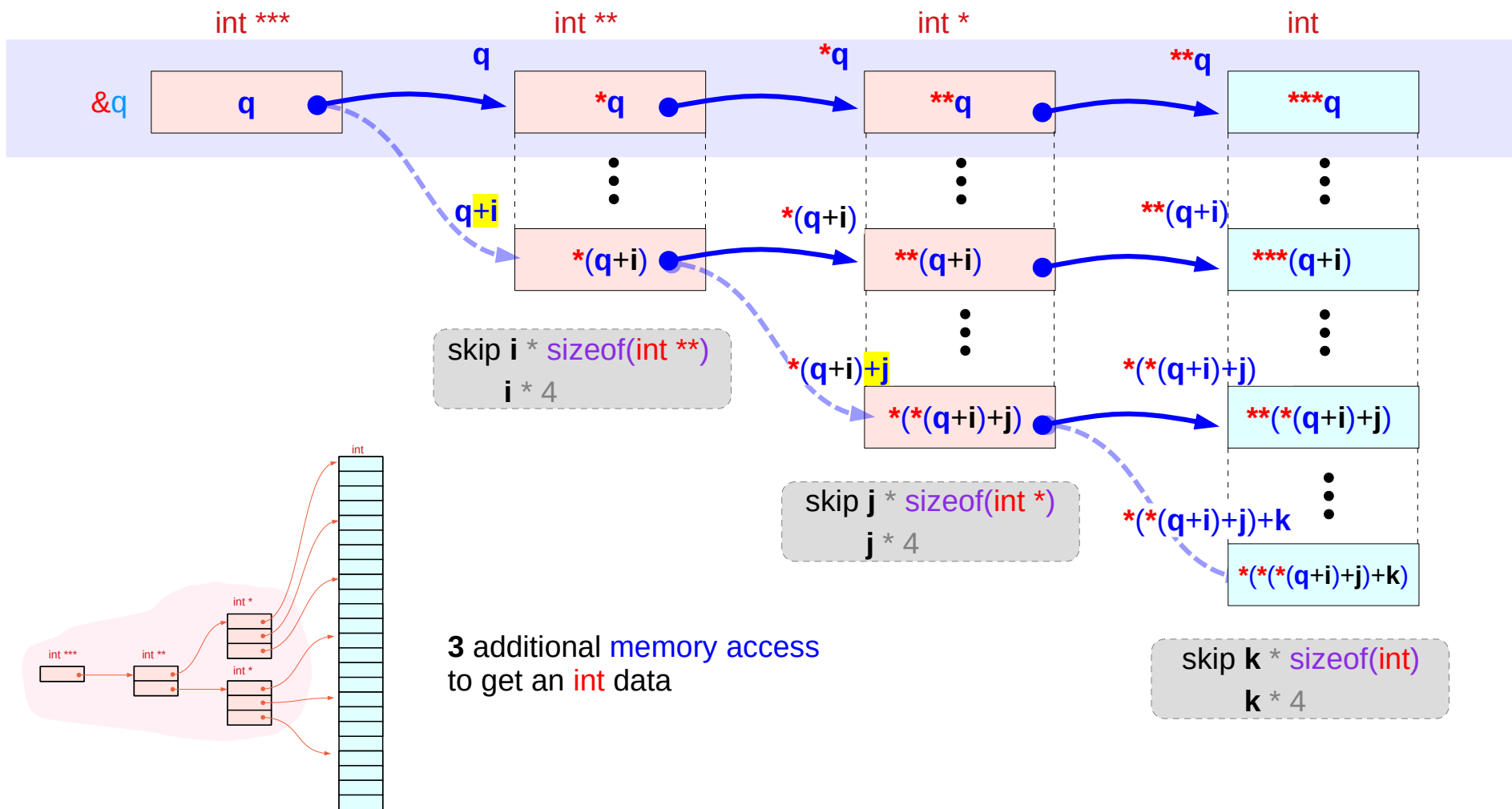

3 additional memory access
to get an int data

Pointer Chain Type II – skipping elements

Pointer Chain Type II

virtual pointer to an abstract data

size: abstract data size

int [2][3][4]
int (*)[3][4]

int [3][4]
int (*)[4]

int [4]
int (*)

int

- relaxing the 1st dim
- dereference

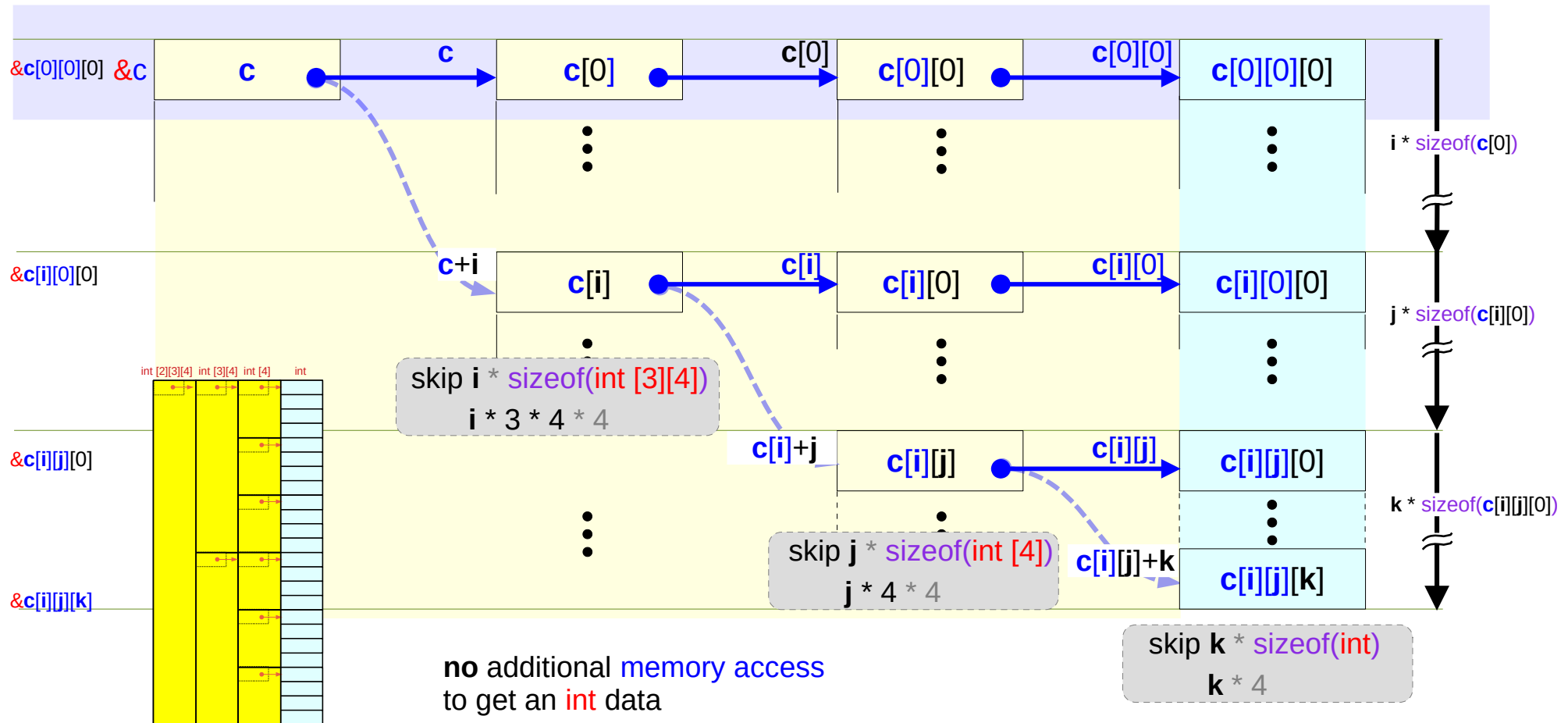

Two step dereferencing in type II (1) – without skipping

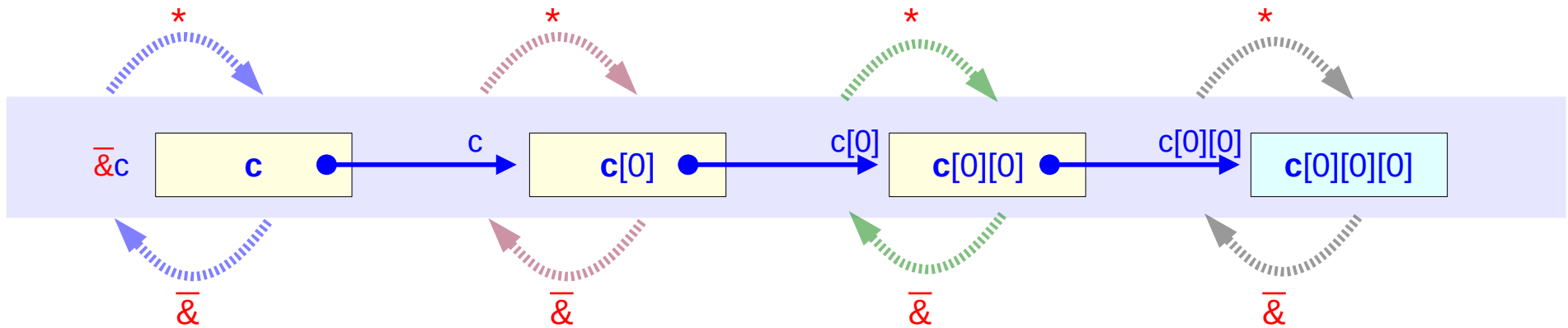
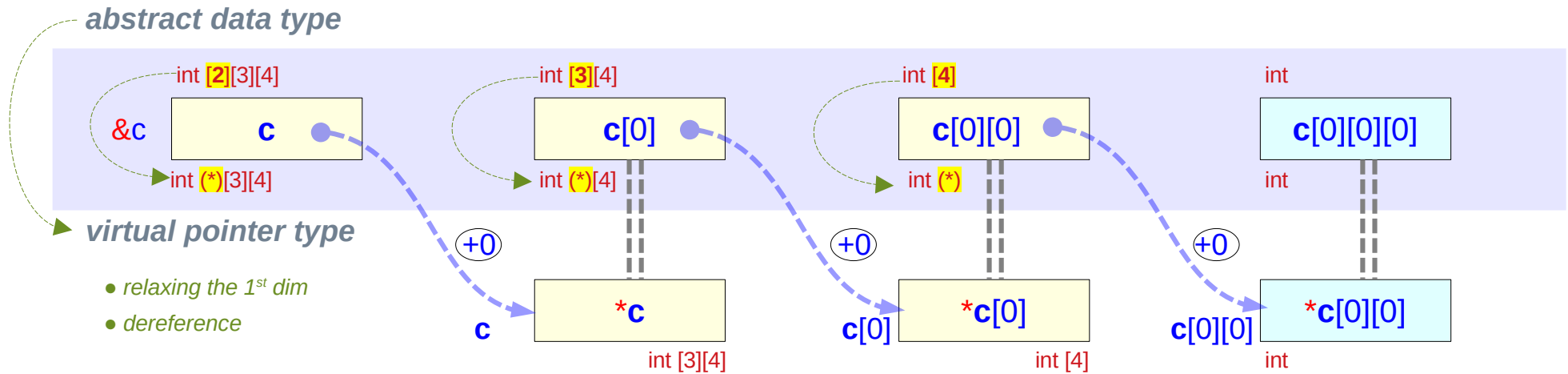

$\bar{\&}$: mathematical & operator

Two step deferencing in type II (2) – with skipping

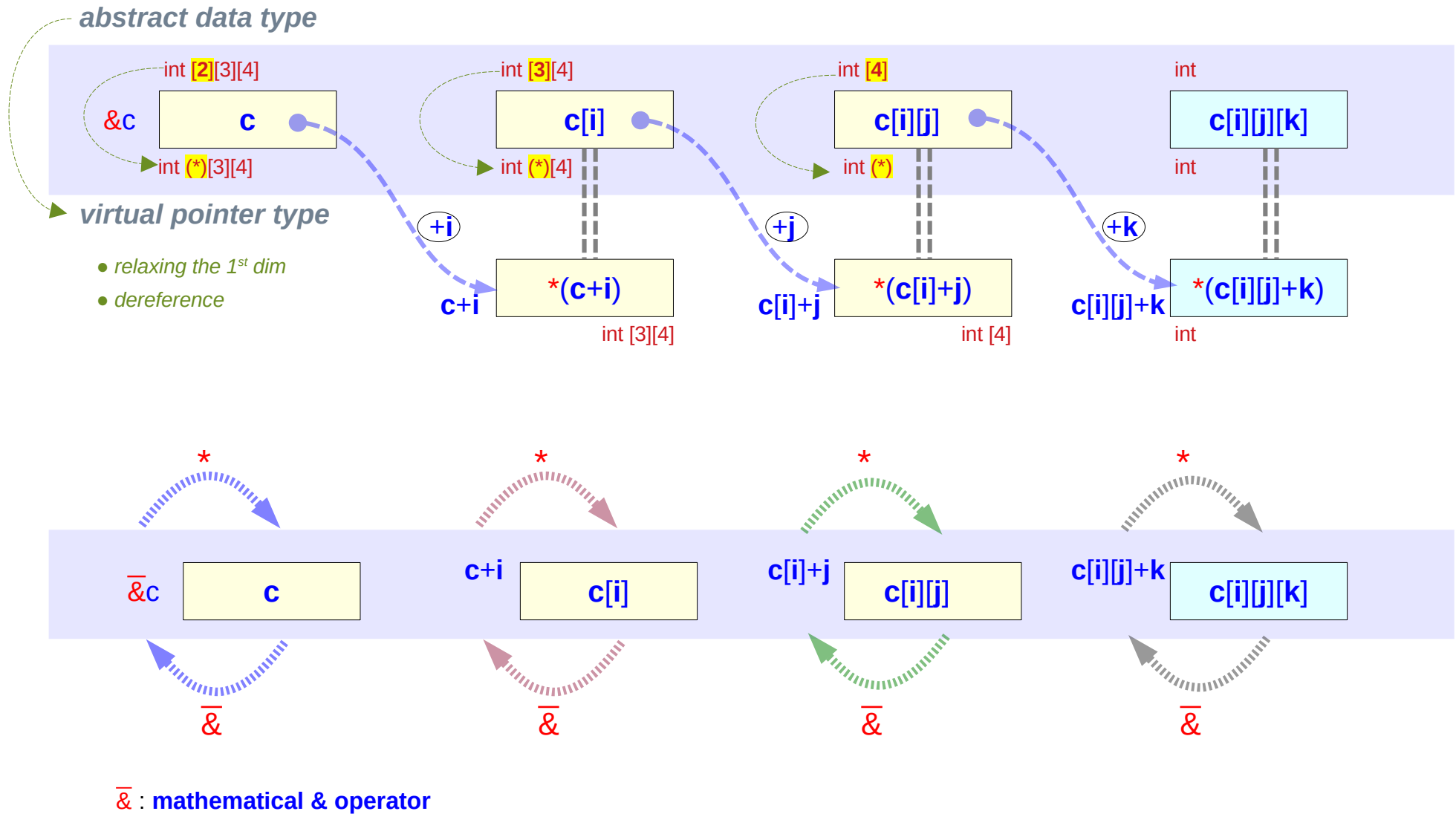

Two step deferencing in type II (3)

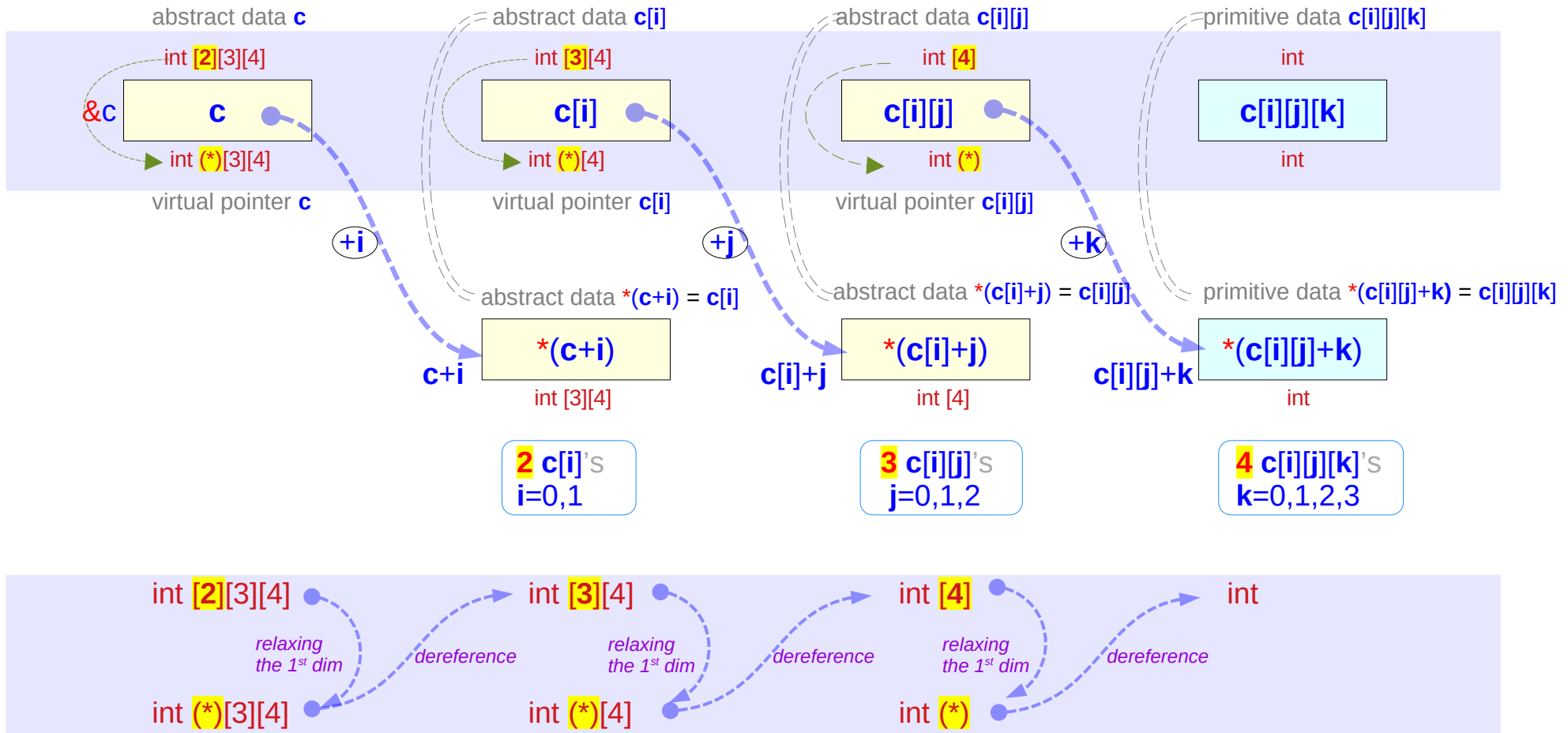

Skipping elements

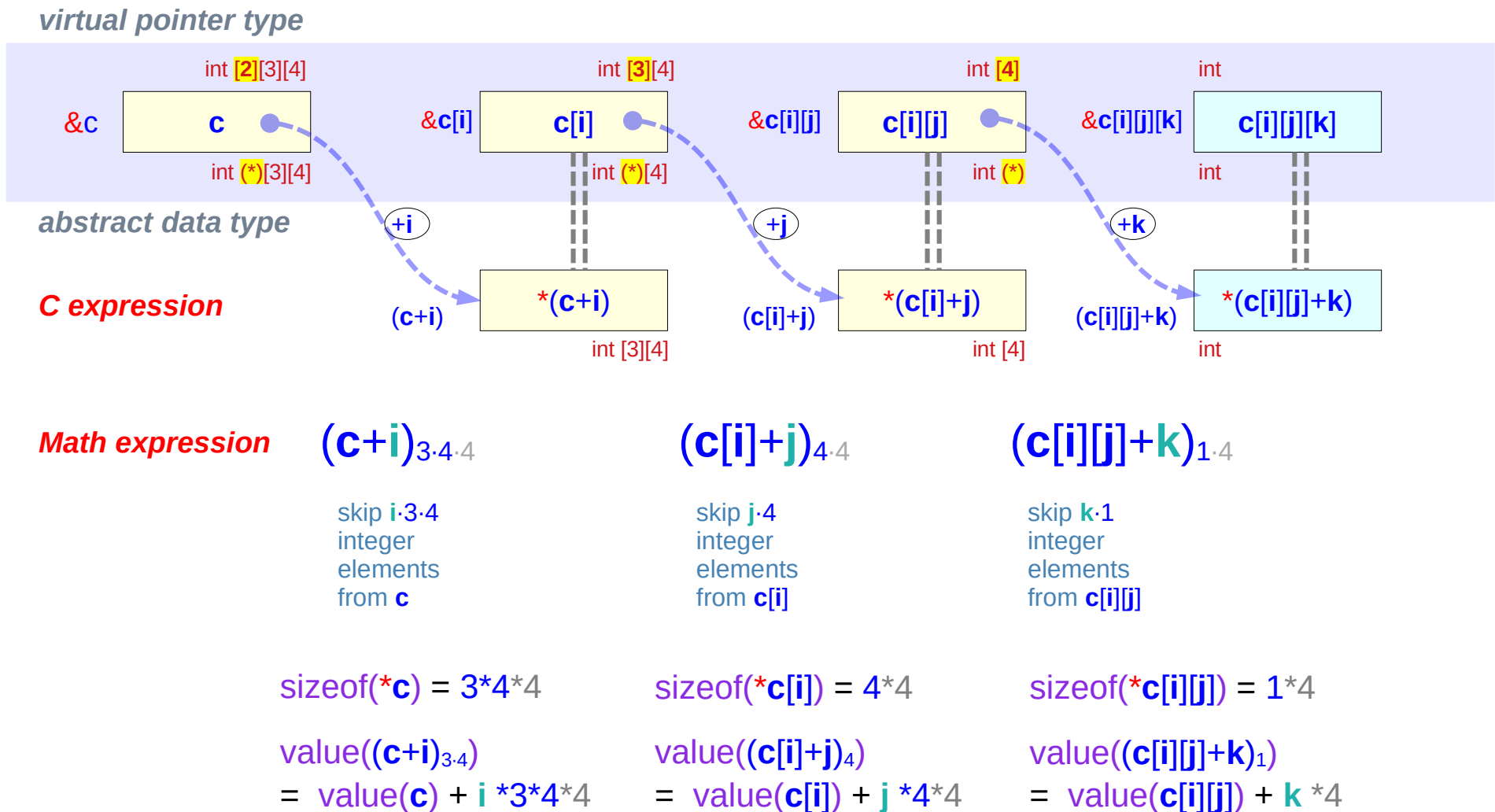

Address replication

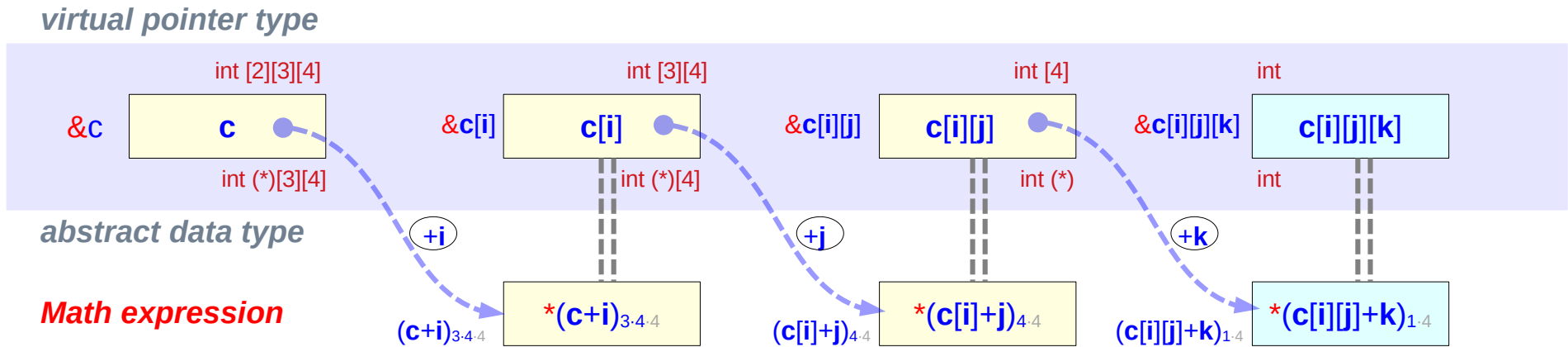

equivalence relations – c expressions

$$\begin{aligned} \mathbf{c[i][j][k]} &= \mathbf{*(c[i][j] + k)} \\ \mathbf{c[i][j]} &= \mathbf{*(c[i] + j)} \\ \mathbf{c[i]} &= \mathbf{*(c + i)} \end{aligned}$$

$$\begin{aligned} \mathbf{\&c[i][j][k]} &= \mathbf{(c[i][j] + k)} \\ \mathbf{\&c[i][j]} &= \mathbf{(c[i] + j)} \\ \mathbf{\&c[i]} &= \mathbf{(c + i)} \end{aligned}$$

address replication – math expressions

$$\begin{aligned} \mathbf{value(c[i][j])} &= \mathbf{value((c[i] + j)_{4-4})} \\ \mathbf{value(c[i])} &= \mathbf{value((c + i)_{3-4-4})} \end{aligned}$$

Applying address replication

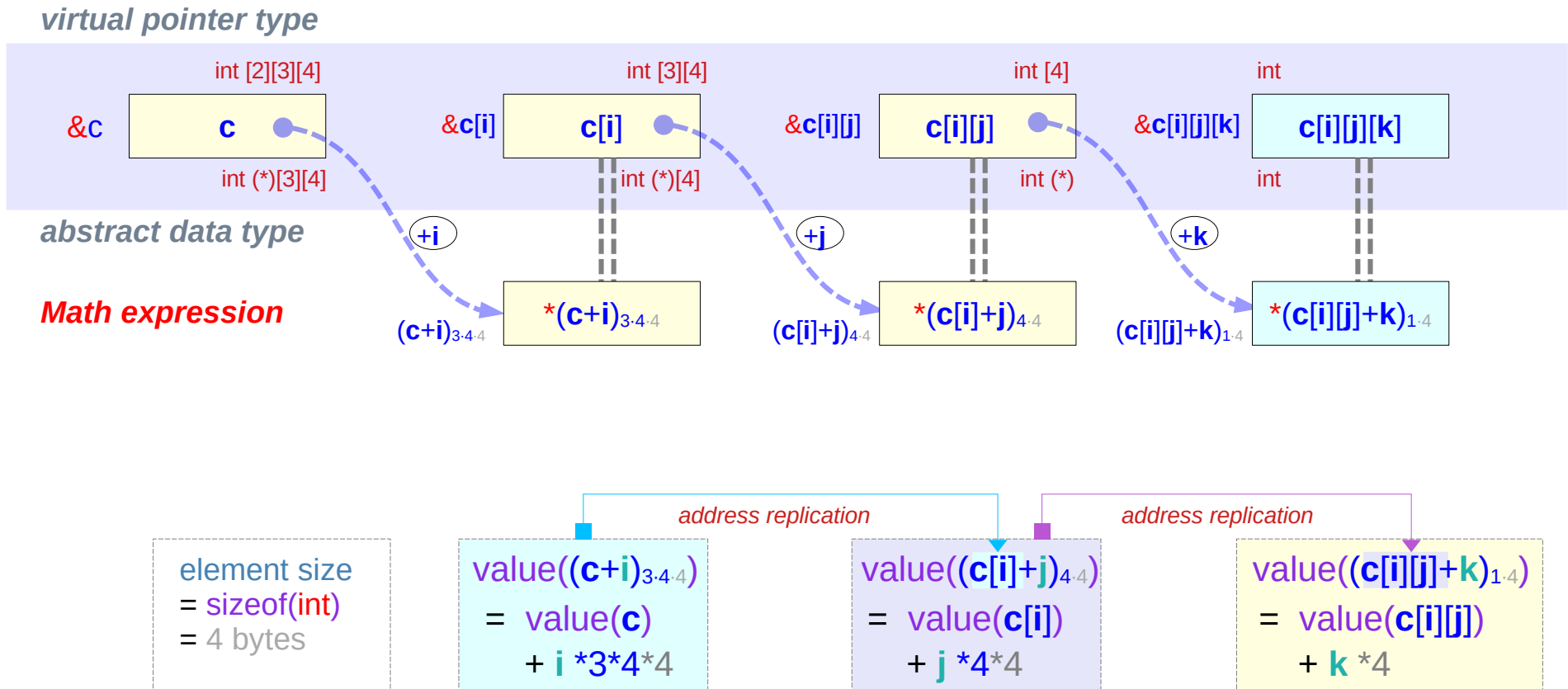

const pointers

const type, const pointer type (1)

```
const int * p;
```

```
int * const q ;
```

```
const int * const r ;
```



```
int * p;
```

```
int * q ;
```

```
int * r ;
```



constant *must not be changed*
must not be updated
must not be written
must not be assigned

const type, const pointer type (2)

const int * p ;

constant integer

int * **const q** ;

constant pointer

const int * **const r** ;

constant integer

const int * **const r** ;

constant pointer

const []

group with the following

*p : constant integer value

q : constant (int *) pointer

*r : constant integer value

r : constant (int *) pointer

const type, const pointer type (3)

`const int *p;`

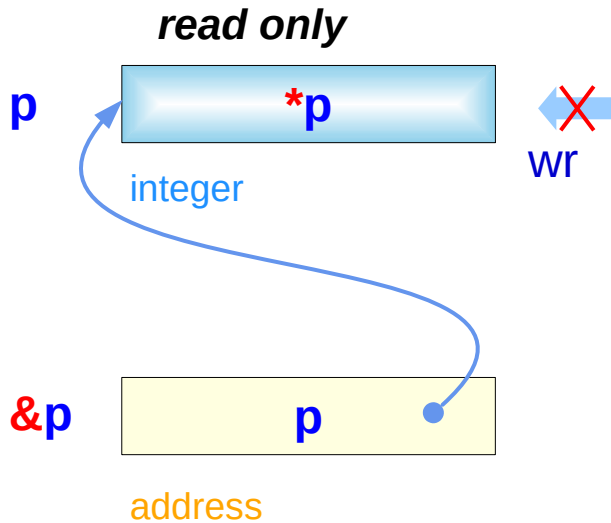

`int *const q;`

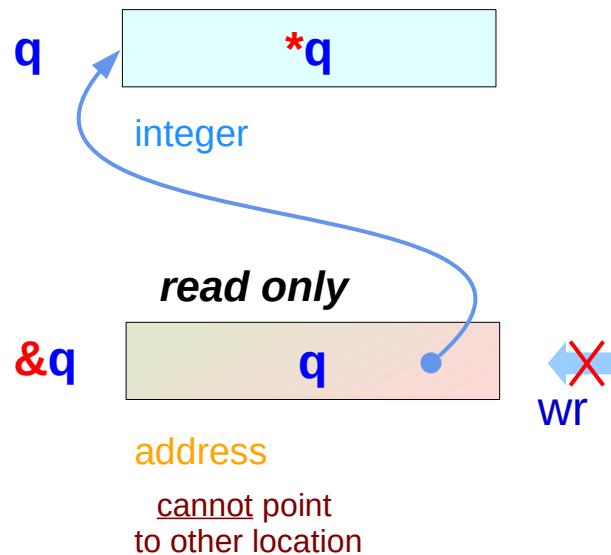

`const int *const r;`

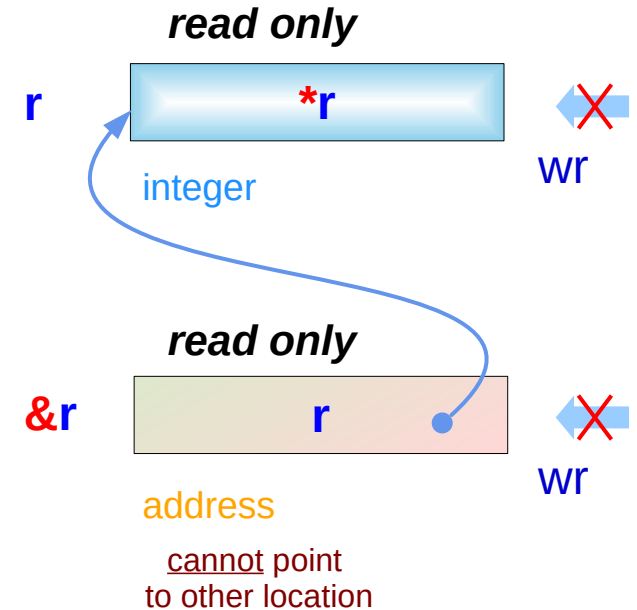

const examples (1)

```
const int * pc;  
int * p, i;  
const int ic;
```

```
pc = &i; // (const int *) ← (int *)  
*pc = 5; // (const int) error
```

Writing to the writable memory location (i)
is forbidden via **pc** ... (no harm, OK)

```
p = &ic; // (int *) ← (const int *) warning  
*p = 5; // (int)
```

Writing to the read only memory location (ic)
is not forbidden via **p** ... (hazardous, not OK)

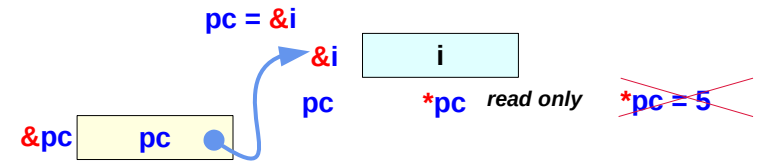

pc can point to **i**
***pc** must be **const**

the same memory location
that can be written via **i**
cannot be written via ***pc**

***pc** should not write
the writable memory location

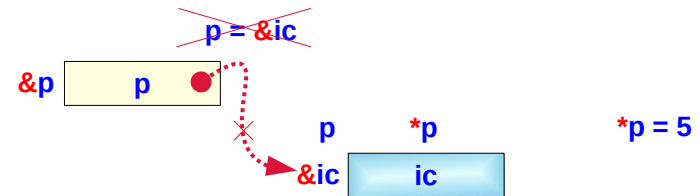

Assume **p** points to **const ic**

the same memory location
that cannot be written via **ic**,
can be written via ***p**

thus ***p** can write
the **const** memory location

therefore, **p** should not point to **const ic**

const examples (2)

```
const int * pc;  
    int * p, i = 5;  
const int ic = 7;
```

```
p = &i;  
pc = &ic
```

// more constrained type ← general type (O)

```
pc = &i; // (const int * ← int *)  
pc = p; // (const int * ← int *)
```

// general type ← more constrained type (X)

```
p = &ic; // (int * ← const int *) warning  
p = pc; // (int * ← const int *) warning
```

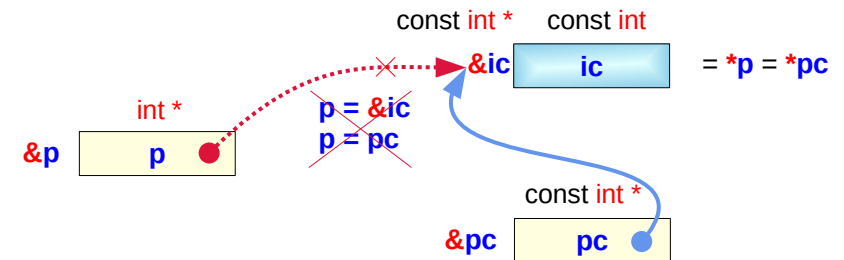
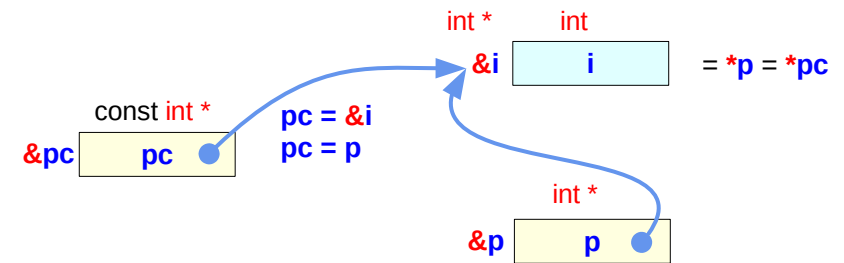

C A Reference Manual, Harbison & Steele Jr.

const examples (3)

```
const int * pc;
      int * p, i;
const int ic;
```

```
p = &i; // (int *) ← (int *)
*p = 5; // (int)
pc = &i; // (const int *) ← (int *)
*pc = 5; // (const int) error
```

```
p = &ic; // (int *) ← (const int *) warning
*p = 5; // (int)
pc = &ic; // (const int *) ← (const int *)
*pc = 5; // (const int) error
```

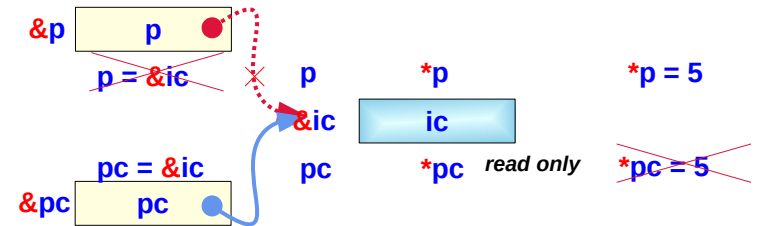
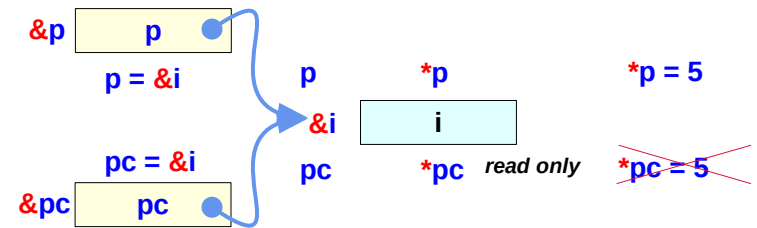
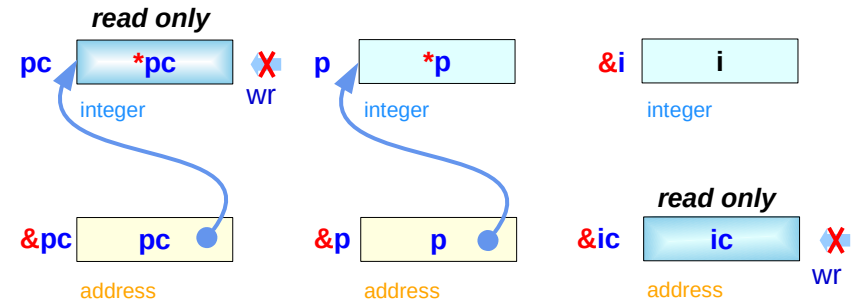

C A Reference Manual, Harbison & Steele Jr.

const examples (4)

```
const int * pc;  
int * p, i;  
const int ic;
```

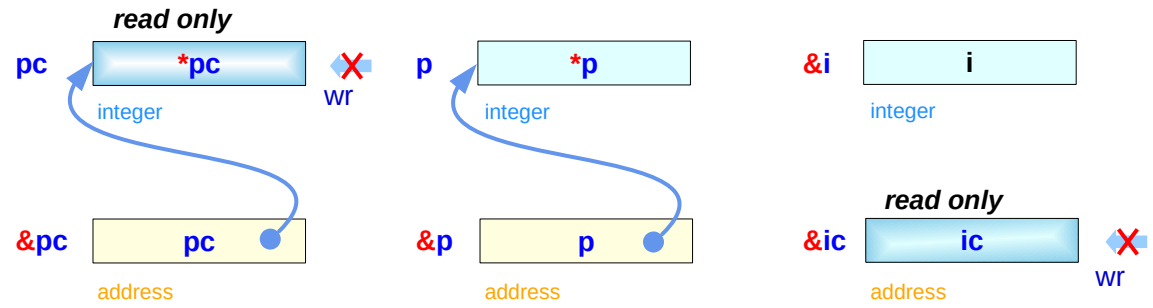

```
pc = p = &i;  
pc = &ic  
*p = 5;  
*pc = 5; // invalid *pc :: cons int
```

```
pc = &i; // (const int * ← int *)  
pc = p; // (const int * ← int *)  
p = &ic; // invalid (int * ← const int *)  
p = pc; // invalid (int * ← const int *)  
p = (int *) &ic; // type cast  
p = (int *) pc; // type cast
```

C A Reference Manual, Harbison & Steele Jr.

References

- [1] Essential C, Nick Parlante
- [2] Efficient C Programming, Mark A. Weiss
- [3] C A Reference Manual, Samuel P. Harbison & Guy L. Steele Jr.
- [4] C Language Express, I. K. Chun