

Z Transform (H.1)

Definition

20170127

Copyright (c) 2016 Young W. Lim.

Permission is granted to copy, distribute and/or modify this document under the terms of the GNU Free Documentation License, Version 1.2 or any later version published by the Free Software Foundation; with no Invariant Sections, no Front-Cover Texts, and no Back-Cover Texts. A copy of the license is included in the section entitled "GNU Free Documentation License".

Based on
Complex Analysis for Mathematics and Engineering
J. Mathews

z - Transform

$$X(z) = \sum_{k=-\infty}^{+\infty} x[k] z^{-k}$$

$$z = |r| e^{j2\pi F} \\ = |r| e^{j\Omega}$$

$$x[n] \longleftrightarrow X(z)$$

OneSided z-transform

$$X(z) = \sum_{k=0}^{+\infty} x[k] z^{-k}$$

Inverse z-Transform

$$\begin{aligned} X(z) &= \mathcal{Z} \left[\{x_n\}_{n=0}^{\infty} \right] \\ &= \sum_{n=0}^{\infty} x_n z^{-n} \\ &= \sum_{n=0}^{\infty} x[n] z^{-n} \end{aligned}$$

$$\begin{aligned} x_n &= x[n] \\ &= \mathcal{Z}^{-1} [X(z)] \\ &= \frac{1}{2\pi i} \int_C X(z) z^{n-1} dz \end{aligned}$$

Admissible Form of z -transform

$$X(z) = \sum_{k=0}^{\infty} x[n] z^{-n}$$

admissible z -transform

if $X(z)$ is a rational function

$$X(z) = \frac{P(z)}{Q(z)} = \frac{b_0 + b_1 z^1 + b_2 z^2 + \dots + b_{p-1} z^{p-1} + b_p z^p}{a_0 + a_1 z^1 + a_2 z^2 + \dots + a_{q-1} z^{q-1} + a_q z^q}$$

$P(z)$: a polynomial of degree p

$Q(z)$: a polynomial of degree q

D : Simply connected domain

C : Simple closed contour (CCW) in D

if $f(z)$ is analytic inside C and on C
except at the points z_1, z_2, \dots, z_k in C

then

$$\frac{1}{2\pi i} \int_C f(z) dz = \sum_{j=1}^k \text{Res}(f(z), z_j)$$

Singular points: z_1, z_2, \dots, z_k

$$\oint_C f(z) dz = 2\pi i \sum_{k=1}^n \text{Res}(f(z), z_k)$$

finite number k of
singular points z_k

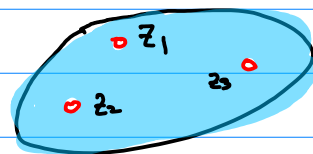

$$\oint_C f(z) dz = 0 \quad \text{if } f(z) \text{ is continuous in } D \text{ and}$$

$f(z) = F'(z) : F(z) \text{ is an antiderivative of } f(z)$
fundamental theorem of calculus

$$\oint_C f(z) dz = 0 \quad \text{if } f(z) \text{ is analytic within and on } C$$

no singularity

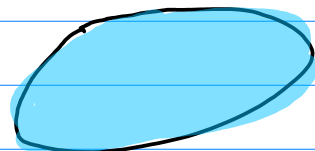

$$f(z) = \sum_{n=n_1}^{\infty} a_n^{(m)} (z - z_m)^n$$

z_m : possible poles of $f(z)$
 not necessarily poles

$$a_n^{(m)} = \frac{1}{2\pi i} \oint_C \frac{f(z')}{(z' - z_m)^{n+1}} dz'$$

$$= \sum_k \text{Res} \left(\frac{f(z)}{(z - z_m)^{n+1}}, z_k \right)$$

z_k : poles of $\frac{f(z)}{(z - z_m)^{n+1}}$
 within C

$$= \frac{1}{n!} f^{(n)}(z_m) \quad n_1 \geq 0$$

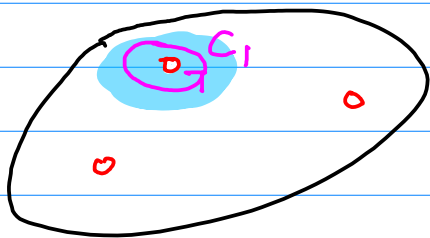

$a_n^{(0)}$ expansion at z_0

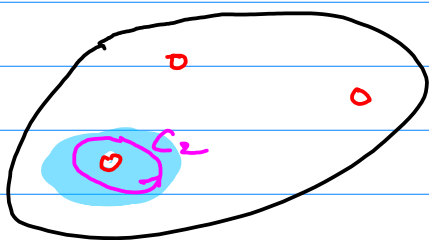

$a_n^{(1)}$ expansion at z_1

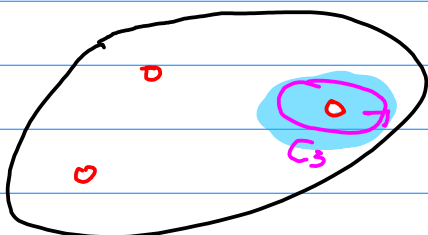

$a_n^{(2)}$ expansion at z_2

$$a_n^{(m)} = \text{Res}(f(z), z_m)$$

the residue of $f(z)$ at z_m using C_m

assumed that

there are several (m) singularities (poles) of $f(z)$ in a region

but that

C is taken to enclose only the pole z_m : C_m

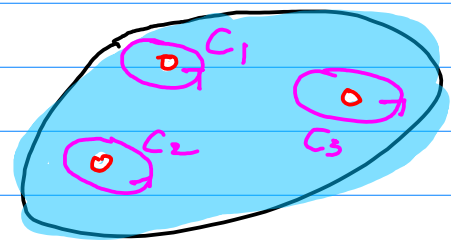
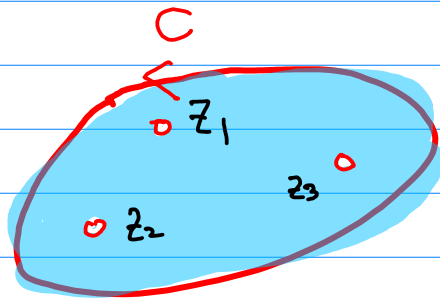

Laurent's Theorem

f : analytic within the annular domain D

$$r < |z - z_0| < R$$

then

$$f(z) = \sum_{k=-\infty}^{+\infty} a_k (z - z_0)^k, \text{ valid for } r < |z - z_0| < R$$

$$a_k = \frac{1}{2\pi i} \oint_C \frac{f(s)}{(s - z_0)^{k+1}} ds, \quad k = 0, \pm 1, \pm 2, \dots$$

C : a simple closed curve
that lies entirely within D
that encloses z_0

$$a_{-1} = \frac{1}{2\pi i} \oint_C f(s) ds \quad \rightarrow \quad \oint_C f(s) ds = 2\pi i \cdot a_{-1}$$

$$a_{-1} = \frac{1}{2\pi i} \oint_C f(s) ds = \text{Res}(f(z), z_0)$$

$$= \begin{cases} \lim_{z \rightarrow z_0} (z - z_0) f(z) & \text{(simple)} \\ \frac{1}{(n-1)!} \lim_{z \rightarrow z_0} \frac{d^{n-1}}{dz^{n-1}} (z - z_0)^n f(z) & \text{(order } n) \end{cases}$$

Cauchy's Residue Theorem

$f(z)$: **analytic** on and within C
except a finite number of **singular points**
 z_1, z_2, \dots, z_n within C

then

$$\int_C f(z) dz = 2\pi i \sum_{k=1}^n \text{Res}(f(z), z_k)$$

D : a simply connected domain

C : a simple closed contour in D

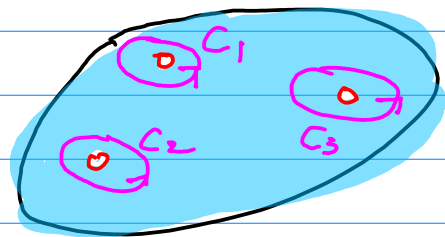
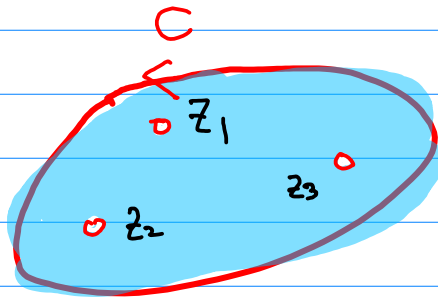

z_1

$$f(z) = \sum_{k=-\infty}^{+\infty} a_k (z - z_1)^k$$

$$a_{-1}^{z_1} = \frac{1}{2\pi i} \oint_{C_1} f(s) ds = \text{Res}(f(z), z_1)$$

z_2

$$f(z) = \sum_{k=-\infty}^{+\infty} a_k (z - z_2)^k$$

$$a_{-1}^{z_2} = \frac{1}{2\pi i} \oint_{C_2} f(s) ds = \text{Res}(f(z), z_2)$$

z_3

$$f(z) = \sum_{k=-\infty}^{+\infty} a_k (z - z_3)^k$$

$$a_{-1}^{z_3} = \frac{1}{2\pi i} \oint_{C_3} f(s) ds = \text{Res}(f(z), z_3)$$

z_1

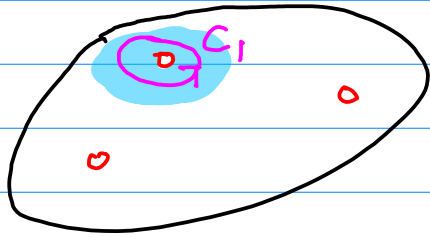

Laurent series expansion at z_1

$$f(z) = \sum_{k=-\infty}^{+\infty} a_k (z - z_1)^k$$

$$a_{-1} = \frac{1}{2\pi i} \oint_{C_1} f(s) ds = \text{Res}(f(z), z_1)$$

z_2

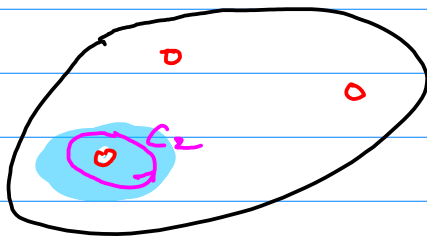

Laurent series expansion at z_2

$$f(z) = \sum_{k=-\infty}^{+\infty} a_k (z - z_2)^k$$

$$a_{-1} = \frac{1}{2\pi i} \oint_{C_2} f(s) ds = \text{Res}(f(z), z_2)$$

z_3

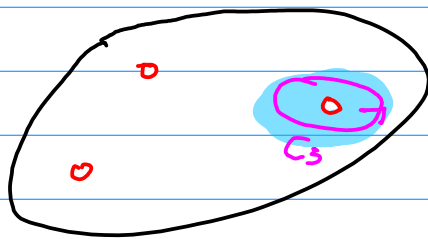

Laurent series expansion at z_3

$$f(z) = \sum_{k=-\infty}^{+\infty} a_k (z - z_3)^k$$

$$a_{-1} = \frac{1}{2\pi i} \oint_{C_3} f(s) ds = \text{Res}(f(z), z_3)$$

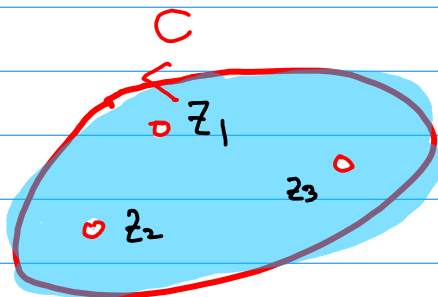

$$\int_C f(z) dz = 2\pi i \sum_{k=1}^n \text{Res}(f(z), z_k)$$

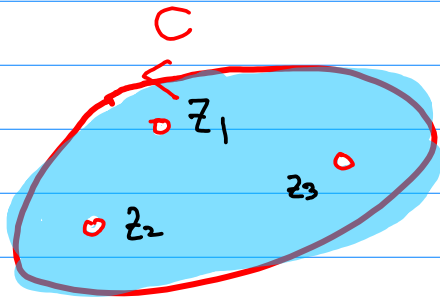

$$\int_C f(z) dz = 2\pi i \operatorname{Res}(f(z), z_1) + 2\pi i \operatorname{Res}(f(z), z_2) + 2\pi i \operatorname{Res}(f(z), z_3)$$

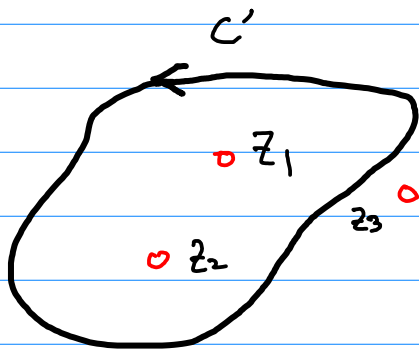

$$\int_{C'} f(z) dz = 2\pi i \operatorname{Res}(f(z), z_1) + 2\pi i \operatorname{Res}(f(z), z_2)$$

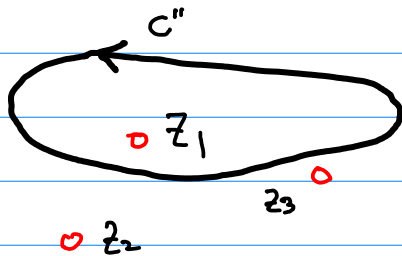

$$\int_{C''} f(z) dz = 2\pi i \operatorname{Res}(f(z), z_1)$$

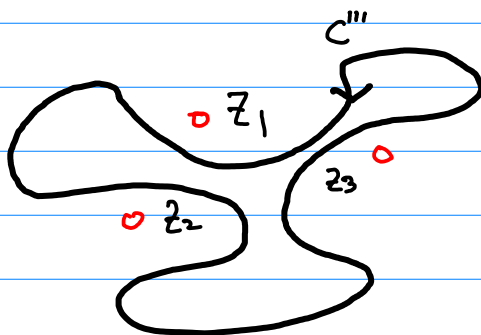

$$\int_{C'''} f(z) dz = 0$$

Different D , Different Laurent Series

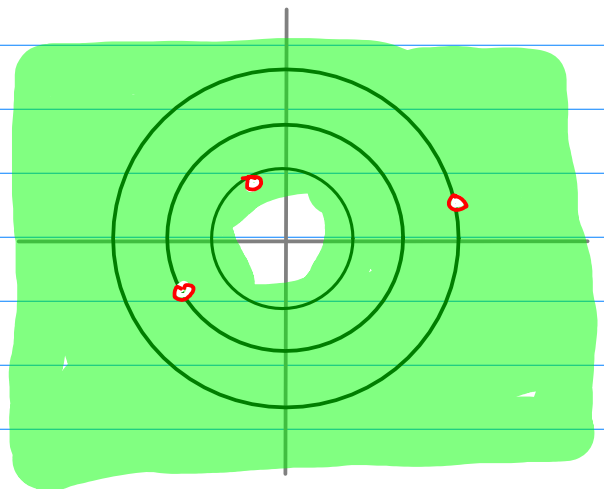
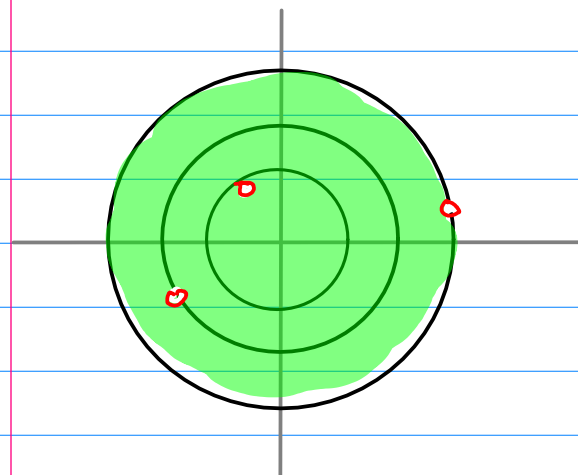
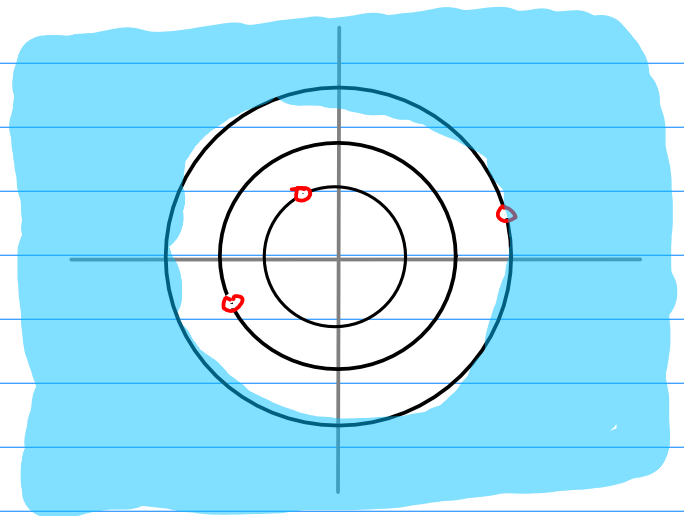
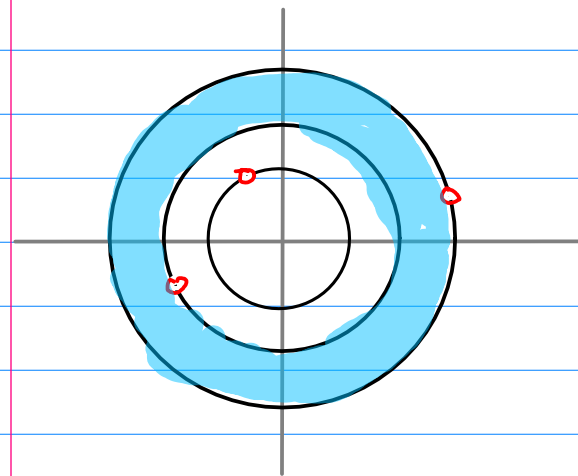
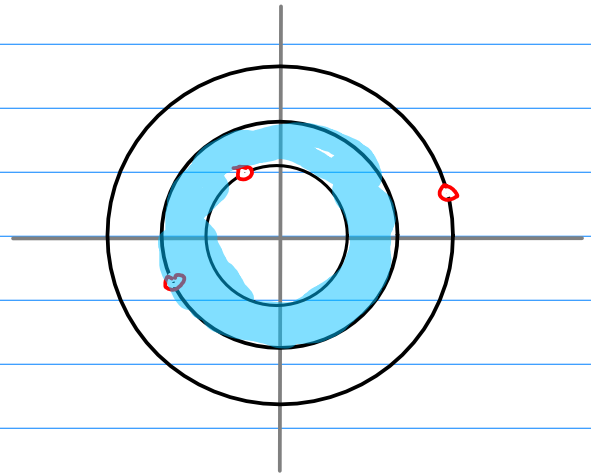
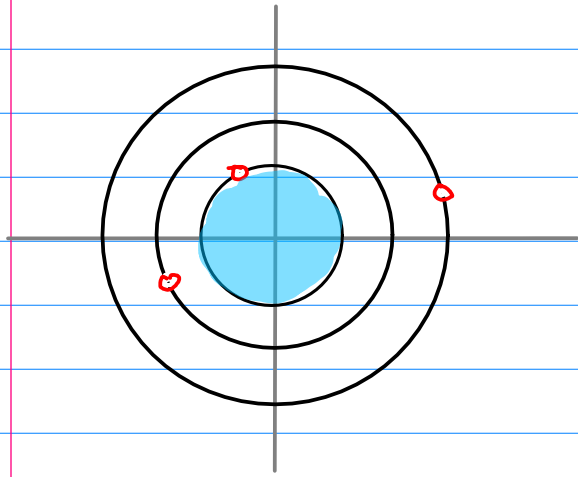

z -transform

$$f(z) = \frac{12}{z(2-z)(1+z)} = \frac{4}{z} \left(\frac{1}{1+z} + \frac{1}{2-z} \right)$$

pole: $z=0$, $z=2$, $z=-1$

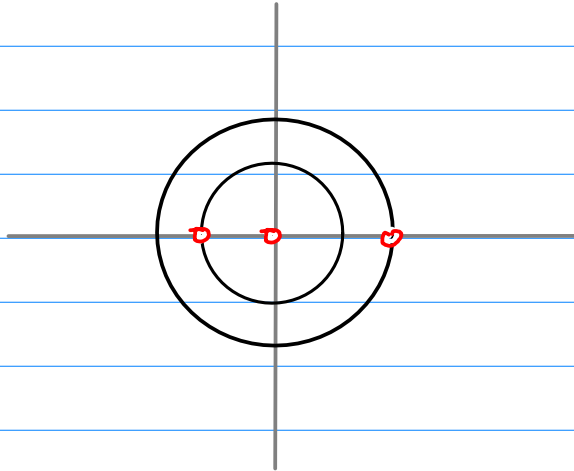

$$0 < |z| < 1$$

$$f(z) = -3 + 9z/2 - 15z^2/4 + 33z^3/8 + \dots + 6/z$$

$$|z| > 2$$

$$\frac{1}{1+z} = \frac{1}{z} \frac{1}{(1+z^{-1})} \quad \frac{1}{2+z} = -\frac{1}{z} \frac{1}{1-2z^{-1}}$$

$$f(z) = -(12/z^3) (1 + 1/z + 3/z^2 + 5/z^3 + 11/z^4 + \dots)$$

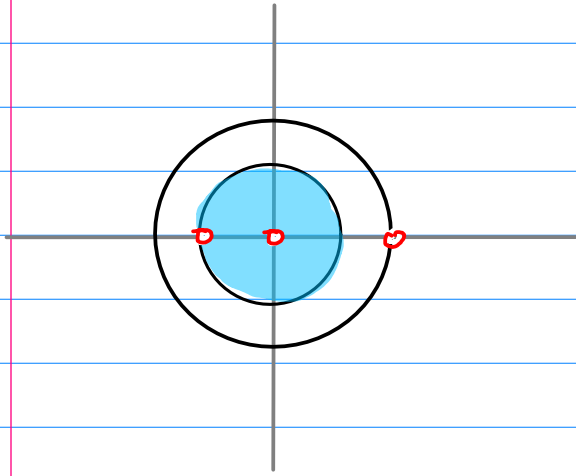

$$0 < |z| < 1$$

$$f(z) = -3 + 9z/2 - 15z^2/4 + 33z^3/8 + \dots + 6/z$$

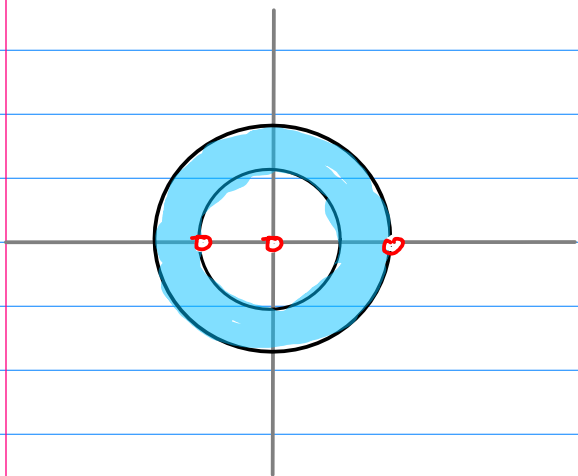

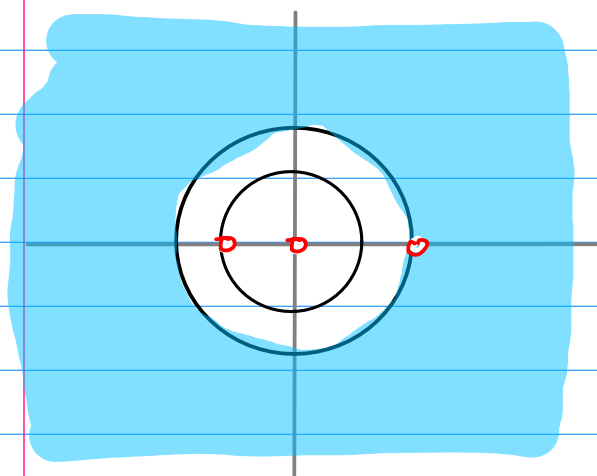

$$|z| > 2$$

$$\frac{1}{1+z} = \frac{1}{z} \frac{1}{(1+z^{-1})}$$

$$\frac{1}{2+z} = -\frac{1}{z} \frac{1}{1-2z^{-1}}$$

$$f(z) = \frac{-1}{(z-1)(z-2)}$$

Complex Variables and Ap
Brown & Churchill

$$f(z) = \frac{-1}{(z-1)(z-2)} = \frac{1}{z-1} - \frac{1}{z-2}$$

$$D_1: |z| < 1$$

$$D_2: 1 < |z| < 2$$

$$D_3: 2 < |z|$$

$$\textcircled{1} D_1 \quad |z| < 1, \quad \left|\frac{z}{2}\right| < 1$$

$$f(z) = \frac{1}{z-1} - \frac{1}{z-2} = \frac{-1}{1-z} + \frac{1}{2} \frac{1}{1-\left(\frac{z}{2}\right)}$$

$$= -\sum_{n=0}^{\infty} z^n + \sum_{n=0}^{\infty} \frac{z^n}{2^{n+1}} = \sum_{n=0}^{\infty} (2^{-n-1} - 1)z^n \quad |z| < 1$$

$$\textcircled{2} D_2 \quad 1 < |z| < 2 \Rightarrow \left|\frac{1}{z}\right| < 1, \quad \left|\frac{z}{2}\right| < 1$$

$$f(z) = \frac{1}{z-1} - \frac{1}{z-2} = \frac{1}{z} \cdot \frac{1}{1-\left(\frac{1}{z}\right)} + \frac{1}{2} \frac{1}{1-\left(\frac{z}{2}\right)}$$

$$= \sum_{n=0}^{\infty} \frac{1}{z^{n+1}} + \sum_{n=0}^{\infty} \frac{z^n}{2^{n+1}}$$

$$= \sum_{n=1}^{\infty} \frac{1}{z^n} + \sum_{n=0}^{\infty} \frac{z^n}{2^{n+1}}$$

$$\textcircled{3} D_3 \quad 2 < |z| \quad \left|\frac{z}{2}\right| < 1 \quad \left|\frac{1}{z}\right| < 1$$

$$f(z) = \frac{1}{z-1} - \frac{1}{z-2} = \frac{1}{z} \frac{1}{1-\left(\frac{1}{z}\right)} - \frac{1}{z} \frac{1}{1-\left(\frac{z}{2}\right)}$$

$$= \sum_{n=0}^{\infty} \frac{1}{z^{n+1}} - \sum_{n=0}^{\infty} \frac{z^n}{z^{n+1}} = \sum_{n=0}^{\infty} \frac{1-2^n}{z^{n+1}}$$

$$= \sum_{n=1}^{\infty} \frac{1-2^{n-1}}{z^n}$$

$$f(z) = \frac{-1}{(z-1)(z-2)}$$

① $D_1 \quad |z| < 1, \quad \left|\frac{z}{2}\right| < 1$

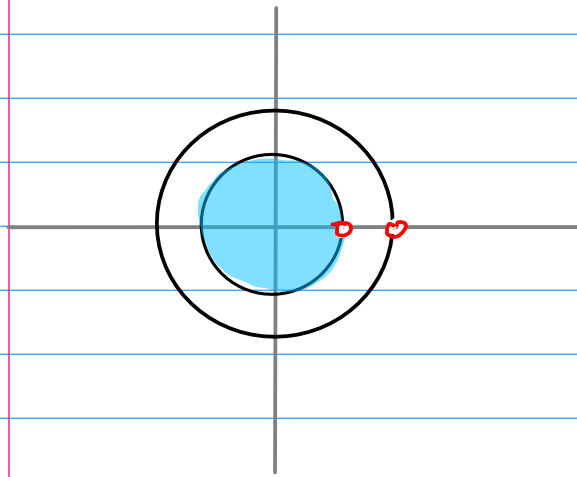

$$f(z) = \frac{1}{z-1} - \frac{1}{z-2} = \frac{-1}{1-z} + \frac{1}{1-\left(\frac{z}{2}\right)}$$

$$= - \sum_{n=0}^{\infty} z^n + \sum_{n=0}^{\infty} \frac{z^n}{2^{n+1}} = \sum_{n=0}^{\infty} (2^{-n-1} - 1) z^n \quad |z| < 1$$

$$f(z) = \frac{-1}{(z-1)(z-2)}$$

$$\textcircled{2} D_2 \quad 1 < |z| < 2 \Rightarrow \left| \frac{1}{z} \right| < 1, \quad \left| \frac{z}{2} \right| < 1$$

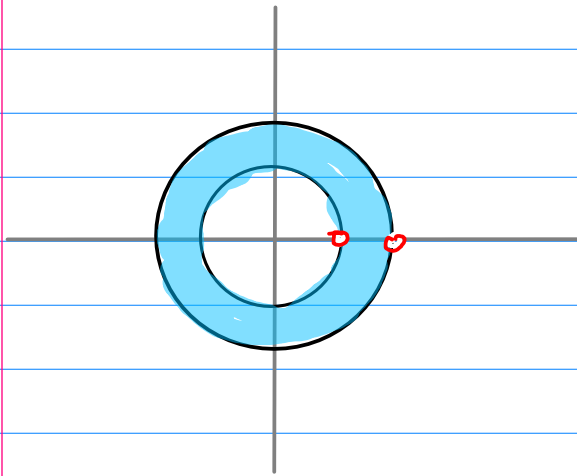

$$\begin{aligned} f(z) &= \frac{1}{z-1} - \frac{1}{z-2} = \frac{1}{z} \cdot \frac{1}{1-\left(\frac{1}{z}\right)} + \frac{1}{2} \frac{1}{1-\left(\frac{z}{2}\right)} \\ &= \sum_{n=0}^{\infty} \frac{1}{z^{n+1}} + \sum_{n=0}^{\infty} \frac{z^n}{2^{n+1}} \\ &= \sum_{n=1}^{\infty} \frac{1}{z^n} + \sum_{n=0}^{\infty} \frac{z^n}{2^{n+1}} \end{aligned}$$

$$f(z) = \frac{-1}{(z-1)(z-2)}$$

③ $D_3 \quad 2 < |z| \quad \left| \frac{z}{2} \right| < 1 \quad \left| \frac{1}{z} \right| < 1$

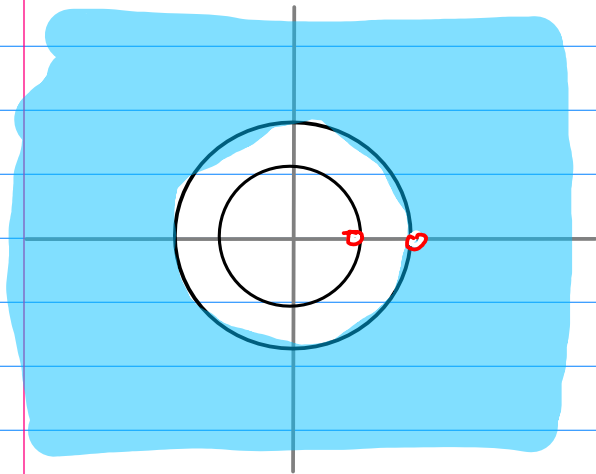

$$\begin{aligned} f(z) &= \frac{1}{z-1} - \frac{1}{z-2} = \frac{1}{z} \frac{1}{1-(\frac{1}{z})} - \frac{1}{z} \frac{1}{1-(\frac{1}{2z})} \\ &= \sum_{n=0}^{\infty} \frac{1}{z^{n+1}} - \sum_{n=0}^{\infty} \frac{2^n}{z^{n+1}} = \sum_{n=0}^{\infty} \frac{1-2^n}{z^{n+1}} \\ &= \sum_{n=1}^{\infty} \frac{1-2^{n-1}}{z^n} \end{aligned}$$

$$f(z) = \frac{-1}{(z-1)(z-2)}$$

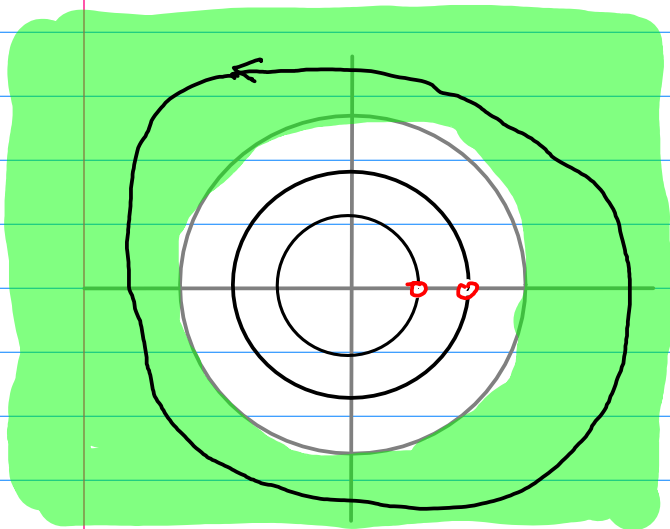

$$x[n]$$

$$= \frac{1}{2\pi i} \int_C \boxed{X(z) z^{n-1}} dz$$

$$= \sum_{j=1}^k \text{Res}(\boxed{X(z) z^{n-1}}, z_j)$$

$$X(z) = \frac{-1}{(z-1)(z-2)}$$

$$X(z) z^{n-1} = \frac{-1}{(z-1)(z-2)} z^{n-1}$$

$$\text{Res}(\boxed{X(z) z^{n-1}}, 1) = (z-2) \frac{-1}{(z-1)(z-2)} z^{n-1} \Big|_{z=1} = 1$$

$$\text{Res}(\boxed{X(z) z^{n-1}}, 2) = (z-1) \frac{-1}{(z-1)(z-2)} z^{n-1} \Big|_{z=2} = -2^{n-1}$$

$$x[n] = 1 - 2^{n-1}$$

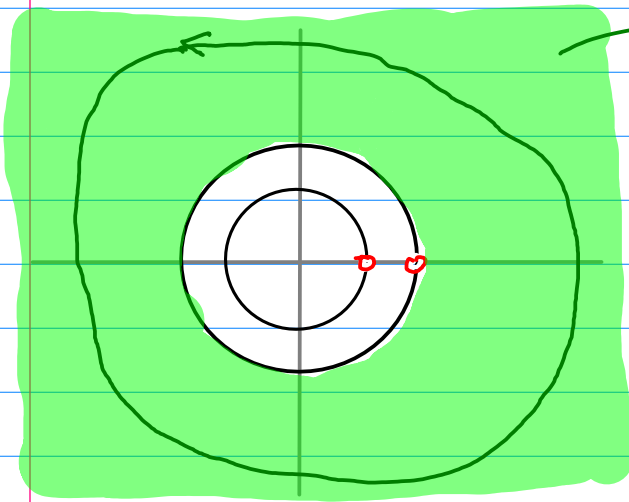

ROC (Region of Convergence)

$$|z| > 2 \Rightarrow \frac{2}{|z|} < 1$$

$$\left(\frac{2}{z}\right)^0 + \left(\frac{2}{z}\right)^1 + \left(\frac{2}{z}\right)^2 + \dots \longrightarrow \frac{1}{1 - \frac{2}{z}}$$

Converge

$$|z| > 2 \Rightarrow \frac{1}{|z|} < 1$$

$$\left(\frac{1}{z}\right)^0 + \left(\frac{1}{z}\right)^1 + \left(\frac{1}{z}\right)^2 + \dots \longrightarrow \frac{1}{1 - \frac{1}{z}}$$

Converge

$$\begin{aligned} f(z) &= \frac{1}{z-1} - \frac{1}{z-2} = \frac{1}{z} \frac{1}{1 - (\frac{1}{z})} - \frac{1}{z} \frac{1}{1 - (\frac{2}{z})} \\ &= \sum_{n=0}^{\infty} \frac{1}{z^{n+1}} - \sum_{n=0}^{\infty} \frac{2^n}{z^{n+1}} = \sum_{n=0}^{\infty} \frac{1 - 2^n}{z^{n+1}} \\ &= \sum_{n=1}^{\infty} \frac{1 - 2^{n-1}}{z^n} \end{aligned}$$

$$\left(\frac{1}{z}\right) + \left(\frac{1}{z}\right)^2 + \left(\frac{1}{z}\right)^3 + \dots + \frac{1}{z} \left\{ \left(\frac{2}{z}\right) + \left(\frac{2}{z}\right)^2 + \left(\frac{2}{z}\right)^3 + \dots \right\} \longrightarrow \frac{1}{z-1} - \frac{1}{z-2} = \frac{-1}{(z-1)(z-2)}$$

Converge

$$(1-2^0)z^{-1} + (1-2^1)z^{-2} + (1-2^2)z^{-3} + \dots \longrightarrow \frac{-1}{(z-1)(z-2)} \quad (|z| > 2)$$

Converge

$$x[n] = 1 - 2^n \quad \longleftrightarrow \quad X(z) = \frac{-1}{(z-1)(z-2)} \quad (|z| > 2)$$

causal $x[n]=0$ ($n < 0$)

anti-causal $x[n]=0$ ($n > 0$)

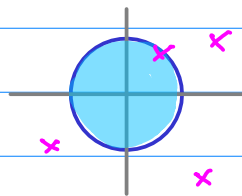
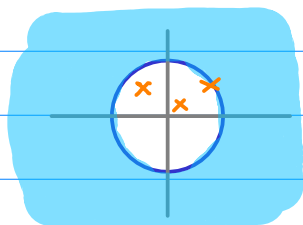

ROC: outside a circle

ROC: inside a circle

bi-causal $x[n]$

Overlapped ROC

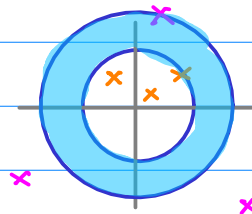

$$f(z) = \sum_{n=n_1}^{\infty} a_n (z - z_m)^n$$

$$a_n = \frac{1}{2\pi i} \oint_C \frac{f(z')}{(z' - z_m)^{n+1}} dz'$$

$$= \sum_k \text{Res} \left(\frac{f(z)}{(z - z_m)^{n+1}}, z_k \right)$$



C is in the same region of analyticity of $f(z)$
typically a circle centered on z_m

z_k within C : singularities of $\frac{f(z)}{(z - z_m)^{n+1}}$

$n_1 = n_{f,m}$ depends on $f(z)$, z_m

a_n depends on $f(z)$, z_m , region of analyticity

Whether $f(z)$ is singular at $z = z_m$ or not

or at other points between z and z_m

We can expand $f(z)$ about any point z_m

over powers of $(z - z_m)$.

$$f(z) = \sum_{n=-\infty}^{\infty} a_n^{(m)} (z - z_m)^n$$

$$a_n^{(m)} = \frac{1}{2\pi i} \oint_C \frac{f(z')}{(z' - z_m)^{n+1}} dz'$$

$$= \sum_k \operatorname{Res} \left(\frac{f(z)}{(z - z_m)^{n+1}}, z_k \right)$$

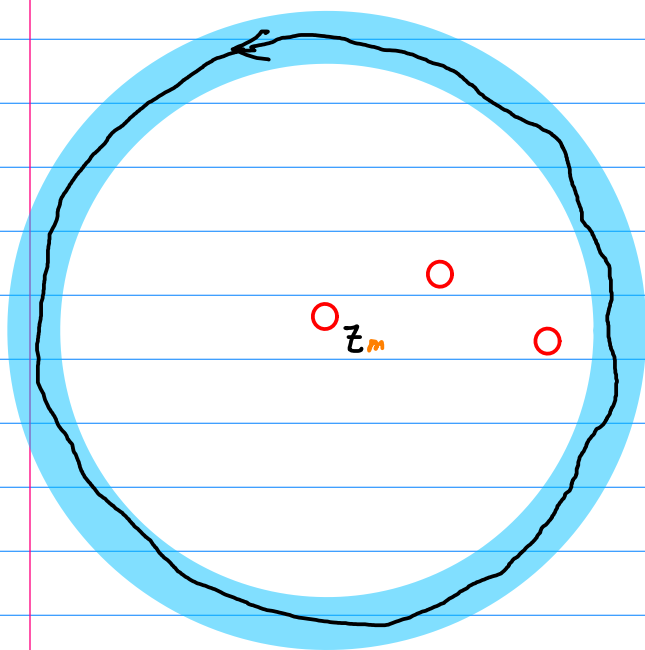
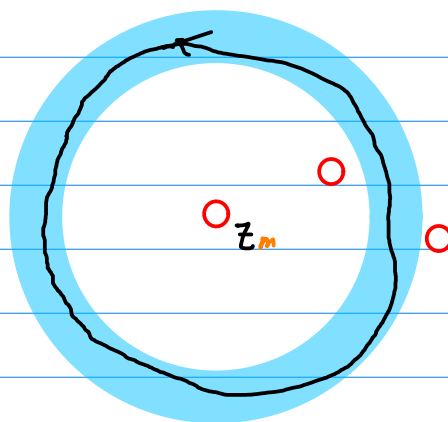
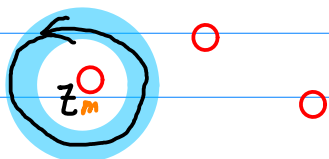

$$f(z) = \sum_{n=-\infty}^{\infty} a_n^{(m)} (z - z_m)^n$$

$$f(z) = \sum_{n=-\infty}^{\infty} a_n z^n \quad z_m = 0 \quad a_n^{(0)} \rightarrow a_n$$

Laurent Series at $z=0$

$$f(z) = \dots + a_{-2} z^{-2} + a_{-1} z^{-1} + a_0 z^0 + a_1 z^1 + a_2 z^2 + a_3 z^3 + \dots$$

z-transform

Bi-causal

$$X(z) = \dots + x[-2] z^2 + x[-1] z^1 + x[0] z^0 + x[1] z^{-1} + x[2] z^{-2} + x[3] z^{-3} + \dots$$

Causal

$$X(z) = x[0] z^0 + x[1] z^{-1} + x[2] z^{-2} + x[3] z^{-3} + \dots$$

Anti-causal

$$X(z) = \dots + x[-2] z^2 + x[-1] z^1 + x[0] z^0$$

$$a_n \leftrightarrow x[-n]$$

$$a_{-n} \leftrightarrow x[n]$$

$$f(z) = \sum_{n=n_1}^{\infty} a_n^{\{m\}} (z - z_m)^n$$

$$a_n^{\{m\}} = \frac{1}{2\pi i} \oint_C \frac{f(z')}{(z' - z_m)^{n+1}} dz'$$

$$= \sum_k \operatorname{Res} \left(\frac{f(z)}{(z - z_m)^{n+1}}, z_k \right)$$

Analytic at z_m

$$n_1 \geq 0$$

Taylor Series

$$\text{general } n_1, \quad z_m = 0$$

MacLaurin Series

Singular at z_m

$$\text{general } n_1$$

Laurent Series

$$\text{general } n_1, \quad z_m = 0$$

z -Transform

$$f(z) = \sum_{n=-\infty}^{\infty} a_n^{(f)} (z - z_m)^n$$

$$\begin{aligned} a_n^{(f)} &= \frac{1}{2\pi i} \oint_c \frac{f(z')}{(z' - z_m)^{n+1}} dz' \\ &= \sum_k \operatorname{Res} \left(\frac{f(z)}{(z - z_m)^{n+1}}, z_k \right) \end{aligned}$$

$$z_m = 0$$

$$a_{-n}^{(f)} = h(n)$$

$$n \rightarrow -n$$

$$H(z) = \sum_{n=-\infty}^{\infty} h(-n) z^n$$

$$\begin{aligned} h(n) &= \frac{1}{2\pi i} \oint_c \frac{H(z')}{z'^{n+1}} dz' \\ &= \sum_k \operatorname{Res} \left(\frac{H(z)}{z^{n+1}}, z_k \right) \end{aligned}$$

$$H(z) = \sum_{n=-\infty}^{\infty} h(n) z^{-n}$$

$$\begin{aligned} h(n) &= \frac{1}{2\pi i} \oint_c H(z') z'^{n-1} dz' \\ &= \sum_k \operatorname{Res} (H(z) z^{n-1}, z_k) \end{aligned}$$

C is in the same region of analyticity of $f(z)$
typically a circle centered on z_m

z_k within C : singularities of $\frac{f(z)}{(z-z_k)^{n+1}}$

C is in the same region of analyticity of $H(z)$
typically a circle centered on z_m

generally a circle centered on the origin
may enclose any or all singularities of $H(z)$
often the unit circle

z_k within C : singularities of $H(z)z^{n-1}$

$$H(z) = \sum_{n=-\infty}^{\infty} h(n) z^{-n} \quad z \in \text{R.O.C.}$$

$$h(n) = \frac{1}{2\pi i} \oint_C H(z') z'^{n-1} dz' \quad C \text{ in R.O.C.}$$

$$= \sum_k \text{Res}(H(z') z'^{n-1}, z_k)$$

- ① a power series representation of a function $f(z)$ of a complex variable z
- ② a transform $H(z)$ of a sequence of 1

$$X(z) = \frac{z}{z - \frac{1}{2}} \quad \text{pole } z_0 = \frac{1}{2}$$

$$\begin{aligned} x[n] &= \text{Res} \left(X(z) z^{n-1}, z_0 \right) = \text{Res} \left(\frac{z}{z - \frac{1}{2}} z^{n-1}, \frac{1}{2} \right) \\ &= \text{Res} \left(\frac{z^n}{z - \frac{1}{2}}, \frac{1}{2} \right) = \lim_{z \rightarrow \frac{1}{2}} (z - \frac{1}{2}) \frac{z^n}{z - \frac{1}{2}} = \left(\frac{1}{2} \right)^n \end{aligned}$$

$$x[n] = \frac{1}{2^n} \quad n \geq 0$$

$$\begin{aligned} \left(\frac{1}{2} \right)^0 z^0 + \left(\frac{1}{2} \right)^1 z^{-1} + \left(\frac{1}{2} \right)^2 z^{-2} + \left(\frac{1}{2} \right)^3 z^{-3} + \dots &= \frac{1}{1 - \left(\frac{1}{2} z^{-1} \right)} \\ &= \frac{z}{z - \frac{1}{2}} \end{aligned}$$

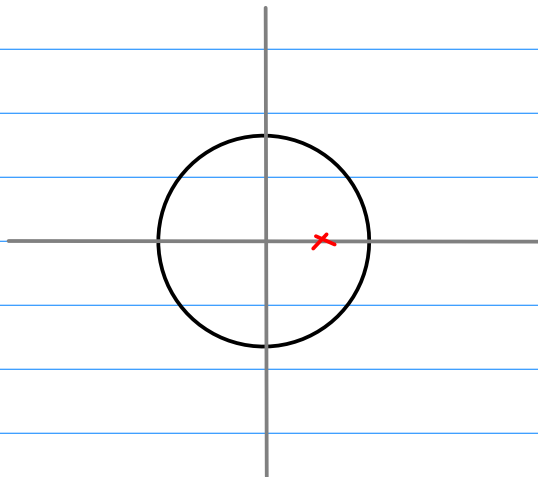

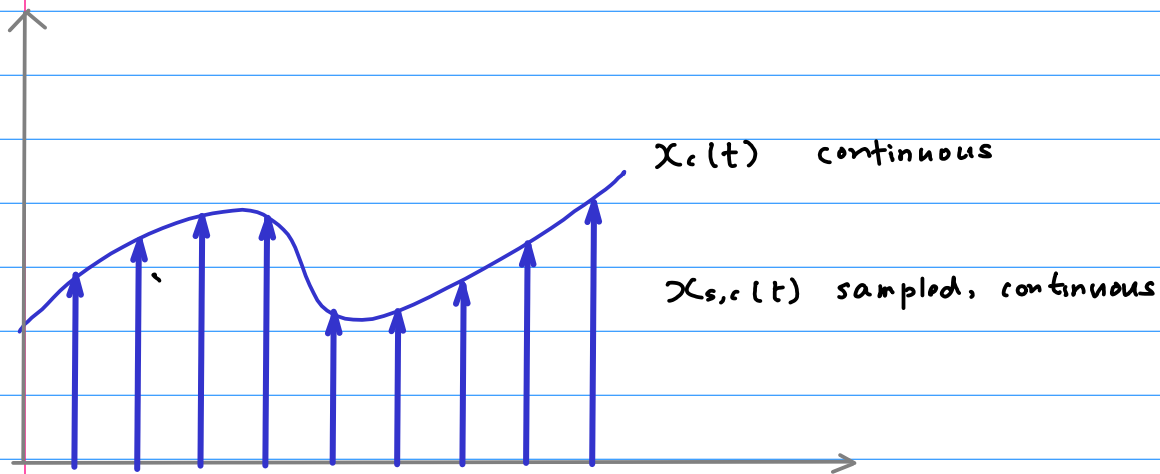

$$x_{s,c}(t) = \sum_{n=-\infty}^{+\infty} x(n) \delta_c(t - n\Delta t)$$

$$\begin{aligned} X_{s,c}(s) &= \mathcal{L}\{x_{s,c}(t)\} = \int_{-\infty}^{\infty} \boxed{\sum_{n=-\infty}^{+\infty} x(n) \delta_c(t - n\Delta t)} e^{-st} dt \\ &= \sum_{n=-\infty}^{+\infty} x(n) \int_{-\infty}^{\infty} \delta_c(t - n\Delta t) e^{-st} dt \\ &= \sum_{n=-\infty}^{+\infty} x(n) e^{-sn\Delta t} \quad e^{s\Delta t} \triangleq z \end{aligned}$$

$$X_{s,c}(s) = \sum_{n=-\infty}^{+\infty} x(n) z^{-n} \Big|_{z=e^{s\Delta t}}$$

$$X_{s,c}(s) = X(z) \Big|_{z=e^{s\Delta t}}$$

$$X_{s,c}(s) = \mathcal{L}\{x_{s,c}(t)\} = X(z) \Big|_{z=e^{s\Delta t}}$$

$x_{s,c}(t)$ an impulse train

whose coefficients are given by $x[n] = x_c(n\Delta t)$

z-transform : a special Laurent series

$$z_m = 0$$

$$a_{-n}^{\{0\}} = h(n)$$

$$n \rightarrow -n$$

$$f(z) = \sum_{n=-\infty}^{\infty} a_n^{\{m\}} (z - z_m)^n$$

$$a_n^{\{m\}} = \frac{1}{2\pi i} \oint_C \frac{f(z')}{(z' - z_m)^{n+1}} dz'$$

$$= \sum_k \operatorname{Res} \left(\frac{f(z)}{(z - z_m)^{n+1}}, z_k \right)$$

Time Reversal \leftarrow Laplace Transform

the transform functions

$$X(s) = \int \text{over negative powers } e^{-st} \quad \text{for } t > 0$$

$$X(z) = \int \text{over negative powers } z^{-n} \quad \text{for } n > 0$$

the time expansion functions

$$x(t) = \int \text{over negative powers } e^{-st} \quad \text{for } t > 0$$

$$x[n] = \int \text{over negative powers } z^{-n} \quad \text{for } n > 0$$

Time Reversal \leftarrow z^{-1} : unit delay, char eq (modes in z^k)

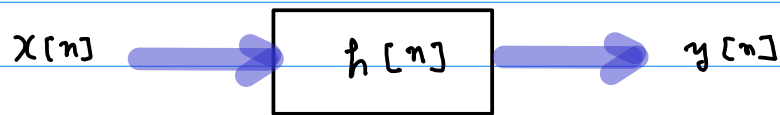

Stable system : $h[n]$ must be absolutely summable

$$|e^{j\omega n}| = 1$$

$$|z^n| \quad z = 1$$

$$\infty > M_h > \sum_{n=-\infty}^{\infty} |h[n]| \quad \text{absolutely summable}$$

$$= \sum_{n=-\infty}^{+\infty} |h[n] e^{-j\omega n}|$$

$$\geq \left| \sum_{n=-\infty}^{+\infty} h[n] e^{-j\omega n} \right|$$

$$= \left| H(z) \Big|_{z=e^{j\omega}} \right|$$

$$\infty > \left| H(z) \Big|_{z=e^{j\omega}} \right|$$

a stable system,

$H(z)$ must converge on the unit circle $|z|=1$

ROC (Region of Convergence) must include the unit circle

regardless of causality of $h[n]$

$$H(z) \Big|_{|z|=1} = H(e^{j\hat{\omega}}) \quad \text{DTFT of } h[n]$$

discrete all stable sequence must have convergent DTFTs

continuous all stable signal must have convergent CTFTs

$$C \leftarrow \text{unit circle} \quad z = e^{j\hat{\omega}}$$

ZT^{-1} $DTFT^{-1}$ identical formulas

$h[n]$ causal

$$H(z) = \sum_{n=-\infty}^{+\infty} h[n] z^{-n} = \sum_{n=0}^{+\infty} h[n] z^{-n} \quad n \in [0, \infty)$$

for finite values of n ,

each term must be finite as long as $z \neq 0$

For the sum to converge,

$h[n] z^{-n}$ must vanish as $n \rightarrow \infty$

$$|z| > r_h \quad z_h = r_h e^{j\theta}$$

z_h^n is the largest magnitude

geometrically increasing component

$n^m z^n$: the most general term

for impulse responses

$n \rightarrow \infty$ z^n dominant over n^m for finite m

Geometric components — as poles

$$\sum \{ z_0^n u[n] \} = \frac{1}{1 - (\frac{z_0}{z})} = \frac{z}{z - z_0}$$

ROC of a causal sequence $h[n]$

outside the radius of the largest magnitude pole of $H(z)$

ROC of a causal signal $h(t)$

to the right of the rightmost pole of $H_c(s)$

if $h[n]$ is a stable, causal sequence,

the unit circle must be included in the ROC

• Causal $h[n]$

ROC: outside of
a circle

• Stable $h[n]$

all poles inside
the unit circle

ROC circle must be

smaller than the unit circle

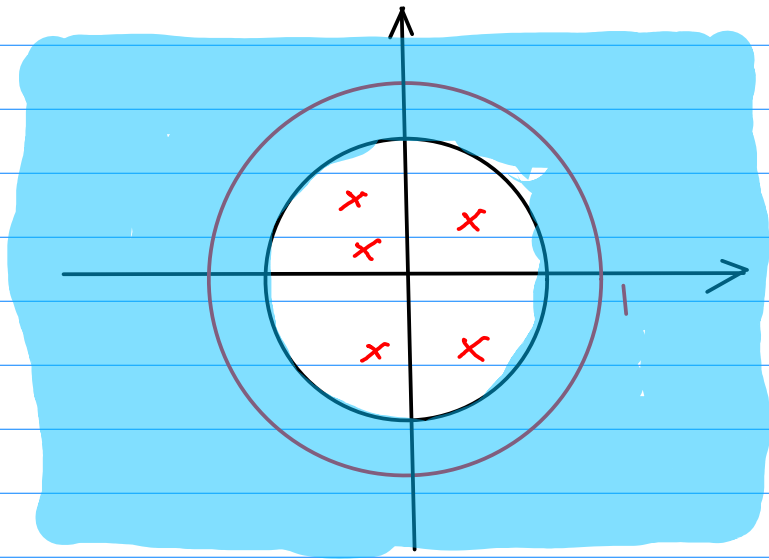

⇒ all the geometric components of $h[n]$: modes
must decay with increasing n

all the poles of $H(z)$ must be within the unit circle

all the poles of $H_c(s)$ must be in the left half plane

⊙ anti-causal $h[n]$

ROC: inside of
a circle

⊙ Stable $h[n]$

all poles outside
the unit circle

ROC circle must be

larger than the unit circle

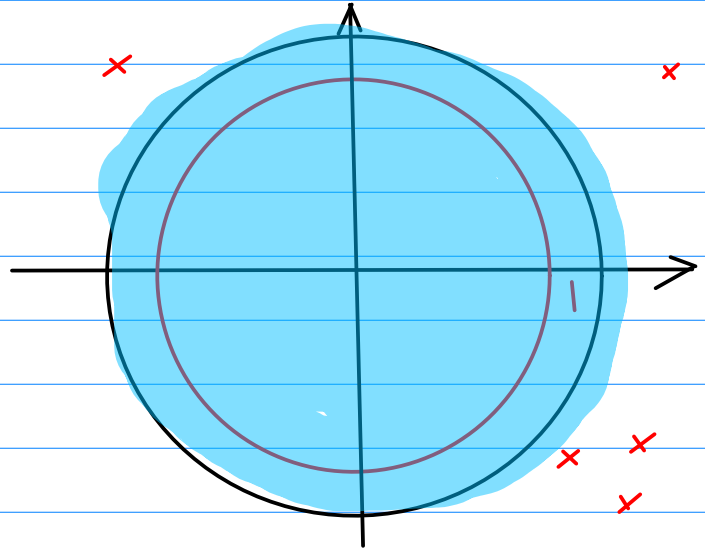

⇒ all the geometric components of $h[n]$: modes
must decay with decreasing n

• bi-causal $h[n]$

$$h_c[n] + h_{ac}[n]$$

outside inside

max mag < min mag

Overlapped ROC

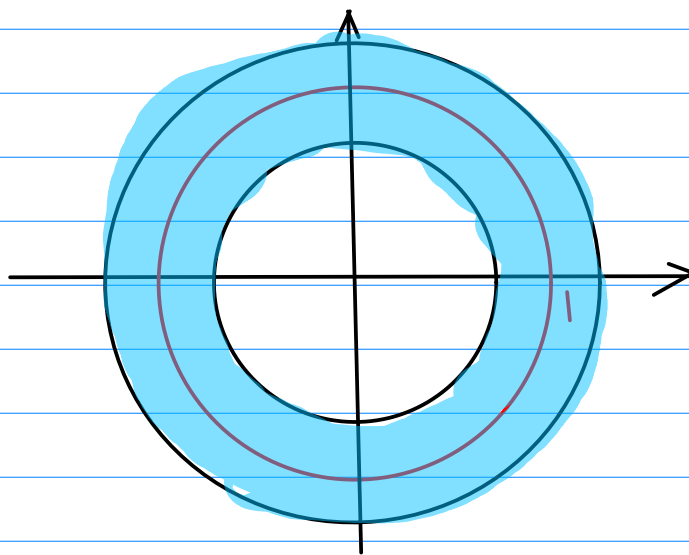

• Stable $h[n]$

all poles outside

the unit circle

ROC circle must include the unit circle

• bi-causal $h[n]$

$$h[n] = h_c[n] + h_{ac}[n]$$

causal comp. anti-causal comp

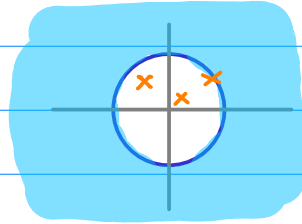

outside a circle

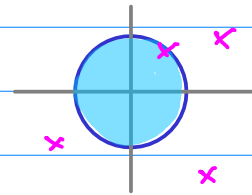

inside a circle

$$\text{max mag} < \text{min mag}$$

Overlapped ROC

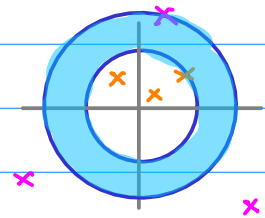

$$\text{max mag} > \text{min mag}$$

non-overlapping ROC

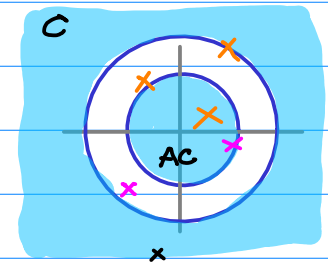

• Stable $h[n]$

all poles outside the large circle
inside the small circle

ROC circle must include the unit circle

only one annulus include the unit circle

only one stable sequence

Existence of the z-Transform

$$X(z) = \sum_{n=0}^{\infty} x[n]z^{-n} = \sum_{n=0}^{\infty} \frac{x[n]}{z^n}$$

the existence of the z-transform is guaranteed if

$$|X(z)| \leq \sum_{n=0}^{\infty} \frac{|x[n]|}{|z|^n} < \infty \quad \text{for some } |z|$$

any signal $x[n]$ that grows no faster than an exponential signal r_0^n , for some r_0 satisfies the above condition

if $|x[n]| \leq r_0^n$ for some r_0

$$\text{then } |X(z)| \leq \sum_{n=0}^{\infty} \left(\frac{r_0}{|z|}\right)^n = \frac{1}{1 - \frac{r_0}{|z|}} \quad |z| > r_0$$

therefore $X(z)$ exists for $|z| > r_0$

Almost all practical signals satisfy this condition

$$|x[n]| \leq r_0^n \quad \text{for some } r_0$$

and z-transformable

Some signals (e.g. r^{n^2}) grow faster than

the exponential signal r_0^n (for any r_0)

and do not satisfy this condition

and are not z-transformable

Such signals are of little practical or theoretical interest

Even such signals over a finite interval are z-transformable

Region of Convergence

Laplace Transform	$Ae^{\alpha t}u(t)$	$\alpha > 0$
z - Transform	$A\alpha^n u[n]$	$ \alpha > 0$
DTFT (X)		

$$X(z) = A \sum_{n=-\infty}^{\infty} \alpha^n u[n] z^{-n} = A \sum_{n=0}^{\infty} \alpha^n z^{-n} = A \sum_{n=0}^{\infty} \left(\frac{\alpha}{z}\right)^n$$

converge $\left|\frac{\alpha}{z}\right| < 1$ $|z| > |\alpha|$
open exterior of
a circle of radius $|\alpha|$

the sum of a geometric series

$$X(z) = A \frac{1}{1 - \frac{\alpha}{z}} = \frac{A}{1 - \alpha z^{-1}} = A \frac{z}{z - \alpha} \quad |z| > |\alpha|$$

DTFT

$$X(j\hat{\omega}) = \sum_{n=-\infty}^{+\infty} x[n] e^{-j\hat{\omega}n}$$

DTFT

DTFT of the unit sequence $u[n]$

$$X(e^{-j\hat{\omega}n}) = \sum_{n=-\infty}^{+\infty} u[n] e^{-j\hat{\omega}n} = \sum_{n=0}^{\infty} e^{-j\hat{\omega}n}$$

not converge

$$\hat{\omega} = 0 \quad \sum_{n=0}^{\infty} 1^n \quad \text{diverge}$$

$$\hat{\omega} = \pi \quad \sum_{n=0}^{\infty} (-1)^n \quad \text{oscillates}$$

$$\hat{\omega} = \frac{\pi}{2} \quad \sum_{n=0}^{\infty} (j)^n$$

The DTFTs of some commonly used functions do not exist in the strict sense.

But even though the DTFT does not exist, the z -transform does exist.

$$X(z) = \sum_{n=-\infty}^{+\infty} u[n] z^{-n} = \sum_{n=0}^{\infty} z^{-n}$$

$$|z| > 1 \quad X(z) = \frac{z}{z-1} = \frac{1}{1-z^{-1}}$$

$$X(z) = \frac{z}{z-1} \quad \text{pole } z=1, \quad \text{zero } z=0$$

$$X(z) = \frac{1}{1-z^{-1}} \quad \text{useful when a system is synthesized from a } z\text{-domain transfer function}$$

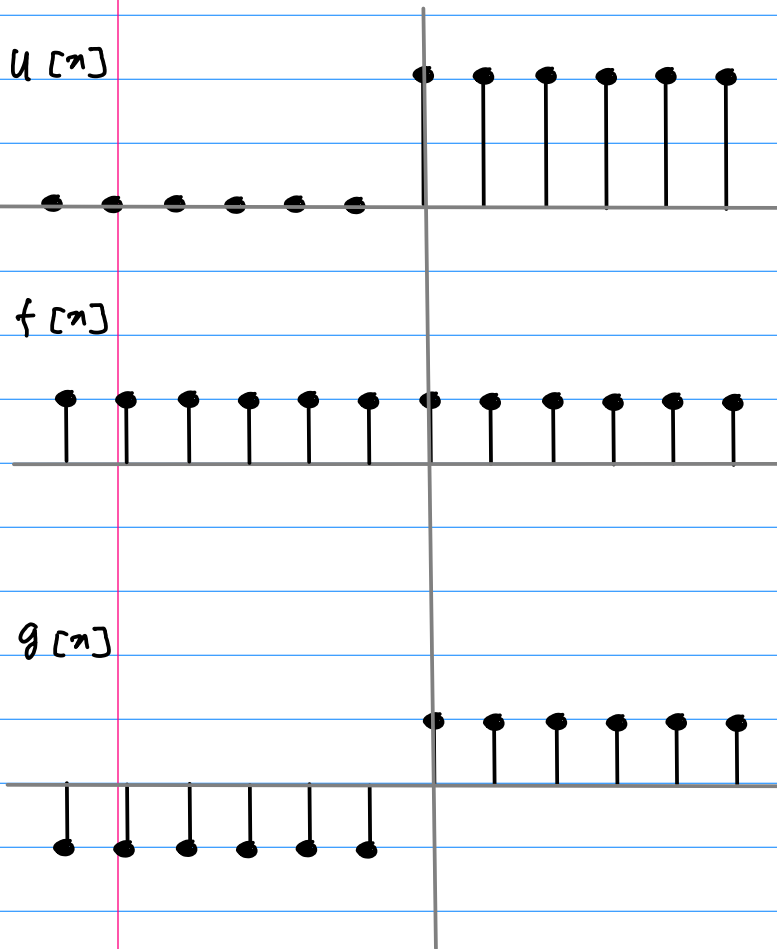

$$f[n] = \frac{1}{2} \quad -\infty < n < \infty$$

$$g[n] = \begin{cases} \frac{1}{2} & n \geq 0 \\ -\frac{1}{2} & n < 0 \end{cases}$$

$$u[n] = f[n] + g[n]$$

$$\delta[n] = g[n] - g[n-1]$$

$$1 = G(e^{j\omega}) - e^{-j\omega} G(e^{j\omega})$$

$$G(e^{j\omega}) = \frac{1}{1 - e^{-j\omega}}$$

$$F(e^{j\omega}) = \pi \sum_{k=-\infty}^{+\infty} \delta(\omega - 2\pi k) \quad (\text{impulse train})$$

$$U(e^{j\omega}) = \frac{1}{1 - e^{-j\omega}} + \pi \sum_{k=-\infty}^{+\infty} \delta(\omega - 2\pi k)$$

Discrete Time Exponential r^n

continuous time exponential $e^{\lambda t}$

$$\begin{aligned}e^{\lambda t} &= r^t & (e^{\lambda})^t &= r^t \\e^{\lambda} &= r \\ \lambda &= \ln r\end{aligned}$$

$$\begin{aligned}e^{-0.03t} &= (0.9408)^t \\ 4^t &= e^{1.386t}\end{aligned}$$

continuous time analysis $e^{\lambda t}$

discrete time analysis r^n

$$\begin{aligned}e^{\lambda n} &= r^n & (e^{\lambda})^n &= r^n \\e^{\lambda} &= r \\ \lambda &= \ln r\end{aligned}$$

$e^{\lambda n}$

Exponentially grows if $\text{Re } \lambda > 0$ (λ in RHP)

exponentially decays if $\text{Re } \lambda < 0$ (λ in LHP)

Oscillates or constant if $\text{Re } \lambda = 0$ (λ in imag axis)

the location of λ in the complex plain indicates whether

① $e^{\lambda t}$ will grow exponentially

② $e^{\lambda t}$ will decay exponentially

③ $e^{\lambda t}$ will oscillates with constant amplitude

constant signal : oscillation with zero frequency

$e^{j\Omega n}$ $\lambda = j\Omega$ imaginary axis

(constant amplitude oscillating signal)

$$e^{j\Omega n} = (e^{j\Omega})^n = \gamma^n \quad \gamma = e^{j\Omega} \quad |\gamma| = 1$$

$\lambda = j\Omega$ imaginary axis $\rightarrow |\gamma| = 1$ unit circle

if γ lies on the unit circle,

γ^n oscillates with constant amplitude

the imaginary axis in the λ plane

the unit circle in the γ plane

$e^{\lambda n}$ $\lambda = a + jb$ in the LHP ($a < 0$)
exponentially decaying

$$r = e^{\lambda} = e^{a+jb} = e^a e^{jb}$$

$$|r| = |e^{\lambda}| = |e^a \cdot e^{jb}| = |e^a| = e^a$$

$|r| = e^a < 1$ inside the Unit circle

r^n : exponentially decaying

$|r| = e^a > 1$ outside the Unit circle

r^n : exponentially growing

λ -plane

the imaginary axis

the LHP

the RHP



z -plane

the unit circle

inside of the unit circle

outside of the unit circle



