

Applications of Pointers (1A)

Copyright (c) 2010 - 2018 Young W. Lim.

Permission is granted to copy, distribute and/or modify this document under the terms of the GNU Free Documentation License, Version 1.2 or any later version published by the Free Software Foundation; with no Invariant Sections, no Front-Cover Texts, and no Back-Cover Texts. A copy of the license is included in the section entitled "GNU Free Documentation License".

Please send corrections (or suggestions) to youngwlim@hotmail.com.

This document was produced by using LibreOffice.

Array of Pointers

Array of Pointers

```
int    a [4];  
int *  b [4];
```

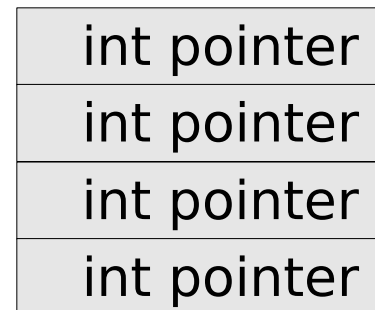
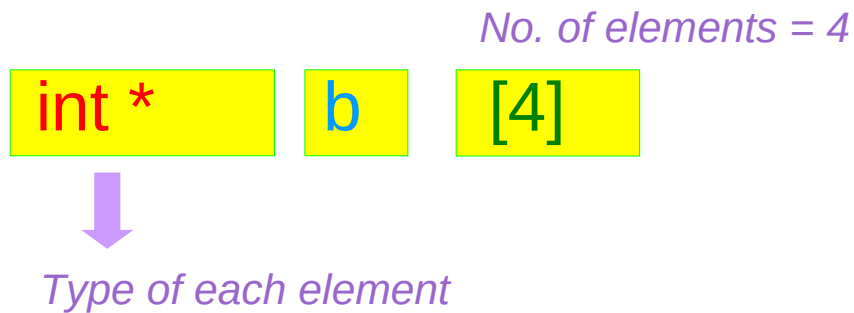
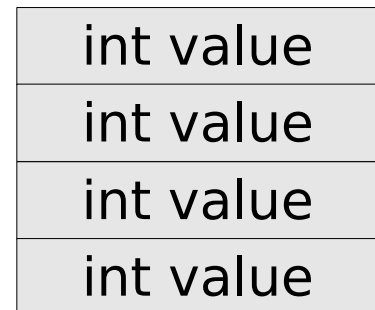
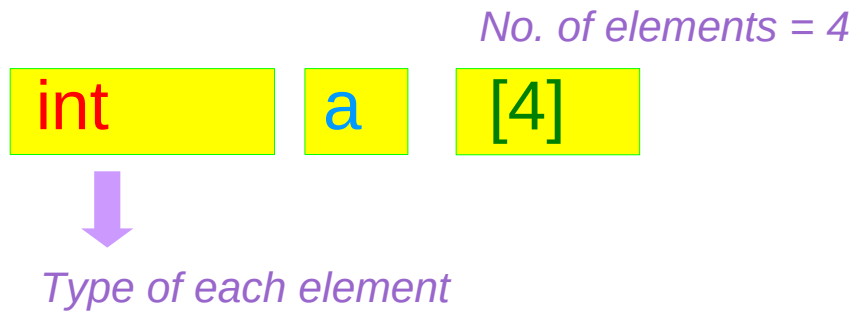

Array of Pointers – a type view

```
int a [4];
```

```
int * b [4];
```

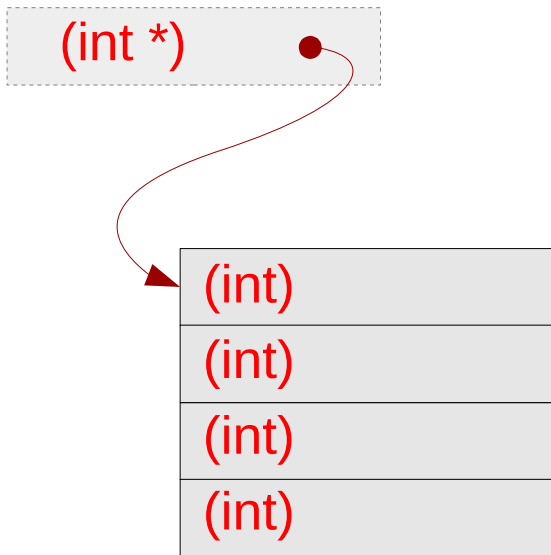

Integers

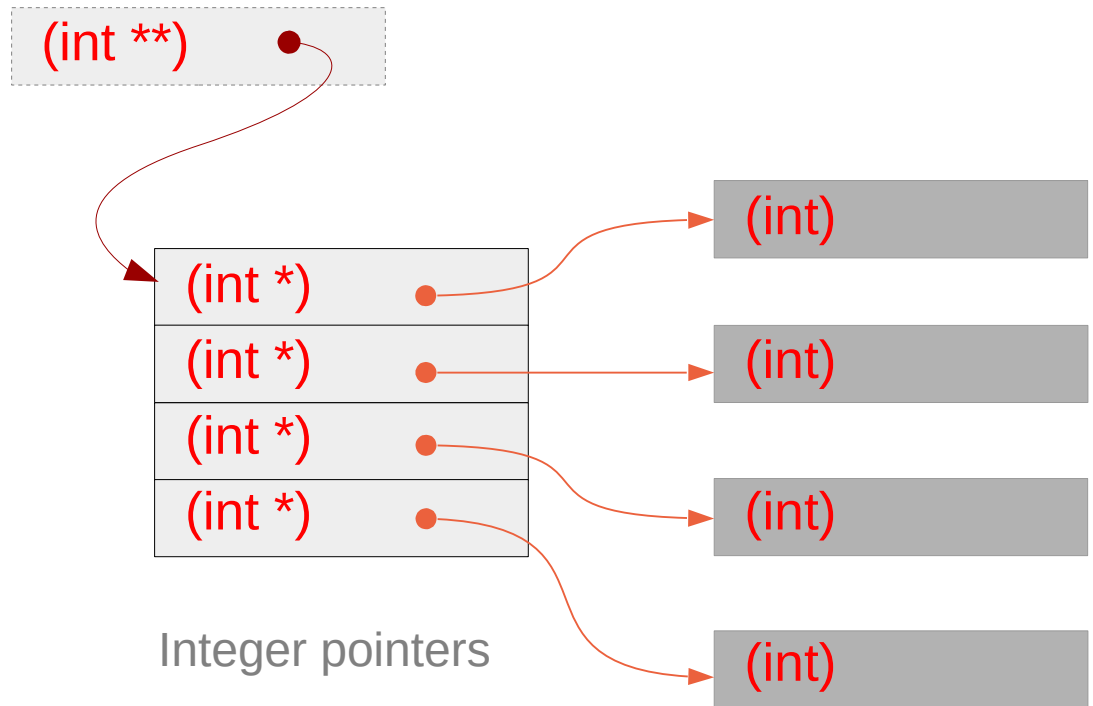

Integer pointers
taking actual
memory locations

Array of Pointers – a variable view

```
int a[4];
```

```
int * b[4];
```

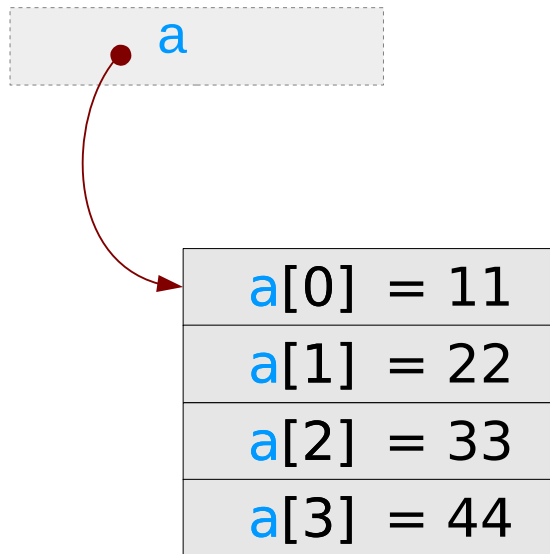

Integers

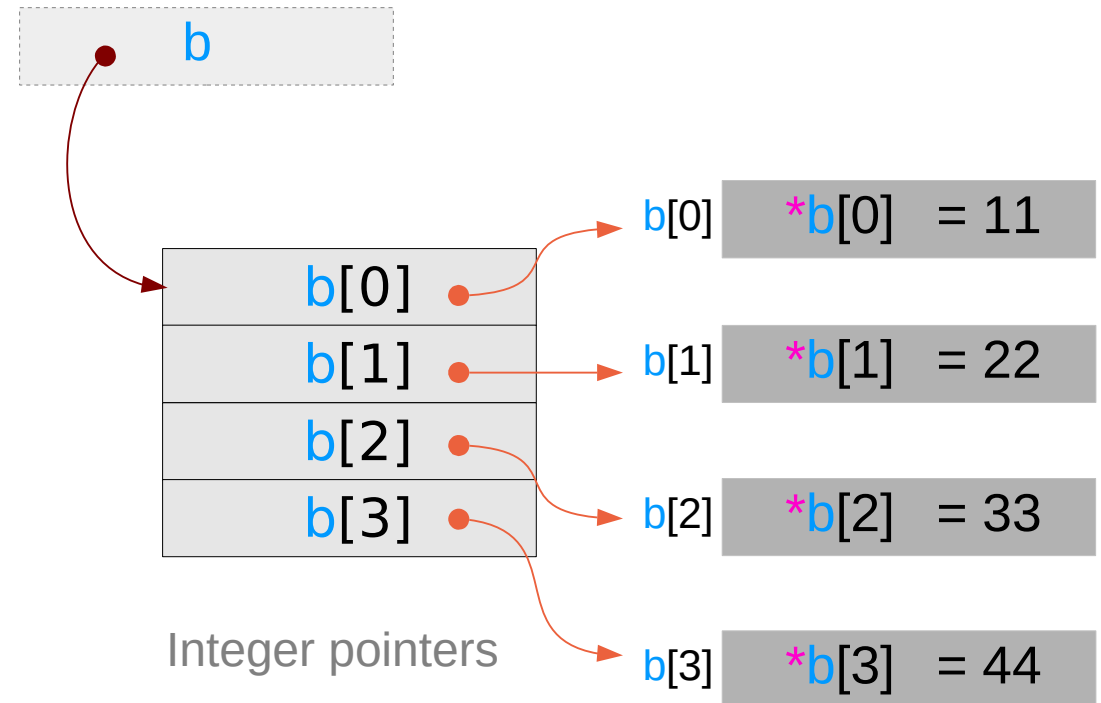

Integer pointers

Array of Pointers – assigning a 1-d array name

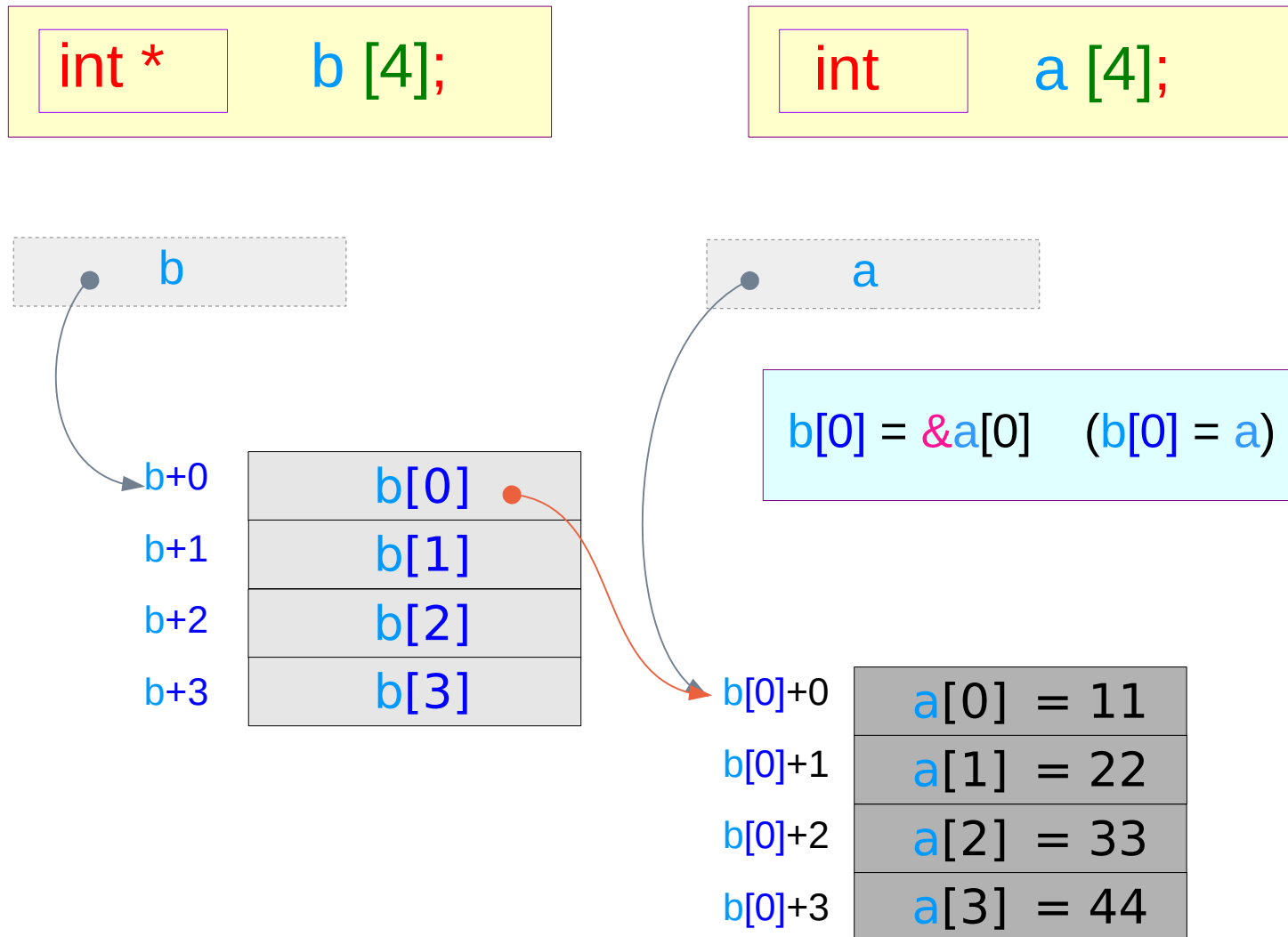

Array of Pointers – an extended dimension

```
int * b [4];
```

assignment `b[0] = a`

equivalence

$$\begin{aligned} a[0] &\equiv b[0][0] \equiv *((*(b+0)+0)) \\ a[1] &\equiv b[0][1] \equiv *((*(b+0)+1)) \\ a[2] &\equiv b[0][2] \equiv *((*(b+0)+2)) \\ a[3] &\equiv b[0][3] \equiv *((*(b+0)+3)) \end{aligned}$$

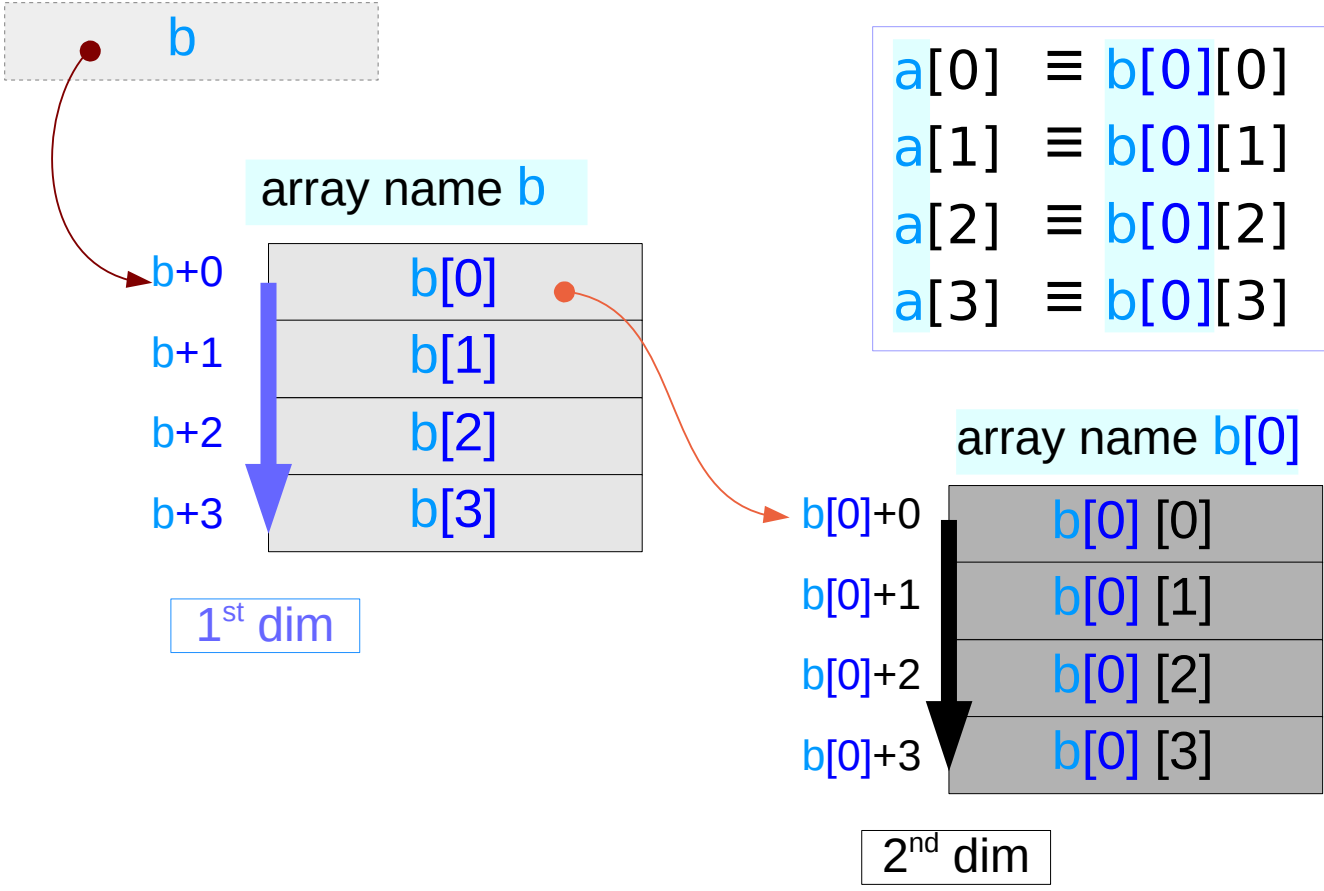

Array of Pointers – assigning other 1-d array names

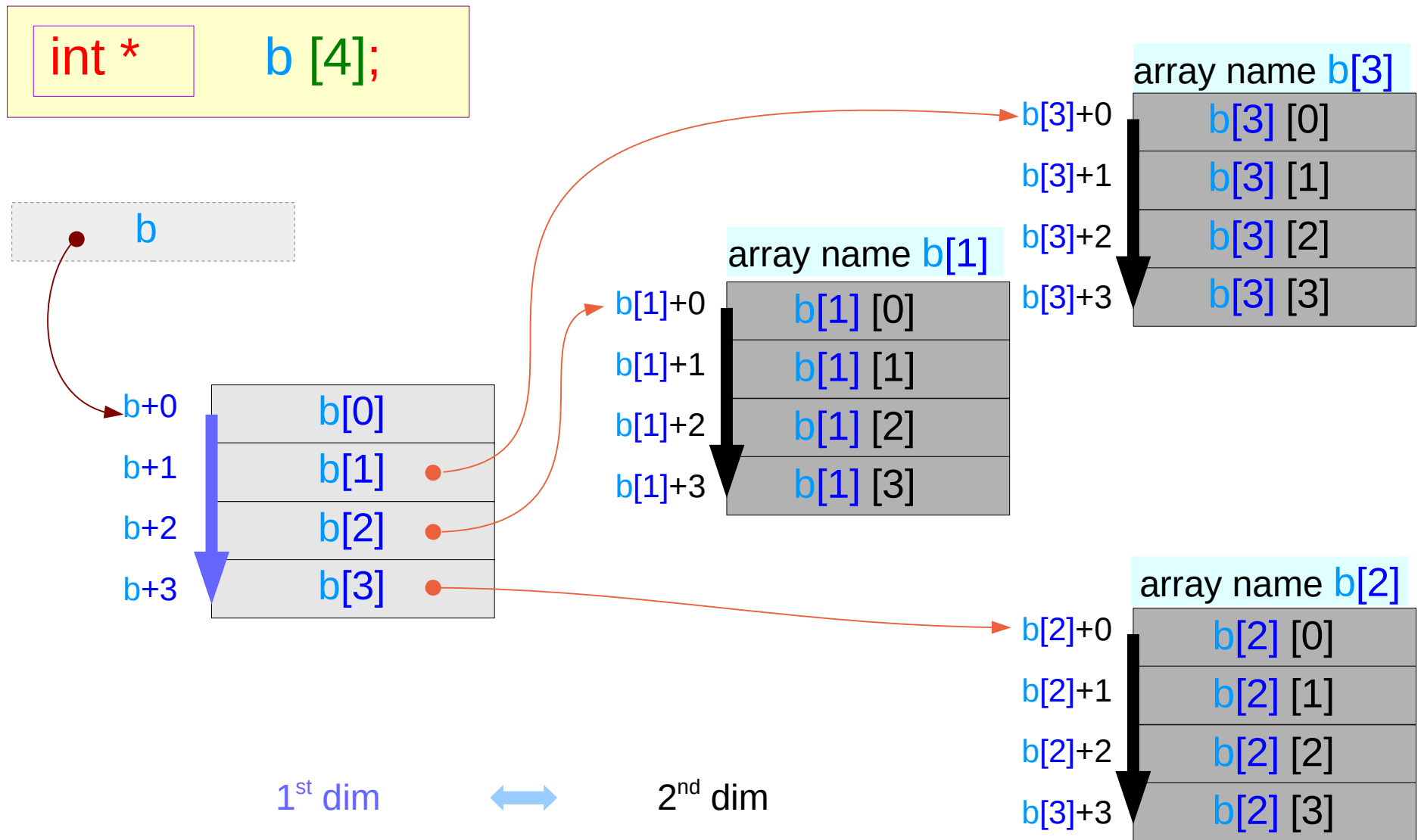

2-d access of a 1-d array – using a pointer array

```
int * b [4];
```

```
int a [4*4];
```

```
b[0] = &a[0*4] (b[0] = a+ 0)  
b[1] = &a[1*4] (b[1] = a+ 4)  
b[2] = &a[2*4] (b[2] = a+ 8)  
b[3] = &a[3*4] (b[3] = a+12)
```



2-d access of a 1-d array

$$b[i][j] \equiv *((*(b+i)+j))$$
$$a[i*4+j] \equiv *(a + i*4+j)$$

1-d access of a 1-d array

3-d access of a 1-d array – using pointer arrays

int	a [4*4*4];
int *	b [4*4];
int **	c [4];



a[i]	≡	*(a+i)
b[i][j]	≡	*(*(b+i)+j)
c[i][j][k]	≡	*(*(*(c+i)+j)+k)

3-d access of a 1-d array – pointer array assignment

```
int    a [4*4*4];  
int *  b [4*4];  
int ** c [4];
```

```
a[i]    ≡ *(a+i)  
b[i][j] ≡ *(*b+i)+j  
c[i][j][k] ≡ *(*(*c+i)+j)+k
```

```
for (i=0; i<4; ++i)  
    c[i] = &b[i*4];  
  
for (i=0; i<4*4; ++i)  
    b[i] = &a[i*4]
```



3-d access of a 1-d array

```
c[i][j][k] ≡  
a[i*M*N+j*N+k] ≡  
a[(i*M + j)*N+k]
```

1-d access of a 1-d array

Initialization of pointer arrays **b** and **c**

3-d Array – using pointer arrays **b**, **c**

```
int **   c [4];  
int *    b [4*4];
```

```
int      a [4*4*4];
```

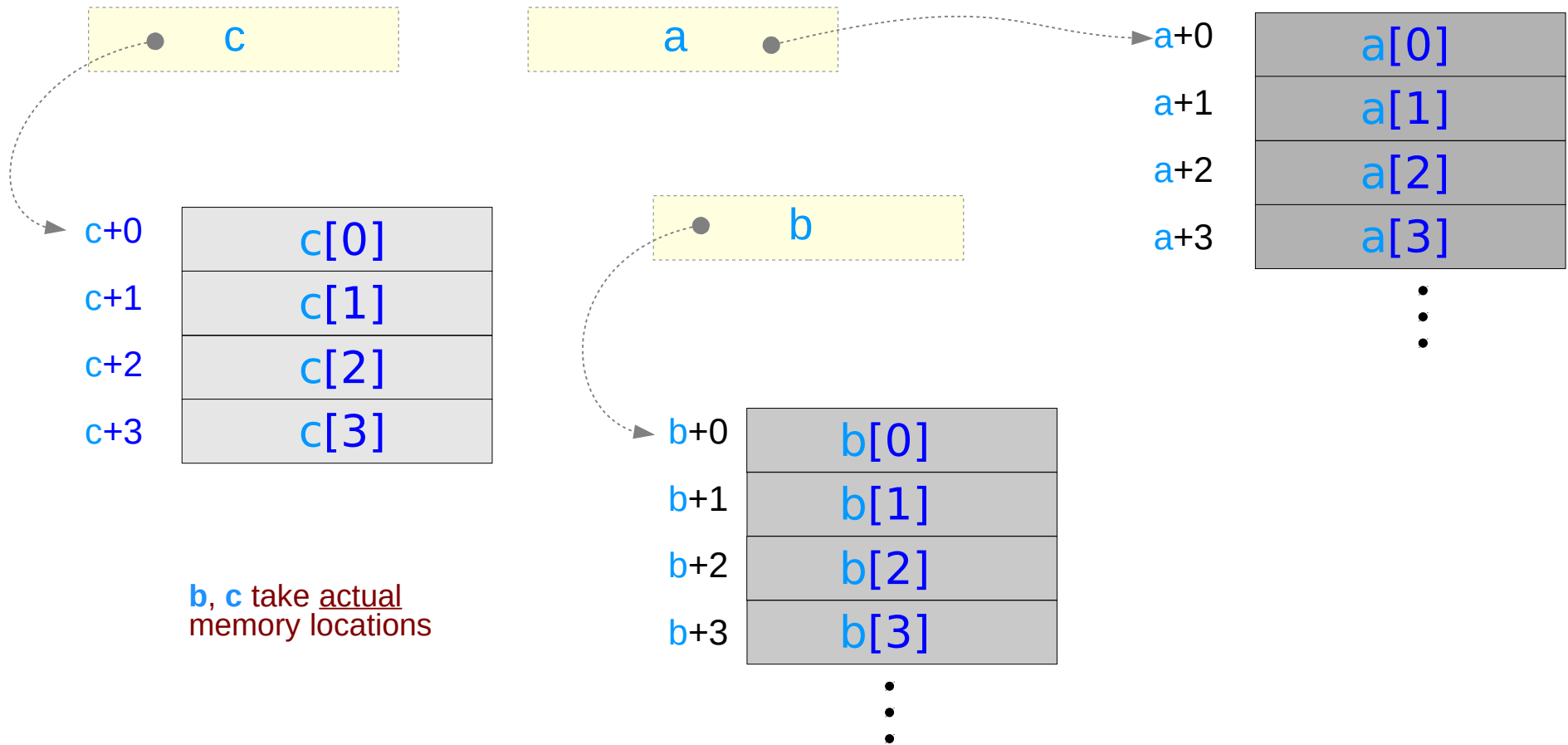

3-d Array – pointer arrays extend dimensions

```
int ** c [4];  
int * b [4*4];
```

```
c[0] = b;      (c[0] = &b[0];)  
b[0] = a;      (b[0] = &a[0];)
```

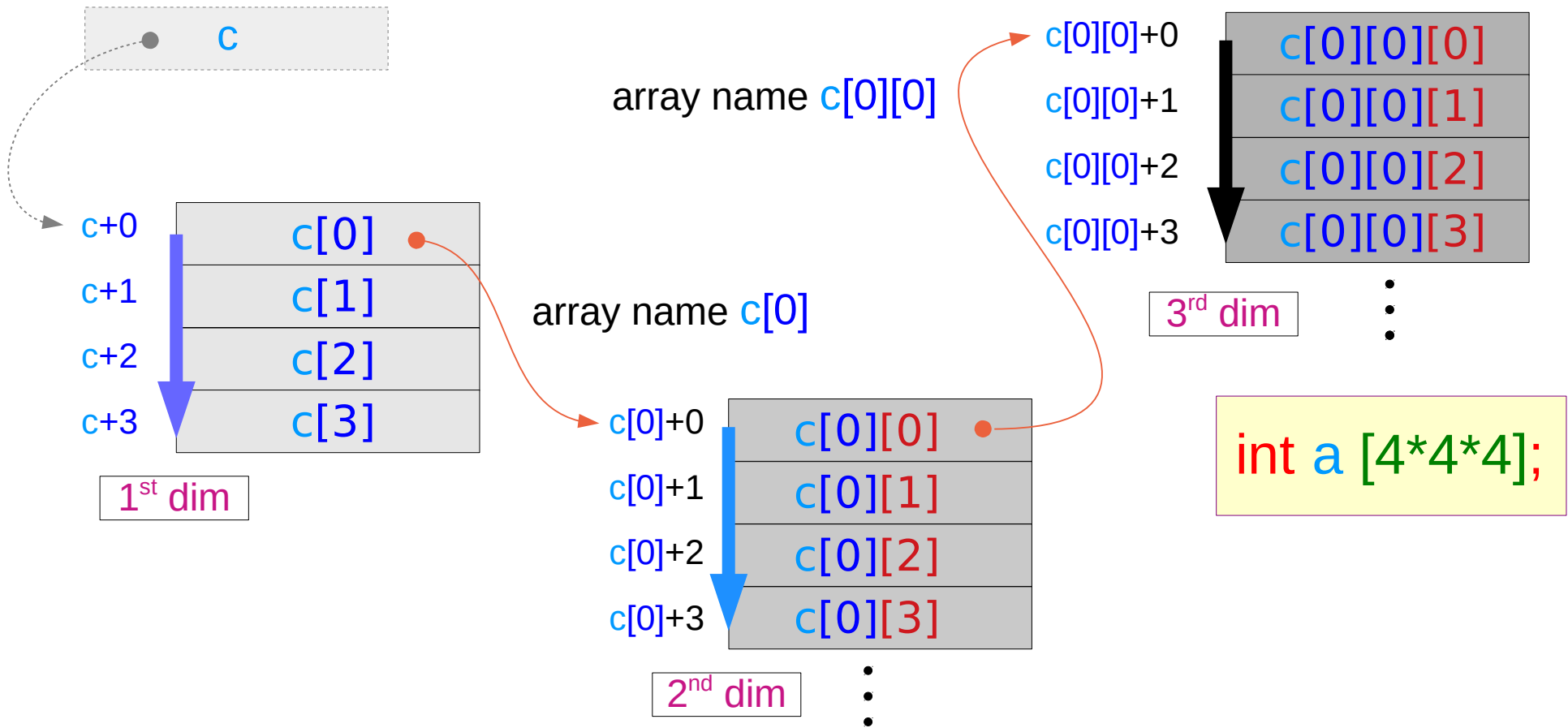

Using recursive pointers and brackets

$c[i][j][k]$	\rightarrow	$*(c[i][j] + k)$	$X[k] = *(X+k)$
$*(c[i][j] + k)$	\rightarrow	$*(*(c[i] + j) + k)$	$Y[j] = *(Y+j)$
$*(*(c[i] + j) + k)$	\rightarrow	$*(*(*(c + i) + j) + k)$	$Z[i] = *(Z+i)$

$c[i][j][k]$	\leftrightarrow	$*(*(*(c+i)+j)+k)$
--------------	-------------------	--------------------

Initializing two 1-d pointer arrays **b**, **c**

```
int    a [2*3*4];  
int*   b [2*3];  
int**  c [2];
```

```
c[0] = &b[0*3];  
c[1] = &b[1*3];
```

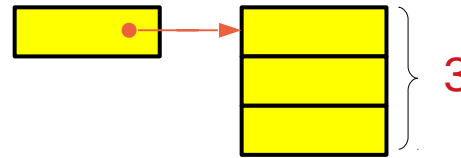

```
int c[2];  
int b[2*3];
```

```
b[0] = &a[0*4];  
b[1] = &a[1*4];  
b[2] = &a[2*4];  
b[3] = &a[3*4];  
b[4] = &a[4*4];  
b[5] = &a[5*4];
```

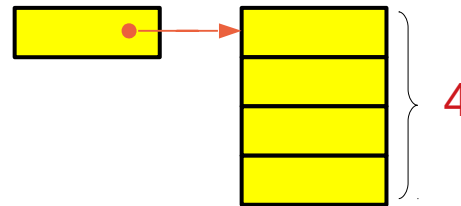

```
int b[2*3];  
int a[2*3*4];
```

Initialization of pointer arrays – a general case

```
int a [L*M*N];
```

```
int* b [L*M];  
int** c [L];
```

pointer arrays b, c

```
int ** c[L];  
int * b[L*M];
```

```
for (i=0; i<L; ++i)  
c[i] = &b[i*M];
```

```
int * b[L*M];  
int a[L*M*N];
```

```
for (j=0; j<L*M; ++j)  
b[j] = &a[j*N];
```



```
int c [L][M][N];
```

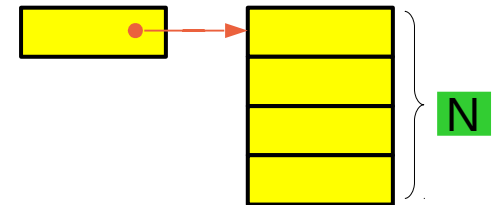
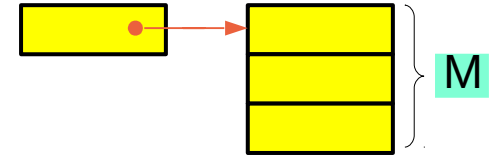

Accessing the array **a** as a **1-d** array

```
int    a [2*3*4];  
int*   b [2*3];  
int**  c [2];
```



```
int    a [24];
```

b, **c** take actual memory locations

int** c [2];

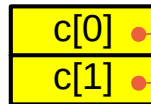

int* b [2*3];

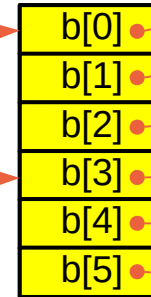

int a [2*3*4];

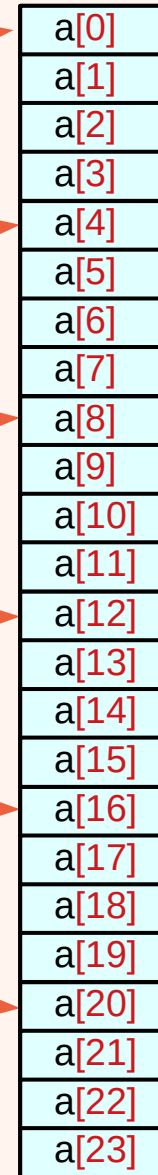

24=2*3*4

```
c[i][j][k] ≡ *(*(*c+i)+j)+k  
b[i][j]    ≡ *(*b+i)+j  
a[i]       ≡ *(a+i)
```

```
int c[2][3][4] ;  
int b[2*3][4] ;  
int a[2*3*4] ;
```

Accessing the array **a** as a 2-d array using **b**

```
int    a [2*3*4];  
int*   b [2*3];  
int**  c [2];
```

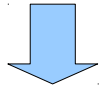

```
int    b [6][4];
```

b, **c** take actual memory locations

int** c [2];

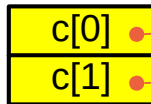

int* b [2*3];

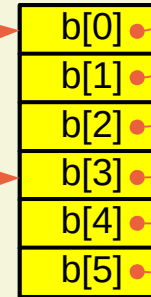

int a [2*3*4];

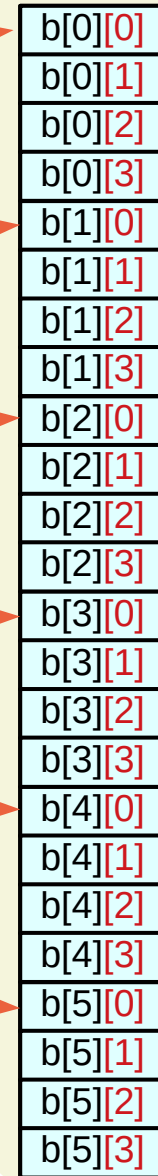

24=2*3*4

```
c[i][j][k] ≡ *(*(*c+i)+j)+k    int c[2][3][4] ;  
b[i][j]    ≡ *(*(*b+i)+j)      int b[2*3][4] ;  
a[i]       ≡ *(*a+i)            int a[2*3*4] ;
```

Accessing the array **a** as a **3-d** array using **c**

```
int    a [2*3*4];  
int*  b [2*3];  
int** c [2];
```



```
int    c [2][3][4];
```

b, **c** take actual memory locations

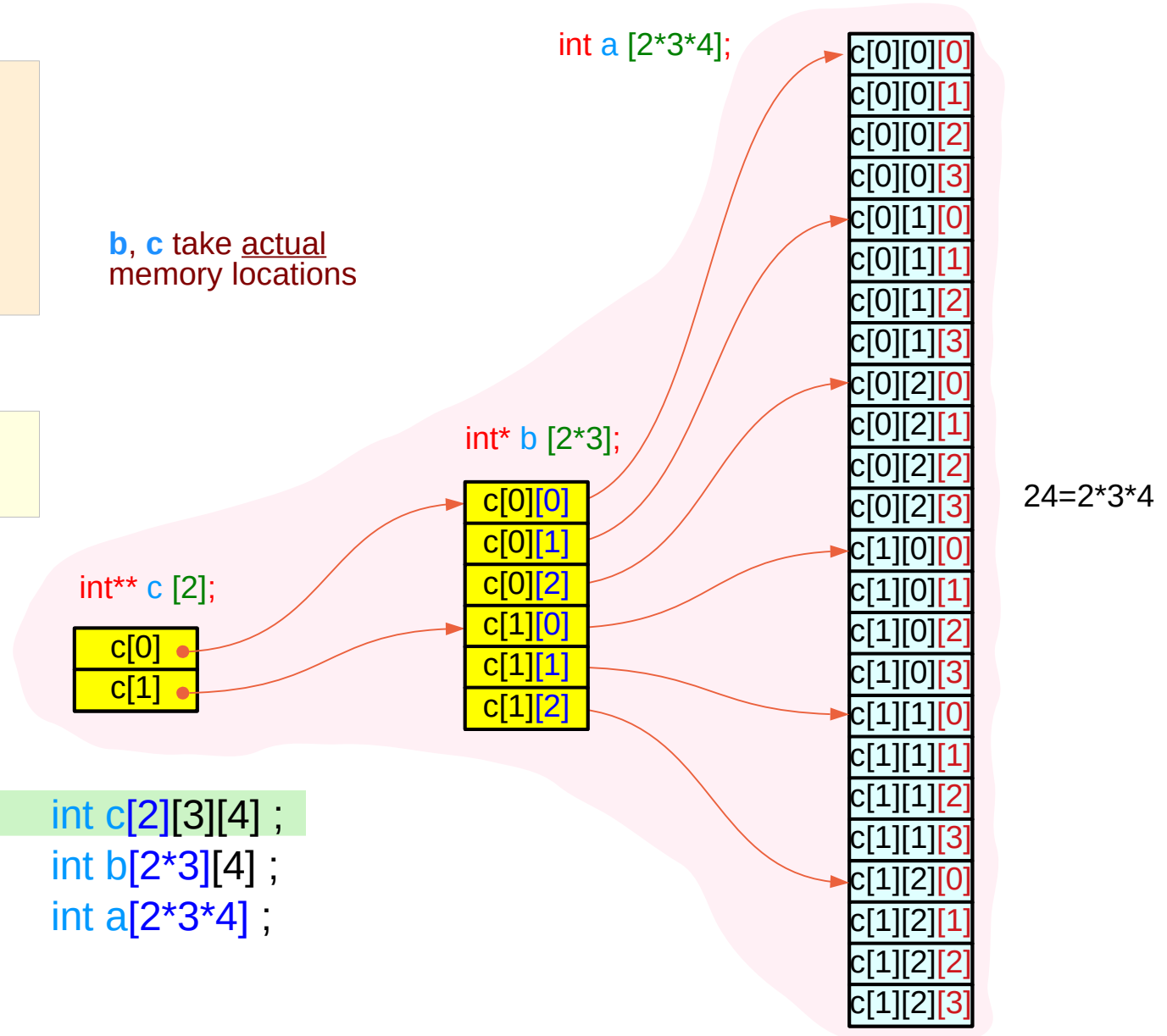

```
c[i][j][k] ≡ *(*(*c+i)+j)+k    int c[2][3][4];  
b[i][j]   ≡ *(*b+i)+j          int b[2*3][4];  
a[i]      ≡ *(a+i)              int a[2*3*4];
```

Array names of 2-d and 1-d sub-arrays

```
int    a [2*3*4];  
int*   b [2*3];  
int**  c [2];
```



```
int    c [2][3][4];
```

`c[0]` array name of a 2-d array [M][N]
`c[1]` array name of a 2-d array [M][N]

`c[0][0][0] = a[0*M*N]`
`c[1][0][0] = a[1*M*N]`

starting elements

`&c[0][0][0] = c[0][0]`
`&c[1][0][0] = c[1][0]`

`c[0][0]` array name of a 1-d array [N]
`c[0][1]` array name of a 1-d array [N]
`c[0][2]` array name of a 1-d array [N]
`c[1][0]` array name of a 1-d array [N]
`c[1][1]` array name of a 1-d array [N]
`c[1][2]` array name of a 1-d array [N]

`c[0][0][0] = a[(0*M+0)*N]`
`c[0][1][0] = a[(0*M+1)*N]`
`c[0][2][0] = a[(0*M+2)*N]`
`c[1][0][0] = a[(1*M+0)*N]`
`c[1][1][0] = a[(1*M+1)*N]`
`c[1][2][0] = a[(1*M+2)*N]`

starting elements

`&c[0][0][0] = c[0][0]`
`&c[0][1][0] = c[0][1]`
`&c[0][2][0] = c[0][2]`
`&c[1][0][0] = c[1][0]`
`&c[1][1][0] = c[1][1]`
`&c[1][2][0] = c[1][2]`

Starting element Index

```

int    a [L*M*N];
int*   b [L*M];
int**  c [L];

↓

int    c [L][M][N];
    
```

- L=2**
- i=0 $i*3*4 = 0$
 - i=1 $i*3*4 = 12$
- M=3**
- j=0 $j*4 = 0$
 - j=1 $j*4 = 4$
 - j=2 $j*4 = 8$
- N=4**
- k=0 $k*1 = 0$
 - k=1 $k*1 = 1$
 - k=2 $k*1 = 2$
 - k=3 $k*1 = 3$

$c[0][0][0] = a[0]$	0
$c[1][0][0] = a[12]$	12
$c[0][0][0] = a[0]$	0 + 0
$c[0][1][0] = a[4]$	0 + 4
$c[0][2][0] = a[8]$	0 + 8
$c[1][0][0] = a[12]$	12 + 0
$c[1][1][0] = a[16]$	12 + 4
$c[1][2][0] = a[20]$	12 + 8

c[0][0][0]	a[0]
c[0][0][1]	a[1]
c[0][0][2]	a[2]
c[0][0][3]	a[3]
c[0][1][0]	a[4]
c[0][1][1]	a[5]
c[0][1][2]	a[6]
c[0][1][3]	a[7]
c[0][2][0]	a[8]
c[0][2][1]	a[9]
c[0][2][2]	a[10]
c[0][2][3]	a[11]
c[1][0][0]	a[12]
c[1][0][1]	a[13]
c[1][0][2]	a[14]
c[1][0][3]	a[15]
c[1][1][0]	a[16]
c[1][1][1]	a[17]
c[1][1][2]	a[18]
c[1][1][3]	a[19]
c[1][2][0]	a[20]
c[1][2][1]	a[21]
c[1][2][2]	a[22]
c[1][2][3]	a[23]

L, M, N – the number of index values

```
int    a [L*M*N];  
int*   b [L*M];  
int**  c [L];
```



```
int    c [L][M][N];
```

L	M	N
i [0..L-1]	j [0..M-1]	k [0..N-1]

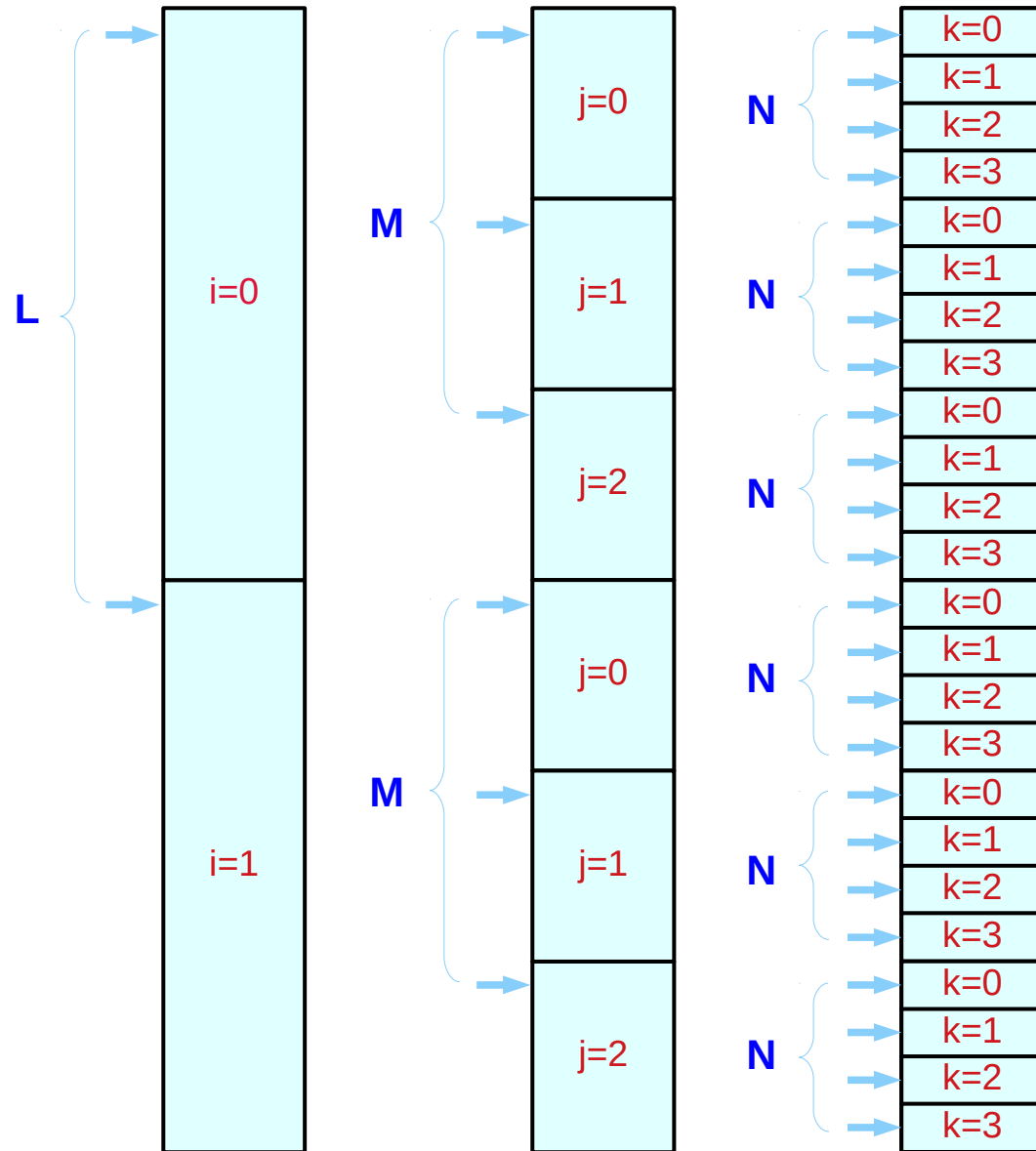

Index value tree – all possible combinations

```
int    a [L*M*N];  
int*  b [L*M];  
int** c [L];
```



```
int    c [L][M][N];
```

L	M	N
i [0..L-1]	j [0..M-1]	k [0..N-1]

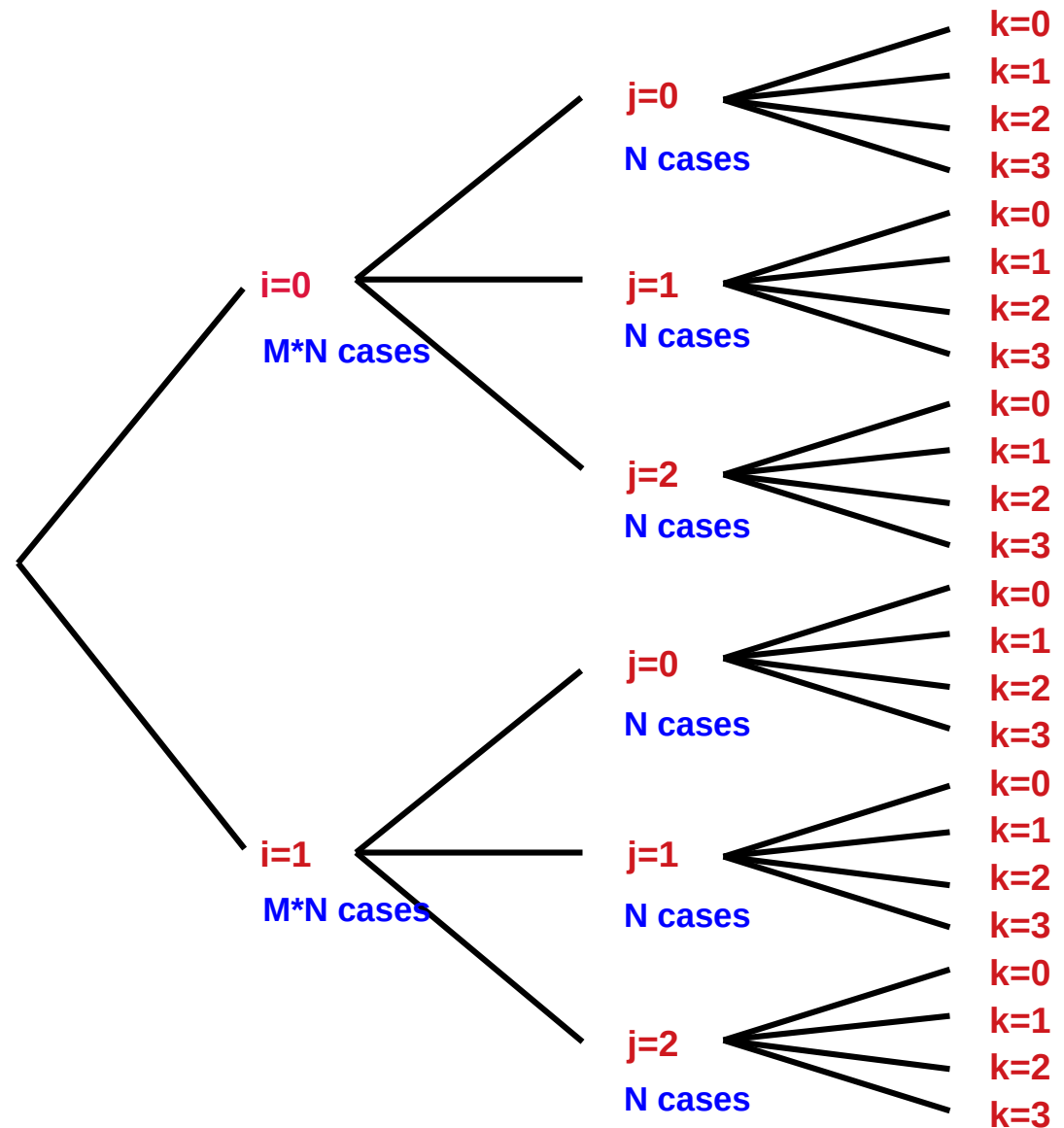

Converting a 3-d index into a 1-d index

```
int    a [L*M*N];  
int*   b [L*M];  
int**  c [L];
```



```
int    c [L][M][N];
```

L	M	N
<i>i</i>	<i>j</i>	<i>k</i>
[0..L-1]	[0..M-1]	[0..N-1]
$i*M*N$	$j*N$	<i>k</i>

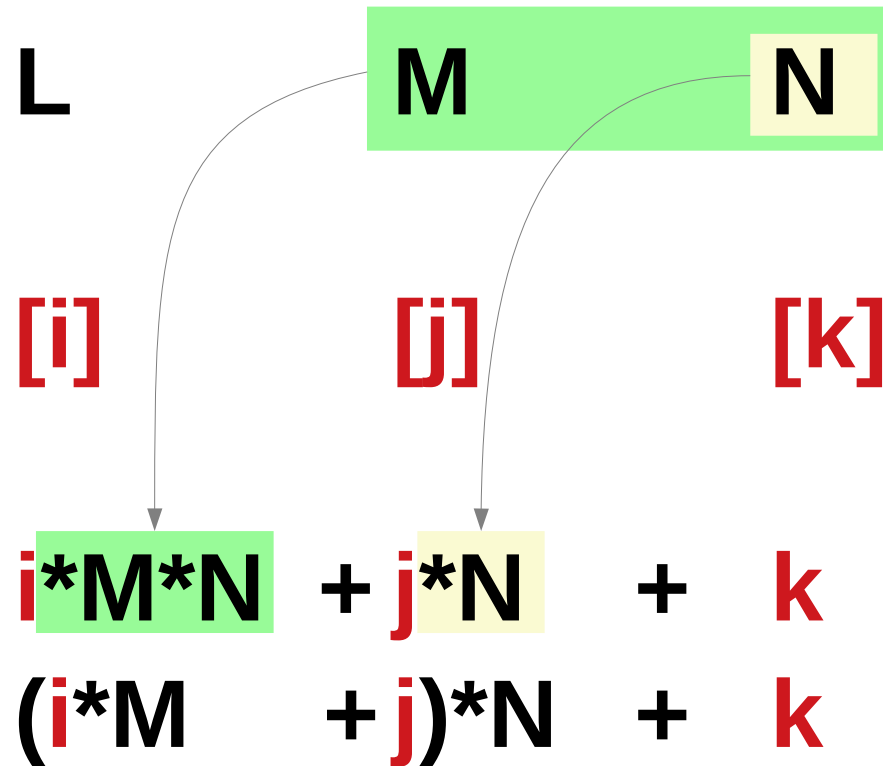

3-d and 1-d accesses (recursive pointers vs. brackets)

```
c[i] = &b[i*M];  
b[j] = &a[j*N];
```



```
c[i][j][k] ≡ a[i*M*N + j*N + k]  
≡ a[(i*M + j)*N + k]
```

```
int ** c[L];  
int * b[L*M];
```

```
for (i=0; i<L; ++i)  
    c[i] = &b[i*M];
```

```
int * b[L*M];  
int a[L*M*N];
```

```
for (j=0; j<L*M; ++j)  
    b[j] = &a[j*N];
```

```
c[i][j][k]
```

```
= *(*(*c+i)+j)+k
```

```
= *(*(c[i]+j)+k)
```

```
= *(*(&b[i*M]+j)+k)
```

```
= *(b[i*M+j]+k)
```

```
= *(&a[(i*M+j)*N]+k)
```

```
= a[(i*M+j)*N+k]
```

```
← c[i] = &b[i*M]
```

```
← *(*(&b[i*M]+j)+k)
```

```
← b[m] = &a[m*N]
```

```
← *(a+(i*M+j)*N+k)
```

$i * M * N$, $j * N$, k – index offset values

```
int a [L*M*N];
int* b [L*M];
int** c [L];
```



```
int c [L][M][N];
```

L	M	N
i	j	k
$[0..L-1]$	$[0..M-1]$	$[0..N-1]$
$i * M * N$	$j * N$	k

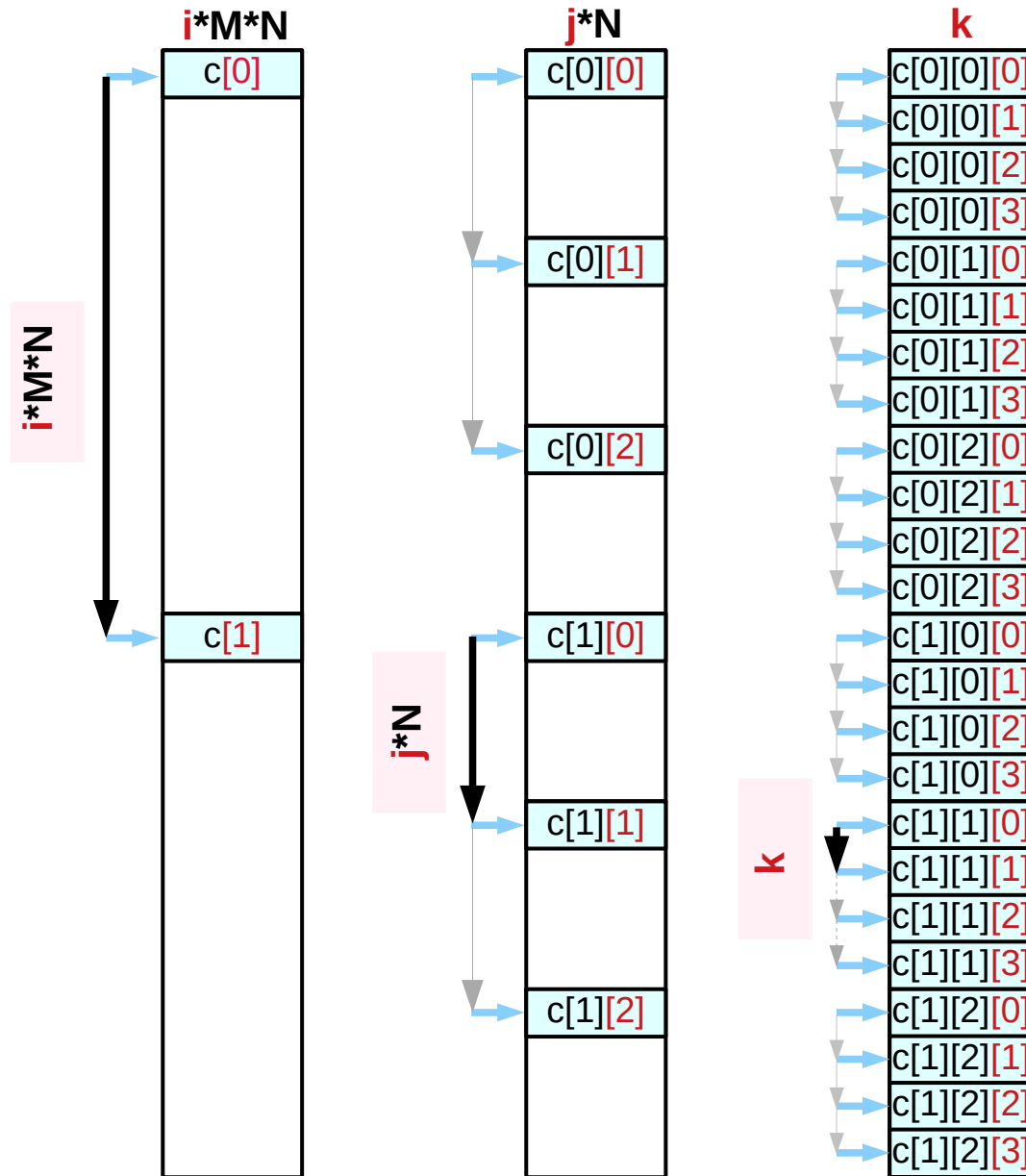

24=2*3*4

Accessing `a` by base and offset indices

```
int    a [L*M*N];
int*   b [L*M];
int**  c [L];
```



```
int    c [L][M][N];
```

L	M	N
<i>i</i>	<i>j</i>	<i>k</i>
[0..L-1]	[0..M-1]	[0..N-1]
$i*M*N$	$j*N$	k

Base Index = 0

Offset Index 1

Offset Index 2

Offset Index 3

$$(i*M*N + j*N + k)$$

$$((i*M + j)*N + k)$$



$$24 = 2 * 3 * 4$$

Base and Offset Addressing

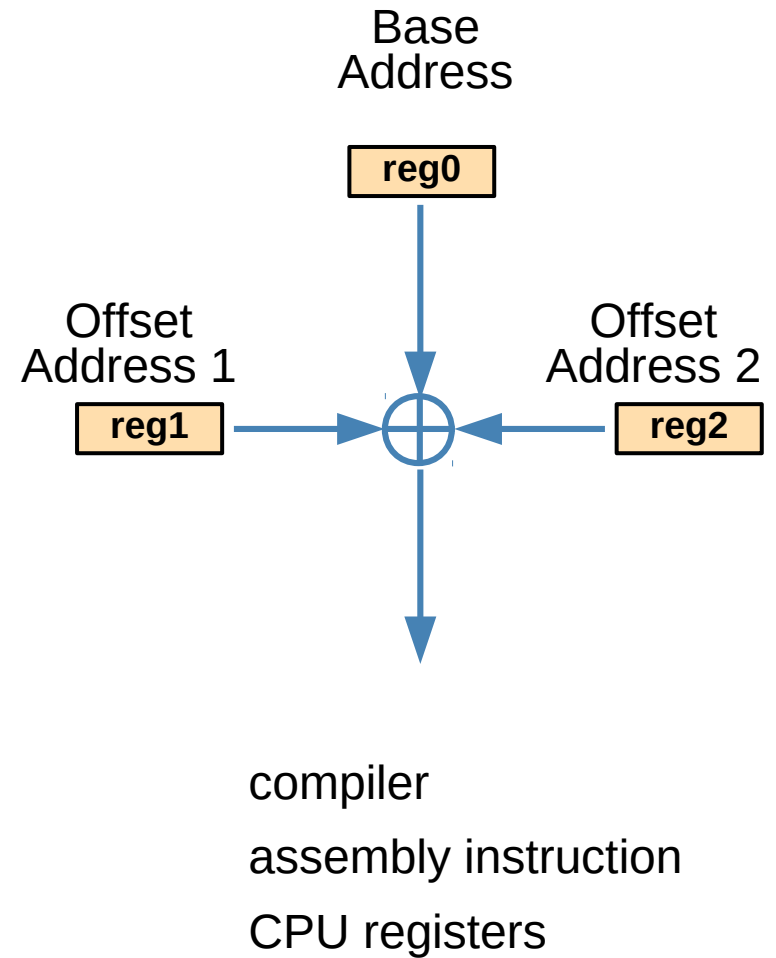
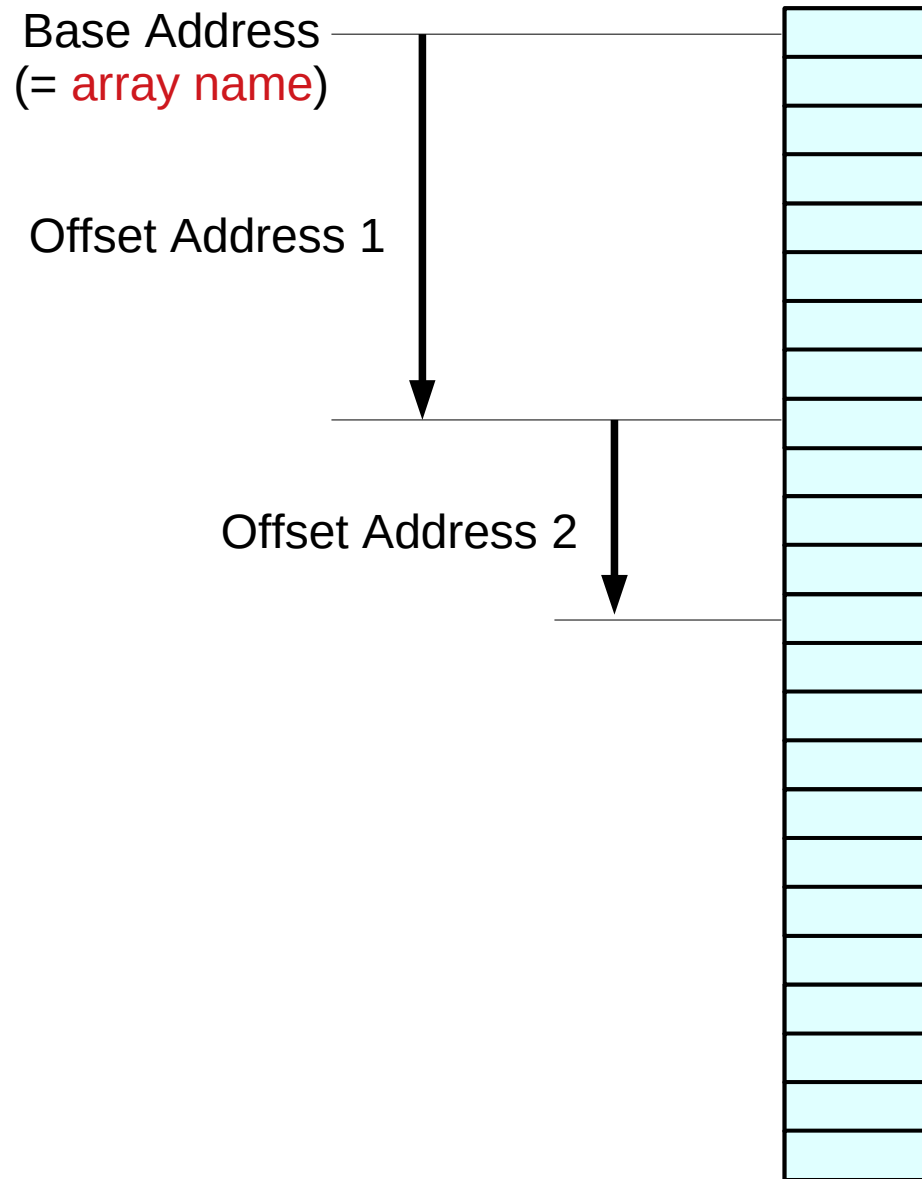

Pointer Array vs. Array Pointer

explicit memory locations
for pointer arrays

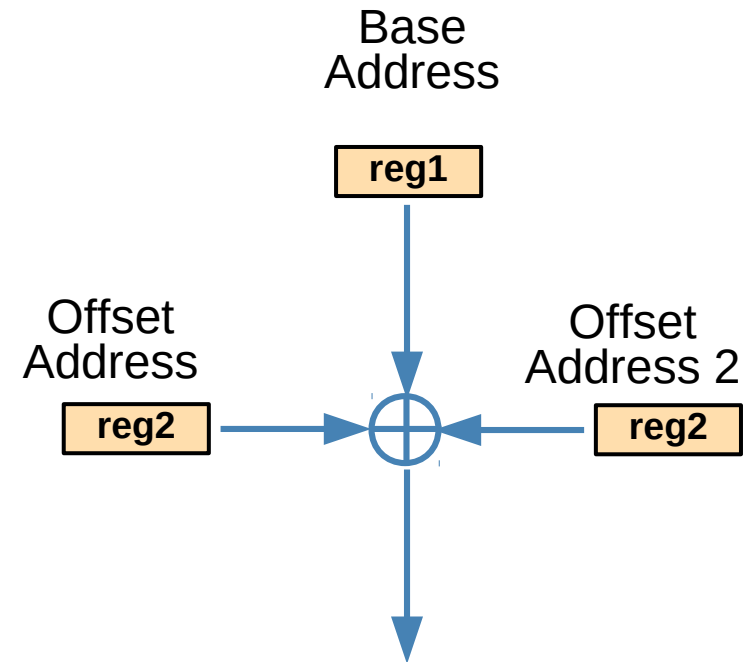
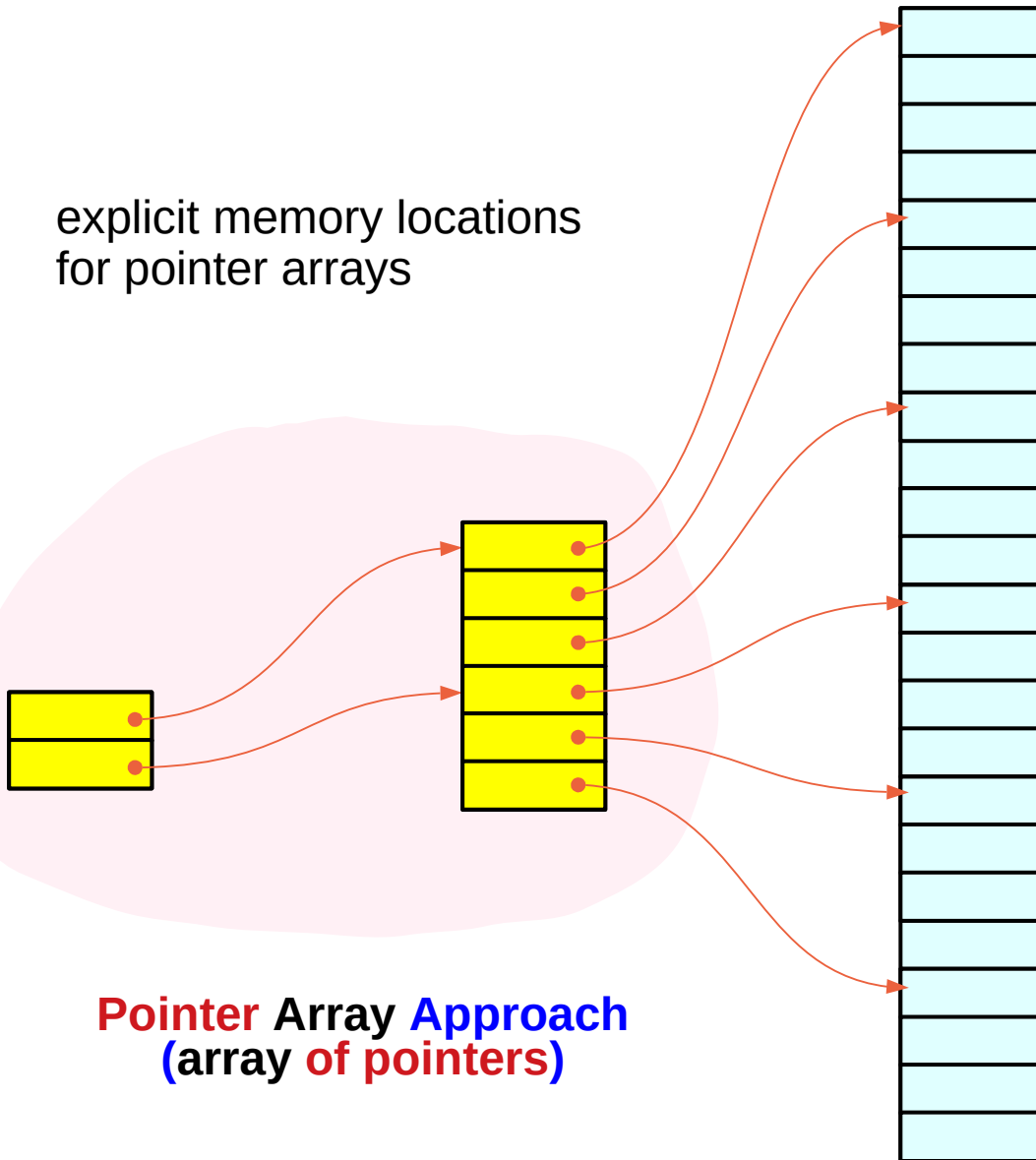

CPU register based address
computations eliminate the
pointer arrays

Array Pointer Approach
(pointer to arrays)

Pointer to an array – variable declarations

```
int m ;
```

```
int *n ;
```

an integer pointer

Array **Pointer Approach**
(**pointer to arrays**)

```
int a [4]
```

```
int (*p) [4]
```

an array pointer

```
int func (int a, int b) ;
```

```
int (*fp) (int a, int b) ;
```

a function pointer

Pointer to an array – a type view

int 4 byte data

int *

an integer pointer

array pointer:
a pointer to an array

pointer array:
an array of pointers

int [4] 4*4 byte data

int (*) [4]

an array pointer

int (int, int) instructions

int (*) (int, int)

a function pointer

Pointer to an array : assignment and equivalence

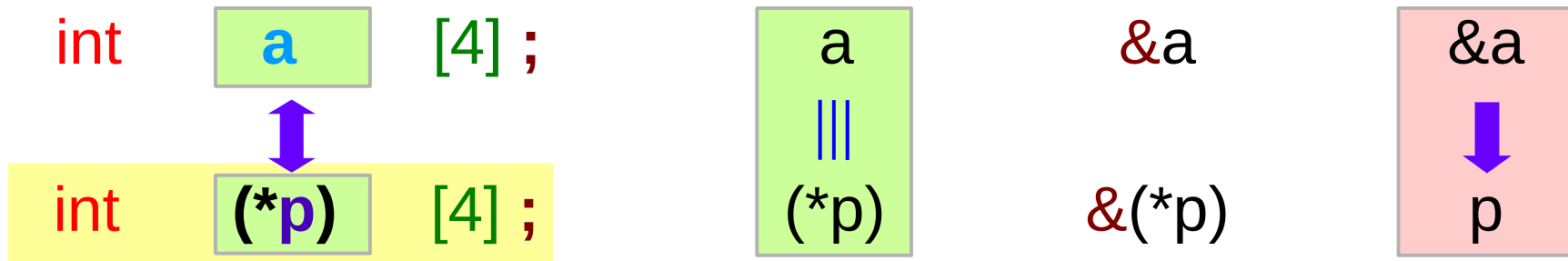

1-d array pointer

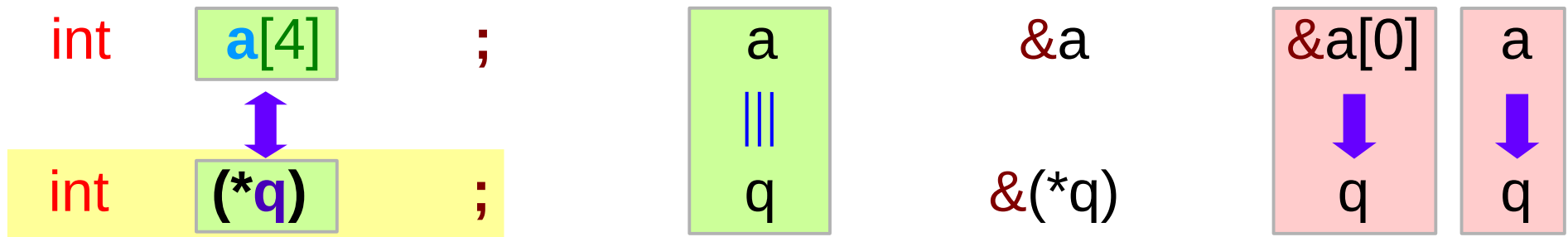

0-d array pointer (= int pointer)

Pointer to an array : size of array

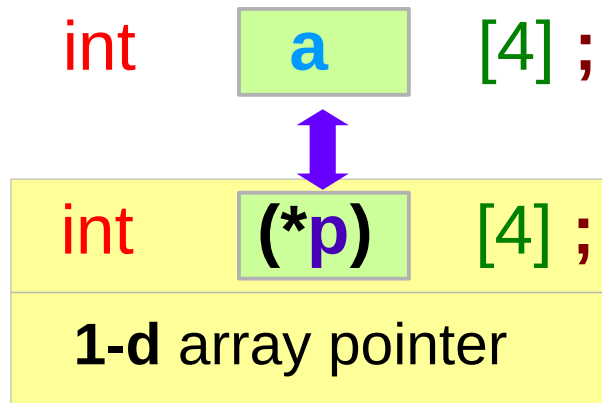

`p = &a;`

`sizeof(p)` = 8 bytes : the size of a pointer
`sizeof(*p)` = 4*4 bytes : the whole size of the pointed 1-d array

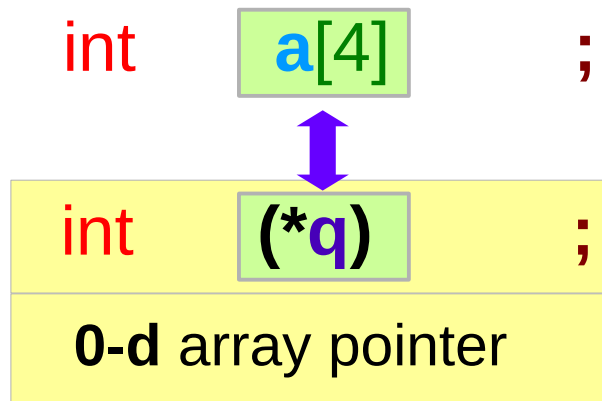

`q = a;`

`sizeof(q)` = 8 bytes : the size of a pointer
`sizeof(*q)` = 4 bytes : the whole size of the pointed 0-d array

Pointer to an array – a variable view (1)

```
int (*p) [4];
```

assignment
 $p = \&a$

equivalence
 $*p \equiv a$

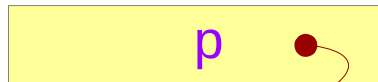

1-d array pointer

points to a **1-d** array –
a aggregated type data

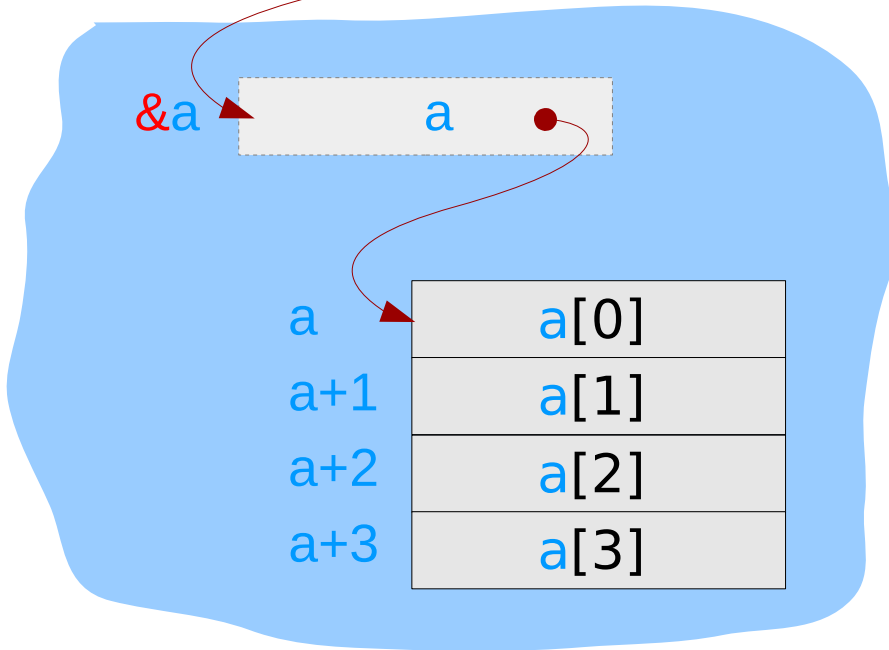

```
int a [4];
```

$p : \text{int } (*) [4]$ type

Pointer to an array – a variable view (2)

```
int (*q);
```

assignment

```
q = &a[0];  
q = a
```

equivalence

```
*q ≡ *a  
q ≡ a
```

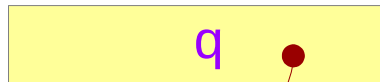

0-d array pointer

points to an array element –
an integer type data

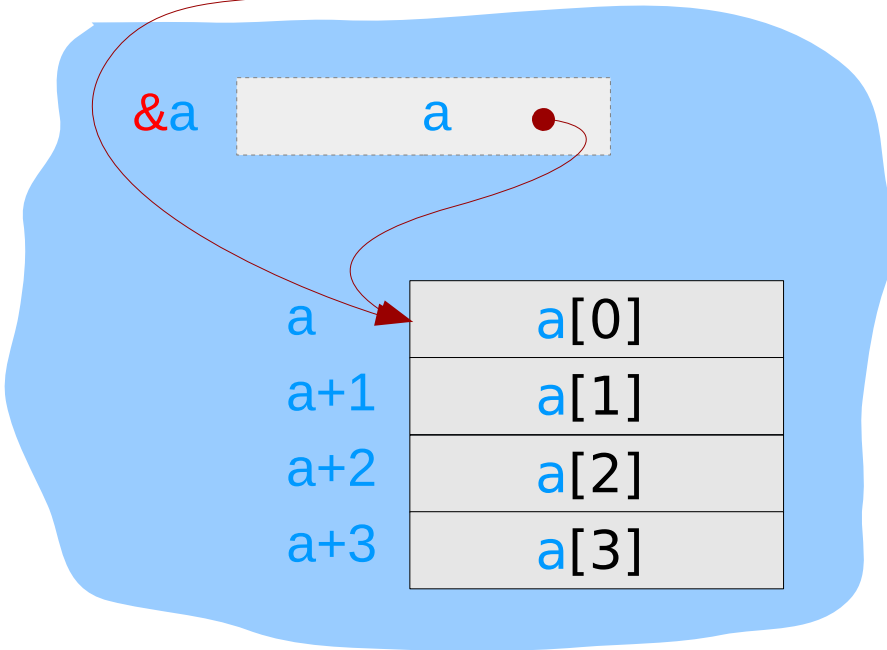

```
int a[4];
```

$q : \text{int } (*) = \text{int } * \text{ type}$

Pointer to a 1-d array – an aggregated type view

```
int (*p) [4];
```

- An aggregated type
- starting address (&a)
 - size of all the array elements (16 bytes)

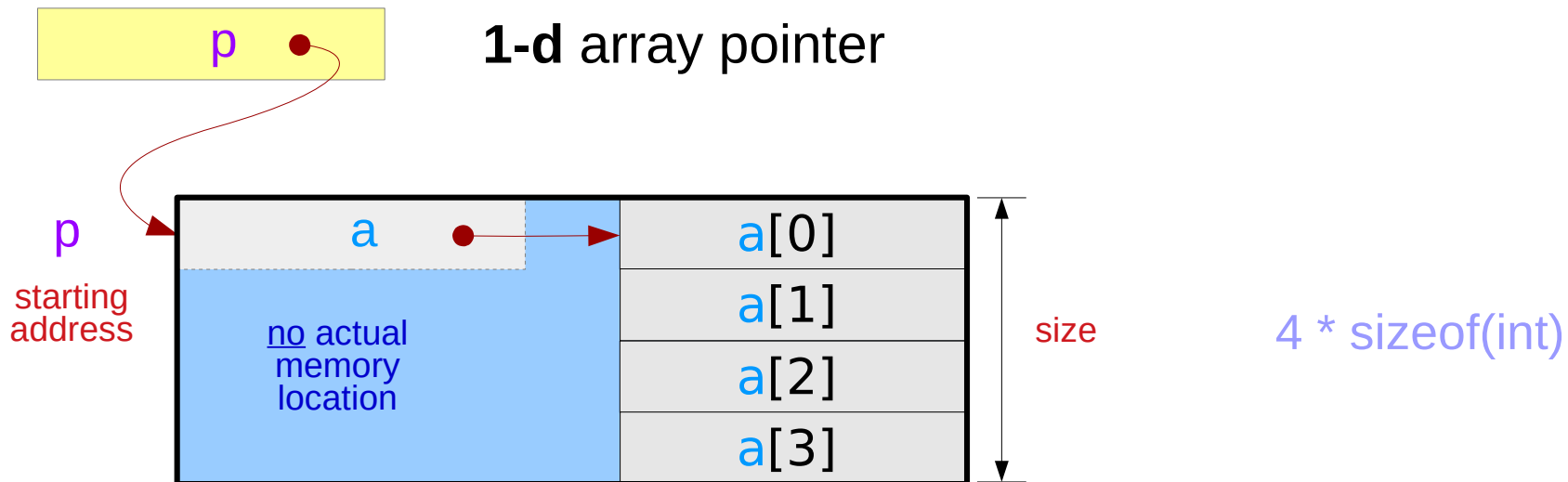

Incrementing an array pointer

```
int (*p) [4];
```

Aggregated Type Size

$$\begin{aligned} \text{address } p+1 - \text{address } p \\ = (\text{long}) (p+1) - (\text{long}) (p) &= 4 * \text{sizeof}(\text{int}) \end{aligned}$$

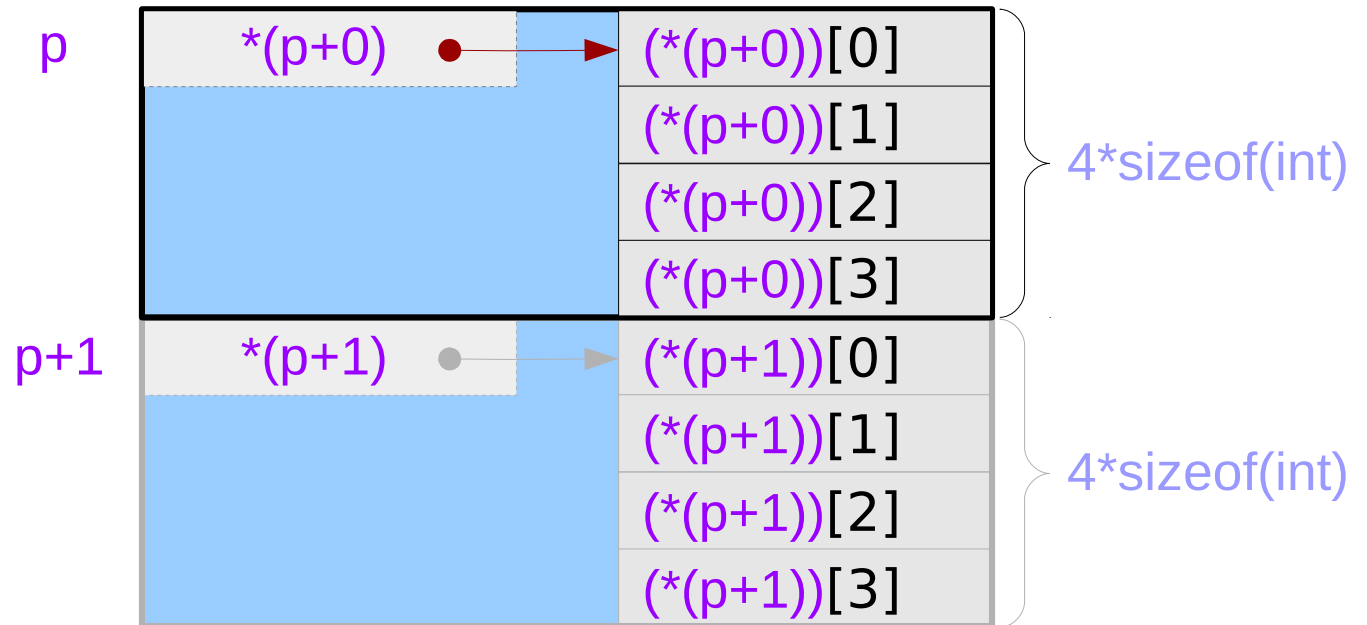
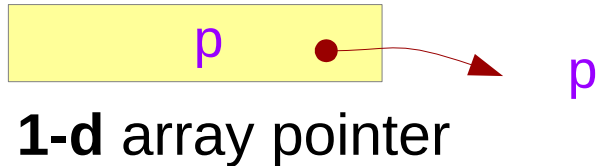

Incrementing an array pointer – extending a dimension

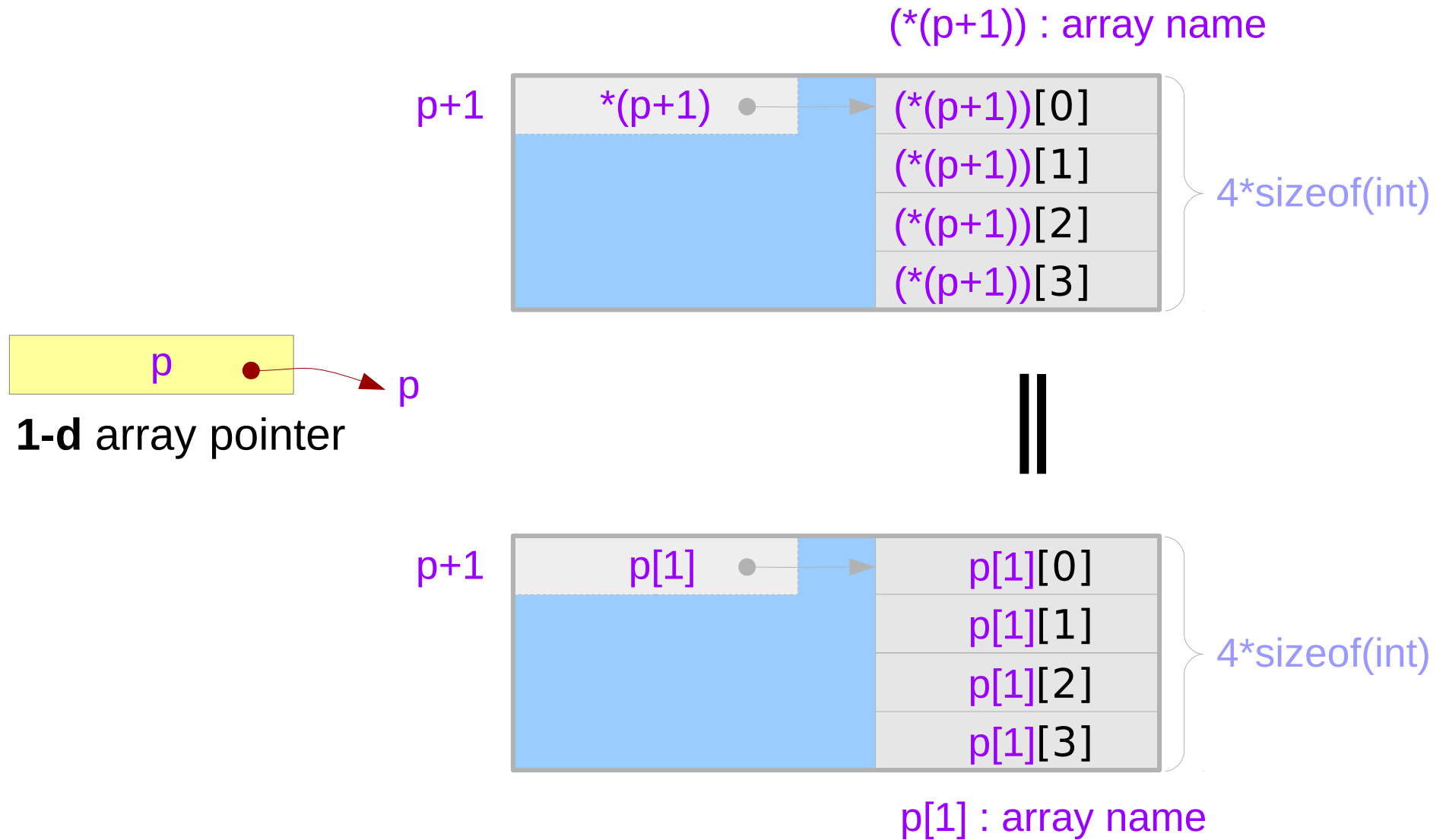

A 1-d array pointer and a 1-d array

```
int    a [4];
```

1-d array pointer

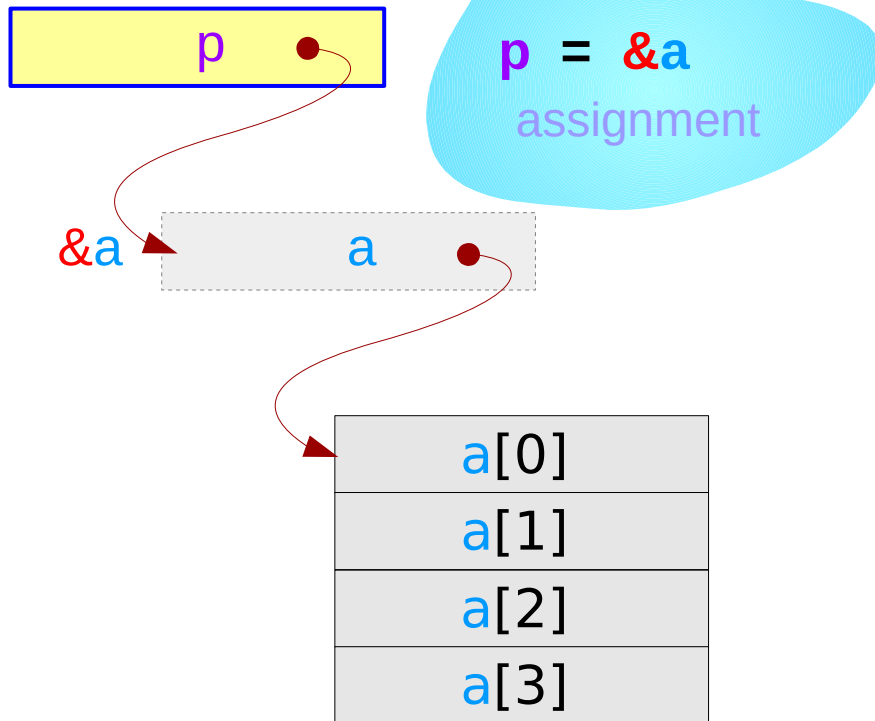

```
int (*p) [4] = &a;
```

1-d array pointer

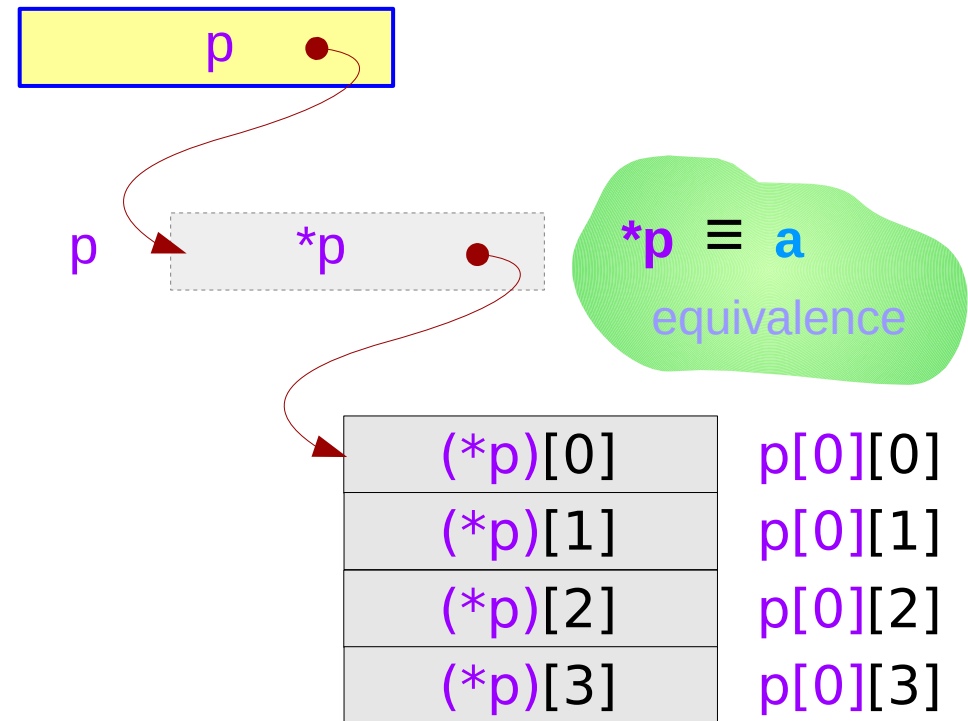

A 1-d array pointer and a 2-d array

```
int c [4][4];
```

```
int (*p) [4] = &c[0];
```

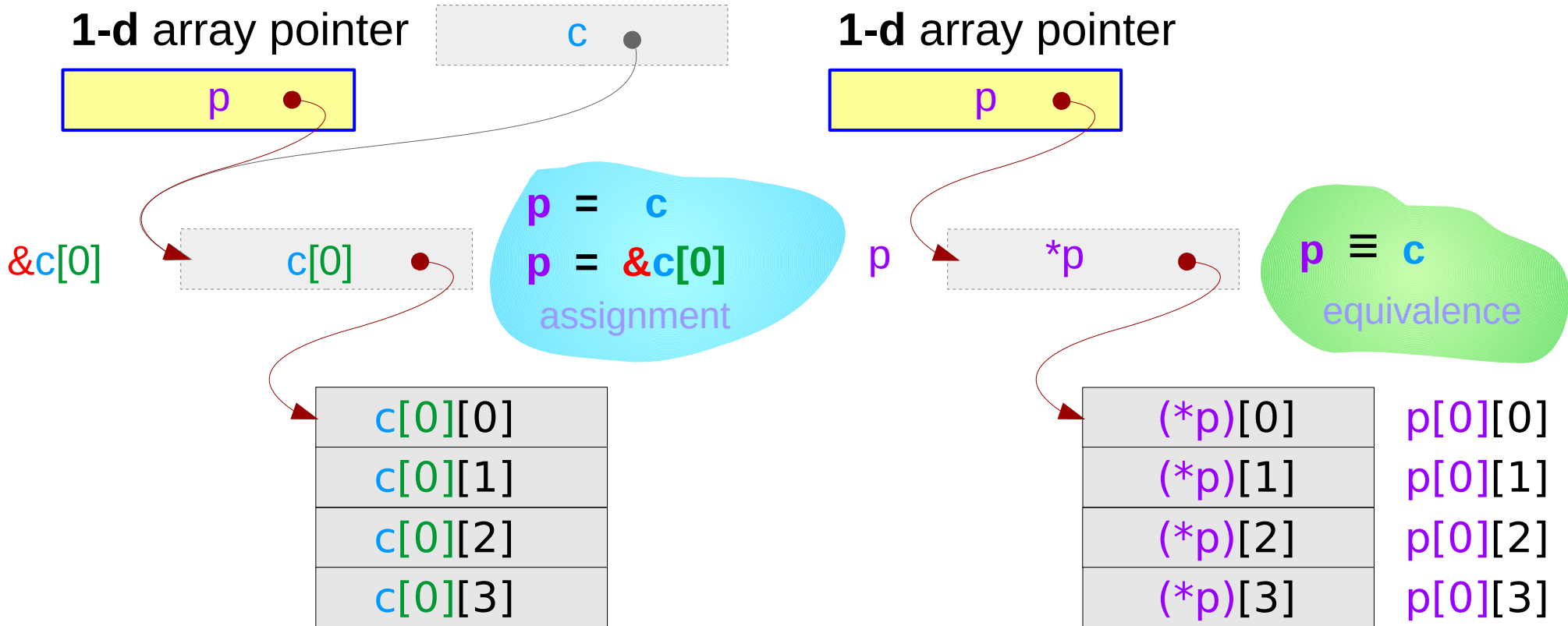

A 1-d array pointer and a 1-d array – a type view

```
int    a [4];
```

```
int (*p) [4] = &a;
```

1-d array pointer

`(int (*)[4])p`

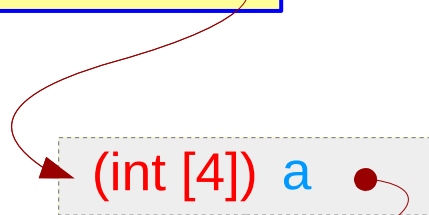

`(int *)`

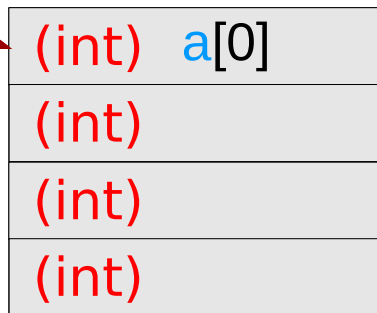

1-d array pointer

`(int (*)[4])p`

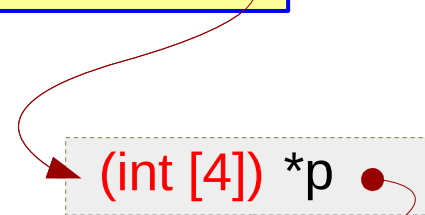

`p[0][0]`

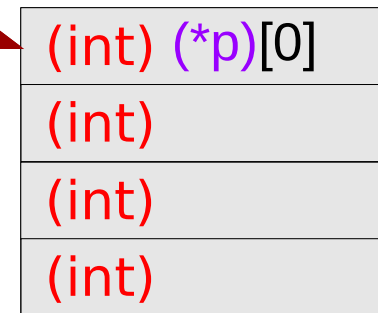

A 1-d array pointer and a 2-d array – a type view

```
int c [4][4];
```

```
int (*p) [4] = &c[0];
```

1-d array pointer

(int (*)[4] c

(int (*)[4] p

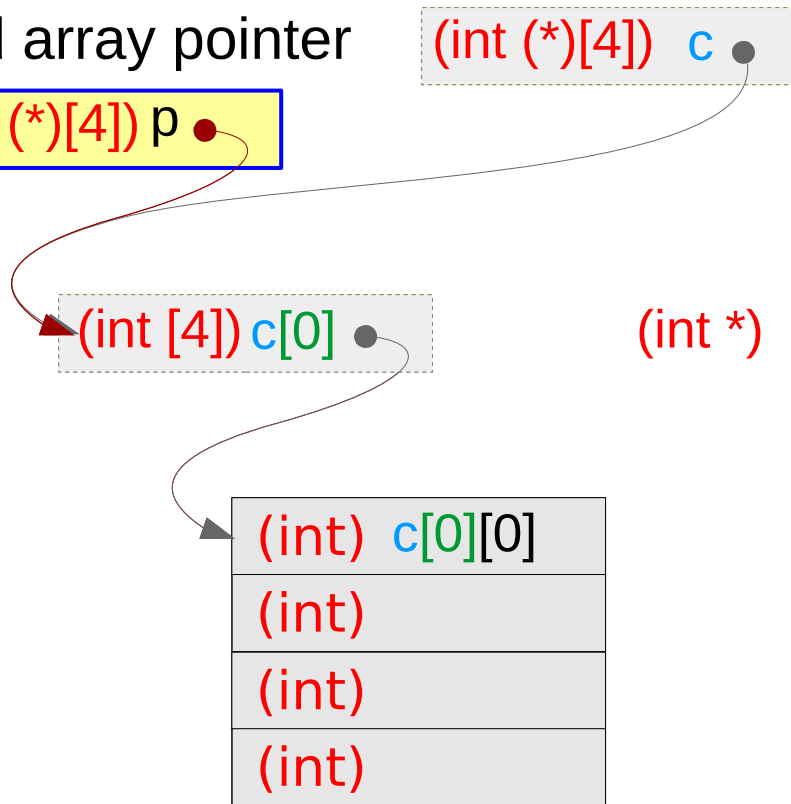

1-d array pointer

(int (*)[4] p

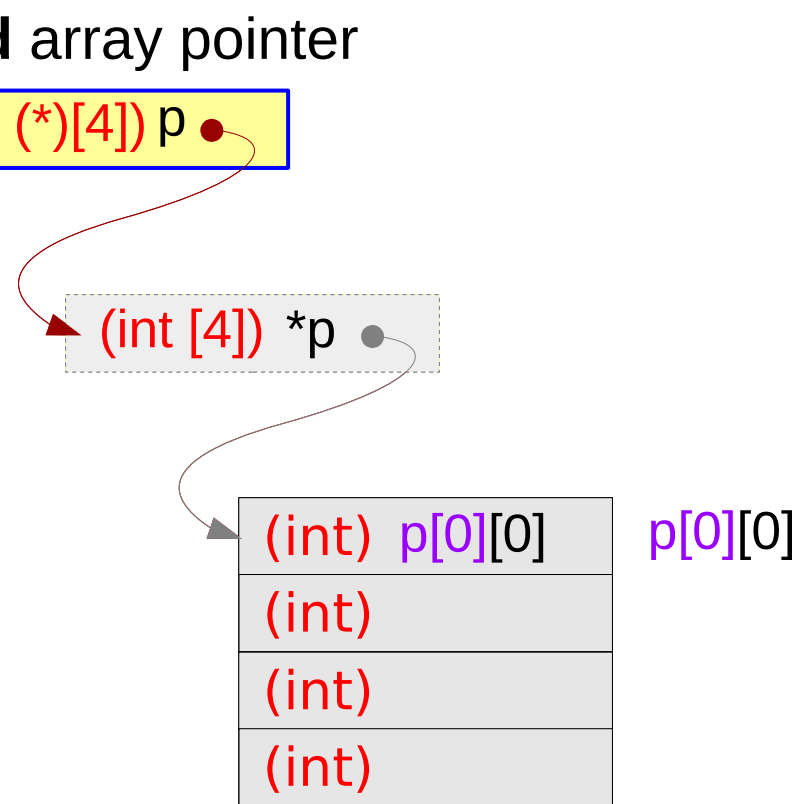

Double pointer to a 1-d array – a variable view

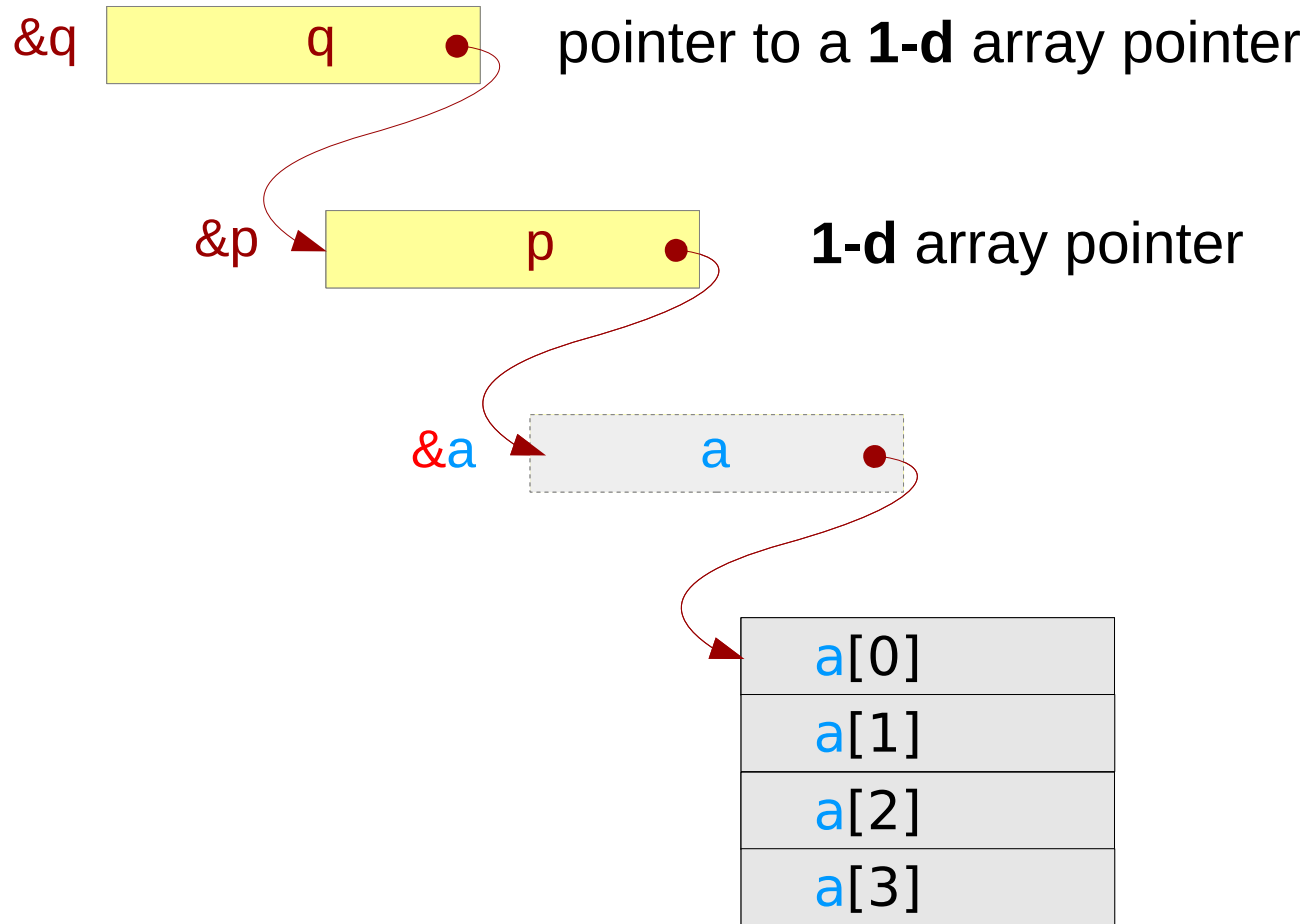

```
int a[4] ;  
int (*p) [4] = &a ;  
int (**q) [4] = &p ;
```

Double pointer to a 1-d array – a type view

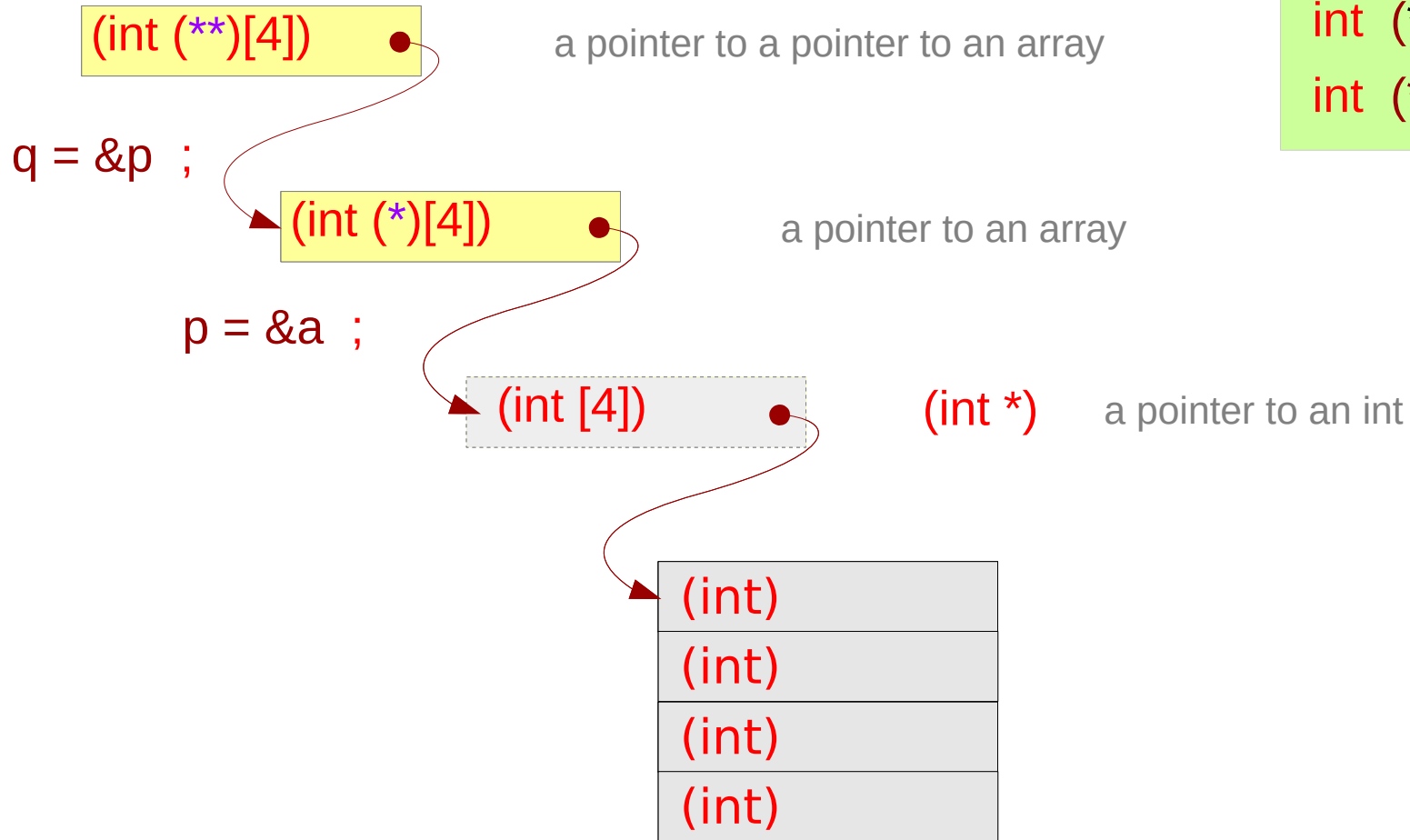

```
int a[4] ;  
int (*p) [4] = &a ;  
int (**q) [4] = &p ;
```

Pointer to Multi-dimensional Arrays

Integer pointer type

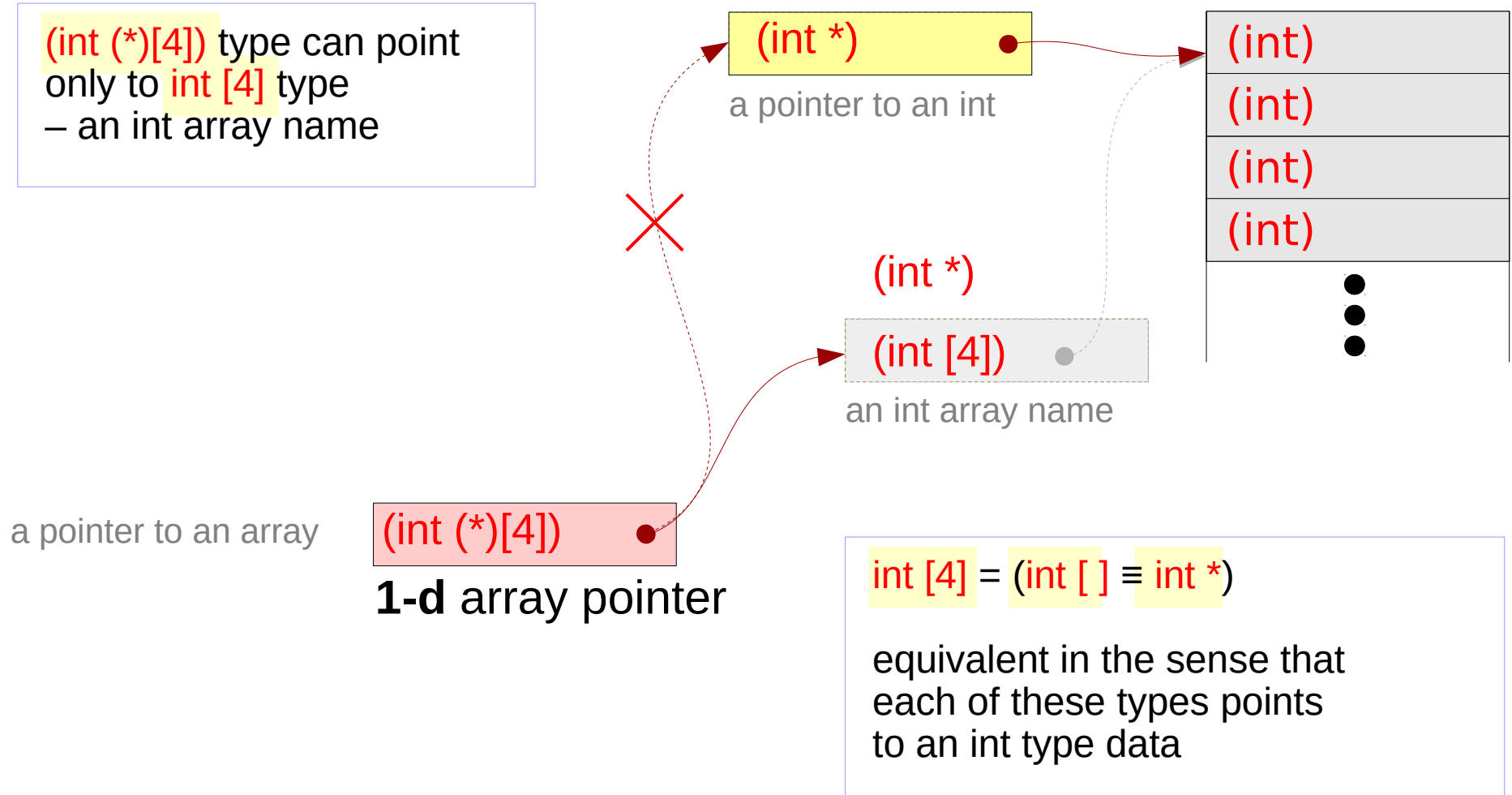

Series of array pointers – a type view

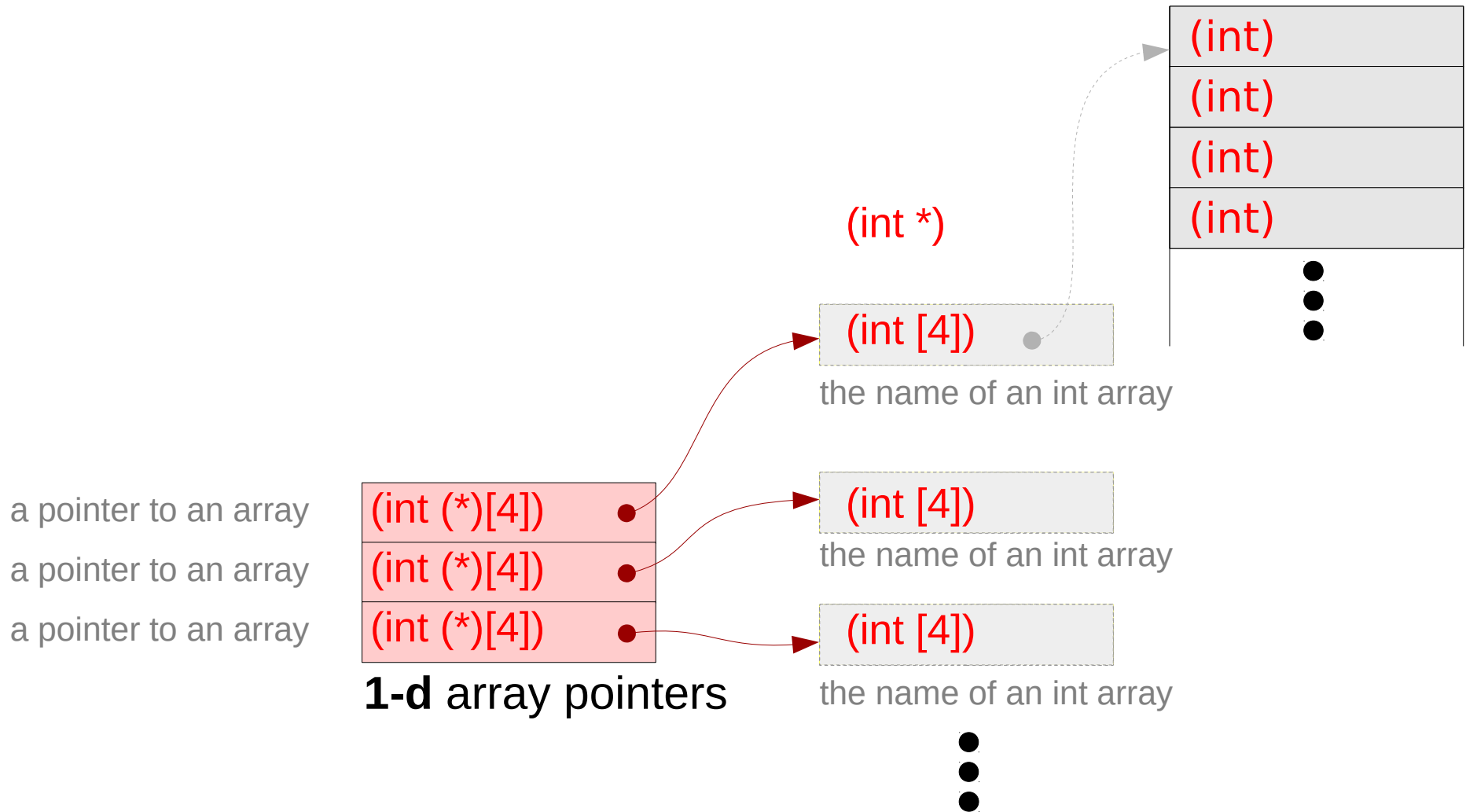

Series of array pointers – a variable view

```
int a[4]; int (*p1)[4]; int (*r);  
int b[4]; int (*p2)[4];  
int c[4]; int (*p3)[4];
```

assignment

```
p1 = &a  
p2 = &b  
p3 = &c
```

equivalence

```
(*p1) ≡ p1[0] ≡ a  
(*p2) ≡ p2[0] ≡ b  
(*p3) ≡ p3[0] ≡ c
```

a pointer to an array
a pointer to an array
a pointer to an array

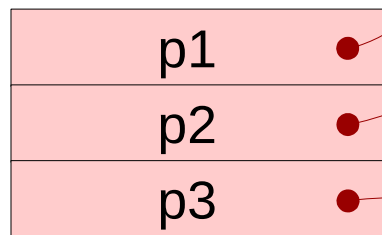

1-d array pointers

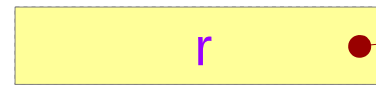

⋮

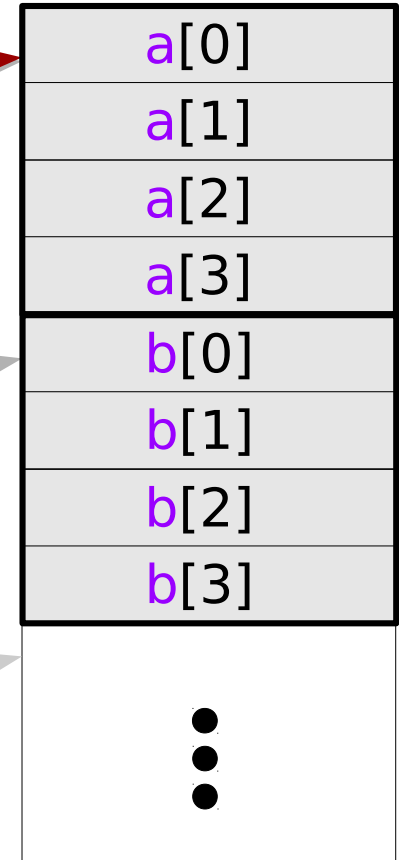

assume that
array a, b, and c
are contiguous
in the memory

Pointer array – a variable view

```
int *q[3];
```

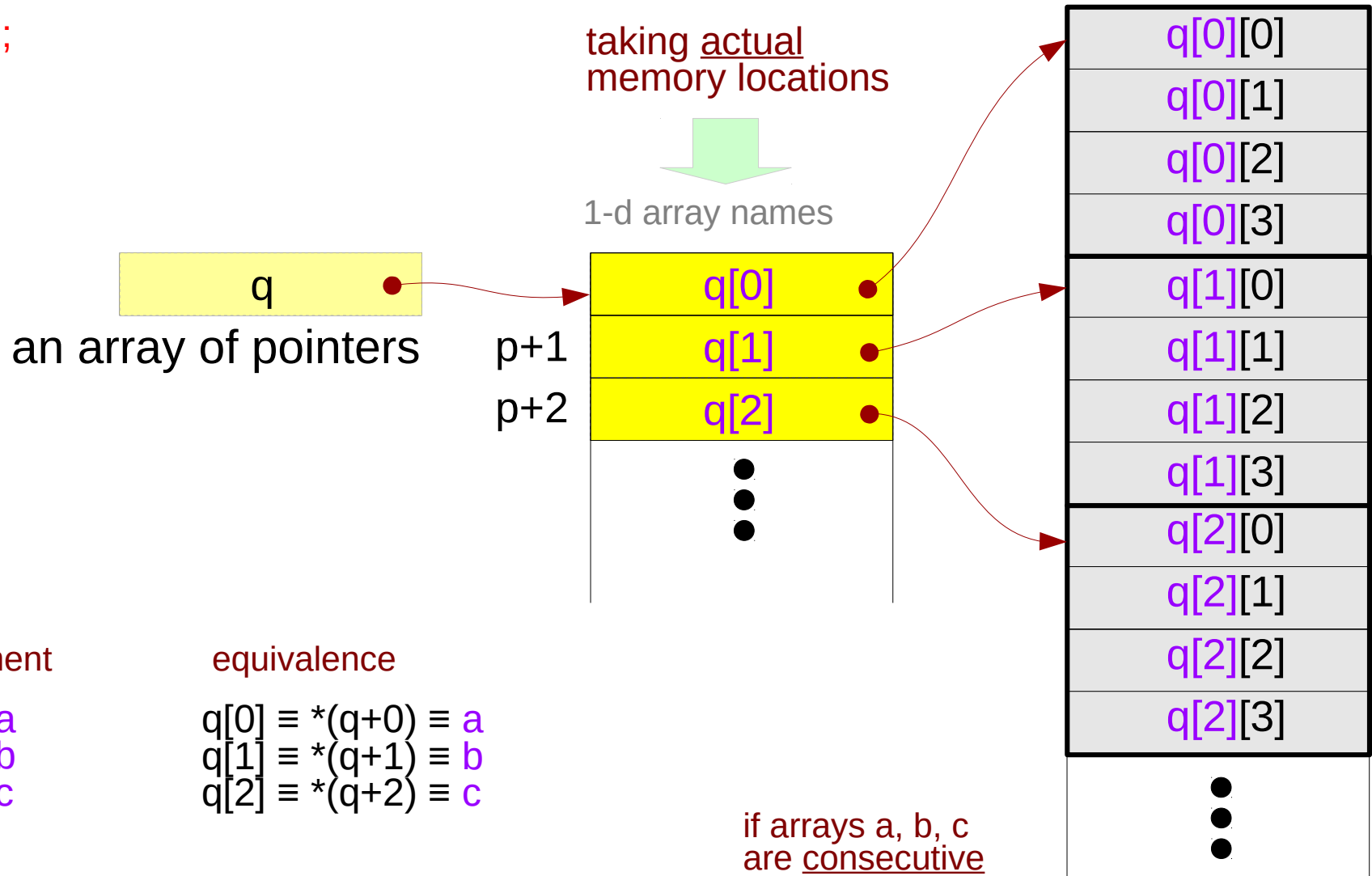

Array pointer to consecutive **1-d** arrays

```
int (*p)[4];
```

a pointer to an array



1-d array pointer

assignment

```
p = &a
```

equivalence

```
*(p+0) ≡ p[0] ≡ a  
*(p+1) ≡ p[1] ≡ b  
*(p+2) ≡ p[2] ≡ c  
*(p+3) ≡ p[3] ≡ d
```

if arrays a, b, c, d
are consecutive

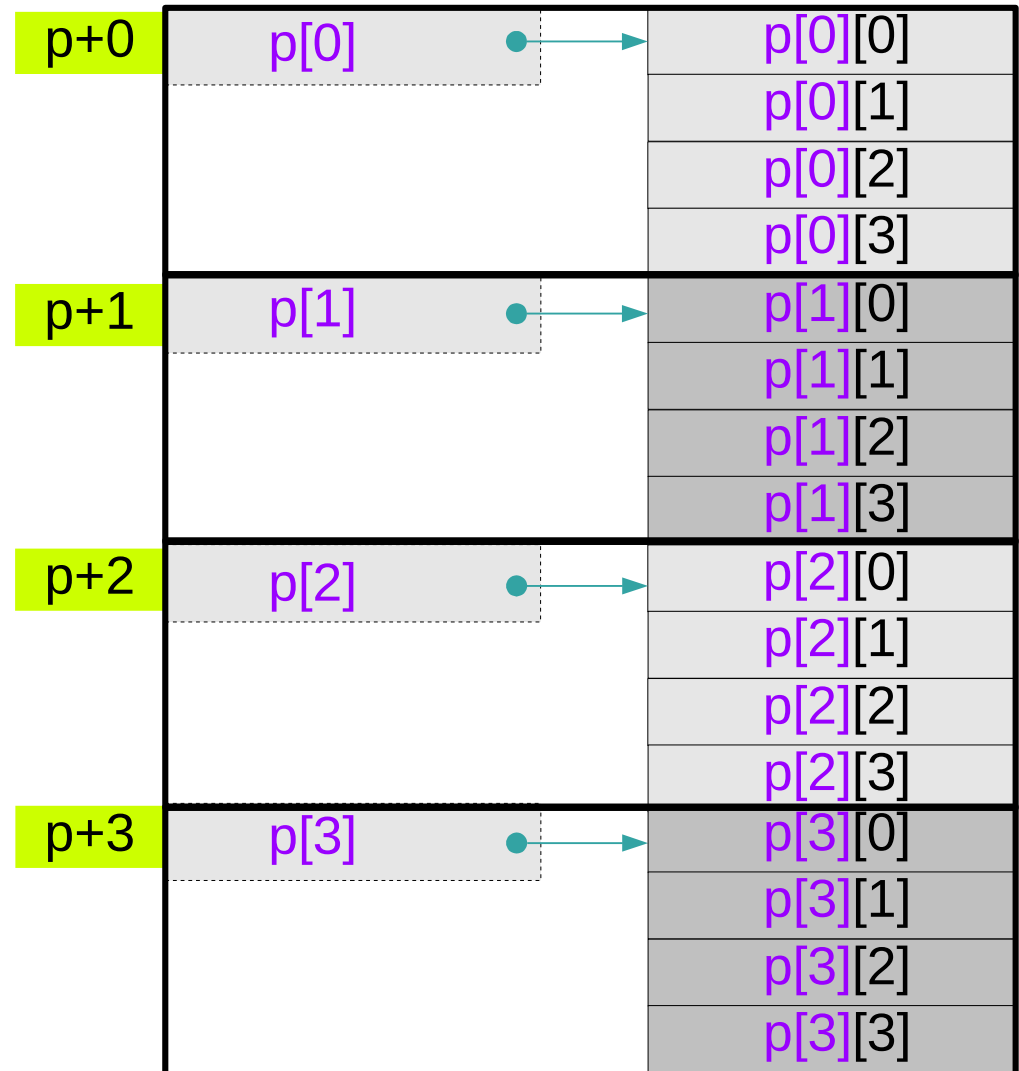

A 2-d array and its sub-arrays – a variable view

the array name **c** of a **2-d** array as a **1-d** array pointer which points to its 1st **1-d** sub-array

c is the **1-d** array pointer
c[i]'s are the **1-d** sub-array name

c[0]	the 1 st	1-d sub-array name
c[1]	the 2 nd	1-d sub-array name
c[2]	the 3 rd	1-d sub-array name
c[3]	the 4 th	1-d sub-array name

Compilers can make **c[i]**'s require no actual memory locations

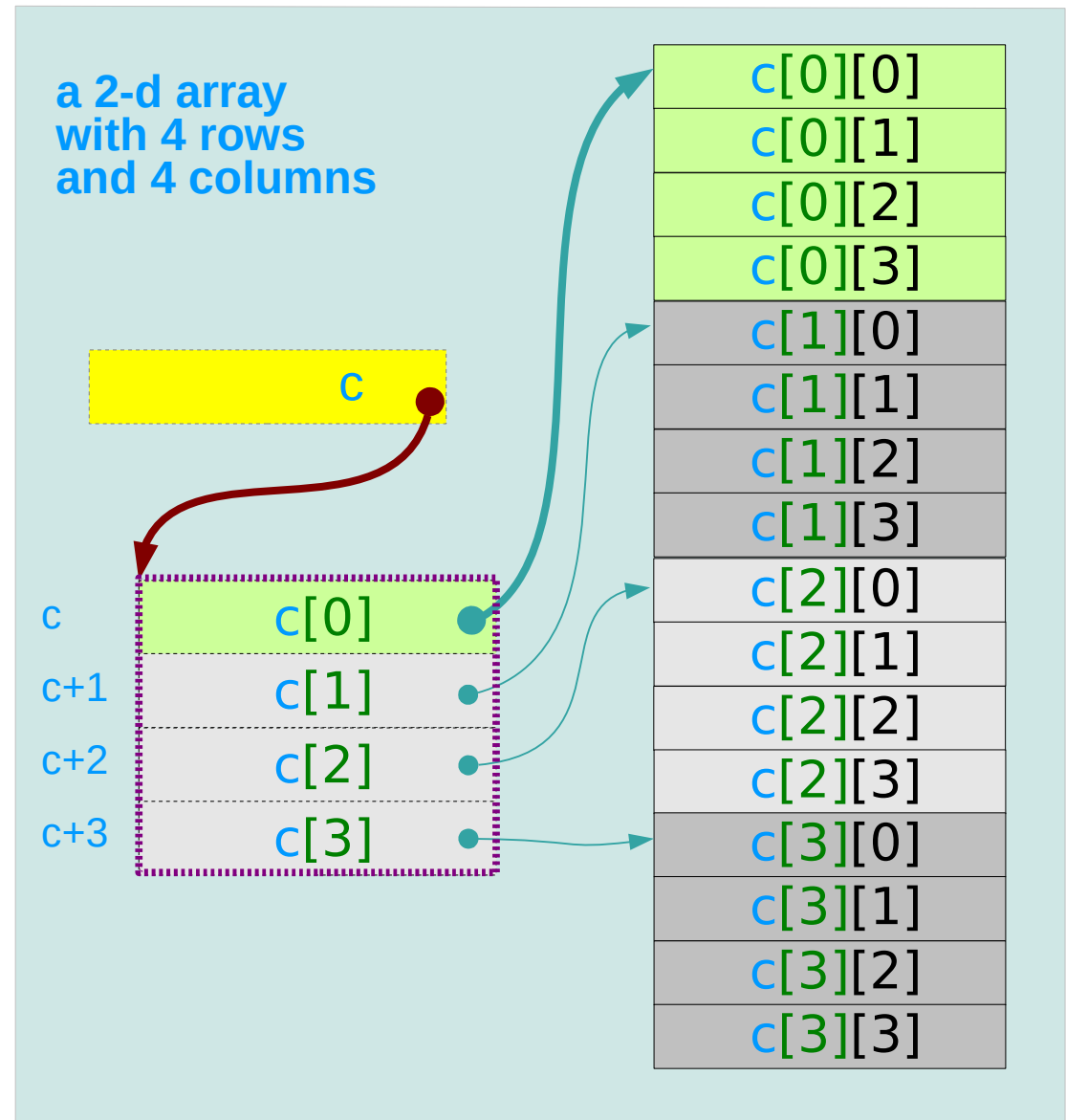

A 2-d array and its sub-arrays – a type view

1-d array pointer

1-d array name

1-d array name

1-d array name

1-d array name

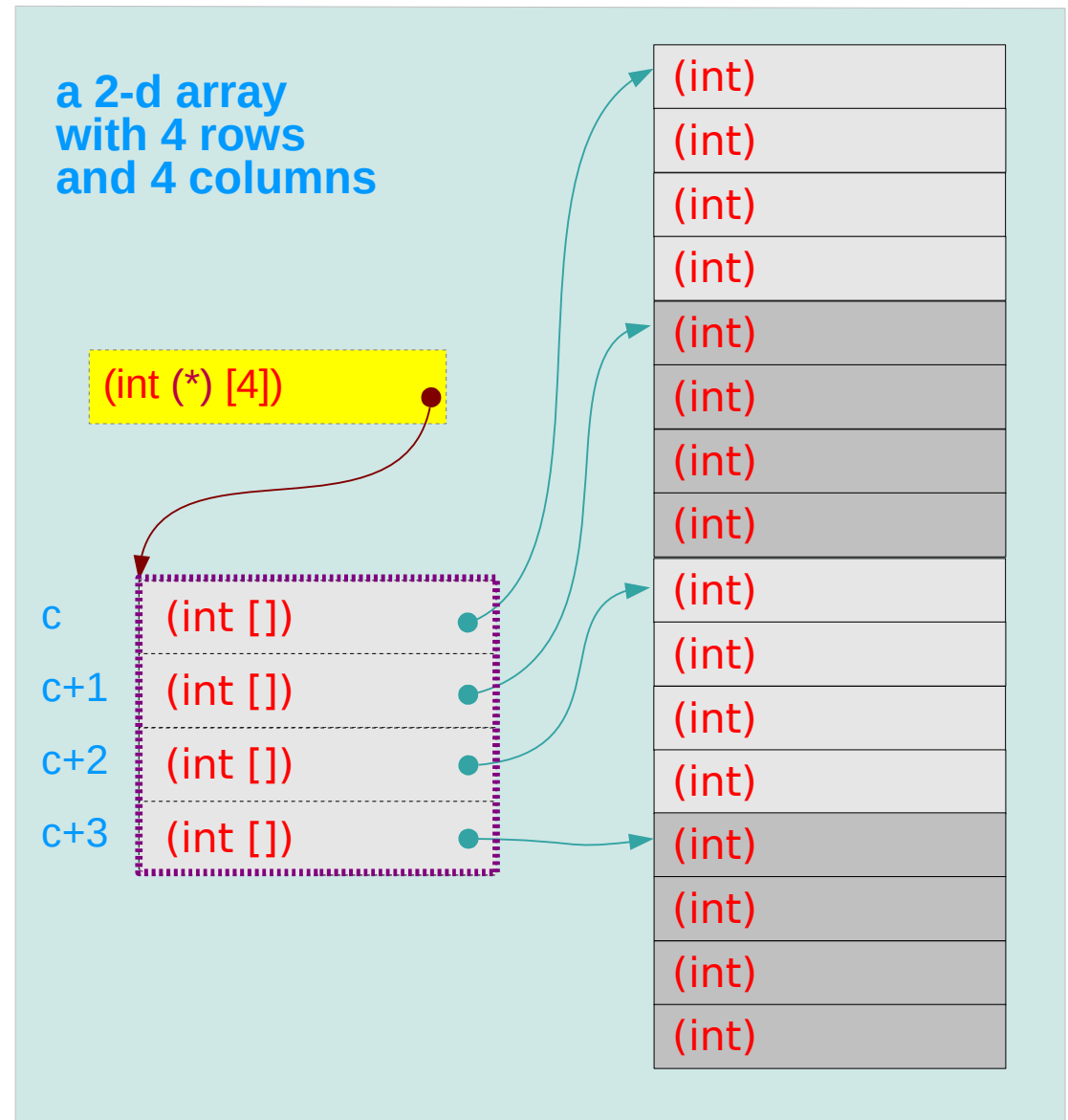

1-d subarray aggregated data type

The 1st subarray **c[0]** (=array name)
sizeof(**c[0]**) = 16 bytes

The 2nd subarray **c[1]** (=array name)
sizeof(**c[1]**) = 16 bytes

The 3rd subarray **c[2]** (=array name)
sizeof(**c[2]**) = 16 bytes

The 4th subarray **c[3]** (=array name)
sizeof(**c[3]**) = 16 bytes

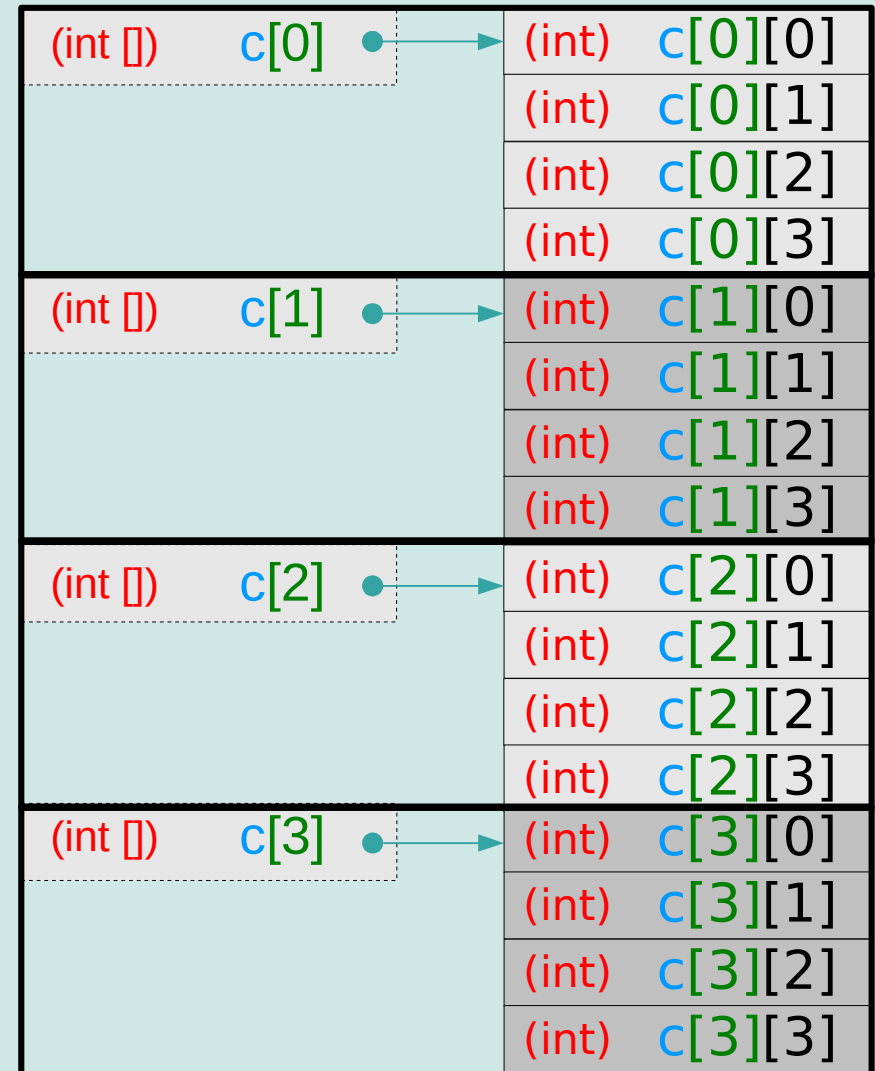

2-d array name as a pointer to a 1-d subarray

1-d array pointer

`(int (*) [4]) c`

`(int []) c[0]`

<code>(int) c[0][0]</code>
<code>(int) c[0][1]</code>
<code>(int) c[0][2]</code>
<code>(int) c[0][3]</code>

The 1st subarray

1-d array pointer

`(int (*) [4]) c+1`

`(int []) c[1]`

<code>(int) c[1][0]</code>
<code>(int) c[1][1]</code>
<code>(int) c[1][2]</code>
<code>(int) c[1][3]</code>

The 2nd subarray

1-d array pointer

`(int (*) [4]) c+2`

`(int []) c[2]`

<code>(int) c[2][0]</code>
<code>(int) c[2][1]</code>
<code>(int) c[2][2]</code>
<code>(int) c[2][3]</code>

The 3rd subarray

1-d array pointer

`(int (*) [4]) c+3`

`(int []) c[3]`

<code>(int) c[3][0]</code>
<code>(int) c[3][1]</code>
<code>(int) c[3][2]</code>
<code>(int) c[3][3]</code>

The 4th subarray

2-d array and 1-d and 2-d array pointers

1-d array pointer

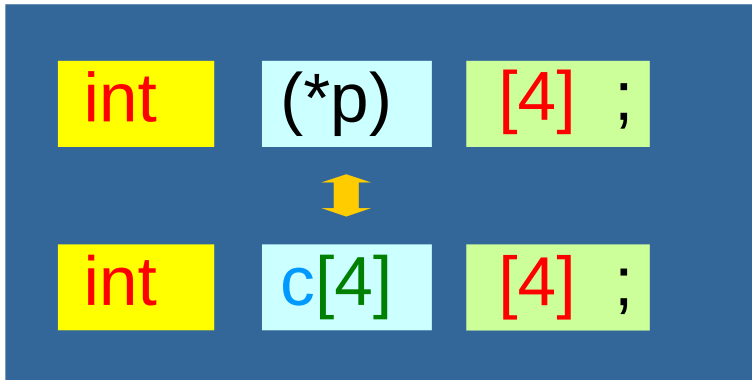

(int (*) [4])

```
p = &c[0];
```

```
p = c;
```

```
p[0] ≡ c[0]  
p[1] ≡ c[1]  
p[2] ≡ c[2]  
p[3] ≡ c[3]
```

2-d array pointer

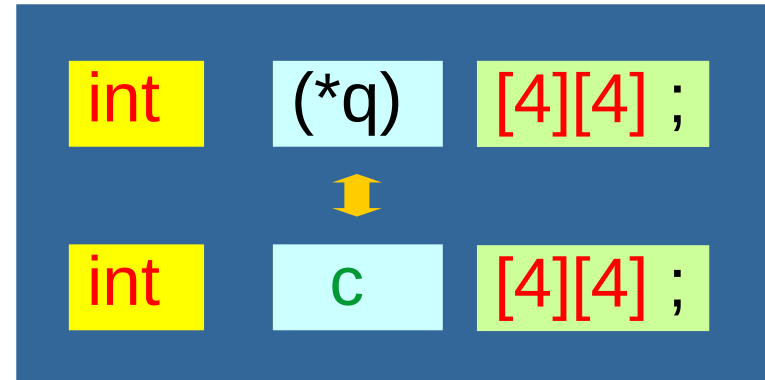

(int(*)[4][4])

```
q = &c;
```

```
(*q)[0] ≡ q[0][0] ≡ c[0]  
(*q)[1] ≡ q[0][1] ≡ c[1]  
(*q)[2] ≡ q[0][2] ≡ c[2]  
(*q)[3] ≡ q[0][3] ≡ c[3]
```

1-d array and 0-d and 1-d array pointers

0-d array pointer : int pointer

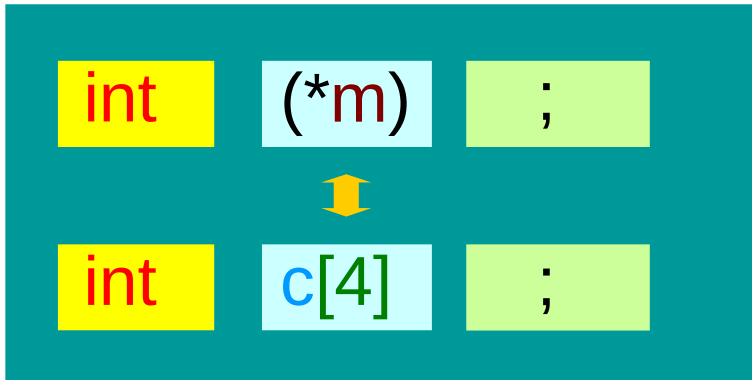

(int (*))

```
m = &c[0];
```

```
m = c;
```

$$\begin{matrix} m[0] \\ m[1] \\ m[2] \\ m[3] \end{matrix} \equiv \begin{matrix} c[0] \\ c[1] \\ c[2] \\ c[3] \end{matrix}$$

1-d array pointer

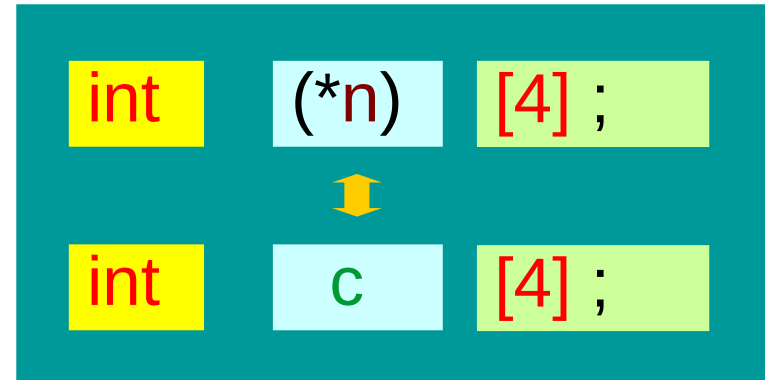

(int(*)[4])

```
n = &c;
```

$$\begin{matrix} (*n)[0] \\ (*n)[1] \\ (*n)[2] \\ (*n)[3] \end{matrix} \equiv \begin{matrix} n[0][0] \\ n[0][0] \\ n[0][0] \\ n[0][0] \end{matrix} \equiv \begin{matrix} c[0] \\ c[1] \\ c[2] \\ c[3] \end{matrix}$$

Pointer to a 2-d array – an aggregated type view

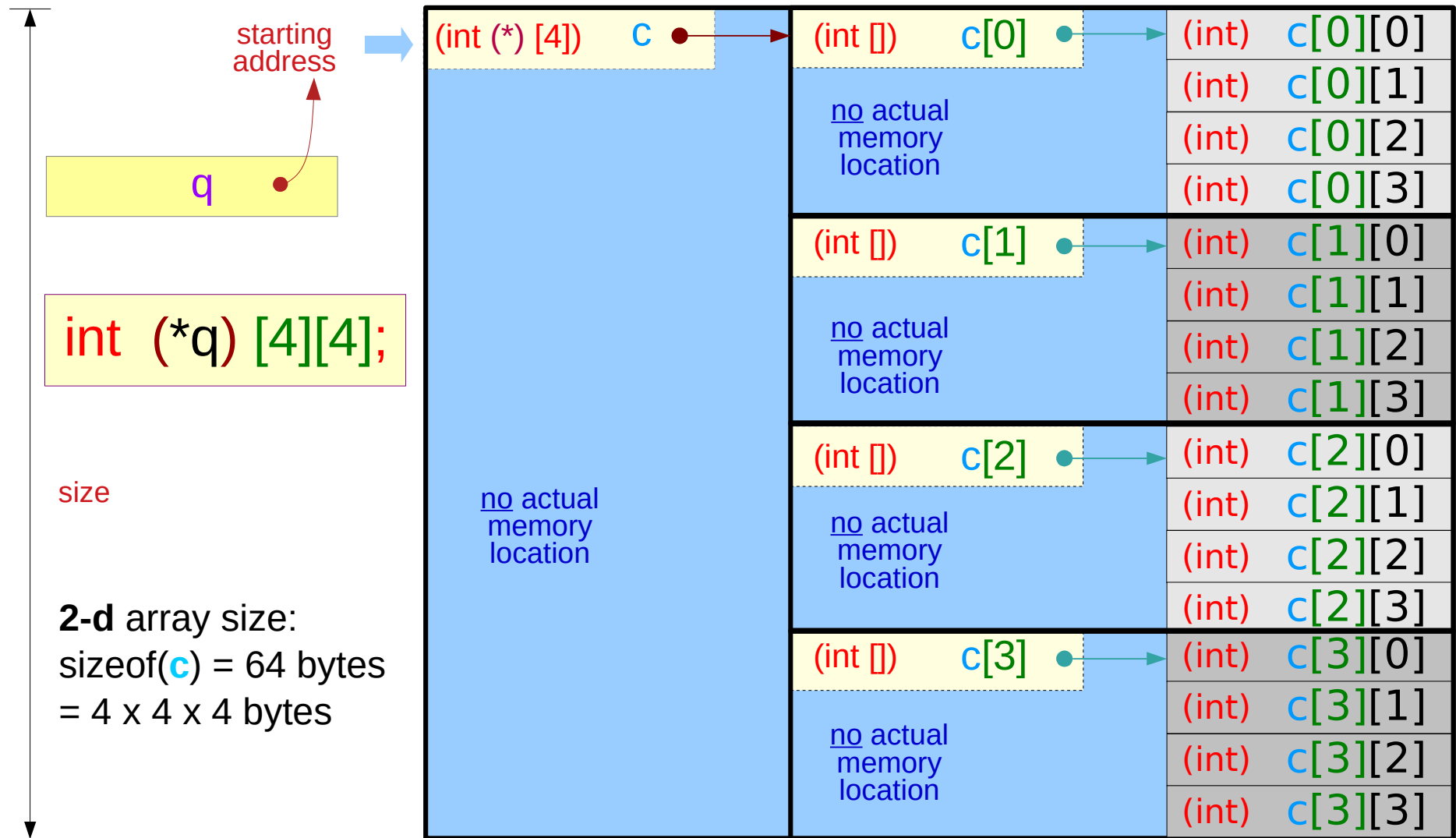

1-d array pointer to a 2-d array

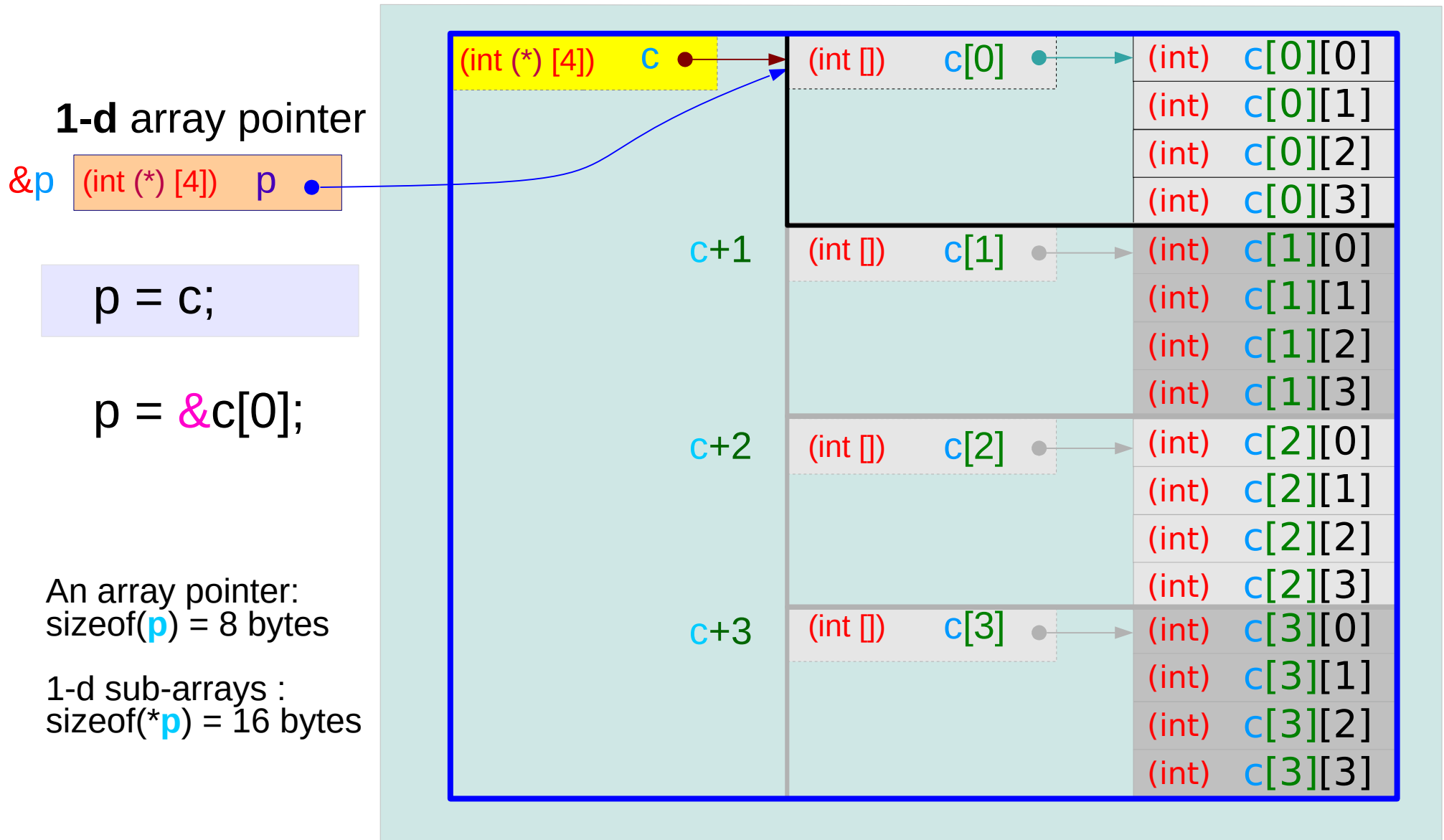

2-d array pointer to a 2-d array

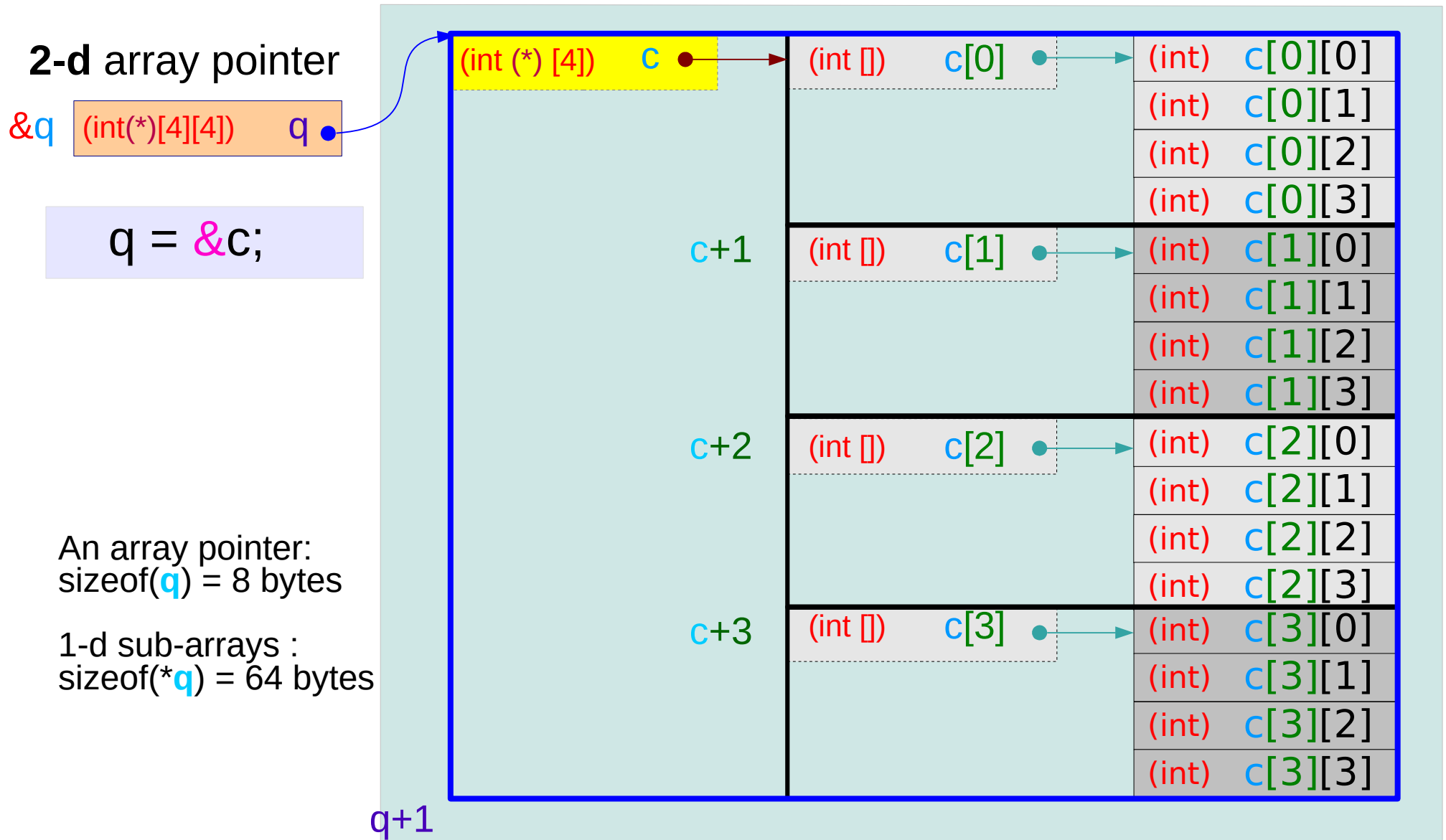

Using a 1-d array pointer to a 2-d array

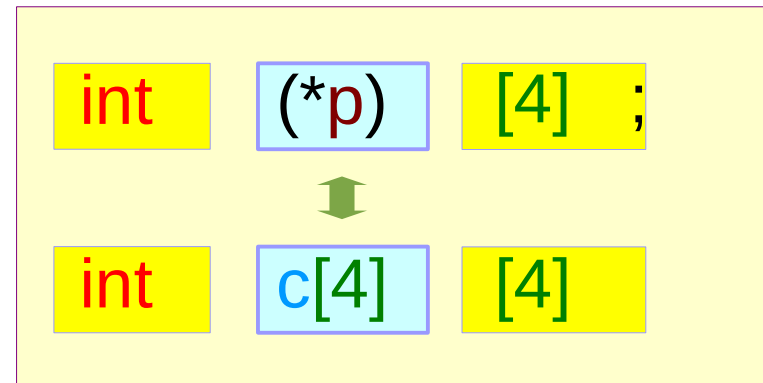

1-d array pointer

&p

`(int (*) [4]) p`

`p = c;`

`p[0] ≡ c[0]`
`p[1] ≡ c[1]`
`p[2] ≡ c[2]`
`p[3] ≡ c[3]`

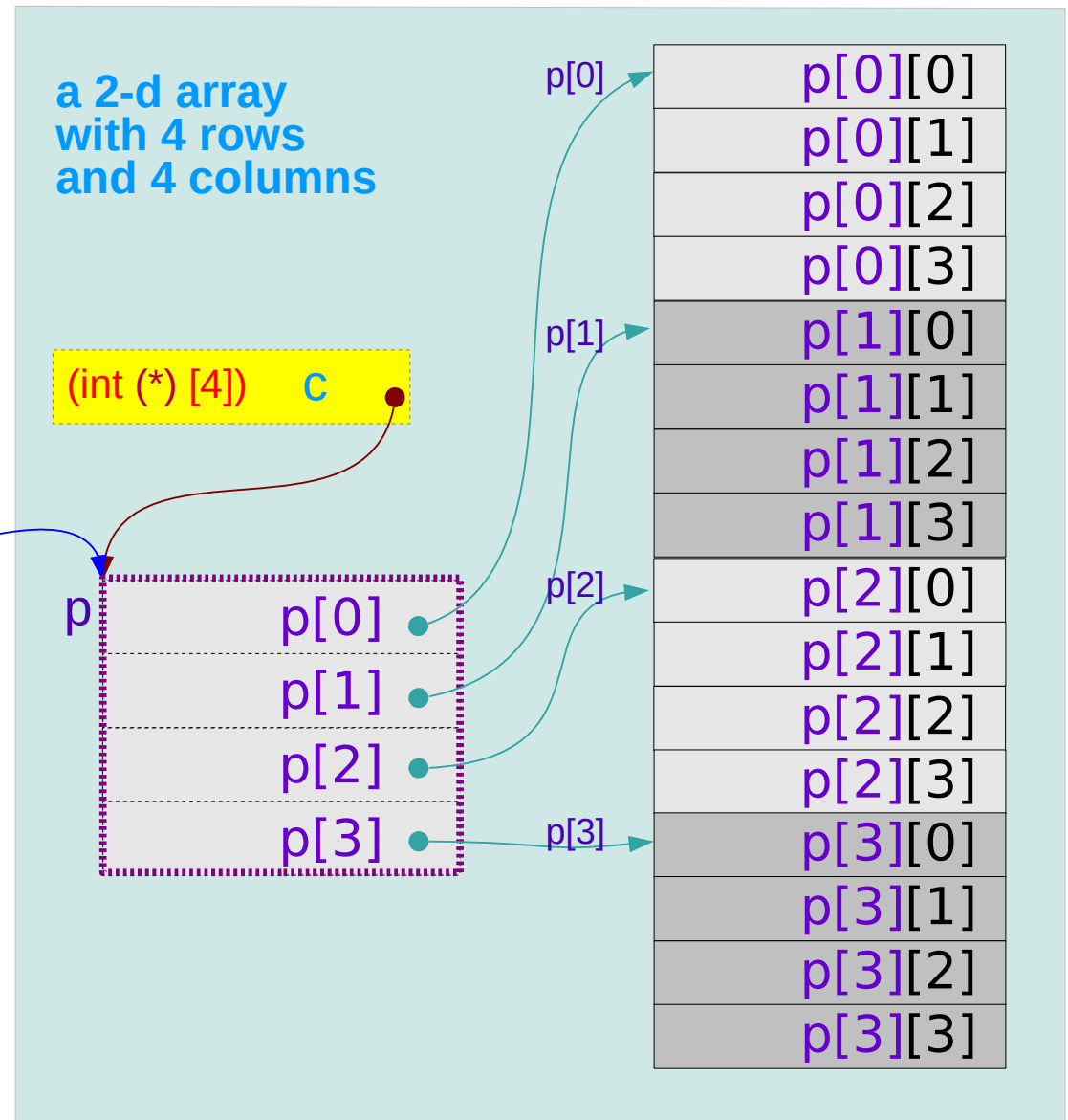

Using a 2-d array pointer to a 2-d array

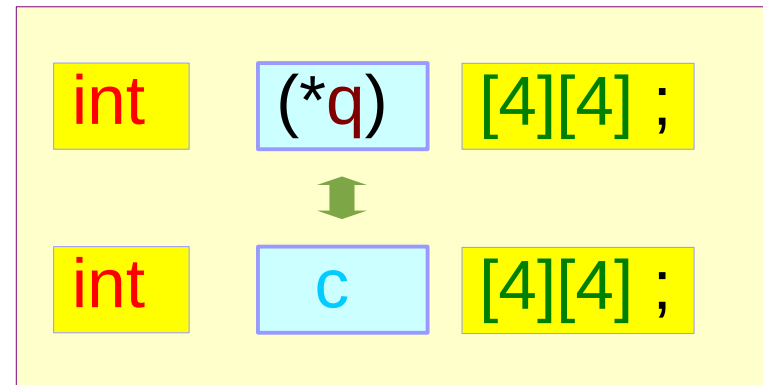

2-d array pointer
`&p (int(*)[4][4]) q`

`q = &c;`

$$\begin{pmatrix} (*q)[0] \\ (*q)[1] \\ (*q)[2] \\ (*q)[3] \end{pmatrix} \equiv c \begin{pmatrix} [0] \\ [1] \\ [2] \\ [3] \end{pmatrix}$$

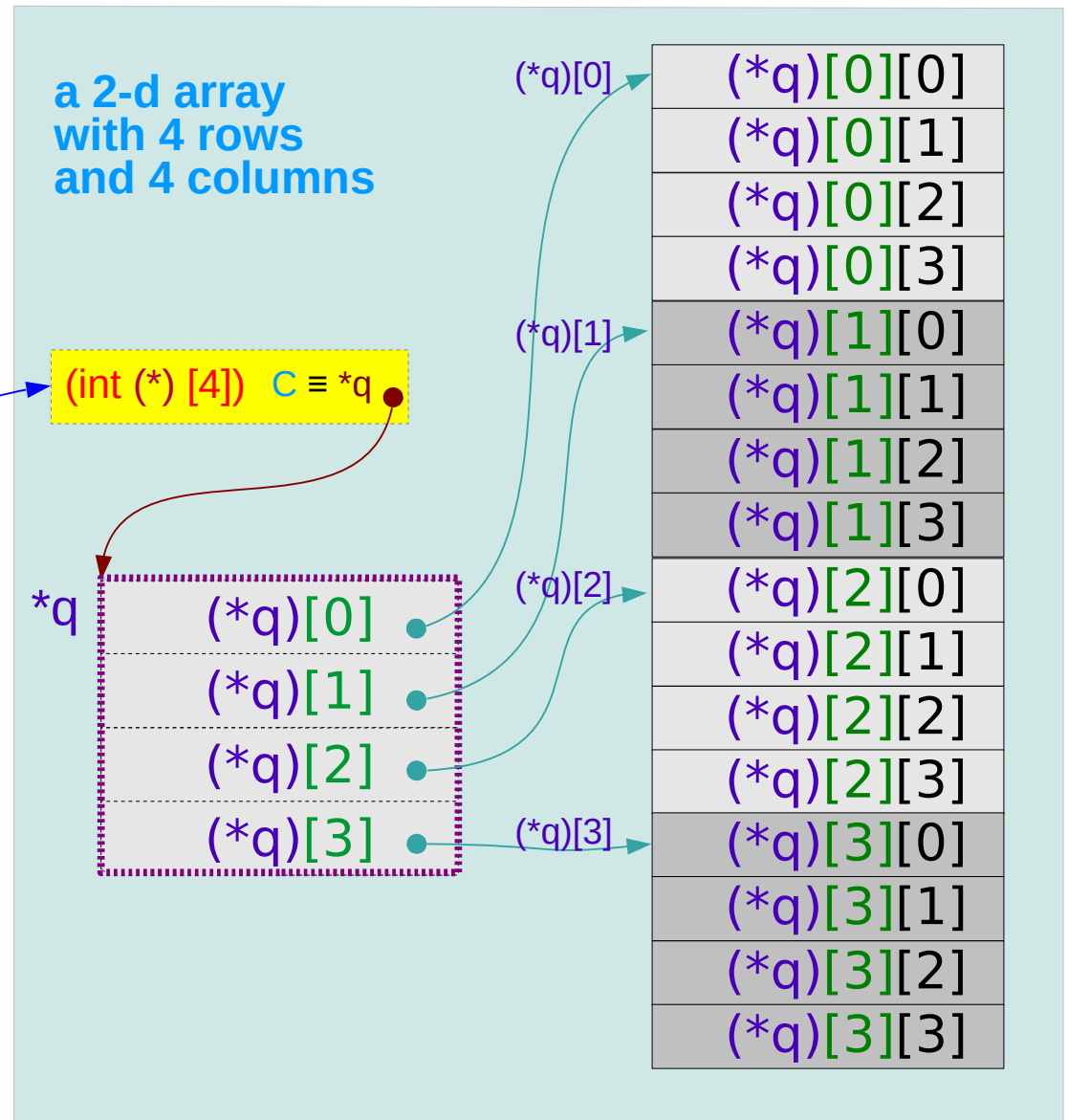

$(n-1)$ -d array pointer to a n -d array

`int a[4];` **1-d** array
`int (*p);` **0-d** array pointer

`int b[4][2];` **2-d** array
`int (*q)[2];` **1-d** array pointer

`int c[4][2][3];` **3-d** array
`int (*r)[2][3];` **2-d** array pointer

`int d[4][2][3][4];` **4-d** array
`int (*s)[2][3][4];` **3-d** array pointer

n -d array name : $(n-1)$ -d array pointer

```
int a[4];  
int (*p);
```

```
p = &a[0];  
p = a;
```

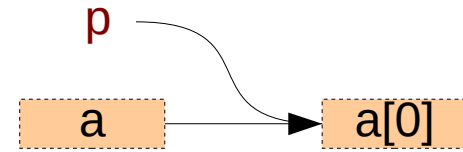

```
int b[4][2];  
int (*q)[2];
```

```
q = &b[0];  
q = b;
```

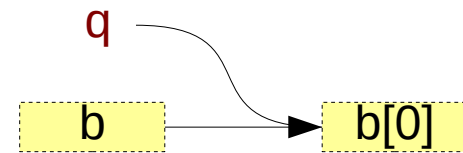

```
int c[4][2][3];  
int (*r)[2][3];
```

```
r = &c[0];  
r = c;
```

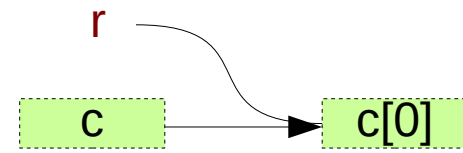

```
int d[4][2][3][4];  
int (*s)[2][3][4];
```

```
s = &d[0];  
s = d;
```

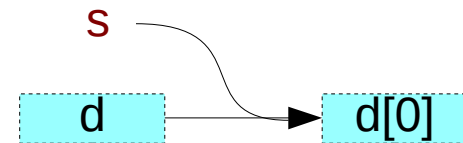

multi-dimensional array pointers

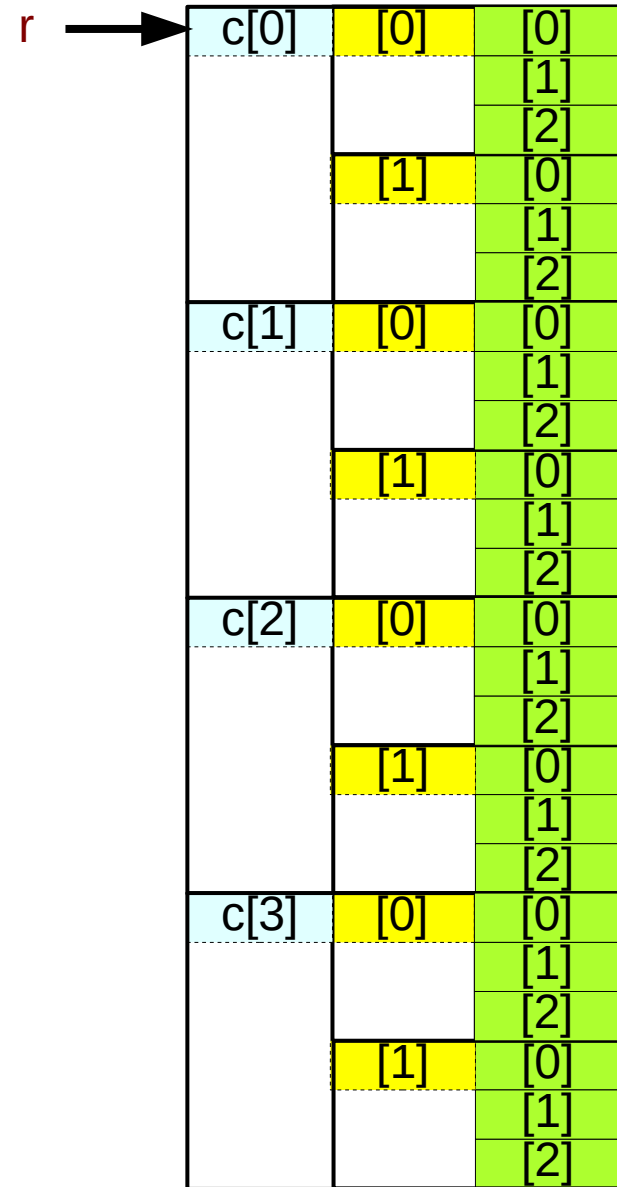
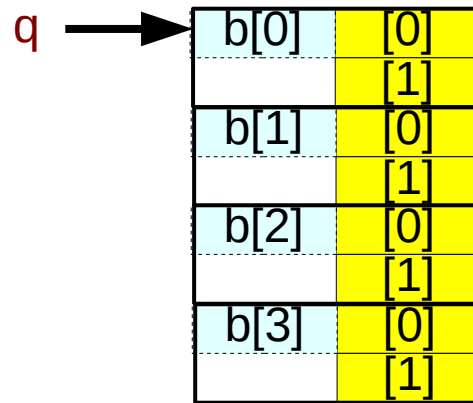
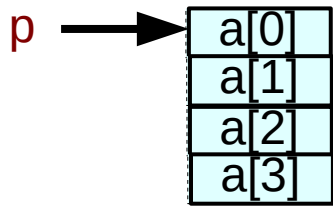

```
int a[4] ;  
int b[4] [2];  
int c[4] [2][3];  
int d[4] [2][3][4];
```

```
int (*p) ;  
int (*q) [2];  
int (*r) [2][3];  
int (*s) [2][3][4];
```

multi-dimensional array pointers

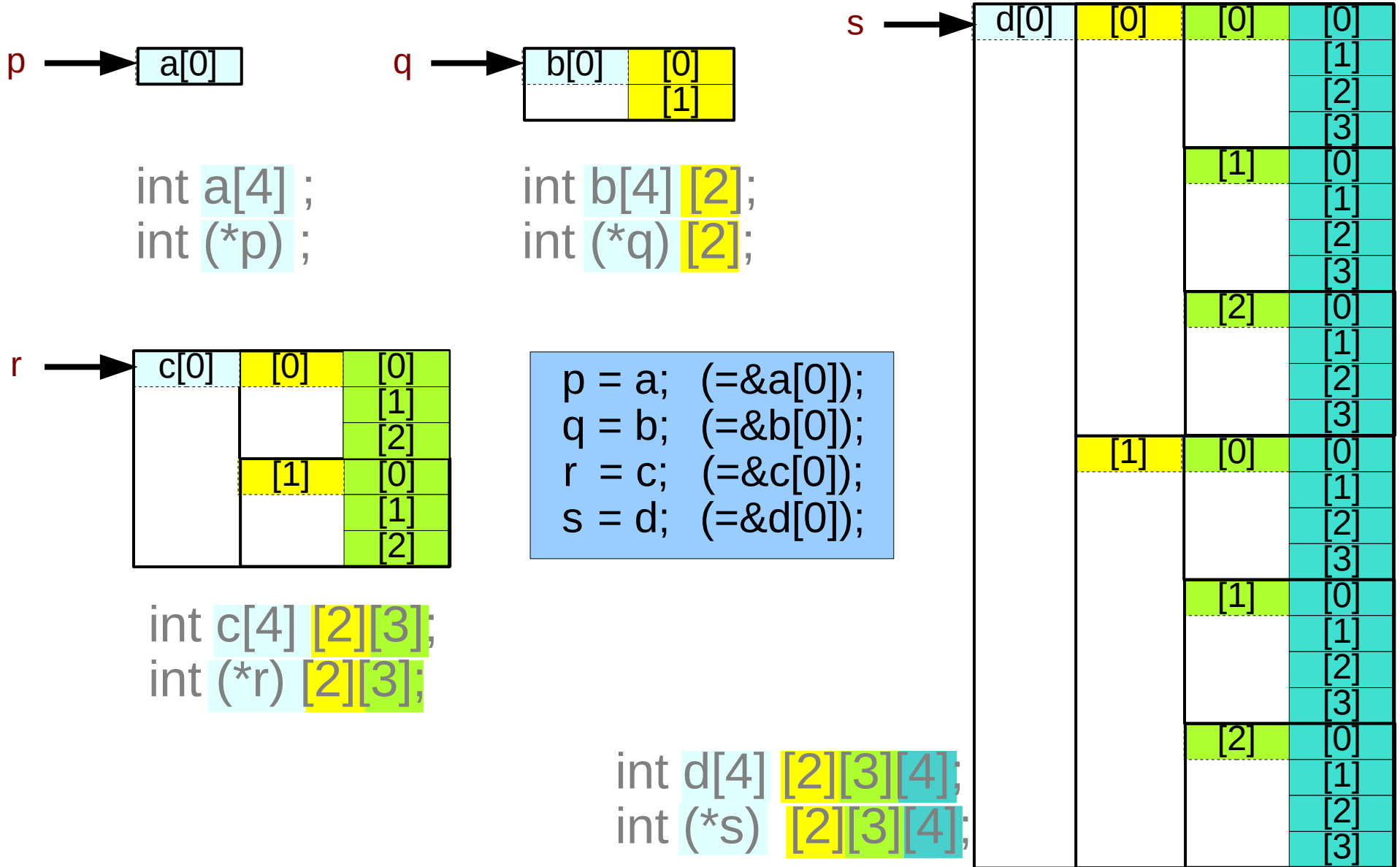

multi-dimensional array pointers

d[1]	[0]	[0]	[0]
			[1]
			[2]
			[3]
		[1]	[0]
			[1]
			[2]
			[3]
		[2]	[0]
			[1]
			[2]
			[3]
	[1]	[0]	[0]
			[1]
			[2]
			[3]
		[1]	[0]
			[1]
			[2]
			[3]
		[2]	[0]
			[1]
			[2]
			[3]

d[2]	[0]	[0]	[0]
			[1]
			[2]
			[3]
		[1]	[0]
			[1]
			[2]
			[3]
		[2]	[0]
			[1]
			[2]
			[3]
	[1]	[0]	[0]
			[1]
			[2]
			[3]
		[1]	[0]
			[1]
			[2]
			[3]
		[2]	[0]
			[1]
			[2]
			[3]

d[3]	[0]	[0]	[0]
			[1]
			[2]
			[3]
		[1]	[0]
			[1]
			[2]
			[3]
		[2]	[0]
			[1]
			[2]
			[3]
	[1]	[0]	[0]
			[1]
			[2]
			[3]
		[1]	[0]
			[1]
			[2]
			[3]
		[2]	[0]
			[1]
			[2]
			[3]

multi-dimensional array pointers

```
int d[4][2][3][4];
int (*s)[2][3][4];
```

d	4-d array name 3-d array pointer	d[4][2][3][4] (*d)[2][3][4]
d[i]	3-d array name 2-d array pointer	d[i][2][3][4] (*d[i])[3][4]
d[i][j]	2-d array name 1-d array pointer	d[i][j][3][4] (*d[i][j])[4]
d[i][j][k]	1-d array name 0-d array pointer	d[i][j][k][4] (*d[i][j][k])

i = [0..3], j = [0..1], k = [0..2]

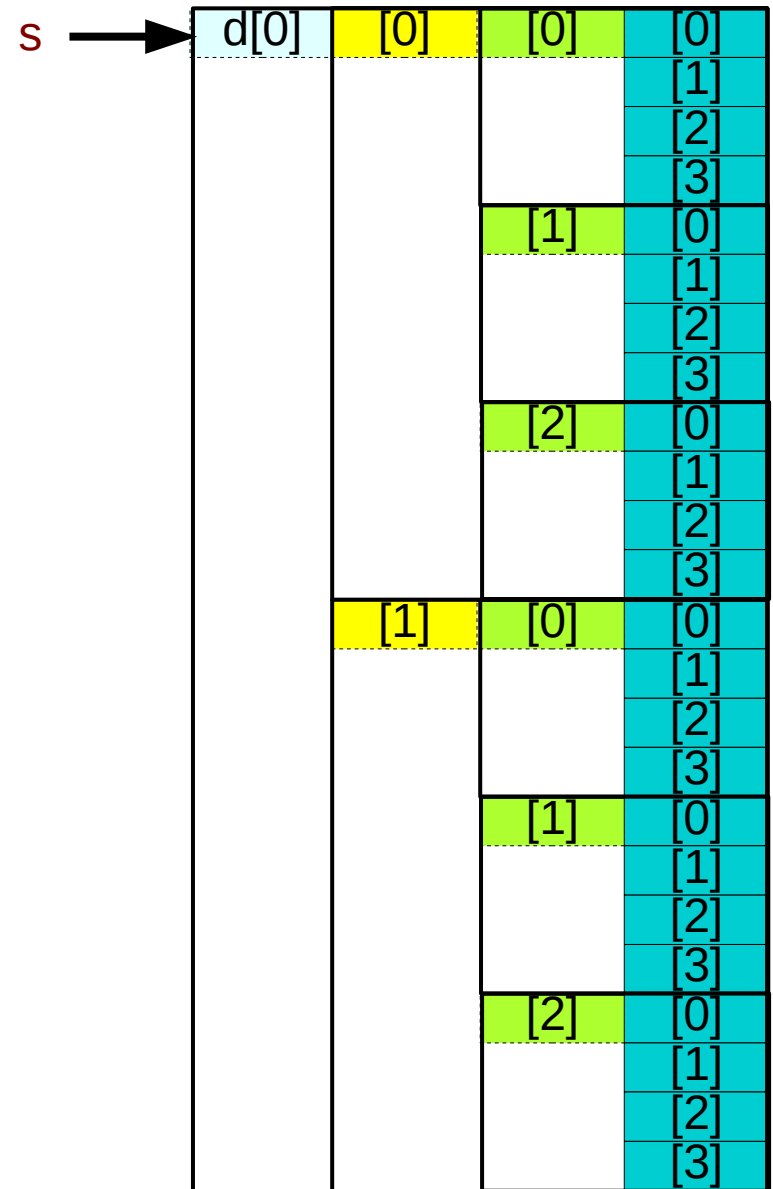

To pass multidimensional array names

```
int a[4];  
int (*p);
```

call
funa(a, ...);

prototype
void **funa**(int (*p), ...);

```
int b[4][2];  
int (*q)[2];
```

call
funb(b, ...);

prototype
void **funb**(int (*q)[2], ...);

```
int c[4][2][3];  
int (*r)[2][3];
```

call
func(c, ...);

prototype
void **func**(int (*r)[2][3], ...);

```
int d[4][2][3][4];  
int (*s)[2][3][4];
```

call
fund(d, ...);

prototype
void **fund**(int (*s)[2][3][4], ...);

References

- [1] Essential C, Nick Parlante
- [2] Efficient C Programming, Mark A. Weiss
- [3] C A Reference Manual, Samuel P. Harbison & Guy L. Steele Jr.
- [4] C Language Express, I. K. Chun