

Laurent Series and z-Transform

- Geometric Series

Applications

ⓑ

20210406 Tue

Copyright (c) 2016 - 2021 Young W. Lim.

Permission is granted to copy, distribute and/or modify this document under the terms of the GNU Free Documentation License, Version 1.2 or any later version published by the Free Software Foundation; with no Invariant Sections, no Front-Cover Texts, and no Back-Cover Texts. A copy of the license is included in the section entitled "GNU Free Documentation License".

$$\dots \quad a_{-3} \quad a_{-2} \quad a_{-1} \quad a_0 \quad a_1 \quad a_2 \quad a_3 \quad \dots$$

$$\dots \quad z^{-3} \quad z^{-2} \quad z^{-1} \quad z^0 \quad z^1 \quad z^2 \quad z^3 \quad \dots$$

causal Laurent $f(z)$

$$a_0 z^0 + a_1 z^1 + a_2 z^2 + a_3 z^3 + \dots$$

anti-causal Laurent $g(z^{-1})$

$$\dots + a_{-3} z^{-3} + a_{-2} z^{-2} + a_{-1} z^{-1}$$

$$\dots \quad a_{-3} \quad a_{-2} \quad a_{-1} \quad a_0 \quad a_1 \quad a_2 \quad a_3 \quad \dots$$

$$\dots \quad z^{-3} \quad z^{-2} \quad z^{-1} \quad z^0 \quad z^{-1} \quad z^{-2} \quad z^{-3} \quad \dots$$

causal z-transform $Y(z)$

$$a_0 z^0 + a_1 z^{-1} + a_2 z^{-2} + a_3 z^{-3} + \dots$$

anti-causal z-transform $X(z^{-1})$

$$\dots + a_{-3} z^3 + a_{-2} z^2 + a_{-1} z^1$$

△

A unit starting Geometric Series

unshifted

Laurent Series

z-Transform

Laurent Series vs. z-Transform

Geometric Series - a unit start term

Laurent Series

(1) $\frac{1}{1 - az}$ $|z| < a^{-1}$

$$(a^0 z^0 + a^1 z^1 + a^2 z^2 + \dots)$$

$$a^n u(n) \quad (n \geq 0)$$

(2) $\frac{1}{1 - a^{-1}z}$ $|z| < a$

$$(a^0 z^0 + a^{-1} z^{-1} + a^{-2} z^{-2} + \dots)$$

$$\left(\frac{1}{a}\right)^0 z^0 + \left(\frac{1}{a}\right)^1 z^{-1} + \left(\frac{1}{a}\right)^2 z^{-2} + \dots$$

$$\left(\frac{1}{a}\right)^n u(n) \quad (n \geq 0)$$

(3) $\frac{1}{1 - a^{-1}z^{-1}}$ $|z| > a^{-1}$

$$- (a^0 z^0 + a^1 z^{-1} + a^2 z^{-2} + \dots)$$

$$-a^n u(-n) \quad (n < 1)$$

(4) $\frac{1}{1 - az^{-1}}$ $|z| > a$

$$- (a^0 z^0 + a^1 z^{-1} + a^2 z^{-2} + \dots)$$

$$- \left(\frac{1}{a}\right)^0 z^0 + \left(\frac{1}{a}\right)^1 z^{-1} + \left(\frac{1}{a}\right)^2 z^{-2} + \dots$$

$$-\left(\frac{1}{a}\right)^n u(-n) \quad (n < 1)$$

Geometric Series - a unit start term

z-Transform $(n \rightarrow -n)$

(1)

$$+ \frac{1}{1 - az}$$

$$|z| < a^{-1}$$

$$(a^0 z^0 + a^1 z^1 + a^2 z^2 + \dots)$$

$$\left(\left(\frac{1}{a}\right)^0 z^0 + \left(\frac{1}{a}\right)^1 z^1 + \left(\frac{1}{a}\right)^2 z^2 + \dots\right)$$

$a^{-n} u(-n)$	$(n \geq 0)$
$\left(\frac{1}{a}\right)^n u(-n)$	$(n < 0)$

(2)

$$+ \frac{1}{1 - a^{-1}z}$$

$$|z| < a$$

$$(a^0 z^0 + a^1 z^1 + a^2 z^2 + \dots)$$

$$\left(\left(\frac{1}{a}\right)^0 z^0 + \left(\frac{1}{a}\right)^1 z^1 + \left(\frac{1}{a}\right)^2 z^2 + \dots\right)$$

$\left(\frac{1}{a}\right)^{-n} u(-n)$	$(n \geq 0)$
$a^n u(-n)$	$(n < 0)$

(3)

$$- \frac{1}{1 - a^{-1}z^{-1}}$$

$$|z| > a^{-1}$$

$$- (a^0 z^0 + a^1 z^1 + a^2 z^2 + \dots)$$

$$- \left(\left(\frac{1}{a}\right)^0 z^0 + \left(\frac{1}{a}\right)^1 z^1 + \left(\frac{1}{a}\right)^2 z^2 + \dots\right)$$

$- a^{-n} u(-(-n))$	$(n < 0)$
$-\left(\frac{1}{a}\right)^n u(n)$	$(n \geq 0)$

(4)

$$- \frac{1}{1 - az^{-1}}$$

$$|z| > a$$

$$- (a^0 z^0 + a^1 z^1 + a^2 z^2 + \dots)$$

$$- \left(\left(\frac{1}{a}\right)^0 z^0 + \left(\frac{1}{a}\right)^1 z^1 + \left(\frac{1}{a}\right)^2 z^2 + \dots\right)$$

$-\left(\frac{1}{a}\right)^n u(-(-n))$	$(n < 0)$
$- a^n u(n)$	$(n \geq 0)$

Geometric Series

Laurent Series vs. z-Transform ($n \rightarrow -n$)

(1)

$$+ \frac{1}{1 - az}$$

$$|z| < a^{-1}$$

$$(a^0 z^0 + a^1 z^1 + a^2 z^2 + \dots)$$

$$\left(\left(\frac{1}{a}\right)^0 z^0 + \left(\frac{1}{a}\right)^1 z^1 + \left(\frac{1}{a}\right)^2 z^2 + \dots\right)$$

$$+ \frac{1}{1 - a^{-1}z}$$

$$|z| < a$$

$$(a^0 z^0 + a^1 z^1 + a^2 z^2 + \dots)$$

$$\left(\left(\frac{1}{a}\right)^0 z^0 + \left(\frac{1}{a}\right)^1 z^1 + \left(\frac{1}{a}\right)^2 z^2 + \dots\right)$$

(2)

Laurent

$$a^n u(n) \quad (n \geq 0)$$

$$\left(\frac{1}{a}\right)^n u(n) \quad (n \geq 0)$$

z-Trans

$$\left(\frac{1}{a}\right)^n u(-n) \quad (n < 1)$$

$$a^n u(-n) \quad (n < 1)$$

(3)

$$- \frac{1}{1 - a^{-1}z^{-1}}$$

$$|z| > a^{-1}$$

$$- (a^0 z^0 + a^1 z^1 + a^2 z^2 + \dots)$$

$$- \left(\left(\frac{1}{a}\right)^0 z^0 + \left(\frac{1}{a}\right)^1 z^1 + \left(\frac{1}{a}\right)^2 z^2 + \dots\right)$$

$$- \frac{1}{1 - az^{-1}}$$

$$|z| > a$$

$$- (a^0 z^0 + a^1 z^1 + a^2 z^2 + \dots)$$

$$- \left(\left(\frac{1}{a}\right)^0 z^0 + \left(\frac{1}{a}\right)^1 z^1 + \left(\frac{1}{a}\right)^2 z^2 + \dots\right)$$

(4)

Laurent

$$- a^n u(-n) \quad (n < 1)$$

$$- \left(\frac{1}{a}\right)^n u(-n) \quad (n < 1)$$

z-Trans

$$- \left(\frac{1}{a}\right)^n u(n) \quad (n \geq 0)$$

$$- a^n u(n) \quad (n \geq 0)$$

A CR starting

Geometric Series

shifted, complementary

Laurent Series

z-Transform

Laurent Series vs. z-Transform

Geometric Series - a non-unit start term

Laurent Series

(5)

$$\frac{a^{-1}z^{-1}}{1 - a^{-1}z^{-1}}$$

$$|z| > a^{-1}$$

$$- (a^{-1}z^{-1} + a^{-2}z^{-2} + a^{-3}z^{-3} + \dots)$$

$$- a^n u(-n-1) \quad (n < 0)$$

(6)

$$\frac{az^{-1}}{1 - az^{-1}}$$

$$|z| > a$$

$$- (a^1 z^{-1} + a^2 z^{-2} + a^3 z^{-3} + \dots)$$

$$- \left(\left(\frac{1}{a}\right)^1 z^{-1} + \left(\frac{1}{a}\right)^2 z^{-2} + \left(\frac{1}{a}\right)^3 z^{-3} + \dots \right)$$

$$- \left(\frac{1}{a}\right)^n u(-n-1) \quad (n < 0)$$

(7)

$$+ \frac{az}{1 - az}$$

$$|z| < a^{-1}$$

$$(a^1 z^1 + a^2 z^2 + a^3 z^3 + \dots)$$

$$a^n u(n-1) \quad (n \geq 1)$$

(8)

$$+ \frac{a^{-1}z}{1 - a^{-1}z}$$

$$|z| < a$$

$$(a^{-1} z^1 + a^{-2} z^2 + a^{-3} z^3 + \dots)$$

$$\left(\left(\frac{1}{a}\right)^1 z^1 + \left(\frac{1}{a}\right)^2 z^2 + \left(\frac{1}{a}\right)^3 z^3 + \dots \right)$$

$$\left(\frac{1}{a}\right)^n u(n-1) \quad (n \geq 1)$$

Geometric Series - a non-unit start term

z-Transform ($n \rightarrow -n$)

(5)
$$-\frac{a^{-1}z^{-1}}{1-a^{-1}z^{-1}} \quad |z| > a^{-1}$$

$$-(a^{-1}z^{-1} + a^{-2}z^{-2} + a^{-3}z^{-3} + \dots)$$

$$-((\frac{1}{a})^{-1}z^{-1} + (\frac{1}{a})^{-2}z^{-2} + (\frac{1}{a})^{-3}z^{-3} + \dots)$$

$$-a^{-n} u(-(-n)-1) \quad (-n < 0)$$

$$-(\frac{1}{a})^n u(n-1) \quad (n \geq 1)$$

(6)
$$-\frac{az^{-1}}{1-az^{-1}} \quad |z| > a$$

$$-(a^1 z^{-1} + a^2 z^{-2} + a^3 z^{-3} + \dots)$$

$$-((\frac{1}{a})^{-1}z^{-1} + (\frac{1}{a})^{-2}z^{-2} + (\frac{1}{a})^{-3}z^{-3} + \dots)$$

$$-(\frac{1}{a})^{-n} u(-(-n)-1) \quad (-n < 0)$$

$$-a^n u(n-1) \quad (n \geq 1)$$

(7)
$$+\frac{az}{1-az} \quad |z| < a^{-1}$$

$$(a^1 z^1 + a^2 z^2 + a^3 z^3 + \dots)$$

$$((\frac{1}{a})^{-1}z^1 + (\frac{1}{a})^{-2}z^2 + (\frac{1}{a})^{-3}z^3 + \dots)$$

$$a^{-n} u((-n)-1) \quad (-n \geq 1)$$

$$(\frac{1}{a})^n u(-n-1) \quad (n < 0)$$

(8)
$$+\frac{a^{-1}z}{1-a^{-1}z} \quad |z| < a$$

$$(a^{-1} z^1 + a^{-2} z^2 + a^{-3} z^3 + \dots)$$

$$((\frac{1}{a})^{-1}z^1 + (\frac{1}{a})^{-2}z^2 + (\frac{1}{a})^{-3}z^3 + \dots)$$

$$(\frac{1}{a})^{-n} u((-n)-1) \quad (-n \geq 1)$$

$$a^n u(-n-1) \quad (n < 0)$$

Geometric Series - a non-unit start term

Laurent Series vs. z-Transform ($n \rightarrow -n$)

(5) $\frac{a^{-1}z^{-1}}{1-a^{-1}z^{-1}} \quad |z| > a^{-1}$ $\frac{az^{-1}}{1-az^{-1}} \quad |z| > a$ (6)

$$-(a^{-1}z^{-1} + a^{-2}z^{-2} + a^{-3}z^{-3} + \dots)$$

$$-\left(\left(\frac{1}{a}\right)^1 z^{-1} + \left(\frac{1}{a}\right)^2 z^{-2} + \left(\frac{1}{a}\right)^3 z^{-3} + \dots\right)$$

$$-(a^1 z^{-1} + a^2 z^{-2} + a^3 z^{-3} + \dots)$$

$$-\left(\left(\frac{1}{a}\right)^1 z^{-1} + \left(\frac{1}{a}\right)^2 z^{-2} + \left(\frac{1}{a}\right)^3 z^{-3} + \dots\right)$$

Laurent $-a^n u(-n-1) \quad (n < 0)$

z-Trans $-\left(\frac{1}{a}\right)^n u(n-1) \quad (n \geq 1)$

$-\left(\frac{1}{a}\right)^n u(-n-1) \quad (n < 0)$

$-a^n u(n-1) \quad (n \geq 1)$

(7) $+\frac{az}{1-az} \quad |z| < a^{-1}$ $+\frac{a^{-1}z}{1-a^{-1}z} \quad |z| < a$ (8)

$$(a^1 z^1 + a^2 z^2 + a^3 z^3 + \dots)$$

$$\left(\left(\frac{1}{a}\right)^1 z^1 + \left(\frac{1}{a}\right)^2 z^2 + \left(\frac{1}{a}\right)^3 z^3 + \dots\right)$$

$$(a^{-1} z^1 + a^{-2} z^2 + a^{-3} z^3 + \dots)$$

$$\left(\left(\frac{1}{a}\right)^1 z^1 + \left(\frac{1}{a}\right)^2 z^2 + \left(\frac{1}{a}\right)^3 z^3 + \dots\right)$$

Laurent $a^n u(n-1) \quad (n \geq 1)$

z-Trans $\left(\frac{1}{a}\right)^n u(-n-1) \quad (n < 0)$

$\left(\frac{1}{a}\right)^n u(n-1) \quad (n \geq 1)$

$a^n u(-n-1) \quad (n < 0)$

4 cases of geometric series Simple Pole Form

- 2 representations for each case

using z

using $1/z$

simple pole p

simple pole $1/p$

simple pole $1/p$

simple pole p

(A)

$$\frac{1}{z - p}$$

(B)

$$\frac{1}{z - p^{-1}}$$

(C)

$$\frac{1}{z^{-1} - p}$$

(D)

$$\frac{1}{z^{-1} - p^{-1}}$$

$/p$

$$\frac{p^{-1}}{1 - p^{-1}z}$$

$*p$

$$\frac{p}{1 - pz}$$

$/p$

$$\frac{p^{-1}}{1 - p^{-1}z^{-1}}$$

$*p$

$$\frac{p}{1 - pz^{-1}}$$

$/z$

$$\frac{z^{-1}}{1 - pz^{-1}}$$

$/z$

$$\frac{z^{-1}}{1 - p^{-1}z^{-1}}$$

$*z$

$$\frac{z}{1 - pz}$$

$*z$

$$\frac{z}{1 - p^{-1}z}$$

p^{-1}

p^{-1}

z^{-1}

$/p$

$$\frac{-p^{-n-1}}{u(n)}$$

$*p$

$$\frac{-p^{n+1}}{u(n)}$$

$/p$

$$\frac{-p^{-n-1}}{u(-n)}$$

$*p$

$$\frac{-p^{-n+1}}{u(-n)}$$

$/z$

$$\frac{p^{-n-1}}{u(-n-1)}$$

$/z$

$$\frac{p^{n+1}}{u(-n-1)}$$

$*z$

$$\frac{-p^{-n-1}}{u(n-1)}$$

$*z$

$$\frac{-p^{-n+1}}{u(n-1)}$$

4 cases of geometric series Simple Pole Form

- 2 representations for each case

using p

using $1/p$

simple pole p

simple pole $1/p$

simple pole $1/p$

simple pole p

(A) $\frac{1}{z - p}$

(C) $\frac{1}{z^{-1} - p}$

(B) $\frac{1}{z - p^{-1}}$

(D) $\frac{1}{z^{-1} - p^{-1}}$

$/p$ $-\frac{p^{-1}}{1 - p^{-1}z}$

$/p$ $-\frac{p^{-1}}{1 - p^{-1}z^{-1}}$

$*p$ $-\frac{p}{1 - pz}$

$*p$ $-\frac{p}{1 - pz^{-1}}$

$/z$ $\frac{z^{-1}}{1 - pz^{-1}}$

$*z$ $\frac{z}{1 - pz}$

$/z$ $\frac{z^{-1}}{1 - p^{-1}z^{-1}}$

$*z$ $\frac{z}{1 - p^{-1}z}$

z^{-1}

z^{-1}

p^{-1}

$/p$ $\frac{-p^{-n-1}}{u(n)}$

$/p$ $\frac{-p^{-n-1}}{u(-n)}$

$*p$ $\frac{-p^{n+1}}{u(n)}$

$*p$ $\frac{-p^{n+1}}{u(-n)}$

$/z$ $\frac{p^{-n-1}}{u(-n-1)}$

$*z$ $\frac{-p^{-n-1}}{u(n-1)}$

$/z$ $\frac{p^{n+1}}{u(-n-1)}$

$*z$ $\frac{-p^{n+1}}{u(n-1)}$

(A)

$\frac{1}{z - p}$	$\frac{z^{-1}}{1 - pz^{-1}}$	$-\frac{p^{-1}}{1 - p^{-1}z}$
p^2 z^{-3}	p^1 z^{-2}	p^0 z^{-1}
p^{-1} z^0	p^{-2} z^1	p^{-3} z^2
p^{-4} z^3		

$\leftarrow \dots + p^2 z^{-3} + p^1 z^{-2} + p^0 z^{-1} \quad p^{-1} z^0 + p^{-2} z^1 + p^{-3} z^2 + p^{-4} z^3 + \dots \rightarrow$

(B)

$\frac{1}{z - p^{-1}}$	$\frac{p}{1 - pz}$	$\frac{z^{-1}}{1 - p^{-1}z^{-1}}$
p^{-2} z^{-3}	p^{-1} z^{-2}	p^0 z^{-1}
p^1 z^0	p^2 z^1	p^3 z^2
p^4 z^3		

$\leftarrow \dots + p^{-2} z^{-3} + p^{-1} z^{-2} + p^0 z^{-1} \quad p^{-1} z^0 + p^{-2} z^1 + p^{-3} z^2 + p^{-4} z^3 + \dots \rightarrow$

(C)

$\frac{1}{z^{-1} - p}$	$-\frac{p^{-1}}{1 - p^{-1}z^{-1}}$	$\frac{z}{1 - pz}$
------------------------	------------------------------------	--------------------

(D)

$\frac{1}{z^{-1} - p^{-1}}$	$\frac{p}{1 - pz^{-1}}$	$\frac{z}{1 - p^{-1}z}$
-----------------------------	-------------------------	-------------------------

when the pole is expressed as p

2 formulas

Simple Pole Form

$$\frac{1}{z - p}$$

$$\frac{1}{z^{-1} - p}$$

2 representations each

Shifted Geometric Series Form

(A)

$$\frac{1}{z - p} \begin{cases} \cong \frac{p^{-1}}{1 - p^{-1}z} \triangleq f(z) = \chi(z^{-1}) \\ \cong \frac{z^{-1}}{1 - pz^{-1}} \triangleq g(z^{-1}) = \Upsilon(z) \end{cases}$$

causal
Laurent
 anti-causal
z-transform

||
||

anti-causal
Laurent
 causal
z-transform

(C)

$$\frac{1}{z^{-1} - p} \begin{cases} \cong \frac{p^{-1}}{1 - p^{-1}z^{-1}} \triangleq f(z^{-1}) = \chi(z) \\ \cong \frac{z}{1 - pz} \triangleq g(z) = \Upsilon(z^{-1}) \end{cases}$$

anti-causal
Laurent
 causal
z-transform

||
||

causal
Laurent
 anti-causal
z-transform

Simple Pole Form

Shifted Geometric Series Form

when the pole is expressed as $1/p$

2 formulas

Simple Pole Form

$$\frac{1}{z - p^{-1}}$$

$$\frac{1}{z^{-1} - p^{-1}}$$

2 representations each

Shifted Geometric Series Form

(B)

$$\frac{1}{z - p^{-1}} \begin{cases} \cong \frac{p}{1 - pz} \triangleq f(z) = \begin{matrix} \text{causal} \\ \text{Laurent} \end{matrix} = \begin{matrix} \text{anti-causal} \\ \text{z-transform} \end{matrix} X(z^{-1}) \\ \cong \frac{z^{-1}}{1 - p^{-1}z^{-1}} \triangleq g(z^{-1}) = \begin{matrix} \text{anti-causal} \\ \text{Laurent} \end{matrix} = \begin{matrix} \text{causal} \\ \text{z-transform} \end{matrix} Y(z) \end{cases}$$

(D)

$$\frac{1}{z^{-1} - p^{-1}} \begin{cases} \cong \frac{p}{1 - pz^{-1}} \triangleq f(z^{-1}) = \begin{matrix} \text{anti-causal} \\ \text{Laurent} \end{matrix} = \begin{matrix} \text{causal} \\ \text{z-transform} \end{matrix} X(z) \\ \cong \frac{z}{1 - p^{-1}z} \triangleq g(z) = \begin{matrix} \text{causal} \\ \text{Laurent} \end{matrix} = \begin{matrix} \text{anti-causal} \\ \text{z-transform} \end{matrix} Y(z^{-1}) \end{cases}$$

Simple Pole Form

Shifted Geometric Series Form

(A) $\frac{1}{z-p}$

$\frac{p^{-1}}{1-p^{-1}z}$	$-(p^{-1}z^0 + p^{-2}z^1 + p^{-3}z^2 + \dots)$	$f(z)$	causal Laurent
	$-((\frac{1}{p})z^0 + (\frac{1}{p})z^1 + (\frac{1}{p})z^2 + \dots)$	$X(z^{-1})$	anti-causal z-transform
$\frac{z^{-1}}{1-pz^{-1}}$	$(p^0z^{-1} + p^1z^{-2} + p^2z^{-3} + \dots)$	$g(z^{-1})$	anti-causal Laurent
	$((\frac{1}{p})z^{-1} + (\frac{1}{p})z^{-2} + (\frac{1}{p})z^{-3} + \dots)$	$Y(z)$	causal z-transform

(C) $\frac{1}{z^{-1}-p}$

$\frac{p}{1-pz^{-1}}$	$-(p^1z^0 + p^2z^1 + p^3z^2 + \dots)$	$f(z^{-1})$	anti-causal Laurent
	$-((\frac{1}{p})z^0 + (\frac{1}{p})z^1 + (\frac{1}{p})z^2 + \dots)$	$X(z)$	causal z-transform
$\frac{z}{1-pz}$	$(p^0z^1 + p^1z^2 + p^2z^3 + \dots)$	$g(z)$	causal Laurent
	$((\frac{1}{p})z^1 + (\frac{1}{p})z^2 + (\frac{1}{p})z^3 + \dots)$	$Y(z^{-1})$	anti-causal z-transform

(B) $\frac{1}{z-p^{-1}}$

$\frac{p}{1-pz}$	$-(p^1z^0 + p^2z^1 + p^3z^2 + \dots)$	$f(z)$	causal Laurent
	$-((\frac{1}{p})z^0 + (\frac{1}{p})z^1 + (\frac{1}{p})z^2 + \dots)$	$X(z^{-1})$	anti-causal z-transform
$\frac{z^{-1}}{1-p^{-1}z^{-1}}$	$(p^0z^{-1} + p^1z^{-2} + p^2z^{-3} + \dots)$	$g(z^{-1})$	anti-causal Laurent
	$((\frac{1}{p})z^{-1} + (\frac{1}{p})z^{-2} + (\frac{1}{p})z^{-3} + \dots)$	$Y(z)$	causal z-transform

(D) $\frac{1}{z^{-1}-p^{-1}}$

$\frac{p}{1-pz^{-1}}$	$-(p^1z^0 + p^2z^1 + p^3z^2 + \dots)$	$f(z^{-1})$	anti-causal Laurent
	$-((\frac{1}{p})z^0 + (\frac{1}{p})z^1 + (\frac{1}{p})z^2 + \dots)$	$X(z)$	causal z-transform
$\frac{z}{1-p^{-1}z}$	$(p^0z^1 + p^1z^2 + p^2z^3 + \dots)$	$g(z)$	causal Laurent
	$((\frac{1}{p})z^1 + (\frac{1}{p})z^2 + (\frac{1}{p})z^3 + \dots)$	$Y(z^{-1})$	anti-causal z-transform

Shifted Geometric Series (1) p

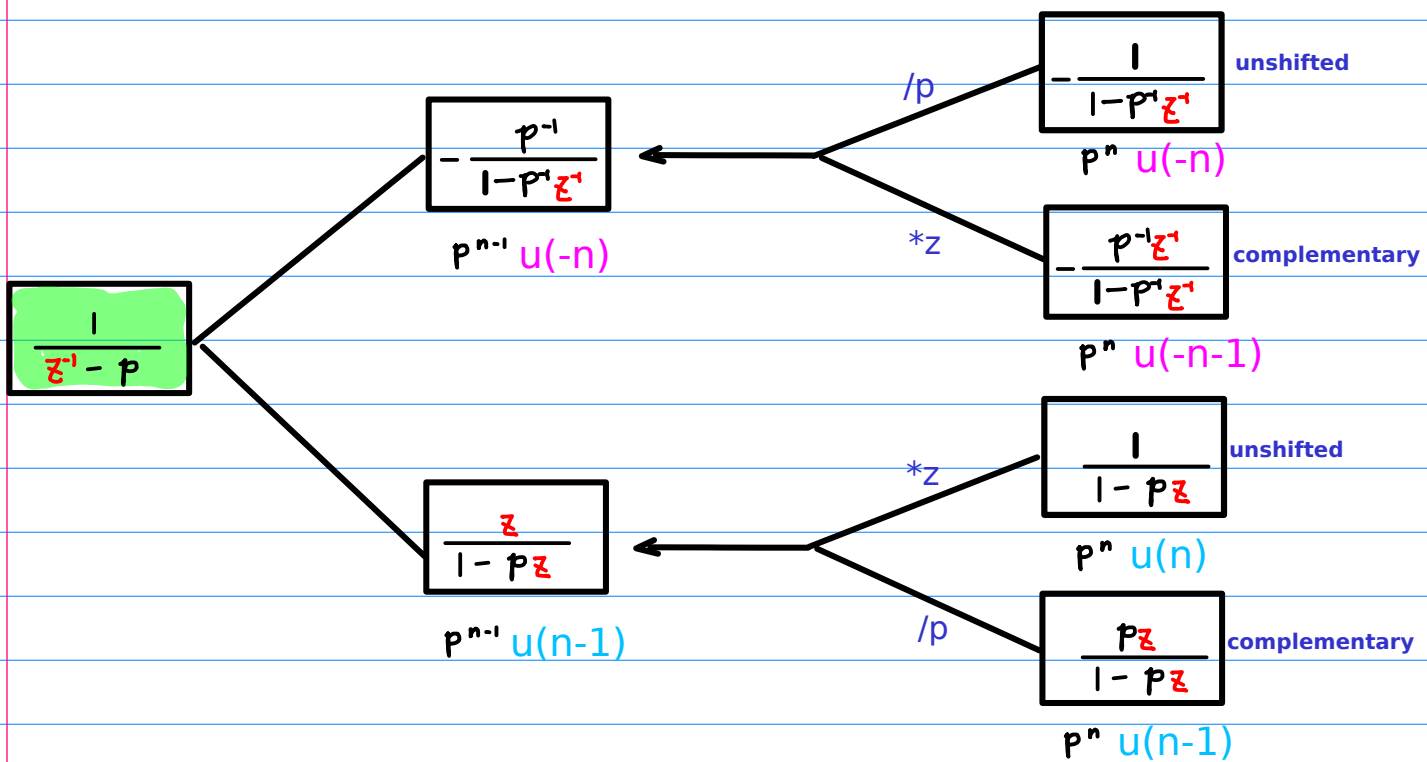
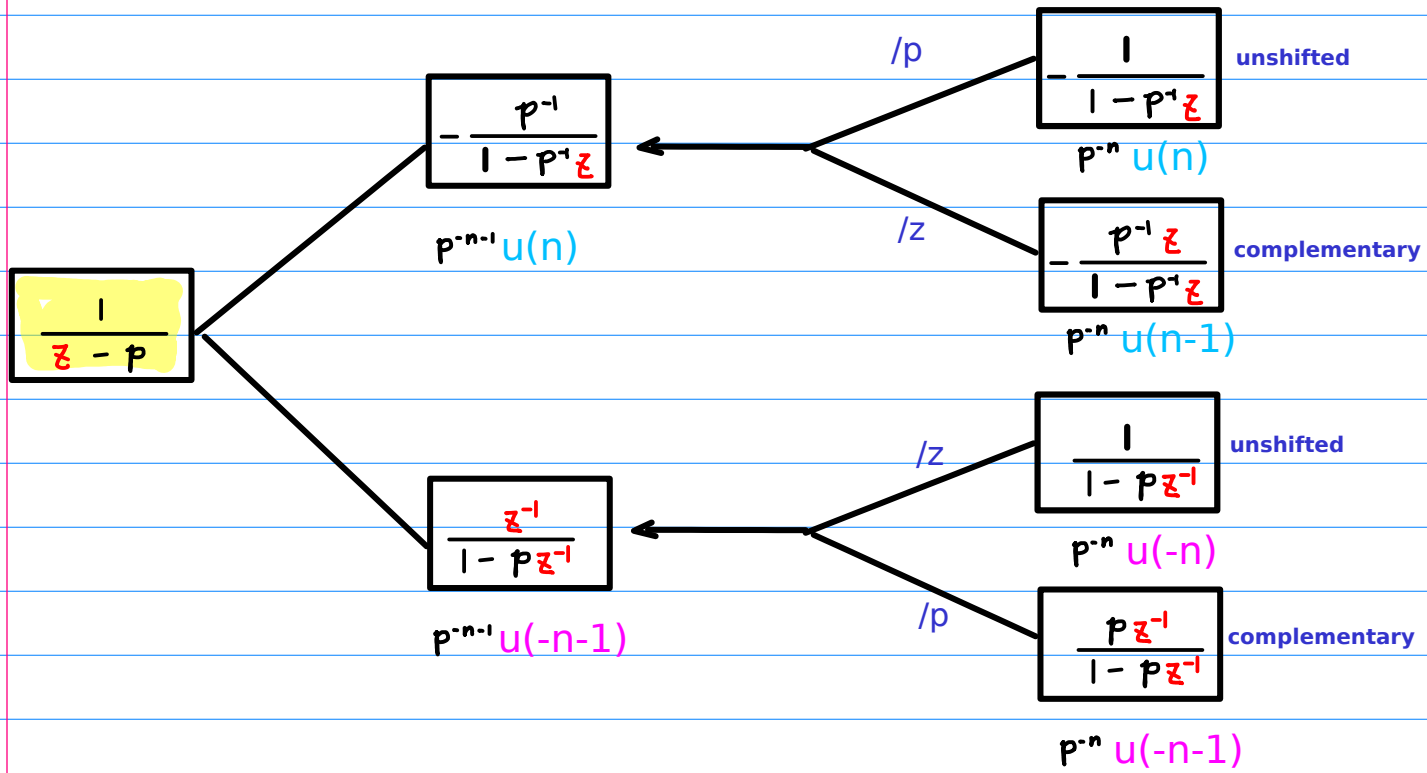

Shifted Geometric Series (2) 1/p

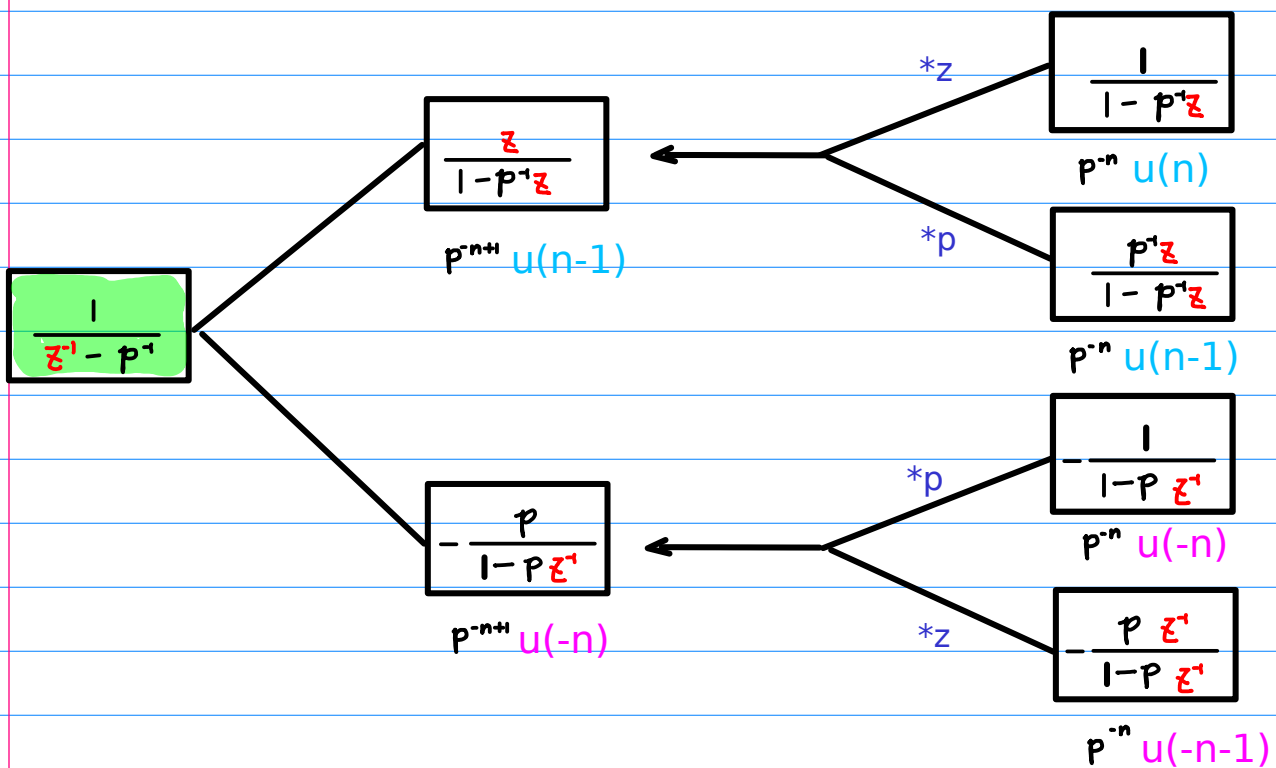
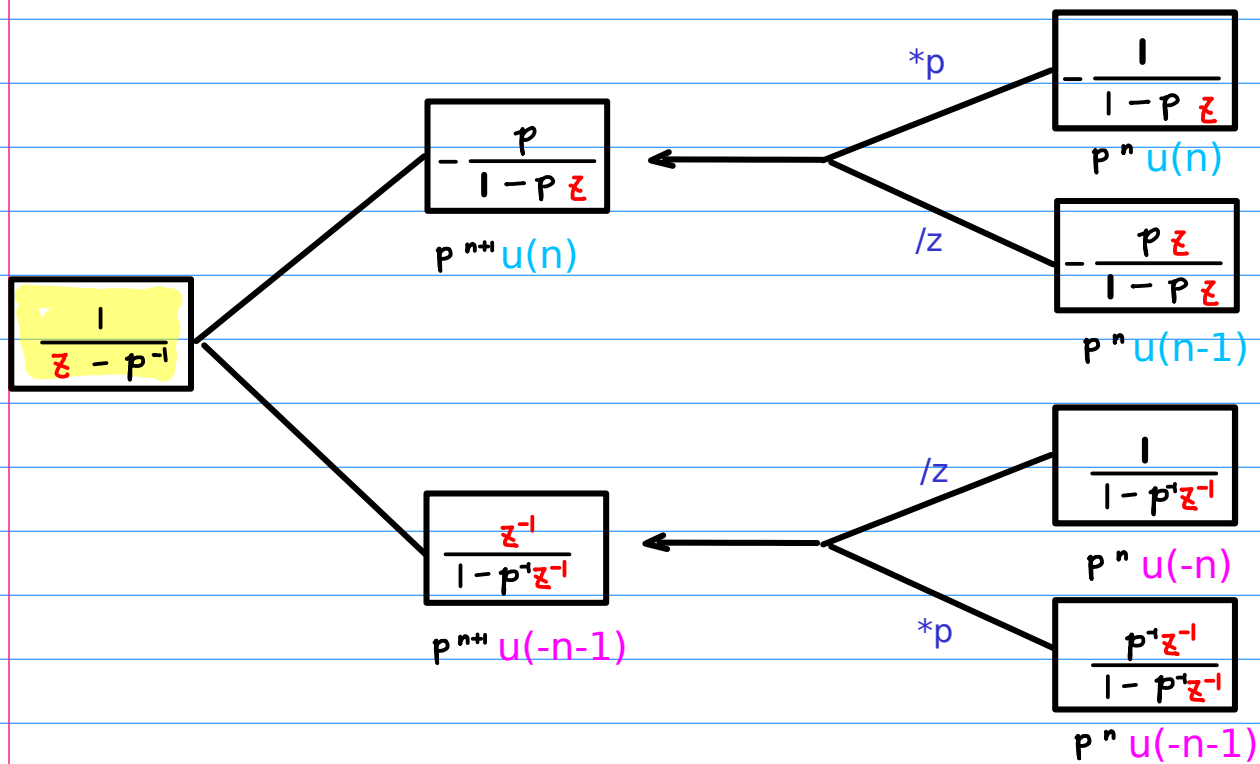

2 formulas

Simple Pole Form

$$\frac{1}{z - p}$$

$$\frac{1}{z^{-1} - p}$$

2 representations each

Geometric Series Form

$$\begin{array}{l} \frac{1}{z - p} \\ \swarrow \quad \searrow \\ \frac{p^{-1}}{1 - p^{-1}z} \triangleq \begin{array}{l} \text{causal} \\ f(z) = \chi(z^{-1}) \\ \text{anti-causal} \end{array} \\ \frac{z^{-1}}{1 - pz^{-1}} \triangleq \begin{array}{l} \text{causal} \\ \gamma(z) = g(z^{-1}) \\ \text{anti-causal} \end{array} \end{array}$$

$$\begin{array}{l} \frac{1}{z^{-1} - p} \\ \swarrow \quad \searrow \\ \frac{p^{-1}}{1 - p^{-1}z^{-1}} \triangleq \begin{array}{l} \text{causal} \\ \chi(z) = f(z^{-1}) \\ \text{anti-causal} \end{array} \\ \frac{z}{1 - pz} \triangleq \begin{array}{l} \text{causal} \\ g(z) = \gamma(z^{-1}) \\ \text{anti-causal} \end{array} \end{array}$$

Simple Pole Form

Geometric Series Form

Simple Pole Form

①

$-\frac{1}{1-az}$	$ z < a^{-1}$
$-a^n$	$(n \geq 0)$

②

$-\frac{1}{1-az^{-1}}$	$ z > a$
$-(\frac{1}{a})^n$	$(n < 1)$

③

$\frac{1}{1-a^{-1}z^{-1}}$	$ z > a^{-1}$
a^n	$(n < 1)$

④

$\frac{1}{1-a^{-1}z}$	$ z < a$
$(\frac{1}{a})^n$	$(n \geq 0)$

⑤

$-\frac{1}{1-a^{-1}z}$	$ z < a$
$-(\frac{1}{a})^n$	$(n \geq 0)$

⑥

$-\frac{1}{1-az^{-1}}$	$ z > a^{-1}$
$-a^n$	$(n < 1)$

⑦

$\frac{1}{1-az^{-1}}$	$ z > a$
$(\frac{1}{a})^n$	$(n < 1)$

⑧

$\frac{1}{1-az}$	$ z < a^{-1}$
a^n	$(n \geq 0)$

Geometric Series : $f(z)$, $g(z)$, $\bar{f}(z)$, $\bar{g}(z)$

$f(z) = -\frac{a}{1-az}$	$ z < a^{-1}$
$a_n = -a^{n+1}$	$(n \geq 0)$

$f(z^{-1}) = -\frac{a}{1-az^{-1}}$	$ z > a$
$a_n = -\left(\frac{1}{a}\right)^{n+1}$	$(n < 1)$

$g(z^{-1}) = \frac{z^{-1}}{1-a^{-1}z^{-1}}$	$ z > a^{-1}$
$a_n = a^{n+1}$	$(n < 0)$

$g(z) = \frac{z}{1-a^{-1}z}$	$ z < a$
$a_n = -\left(\frac{1}{a}\right)^{n+1}$	$(n \geq 1)$

$\bar{f}(z) = -\frac{a^{-1}}{1-a^{-1}z}$	$ z < a$
$a_n = -\left(\frac{1}{a}\right)^{n+1}$	$(n \geq 0)$

$\bar{f}(z^{-1}) = -\frac{a^{-1}}{1-a^{-1}z^{-1}}$	$ z > a^{-1}$
$a_n = -a^{n+1}$	$(n < 1)$

$\bar{g}(z^{-1}) = \frac{z^{-1}}{1-az^{-1}}$	$ z > a$
$a_n = \left(\frac{1}{a}\right)^{n+1}$	$(n < 0)$

$\bar{g}(z) = \frac{z}{1-az}$	$ z < a^{-1}$
$a_n = -a^{n+1}$	$(n \geq 1)$

Geometric Series :

$$f(z) = g(z^*)$$

the same algebraic formula
but the complement ROC's

$$g(z) = f(z^*)$$

the same algebraic formula
but the complement ROC's

$$f(z) = f_a(z)$$

two variable function

$$g(z) = g_a(z)$$

two variable function

$$\bar{f}(z) = f_{a^{-1}}(z)$$

inverse a

$$\bar{g}(z) = g_{a^{-1}}(z)$$

inverse a

associated simple pole forms

$a^n f(z)$, $z^n g(z)$, $a^n \bar{f}(z)$, $z^n \bar{g}(z)$

①

$a^n f(z) = -\frac{1}{1-az}$	$ z < a^{-1}$
$a_n = -a^n$	$(n \geq 0)$

②

$a^n f(z^{-1}) = -\frac{1}{1-az^{-1}}$	$ z > a$
$a_n = -\left(\frac{1}{a}\right)^n$	$(n < 1)$

③

$z g(z^{-1}) = \frac{1}{1-a^{-1}z^{-1}}$	$ z > a^{-1}$
$a_n = a^n$	$(n < 1)$

④

$z^{-1} g(z) = \frac{1}{1-a^{-1}z}$	$ z < a$
$a_n = \left(\frac{1}{a}\right)^n$	$(n \geq 0)$

⑤

$a^n \bar{f}(z) = -\frac{1}{1-a^{-1}z}$	$ z < a$
$a_n = -\left(\frac{1}{a}\right)^n$	$(n \geq 0)$

⑥

$a^n \bar{f}(z^{-1}) = -\frac{1}{1-a^{-1}z^{-1}}$	$ z > a^{-1}$
$a_n = -a^n$	$(n < 1)$

⑦

$z \bar{g}(z^{-1}) = \frac{1}{1-az^{-1}}$	$ z > a$
$a_n = \left(\frac{1}{a}\right)^n$	$(n < 1)$

⑧

$z^{-1} \bar{g}(z) = \frac{1}{1-az}$	$ z < a^{-1}$
$a_n = a^n$	$(n \geq 0)$

(1)	(2)
(3)	(4)
(5)	(6)
(7)	(8)

(1)	(2)
(3)	(4)
(5)	(6)
(7)	(8)

$f(z)$ $f(z^{-1})$
 $g(z^{-1})$ $g(z)$
 $\bar{f}(z)$ $\bar{f}(z^{-1})$
 $\bar{g}(z^{-1})$ $\bar{g}(z)$

①

$a_n = -a^{n+1}$	$(n \geq 0)$
$f(z) = -\frac{a}{1-az}$	$ z < a^{-1}$

neg(n) Sym(n)

inv(z) inv(z)

②

$a_n = -(\frac{1}{a})^{n-1}$	$(n < 1)$
$f(z^{-1}) = -\frac{a}{1-az^{-1}}$	$ z > a$

sign
sign

comp(z)
comp(n)

sign
sign

comp(z)
comp(n)

③

$g(z^{-1}) = \frac{z^{-1}}{1-a^{-1}z^{-1}}$	$ z > a^{-1}$
$a_n = a^{n+1}$	$(n < 0)$

neg(n) Sym(n)

inv(z) inv(z)

④

$g(z) = \frac{z}{1-a^{-1}z}$	$ z < a$
$a_n = (\frac{1}{a})^{n-1}$	$(n \geq 1)$

⑤

$a_n = -(\frac{1}{a})^{n+1}$	$(n \geq 0)$
$\bar{f}(z) = -\frac{a^{-1}}{1-a^{-1}z}$	$ z < a$

neg(n) Sym(n)

inv(z) inv(z)

⑥

$a_n = -a^{n-1}$	$(n < 1)$
$\bar{f}(z^{-1}) = -\frac{a^{-1}}{1-a^{-1}z^{-1}}$	$ z > a^{-1}$

sign
sign

comp(z)
comp(n)

sign
sign

comp(z)
comp(n)

⑦

$\bar{g}(z^{-1}) = \frac{z^{-1}}{1-az^{-1}}$	$ z > a$
$a_n = (\frac{1}{a})^{n+1}$	$(n < 0)$

neg(n) Sym(n)

inv(z) inv(z)

⑧

$\bar{g}(z) = \frac{z}{1-az}$	$ z < a^{-1}$
$a_n = a^{n-1}$	$(n \geq 1)$

(1)	(2)
(3)	(4)
(5)	(6)
(7)	(8)

(1)	(2)
(3)	(4)
(5)	(6)
(7)	(8)

$f(z)$ $f(z^{-1})$
 $g(z^{-1})$ $g(z)$
 $\bar{f}(z)$ $\bar{f}(z^{-1})$
 $\bar{g}(z^{-1})$ $\bar{g}(z)$

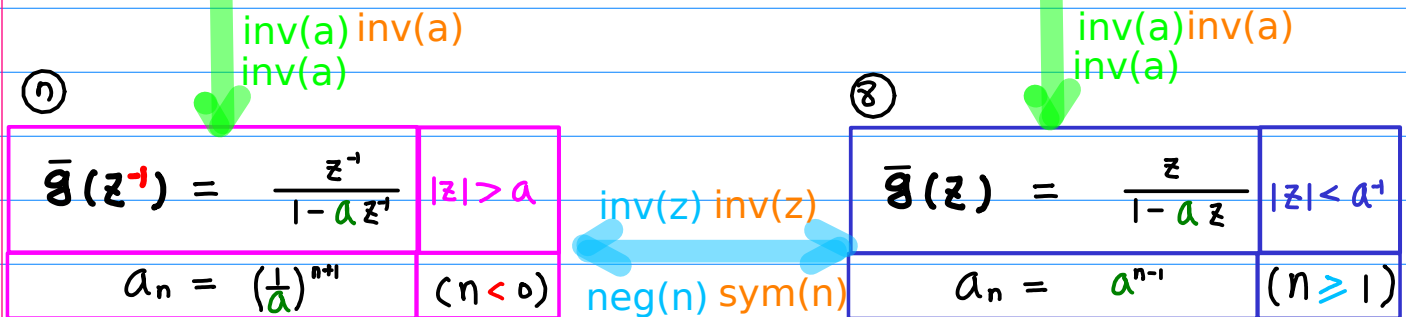
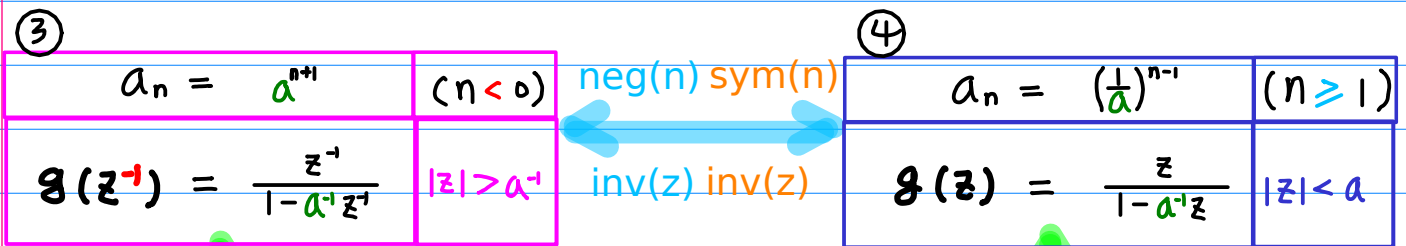
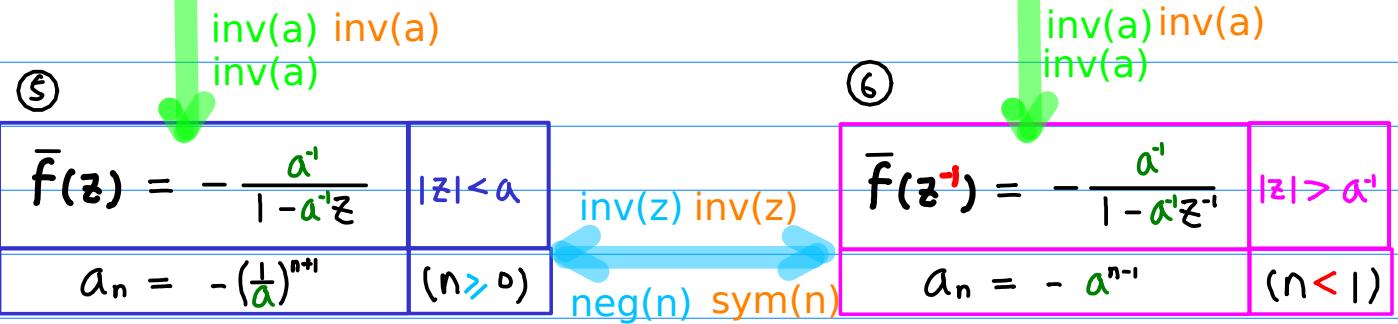
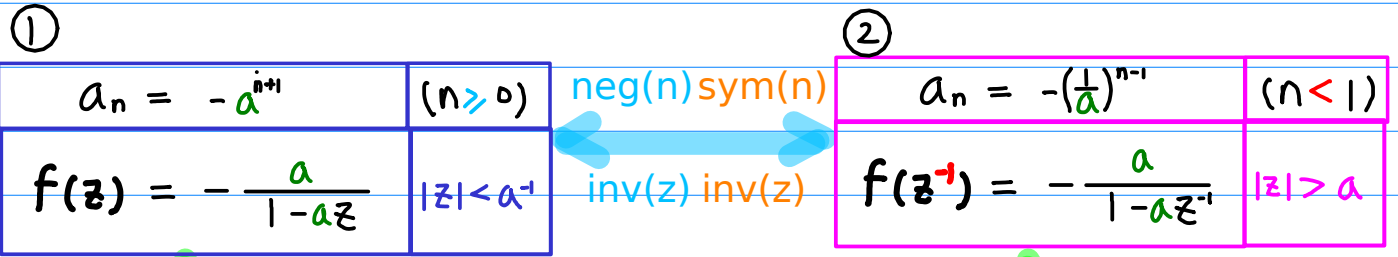

(1)	(2)
(3)	(4)
(5)	(6)
(7)	(8)

(1)	(2)
(3)	(4)
(5)	(6)
(7)	(8)

$$\begin{aligned} a^1 f(z) & a^1 f(z^{-1}) \\ z g(z^{-1}) & z^{-1} g(z) \\ a \bar{f}(z) & a \bar{f}(z^{-1}) \\ z \bar{g}(z^{-1}) & z^{-1} \bar{g}(z) \end{aligned}$$

a unit nominator

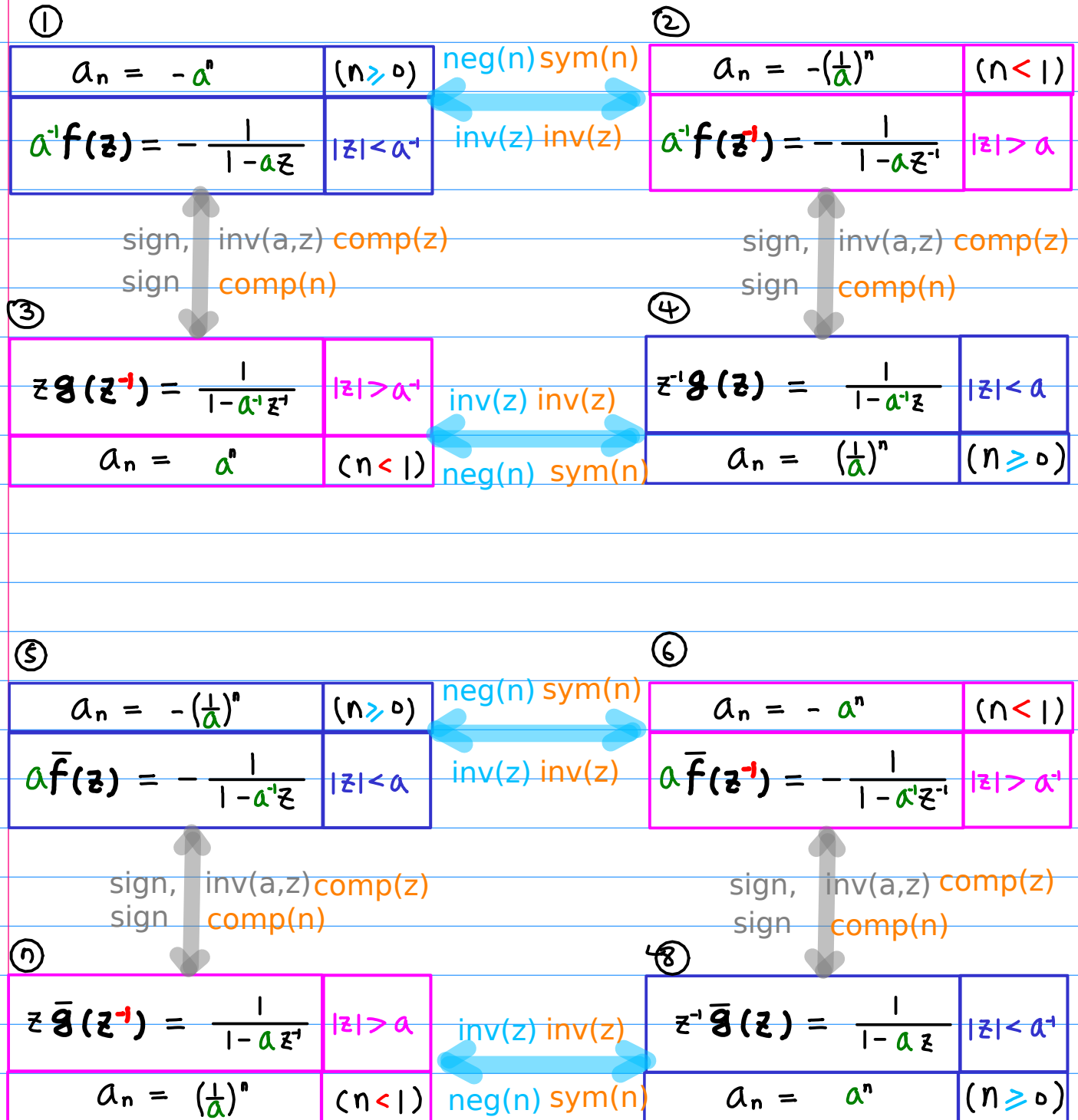

(1)	(2)
(3)	(4)
(5)	(6)
(7)	(8)

(1)	(2)
(3)	(4)
(5)	(6)
(7)	(8)

$a^1 f(z)$ $a^1 f(z^{-1})$
 $z g(z^{-1})$ $z^{-1} g(z)$
 $a \bar{f}(z)$ $a \bar{f}(z^{-1})$
 $z \bar{g}(z^{-1})$ $z^{-1} \bar{g}(z)$

a unit nominator

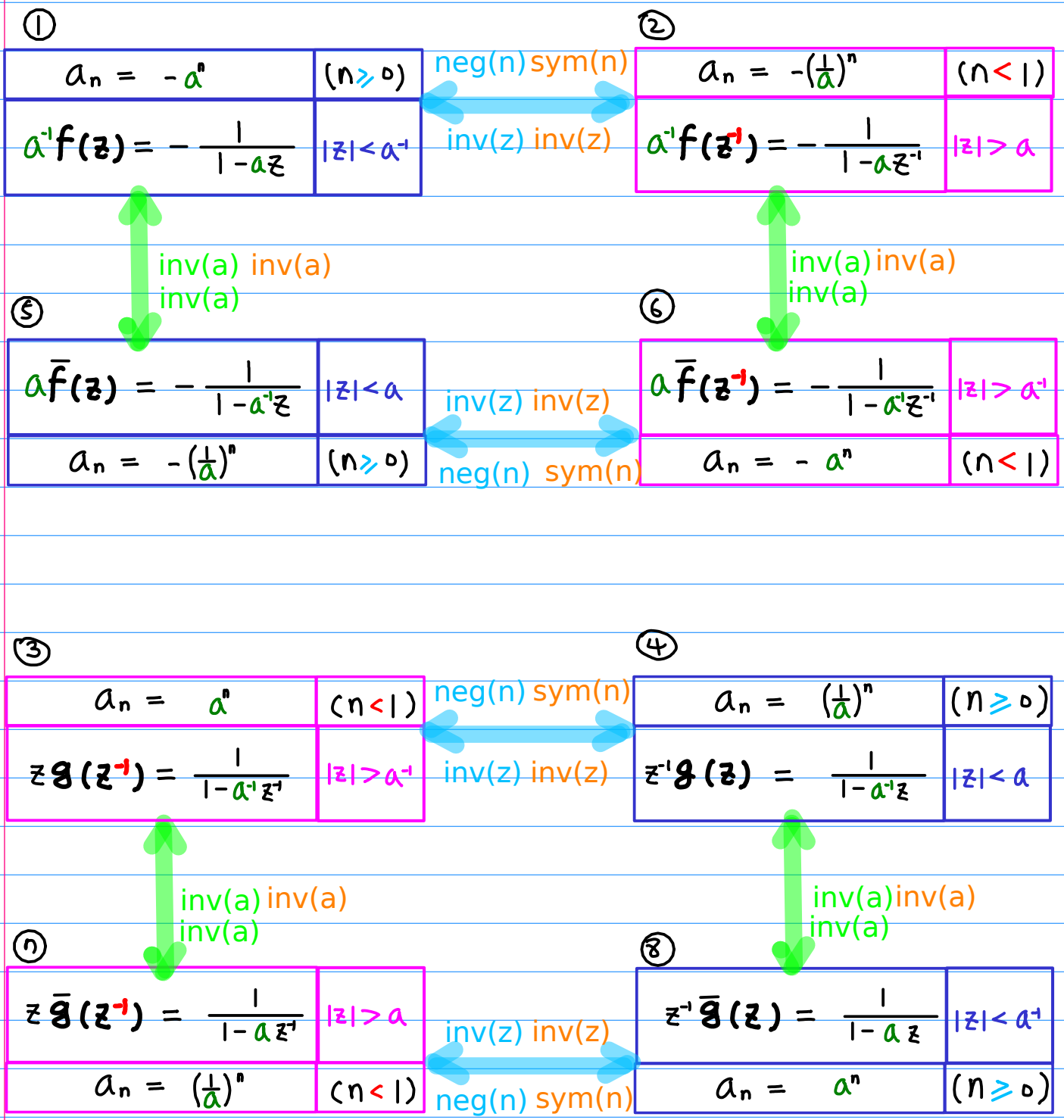

Simple Pole Forms

Geometric Series Forms

①	$a_n = -a^{n+1}$ ($n \geq 0$) $f(z) = -\frac{a}{1-az}$ ($ z < a^{-1}$)	$\cdot a^{-1}$ id $\cdot a^{-1}$ id	$a_n = -a^n$ ($n \geq 0$) $a^{-1}f(z) = -\frac{1}{1-az}$ ($ z < a^{-1}$)
②	$a_n = -(\frac{1}{a})^{n-1}$ ($n < 1$) $f(z^{-1}) = -\frac{a}{1-az^{-1}}$ ($ z > a$)	$\cdot a^{-1}$ id $\cdot a^{-1}$ id	$a_n = -(\frac{1}{a})^n$ ($n < 1$) $a^{-1}f(z^{-1}) = -\frac{1}{1-az^{-1}}$ ($ z > a$)
③	$g(z^{-1}) = \frac{z^{-1}}{1-a^{-1}z^{-1}}$ ($ z > a^{-1}$) $a_n = a^{n+1}$ ($n < 0$)	$\cdot z$ id $\cdot a^{-1}$ S(c(n))	$zg(z^{-1}) = \frac{1}{1-a^{-1}z^{-1}}$ ($ z > a^{-1}$) $a_n = a^n$ ($n < 1$)
④	$g(z) = \frac{z}{1-a^{-1}z}$ ($ z < a$) $a_n = (\frac{1}{a})^{n-1}$ ($n \geq 1$)	$\cdot z^{-1}$ id $\cdot a^{-1}$ S(c(n))	$z^{-1}g(z) = \frac{1}{1-a^{-1}z}$ ($ z < a$) $a_n = (\frac{1}{a})^n$ ($n \geq 0$)
⑤	$a_n = -(\frac{1}{a})^{n+1}$ ($n \geq 0$) $\bar{f}(z) = -\frac{a^{-1}}{1-a^{-1}z}$ ($ z < a$)	$\cdot a$ id $\cdot a$ id	$a_n = -(\frac{1}{a})^n$ ($n \geq 0$) $a\bar{f}(z) = -\frac{1}{1-a^{-1}z}$ ($ z < a$)
⑥	$a_n = -a^{n-1}$ ($n < 1$) $\bar{f}(z^{-1}) = -\frac{a^{-1}}{1-a^{-1}z^{-1}}$ ($ z > a^{-1}$)	$\cdot a$ id $\cdot a$ id	$a_n = -a^n$ ($n < 1$) $a\bar{f}(z^{-1}) = -\frac{1}{1-a^{-1}z^{-1}}$ ($ z > a^{-1}$)
⑦	$\bar{g}(z^{-1}) = \frac{z^{-1}}{1-az^{-1}}$ ($ z > a$) $a_n = (\frac{1}{a})^{n+1}$ ($n < 0$)	$\cdot z$ id $\cdot a$ S(c(n))	$z\bar{g}(z^{-1}) = \frac{1}{1-az^{-1}}$ ($ z > a$) $a_n = (\frac{1}{a})^n$ ($n < 1$)
⑧	$\bar{g}(z) = \frac{z}{1-az}$ ($ z < a^{-1}$) $a_n = a^{n-1}$ ($n \geq 1$)	$\cdot z^{-1}$ id $\cdot a$ S(c(n))	$z^{-1}\bar{g}(z) = \frac{1}{1-az}$ ($ z < a^{-1}$) $a_n = a^n$ ($n \geq 0$)

Simple Pole Forms

Geometric Series Forms

①

$a_n = -a^{n+1}$	$(n \geq 0)$
$f(z) = -\frac{a}{1-az}$	$ z < a^{-1}$

$$-a(a^0 z^0 + a^1 z^1 + a^2 z^2 + \dots)$$

$\cdot a$ id
 $\cdot a$ id

$a_n = -a^n$	$(n \geq 0)$
$a^{-1}f(z) = -\frac{1}{1-az}$	$ z < a^{-1}$

$$-(a^0 z^0 + a^1 z^1 + a^2 z^2 + \dots)$$

②

$a_n = -\left(\frac{1}{a}\right)^{n-1}$	$(n < 1)$
$f(z^{-1}) = -\frac{a}{1-az^{-1}}$	$ z > a$

$$-a(a^0 z^0 + a^1 z^{-1} + a^2 z^{-2} + \dots)$$

$$-a\left(\left(\frac{1}{a}\right)^0 z^0 + \left(\frac{1}{a}\right)^1 z^{-1} + \left(\frac{1}{a}\right)^2 z^{-2} + \dots\right)$$

$\cdot a$ id
 $\cdot a$ id

$a_n = -\left(\frac{1}{a}\right)^n$	$(n < 1)$
$a^{-1}f(z^{-1}) = -\frac{1}{1-az^{-1}}$	$ z > a$

$$-(a^0 z^0 + a^1 z^{-1} + a^2 z^{-2} + \dots)$$

$$-\left(\left(\frac{1}{a}\right)^0 z^0 + \left(\frac{1}{a}\right)^1 z^{-1} + \left(\frac{1}{a}\right)^2 z^{-2} + \dots\right)$$

③

$g(z^{-1}) = \frac{z^{-1}}{1-a^{-1}z^{-1}}$	$ z > a^{-1}$
$a_n = a^{n+1}$	$(n < 0)$

$$-z^{-1}(a^0 z^0 + a^1 z^{-1} + a^2 z^{-2} + \dots)$$

$$-(a^0 z^{-1} + a^1 z^{-2} + a^2 z^{-3} + \dots)$$

$\cdot z^{-1}$ id
 $\cdot a$ S(c(n))

$z g(z^{-1}) = \frac{1}{1-a^{-1}z^{-1}}$	$ z > a^{-1}$
$a_n = a^n$	$(n < 1)$

$$-(a^0 z^0 + a^1 z^{-1} + a^2 z^{-2} + \dots)$$

④

$g(z) = \frac{z}{1-a^{-1}z}$	$ z < a$
$a_n = \left(\frac{1}{a}\right)^{n-1}$	$(n \geq 1)$

$$-z(a^0 z^0 + a^1 z^1 + a^2 z^2 + \dots)$$

$$-\left(\left(\frac{1}{a}\right)^0 z^1 + \left(\frac{1}{a}\right)^1 z^2 + \left(\frac{1}{a}\right)^2 z^3 + \dots\right)$$

$\cdot z$ id
 $\cdot a$ S(c(n))

$z^{-1}g(z) = \frac{1}{1-a^{-1}z}$	$ z < a$
$a_n = \left(\frac{1}{a}\right)^n$	$(n \geq 0)$

$$-(a^0 z^0 + a^1 z^1 + a^2 z^2 + \dots)$$

$$-\left(\left(\frac{1}{a}\right)^0 z^0 + \left(\frac{1}{a}\right)^1 z^1 + \left(\frac{1}{a}\right)^2 z^2 + \dots\right)$$

Simple Pole Forms

Geometric Series Forms

⑤

$a_n = -\left(\frac{1}{a}\right)^{n+1}$	$(n \geq 0)$
$\bar{f}(z) = -\frac{a^1}{1-a^1 z}$	$ z < a$

$-\left(\frac{1}{a}\right)\left(\left(\frac{1}{a}\right)^0 z^0 + \left(\frac{1}{a}\right)^1 z^1 + \left(\frac{1}{a}\right)^2 z^2 + \dots\right)$
 $-\left(\left(\frac{1}{a}\right)^1 z^0 + \left(\frac{1}{a}\right)^2 z^1 + \left(\frac{1}{a}\right)^3 z^2 + \dots\right)$

$\cdot a^{-1}$ id
 $\cdot a^{-1}$ id

$a_n = -\left(\frac{1}{a}\right)^n$	$(n \geq 0)$
$a\bar{f}(z) = -\frac{1}{1-a^1 z}$	$ z < a$

$-\left(\left(\frac{1}{a}\right)^0 z^0 + \left(\frac{1}{a}\right)^1 z^1 + \left(\frac{1}{a}\right)^2 z^2 + \dots\right)$

⑥

$a_n = -a^{n-1}$	$(n < 1)$
$\bar{f}(z^{-1}) = -\frac{a^1}{1-a^1 z^{-1}}$	$ z > a^{-1}$

$-a^1(a^0 z^0 + a^1 z^{-1} + a^2 z^{-2} + \dots)$
 $-(a^1 z^0 + a^2 z^{-1} + a^3 z^{-2} + \dots)$

$\cdot a^{-1}$ id
 $\cdot a^{-1}$ id

$a_n = -a^n$	$(n < 1)$
$a\bar{f}(z^{-1}) = -\frac{1}{1-a^1 z^{-1}}$	$ z > a^{-1}$

$-(a^0 z^0 + a^1 z^{-1} + a^2 z^{-2} + \dots)$

⑦

$\bar{g}(z^{-1}) = \frac{z^{-1}}{1-a^1 z^{-1}}$	$ z > a$
$a_n = \left(\frac{1}{a}\right)^{n+1}$	$(n < 0)$

$z^{-1}\left(\left(\frac{1}{a}\right)^0 z^0 + \left(\frac{1}{a}\right)^1 z^{-1} + \left(\frac{1}{a}\right)^2 z^{-2} + \dots\right)$
 $\left(\left(\frac{1}{a}\right)^0 z^{-1} + \left(\frac{1}{a}\right)^1 z^{-2} + \left(\frac{1}{a}\right)^2 z^{-3} + \dots\right)$

$\cdot z^{-1}$ id
 $\cdot a^{-1}s(c(n))$

$z\bar{g}(z^{-1}) = \frac{1}{1-a^1 z^{-1}}$	$ z > a$
$a_n = \left(\frac{1}{a}\right)^n$	$(n < 1)$

$(a^0 z^0 + a^1 z^{-1} + a^2 z^{-2} + \dots)$
 $\left(\left(\frac{1}{a}\right)^0 z^0 + \left(\frac{1}{a}\right)^1 z^{-1} + \left(\frac{1}{a}\right)^2 z^{-2} + \dots\right)$

⑧

$\bar{g}(z) = \frac{z}{1-a^1 z}$	$ z < a^{-1}$
$a_n = a^{n-1}$	$(n \geq 1)$

$z(a^0 z^0 + a^1 z^{-1} + a^2 z^{-2} + \dots)$
 $(a^0 z^1 + a^1 z^2 + a^2 z^3 + \dots)$

$\cdot z$ id
 $\cdot a^{-1}s(c(n))$

$z^{-1}\bar{g}(z) = \frac{1}{1-a^1 z}$	$ z < a^{-1}$
$a_n = a^n$	$(n \geq 0)$

$(a^0 z^0 + a^1 z^{-1} + a^2 z^{-2} + \dots)$

①

$a_n = -a^{n+1}$	$(n \geq 0)$
$f(z) = -\frac{a}{1-az}$	$ z < a^{-1}$

②

$a_n = -\left(\frac{1}{a}\right)^{n-1}$	$(n < 1)$
$f(z^{-1}) = -\frac{a}{1-az^{-1}}$	$ z > a$

neg(n) sym(n)
inv(z) inv(z)

$a_n = -a^{n+1}$	$(n \geq 0)$
$f(z) = -\frac{a}{1-az}$	$ z < a^{-1}$

③

$g(z^{-1}) = \frac{z^{-1}}{1-a^{-1}z^{-1}}$	$ z > a^{-1}$
$a_n = a^{n+1}$	$(n < 0)$

neg(n) sym(n)
inv(z) inv(z)

$g(z) = \frac{z}{1-a^{-1}z}$	$ z < a$
$a_n = \left(\frac{1}{a}\right)^{n-1}$	$(n \geq 1)$

· z id
· a s(c(n))

$z^{-1}g(z) = \frac{1}{1-a^{-1}z}$	$ z < a$
$a_n = \left(\frac{1}{a}\right)^n$	$(n \geq 0)$

④

$g(z) = \frac{z}{1-a^{-1}z}$	$ z < a$
$a_n = \left(\frac{1}{a}\right)^{n-1}$	$(n \geq 1)$

· z id
· a s(c(n))

$z^{-1}g(z) = \frac{1}{1-a^{-1}z}$	$ z < a$
$a_n = \left(\frac{1}{a}\right)^n$	$(n \geq 0)$

$g(z^{-1}) = \frac{z^{-1}}{1 - a^{-1}z^{-1}}$	$ z > a^{-1}$
$a_n = a^{n+1}$	$(n < 0)$

$\cdot z^{-1}$ id
 $\cdot a$ $s(c(n))$

$z g(z^{-1}) = \frac{1}{1 - a^{-1}z^{-1}}$	$ z > a^{-1}$
$a_n = a^n$	$(n < 1)$

$$X(z) = \frac{1}{1 - a^{-1}z^{-1}} \quad |z| > a^{-1}$$

↓

$$a_n = a^n \quad (n < 1)$$

$\cdot z^{-1}$ ↓	$+ (a^0 z^0 + a^{-1} z^{-1} + a^{-2} z^{-2} + \dots)$ $a^0 \quad a^{-1} \quad a^{-2} \quad \dots$	$n = 0, -1, -2, \dots$ $\cdot a$ ↓ $n = -1, -2, -3, \dots$
	$+ (a^0 z^{-1} + a^{-1} z^{-2} + a^{-2} z^{-3} + \dots)$	

$$z^{-1} X(z) = \frac{z^{-1}}{1 - a^{-1}z^{-1}} \quad |z| > a^{-1}$$

↓

$$a_{n-1} = a^{n+1} \quad (n < 0)$$

$g(z) = \frac{z}{1-a^1z}$	$ z < a$
$a_n = \left(\frac{1}{a}\right)^{n-1}$	$(n \geq 1)$

$\cdot z$ id
 $\cdot a^{-1} s(c(n))$

$z^{-1}g(z) = \frac{1}{1-a^1z}$	$ z < a$
$a_n = \left(\frac{1}{a}\right)^n$	$(n \geq 0)$

$$X(z) = \frac{1}{1-a^1z} \quad |z| < a$$

$$a_n = \left(\frac{1}{a}\right)^n \quad (n \geq 0)$$

$\cdot z$	$- (a^0 z^0 + a^1 z^1 + a^2 z^2 + \dots)$	$n = 0, 1, 2, \dots$
	$a^0 \quad a^1 \quad a^2 \quad \dots$	$\cdot a^{-1}$
	$- (a^0 z^1 + a^1 z^2 + a^2 z^3 + \dots)$	$n = 1, 2, 3, \dots$

$$zX(z) = \frac{z}{1-a^1z} \quad |z| < a$$

$$a_{n-1} = \left(\frac{1}{a}\right)^{n-1} \quad (n \geq 1)$$

$\bar{g}(z^{-1}) = \frac{z^{-1}}{1 - az^{-1}}$	$ z > a$
$a_n = \left(\frac{1}{a}\right)^{n+1}$	$(n < 0)$

$\cdot z$ id
 $\cdot a^{-1}$ s(c(n))

$z \bar{g}(z^{-1}) = \frac{1}{1 - az^{-1}}$	$ z > a$
$a_n = \left(\frac{1}{a}\right)^n$	$(n < 1)$

$X(z) = \frac{1}{1 - az^{-1}} \quad |z| > a$
 \downarrow
 $a_n = \left(\frac{1}{a}\right)^n \quad (n < 1)$

$\cdot z$ \downarrow	$- (a^0 z^0 + a^1 z^{-1} + a^2 z^{-2} + \dots)$	$\cdot a^{-1}$ \downarrow	$n = 0, -1, -2, \dots$
	$a^0 \quad a^1 \quad a^2 \quad \dots$		
	$- (a^0 z^1 + a^1 z^2 + a^2 z^3 + \dots)$		$n = -1, -2, -3, \dots$

$z X(z) = \frac{z^{-1}}{1 - az^{-1}} \quad |z| > a$
 \downarrow
 $a_{n-1} = \left(\frac{1}{a}\right)^{n+1} \quad (n < 0)$

$\bar{g}(z) = \frac{z}{1-az}$	$ z < a^{-1}$
$a_n = a^{n-1}$	$(n \geq 1)$

$\cdot z^{-1}$ id

$\cdot a^{-1}$ s(c(n))

$z^{-1}\bar{g}(z) = \frac{1}{1-az}$	$ z < a^{-1}$
$a_n = a^n$	$(n \geq 0)$

$$X(z) = \frac{1}{1-az} \quad |z| < a^{-1}$$

$$a_n = a^n \quad (n \geq 0)$$

$\cdot z^{-1}$ ↓	$+ (a^0 z^0 + a^1 z^1 + a^2 z^2 + \dots)$	$\cdot a^{-1}$ ↓	$n = 0, 1, 2, \dots$
	$+ (a^0 z^1 + a^1 z^2 + a^2 z^3 + \dots)$		$n = 1, 2, 3, \dots$

$$z^{-1}X(z) = \frac{z}{1-az} \quad |z| < a^{-1}$$

$$a_{n-1} = a^{n-1} \quad (n \geq 1)$$

①

$a_n = -2^n$	$(n \geq 0)$
$0.5 f(z) = -\frac{1}{1-2z}$	$ z < 0.5$

neg(n) sym(n)

inv(z) inv(z)

②

$a_n = -(\frac{1}{2})^n$	$(n < 1)$
$0.5 f(z^{-1}) = -\frac{1}{1-2z^{-1}}$	$ z > 0.5$

sign, inv(a,z) comp(z)
sign comp(n)

sign, inv(a,z) comp(z)
sign comp(n)

③

$z g(z^{-1}) = \frac{1}{1-0.5z^{-1}}$	$ z > 0.5$
$a_n = 2^n$	$(n < 1)$

inv(z) inv(z)

neg(n) sym(n)

④

$z^{-1} g(z) = \frac{1}{1-0.5z}$	$ z < 2$
$a_n = (\frac{1}{2})^n$	$(n \geq 0)$

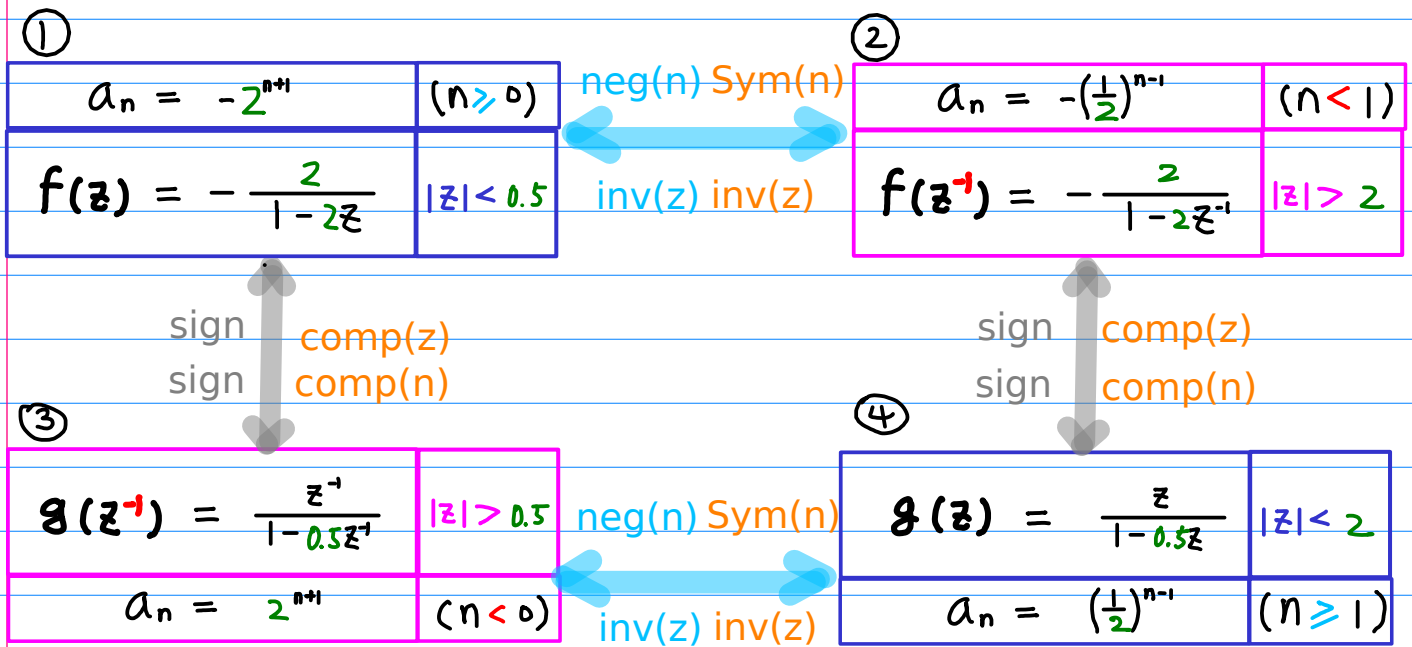

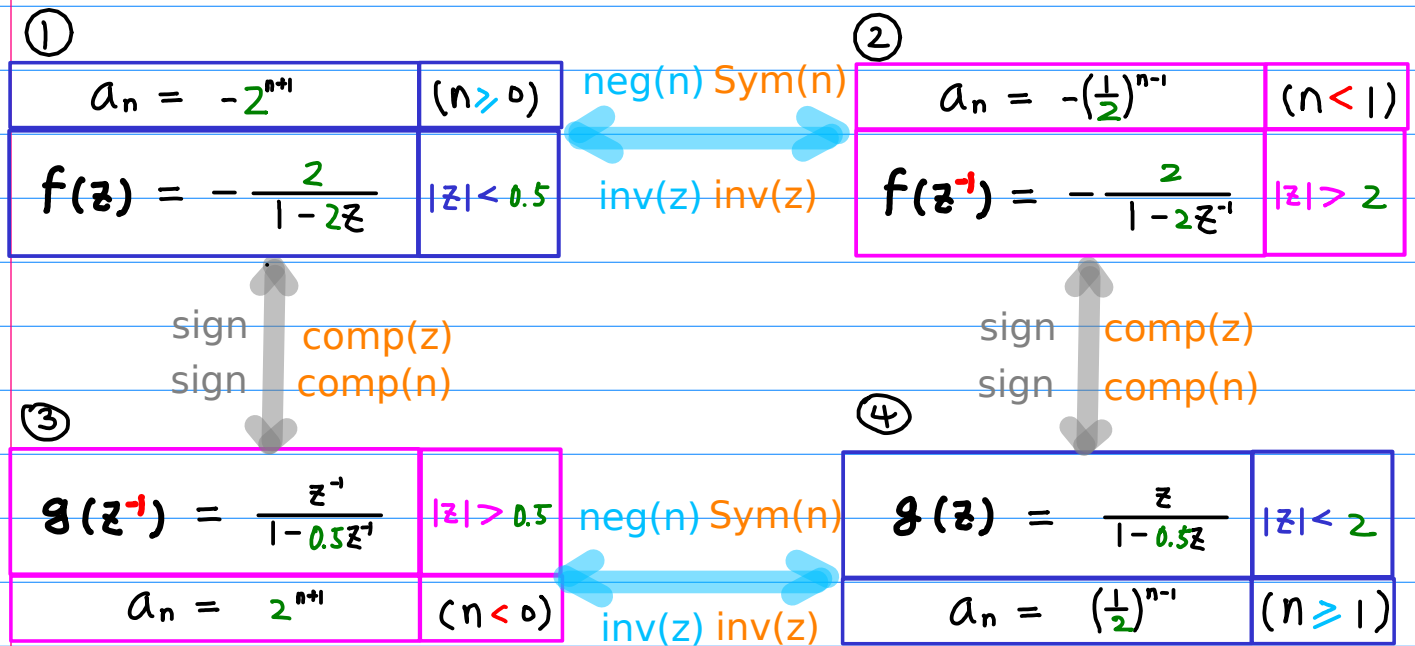

①

$a_n = -2^{n+1}$	$(n \geq 0)$
$f(z) = -\frac{z}{1-2z}$	$ z < 0.5$

②

$a_n = -(\frac{1}{2})^{n-1}$	$(n < 1)$
$f(z^{-1}) = -\frac{z}{1-2z^{-1}}$	$ z > 2$

neg(n) sym(n)

inv(z) inv(z)

$a_n = -2^{n+1}$	$(n \geq 0)$
$f(z) = -\frac{z}{1-2z}$	$ z < 0.5$

③

$g(z^{-1}) = \frac{z^{-1}}{1-0.5z^{-1}}$	$ z > 0.5$
$a_n = 2^{n+1}$	$(n < 0)$

neg(n) sym(n)

inv(z) inv(z)

$g(z) = \frac{z}{1-0.5z}$	$ z < 2$
$a_n = (\frac{1}{2})^{n-1}$	$(n \geq 1)$

· z id
· a s(c(n))

$z^{-1}g(z) = \frac{1}{1-0.5z}$	$ z < 2$
$a_n = (\frac{1}{2})^n$	$(n \geq 0)$

④

$g(z) = \frac{z}{1-2z}$	$ z < 2$
$a_n = (\frac{1}{2})^{n-1}$	$(n \geq 1)$

· z id
· a s(c(n))

$z^{-1}g(z) = \frac{1}{1-2z}$	$ z < 2$
$a_n = (\frac{1}{2})^n$	$(n \geq 0)$

$$\frac{3}{2} \frac{-1}{(z-0.5)(z-2)} = \left(\frac{1}{z-0.5} - \frac{1}{z-2} \right)$$

$$|z| < 0.5 \quad f(z) = -\frac{2}{1-2z} + \frac{0.5}{1-0.5z} \quad \boxed{-2^{n+1} + \left(\frac{1}{2}\right)^{n+1}} \quad (n \geq 0)$$

$$-\left(2z^0 + 2^2 z^1 + 2^3 z^2 + \dots\right) + \left(\left(\frac{1}{2}\right)z^0 + \left(\frac{1}{2}\right)^2 z^1 + \left(\frac{1}{2}\right)^3 z^2 + \dots\right)$$

$n=0 \quad n=1 \quad n=2 \qquad n=0 \quad n=1 \quad n=2$

$$|z| < 0.5 \quad X(z) = -\frac{2}{1-2z} + \frac{0.5}{1-0.5z} \quad \boxed{-\left(\frac{1}{2}\right)^{n-1} + 2^{n-1}} \quad (n \leq 0)$$

$$-\left(2^1 z^0 + 2^2 z^1 + 2^3 z^2 + \dots\right) + \left(\left(\frac{1}{2}\right)z^0 + \left(\frac{1}{2}\right)^2 z^1 + \left(\frac{1}{2}\right)^3 z^2 + \dots\right)$$

$$-\left(\left(\frac{1}{2}\right)^1 z^0 + \left(\frac{1}{2}\right)^2 z^1 + \left(\frac{1}{2}\right)^3 z^2 + \dots\right) + \left(2^{-1} z^0 + 2^{-2} z^1 + 2^{-3} z^2 + \dots\right)$$

$n=0 \quad n=-1 \quad n=-2 \qquad n=0 \quad n=-1 \quad n=-2$

	$f(z) = \sum_{n=0}^{\infty} a^{n+1} z^n$	a^{n+1}	$n \geq 0$	$n \geq 1$	$n < 0$	$n < 1$
		↓	↓	↓	↓	↓
	$\sum_{n=0}^{\infty} \left(\frac{1}{a}\right)^{n-1} z^n$	$-n$				
		↓	↓	↓	↓	↓
ROC	$X(z) = \sum_{k=-\infty}^{\infty} \left(\frac{1}{a}\right)^{k-1} z^{-k}$	a^{-n+1}	$n < 0$	$n < 1$	$n \geq 0$	$n \geq 1$
		$= \left(\frac{1}{a}\right)^{n-1}$				

ROC	$f(z) = \sum_{n=0}^{\infty} a^{n+1} z^n$	a^{n+1}	$n \geq 0$	$n \geq 1$	$n < 0$	$n < 1$
	\uparrow	\downarrow	\downarrow	\downarrow	\downarrow	\downarrow
z^{-1}	\uparrow	z^{-1}				
	\uparrow	\downarrow				
	$\sum_{n=0}^{\infty} \left(\frac{1}{a}\right)^{n+1} z^n$	$-n$				
ROC	$X(z) = \sum_{k=0}^{\infty} (a)^{k+1} z^{-k}$	$\left(\frac{1}{a}\right)^{-n+1}$	$n < 0$	$n < 1$	$n \geq 0$	$n \geq 1$
		$= a^{n-1}$				

$$\textcircled{1} \quad -\frac{2}{|-2z|} + \frac{0.5}{|-0.5z|} \quad |z| < 0.5$$

$$\textcircled{2} \quad +\frac{z^{-1}}{|-0.5z^{-1}|} - \frac{z^{-1}}{|-2z^{-1}|} \quad |z| > 2$$

$$\textcircled{3} \quad -\frac{2}{|-2z^{-1}|} + \frac{0.5}{|-0.5z^{-1}|} \quad |z| > 2$$

$$\textcircled{4} \quad +\frac{z}{|-0.5z|} - \frac{z}{|-2z|} \quad |z| < 0.5$$

$$-2^{n+1} + \left(\frac{1}{2}\right)^{n+1} \quad (n \geq 0)$$

$$-\frac{2}{|-2z|} + \frac{0.5}{|-0.5z|} \quad |z| < 0.5$$

$$-\left(\frac{1}{2}\right)^{n-1} + 2^{n-1} \quad (n < 1)$$

$$-\frac{2}{|-2z^{-1}|} + \frac{0.5}{|-0.5z^{-1}|} \quad |z| > 2$$

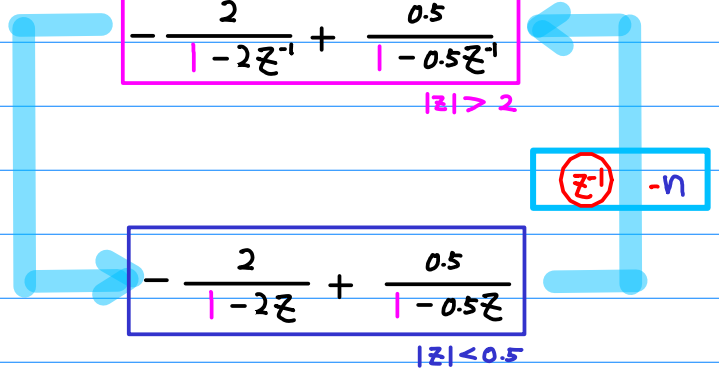

$$+2^{n+1} - \left(\frac{1}{2}\right)^{n+1} \quad (n < 0)$$

$$+\frac{z^{-1}}{|-0.5z^{-1}|} - \frac{z^{-1}}{|-2z^{-1}|} \quad |z| > 2$$

$$+\left(\frac{1}{2}\right)^{n-1} - 2^{n-1} \quad (n \geq 1)$$

$$+\frac{z}{|-0.5z|} - \frac{z}{|-2z|} \quad |z| < 0.5$$

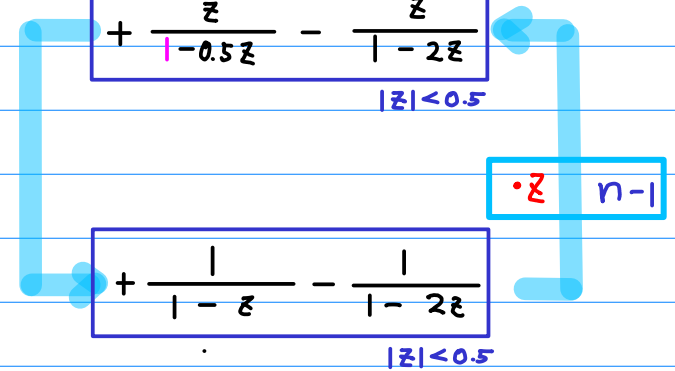
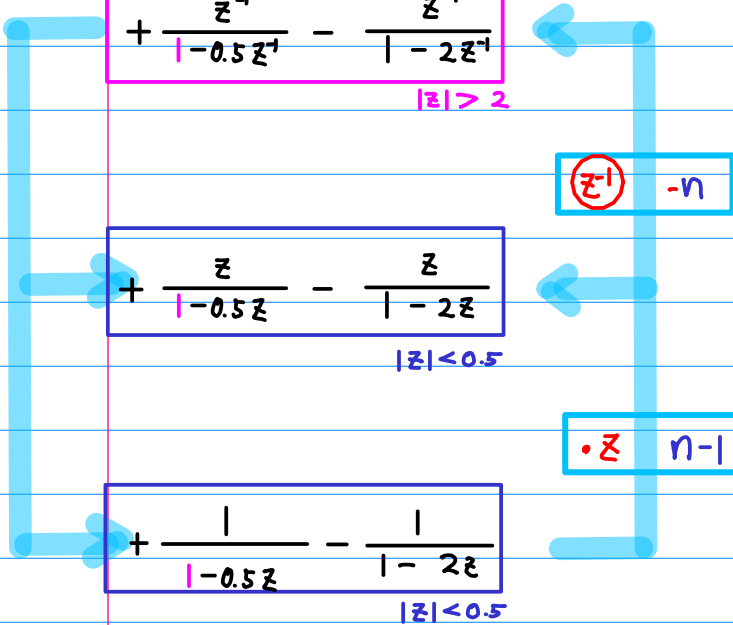

$z^{-1} X(z)$ Shifted Sequence

$$X(z) = \frac{1}{1-z^{-1}} - \frac{1}{1-2z^{-1}} \quad (|z| > 2)$$

$$a_n = 1^n + 2^n \quad (n \geq 0)$$

$$\begin{array}{l} \bullet z^{-1} \downarrow \\ \left(\begin{array}{cccc} 1^0 z^0 & 1^1 z^{-1} & 1^2 z^{-2} & \dots \end{array} \right) + \left(\begin{array}{cccc} 2^0 z^0 & 2^1 z^{-1} & 2^2 z^{-2} & \dots \end{array} \right) \quad \textcircled{n} \quad n = 0, 1, 2, \dots \\ \left(\begin{array}{cccc} 1^0 & 1^1 & 1^2 & \dots \end{array} \right) + \left(\begin{array}{cccc} 2^0 & 2^1 & 2^2 & \dots \end{array} \right) \\ \left(\begin{array}{cccc} 1^0 z^{-1} & 1^1 z^{-2} & 1^2 z^{-3} & \dots \end{array} \right) + \left(\begin{array}{cccc} 2^0 z^{-1} & 2^1 z^{-2} & 2^2 z^{-3} & \dots \end{array} \right) \quad \textcircled{n-1} \quad n = 1, 2, 3, \dots \end{array}$$

$$z^{-1} X(z) = \frac{z^{-1}}{1-z^{-1}} - \frac{z^{-1}}{1-2z^{-1}} \quad (|z| > 2)$$

$$a_{n-1} = 1^{n-1} + 2^{n-1} \quad (n \geq 1)$$

$z f(z)$ Shifted Sequence

$$f(z) = (+1) \frac{1}{1-z} - \frac{1}{1-2z} \quad (|z| < 0.5)$$

$$a_n = \downarrow \frac{1}{1^n} - \downarrow \frac{1}{2^n} \quad (n \geq 0)$$

$\bullet z \downarrow$

$$\left(\begin{array}{cccc} 1^0 z^0 & 1^1 z^1 & 1^2 z^2 & \dots \end{array} \right) - \left(\begin{array}{cccc} 2^0 z^0 & 2^1 z^1 & 2^2 z^2 & \dots \end{array} \right) \quad \textcircled{n} \quad n = 0, 1, 2, \dots$$

$$\left(\begin{array}{cccc} 1^0 z^1 & 1^1 z^2 & 1^2 z^3 & \dots \end{array} \right) - \left(\begin{array}{cccc} 2^0 z^1 & 2^1 z^2 & 2^2 z^3 & \dots \end{array} \right) \quad \textcircled{n-1} \quad n = 1, 2, 3, \dots$$

$$z f(z) = (+1) \frac{z}{1-z} - \frac{z}{1-2z} \quad (|z| < 0.5)$$

$$a_{n-1} = \downarrow \frac{1}{1^{n-1}} - \downarrow \frac{1}{2^{n-1}} \quad (n \geq 1)$$

$z^{-1} f(z^{-1})$ Shifted & Reflected Sequence

$$f(z) = \frac{1}{1-z} - \frac{1}{1-2z} \quad (|z| < 0.5)$$

$$a_n = 1^n - 2^n \quad (n \geq 0)$$

$\bullet z$	↓	$(1^0 z^0 + 1^1 z^1 + 1^2 z^2 + \dots) - (2^0 z^0 + 2^1 z^1 + 2^2 z^2 + \dots)$	\textcircled{n} ↓	$n = 0, 1, 2, \dots$
		$1^0 \quad 1^1 \quad 1^2 \quad \dots \quad 2^0 \quad 2^1 \quad 2^2 \quad \dots$		
		$(1^0 z^1 + 1^1 z^2 + 1^2 z^3 + \dots) - (2^0 z^1 + 2^1 z^2 + 2^2 z^3 + \dots)$	$\textcircled{n-1}$ ↓	$n = 1, 2, 3, \dots$

$$z f(z) = \frac{z}{1-z} - \frac{z}{1-2z} \quad (|z| < 0.5)$$

$$a_{n-1} = 1^{n-1} - 2^{n-1} \quad (n \geq 1)$$

\textcircled{z}	↓	$(1^0 z^1 + 1^1 z^2 + 1^2 z^3 + \dots) + (2^0 z^1 + 2^1 z^2 + 2^2 z^3 + \dots)$	\textcircled{n} ↓	$n = 1, 2, 3, \dots$
		$1^0 \quad 1^1 \quad 1^2 \quad \dots \quad 2^0 \quad 2^1 \quad 2^2 \quad \dots$		
$\textcircled{z^{-1}}$	↓	$(1^0 z^1 + 1^1 z^2 + 1^2 z^3 + \dots) + (2^0 z^1 + 2^1 z^2 + 2^2 z^3 + \dots)$	$\textcircled{-n}$ ↓	$n = -1, -2, -3, \dots$

$$z^{-1} f(z^{-1}) = \frac{z^{-1}}{1-z^{-1}} - \frac{z^{-1}}{1-2z^{-1}} \quad (|z| > 2)$$

$$a_{-n-1} = 1^{n+1} - \left(\frac{1}{2}\right)^{n+1} \quad (n < 0)$$

$$a_{-(n+1)}$$

$$\frac{3}{2} \frac{-1}{(z-0.5)(z-2)} = \left(\frac{1}{z-0.5} - \frac{1}{z-2} \right)$$

$$|z| < 0.5 \quad X(z)$$

$$a_n = -\left(\frac{1}{2}\right)^{n-1} + 2^{n-1} \quad (n < 0)$$

$$|z| > 2 \quad X(z)$$

$$b_n = \left(\frac{1}{2}\right)^{n-1} - 2^{n-1} \quad (n > 0)$$

$$\{|z| < 0.5\} \cap \{|z| > 2\} = \emptyset \quad \longrightarrow \quad a_n + b_n = 0$$

$$a_n = -b_n$$

$$|z| < a \quad X(z) = \sum_{n=0}^{\infty} a^{n+1} z^n$$

||

$$\sum_{n=0}^{\infty} \left(\frac{1}{a}\right)^{n-1} z^n$$

$$a^{n+1}$$



-n

$$n \geq 0 \quad n \geq 1 \quad n < 0 \quad n <$$



$$|z| > a \quad X(z) = \sum_{k=0}^{\infty} \left(\frac{1}{a}\right)^{k-1} z^{-k}$$

$$a^{-n+1} = \left(\frac{1}{a}\right)^{n-1}$$

$$n < 0 \quad n < 1 \quad n \geq 0 \quad n >$$

$$a^{n+1} z^n$$

$$a (az)^n$$

$$a \left(\frac{1}{az}\right)^{-n}$$

$$\frac{a}{1-az}$$

$$\sum_{n=0}^{\infty} a^{n+1} z^n$$

$$\frac{z}{1-az}$$

$$\sum_{n=1}^{\infty} a^{n-1} z^n$$

$$-\frac{z^{-1}}{1-a^{-1}z^{-1}}$$

$$-\sum_{n=0}^{\infty} a^{-n} z^{-n-1}$$

$$-\sum_{n=-1}^{\infty} a^{n+1} z^n$$

$$-\frac{a^{-1}}{1-a^{-1}z^{-1}}$$

$$-\sum_{n=1}^{\infty} a^{n-1} z^{-n}$$

$$-\sum_{n=0}^{\infty} a^{n-1} z^{-n}$$

z $X(z)$ Shifted & Reflected Sequence

$$X(z) = \frac{1}{1-z^{-1}} - \frac{1}{1-2z^{-1}} \quad (|z| > 2)$$

$$a_n = 1^n - 2^n \quad (n \geq 0)$$

$\bullet z^{-1}$

\downarrow	$(1^0 z^0 + 1^1 z^{-1} + 1^2 z^{-2} + \dots)$	$+$	$(2^0 z^0 + 2^1 z^{-1} + 2^2 z^{-2} + \dots)$	$\circledast n$	\downarrow	$n = 0, 1, 2, \dots$
\downarrow	$1^0 \quad 1^1 \quad 1^2 \quad \dots$	\downarrow	$2^0 \quad 2^1 \quad 2^2 \quad \dots$	\downarrow	\downarrow	\downarrow
\downarrow	$(1^0 z^{-1} + 1^1 z^{-2} + 1^2 z^{-3} + \dots)$	$+$	$(2^0 z^{-1} + 2^1 z^{-2} + 2^2 z^{-3} + \dots)$	$\circledast n-1$	\downarrow	$n = 1, 2, 3, \dots$

$$z^{-1} X(z) = \frac{z^{-1}}{1-z^{-1}} - \frac{z^{-1}}{1-2z^{-1}} \quad (|z| > 2)$$

$$a_{n-1} = 1^{n-1} - 2^{n-1} \quad (n \geq 1)$$

\downarrow	$(1^0 z^{-1} + 1^1 z^{-2} + 1^2 z^{-3} + \dots)$	$+$	$(2^0 z^{-1} + 2^1 z^{-2} + 2^2 z^{-3} + \dots)$	$\circledast n$	\downarrow	$n = 1, 2, 3, \dots$
\downarrow	$1^0 \quad 1^1 \quad 1^2 \quad \dots$	\downarrow	$2^0 \quad 2^1 \quad 2^2 \quad \dots$	\downarrow	\downarrow	\downarrow
\downarrow	$(1^0 z^1 + 1^1 z^2 + 1^2 z^3 + \dots)$	$+$	$(2^0 z^1 + 2^1 z^2 + 2^2 z^3 + \dots)$	$\circledast -n$	\downarrow	$n = 1, 2, 3, \dots$

$$z X(z^{-1}) = \frac{z}{1-z} - \frac{z}{1-2z} \quad (|z| < 0.5)$$

$$a_{-n-1} = 1^{n+1} - \left(\frac{1}{2}\right)^{n+1} \quad (n < 0)$$

$$a_{-(n+1)}$$

$$\frac{3}{2} \frac{-1}{(z-0.5)(z-2)} = \left(\frac{1}{z-0.5} - \frac{1}{z-2} \right)$$

$$|z| < 0.5 \quad f(z) = -\frac{2}{1-2z} + \frac{0.5}{1-0.5z} \quad \boxed{-2^{n+1} + \left(\frac{1}{2}\right)^{n+1}} \quad (n \geq 0)$$

$$-\left(2z^0 + 2^2 z^1 + 2^3 z^2 + \dots\right) + \left(\left(\frac{1}{2}\right)z^0 + \left(\frac{1}{2}\right)^2 z^1 + \left(\frac{1}{2}\right)^3 z^2 + \dots\right)$$

$n=0 \quad n=1 \quad n=2$
 $n=0 \quad n=1 \quad n=2$







$$|z| < 0.5 \quad X(z) = -\frac{2}{1-2z} + \frac{0.5}{1-0.5z} \quad \boxed{-\left(\frac{1}{2}\right)^{n-1} + 2^{n-1}} \quad (n \leq 0)$$

$$-\left(2^1 z^0 + 2^2 z^1 + 2^3 z^2 + \dots\right) + \left(\left(\frac{1}{2}\right)z^0 + \left(\frac{1}{2}\right)^2 z^1 + \left(\frac{1}{2}\right)^3 z^2 + \dots\right)$$

$$-\left(\left(\frac{1}{2}\right)^1 z^0 + \left(\frac{1}{2}\right)^2 z^1 + \left(\frac{1}{2}\right)^3 z^2 + \dots\right) + \left(2^{-1} z^0 + 2^{-2} z^1 + 2^{-3} z^2 + \dots\right)$$

$n=0 \quad n=-1 \quad n=-2$
 $n=0 \quad n=-1 \quad n=-2$

ROC	$f(z) = \sum_{n=0}^{\infty} a^{n+1} z^n$	a^{n+1}	$n \geq 0$	$n \geq 1$	$n < 0$	$n < 1$
	$\sum_{n=0}^{\infty} \left(\frac{1}{a}\right)^{n-1} z^n$	↓ -n	↓	↓	↓	↓
ROC	$X(z) = \sum_{k=0}^{\infty} \left(\frac{1}{a}\right)^{k-1} z^{-k}$	a^{-n+1}	$n < 0$	$n < 1$	$n \geq 0$	$n \geq 1$
		$= \left(\frac{1}{a}\right)^{n-1}$				

ROC	$f(z) = \sum_{n=0}^{\infty} a^{n+1} z^n$	a^{n+1}	$n \geq 0$	$n \geq 1$	$n < 0$	$n < 1$
						
	$\sum_{n=0}^{\infty} \left(\frac{1}{a}\right)^{n+1} z^n$	$\left(\frac{1}{a}\right)^{-n+1}$				
ROC	$X(z) = \sum_{k=0}^{\infty} (a)^{k+1} z^{-k}$	$= a^{n+1}$	$n < 0$	$n < 1$	$n \geq 0$	$n \geq 1$

$$2z$$

$$2z^{-1}$$

$$2^{-1}z^{-1}$$

$$2^{-1}z$$

$$|z| < 0.5$$

$$|z| > 2$$

$$|z| > 0.5$$

$$|z| < 2$$

$$- \frac{2}{-2z}$$



$$- \frac{2}{-2z^{-1}}$$

$$\cdot \frac{(2z)^{-1}}{(2z)^{-1}} \cdot \frac{(2z)}{(2z)}$$

$$\cdot \frac{(2z^{-1})^{-1}}{(2z^{-1})^{-1}} \cdot \frac{(2z^{-1})}{(2z^{-1})}$$

$$+ \frac{z^{-1}}{-0.5z^{-1}}$$



$$+ \frac{z}{-0.5z}$$







z-Transform ($n \rightarrow -n$)

(5)
$$-\frac{a^{-1}z^{-1}}{1-a^{-1}z^{-1}} \quad |z| > a^{-1}$$

$$- (a^{-1}z^{-1} + a^{-2}z^{-2} + a^{-3}z^{-3} + \dots)$$

$$- ((\frac{1}{a})^1 z^{-1} + (\frac{1}{a})^2 z^{-2} + (\frac{1}{a})^3 z^{-3} + \dots)$$

$- a^{-n} u(-(-n)-1)$	$(-n < 0)$
$- (\frac{1}{a})^n u(n-1)$	$(n \geq 1)$

(6)
$$-\frac{az^{-1}}{1-az^{-1}} \quad |z| > a$$

$$- (a^1 z^{-1} + a^2 z^{-2} + a^3 z^{-3} + \dots)$$

$$- ((\frac{1}{a})^1 z^{-1} + (\frac{1}{a})^2 z^{-2} + (\frac{1}{a})^3 z^{-3} + \dots)$$

$- (\frac{1}{a})^{-n} u(-(-n)-1)$	$(-n < 0)$
$- a^n u(n-1)$	$(n \geq 1)$

(7)
$$+\frac{az}{1-az} \quad |z| < a^{-1}$$

$$(a^1 z^1 + a^2 z^2 + a^3 z^3 + \dots)$$

$$((\frac{1}{a})^1 z^1 + (\frac{1}{a})^2 z^2 + (\frac{1}{a})^3 z^3 + \dots)$$

$a^n u((-n)-1)$	$(-n \geq 1)$
$(\frac{1}{a})^n u(-n-1)$	$(n < 0)$

(8)
$$+\frac{a^{-1}z}{1-a^{-1}z} \quad |z| < a$$

$$(a^{-1} z^1 + a^{-2} z^2 + a^{-3} z^3 + \dots)$$

$$((\frac{1}{a})^1 z^1 + (\frac{1}{a})^2 z^2 + (\frac{1}{a})^3 z^3 + \dots)$$

$(\frac{1}{a})^{-n} u((-n)-1)$	$(-n \geq 1)$
$a^n u(-n-1)$	$(n < 0)$

Laurent Series vs. z-Transform ($n \rightarrow -n$)

(5) $\frac{a^{-1}z^{-1}}{1-a^{-1}z^{-1}} \quad |z| > a^{-1}$ (6) $\frac{az^{-1}}{1-az^{-1}} \quad |z| > a$

$-(a^{-1}z^{-1} + a^{-2}z^{-2} + a^{-3}z^{-3} + \dots)$

$-(\frac{1}{a})z^{-1} + (\frac{1}{a})^2z^{-2} + (\frac{1}{a})^3z^{-3} + \dots$

$-(a^{-1}z^{-1} + a^{-2}z^{-2} + a^{-3}z^{-3} + \dots)$

$-(\frac{1}{a})z^{-1} + (\frac{1}{a})^2z^{-2} + (\frac{1}{a})^3z^{-3} + \dots$

Laurent

$-a^n \quad u(-n-1) \quad (n < 0)$

$-(\frac{1}{a})^n \quad u(-n-1) \quad (n < 0)$

z-Trans

$-(\frac{1}{a})^n \quad u(n-1) \quad (n \geq 1)$

$-a^n \quad u(n-1) \quad (n \geq 1)$

(7) $\frac{az}{1-az} \quad |z| < a^{-1}$ (8) $\frac{a^{-1}z}{1-a^{-1}z} \quad |z| < a$

$(a^{-1}z^{-1} + a^{-2}z^{-2} + a^{-3}z^{-3} + \dots)$

$(\frac{1}{a})z^{-1} + (\frac{1}{a})^2z^{-2} + (\frac{1}{a})^3z^{-3} + \dots$

$(a^{-1}z^{-1} + a^{-2}z^{-2} + a^{-3}z^{-3} + \dots)$

$(\frac{1}{a})z^{-1} + (\frac{1}{a})^2z^{-2} + (\frac{1}{a})^3z^{-3} + \dots$

Laurent

$a^n \quad u(n-1) \quad (n \geq 1)$

$(\frac{1}{a})^n \quad u(n-1) \quad (n \geq 1)$

z-Trans

$(\frac{1}{a})^n \quad u(-n-1) \quad (n < 0)$

$a^n \quad u(-n-1) \quad (n < 0)$