

# Applications of Array Pointers (1A)

---

Copyright (c) 2010 - 2020 Young W. Lim.

Permission is granted to copy, distribute and/or modify this document under the terms of the GNU Free Documentation License, Version 1.2 or any later version published by the Free Software Foundation; with no Invariant Sections, no Front-Cover Texts, and no Back-Cover Texts. A copy of the license is included in the section entitled "GNU Free Documentation License".

Please send corrections (or suggestions) to [youngwlim@hotmail.com](mailto:youngwlim@hotmail.com).  
This document was produced by using LibreOffice.

---

# Virtual Array Pointers in Multi-dimensional Arrays

# 3-d array structure

- Hierarchical
- Nested Structure
- Virtual Array Pointers over
  - Contiguous
  - Linear Layout

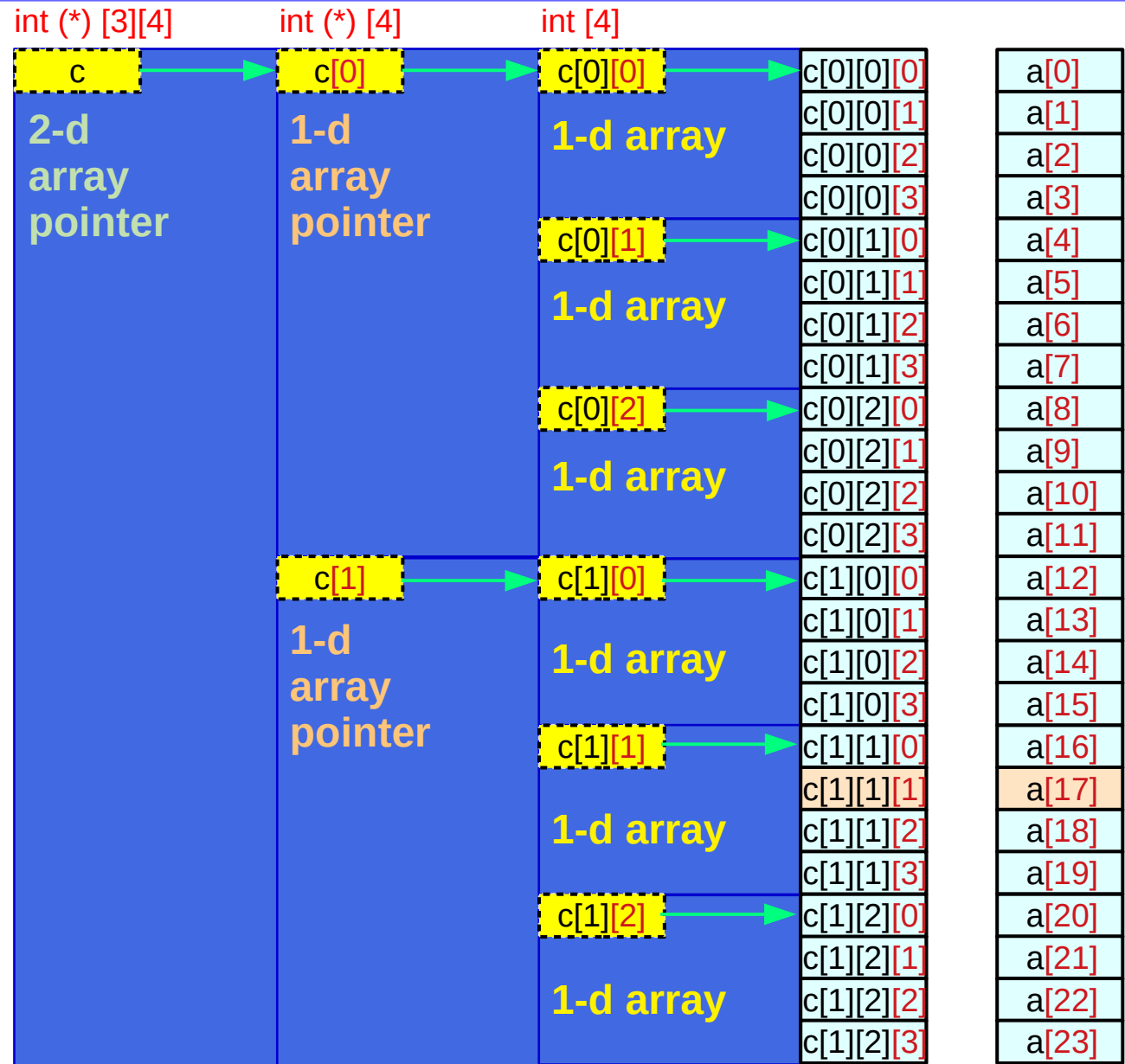

# Array **p** and virtual array pointer **p**

## Abstract data (array) **p**

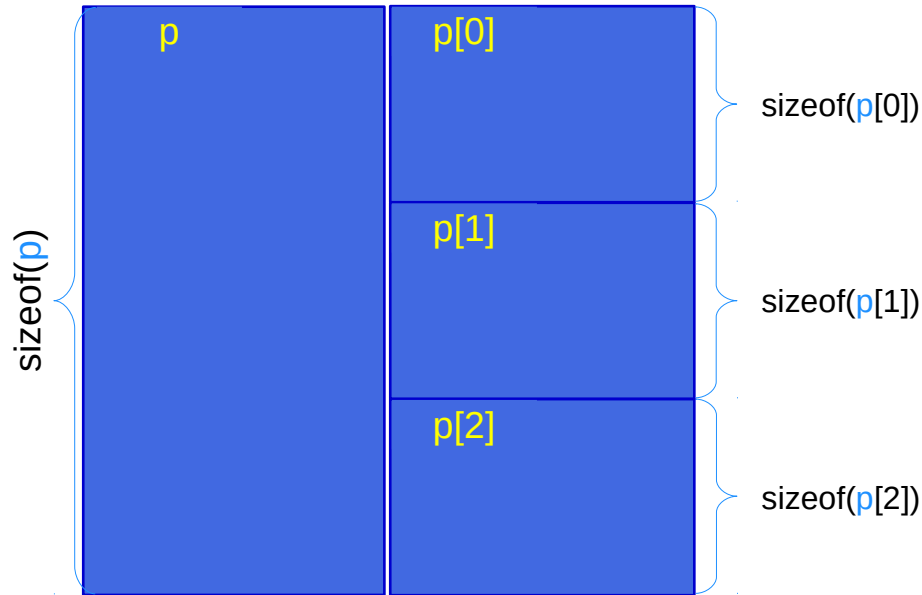

## Virtual array pointer **p**

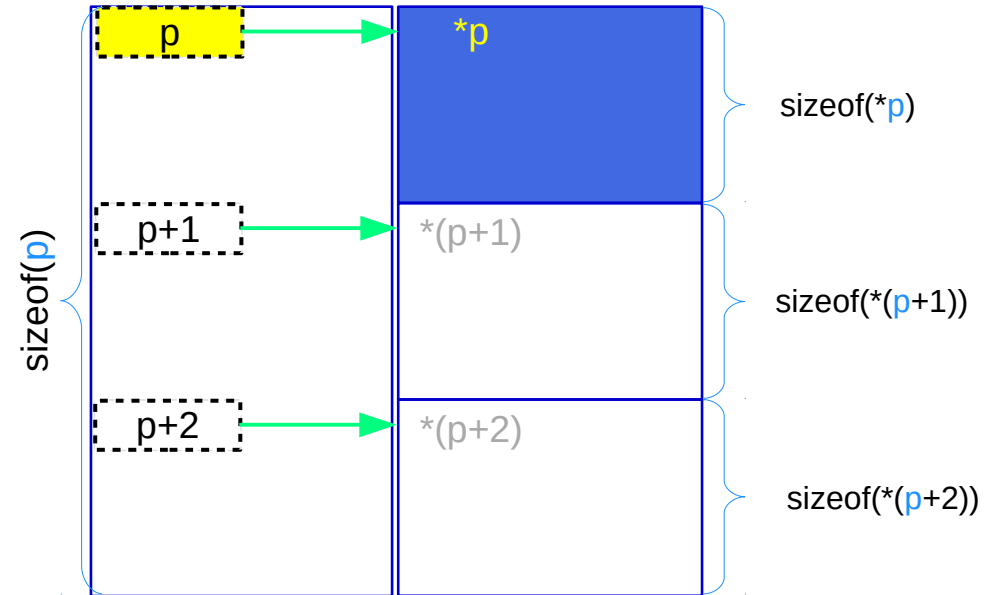

**p** is the name of an array and has a array pointer type but has a size of the array

**p** is a virtual array pointer

# Virtual array pointer to abstract data

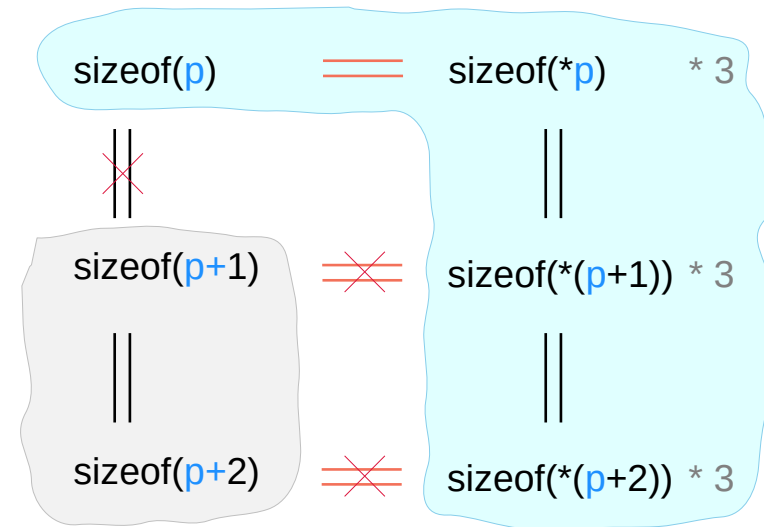
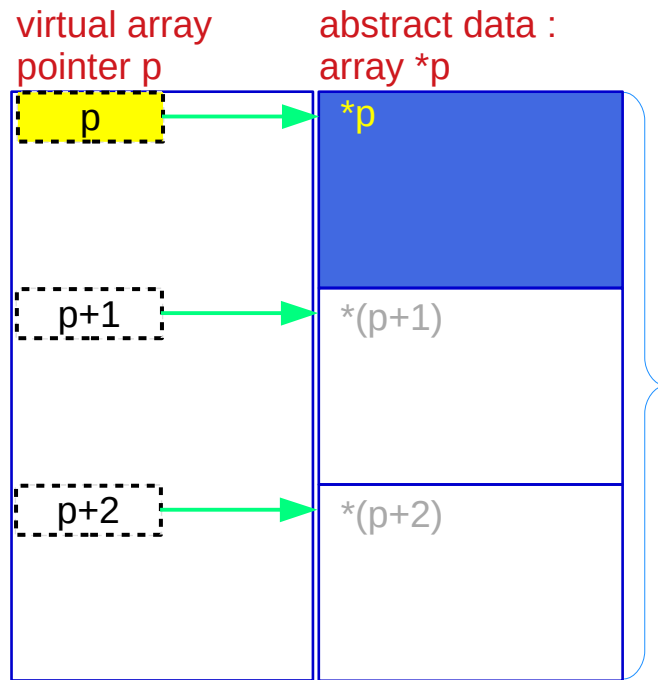

# Array **a** and pointer **a**

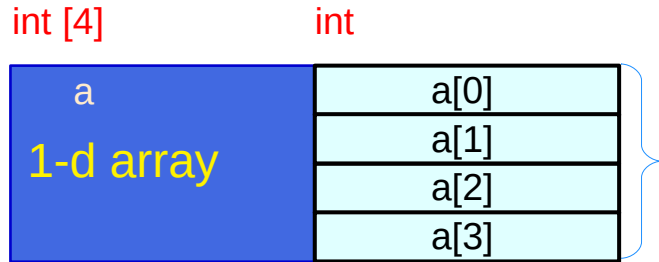

**1-d array **a**** specific array type

$\text{sizeof}(a)$

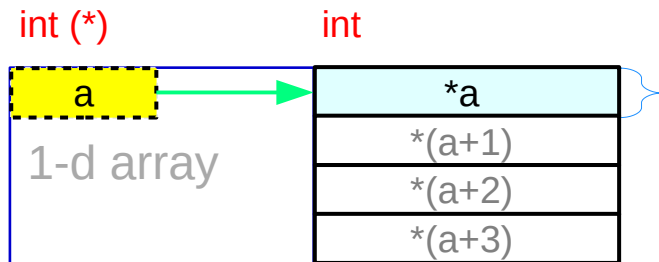

**pointer **a**** general pointer type

$\text{sizeof}(a) = \text{sizeof}(*a) * 4$

**a** is the name of a 1-d array and has a pointer type but has a size of the array

**a** is a virtual array pointer

# Array **b** and pointer **b**

**2-d array **b**** specific array type

`sizeof(b)`

`int [3] [4]`

`int [4]`



**1-d array pointer **b**** general pointer type

`sizeof(b) = sizeof(*b) * 3`

`int (*) [4]`

`int [4]`

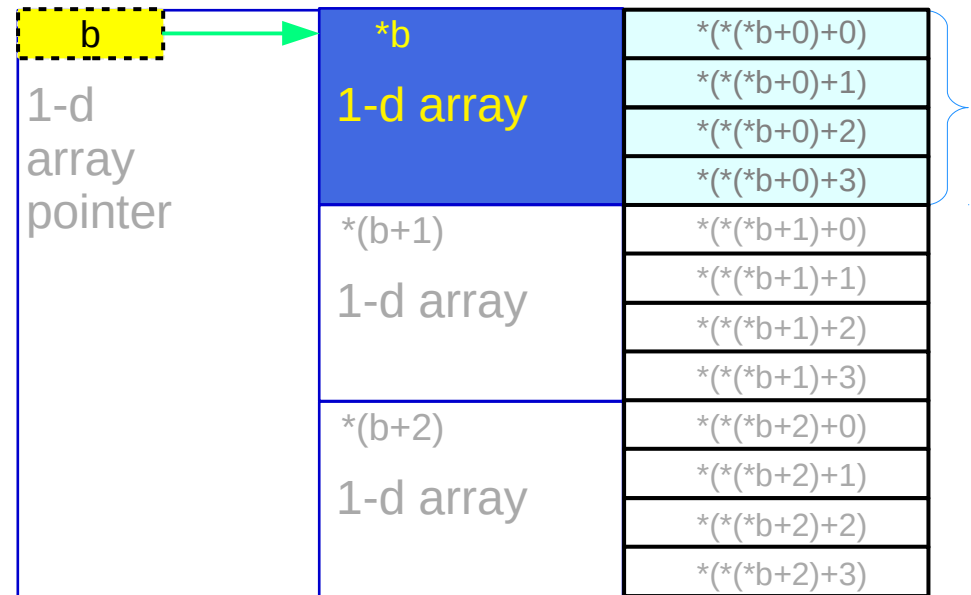

**b** is the name of a 2-d array and has a 1-d array pointer type but has a size of the array

**b** is a virtual array pointer



# Array c

## 3-d array c

specific array type

sizeof(c)

c is the name of a 3-d array and has a 2-d array pointer type but has a size of the array

c is a virtual array pointer

int [2][3][4]	int [3][4]	int [4]	
c 3-d array	c[0] 2-d array	c[0][0] 1-d array	c[0][0][0]
			c[0][0][1]
			c[0][0][2]
			c[0][0][3]
		c[0][1] 1-d array	c[0][1][0]
			c[0][1][1]
		c[0][1][2]	
		c[0][1][3]	
		c[0][2] 1-d array	c[0][2][0]
			c[0][2][1]
			c[0][2][2]
			c[0][2][3]
	c[1] 2-d array	c[1][0] 1-d array	c[1][0][0]
			c[1][0][1]
			c[1][0][2]
			c[1][0][3]
		c[1][1] 1-d array	c[1][1][0]
			c[1][1][1]
		c[1][1][2]	
		c[1][1][3]	
		c[1][2] 1-d array	c[1][2][0]
			c[1][2][1]
			c[1][2][2]
			c[1][2][3]

# Pointer c

## 2-d array pointer c

general pointer type

$\text{sizeof}(c) = \text{sizeof}(*c) * 2$

**c** is the name of a 3-d array and has a 2-d array pointer type but has a size of the array

**c** is a virtual array pointer

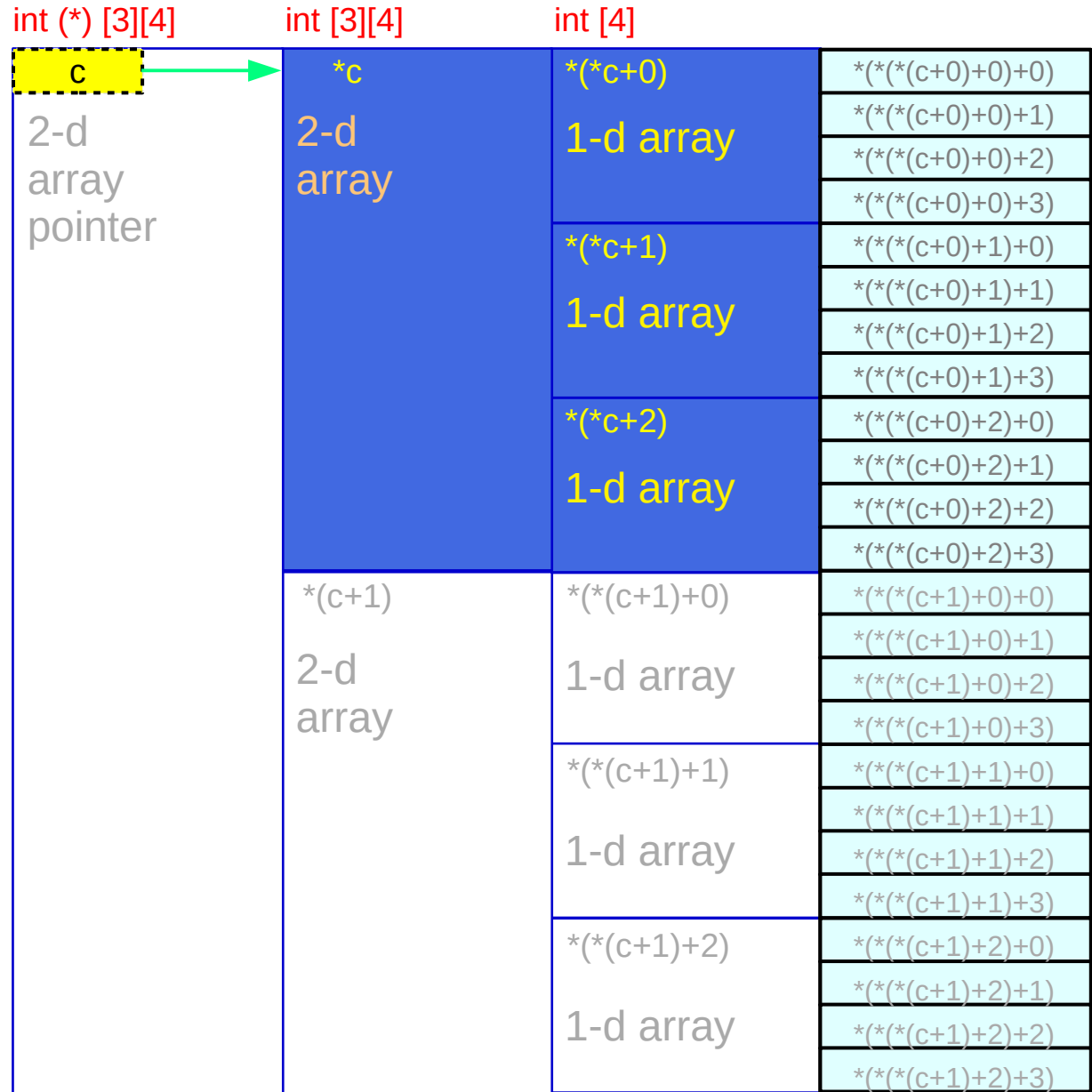

# Pointers to primitive data

**int \*p;**

**int i, j, k;**

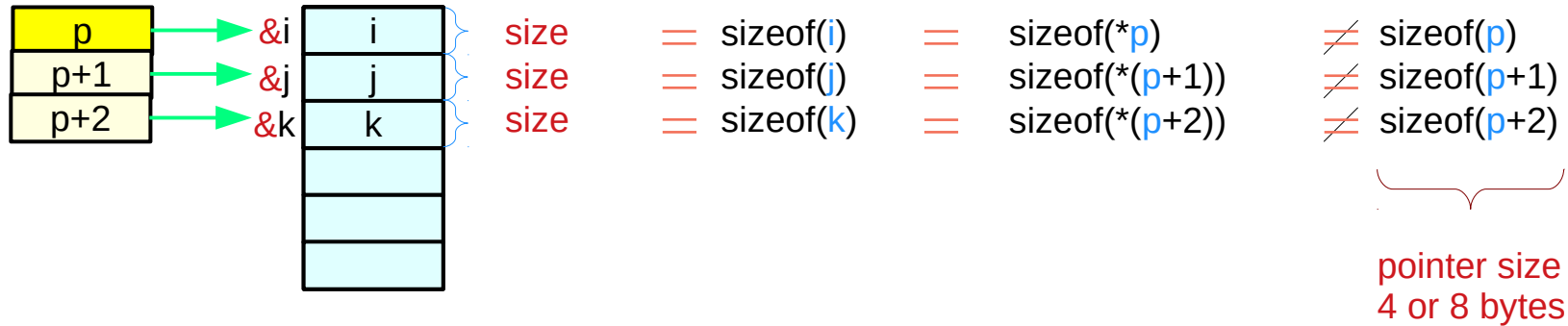

**double \*q;**

**double a, b, c;**

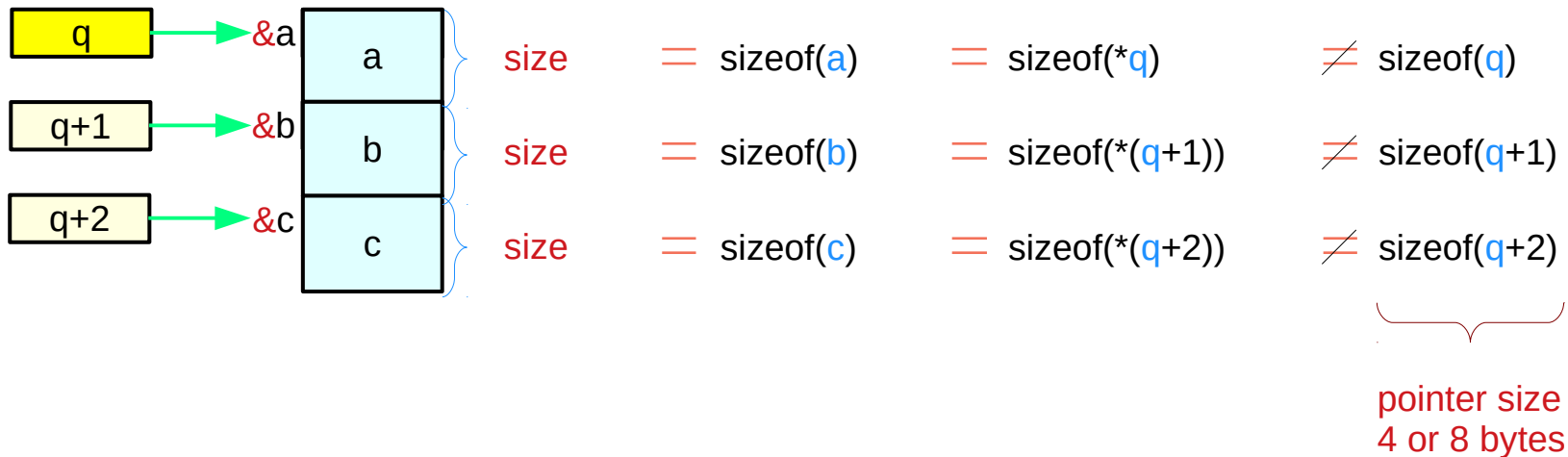

# Pointers to abstract data

**T \*p;**

**T X, Y, Z;**

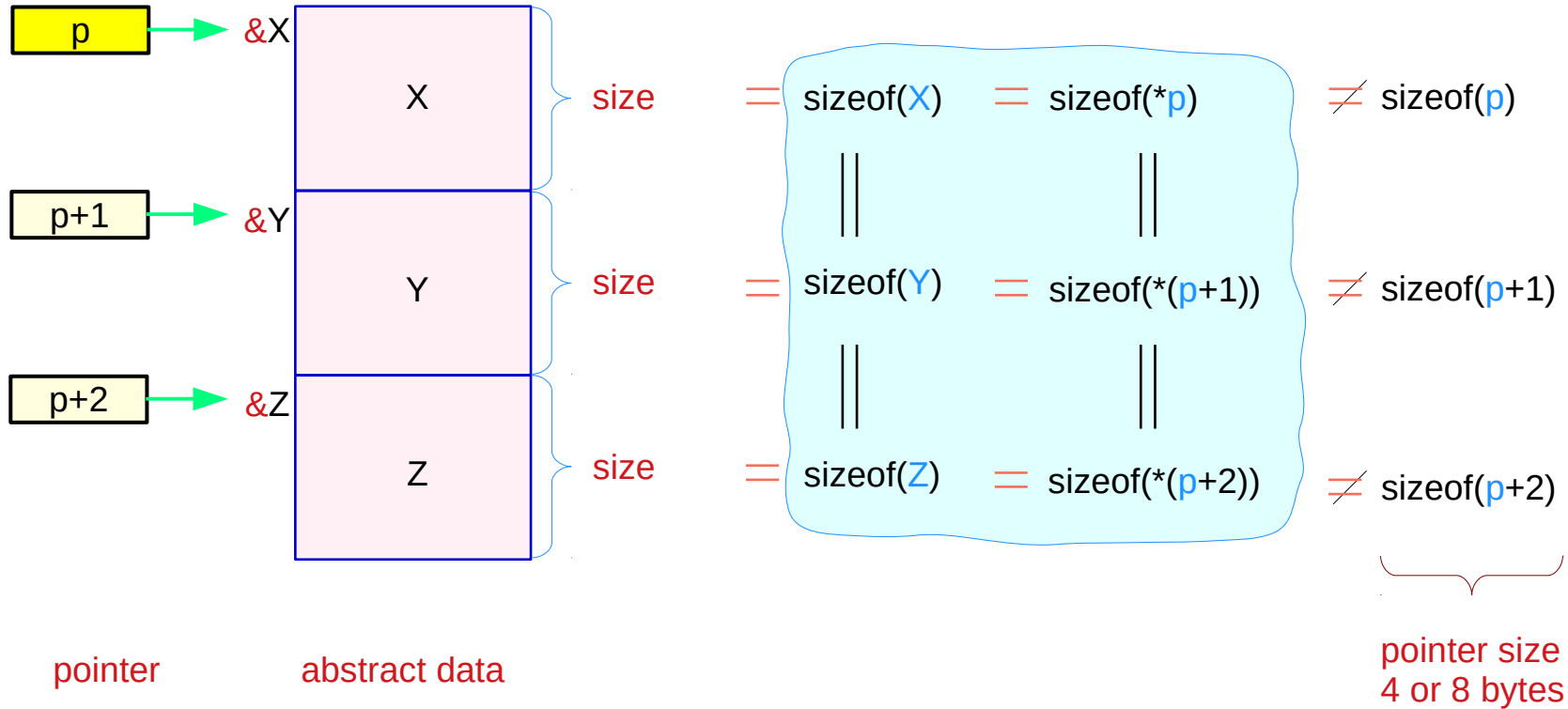

type ----- array  
 value ----- start address  
 increment size ----- size

# Virtual pointers in a multi-dimensional array

$p[i] :: T1$        $*p[i], *p[i+1] :: T2$

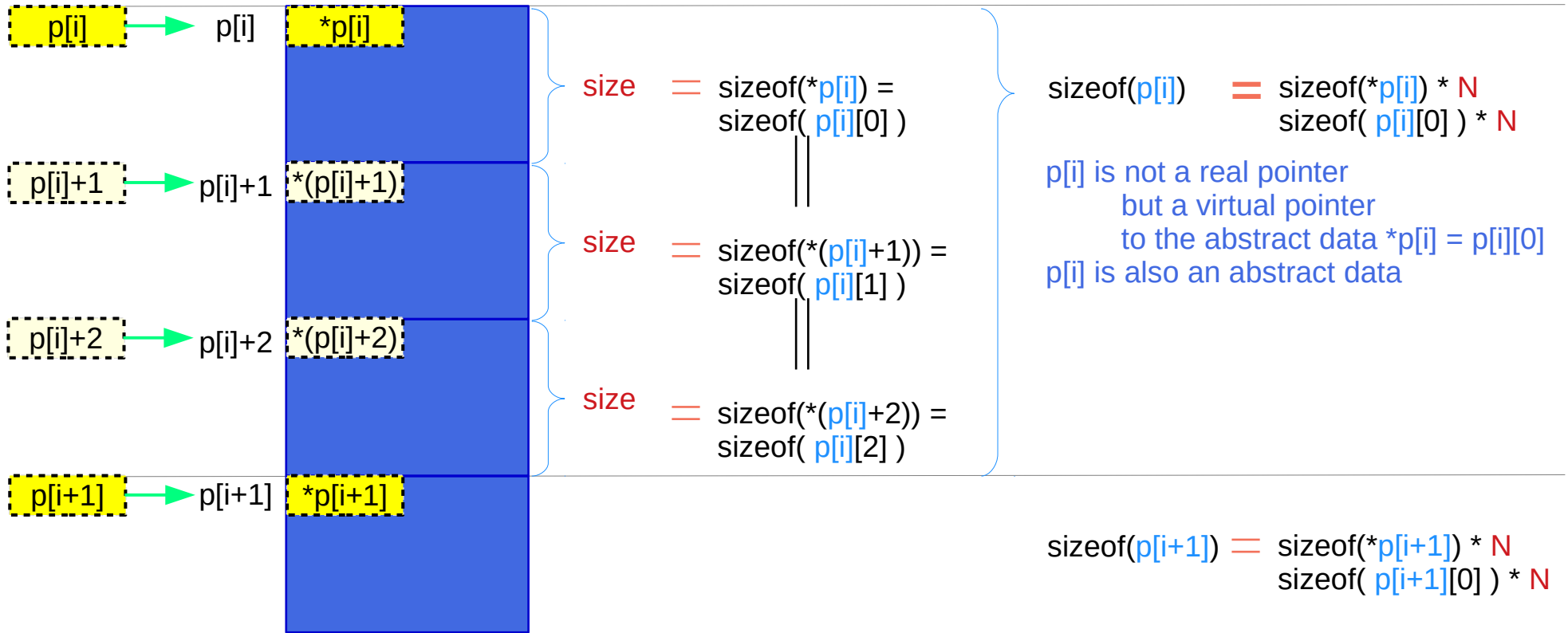

**T1**      **T2**

$\text{int} (*) [4]$        $\text{int} [4]$        $\subset \text{int} (*)$

$\text{int} (*) [3][4]$        $\text{int} [3][4]$        $\subset \text{int} (*) [4]$

# Virtual pointers in a multi-dimensional array

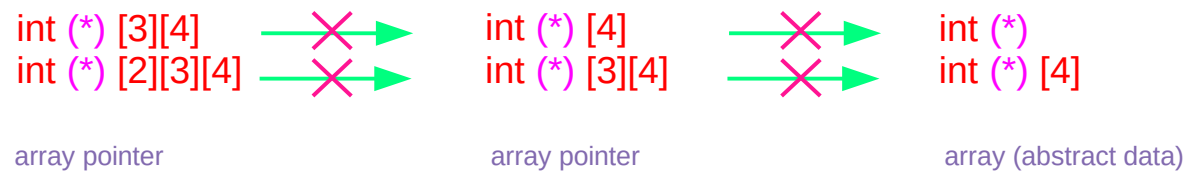
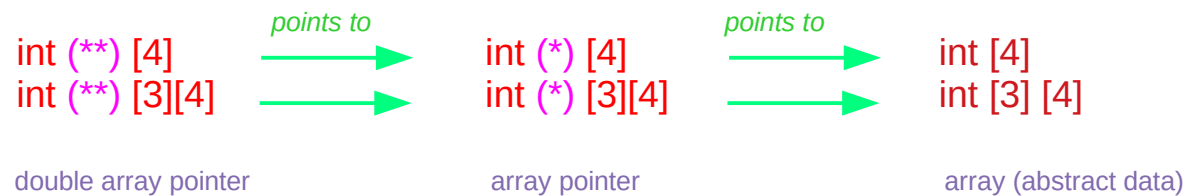
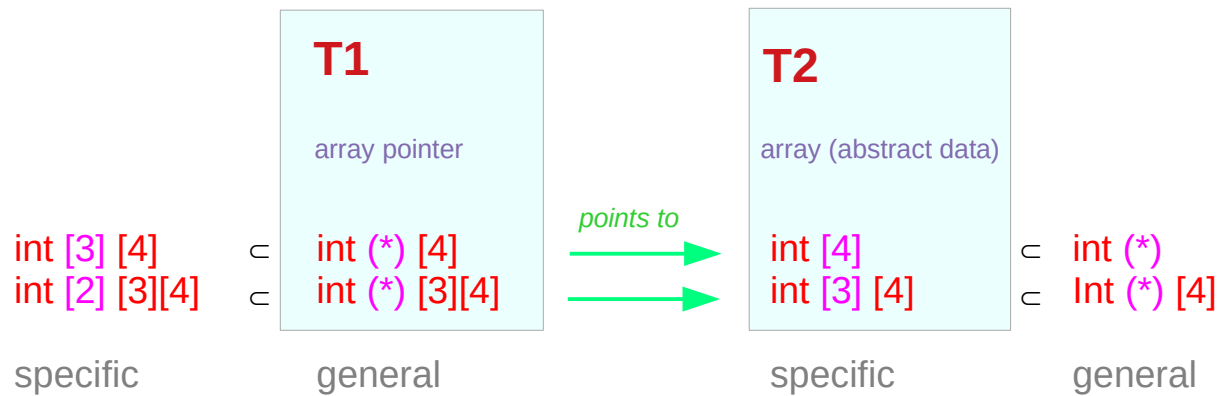

# Virtual pointers in a multi-dimensional array

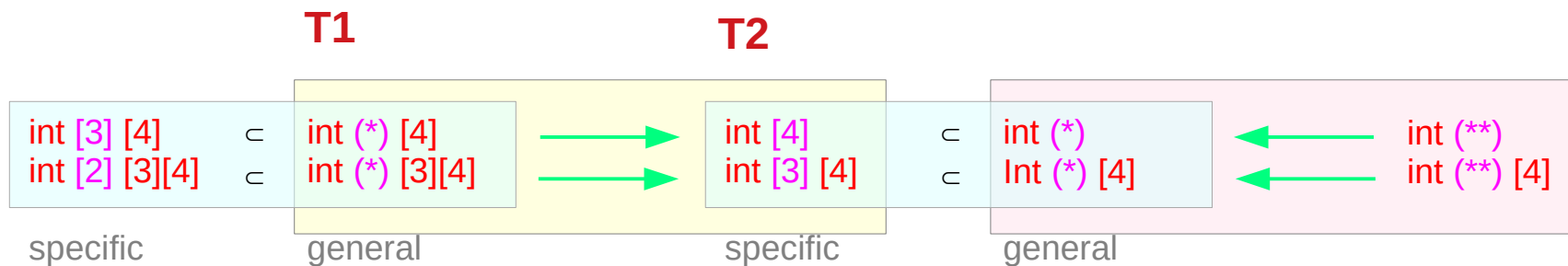

```
typedef int (*T1) [4];
typedef int (*T1) [3][4];
```

```
int (*) [4]
int (*) [3][4]
general
```

```
typedef int T2[4];
typedef int T2[3][4];
```

```
int [4]
int [3] [4]
specific
```

```
T1 a;
T2 b;
```

T1 is a pointer type  
T2 is an array type  
T1 has one more dimension than T2

```
a = &b;
*a = b;
```

a references b  
b is a dereference of a

# Virtual array pointers – types, sizes, and values

<b>int c[2][3][4];</b>	<b>c[i][j]</b>	<b>c[i][j][0]</b>	
type	int [4] int (*)	int int	<ul style="list-style-type: none"> <li>abstract data type</li> <li>array pointer type</li> </ul>
size	sizeof(c[i][j]) =	sizeof(c[i][j][0]) * 4	= sizeof(int) * 4
value (address)	c[i][j] =	&c[i][j][0]	
<b>int c[2][3][4];</b>	<b>c[i]</b>	<b>c[i][0]</b>	
type	int [3][4] int (*)[4]	int [4] int (*)	<ul style="list-style-type: none"> <li>abstract data type</li> <li>array pointer type</li> </ul>
size	sizeof(c[i]) =	sizeof(c[i][0]) * 3	= sizeof(int) * 4 * 3
value (address)	c[i] =	&c[i][0]	
<b>int c[2][3][4];</b>	<b>c</b>	<b>c[0]</b>	
type	int [2][3][4] int (*)[3][4]	int [3][4] int (*)[4]	<ul style="list-style-type: none"> <li>abstract data type</li> <li>array pointer type</li> </ul>
size	sizeof(c) =	sizeof(c[0]) * 2	= sizeof(int) * 4 * 3 * 2
value (address)	c =	&c[0]	



# virtual array pointers c, c[i], c[i][j] – sizes

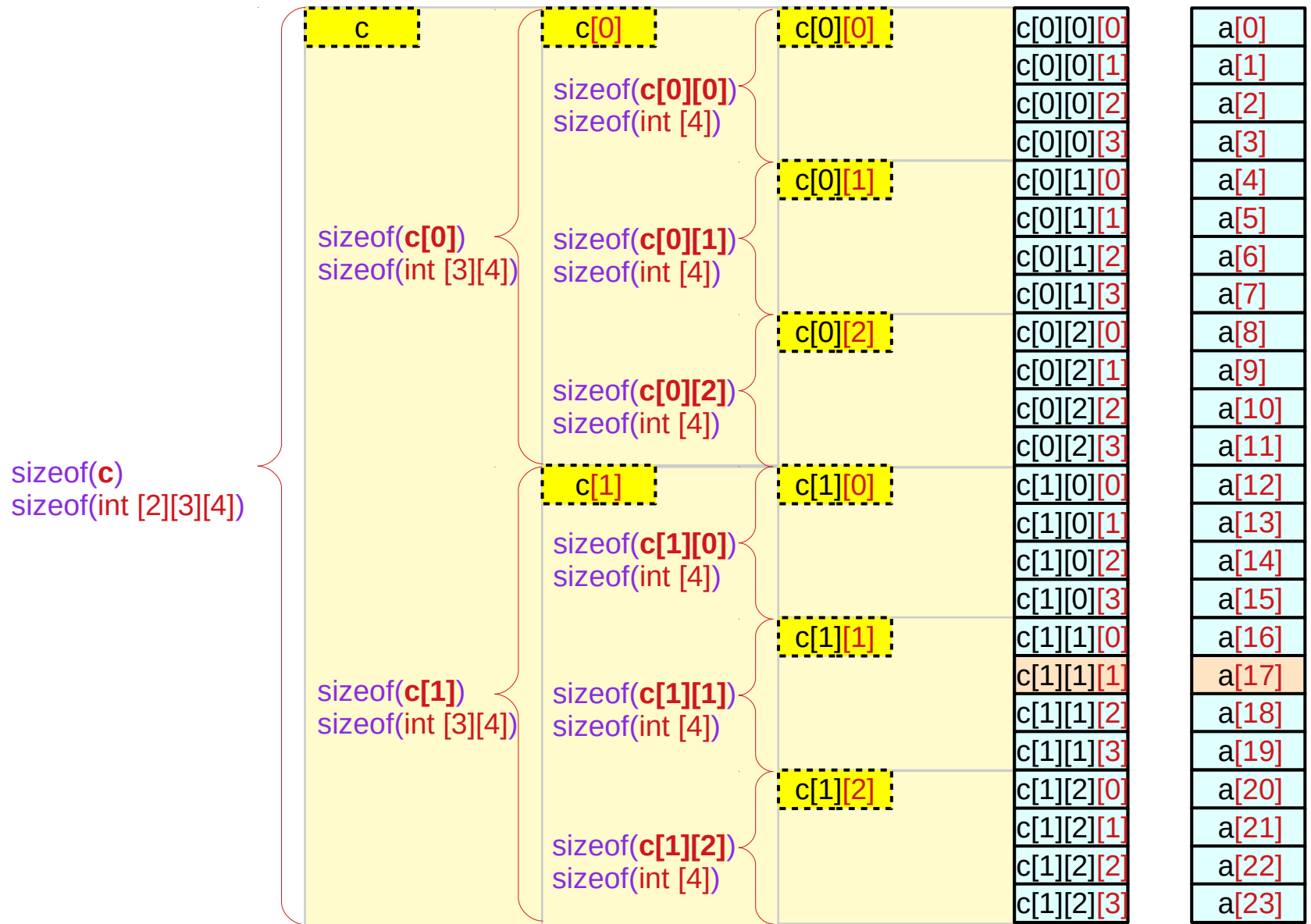

# Virtual array pointer $c$ , $c[i]$ , $c[i][j]$ – values (addresses)

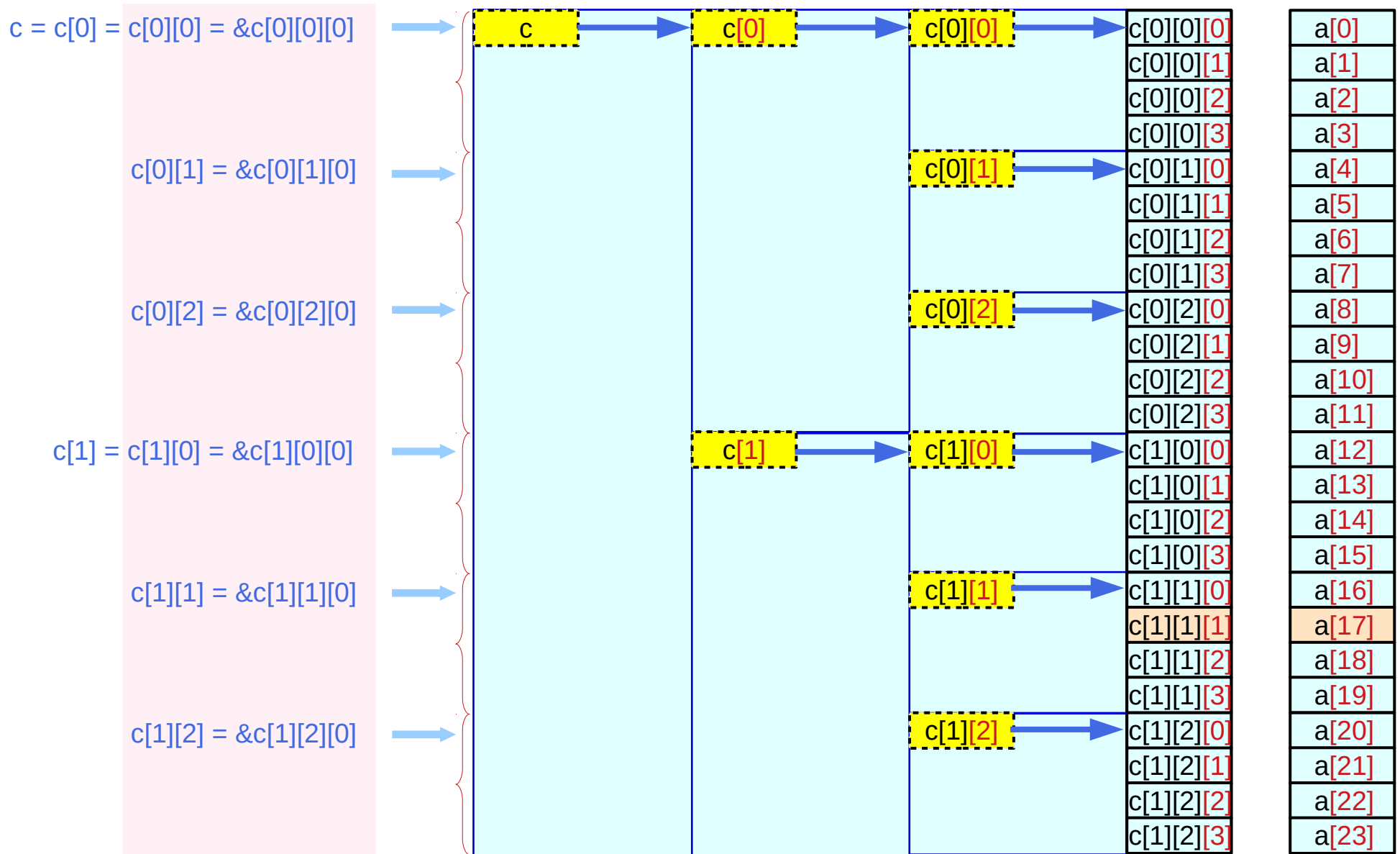

# Virtual array pointer $c$ , $c[i]$ , $c[i][j]$ – vertical displacement

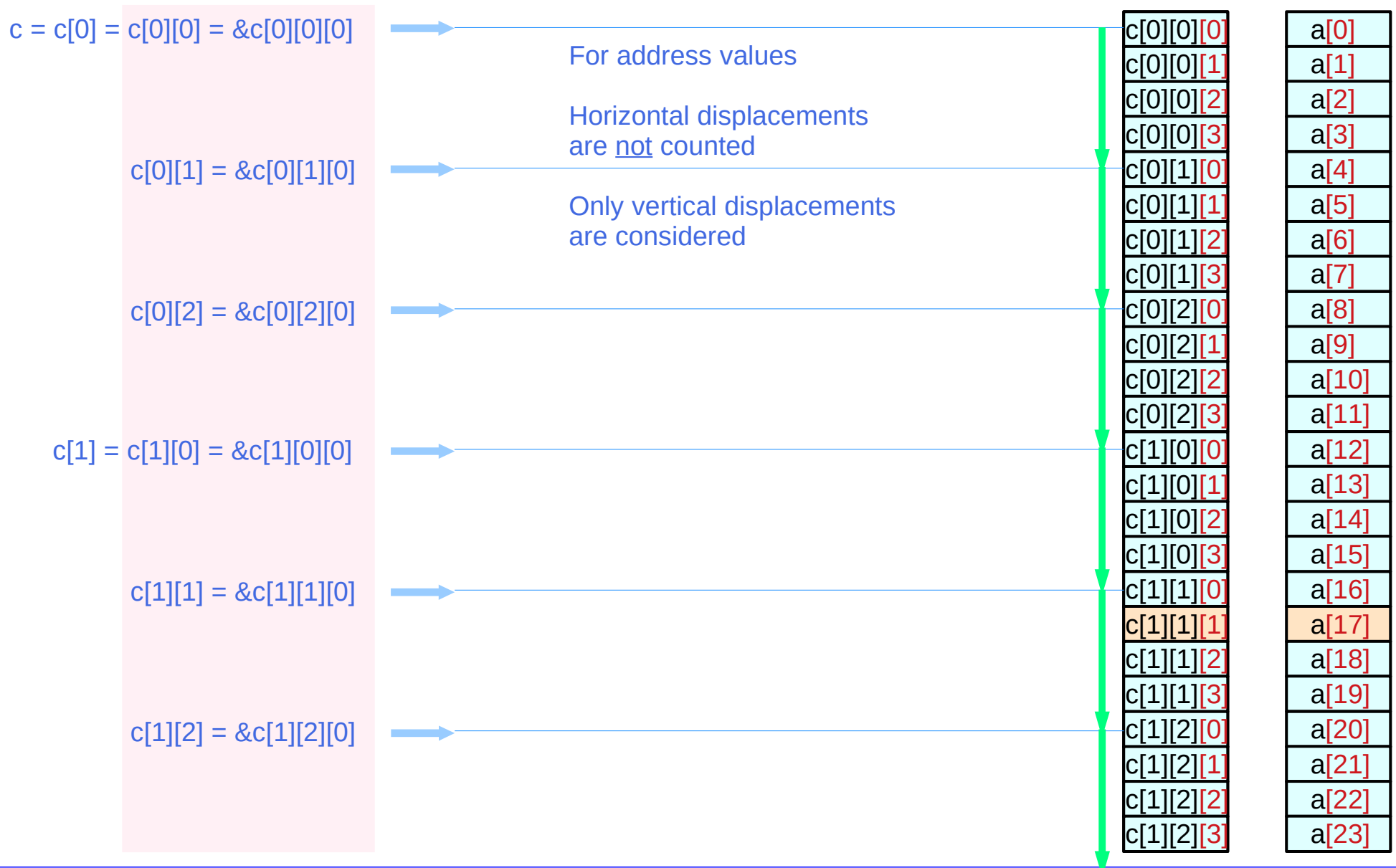

# Virtual array pointer c, c[i], c[i][j] – values and types

$c = c[0] = c[0][0] = \&c[0][0][0]$  means  $\rightarrow$   
 $c[0][1] = \&c[0][1][0]$  means  $\rightarrow$   
 $c[0][2] = \&c[0][2][0]$  means  $\rightarrow$   
 $c[1] = c[1][0] = \&c[1][0][0]$  means  $\rightarrow$   
 $c[1][1] = \&c[1][1][0]$  means  $\rightarrow$   
 $c[1][2] = \&c[1][2][0]$  means  $\rightarrow$

$value(c) = value(c[0]) = value(c[0][0]) = value(\&c[0][0][0])$ $type(c) \neq type(c[0]) \neq type(c[0][0]) = type(\&c[0][0][0])$ $int (*) [3][4] \quad int (*) [4] \quad int * \quad int *$
$value(c[0][1]) = value(\&c[0][1][0])$ $type(c[0][1]) = type(\&c[0][1][0])$ $int * \quad int *$
$value(c[0][2]) = value(\&c[0][2][0])$ $type(c[0][2]) = type(\&c[0][2][0])$ $int * \quad int *$
$value(c[1]) = value(c[1][0]) = value(\&c[1][0][0])$ $type(c[1]) \neq type(c[1][0]) = type(\&c[1][0][0])$ $int (*) [4] \quad int * \quad int *$
$value(c[1][1]) = value(\&c[1][1][0])$ $type(c[1][1]) = type(\&c[1][1][0])$ $int * \quad int *$
$value(c[1][2]) = value(\&c[1][2][0])$ $type(c[1][2]) = type(\&c[1][2][0])$ $int * \quad int *$

# Virtual array pointer c, c[0], c[0][0] – types and sizes

## Types – array pointers

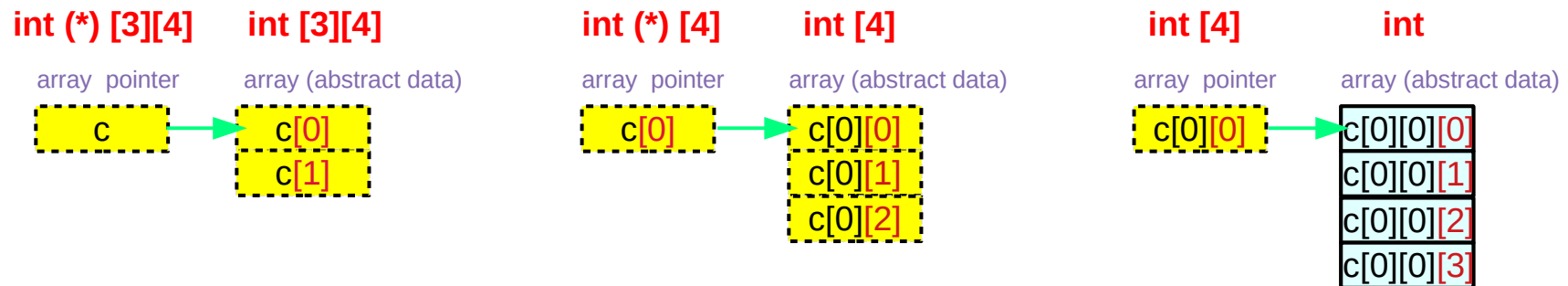

## Sizes – abstract data

<code>sizeof(c)</code>	<code>sizeof(c[0])</code>	<code>sizeof(c[0][0])</code>	<code>sizeof(c[0][0][0])</code>	<code>sizeof(c[0][0][0])</code>
<code>sizeof(c[0]) * 2</code>	<code>sizeof(c[0][0]) * 3</code>	<code>sizeof(c[0][0]) * 4</code>	<code>sizeof(c[0][0][0]) * 4</code>	<code>sizeof(c[0][0][0])</code>
<code>sizeof(c[0][0]) * 2 * 3</code>	<code>sizeof(c[0][0][0]) * 3 * 4</code>	<code>sizeof(c[0][0][0]) * 4</code>	<code>sizeof(c[0][0][0]) * 4</code>	<code>sizeof(c[0][0][0])</code>
<code>sizeof(c[0][0][0]) * 2 * 3 * 4</code>	<code>sizeof(c[0][0][0]) * 3 * 4</code>	<code>sizeof(c[0][0][0]) * 4</code>	<code>sizeof(c[0][0][0]) * 4</code>	<code>sizeof(c[0][0][0])</code>
<code>sizeof(int [2][3][4])</code>	<code>sizeof(int [3][4])</code>	<code>sizeof(int [4])</code>	<code>sizeof(int [4])</code>	<code>sizeof(int)</code>
<code>sizeof(int [2][3][4]) = 96</code>	<code>sizeof(int [3][4]) = 48</code>	<code>sizeof(int [4]) = 16</code>	<code>sizeof(int [4]) = 16</code>	<code>sizeof(int) = 4</code>
<code>sizeof(int (*)[3][4]) = 4 / 8</code>	<code>sizeof(int (*)[4]) = 4 / 8</code>	<code>sizeof(int (*)[4]) = 4 / 8</code>	<code>sizeof(int (*)[4]) = 4 / 8</code>	<code>sizeof(int) = 4</code>

# Abstract Data $c$ , $c[i]$ , $c[i][j]$ – start addresses and sizes

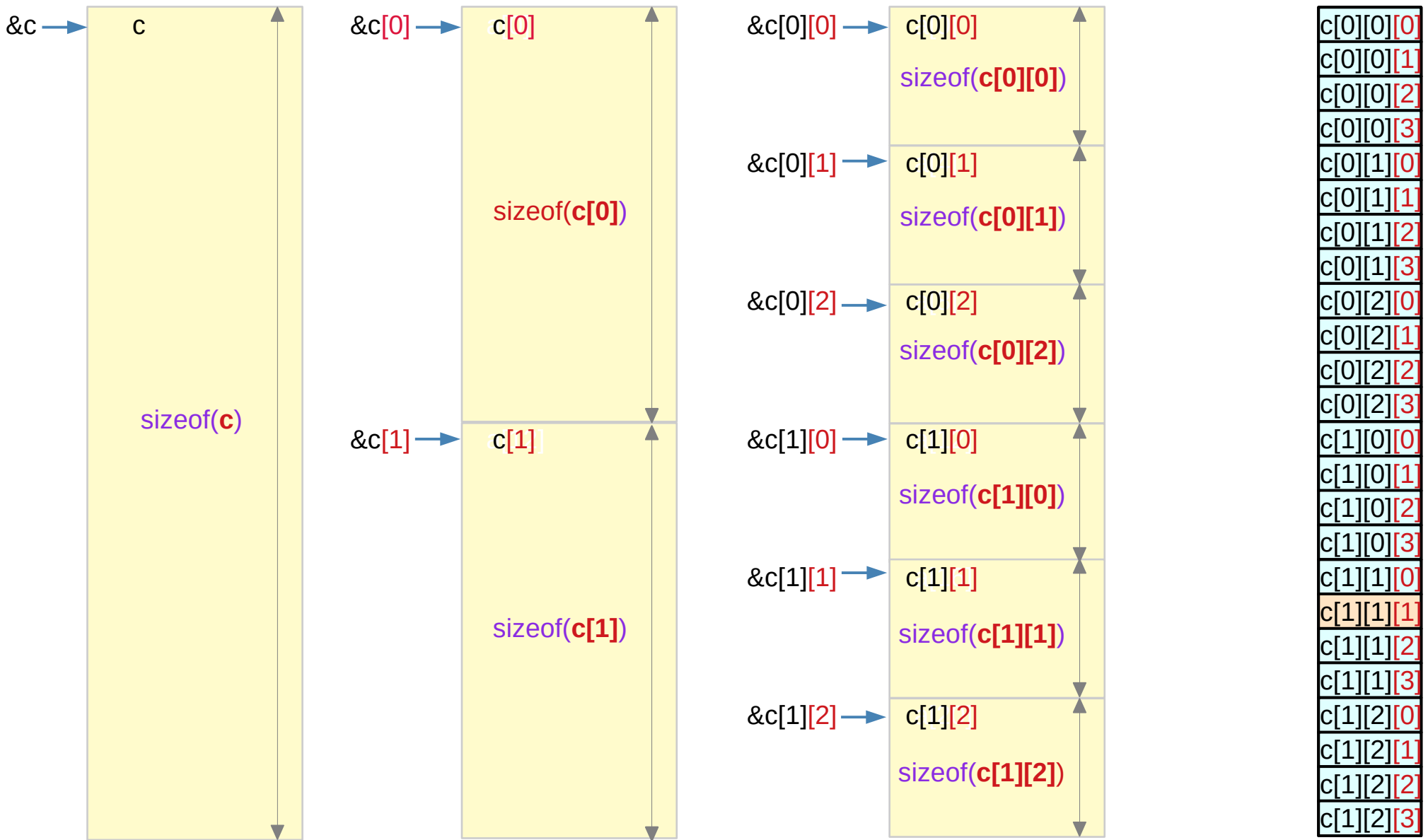

# Types in a multi-dimensional array

```
int c [2][3][4];
```

abstract data `int [2] [3][4]`  
array pointer `int (*) [3][4]`

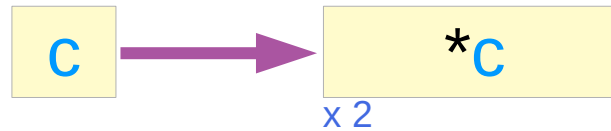

`int [3] [4]` abstract data  
`int (*) [4]` array pointer

abstract data `int [3] [4]`  
array pointer `int (*) [4]`

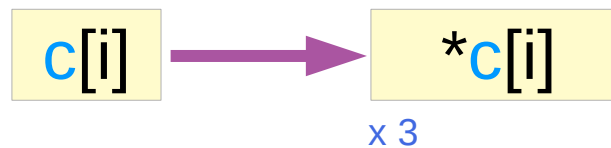

`int [4]` abstract data  
`int (*)` array pointer

abstract data `int [4]`  
array pointer `int (*)`

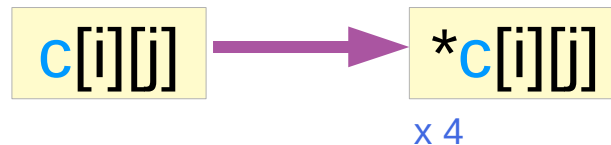

`int` primitive data

# Virtual array pointers and abstract data

```
int c [2][3][4];
```

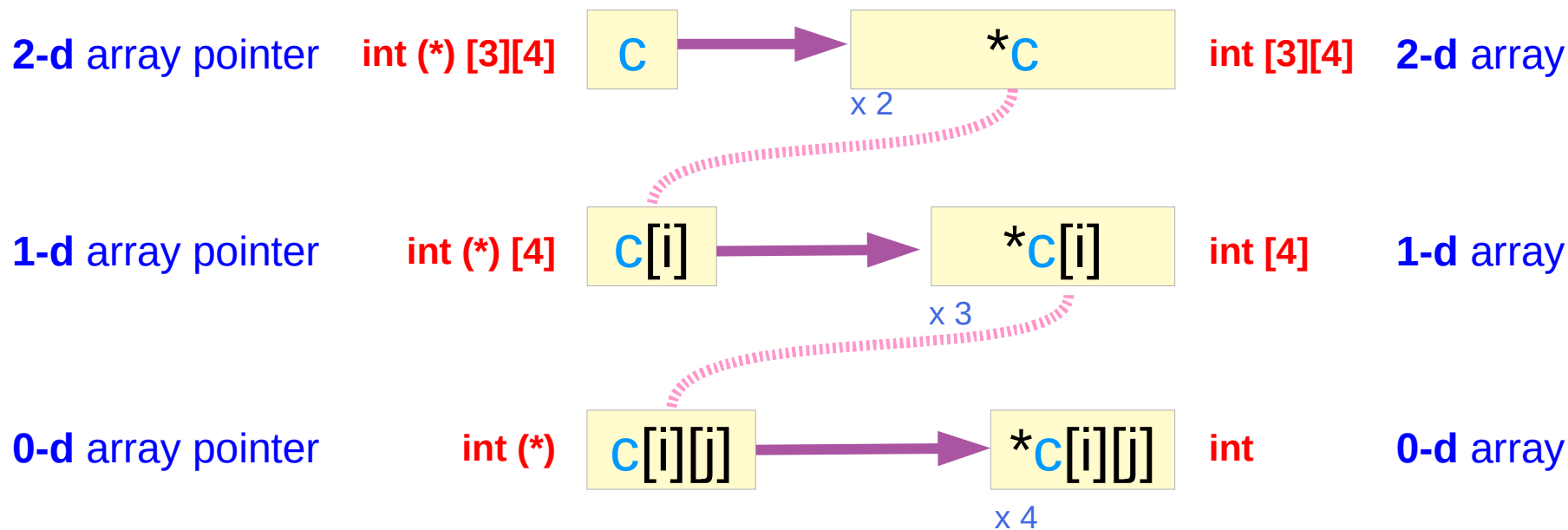

all these pointers are virtual, and take no actual memory locations

exploiting the **contiguity** of allocated memory locations



# Abstract Data Sizes

```
int c [2][3][4];
```

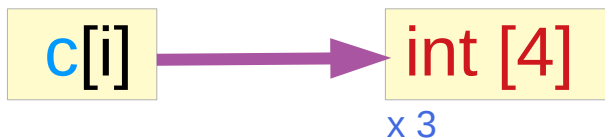
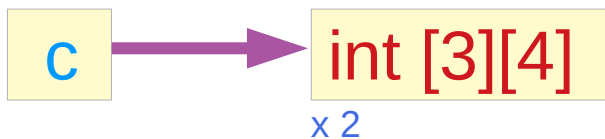

c, c[i], c[i][j] are virtual array pointers and they are also abstract data (arrays)

when sizes are considered, view them as abstract data (arrays)

the size of a pointer type is fixed  
Here, the sizes of virtual pointers are shown  
i.e, the sizes of different abstract data types

sizeof( c )	=	sizeof(int [2][3][4])
sizeof(*c)	=	sizeof(int [3][4])
sizeof( c[i] )	=	sizeof(int [3][4])
sizeof(*c[i] )	=	sizeof(int [4])
sizeof( c[i][j] )	=	sizeof(int [4])
sizeof(*c[i][j] )	=	sizeof(int)

all are sizes of arrays

# Virtual array pointer sizes and abstract data sizes

```
int c [2][3][4];
```

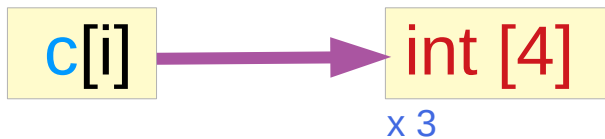
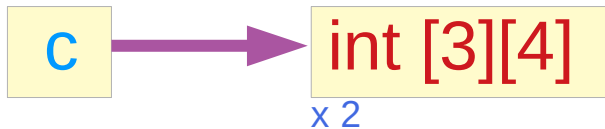

$$\text{size of a virtual array pointer} = \text{size of the pointed abstract data type} * \text{the number of such types}$$

$$\text{sizeof}( c ) = \text{sizeof}( *c ) * 2$$

$$\text{sizeof}( c[i] ) = \text{sizeof}( *c[i] ) * 3$$

$$\text{sizeof}( c[i][j] ) = \text{sizeof}( *c[i][j] ) * 4$$

# Sizes of array pointer types

```
int c [2][3][4];
```

c → int [3][4]

c[i] → int [4]

c[i][j] → int

not real array pointers  
virtual array pointers



c int (\*)[3][4]  
sizeof(int (\*) [3][4]) = pointer size ≠ sizeof(c)

c[i] int (\*) [4]  
sizeof(int (\*) [4]) = pointer size ≠ sizeof(c[i])

c[i][j] int [4]  
sizeof(int [4]) = pointer size ≠ sizeof(c[i][j])

4 bytes for 32-bit machines  
8 bytes for 64-bit machines

# Hierarchical nested array pointers

```
int c [2][3][4];
```

c points to a **2-d** array  
increment size:  $\text{sizeof(int)} * 2 * 3 * 4$

c[i] points to an **1-d** array  
increment size:  $\text{sizeof(int)} * 3 * 4$

c[i][j] points to an integer  
increment size:  $\text{sizeof(int)} * 4$

int (\*) [3][4]



int (\*) [4]

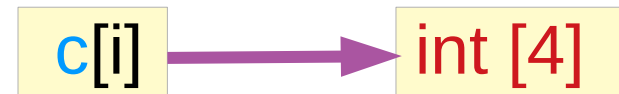

int (\*)



# Types of array pointers in a 3-d array

```
int c[2][3][4];
```

<code>c[i][j][k]</code>	:: int	int
<code>c[i][j]</code>	:: int <sub>[k]</sub> <sup>[4]</sup>	int (*) <sub>[k]</sub>
<code>c[i]</code>	:: int <sub>[j] [k]</sub> <sup>[3] [4]</sup>	int (*) <sub>[j] [k]</sub> <sup>[4]</sup>
<code>c</code>	:: int <sub>[j] [k]</sub> <sup>[2] [3] [4]</sup>	int (*) <sub>[j] [k]</sub> <sup>[3] [4]</sup>
	array type (name)	array pointer type

# Sizes of array pointers in a 3-d array

```
int c[2][3][4];
```

$\text{sizeof}(c[i][j][k]) = \text{sizeof}(\text{int})$

$\text{sizeof}(c[i][j]) = \text{sizeof}(\text{int}) * 4$   
[k]

$\text{sizeof}(c[i]) = \text{sizeof}(\text{int}) * 3 * 4$   
[j] [k]

$\text{sizeof}(c) = \text{sizeof}(\text{int}) * 2 * 3 * 4$   
[i] [j] [k]

# Address values of array pointers in a 3-d array

```
int c[2][3][4];
```

$c[i][j][k] = \&c[i][j][k]$

$c[i][j]+k = \&c[i][j][0] + k * \text{sizeof}(c[i][j][k])$        $\text{sizeof}(*c[i][j]) = \text{sizeof}(c[i][j][0]) = \text{sizeof}(\text{int})$

$c[i]+j = \&c[i][0][0] + j * \text{sizeof}(c[i][j])$        $\text{sizeof}(*c[i]) = \text{sizeof}(c[i][0]) = \text{sizeof}(\text{int}) * 4$   
[k]

$c+i = \&c[0][0][0] + i * \text{sizeof}(c[i])$        $\text{sizeof}(*c) = \text{sizeof}(c[0]) = \text{sizeof}(\text{int}) * 3 * 4$   
[j] [k]

# Summary of array pointers in a 3-d array

$$c[i] \equiv *(c + i)$$

int (\*) [3][4] 2-d array pointer  $c$   
int [2] [3][4] 3-d array name  $c$

address value  $c + i$

$\&c[0][0][0] + i * \text{sizeof}(*c)$   
 $\&c[0][0][0] + i * \text{sizeof}(c[0])$   
 $\&c[0][0][0] + i * 4 * 3 * 4$

leading elements

$c[0][0][0]$

$$c[i][j] \equiv *(c[i] + j)$$

int (\*) [4] 1-d array pointers  $c[i]$   
Int [3] [4] 2-d array names  $c[i]$

address value  $c[i] + j$

$\&c[i][0][0] + j * \text{sizeof}(*c[i])$   
 $\&c[i][0][0] + j * \text{sizeof}(c[i][0])$   
 $\&c[i][0][0] + j * 4 * 4$

leading elements

$c[0][0][0]$

$c[1][0][0]$

$$c[i][j][k] \equiv *(c[i][j] + k)$$

int (\*) 0-d array pointers  $c[i][j]$   
int [4] 1-d array names  $c[i][j]$

address value  $c[i][j] + k$

$\&c[i][j][0] + k * \text{sizeof}(*c[i][j])$   
 $\&c[i][j][0] + k * \text{sizeof}(c[i][j][0])$   
 $\&c[i][j][0] + k * 4$

leading elements

$c[0][0][0]$

$c[0][1][0]$

$c[0][2][0]$

$c[1][0][0]$

$c[1][1][0]$

$c[1][2][0]$



# Sub-array properties in multi-dimensional arrays

int c [2][3][4];  3-d access c [i][j][k]

2-d array pointer	c	int (*) [3][4]
1-d array pointers	c[i]	int (*) [4]
0-d array pointers	c[i][j]	int (*)

# Hierarchical Sub-arrays in a 3-d array

```
int c [L][M][N];
```

```
c [i][j][k]
```

left-to-right associativity

Array Names and Types

Pointers to hierarchical sub-arrays

c	[i]	[j][k]
c[i]	[j]	[k]
c[i][j]	[k]	

c	3-d array names	int (*) [M][N]	2-d array pointer
c[i]	2-d array names	int (*) [N]	1-d array pointer
c[i][j]	1-d array names	int (*)	0-d array pointer

# General requirements for accessing $c[i][j][k]$

$c[i][j][k]$



$$\begin{aligned}\&c[i][j][k] &= c[i][j] + k \\ \&c[i][j] &= c[i] + j \\ \&c[i] &= c + i\end{aligned}$$

$$\begin{aligned}c[i][j][k] &= *(c[i][j] + k) \\ c[i][j] &= *(c[i] + j) \\ c[i] &= *(c + i)\end{aligned}$$

$$\begin{aligned}\&c[i][j][0] &= c[i][j] \\ \&c[i][0] &= c[i] \\ \&c[0] &= c\end{aligned}$$

$$\begin{aligned}c[i][j][0] &= *(c[i][j]) \\ c[i][0] &= *(c[i]) \\ c[0] &= *(c)\end{aligned}$$

# 3-d access pattern $c[i][j][k]$

## General requirements

$c[i][j][k]$



$\&c[i][j][k] = c[i][j] + k$   
 $\&c[i][j] = c[i] + j$   
 $\&c[i] = c + i$

$\&c[i][j][0] = c[i][j]$   
 $\&c[i][0] = c[i]$   
 $\&c[0] = c$

## Pointer array approach

```
int** c[2];  
int* b[2*3];  
int c[2*3*4];
```

$c[i][j][k] :: \text{int}$   
 $c[i][j] :: \text{int}^*$   
 $c[i] :: \text{int}^{**}$

$c[i] \leftarrow \&b[i*3]$   
 $b[j] \leftarrow \&a[j*4]$

**Explicit**  
Arrays of pointers with  
Multiple Indirection

## N-dim Array approach

```
int c[2][3][4];
```

$c[i][j][k] :: \text{int}$   
 $c[i][j] :: \text{int}[4]$   
 $c[i] :: \text{int}^*[4]$

$c[i][j] \leftarrow \&c[i][j][0]$   
 $c[i] \leftarrow \&c[i][0][0]$   
 $c \leftarrow \&c[0][0][0]$

**Implicit**  
Nested  
Virtual Array Pointers

# 3-d access pattern $c[i][j][k]$ – array pointer approach

## General requirements

$c$   $[i][j][k]$



$\&c[i][j][k] = c[i][j] + k$   
 $\&c[i][j] = c[i] + j$   
 $\&c[i] = c + i$

$\&c[i][j][0] = c[i][j]$   
 $\&c[i][0] = c[i]$   
 $\&c[0] = c$

## N-dim array approach

```
int c[2][3][4];
```

```
c[i][j][k] :: int  
c[i][j]   :: int [4]  
c[i]     :: int (*) [4]  
c        :: int (*) [3][4]
```

```
c[i][j] ← &c[i][j][0]  
c[i]   ← &c[i][0][0]  
c      ← &c[0][0][0]
```

Implicit  
Nested  
Virtual Array Pointers



# Using N-dimensional arrays

```
int c [2][3][4];
```



```
c [i][j][k];
```

## constraints

```
c ← &c[0][0][0]  
c[i] ← &c[i][0][0]  
c[i][j] ← &c[i][j][0]
```

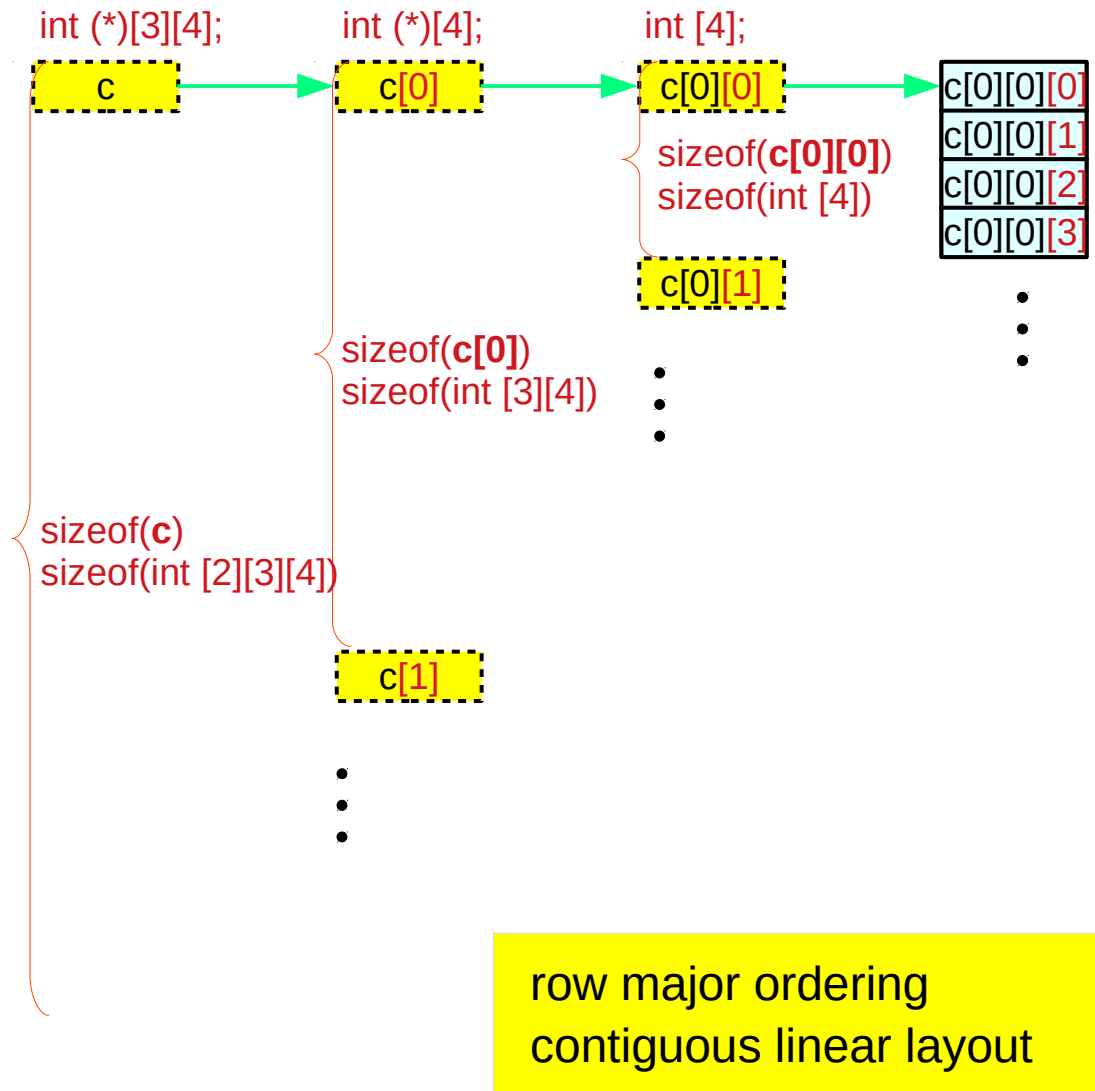

# Types of `c[i]` and `c[i][j]`

`c [i][j][k];`

`&c[i][j][0] = c[i][j]`  
`&c[i][0] = c[i]`  
`&c[0] = c`

`&c[i][j][k] = c[i][j]+k`  
`&c[i][j] = c[i]+j`  
`&c[i] = c+i`

`int c [2][3][4];`

`c[i]` virtual array pointer of the type `int (*) [4]`  
`c[i][j]` : the name of 1-d array with 4 integers `int [4]`

`c[i][j]` (virtual array) pointer of the type `int (*)`  
`c[i][j][k]` : an element of a 4-integer array `int`

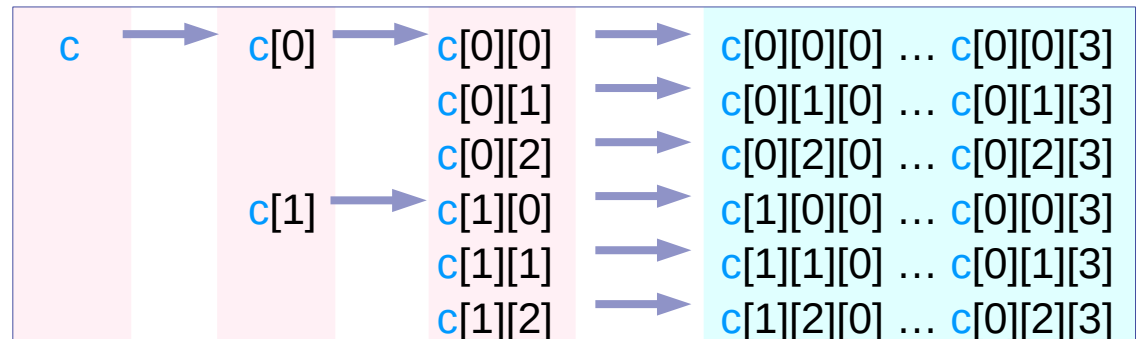

`int [2] [3][4]`   `int [3] [4]`   `int [4]`   `int ... int`  
`int (*) [3][4]`   `int (*) [4]`   `int (*)`   `int ... int`

pointers to a 2-d array   pointers to a 1-d array   1-d array names   leading element of 4-integer array

# Values of $c[i]$ and $c[i][j]$

$c[i][j][k];$

$\&c[i][j][0] = c[i][j]$   
 $\&c[i][0] = c[i]$   
 $\&c[0] = c$

$\&c[i][j][k] = c[i][j] + k$   
 $\&c[i][j] = c[i] + j$   
 $\&c[i] = c + i$

$\text{int } c[2][3][4];$

**virtual** array pointers

in each row in the following figure  
have the same value (address value)

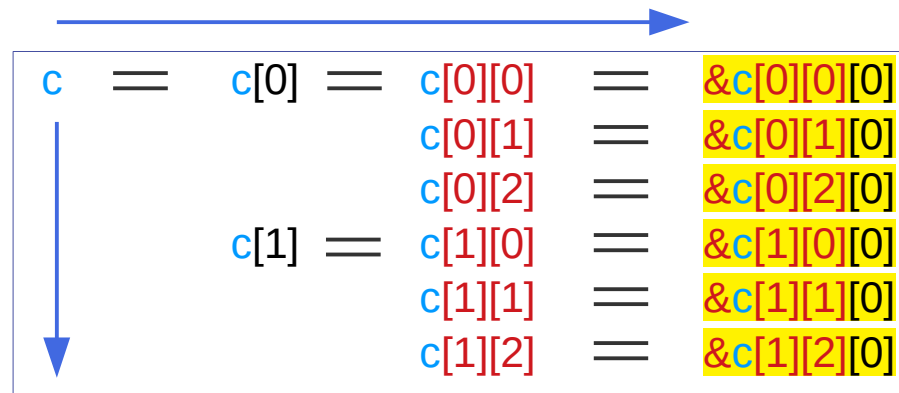

**Horizontal displacements** are not counted  
only **vertical displacements** are considered  
for address values

$c[i][j] = \&c[i][j][0]$   
 $c[i] = \&c[i][0][0]$   
 $c = \&c[0][0][0]$



# Finding address values of $c$ , $c[i]$ , $c[i][j]$

$c[i][j][k];$

$\&c[i][j][0] = c[i][j]$   
 $\&c[i][0] = c[i]$   
 $\&c[0] = c$

$\&c[i][j][k] = c[i][j] + k$   
 $\&c[i][j] = c[i] + j$   
 $\&c[i] = c + i$

$int\ c[2][3][4];$

$c[i][j] = \&c[i][j][0]$   
 $c[i] = \&c[i][0][0]$   
 $c = \&c[0][0][0]$

append [0] to the right

$c$	$\xrightarrow{+0}$	$c[0]$	$\xrightarrow{+0}$	$c[0][0]$	$\xrightarrow{+0}$	$\&c[0][0][0]$
				$c[0][1]$	$\xrightarrow{+0}$	$\&c[0][1][0]$
				$c[0][2]$	$\xrightarrow{+0}$	$\&c[0][2][0]$
		$c[1]$	$\xrightarrow{+0}$	$c[1][0]$	$\xrightarrow{+0}$	$\&c[1][0][0]$
				$c[1][1]$	$\xrightarrow{+0}$	$\&c[1][1][0]$
				$c[1][2]$	$\xrightarrow{+0}$	$\&c[1][2][0]$

$int (*) [3][4]$

$int (*) [4]$

$int [4]$

$int$

$c[i][j][0]$  :  
leading  
elements  
of  $c[i][j]$

$c[i][0][0]$  :  
leading  
elements  
of  $c[i]$

$c[0][0][0]$  :  
leading  
elements  
of  $c$

$\&c[0][0][0]$   
 $\&c[0][1][0]$   
 $\&c[0][2][0]$   
 $\&c[1][0][0]$   
 $\&c[1][1][0]$   
 $\&c[1][2][0]$

$\&c[0][0][0]$   
 $\&c[1][0][0]$

$\&c[0][0][0]$

# Finding sub arrays for the leading elements $c[i][j][0]$

$c[i][j][k];$

```
&c[i][j][0] = c[i][j]
&c[i][0]    = c[i]
&c[0]       = c
```

```
&c[i][j][k] = c[i][j]+k
&c[i][j]    = c[i]+j
&c[i]       = c+i
```

$int\ c[2][3][4];$

```
c[i][j] = &c[i][j][0]
c[i]    = &c[i][0][0]
c       = &c[0][0][0]
```

delete [0] from the right

$\&c[0][0][0]$	$\underline{\underline{-[0]}}$	$c[0][0]$	$\underline{\underline{-[0]}}$	$c[0]$	$\underline{\underline{-[0]}}$	$c$
$\&c[0][1][0]$	$\underline{\underline{-[0]}}$	$c[0][1]$				
$\&c[0][2][0]$	$\underline{\underline{-[0]}}$	$c[0][2]$				
$\&c[1][0][0]$	$\underline{\underline{-[0]}}$	$c[1][0]$	$\underline{\underline{-[0]}}$	$c[1]$		
$\&c[1][1][0]$	$\underline{\underline{-[0]}}$	$c[1][1]$				
$\&c[1][2][0]$	$\underline{\underline{-[0]}}$	$c[1][2]$				

int

int [4]

int (\*) [4]

int (\*) [3][4]

$c[0][0][0]$  is the leading element of  $c[0][0]$ ,  $c[0]$ ,  $c$   
 $c[0][1][0]$  is the leading element of  $c[0][1]$   
 $c[0][2][0]$  is the leading element of  $c[0][2]$   
 $c[1][0][0]$  is the leading element of  $c[1][0]$ ,  $c[1]$   
 $c[1][1][0]$  is the leading element of  $c[1][1]$   
 $c[1][2][0]$  is the leading element of  $c[1][2]$

## multi-dimensional arrays

```
c[i][j] = &c[i][j][0]  
c[i]   = &c[i][0][0]  
c      = &c[0][0][0]
```

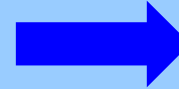

```
&c[i][j][0] = c[i][j]  
&c[i][0]   = c[i]  
&c[0]      = c
```

# Pointer reference and dereference relationship

```
c [i][j][k];
```

```
&c[i][j][0] = c[i][j]
&c[i][0]    = c[i]
&c[0]       = c
```

```
&c[i][j][k] = c[i][j]+k
&c[i][j]    = c[i]+j
&c[i]       = c+i
```

```
int c [2][3][4];
```

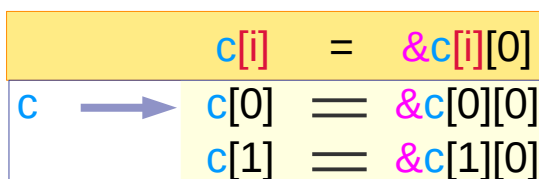
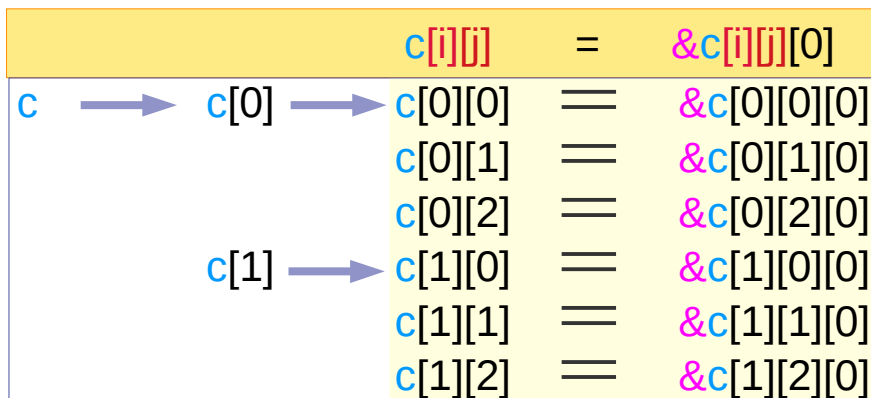
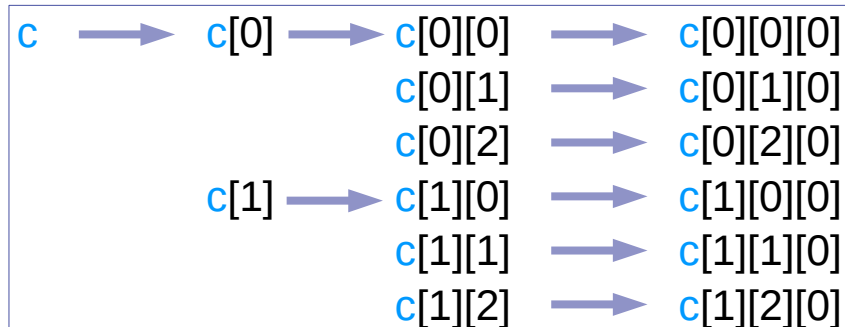

```
c = &c[0]
```

```
c == c[0]
```

# General requirements for `c[i][j][k]`

`c [i][j][k];`

`&c[i][j][0] = c[i][j]`  
`&c[i][0] = c[i]`  
`&c[0] = c`

`&c[i][j][k] = c[i][j]+k`  
`&c[i][j] = c[i]+j`  
`&c[i] = c+i`

`int c [2][3][4];`

`c[i][j]` virtual array pointer of the type `int (*)`  
`c[i][j][0]` : leading element of a 4-integer array `int`

`*(c[0][0]+0) = c[0][0][0]`  
`*(c[0][1]+0) = c[0][1][0]`  
`*(c[0][2]+0) = c[0][2][0]`  
`*(c[1][0]+0) = c[1][0][0]`  
`*(c[1][1]+0) = c[1][1][0]`  
`*(c[1][2]+0) = c[1][2][0]`

`c[0][0]` is the address of `c[0][0][0]`  
`c[0][1]` is the address of `c[0][1][0]`  
`c[0][2]` is the address of `c[0][2][0]`  
`c[1][0]` is the address of `c[1][0][0]`  
`c[1][1]` is the address of `c[1][1][0]`  
`c[1][2]` is the address of `c[1][2][0]`

`c[i]` virtual array pointer of the type `int (*) [4]`  
`c[i][j]` : a 4-element 1-d array name `int [4]`

`*(c[0]+0) = c[0][0]`  
`*(c[1]+0) = c[1][0]`

`c[0]` is the address of `c[0][0]`  
`c[1]` is the address of `c[1][0]`

`c[i][j] = &c[i][j][0]`  
`c[i] = &c[i][0][0]`  
`c = &c[0][0][0]`

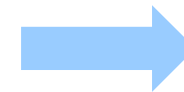

`&c[i][j][0] = c[i][j]`  
`&c[i][0] = c[i]`  
`&c[0] = c`

## multi-dimensional arrays

```
c[i][j] = &c[i][j][0]  
c[i]    = &c[i][0][0]  
c       = &c[0][0][0]
```



```
&c[i][j][0] = c[i][j]  
&c[i][0]    = c[i]  
&c[0]       = c
```

# c[0] = c[0][0] relation

`c [i][j][k];`

`&c[i][j][0] = c[i][j]`  
`&c[i][0] = c[i]`  
`&c[0] = c`

`&c[i][j][k] = c[i][j]+k`  
`&c[i][j] = c[i]+j`  
`&c[i] = c+i`

`int c [2][3][4];`

`c == c[0] == c[0][0] == &c[0][0][0]`

`value(c[0]) = &c[0][0][0]`

`value(c[0][0]) = &c[0][0][0]`

`type(c[0]) = int (*)[4]`

`type(c[0][0]) = int [4]`

`c[0] = c[0][0] means`  
`value(c[0]) = value(c[0][0])`

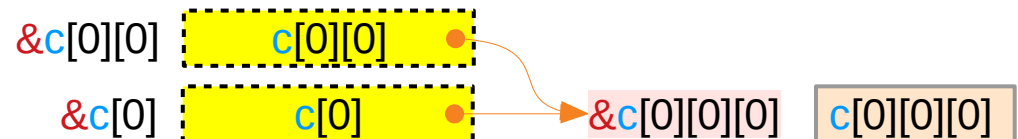

`c[i][j] = &c[i][j][0]`  
`c[i] = &c[i][0][0]`  
`c = &c[0][0][0]`

# Addresses and Values of $c[0]$ and $c[0][0]$

$c[i][j][k];$

$\&c[i][j][0] = c[i][j]$   
 $\&c[i][0] = c[i]$   
 $\&c[0] = c$

$\&c[i][j][k] = c[i][j] + k$   
 $\&c[i][j] = c[i] + j$   
 $\&c[i] = c + i$

$int\ c[2][3][4];$

$c \rightarrow c[0] \rightarrow c[0][0] = \&c[0][0][0]$

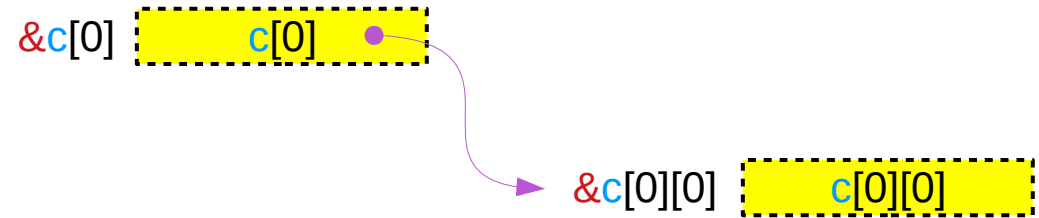

$c = c[0] = c[0][0] = \&c[0][0][0]$

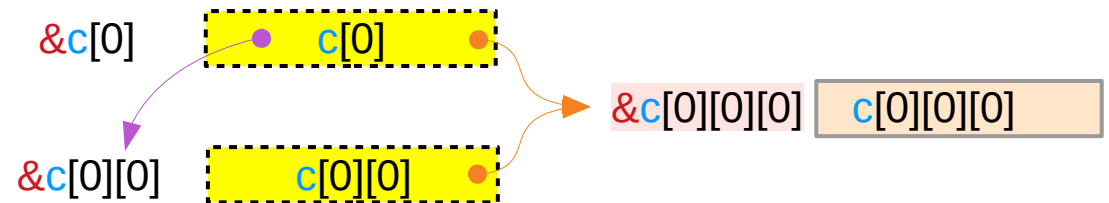

A virtual pointer's address and value are the same

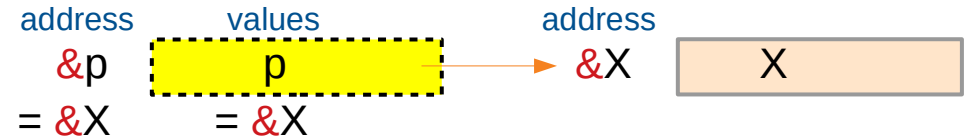



# c[0] and c[0][0] point to the same c[i][0][0]

```
c [i][j][k];
```

```
&c[i][j][0] = c[i][j]
&c[i][0]    = c[i]
&c[0]      = c
```

```
&c[i][j][k] = c[i][j]+k
&c[i][j]    = c[i]+j
&c[i]       = c+i
```

```
int c [2][3][4];
```

```
c[i][j] = &c[i][j][0]
c[i]    = &c[i][0][0]
c       = &c[0][0][0]
```

```
c = c[0] = c[0][0] = &c[0][0][0]
int(*)[3][4] int(*)[4] int(*) int
```

```
c[1] = c[1][0] = &c[1][0][0]
int(*)[4] int(*) int
```

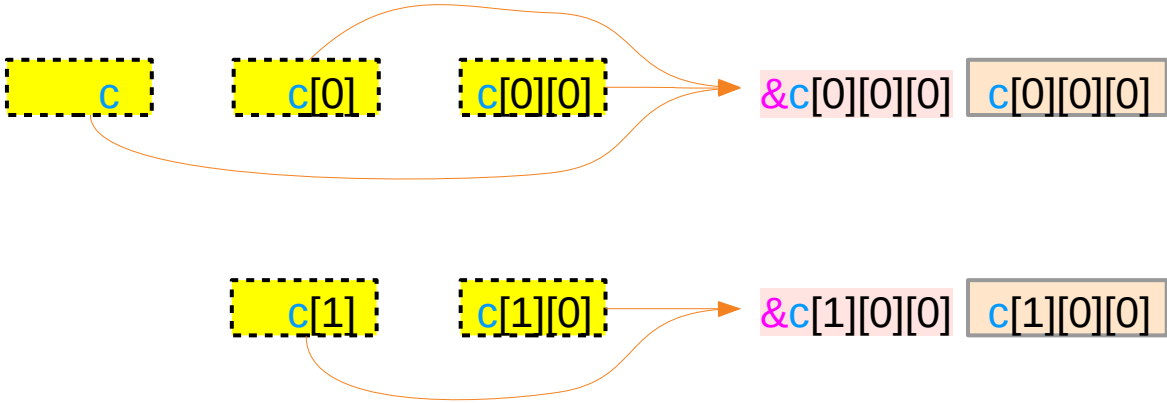

These virtual pointers have different types but the same value (address)

# &c[i][0] and &c[i][0][0] – equivalence relations

`c [i][j][k];`

`&c[i][j][0] = c[i][j]`  
`&c[i][0] = c[i]`  
`&c[0] = c`

`&c[i][j][k] = c[i][j]+k`  
`&c[i][j] = c[i]+j`  
`&c[i] = c+i`

`int c [2][3][4];`

`c[i][j] = &c[i][j][0]`  
`c[i] = &c[i][0][0]`  
`c = &c[0][0][0]`

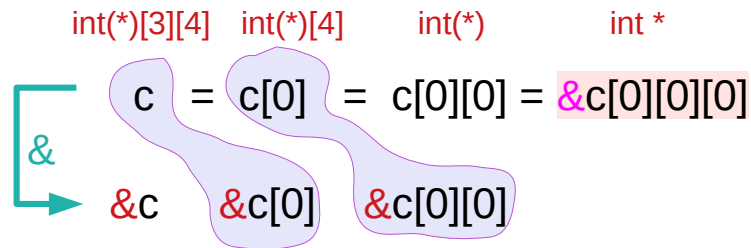

equivalences

`c ≡ &c[0],`  
`c[0] ≡ &c[0][0]`  
`c[0][0] ≡ &c[0][0][0]`

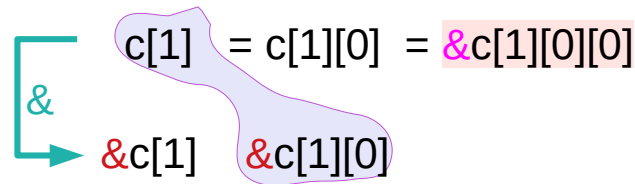

equivalences

`c[1] ≡ &c[1][0]`  
`c[1][0] ≡ &c[1][0][0]`

Horizontal displacements are not counted  
 only vertical displacements are considered  
 for address values

equivalences

`c ≡ &c[0],`  
`c[i] ≡ &c[i][0]`  
`c[i][0] ≡ &c[i][0][0]`

# $c[i] = \&c[i]$ and $c[i][0] = \&c[i][0]$

$c[i][j][k];$

$\&c[i][j][0] = c[i][j]$   
 $\&c[i][0] = c[i]$   
 $\&c[0] = c$

$\&c[i][j][k] = c[i][j] + k$   
 $\&c[i][j] = c[i] + j$   
 $\&c[i] = c + i$

$\text{int } c[2][3][4];$

$c[i][j] = \&c[i][j][0]$   
 $c[i] = \&c[i][0][0]$   
 $c = \&c[0][0][0]$

$c = c[0] = c[0][0] = \&c[0][0][0]$   
 $\&c = \&c[0] = \&c[0][0]$

$c[1] = c[1][0] = \&c[1][0][0]$   
 $\&c[1] = \&c[1][0]$

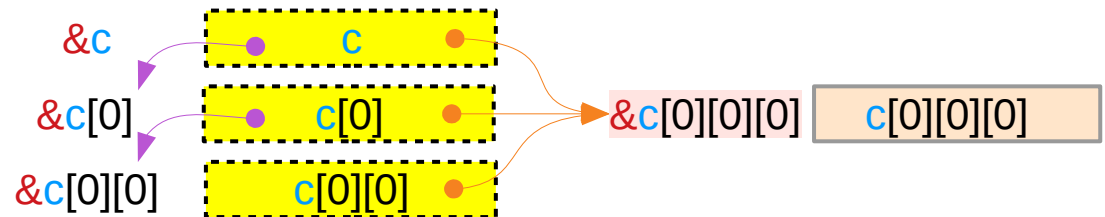

# $c[i] = \&c[i]$ and $c[i][0] = \&c[i][0]$

$c[i][j][k];$

$\&c[i][j][0] = c[i][j]$   
 $\&c[i][0] = c[i]$   
 $\&c[0] = c$

$\&c[i][j][k] = c[i][j] + k$   
 $\&c[i][j] = c[i] + j$   
 $\&c[i] = c + i$

$\text{int } c[2][3][4];$

$c[i][j] = \&c[i][j][0]$   
 $c[i] = \&c[i][0][0]$   
 $c = \&c[0][0][0]$

A virtual pointer's address and value are the same

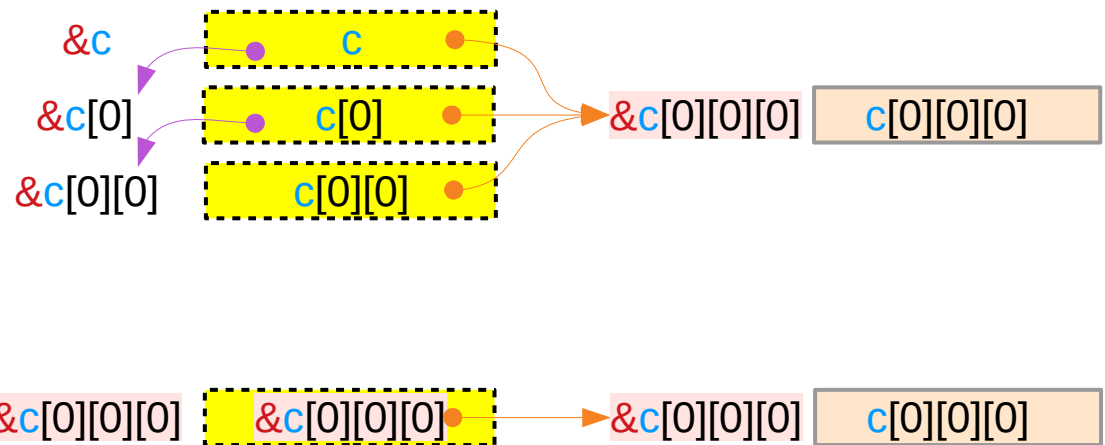
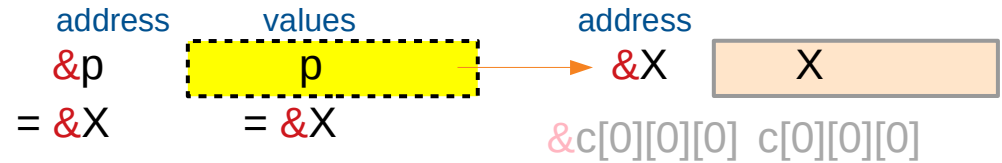

## Leading elements and array pointers

`c[0][0][0]` is the leading element of `c[0][0]`, `c[0]`, `c`

`c[0][1][0]` is the leading element of `c[0][1]`

`c[0][2][0]` is the leading element of `c[0][2]`

`c[1][0][0]` is the leading element of `c[1][0]`, `c[1]`

`c[1][1][0]` is the leading element of `c[1][1]`

`c[1][2][0]` is the leading element of `c[1][2]`

# Array Pointers to $c[i][0][0]$

$c[i][j][k];$

$\&c[i][j][0] = c[i][j]$   
 $\&c[i][0] = c[i]$   
 $\&c[0] = c$

$\&c[i][j][k] = c[i][j] + k$   
 $\&c[i][j] = c[i] + j$   
 $\&c[i] = c + i$

$int\ c[2][3][4];$

$c[i][j] = \&c[i][j][0]$   
 $c[i] = \&c[i][0][0]$   
 $c = \&c[0][0][0]$

$\&c[i][0][0] \equiv c[i][0]$

$\&c[i][0] \equiv c[i]$

$\&c[i] \equiv c + i$

virtual pointers:  
the address of a pointer is  
the same as its value

$= c + i * \text{sizeof}(*c)$   
 $= \&c[0][0][0] + i * 3 * 4$

delete [0] from the right

$\&c[0][0][0] \xrightarrow{-[0]} c[0][0] \xrightarrow{-[0]} c[0] \xrightarrow{-[0]} c$   
 $\&c[1][0][0] \xrightarrow{-[0]} c[1][0] \xrightarrow{-[0]} c[1]$

# Array Pointers to $c[i][j][0]$

$c[i][j][k];$

$\&c[i][j][0] = c[i][j]$   
 $\&c[i][0] = c[i]$   
 $\&c[0] = c$

$\&c[i][j][k] = c[i][j] + k$   
 $\&c[i][j] = c[i] + j$   
 $\&c[i] = c + i$

$int\ c[2][3][4];$

$c[i][j] = \&c[i][j][0]$   
 $c[i] = \&c[i][0][0]$   
 $c = \&c[0][0][0]$

$\&c[i][j][0] \equiv c[i][j]$

$\&c[i][j] \equiv c[i] + j$

$= c[i] + j * \text{sizeof}(*c[i])$   
 $= c + i * \text{sizeof}(*c) + j * 4$   
 $= \&c[0][0][0] + i * 3 * 4 + j * 4$

delete [0] from the right

$\&c[0][0][0]$	$\underline{\underline{-[0]}}$	$c[0][0]$	$\underline{\underline{-[0]}}$	$c[0]$	$\underline{\underline{-[0]}}$	$c$
$\&c[0][1][0]$	$\underline{\underline{-[0]}}$	$c[0][1]$				
$\&c[0][2][0]$	$\underline{\underline{-[0]}}$	$c[0][2]$				
$\&c[1][0][0]$	$\underline{\underline{-[0]}}$	$c[1][0]$	$\underline{\underline{-[0]}}$	$c[1]$		
$\&c[1][1][0]$	$\underline{\underline{-[0]}}$	$c[1][1]$				
$\&c[1][2][0]$	$\underline{\underline{-[0]}}$	$c[1][2]$				

# Contiguity Constraints

c [i][j][k];

Virtual Array Pointers and Contiguity



# Using array pointers

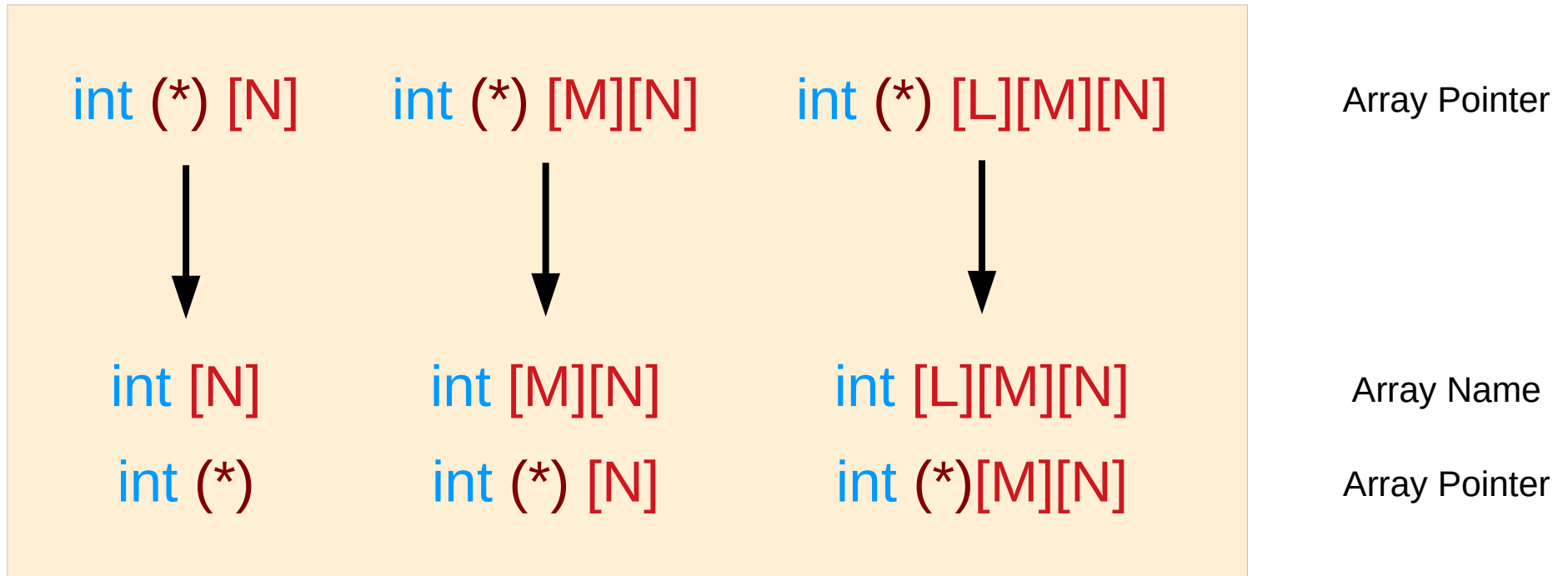

# Array pointer approach – contiguity constraints

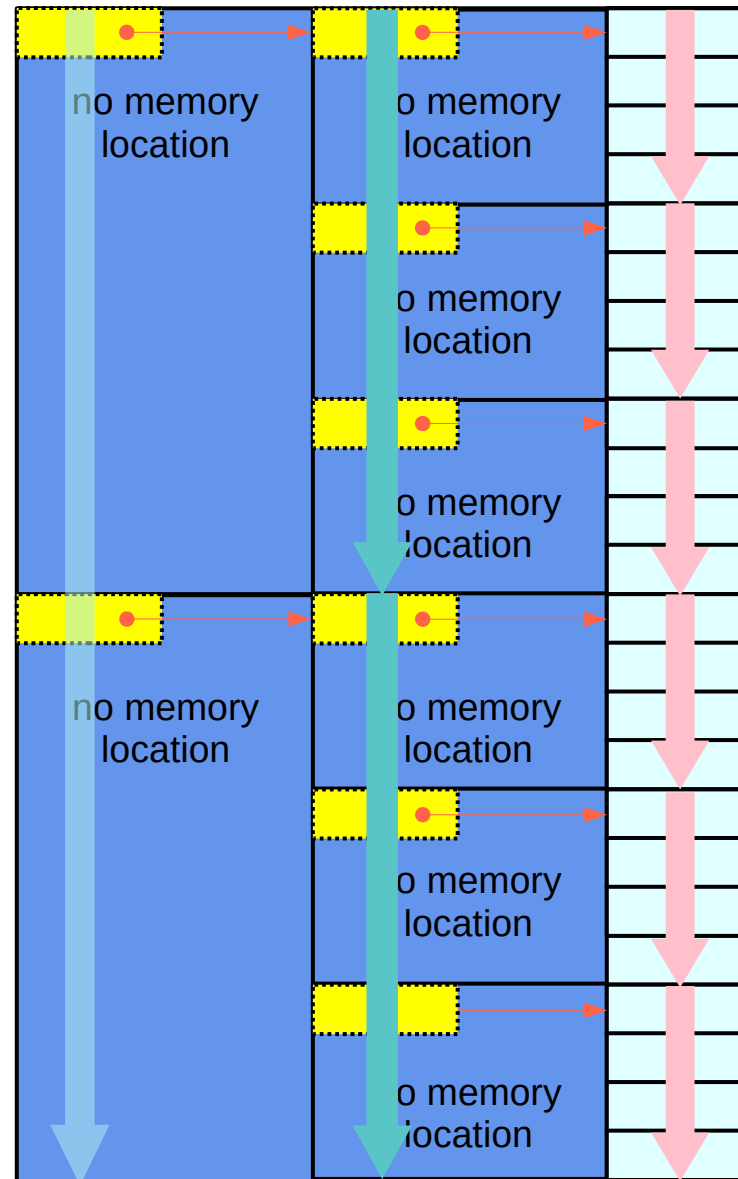

Array **Pointer** Approach  
(**pointer to arrays**)

# Equivalence and contiguity (1)

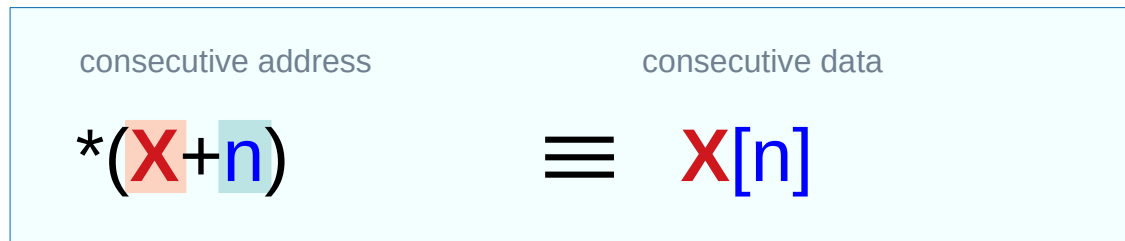

contiguous index : n

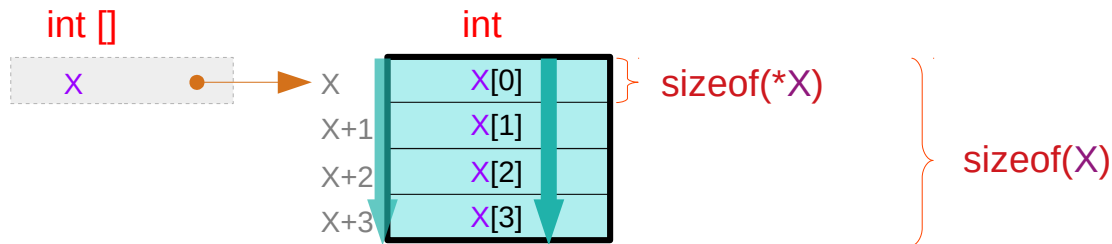

`int X[4]`; contiguous `X[i]` for a given `X` : **primitive types**

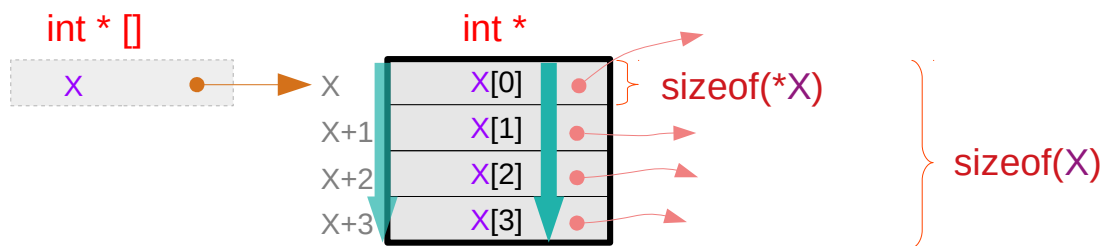

`int * X[4]`; contiguous `X[i]` for a given `X` : **pointer types**

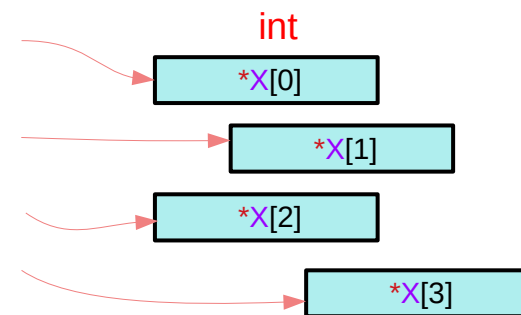

# Equivalence and contiguity (2)

consecutive address                      consecutive data

$$*(X+n) \equiv X[n]$$

contiguous index : n

can be recursively applied

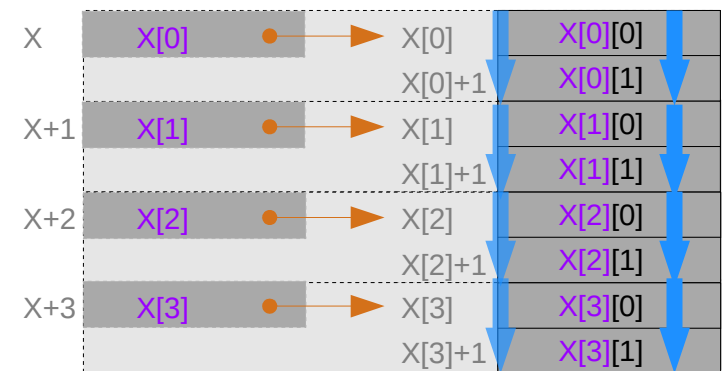
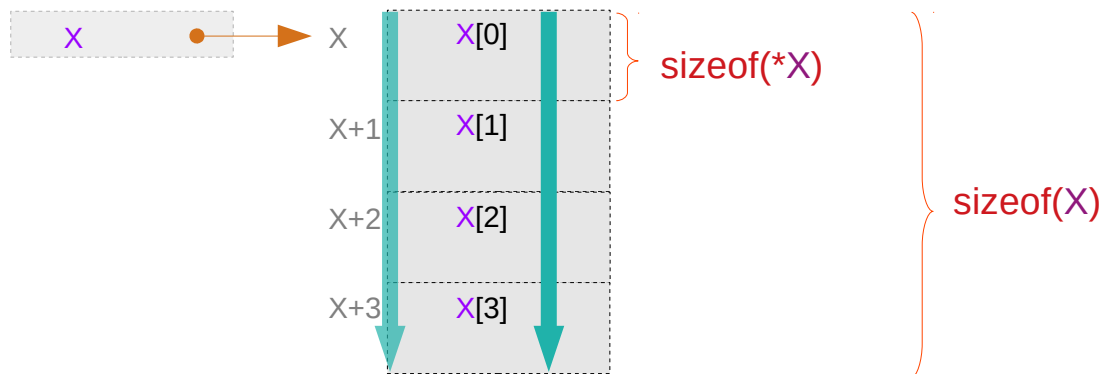

**atype \* X[4];** contiguous `X[i]` for a given `X` : **abstract data types**

# Recursive applications of equivalences

By definition, contiguous memory locations are assumed

consecutive address		consecutive data
$*(X+n)$	$\equiv$	$X[n]$

contiguous index : n

$*(p[m]+n)$	$\leftrightarrow$	$p[m][n]$
$(*(p+m))[n];$	$\leftrightarrow$	$p[m][n];$

$X = p[m]$  contiguous index : n

$X = p$  contiguous index : m

# Equivalence for a given p[m] (1)

$$*(p[m]+n) \iff p[m][n]$$

for a given  $p[m]$  contiguous index :  $n$

**int p[M][4];** contiguous p[m][n] for a given p[m] : **primitive types**

$m = 0, 1, \dots, M-1$

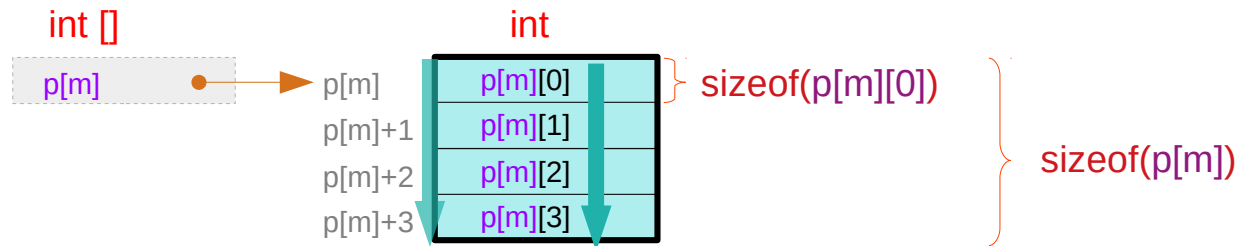

**int \* p[M][4];** contiguous p[m][n] for a given p[m] : **pointer types**

$m = 0, 1, \dots, M-1$

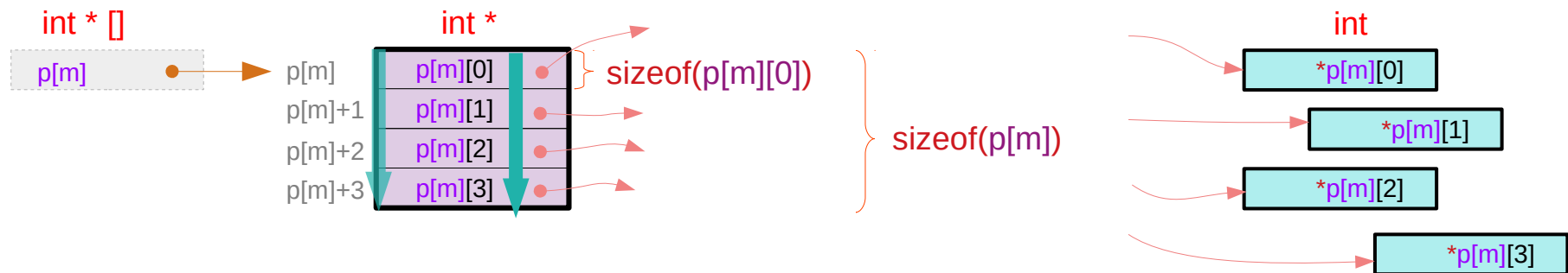

# Equivalence for a given p[m] (2)

$$*(p[m]+n) \iff p[m][n]$$

for a given  $p[m]$  contiguous index :  $n$

**atype \* p[M][4];** contiguous  $p[m][n]$  for a given  $p[m]$  : **abstract data types**  $m = 0, 1, \dots, M-1$

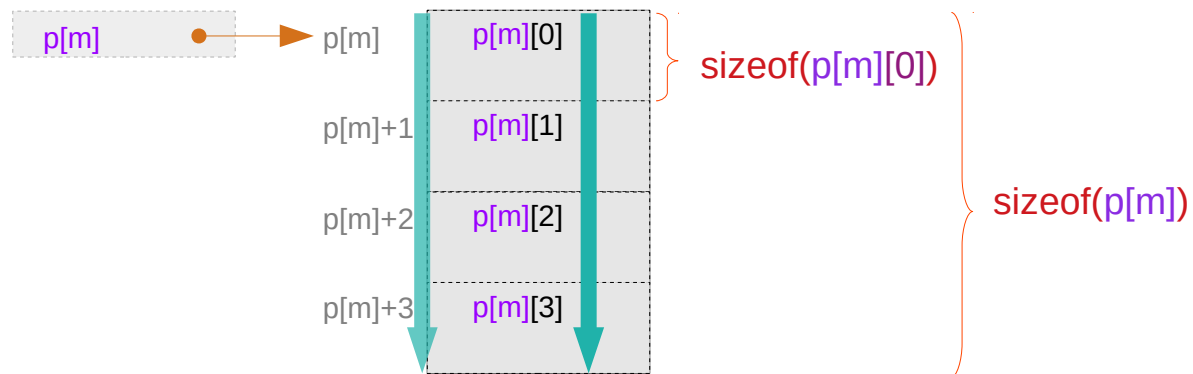

can be recursively applied

# Equivalence for a given p[m][n]

$$*(p[m][n]+k) \iff p[m][n][k]$$

for a given `p[m][n]` contiguous index : `k`

`atype * p[M][4][2]`; contiguous `p[m][n][k]` for a given `p[m][n]` : **abstract data types**  $m = 0, 1, \dots, M-1$

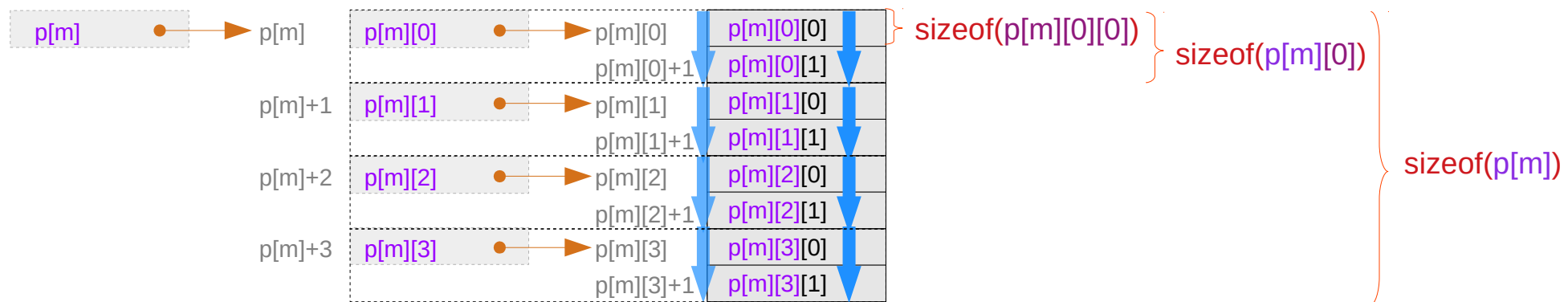



# Contiguity constraints in multi-dimensional arrays

$$*(p[m]+n) \iff p[m][n]$$

for a given  $p[m]$ , thus for a given  $p$  and  $m$ ,  
 $p[m][n]$ 's must be contiguous for all  $n$ .  
 $p[m][0], p[m][1], \dots, p[m][N-1]$

contiguous index :  $n$

$$*(p+m) \iff p[m]$$

for a given  $p$ ,  
 $p[m]$ 's must be contiguous for all  $m$ .  
 $p[0], p[1], \dots, p[M-1]$

contiguous index :  $m$

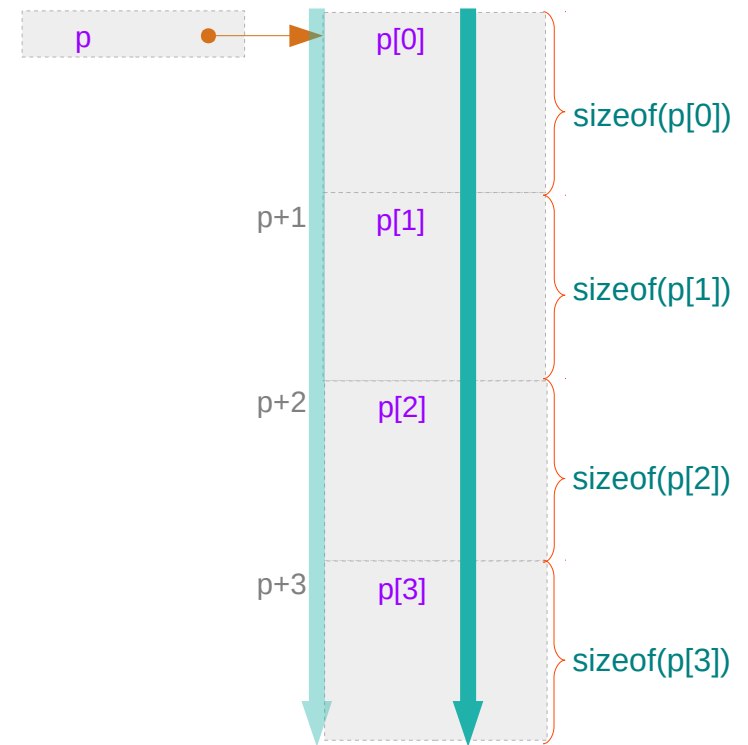
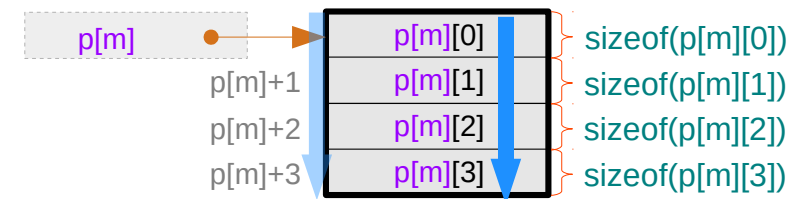

# Contiguity constraints for p

$$*(p+m) \iff p[m]$$

for a given  $p$  contiguous index :  $m$

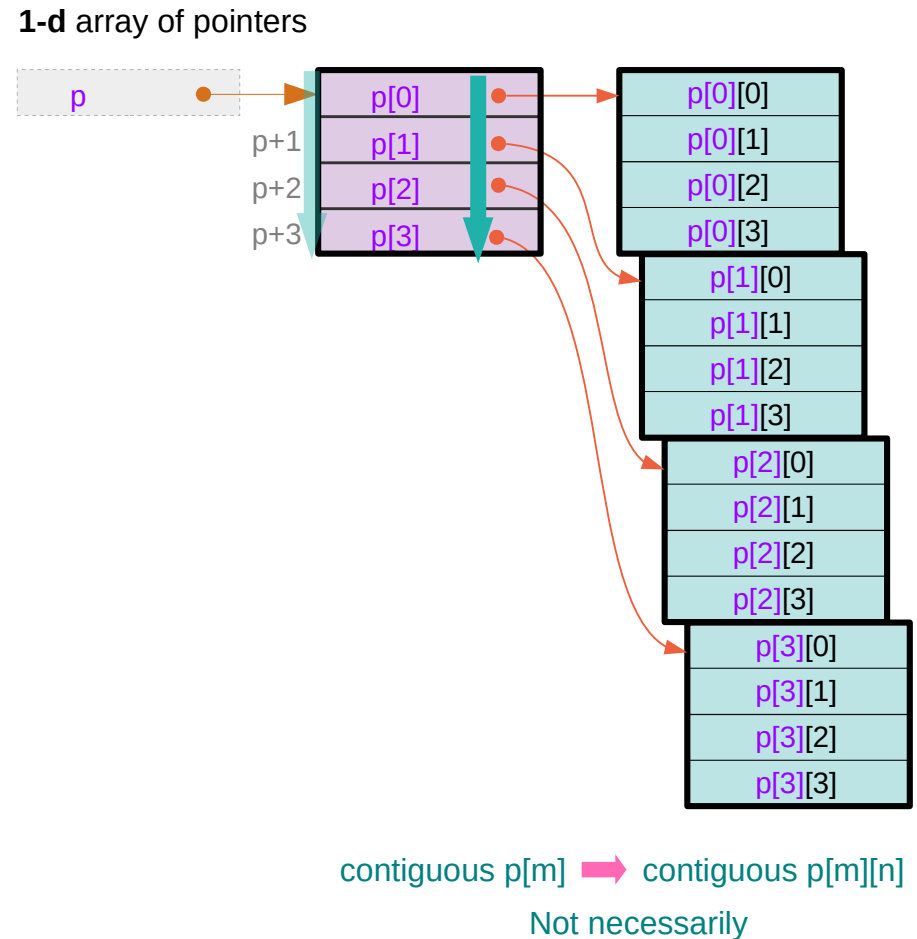
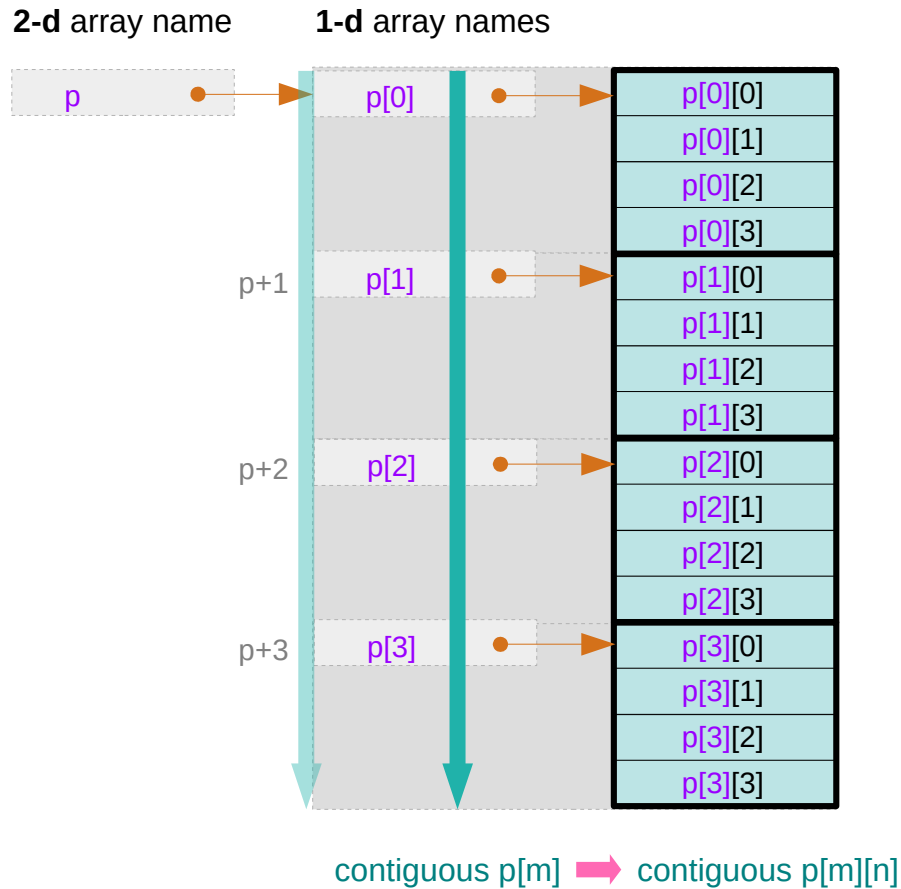

# Contiguity constraints for p[m] – using array pointers

$$*(p[m]+n) \iff p[m][n]$$

for a given  $p[m]$  contiguous index :  $n$

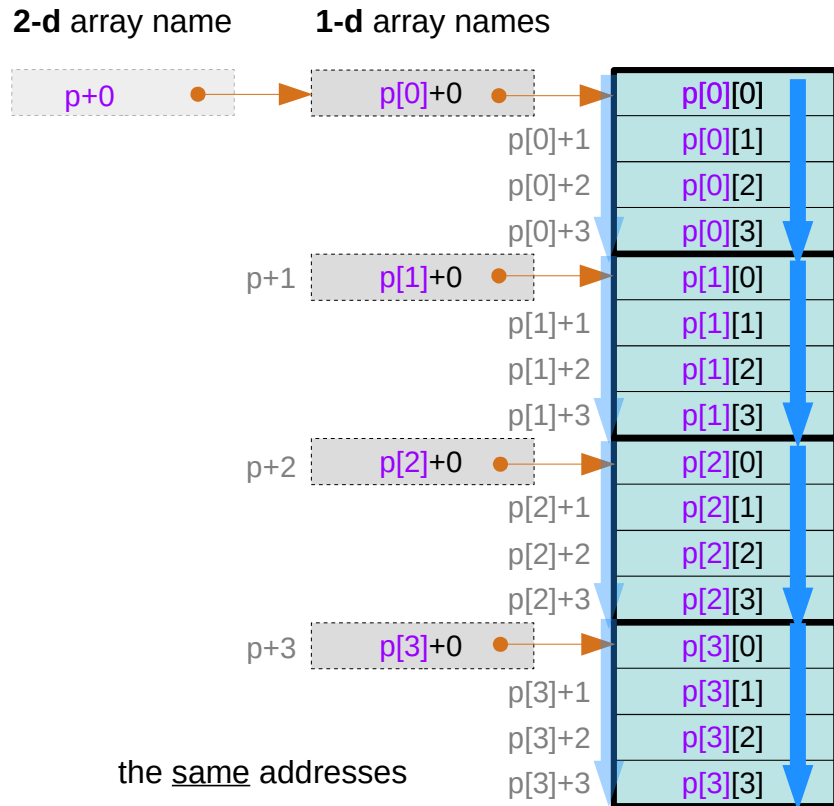

$$p[0][0] = *(p[0]+0) \xrightarrow{\text{addr}} \underbrace{\&p[0][0] = p[0]}_{\text{addr}} \xrightarrow{\text{addr}} p+0$$

$$p[1][0] = *(p[1]+0) \xrightarrow{\text{addr}} \underbrace{\&p[1][0] = p[1]}_{\text{addr}} \xrightarrow{\text{addr}} p+1$$

$$p[2][0] = *(p[2]+0) \xrightarrow{\text{addr}} \underbrace{\&p[2][0] = p[2]}_{\text{addr}} \xrightarrow{\text{addr}} p+2$$

$$p[3][0] = *(p[3]+0) \xrightarrow{\text{addr}} \underbrace{\&p[3][0] = p[3]}_{\text{addr}} \xrightarrow{\text{addr}} p+3$$

the same addresses

contiguous  $p[m]$   $\rightarrow$  contiguous  $p[m][n]$

virtual array pointer  $\iff$  no real memory locations

# Contiguity constraints for p[m] – using pointer arrays

$$*(p[m]+n) \iff p[m][n]$$

for a given  $p[m]$  contiguous index :  $n$

1-d array of pointers

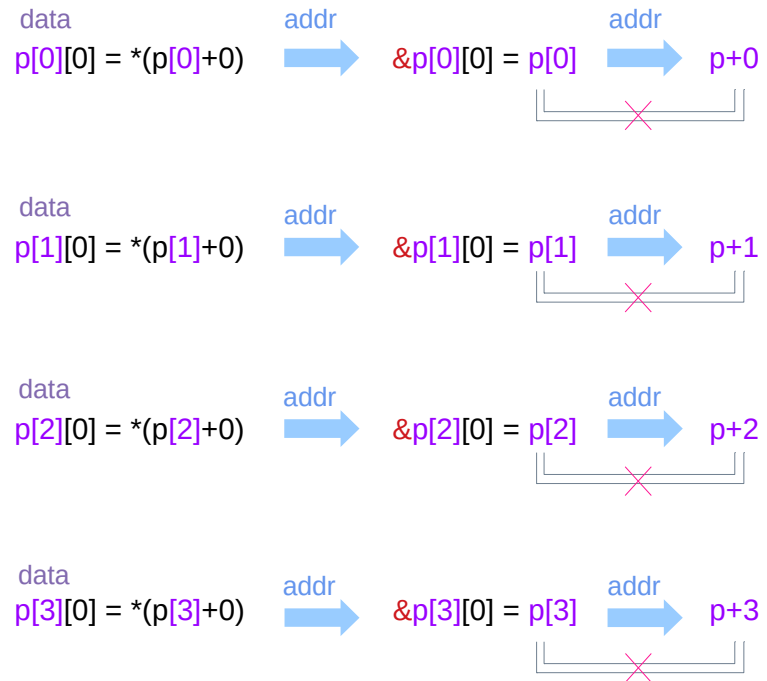
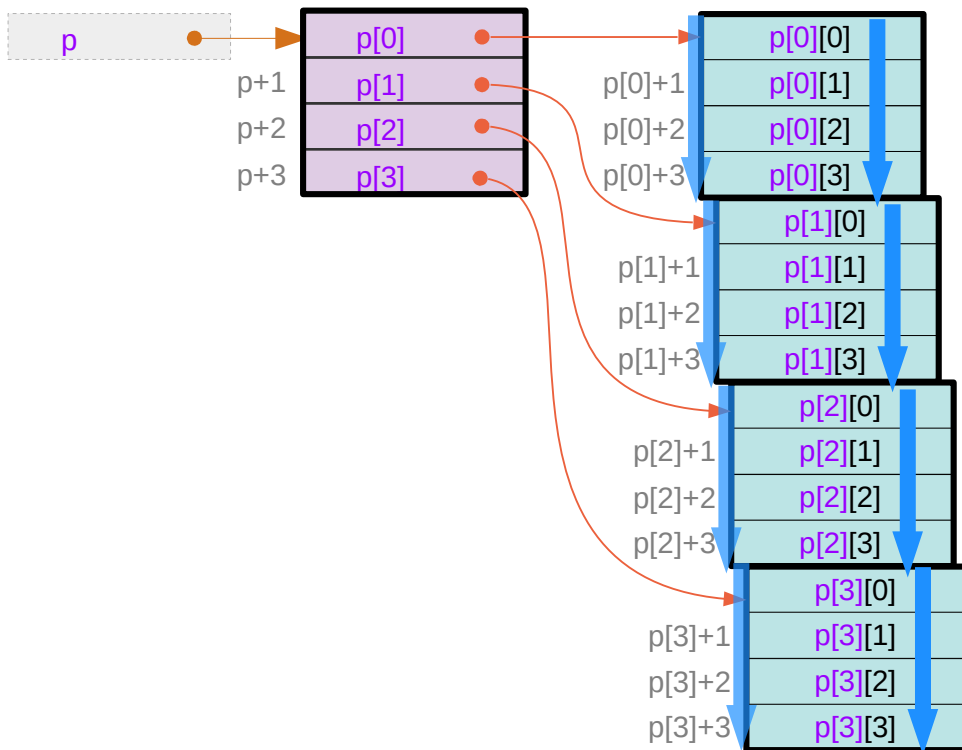

the different addresses

contiguous  $p[m]$   $\implies$  contiguous  $p[m][n]$   
Not necessarily

# Contiguity constraints for 2-d arrays

```
int a[M][N] ;
```

$*(a+m) \leftrightarrow a[m]$

$a[0], a[1], \dots, a[M-1]$   
are contiguous

$*(a[m]+n) \leftrightarrow a[m][n]$

$a[m][0], a[m][1], \dots, a[m][N-1]$   
are contiguous

```
int (*b)[N] ;
```

$*(b+m) \leftrightarrow b[m]$

$b[0], b[1], \dots, b[M-1]$   
are contiguous

$*(b[m]+n) \leftrightarrow b[m][n]$

$b[m][0], b[m][1], \dots, b[m][N-1]$   
are contiguous

```
int * c[M] ;
```

$*(c+m) \leftrightarrow c[m]$

$c[0], c[1], \dots, c[M-1]$   
are contiguous

$*(c[m]+n) \leftrightarrow c[m][n]$

$c[m][0], c[m][1], \dots, c[m][N-1]$   
are contiguous

a set of assignments of pointers  
are necessary for this contiguity

# Pointer Arrays vs Array Pointers

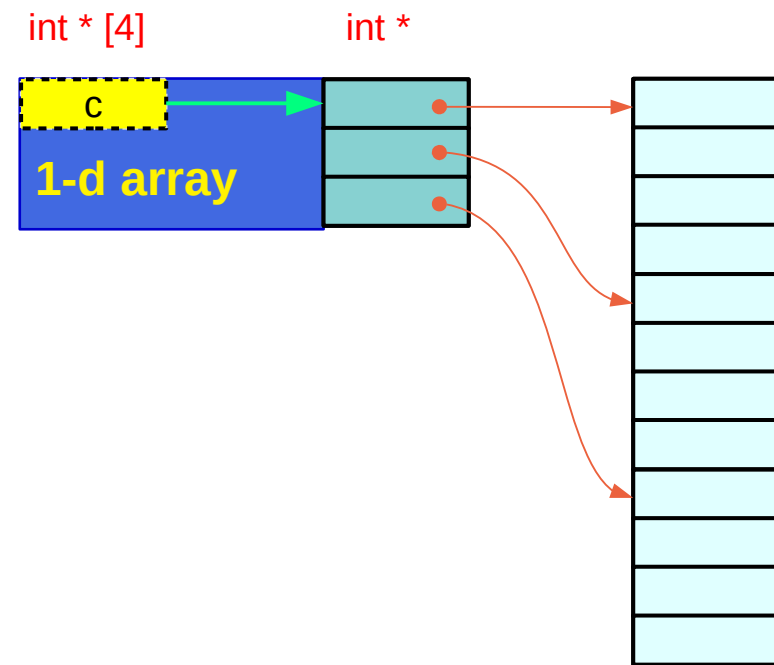
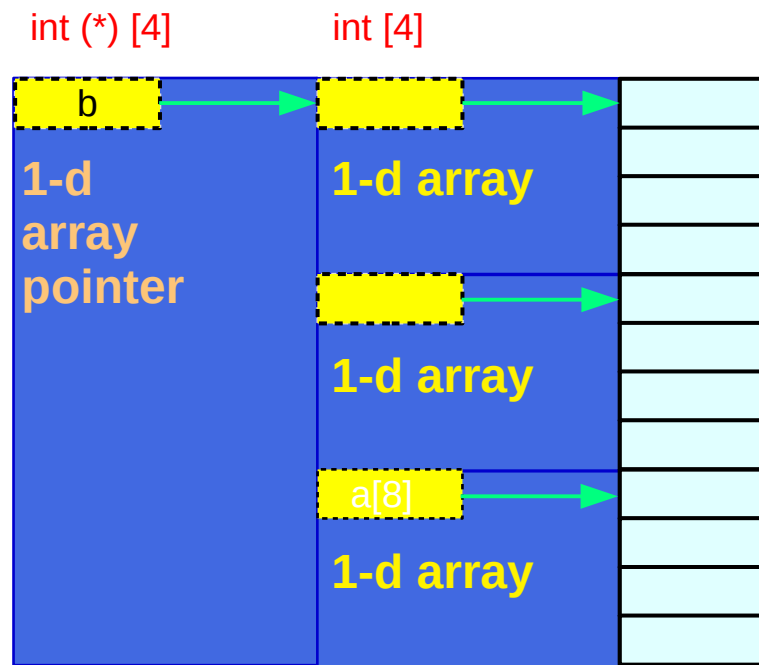

`int (*b)[N] ;`

`int * c[M] ;`

with proper assignments

`*(b+m)`     $\longleftrightarrow$     `b[m]`  
`*(b[m]+n)`     $\longleftrightarrow$     `b[m][n]`

`*(c+m)`     $\longleftrightarrow$     `c[m]` or  
`*(c[m]+n)`     $\longleftrightarrow$     `c[m][n]`

# Pointer Arrays vs Array Pointers

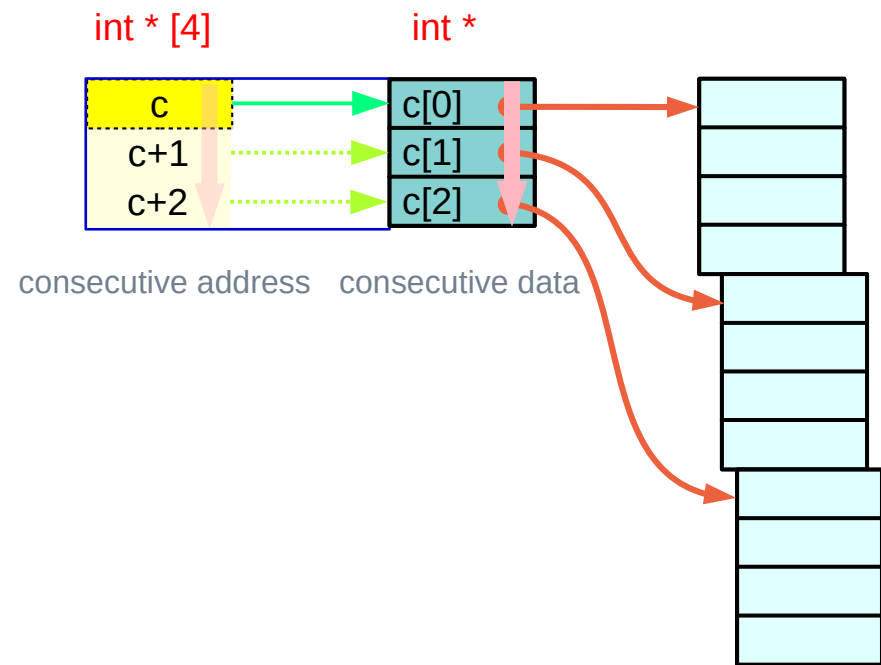
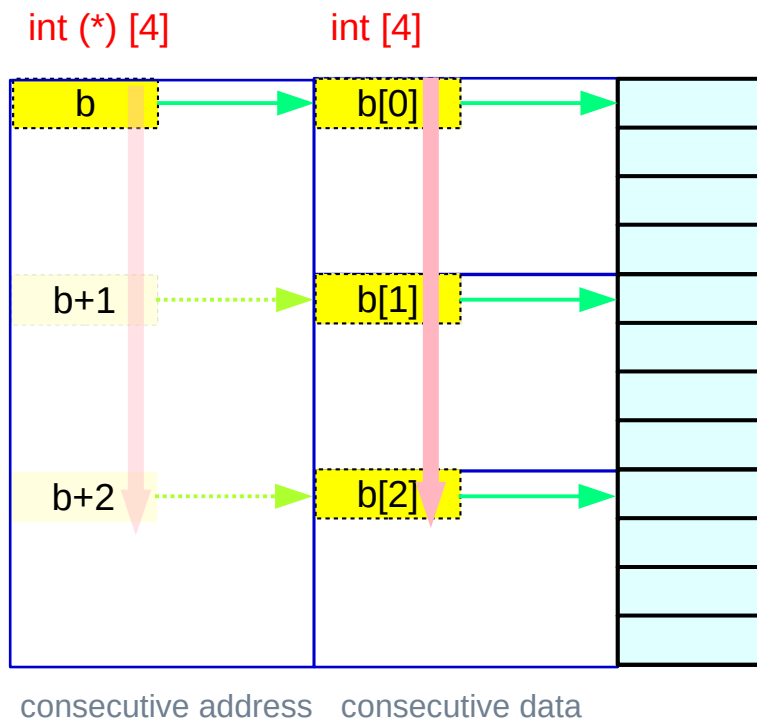

```
int (*b)[N] ;
```

$*(b+m)$        $\longleftrightarrow$        $b[m]$   
 $*(b[m]+n)$        $\longleftrightarrow$        $b[m][n]$

```
int * c[M] ;
```

with proper assignments

$*(c+m)$        $\longleftrightarrow$        $c[m]$  or  
 $*(c[m]+n)$        $\longleftrightarrow$        $c[m][n]$

# Pointer Arrays vs Array Pointers

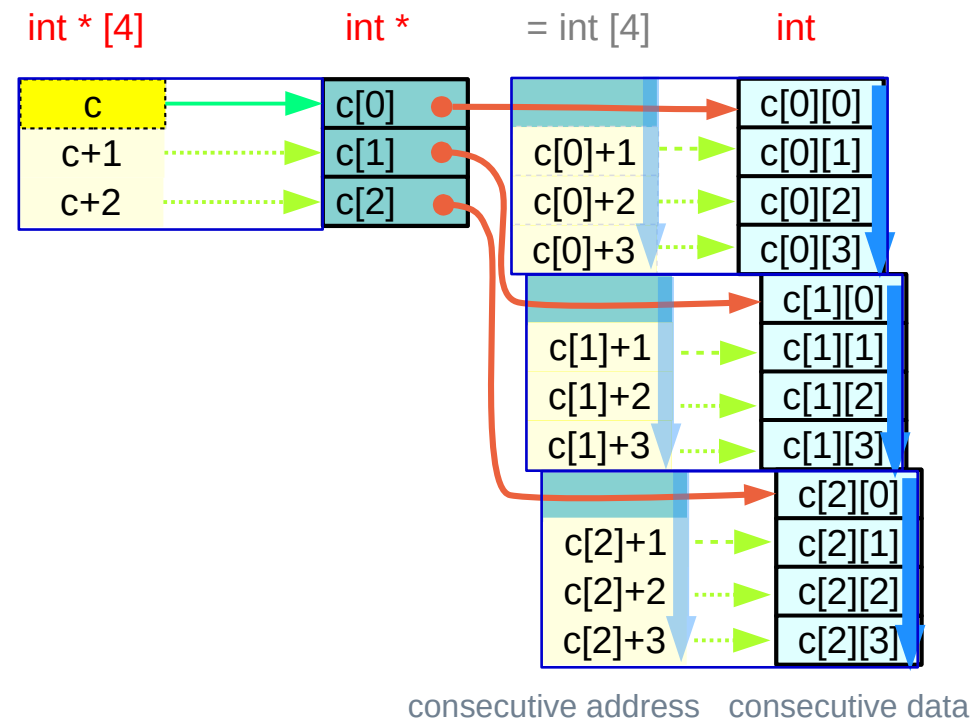
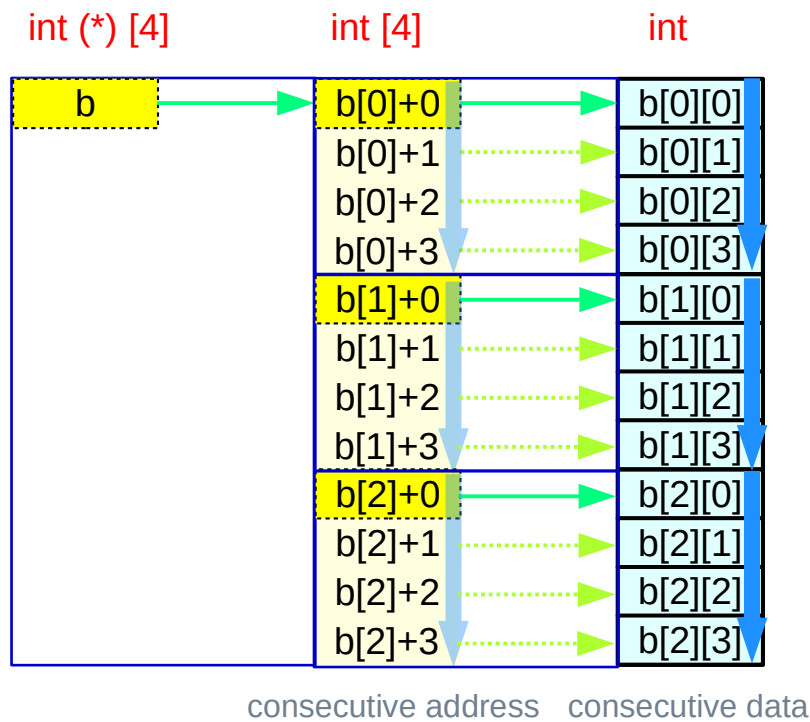

```
int (*b)[N] ;
```

```
int * c[M] ;      with proper assignments
```

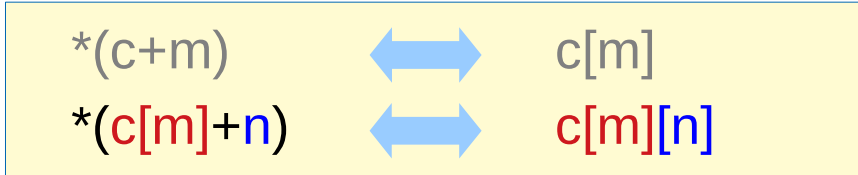



# Three contiguity constraints for 3-d arrays

## Pointer Array Approach (array of pointers)

$c[i][j][k]$        $\rightarrow$      $*(c[i][j] + k)$   
 $*(c[i][j] + k)$      $\rightarrow$      $*(*(c[i] + j) + k)$   
 $*(*(c[i] + j) + k)$   $\rightarrow$   $*(**(*c + i) + j) + k)$

contiguous **int**                                    **int**  
contiguous pointers to **int**                    **int \***  
contiguous double pointers to **int**          **int \*\***

the contiguity constraints are satisfied by allocating arrays of pointers

## Array Pointer Approach (pointer to arrays)

$c[i][j][k]$        $\rightarrow$      $*(c[i][j] + k)$   
 $*(c[i][j] + k)$      $\rightarrow$      $*(*(c[i] + j) + k)$   
 $*(*(c[i] + j) + k)$   $\rightarrow$   $*(**(*c + i) + j) + k)$

contiguous **0-d** arrays    **int**                                    **int**  
contiguous **1-d** arrays    **int [4]**                                    **int \***  
contiguous **2-d** arrays    **int [3][4]**                                **int (\*) [4]**

The contiguity constraints are satisfied by row major ordered linear data layout

# Contiguous array pointers $c[i][j][k] \equiv *(c[i][j] + k)$

```

c[0][0][0] = *(c[0][0] + 0)
c[0][0][1] = *(c[0][0] + 1)
c[0][0][2] = *(c[0][0] + 2)
c[0][0][3] = *(c[0][0] + 3)
c[0][1][0] = *(c[0][1] + 0)
c[0][1][1] = *(c[0][1] + 1)
c[0][1][2] = *(c[0][1] + 2)
c[0][1][3] = *(c[0][1] + 3)

```

• •  
• •

contiguous 1-d  
array elements

$c[i][j]$   
**int [4]** 4 contiguous 0-d arrays  
**int \*** points to the 1<sup>st</sup> 0-d array  
**int** 0-d array

$\text{sizeof}(c[i][j])$  [k]  
 $\text{sizeof}(c[i][j][k]) * 4$   
 $\text{sizeof}(\text{int}) * 4$

```
int c[2][3][4];
```

Address Value  
 $c[i][j] + k$   
 $\&c[i][j][0] + k * \text{sizeof}(*c[i][j])$   
 $\&c[i][j][0] + k * \text{sizeof}(c[i][j][0])$   
 $\&c[i][j][0] + k * 4$

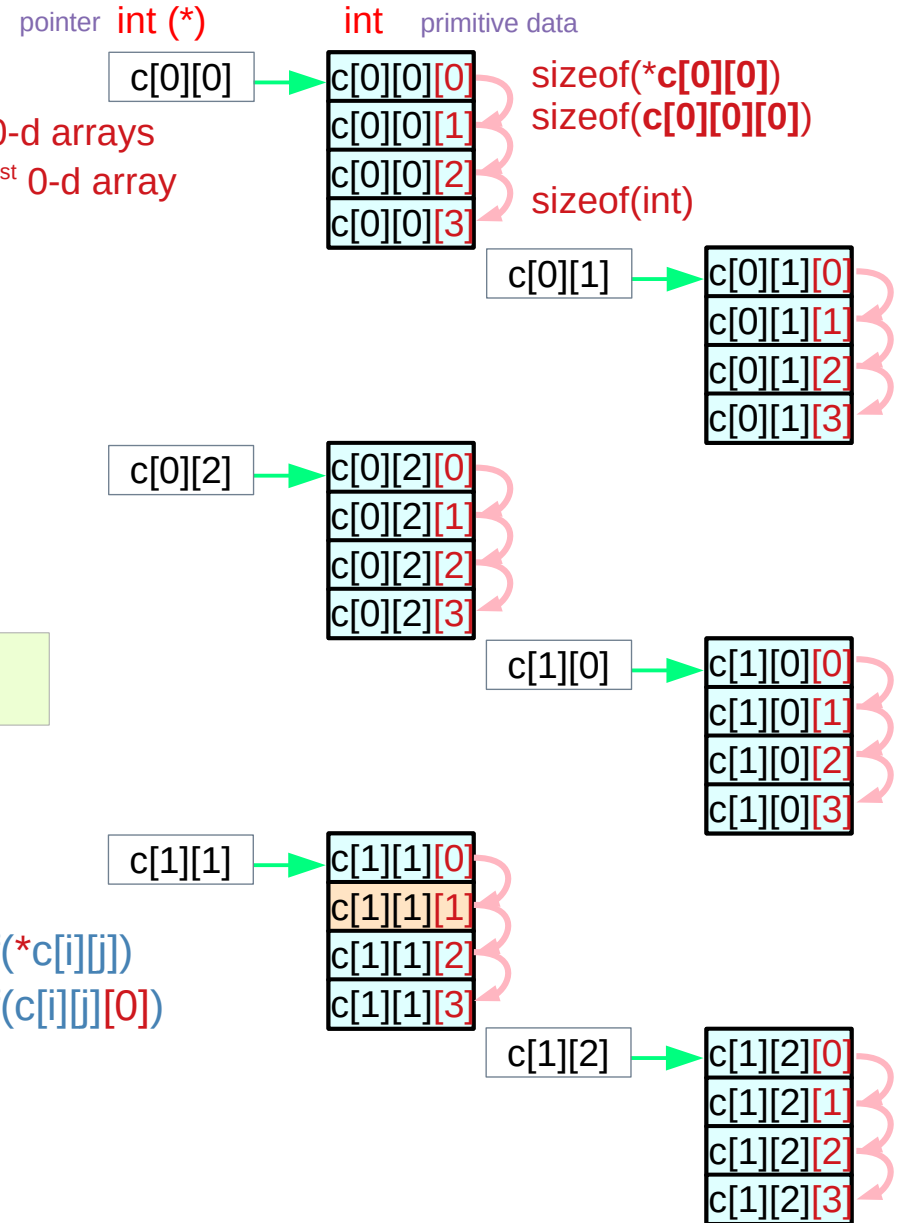

# Contiguous array pointers $c[i][j] \equiv *(c[i] + j)$

```

c[0][0] = *(c[0] + 0)
c[0][1] = *(c[0] + 1)
c[0][2] = *(c[0] + 2)
c[1][0] = *(c[1] + 0)
c[1][1] = *(c[1] + 1)
c[1][2] = *(c[1] + 2)
    
```

**c[i]**  
**int [3][4]** 3 contiguous 1-d arrays  
**int (\*) [4]** points to the 1<sup>st</sup> 1-d array  
**int [4]** 1-d array

sizeof(c[i]) [j] [k]  
 sizeof(c[i][j][k]) \* 3 \* 4  
 sizeof(int) \* 3 \* 4

```
int c[2][3][4];
```

Address Value

$c[i] + j$

$\&c[i][0][0] + j * \text{sizeof}(*c[i])$

$\&c[i][0][0] + j * \text{sizeof}(c[i][0])$

$\&c[i][0][0] + j * 4 * 4$

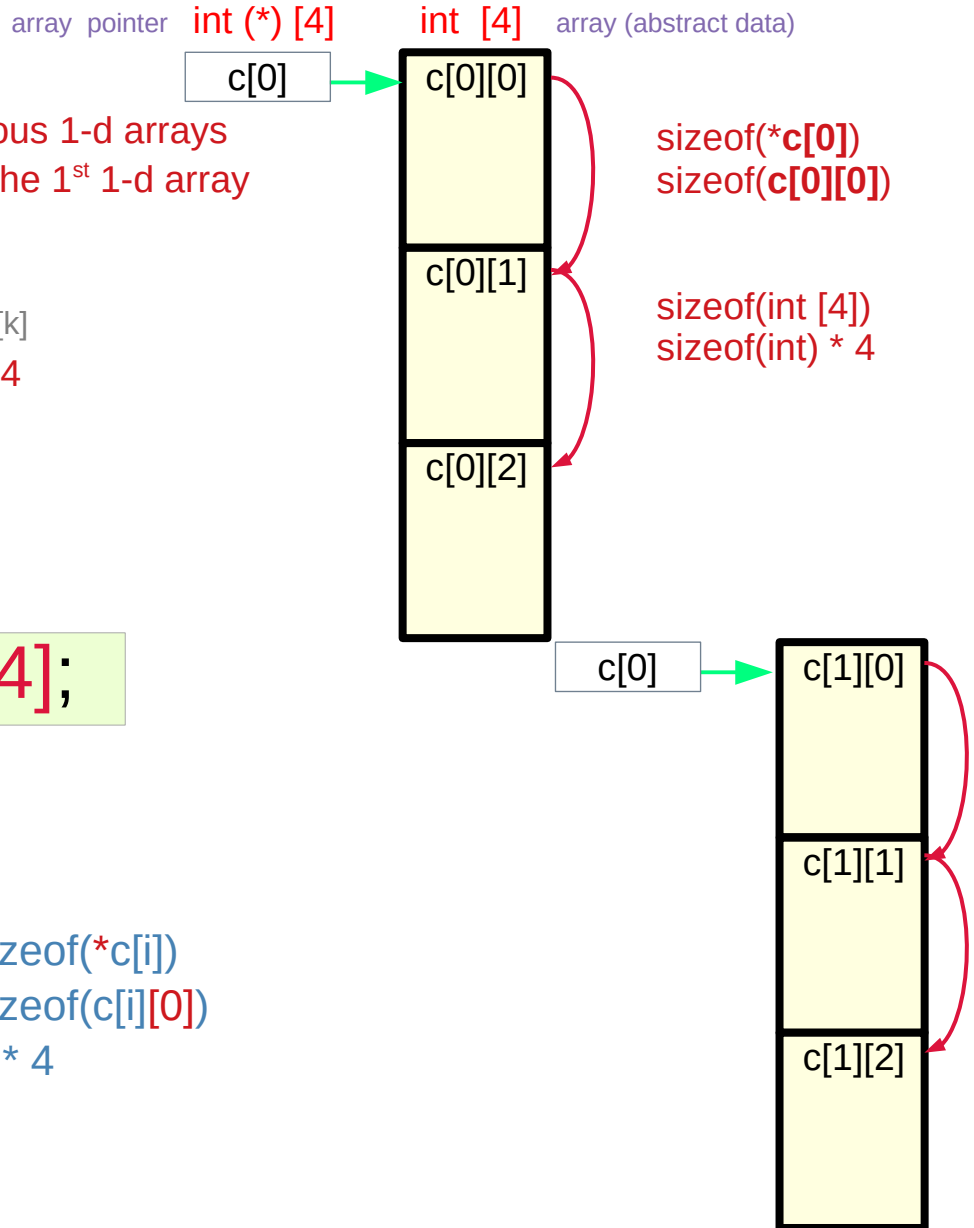

# Contiguous array pointers $c[i] \equiv *(c + i)$

```
c[0] = *(c + 0)
c[1] = *(c + 1)
```

```
c
int [2][3][4]
int (*) [3][4]
int [3][4]
```

2 contiguous 2-d arrays  
points to the 1<sup>st</sup> 2-d array  
2-d array

```
sizeof(c)           [i] [j] [k]
sizeof(c[i][j][k]) * 2 * 3 * 4
sizeof(int) * 2 * 3 * 4
```

```
int c[2][3][4];
```

Address Value

```
c + i
&c[0][0][0] + i * sizeof(*c)
&c[0][0][0] + i * sizeof(c[0])
&c[0][0][0] + i * 4 * 3 * 4
```

array pointer  $int (*) [3][4]$   $int [3][4]$  array (abstract data)

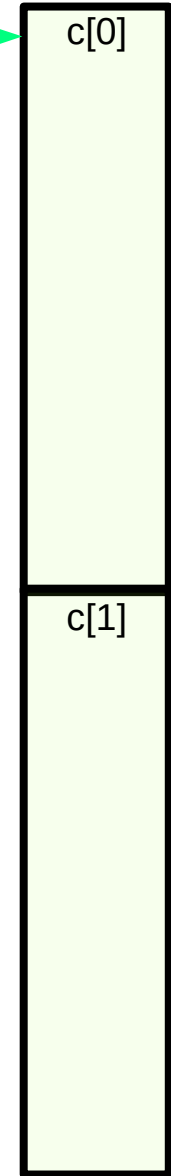
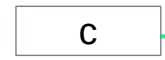

sizeof(\*c)  
sizeof(c[0])

sizeof(int [3][4])  
sizeof(int) \* 3 \* 4

# Subarrays in a 3-d array

**1-d subarrays**

int [4]	int
c[0][0]	c[0][0][0]
	c[0][0][1]
	c[0][0][2]
	c[0][0][3]
c[0][1]	c[0][1][0]
	c[0][1][1]
	c[0][1][2]
	c[0][1][3]
c[0][2]	c[0][2][0]
	c[0][2][1]
	c[0][2][2]
	c[0][2][3]
c[1][0]	c[1][0][0]
	c[1][0][1]
	c[1][0][2]
	c[1][0][3]
c[1][1]	c[1][1][0]
	c[1][1][1]
	c[1][1][2]
	c[1][1][3]
c[1][2]	c[1][2][0]
	c[1][2][1]
	c[1][2][2]
	c[1][2][3]

**2-d subarrays**

int [3][4]	int [4]	int	
c[0]	c[0][0]	c[0][0][0]	
		c[0][0][1]	
		c[0][0][2]	
		c[0][0][3]	
	c[0][1]	c[0][1]	c[0][1][0]
			c[0][1][1]
			c[0][1][2]
			c[0][1][3]
	c[0][2]	c[0][2]	c[0][2][0]
			c[0][2][1]
			c[0][2][2]
			c[0][2][3]
c[1]	c[1][0]	c[1][0][0]	
		c[1][0][1]	
		c[1][0][2]	
		c[1][0][3]	
	c[1][1]	c[1][1]	c[1][1][0]
			c[1][1][1]
			c[1][1][2]
			c[1][1][3]
	c[1][2]	c[1][2]	c[1][2][0]
			c[1][2][1]
			c[1][2][2]
			c[1][2][3]

**3-d array**

int [2][3][4]	int [3][4]	int [3]	int	
c	c[0]	c[0][0]	c[0][0][0]	
			c[0][0][1]	
			c[0][0][2]	
			c[0][0][3]	
	c[0][1]	c[0][1]	c[0][1]	c[0][1][0]
				c[0][1][1]
				c[0][1][2]
				c[0][1][3]
	c[0][2]	c[0][2]	c[0][2]	c[0][2][0]
				c[0][2][1]
				c[0][2][2]
				c[0][2][3]
c[1]	c[1]	c[1][0]	c[1][0][0]	
			c[1][0][1]	
			c[1][0][2]	
			c[1][0][3]	
	c[1][1]	c[1][1]	c[1][1]	c[1][1][0]
				c[1][1][1]
				c[1][1][2]
				c[1][1][3]
	c[1][2]	c[1][2]	c[1][2]	c[1][2][0]
				c[1][2][1]
				c[1][2][2]
				c[1][2][3]

# Contiguous linear layout

```
int c [L][M][N];
```

```
C [i][j][k];
```

L	M	N
i	j	k
$i * M * N$	$j * N$	k

Base Index = 0

Offset Index 1 (i=1)

Offset Index 2 (j=1)

Offset Index 3 (k=1)

$$(i * M * N + j * N + k)$$

$$((i * M + j) * N + k)$$

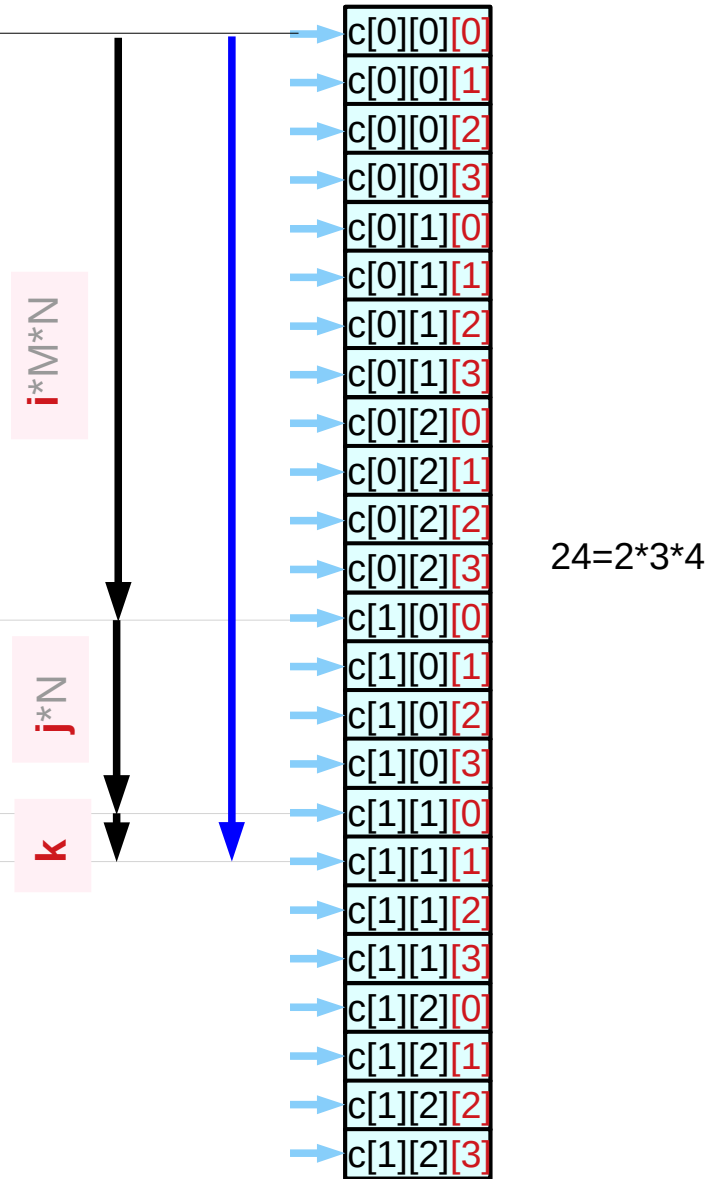

# Base and Offset Addressing

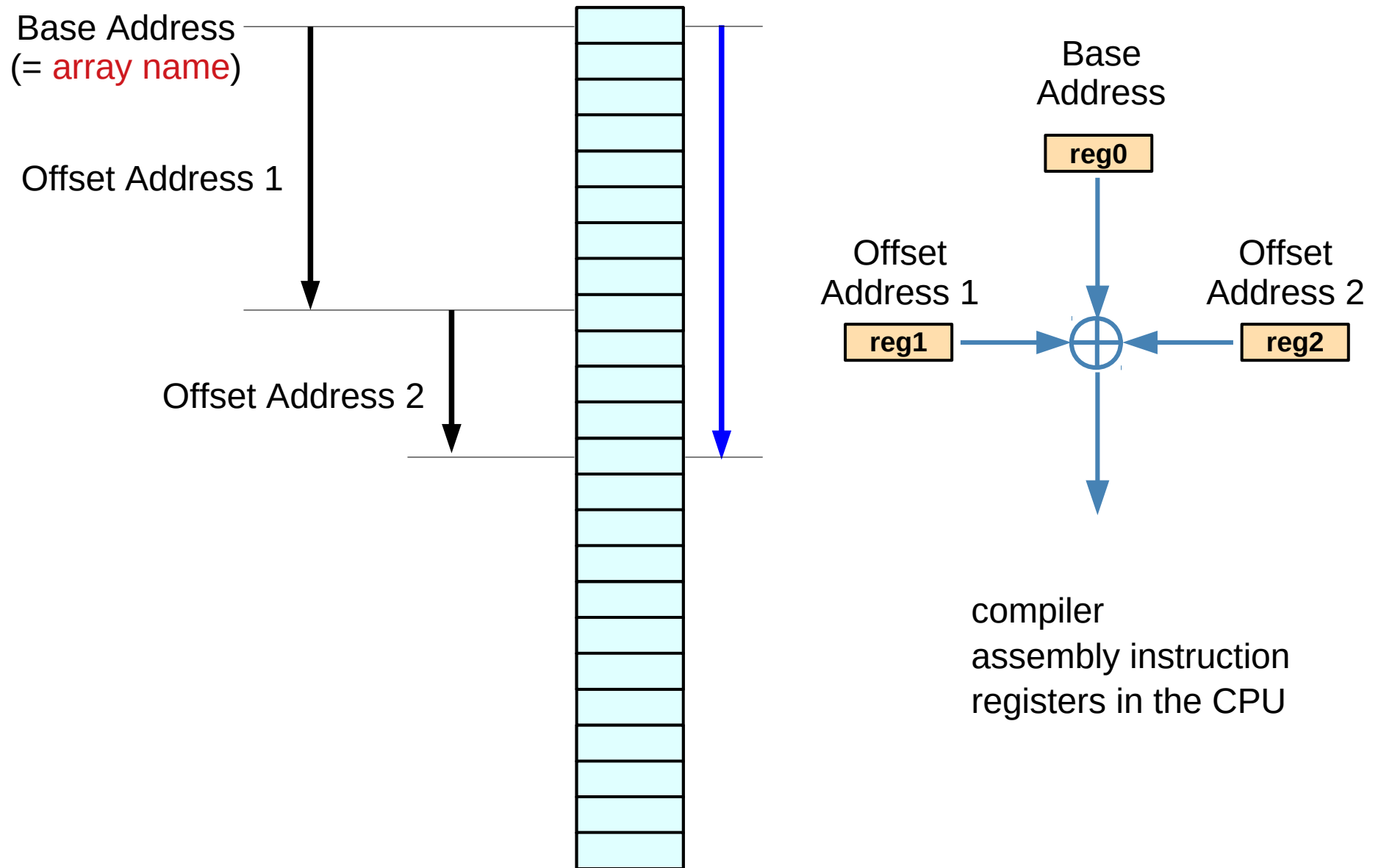

# Array Pointer Approach

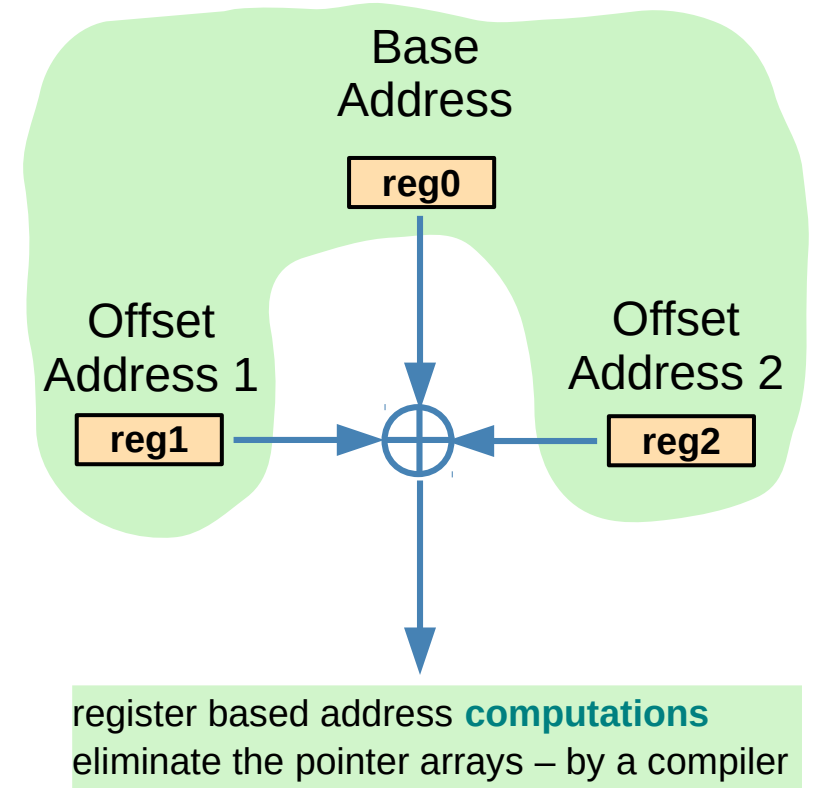
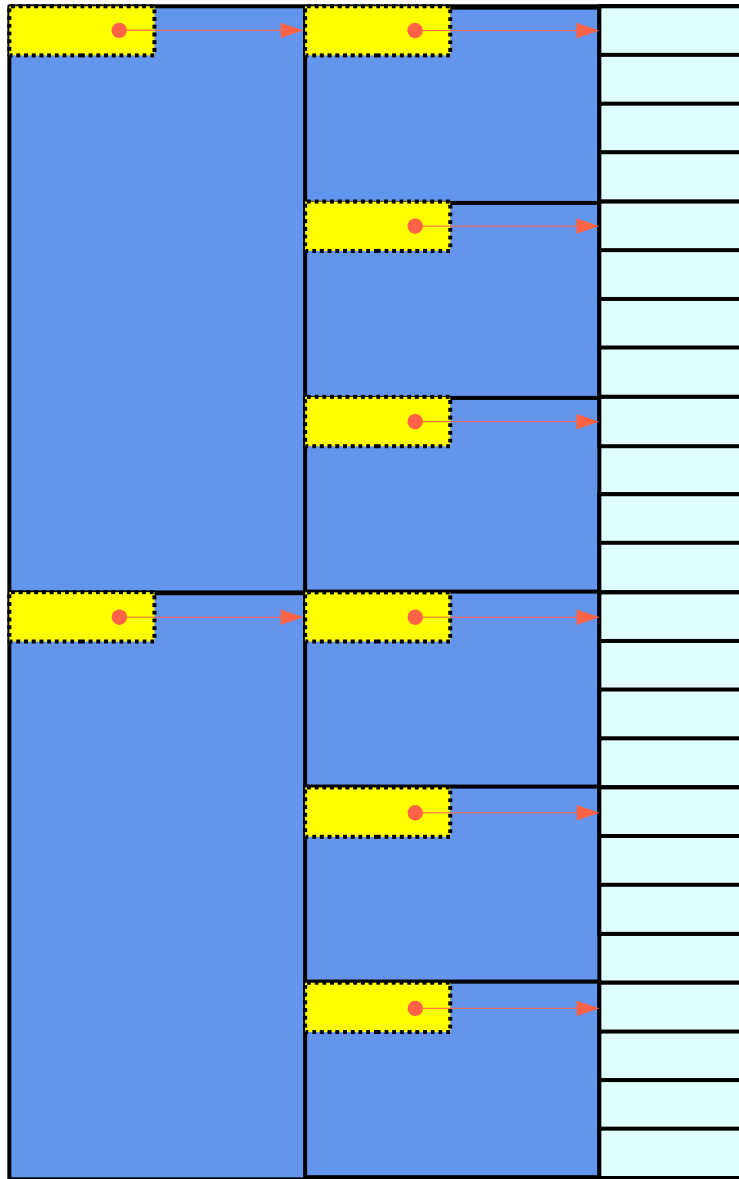

**Array Pointer Approach**  
**(pointer to arrays)**



## References

- [1] Essential C, Nick Parlante
- [2] Efficient C Programming, Mark A. Weiss
- [3] C A Reference Manual, Samuel P. Harbison & Guy L. Steele Jr.
- [4] C Language Express, I. K. Chun