

# Fourier Integrals (3A)

---

- Continuous Time Fourier Transform

Copyright (c) 2009 Young W. Lim.

Permission is granted to copy, distribute and/or modify this document under the terms of the GNU Free Documentation License, Version 1.2 or any later version published by the Free Software Foundation; with no Invariant Sections, no Front-Cover Texts, and no Back-Cover Texts. A copy of the license is included in the section entitled "GNU Free Documentation License".

Please send corrections (or suggestions) to [youngwlim@hotmail.com](mailto:youngwlim@hotmail.com).

This document was produced by using OpenOffice and Octave.

# CTFT of a Rect(t/T) function (1)

## Continuous Time Fourier Transform

Aperiodic Continuous Time Signal

$$X(j\omega) = \int_{-\infty}^{+\infty} x(t) e^{-j\omega t} dt \quad \longleftrightarrow \quad x(t) = \frac{1}{2\pi} \int_{-\infty}^{+\infty} X(j\omega) e^{+j\omega t} d\omega$$

$$\begin{aligned} X(j\omega) &= \int_{-T/2}^{+T/2} e^{-j\omega t} dt \\ &= \left[ \frac{-1}{j\omega} e^{-j\omega t} \right]_{-T/2}^{+T/2} = -\frac{e^{-j\omega T/2} - e^{+j\omega T/2}}{j\omega} \\ &= \frac{\sin(\omega T/2)}{\omega/2} \end{aligned}$$

$$X(j0) = \lim_{\omega \rightarrow 0} \frac{\sin(\omega T/2)}{\omega/2} = \lim_{\omega \rightarrow 0} \frac{T \cos(\omega T/2)}{2 \cdot 1/2} = T$$

$$\sin(\omega T/2) = 0 \quad \rightarrow \quad \omega T/2 = \pi n$$

$$\rightarrow \quad \omega = \frac{2\pi}{T} n$$

$$\rightarrow \quad \omega = \pm \frac{2\pi}{T}, \pm \frac{4\pi}{T}, \pm \frac{6\pi}{T}, \dots$$

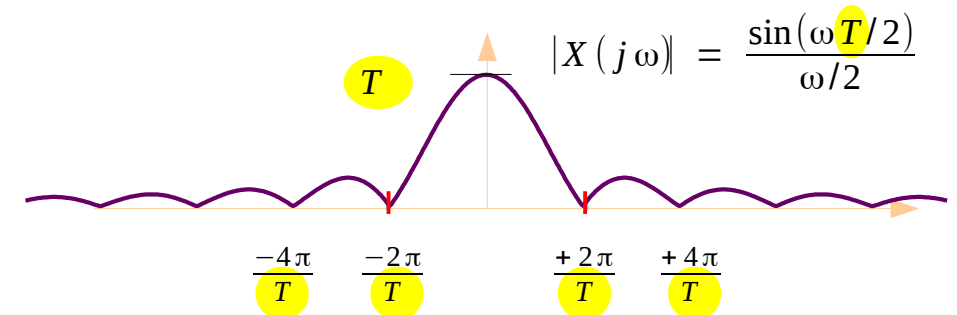
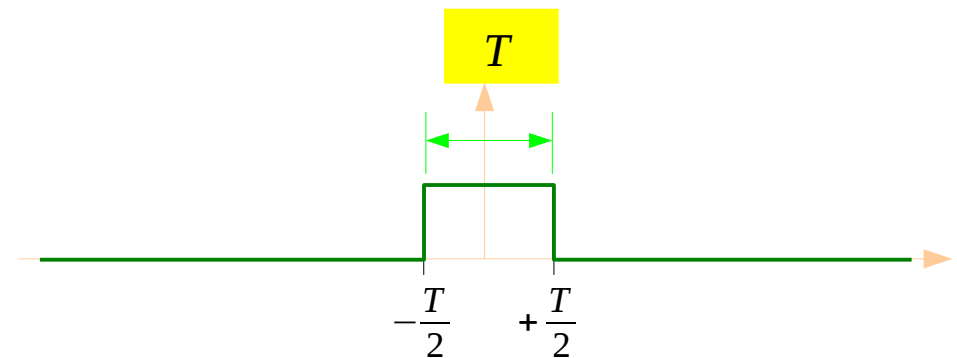

# CTFT of a Rect(t/T) function (2)

## Continuous Time Fourier Transform

Aperiodic Continuous Time Signal

$$X(j\omega) = \int_{-\infty}^{+\infty} x(t) e^{-j\omega t} dt \quad \longleftrightarrow \quad x(t) = \frac{1}{2\pi} \int_{-\infty}^{+\infty} X(j\omega) e^{+j\omega t} d\omega$$

$$X(j\omega) = \int_{-T/2}^{+T/2} e^{-j\omega t} dt = \frac{\sin(\omega T/2)}{\omega/2}$$

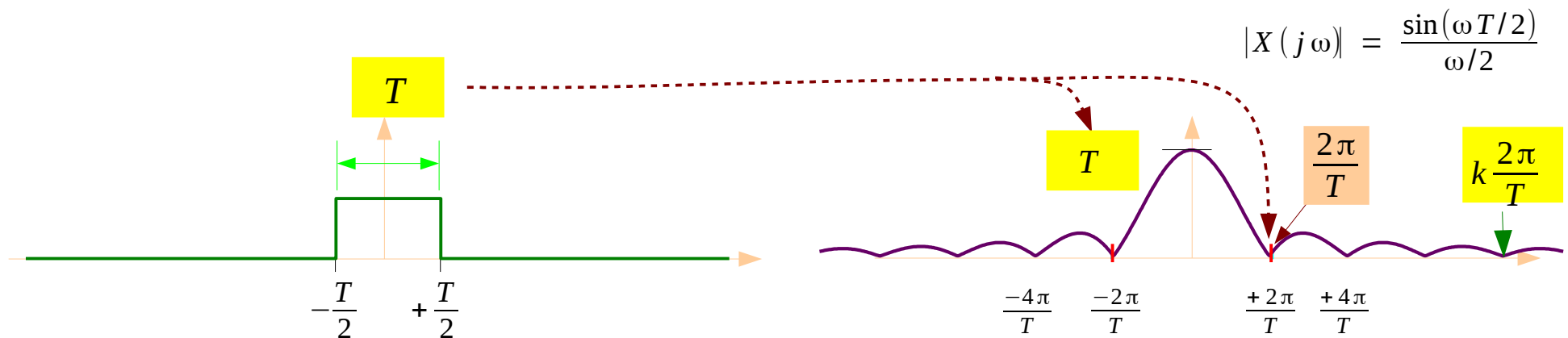

# CTFT and CTFS

## Continuous Time Fourier Transform

## Aperiodic Continuous Time Signal

$$X(j\omega) = \int_{-\infty}^{+\infty} x(t) e^{-j\omega t} dt \quad \longleftrightarrow \quad x(t) = \frac{1}{2\pi} \int_{-\infty}^{+\infty} X(j\omega) e^{+j\omega t} d\omega$$

$$X(j\omega) = \frac{\sin(\omega T/2)}{\omega/2}$$

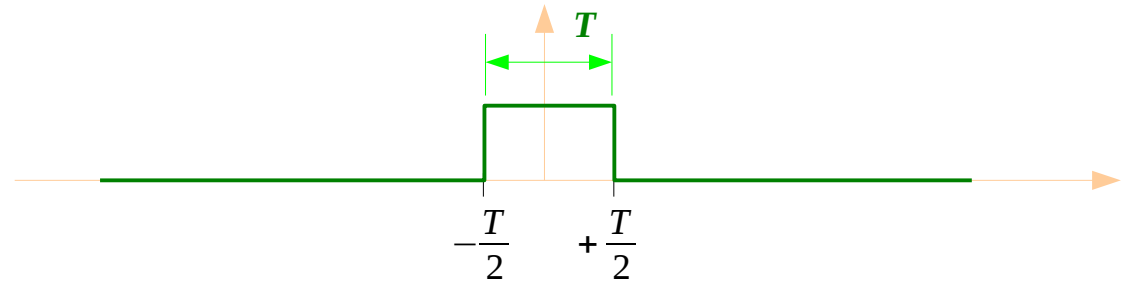

## Continuous Time Fourier Series

## Periodic Continuous Time Signal

$$C_k = \frac{1}{T} \int_0^T x(t) e^{-jk\omega_0 t} dt \quad \longleftrightarrow \quad x(t) = \sum_{k=-\infty}^{\infty} C_k e^{+jk\omega_0 t}$$

$$C_k = \frac{1}{T_0} \frac{\sin(k\omega_0 T/2)}{k\omega_0/2}$$

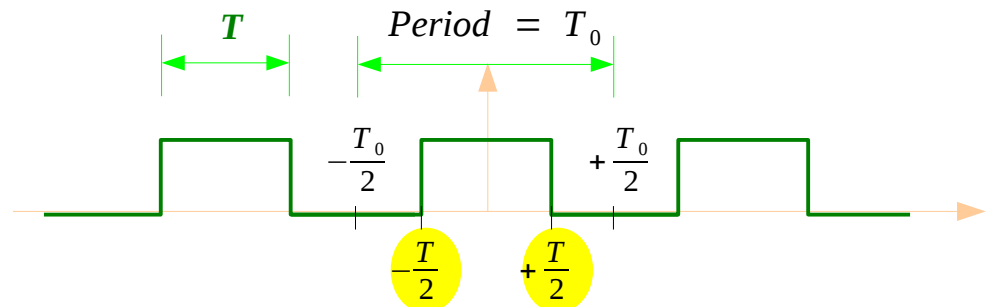

# CTFT ← CTFS

## Aperiodic Continuous Time Signal Continuous Time Fourier Transform

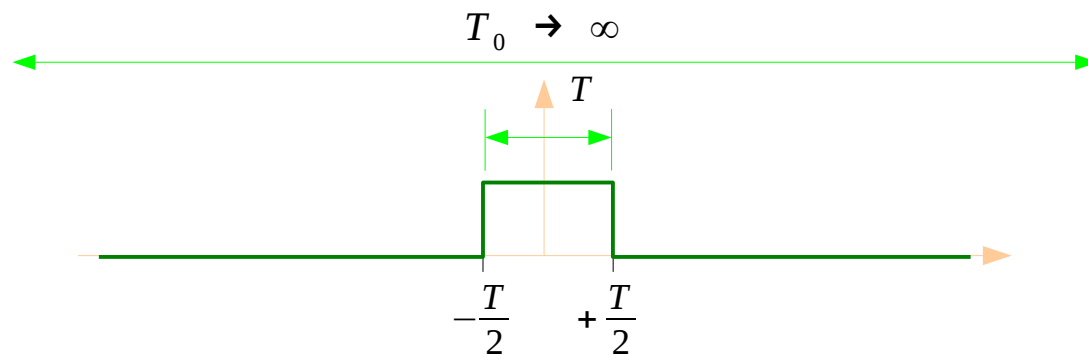

## Periodic Continuous Time Signal Continuous Time Fourier Series

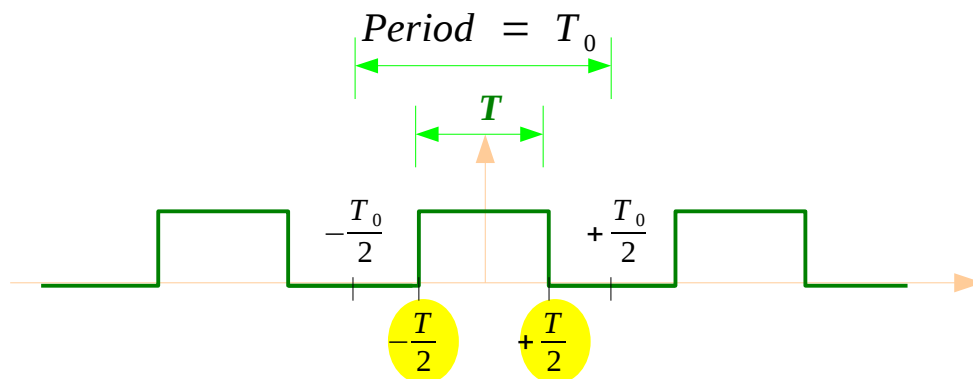

$$x(t)$$

As  $T_0 \rightarrow \infty$ ,

$$x_{T_0}(t) \rightarrow x(t)$$

$$\omega_0 = \frac{2\pi}{T_0} \rightarrow 0$$

$$x_{T_0}(t) = \sum_{n=-\infty}^{+\infty} x(t - nT_0)$$

# CTFT and CTFS as $T_0 \rightarrow \infty$ (1)

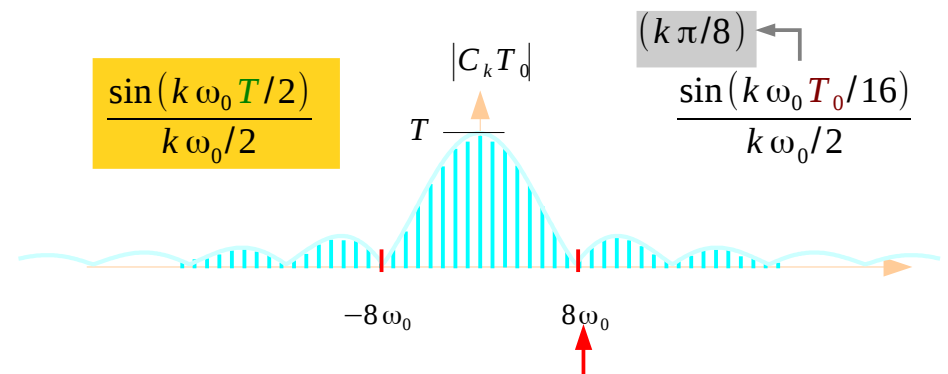
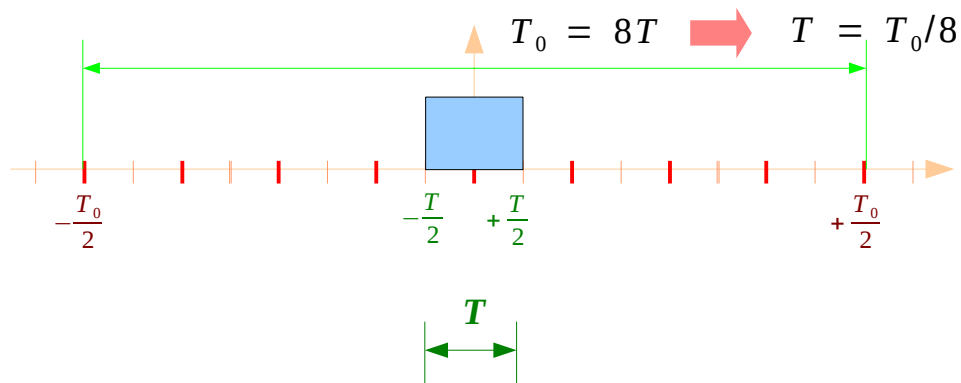
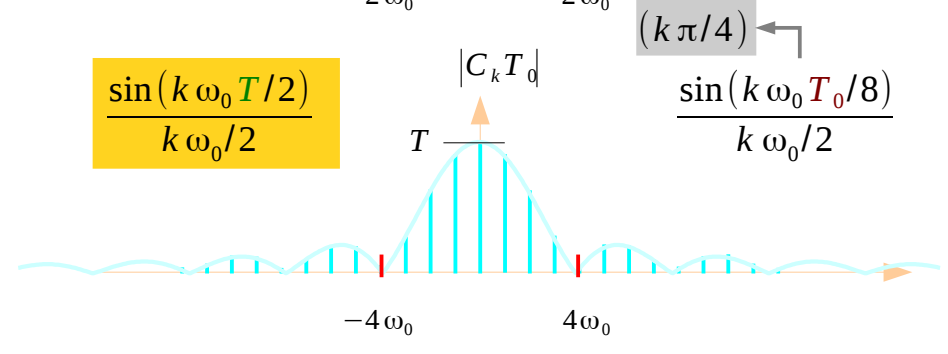
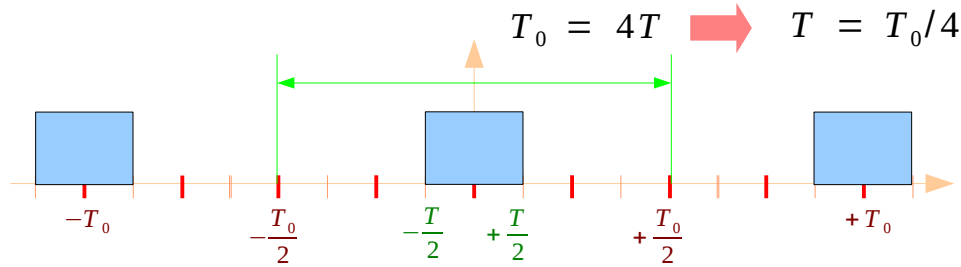
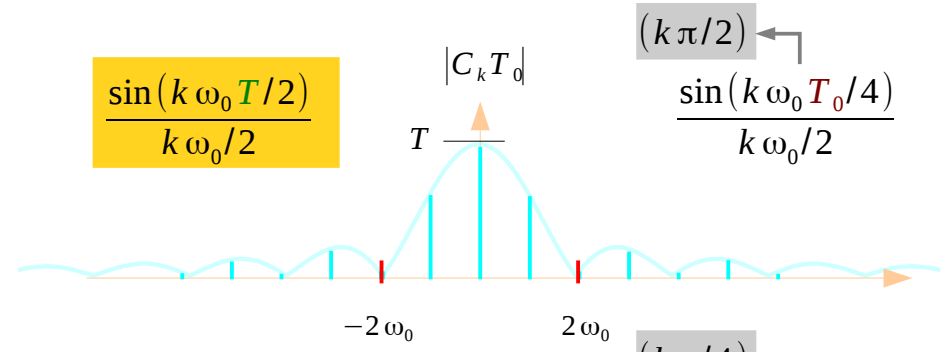
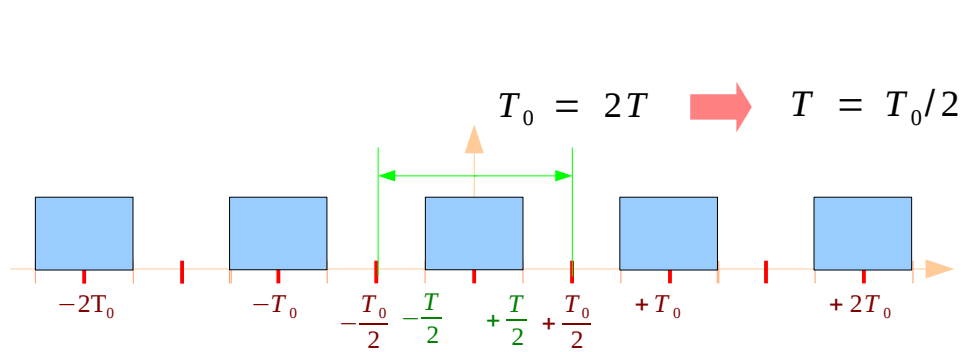

$\omega_0 = \frac{2\pi}{T_0} = \frac{2\pi}{8T} \rightarrow \frac{T_0}{T} \omega_0 = \frac{2\pi}{T}$

# CTFT and CTFS as $T_0 \rightarrow \infty$ (2)

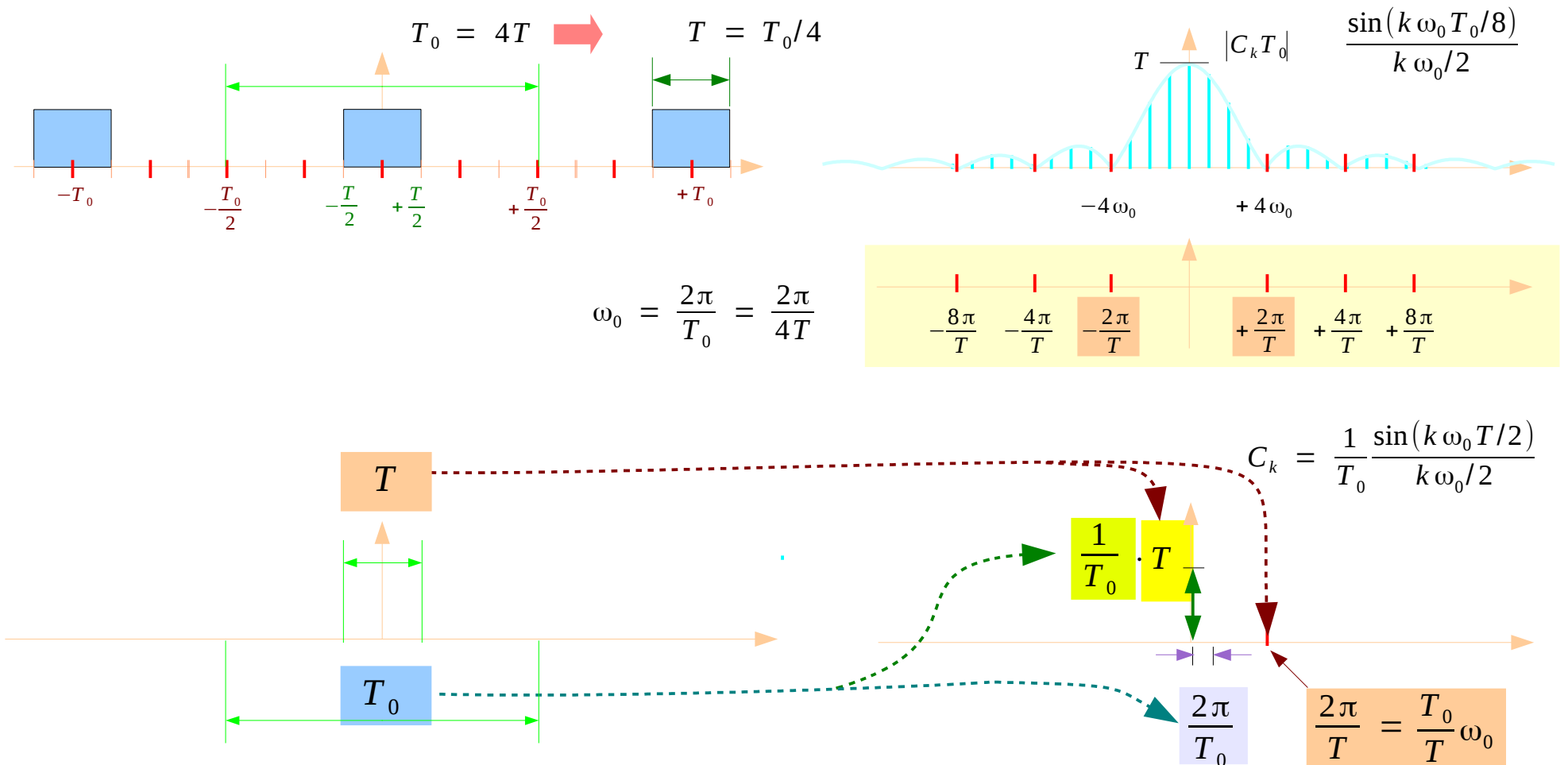



# CTFT of a Rect(t/T) function (3)

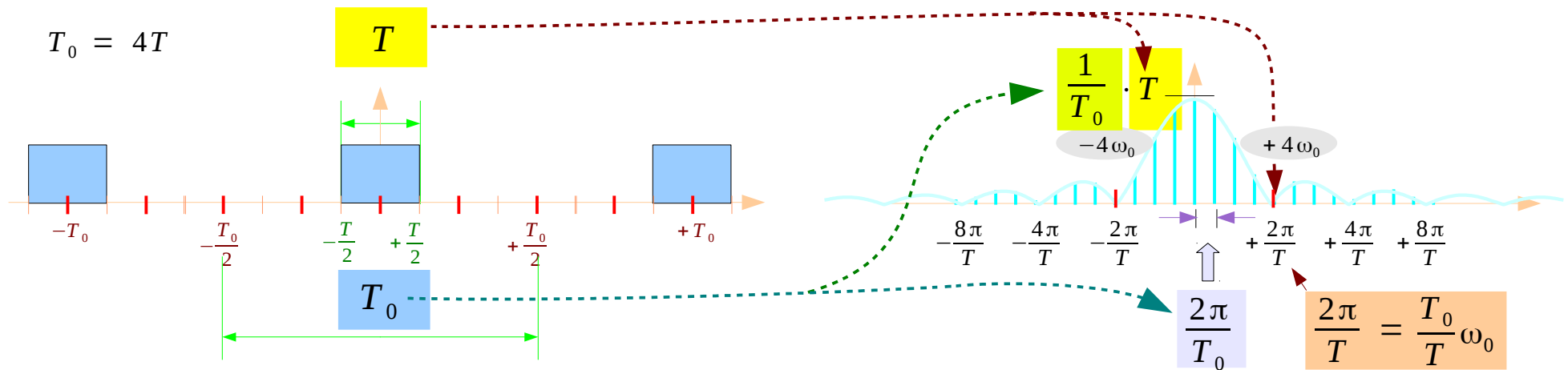

$$C_k T_0 = \frac{\sin(k \omega_0 T/2)}{k \omega_0/2}$$

$$C_k = \frac{1}{T_0} \frac{\sin(k \omega_0 T/2)}{k \omega_0/2}$$

$$X(j\omega) = \lim_{k \omega_0 \rightarrow \omega} \frac{\sin(k \omega_0 T/2)}{k \omega_0/2} = \frac{\sin(\omega T/2)}{\omega/2}$$

$$X(j\omega) = \frac{\sin(\omega T/2)}{\omega/2}$$

$$X(j\omega) = \frac{\sin(\omega T/2)}{\omega/2}$$

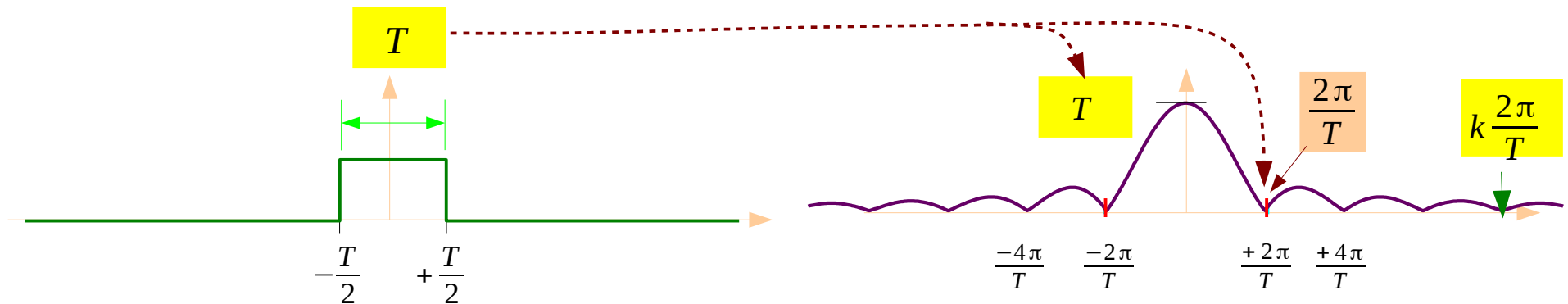

# From CTFS to CTFT

## Continuous Time Fourier Series

$$C_k = \frac{1}{T} \int_0^T x(t) e^{-jk\omega_0 t} dt \quad \longleftrightarrow \quad x(t) = \sum_{k=-\infty}^{\infty} C_k e^{+jk\omega_0 t}$$

$$C_k = \frac{1}{T_0} \int_{-T_0/2}^{+T_0/2} x_{T_0}(t) e^{-jk\omega_0 t} dt$$

$$x_{T_0}(t) = \sum_{n=0}^{\infty} C_k e^{+jk\omega_0 t} \cdot \frac{2\pi}{2\pi} \cdot \frac{T_0}{T_0}$$

$$C_k T_0 = \int_{-T_0/2}^{+T_0/2} x_{T_0}(t) e^{-jk\omega_0 t} dt$$

$$x_{T_0}(t) = \frac{1}{2\pi} \sum_{k=0}^{\infty} C_k T_0 e^{+jk\omega_0 t} \cdot \frac{2\pi}{T_0}$$

$$T_0 \rightarrow \infty \quad \Rightarrow \quad C_k T_0 \rightarrow X(j\omega) \quad x_{T_0} \rightarrow x(t) \quad \omega_0 = \frac{2\pi}{T_0} \rightarrow d\omega$$

## Continuous Time Fourier Transform

$$X(j\omega) = \int_{-\infty}^{+\infty} x(t) e^{-j\omega t} dt \quad \longleftrightarrow \quad x(t) = \frac{1}{2\pi} \int_{-\infty}^{+\infty} X(j\omega) e^{+j\omega t} d\omega$$

# Other Convention

## Continuous Time Fourier Transform {unitary, angular frequency}

$$X(j\omega) = \frac{1}{\sqrt{2\pi}} \int_{-\infty}^{+\infty} x(t) e^{-j\omega t} dt \quad \longleftrightarrow$$

$$x(t) = \frac{1}{\sqrt{2\pi}} \int_{-\infty}^{+\infty} X(j\omega) e^{+j\omega t} d\omega$$

## Continuous Time Fourier Transform {non-unitary, angular frequency}

$$X(j\omega) = 1 \cdot \int_{-\infty}^{+\infty} x(t) e^{-j\omega t} dt \quad \longleftrightarrow$$

$$x(t) = \frac{1}{2\pi} \int_{-\infty}^{+\infty} X(j\omega) e^{+j\omega t} d\omega$$

# Other Convention

## Continuous Time Fourier Transform {unitary, angular frequency}

$$X(j\omega) = \frac{1}{\sqrt{2\pi}} \int_{-\infty}^{+\infty} x(t) e^{-j\omega t} dt \quad \longleftrightarrow$$

$$x(t) = \frac{1}{\sqrt{2\pi}} \int_{-\infty}^{+\infty} X(j\omega) e^{+j\omega t} d\omega$$

## Continuous Time Fourier Transform {non-unitary, angular frequency}

$$X(j\omega) = 1 \cdot \int_{-\infty}^{+\infty} x(t) e^{-j\omega t} dt \quad \longleftrightarrow$$

$$x(t) = \frac{1}{2\pi} \int_{-\infty}^{+\infty} X(j\omega) e^{+j\omega t} d\omega$$

# Fourier Integral (1)

$$f(x) = \frac{a_0}{2} + \sum_{n=1}^{\infty} \left( a_n \cos \frac{n\pi}{p} x + b_n \sin \frac{n\pi}{p} x \right)$$

$$a_0 = \frac{1}{p} \int_{-p}^{+p} f(x) dx$$

$$a_n = \frac{1}{p} \int_{-p}^{+p} f(x) \cos \frac{n\pi}{p} x dx$$

$$b_n = \frac{1}{p} \int_{-p}^{+p} f(x) \sin \frac{n\pi}{p} x dx$$

$$n = 1, 2, 3, \dots$$

$$f(x) = \frac{1}{2p} \int_{-p}^p f(t) dt + \frac{1}{p} \sum_{n=1}^{+\infty} \left[ \left( \int_{-p}^{+p} f(t) \cos \frac{n\pi}{p} t dt \right) \cos \frac{n\pi}{p} x + \left( \int_{-p}^{+p} f(t) \sin \frac{n\pi}{p} t dt \right) \sin \frac{n\pi}{p} x \right]$$

$$\alpha_n = \frac{n\pi}{p} \quad \Delta\alpha = \alpha_{n+1} - \alpha_n = \frac{\pi}{p}$$

$$f(x) = \frac{1}{2\pi} \left( \int_{-p}^p f(t) dt \right) \Delta\alpha + \frac{1}{\pi} \sum_{n=1}^{+\infty} \left[ \left( \int_{-p}^{+p} f(t) \cos \alpha_n t dt \right) \cos \alpha_n x + \left( \int_{-p}^{+p} f(t) \sin \alpha_n t dt \right) \sin \alpha_n x \right] \Delta\alpha$$

$$p \rightarrow \infty \quad \Delta\alpha \rightarrow 0$$

$$\lim_{\Delta\alpha \rightarrow 0} F(\alpha_n) \Delta\alpha_n = \int_0^{\infty} F(\alpha) d\alpha$$

$$f(x) = \frac{1}{\pi} \sum_{n=1}^{+\infty} \left[ \left( \int_{-p}^{+p} f(t) \cos \alpha t dt \right) \cos \alpha x + \left( \int_{-p}^{+p} f(t) \sin \alpha t dt \right) \sin \alpha x \right] d\alpha$$

## References

[1] <http://en.wikipedia.org/>

[2] J.H. McClellan, et al., Signal Processing First, Pearson Prentice Hall, 2003