

# Applications of Arrays (1A)

---

Copyright (c) 2024 - 2010 Young W. Lim.

Permission is granted to copy, distribute and/or modify this document under the terms of the GNU Free Documentation License, Version 1.2 or any later version published by the Free Software Foundation; with no Invariant Sections, no Front-Cover Texts, and no Back-Cover Texts. A copy of the license is included in the section entitled "GNU Free Documentation License".

Please send corrections (or suggestions) to [youngwlim@hotmail.com](mailto:youngwlim@hotmail.com).

This document was produced by using LibreOffice.

- 
- Viewing an **array** as a **pointer**
  - Viewing a **pointer** as an **array**

- Viewing an **array** as a **pointer**

`int a[4];`

an array **a**

generalization



`int (*a)`

view **a** as a pointer

virtual pointer

- no real memory location

- constraints :

`value(&a) = value(a)`

- Viewing a **pointer** as an **array**

`int (*a);`

a pointer **a**

a specific instance



`int a[N]`

view **a** as an array

**N** is not fixed

`sizeof(a)` is

not the size of the array

but of a pointer variable

# Array **a** and pointer **a**

`int a[4];`

an array **a**

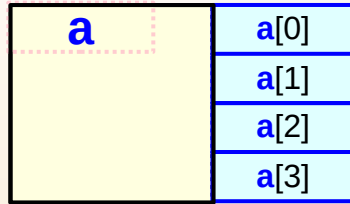

`int (*a);`

a pointer **a**

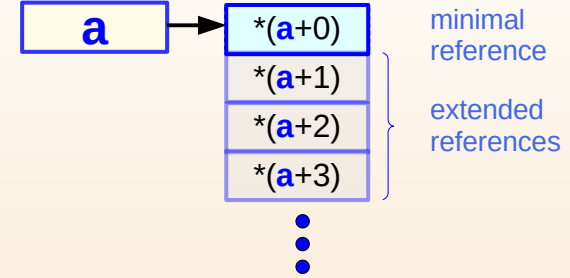

`int (*a)`

**a** as a pointer

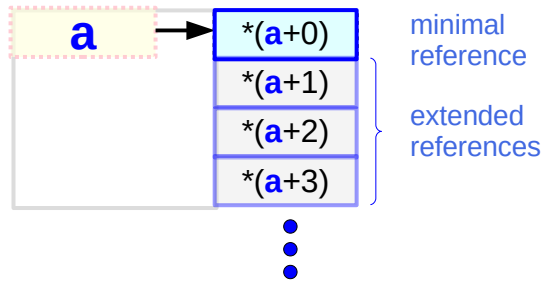

`int a[N]`

**a** as an array

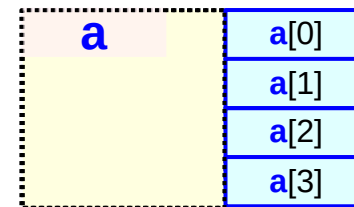

# Array **a** and pointer **a**

`int a[4];` an array **a**

- `type(a)` = `int [4]`
- `sizeof(a)` = an array size (16 bytes)
- `value(&a)` = `value(a)`
- fixed number of elements

`int (*a)` **a** as a pointer

**a** is not a real pointer

- `sizeof(a)` = an array size
- `value(&a)` = `value(a)`

`int (*a);` a pointer **a**

- `type(a)` = `int (*)`
- `sizeof(a)` = a pointer size (4 bytes)
- `value(&a)`  $\neq$  `value(a)`
- variable number of elements

`int a[N]` **a** as an array

**a** is not a real array

- `sizeof(a)`  $\neq$  an array size  
= a pointer size
- `value(&a)`  $\neq$  `value(a)`  
= assigned address

# Relationship between array and array pointer types

`int b[4][2];` declare a **2-d** array **b**



generalization

`int (*b)[2]` **b** as a **1-d** array pointer

`int a[4];` declare a **1-d** array **a**



generalization

`int (*a)` **a** as a **0-d** array pointer

`int (*b)[2];` declare a **1-d** array pointer **b**



a specific instance

`int b[N][2]` **b** as a **2-d** array

`int (*a);` declare a **0-d** array pointer **a**



a specific instance

`int a[N]` **a** as a **1-d** array

# Array **b** and array pointer **b**

```
int b[4][2] ;
```

**2-d array b**

- `type(b)` = `int [4]`
- `sizeof(b)` = an array size (32 bytes)
- `value(&b)` = `value(b)`
- fixed number of elements

```
int (*) [2]
```

**b** as a **1-d** array pointer

**b** is not a real pointer

- `sizeof(b)` = an array size
- `value(&b)` = `value(b)`

```
int (*b) [2] ;
```

**1-d array pointer b**

- `type(b)` = `int (*)`
- `sizeof(b)` = a pointer size (4 bytes)
- `value(&b)` ≠ `value(b)`
- variable number of elements

```
int [N][2]
```

**b** as a **2-d** array

**b** is not a real array

- `sizeof(b)` ≠ an array size  
= a pointer size
- `value(&b)` ≠ `value(b)`  
= assigned address



# Array **b** and array pointer **b**

`int b[4][2];`

2-d array **b**

<b>b</b>	b[0]	b[0][0]
		b[0][1]
	b[1]	b[1][0]
		b[1][1]
	b[2]	b[2][0]
		b[2][1]
	b[3]	b[3][0]
		b[3][1]

`int (*) [2]`

**b** as a 1-d array pointer

<b>b</b>	*(b+0)	(*(b+0))[0]
		(*(b+0))[1]
	*(b+1)	(*(b+1))[0]
		(*(b+1))[1]
	*(b+2)	(*(b+2))[0]
		(*(b+2))[1]
	*(b+3)	(*(b+3))[0]
		(*(b+3))[1]

minimal reference

extended references

virtual pointer  
- no real memory location  
- constraints :  
`&b = b`

...

`int (*b) [2];`

1-d array pointer **b**

<b>b</b>	*(b+0)	(*(b+0))[0]
		(*(b+0))[1]
	*(b+1)	(*(b+1))[0]
		(*(b+1))[1]
	*(b+2)	(*(b+2))[0]
		(*(b+2))[1]
	*(b+3)	(*(b+3))[0]
		(*(b+3))[1]

minimal reference

extended references

...

`int [N][2]`

**b** as a 2-d array

<b>b</b>	b[0]	b[0][0]
		b[0][1]
	b[1]	b[1][0]
		b[1][1]
	b[2]	b[2][0]
		b[2][1]
	b[3]	b[3][0]
		b[3][1]

**N** is not fixed to 4

`sizeof(b)` is not the size of the array but the size of a pointer variable

# Dual type - relaxing the 1<sup>st</sup> dimension of an array

`int [4][2]` **2-d array**  
more constrained type

relaxing the  
1<sup>st</sup> dimension  
generalization



a specific instance



`int (*)[2]` **1-d array pointer**  
more general type

`int [4]` **1-d array**  
more constrained type

relaxing the  
1<sup>st</sup> dimension  
generalization



a specific instance



`int (*)` **0-d array pointer**  
more general type

# Subarray types in a 2-d array

`int b[2][4];` 2-d array `b`

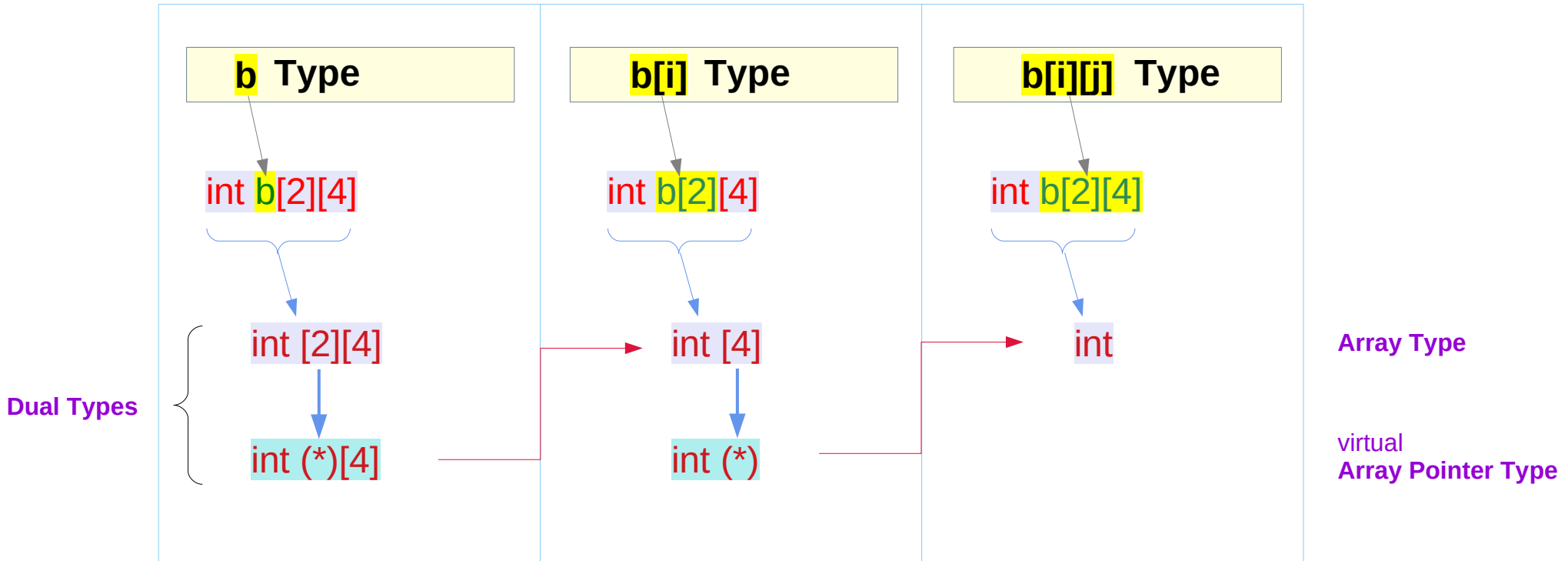

# Dual types in a 2-d array

`int b[2][4];` 2-d array **b**

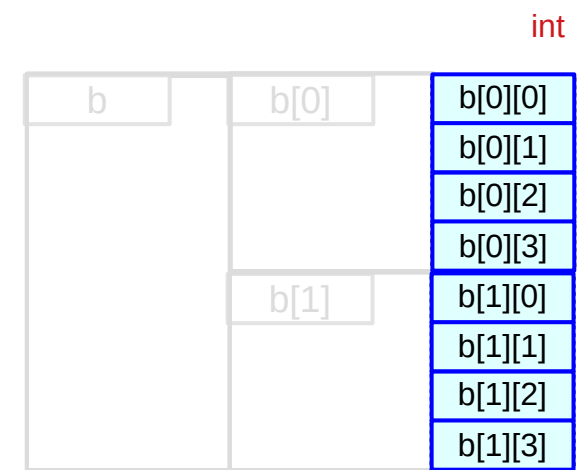
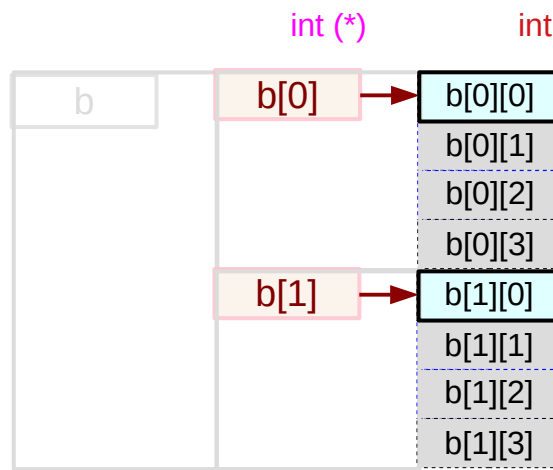
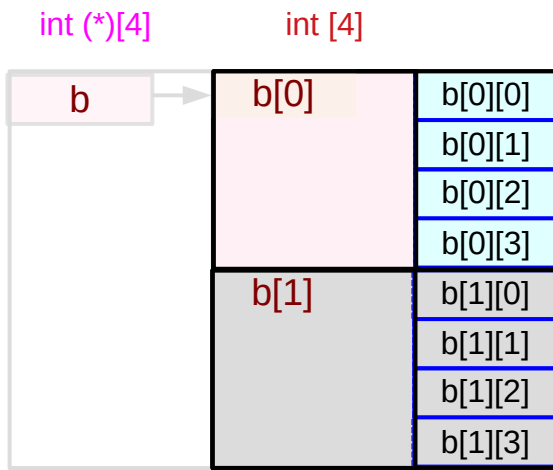
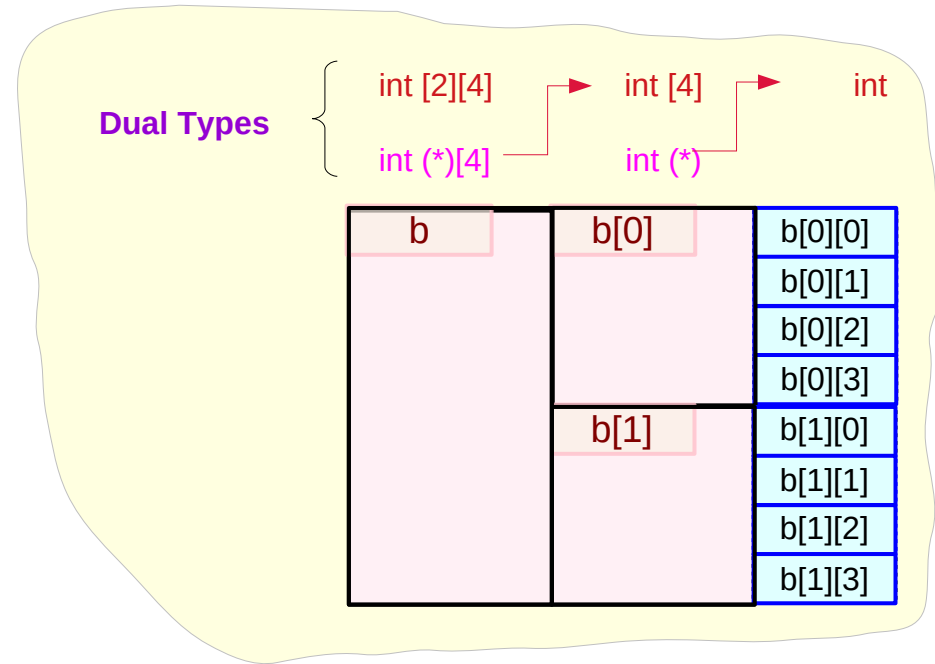
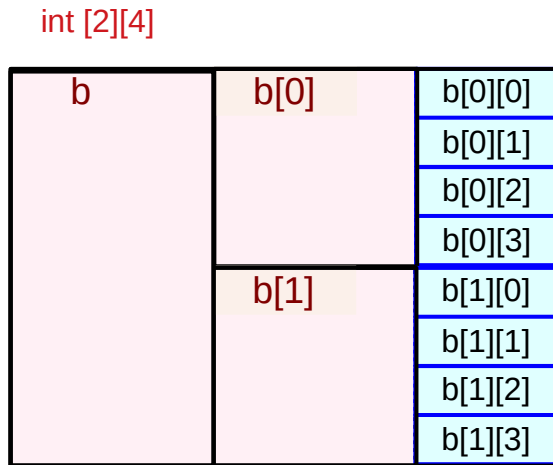

# Subarray type examples

```
int a[4];
```

			relaxed type	virtual
a	int [4]	<b>1-d</b> array type	int (*)	<b>0-d</b> array pointer type
a[i]	int	<b>0-d</b> array type		

```
int b[2][4];
```

			relaxed type	virtual
b	int [2][4]	<b>2-d</b> array type	int (*)[4]	<b>1-d</b> array pointer type
b[i]	int [4]	<b>1-d</b> array type	int (*)	<b>0-d</b> array pointer type
b[i][j]	int	<b>0-d</b> array type		

```
int c[4][2][3];
```

			relaxed type	virtual
c	int [4][2][3]	<b>3-d</b> array type	int (*)[2][3]	<b>2-d</b> array pointer type
c[i]	int [4][2]	<b>2-d</b> array type	int (*)[2]	<b>1-d</b> array pointer type
c[i][j]	int [4]	<b>1-d</b> array type	int (*)	<b>0-d</b> array pointer type
c[i][j][k]	int	<b>0-d</b> array type		

# Types of **a**, **b**, **c** arrays

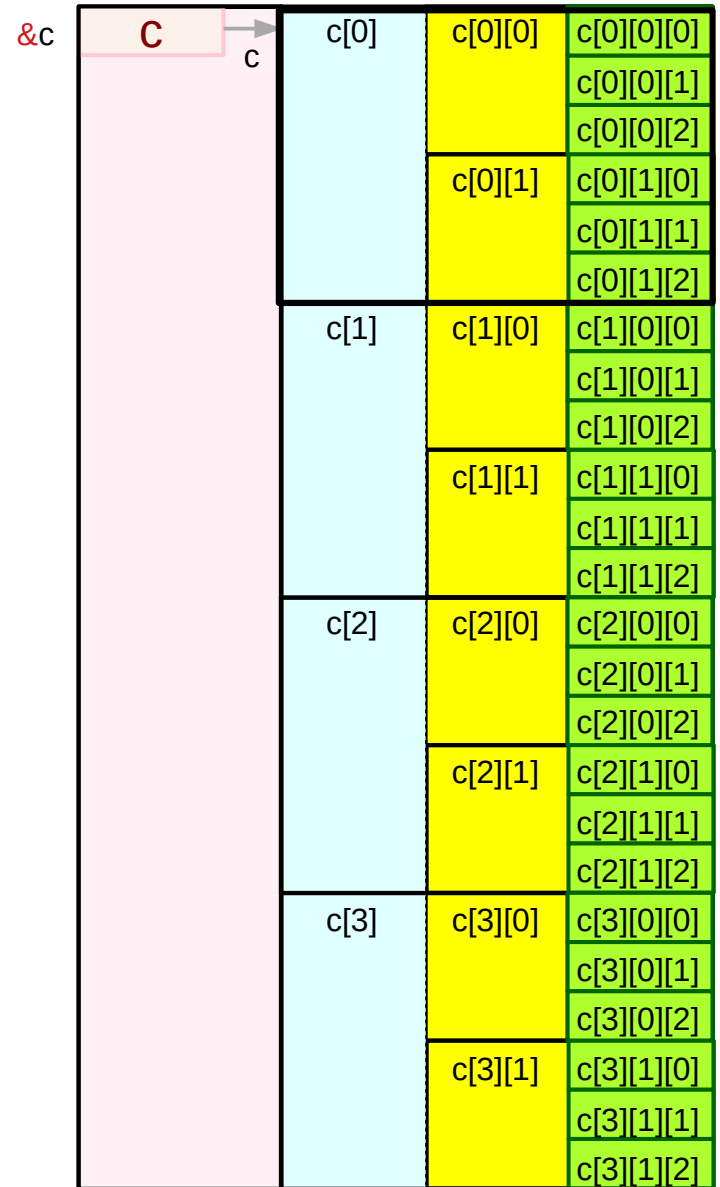
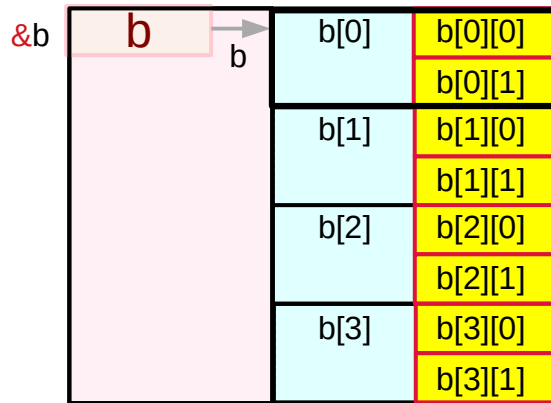
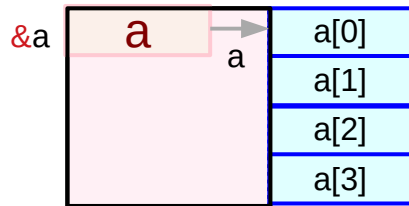

```
int a[4];
int b[2][4];
int c[4][2][3];
```

## dual types

int [4]	<b>1-d array a</b>	<b>a[i]</b>
int (*)	<b>0-d array pointer a (virtual)</b>	<b>*(a+i)</b>
int [4][2];	<b>2-d array b</b>	<b>b[i]</b>
int (*)[2];	<b>1-d array pointer b (virtual)</b>	<b>*(b+i)</b>
int [4][2][3];	<b>3-d array c</b>	<b>c[i]</b>
int (*)[2][3];	<b>2-d array pointer c (virtual)</b>	<b>*(c+i)</b>

# Types of $b[i]$ , $c[i]$ subarrays

```
int a[4];
int b[2][4];
int c[4][2][3];
```

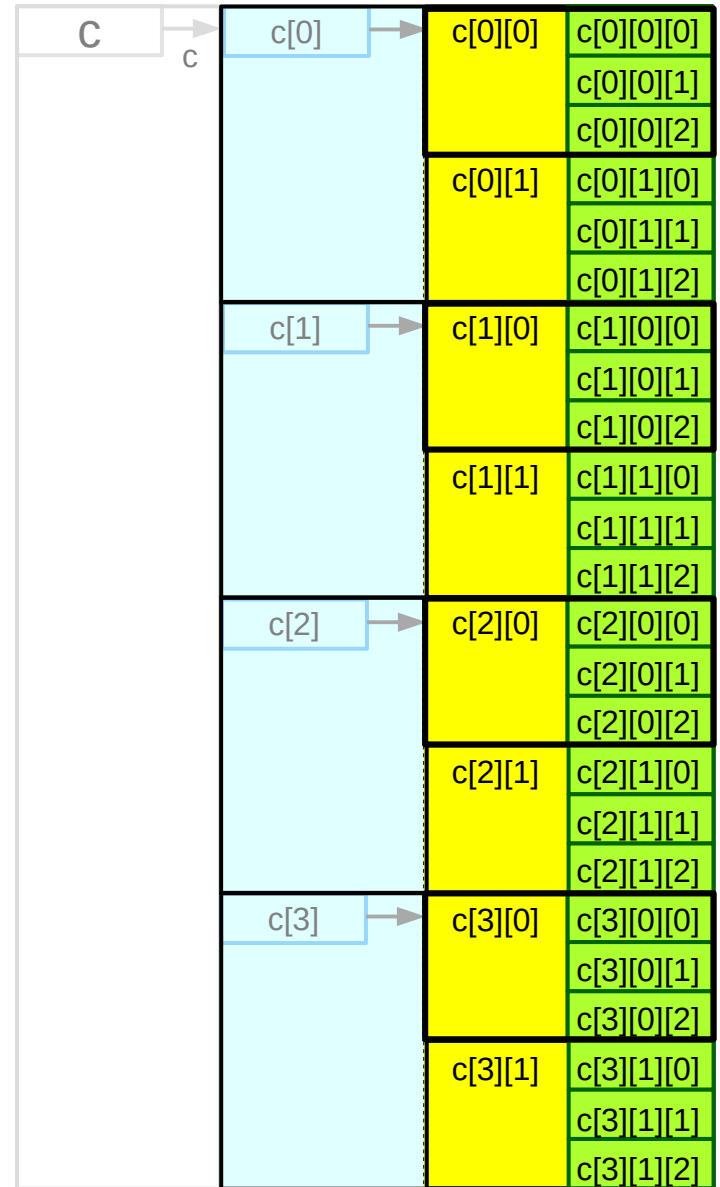
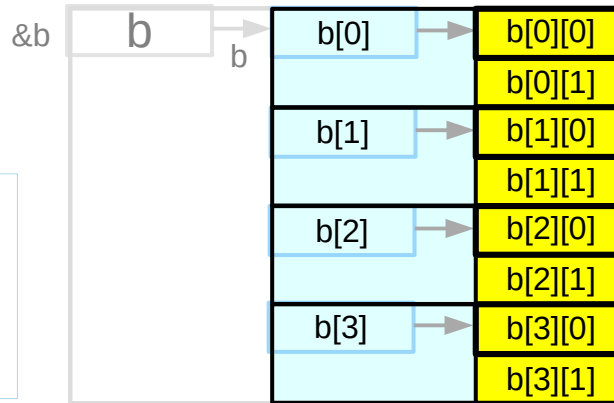

## dual types

int [2]	1-d array $b[i]$	$b[i][j]$
int (*)	0-d array pointer $b[i]$ (virtual)	$*(b[i]+j)$
int [2][3];	2-d array $c[i]$	$c[i][j]$
int (*)[3];	1-d array pointer $c[i]$ (virtual)	$*(c[i]+j)$

# Types of `c[i][j]` subarrays

```
int a[4];  
int b[2][4];  
int c[4][2][3];
```

## dual types

<code>int [3]</code>	<b>1-d</b> array <code>c[i][j]</code>	<code>c[i][j][k]</code>
<code>int (*)</code>	<b>0-d</b> array pointer <code>c[i][j]</code> (virtual)	<code>*(c[i][j]+k)</code>





# Types of a 4-d array and its subarrays

int **d**[4][2][3][4];

types

<b>d</b>	consider <b>d</b> [4][2][3][4]	→	int [4][2][3][4]	⇒	<b>4-d</b> array
	relax the 1 <sup>st</sup> dimension	→	int (*)[2][3][4]	⇒	<b>3-d</b> array pointer (virtual)
<b>d</b> [i]	consider <b>d</b> [i][2][3][4]	→	int [2][3][4]	⇒	<b>3-d</b> array
	relax the 1 <sup>st</sup> dimension	→	int (*)[3][4]	⇒	<b>2-d</b> array pointer (virtual)
<b>d</b> [i][j]	consider <b>d</b> [i][j][3][4]	→	int [3][4]	⇒	<b>2-d</b> array
	relax the 1 <sup>st</sup> dimension	→	int (*)[4]	⇒	<b>1-d</b> array pointer (virtual)
<b>d</b> [i][j][k]	consider <b>d</b> [i][j][k][4]	→	int [4]	⇒	<b>1-d</b> array
	relax the 1 <sup>st</sup> dimension	→	int (*)	⇒	<b>0-d</b> array pointer (virtual)

i,j,k are specific index values

i=[0..3],

j=[0..1],

k=[0..2]

# Initializing $n$ -d array pointers with $n$ -d subarrays

```
int d[4][2][3][4];
```

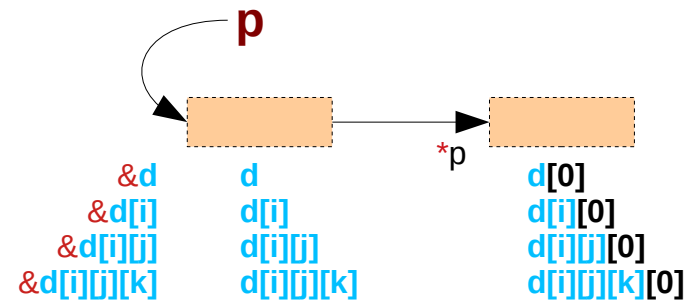

<b>d</b>	4-d array	<code>d[4][2][3][4]</code>	<code>p = &amp;d</code>	abstract data
<b>p</b>	4-d array pointer	<code>(*p)[4][2][3][4]</code>	<code>int (*p)[4][2][3][4] = &amp;d;</code> <code>(*p)[i][j][k][l] ≡ d[i][j][k][l]</code>	
<b>d[i]</b>	3-d array	<code>d[i][2][3][4]</code>	<code>p = &amp;d[i]</code>	abstract data
<b>p</b>	3-d array pointer	<code>(*p)[2][3][4]</code>	<code>int (*p)[3][4] = &amp;d[i];</code> <code>(*p)[j][k][l] ≡ d[i][j][k][l] given i</code>	
<b>d[i][j]</b>	2-d array	<code>d[i][j][3][4]</code>	<code>p = &amp;d[i][j]</code>	abstract data
<b>p</b>	2-d array pointer	<code>(*p)[3][4]</code>	<code>int (*p)[4] = &amp;d[i][j];</code> <code>(*p)[k][l] ≡ d[i][j][k][l] given i, j</code>	
<b>d[i][j][k]</b>	1-d array	<code>d[i][j][k][4]</code>	<code>p = &amp;d[i][j][k]</code>	abstract data
<b>p</b>	1-d array pointer	<code>(*p)[4]</code>	<code>int (*p) = &amp;d[i][j][k];</code> <code>(*p)[l] ≡ d[i][j][k][l] given i, j, k</code>	

# Initializing $(n-1)$ -d array pointers with $n$ -d subarrays

```
int d[4][2][3][4];
```

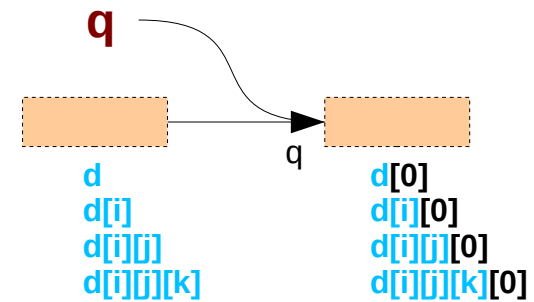

<b>d</b>	4-d array	<code>d[4][2][3][4]</code>	<code>q = d</code>	virtual pointer
<b>q</b>	3-d array pointer	<code>(*q)[2][3][4]</code>	<code>int (*q)[2][3][4] = d;</code> <code>q[i][j][k][l] ≡ d[i][j][k][l]</code>	
<b>d[i]</b>	3-d array	<code>d[i][2][3][4]</code>	<code>q = d[i]</code>	virtual pointer
<b>q</b>	2-d array pointer	<code>(*q)[3][4]</code>	<code>int (*q)[3][4] = d[i];</code> <code>q[j][k][l] ≡ d[i][j][k][l]</code> given i	
<b>d[i][j]</b>	2-d array	<code>d[i][j][3][4]</code>	<code>q = d[i][j]</code>	virtual pointer
<b>q</b>	1-d array pointer	<code>(*q)[4]</code>	<code>int (*q)[4] = d[i][j];</code> <code>q[k][l] ≡ d[i][j][k][l]</code> given i, j	
<b>d[i][j][k]</b>	1-d array	<code>d[i][j][k][4]</code>	<code>q = d[i][j][k]</code>	virtual pointer
<b>q</b>	0-d array pointer	<code>(*q)</code>	<code>int (*q) = d[i][j][k];</code> <code>q[l] ≡ d[i][j][k][l]</code> given i, j, k	

---

Aggregate Data Types  
Abstract Data Types  
Virtual Array Pointers

# Aggregate data type

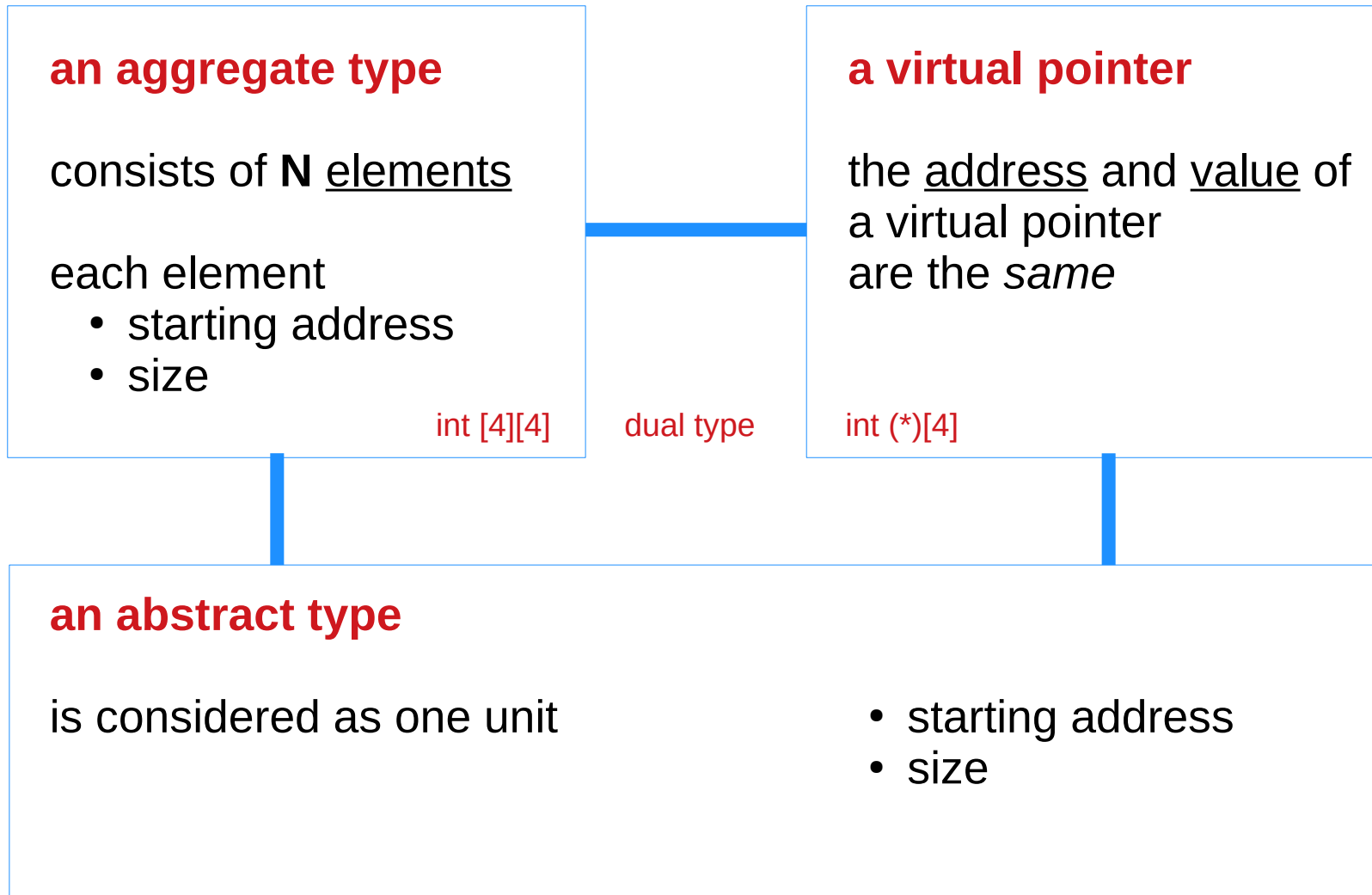

# Abstract data **c**

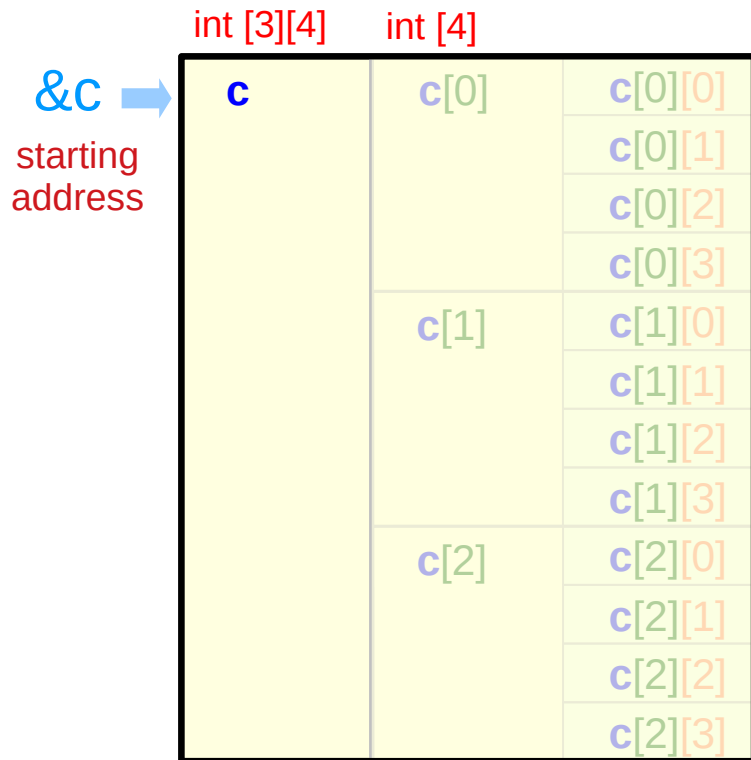

an abstract data  
- start address  
- size

**c**  
**&c**  
**sizeof(c)**

# Aggregate data **c**

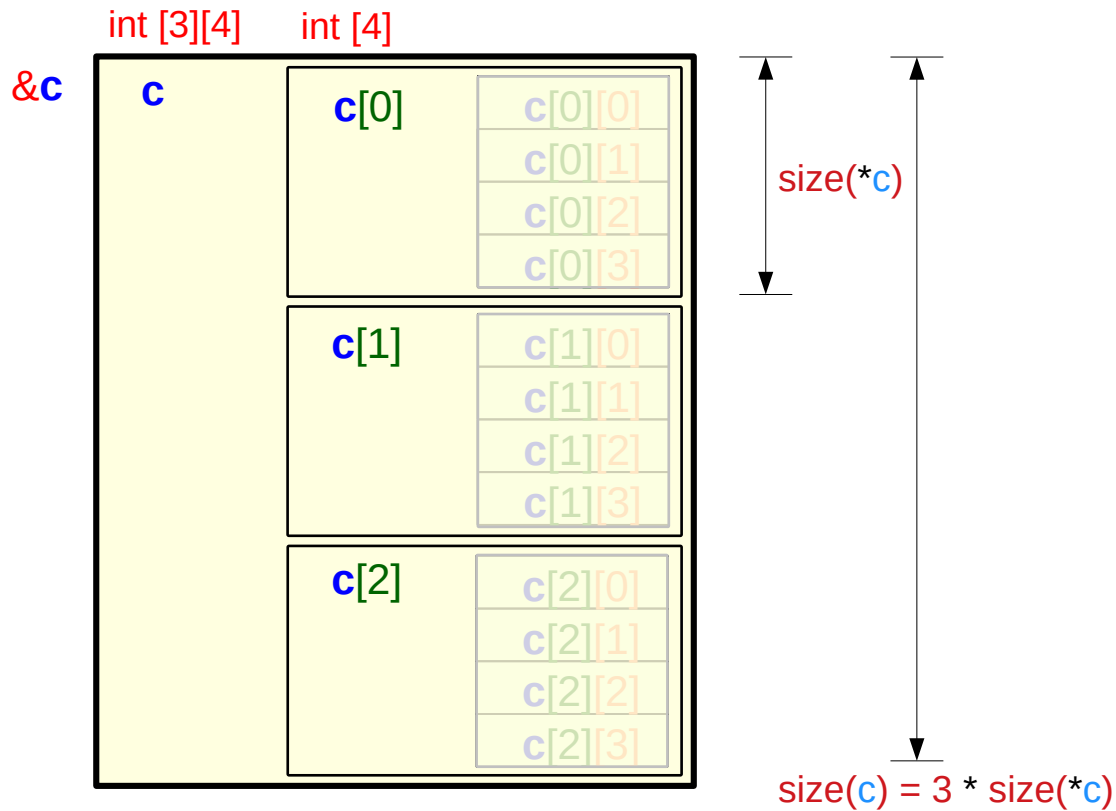

an aggregate type data **c**

- 1<sup>st</sup> element    **c[0]**
- 2<sup>nd</sup> element    **c[1]**
- 3<sup>rd</sup> element    **c[2]**

# Virtual pointer **c**

$\&c = c = \&c[0]$

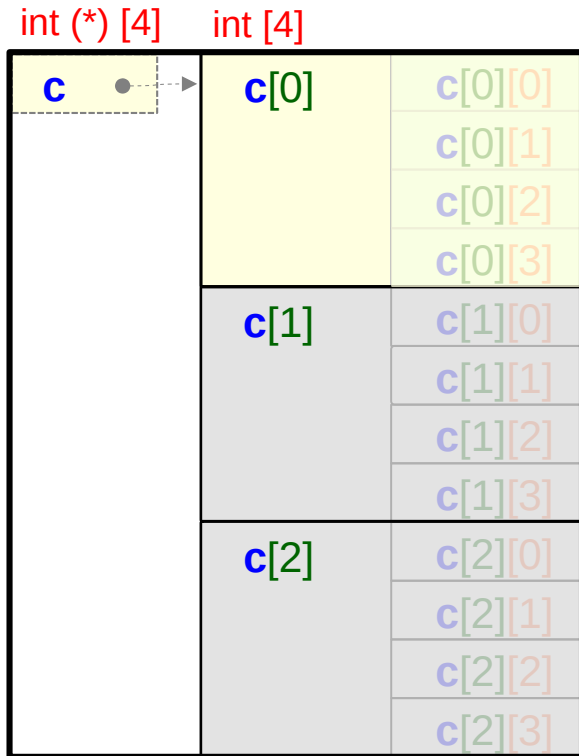

size(\*c)

a virtual pointer **c**  
- pointer address **&c**  
- pointer value **c = &c[0]**  
  
with the constraint  
**c = &c**

an abstract data **c[0] = \*c**  
- start address **&c[0] = c**  
- size **sizeof(c[0])**

virtual pointer **c** points  
to abstract data **c[0]**

## virtual pointers

- no physical memory locations are allocated
- address and data have the same value



# Abstract data $c[i]$

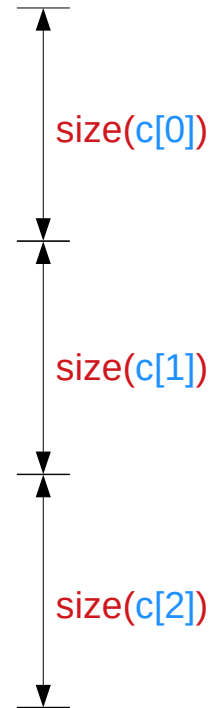
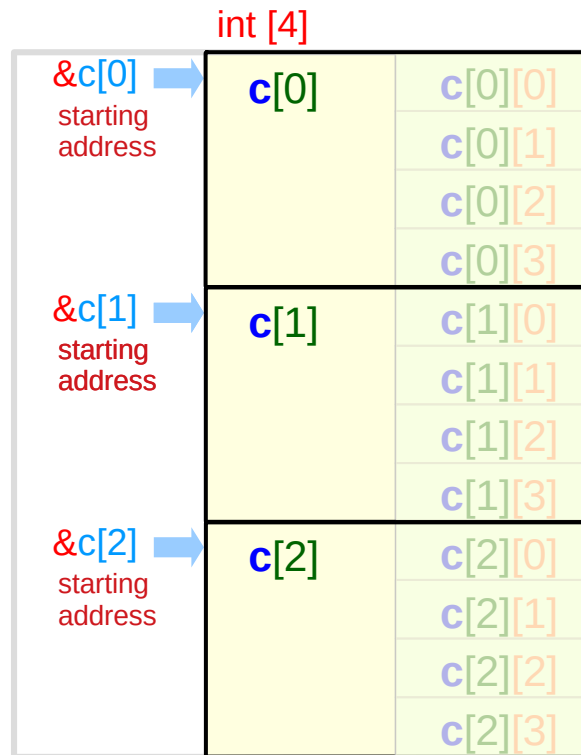

- an abstract data
  - start address  $c[0]$
  - size  $\&c[0]$
  - $sizeof(c[0])$
- an abstract data
  - start address  $c[1]$
  - size  $\&c[1]$
  - $sizeof(c[1])$
- an abstract data
  - start address  $c[2]$
  - size  $\&c[2]$
  - $sizeof(c[2])$

# Aggregate data $c[i]$

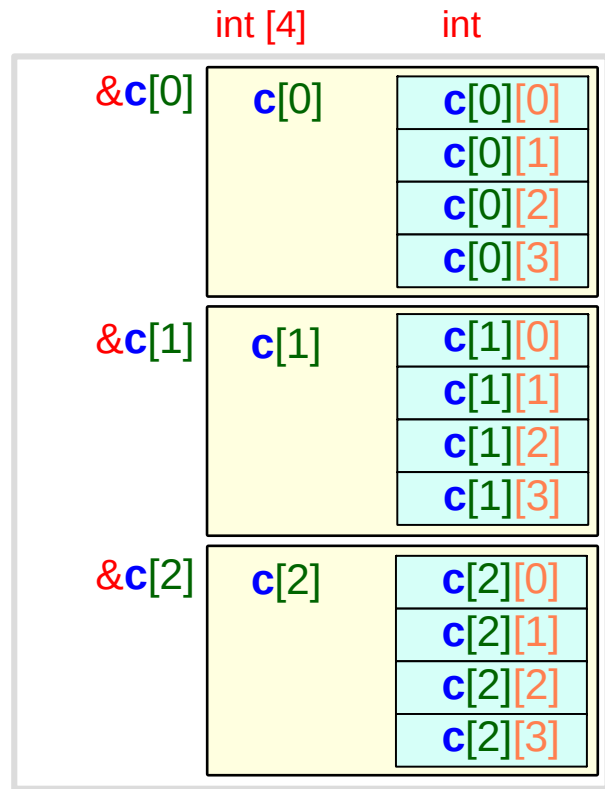

$\text{size}(*c[0])$

$\text{size}(c[0]) = 4 * \text{size}(*c[0])$

an aggregate type data  $c[i]$

- 1<sup>st</sup> element  $c[i][0]$
- 2<sup>nd</sup> element  $c[i][1]$
- 3<sup>rd</sup> element  $c[i][2]$
- 4<sup>th</sup> element  $c[i][3]$

# Virtual pointer $c[i]$

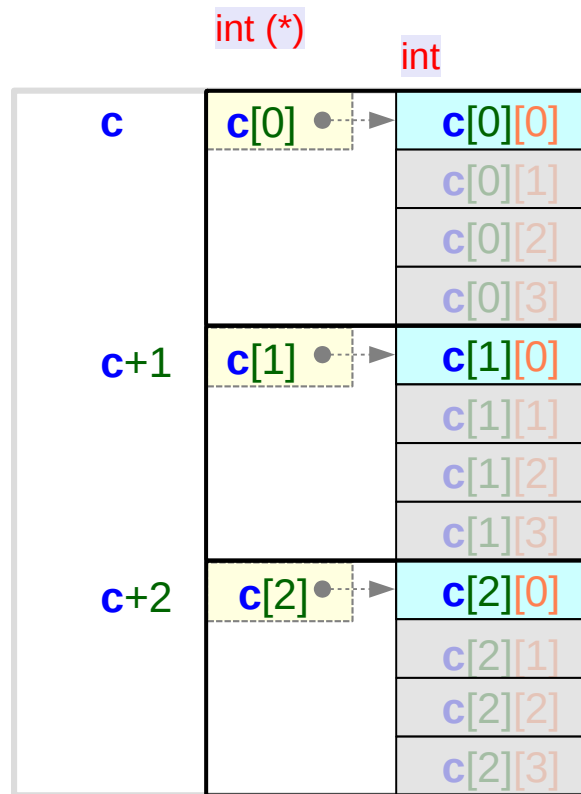

a virtual pointer  $c[i]$

- pointer address  $\&c[i]$
- pointer value  $c+i = \&c[i]$

with the constraint

$$c[i] = \&c[i]$$

an primitive data  $c[i][0] = *c[i]$

- start address  $\&c[i][0] = c[i]$
- size  $\text{sizeof}(c[i][0])$

virtual pointer  $c[i]$   
points to primitive data  $c[i][0]$

virtual pointers

- no physical memory locations are allocated
- address and data have the same value

# A 2-d array and its 1-d sub-arrays – a size view

```
int c[3][4];
```

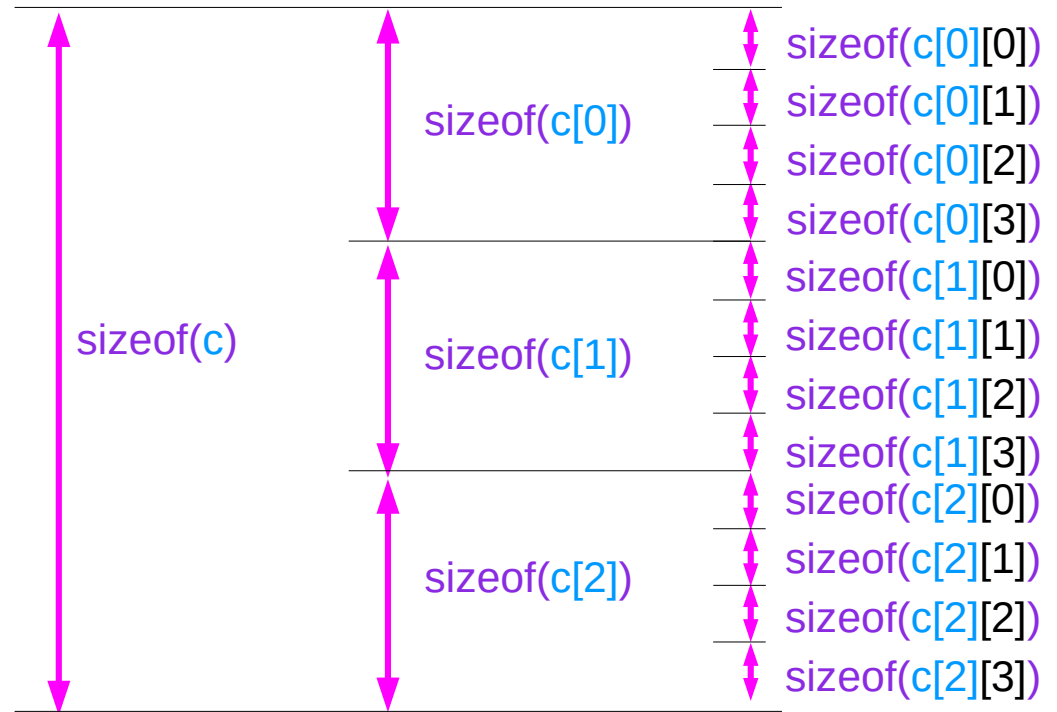
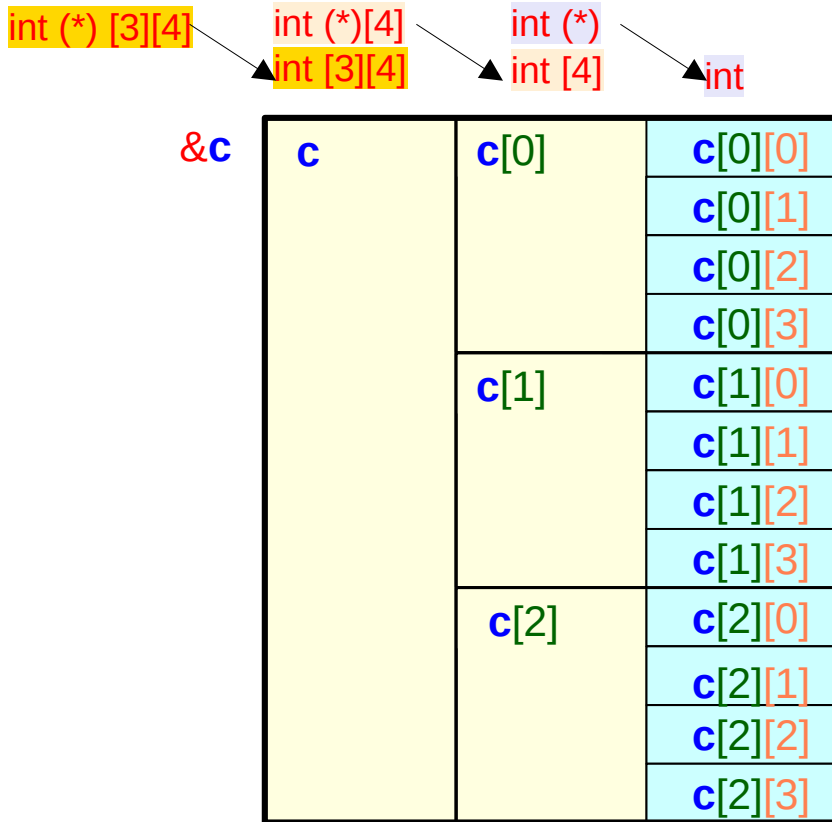

# A 2-d array and its 1-d sub-arrays – a virtual pointer view

```
int c[3][4];
```

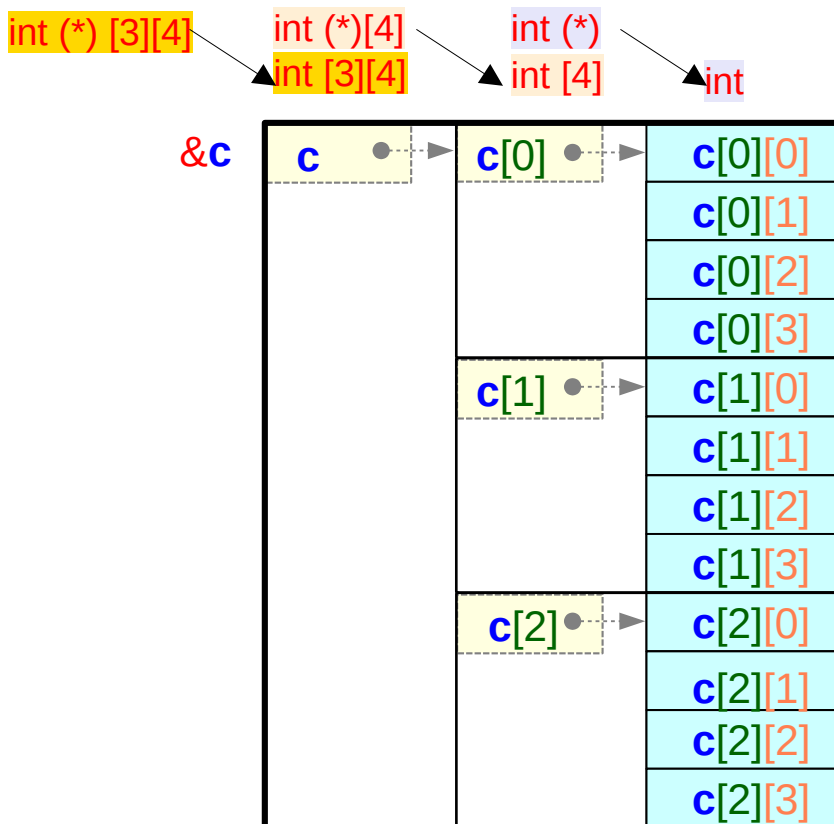

`value( c ) = value( c[0] ) = value(&c[0][0])`  
`value(&c) = value(&c[0]) = value(&c[0][0])`

`value( c[1] ) = value(&c[1][0])`  
`value(&c[1]) = value(&c[1][0])`

`value( c[2] ) = value(&c[2][0])`  
`value(&c[2]) = value(&c[2][0])`

`address(c) = address(c[0]) = address(c[0][0])`  
`address(c[1]) = address(c[1][0])`  
`address(c[2]) = address(c[2][0])`

# A 2-d array and its 1-d sub-arrays – size relation

```
int c[3][4];
```

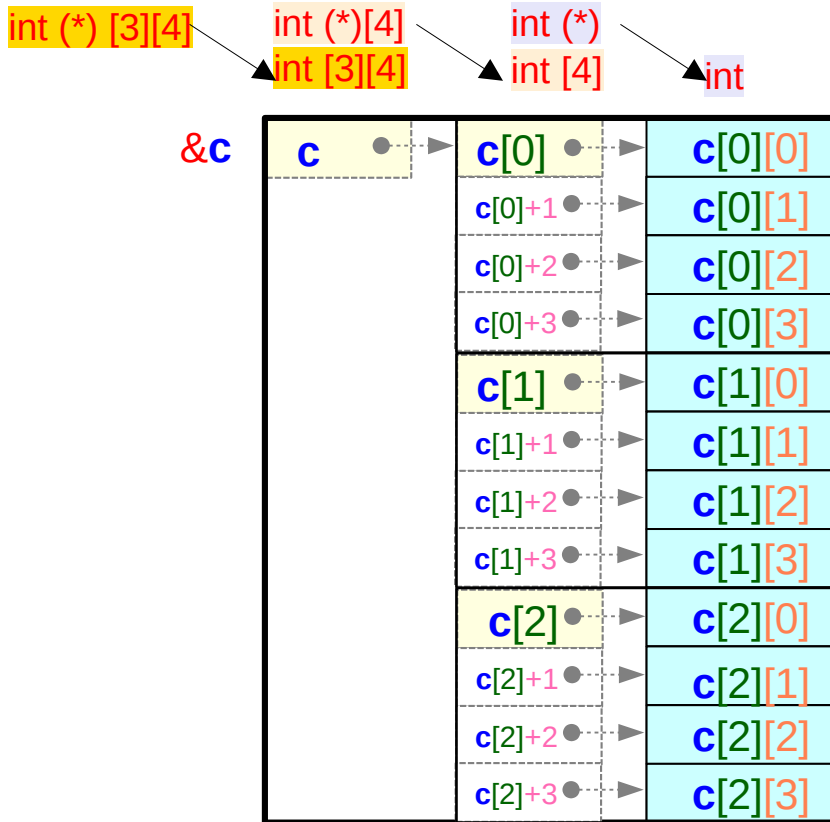

`sizeof(c)` = `sizeof(c[0])` \* 3 ... leading element  
`sizeof(c+1)` = pointer size (4/8 bytes)  
`sizeof(c+2)` = pointer size (4/8 bytes)

`sizeof(c[0])` = `sizeof(c[0][0])` \* 4 ... leading element  
`sizeof(c[0]+1)` = pointer size (4/8 bytes)  
`sizeof(c[0]+2)` = pointer size (4/8 bytes)  
`sizeof(c[0]+3)` = pointer size (4/8 bytes)

`sizeof(c[1])` = `sizeof(c[1][0])` \* 4 ... leading element  
`sizeof(c[1]+1)` = pointer size (4/8 bytes)  
`sizeof(c[1]+2)` = pointer size (4/8 bytes)  
`sizeof(c[1]+3)` = pointer size (4/8 bytes)

`sizeof(c[2])` = `sizeof(c[2][0])` \* 4 ... leading element  
`sizeof(c[2]+1)` = pointer size (4/8 bytes)  
`sizeof(c[2]+2)` = pointer size (4/8 bytes)  
`sizeof(c[2]+3)` = pointer size (4/8 bytes)

# Sub-array types in a 2-d array

`int c[3][4];` 2-d array `c`

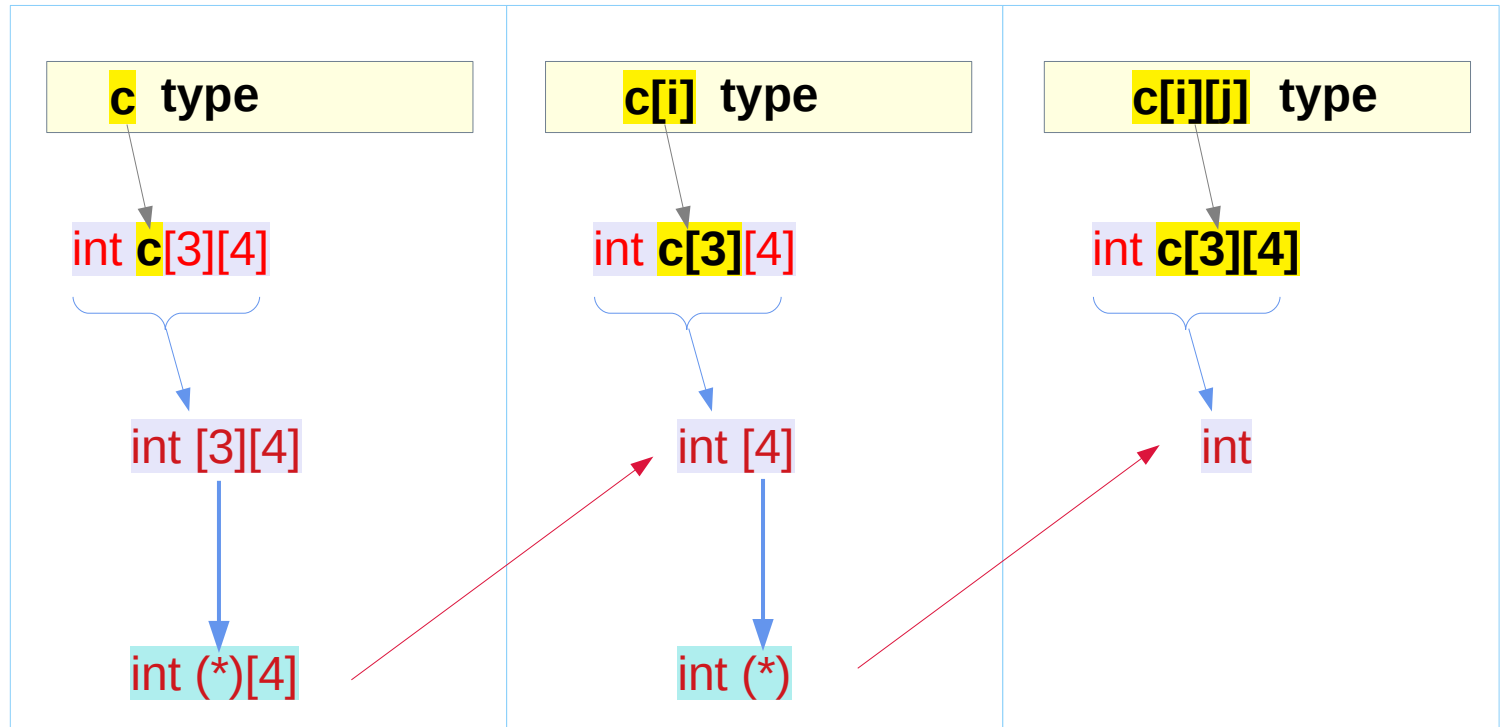

Dual Types

- 
- **Identifying nested arrays  
in a 2-d array declaration**



# Nested arrays in a 2-d array declaration

```
int c[3][4];
```

```
int c[3][4];
```

**c** : a 3 element array  
**c[i]** : each element

```
int c[3][4];
```

**c[i]**'s type 1 : **int [4]**  
an array of 4 integers

```
int c[3][4];
```

relaxed dimension

**c[i]**'s type 2: **int (\*)**  
a pointer to an integer

# Nested arrays

`c[3]`

`c` : a 3 element array  
`c[i]` : each element

`int`

`[4];`

`c[i]`'s type 1 : `int [4]`  
`c[i]`'s type 2 : `int (*)`

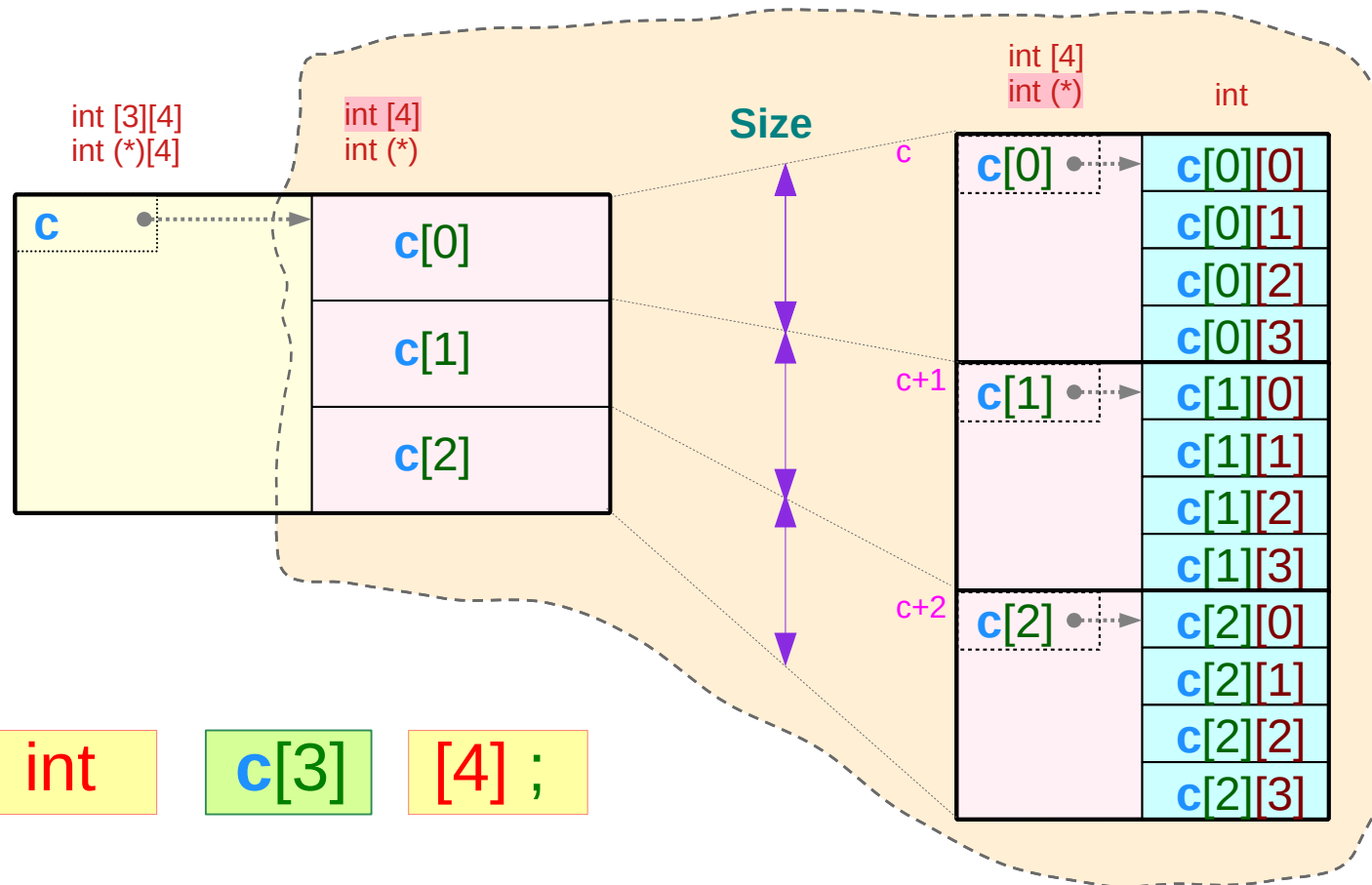

Address

`&c[0][0]` → `c[0]` → `c`

`&c[1][0]` → `c[1]`

`&c[2][0]` → `c[2]`

`int`

`c[3]`

`[4];`

# c : 3-element array

<b>c</b>	2-d array	int [3][4]
<b>c[i]</b>	1-d array	int [4]

```
int c [3] [4] ;
```

## 3-element array c

abstract data element **c[i]**

each element **c[i]** has the 1-d array type **int [4]**

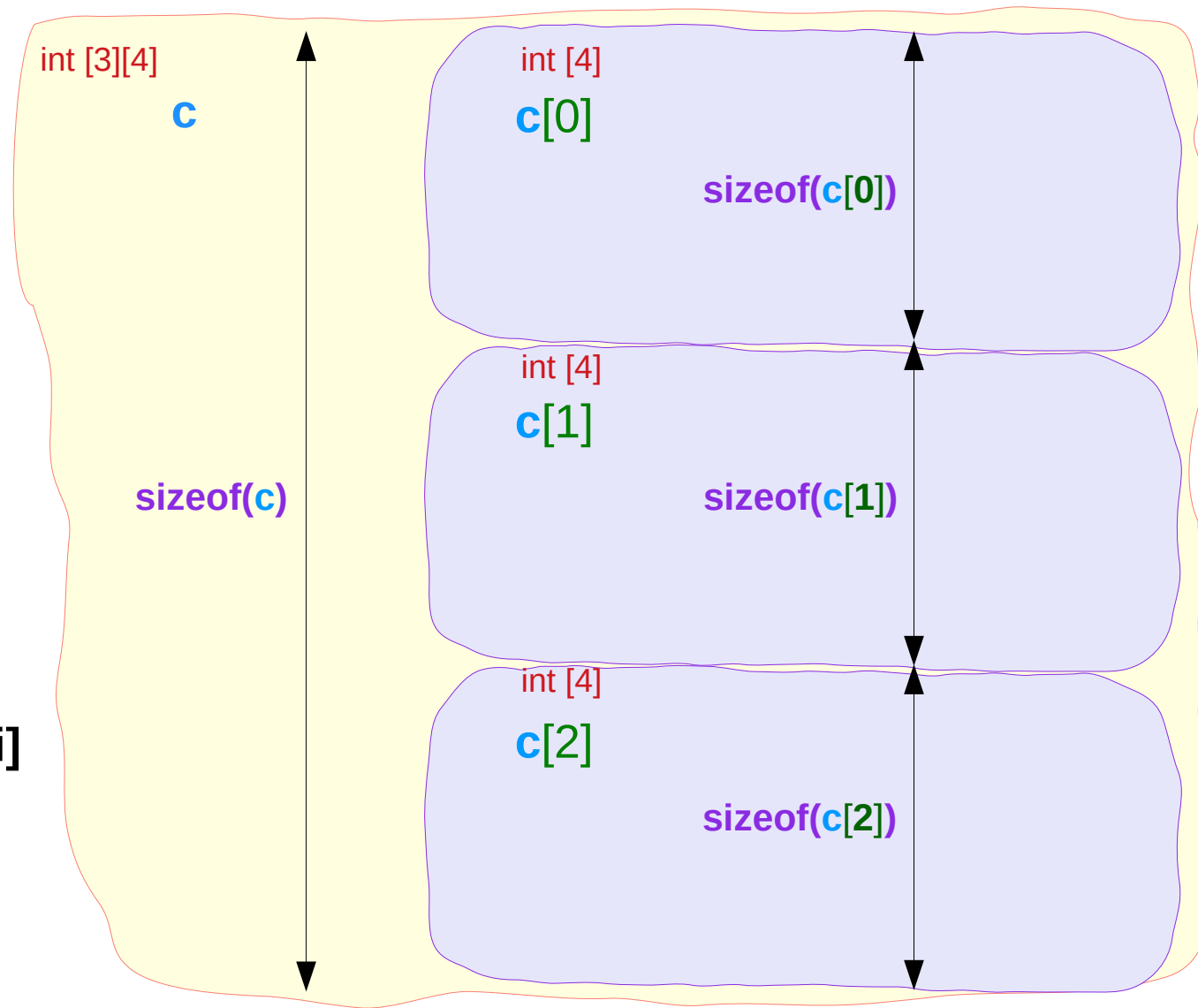

# c : pointer to a 4-element array

<b>c</b>	1-d array pointer	int (*)[4]
<b>c[i]</b>	1-d array	int [4]

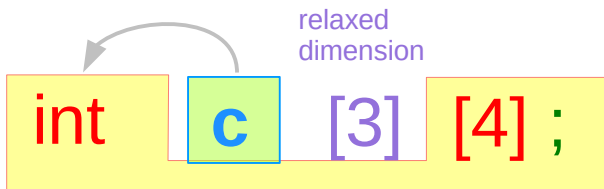

## pointer c

abstract data element **c[0]**

each element **c[i]** has the 1-d array type `int [4]`

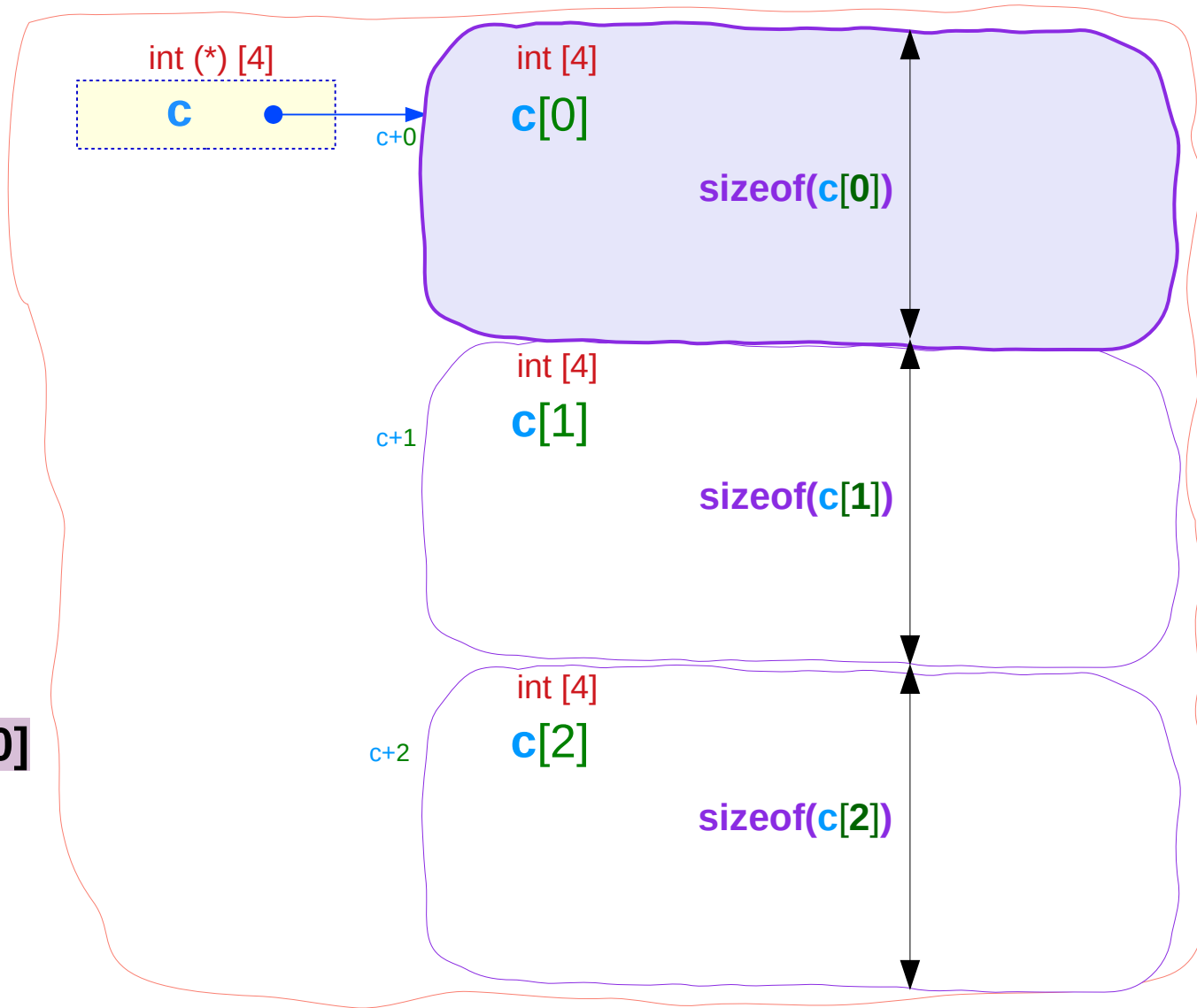

# c[i] : 4-element array

c[i]	1-d array	int [4]
c[i][j]	0-d array	int

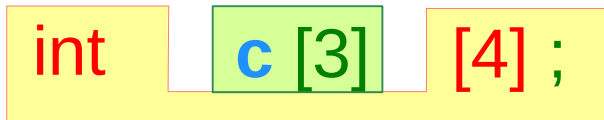

## 4-element array c[i]

primitive data element c[i][j]

each element c[i][j] has the primitive type int

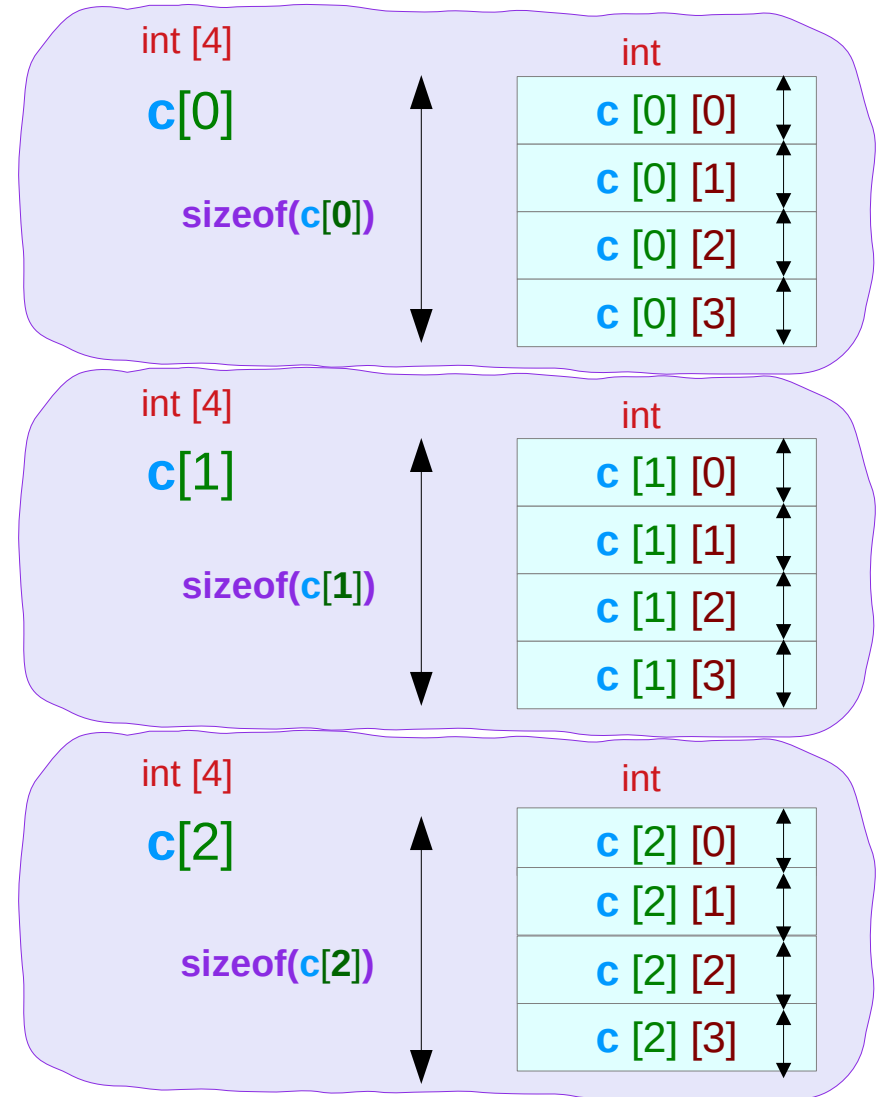

# c[i] : pointer to a primitive data

c[i]	0-d array pointer	int (*)
c[i][j]	0-d array	int

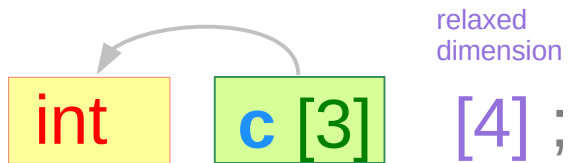

## pointer c[i]

primitive data element c[i][0]

each element c[i][j] has the primitive type int

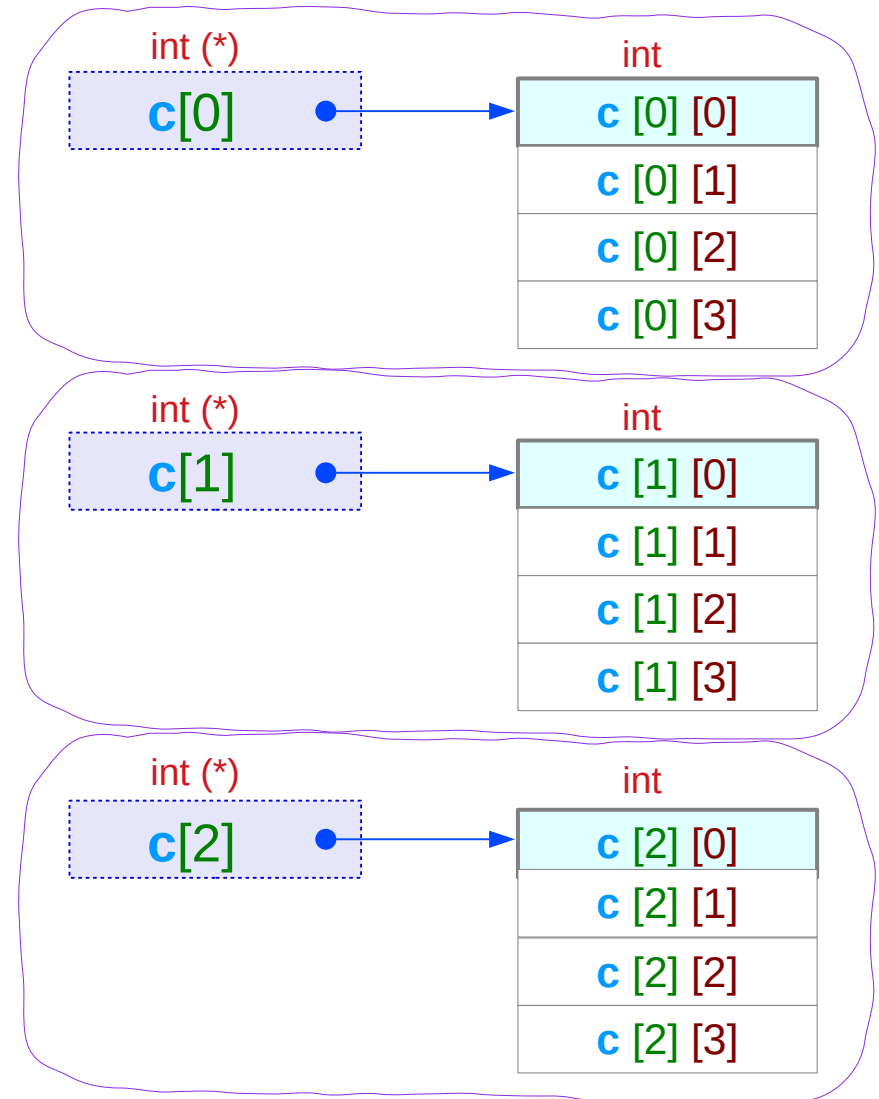

# Recursive data view

<code>c</code>	2-d array	<code>int [3][4]</code>
<code>c</code>	1-d array pointer	<code>int (*)[4]</code>
<code>c[i]</code>	1-d array	<code>int [4]</code>
<code>c[i]</code>	0-d array pointer	<code>int (*)</code>
<code>c[i][j]</code>	0-d array	<code>int</code>

`int`   `c[3]`   `[4]` ;

3-element array `c`  
4-element array `c[i]`

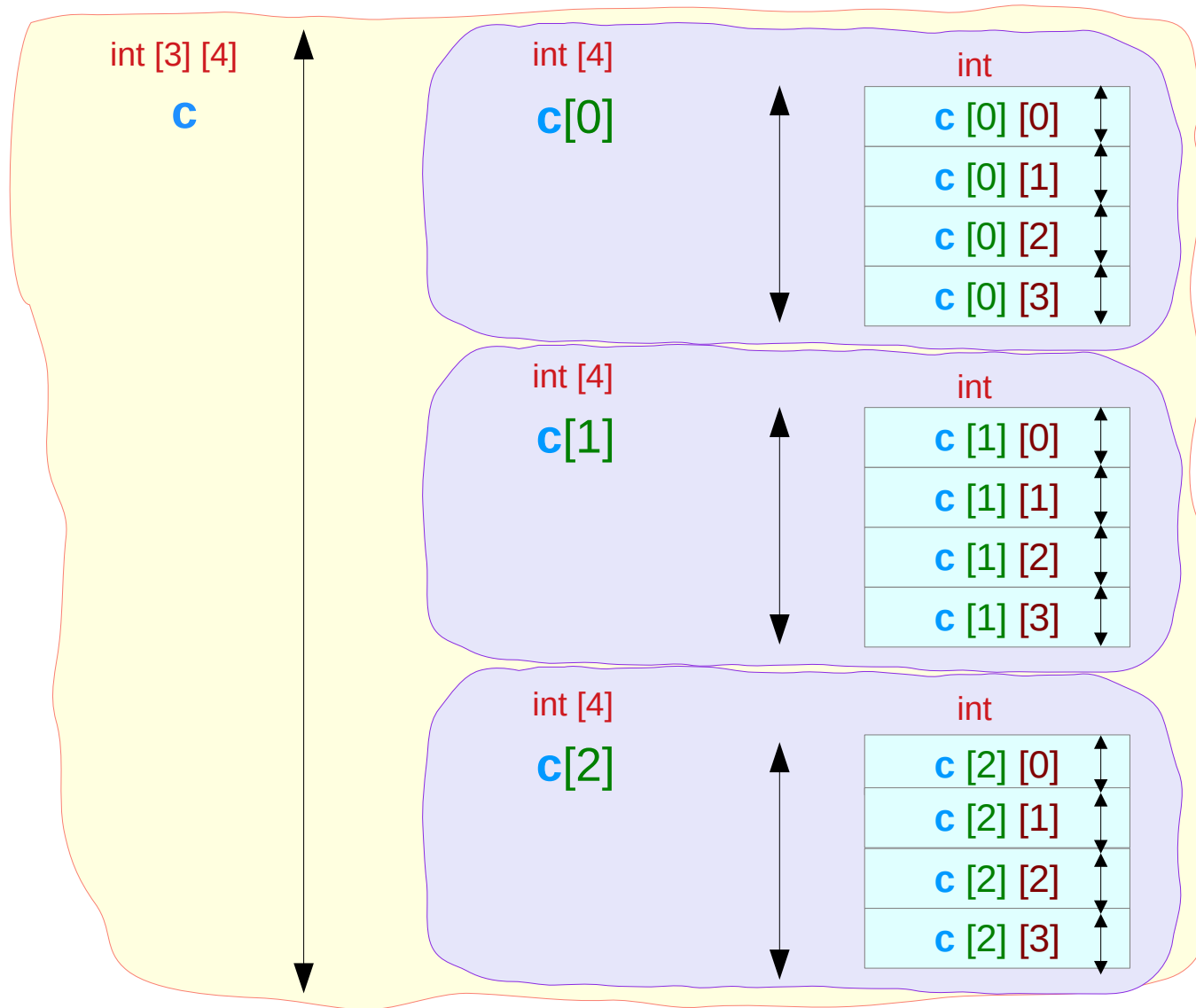

# Pointer view

<b>c</b>	<b>2-d array</b>	<b>int [3][4]</b>
<b>c</b>	<b>1-d array pointer</b>	<b>int (*)[4]</b>
<b>c[i]</b>	<b>1-d array</b>	<b>int [4]</b>
<b>c[i]</b>	<b>0-d array pointer</b>	<b>int (*)</b>
<b>c[i][j]</b>	<b>0-d array</b>	<b>int</b>

**int**   **c[3]**   **[4] ;**

$$\begin{aligned}
 v(\mathbf{c}) &= v(\mathbf{c}[0]) = v(\&\mathbf{c}[0][0]) \\
 v(\mathbf{c}[1]) &= v(\&\mathbf{c}[1][0]) \\
 v(\mathbf{c}[2]) &= v(\&\mathbf{c}[2][0])
 \end{aligned}$$

$v \equiv \text{value}$

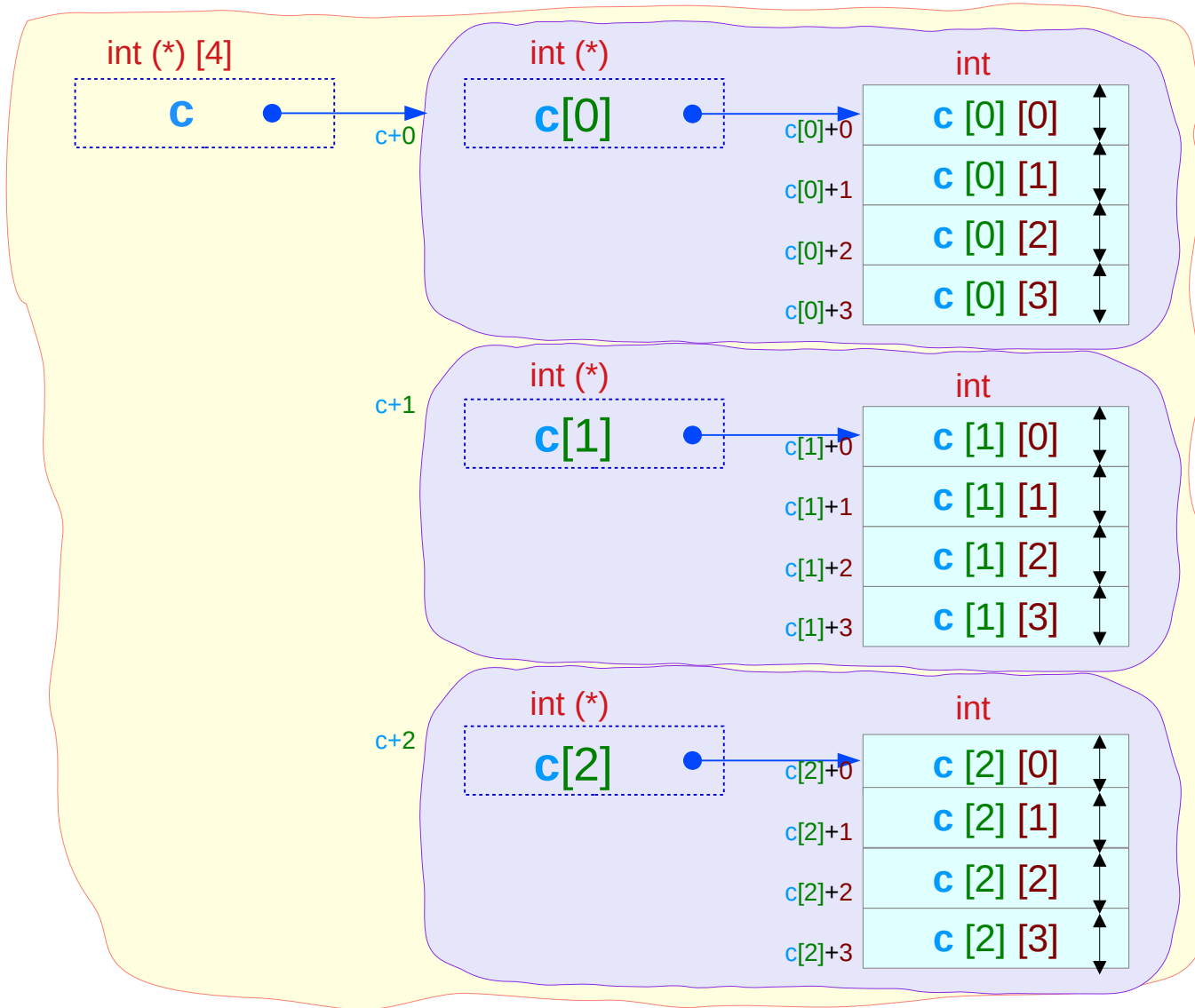



# 1-d array pointer

```
int (*p) [4];
```

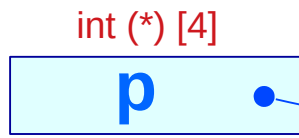

```
int c[3] [4];
```

$$\begin{aligned} v(c) &= v(c[0]) = v(\&c[0][0]) \\ v(c[1]) &= v(\&c[1][0]) \\ v(c[2]) &= v(\&c[2][0]) \end{aligned}$$

$v \equiv$  value

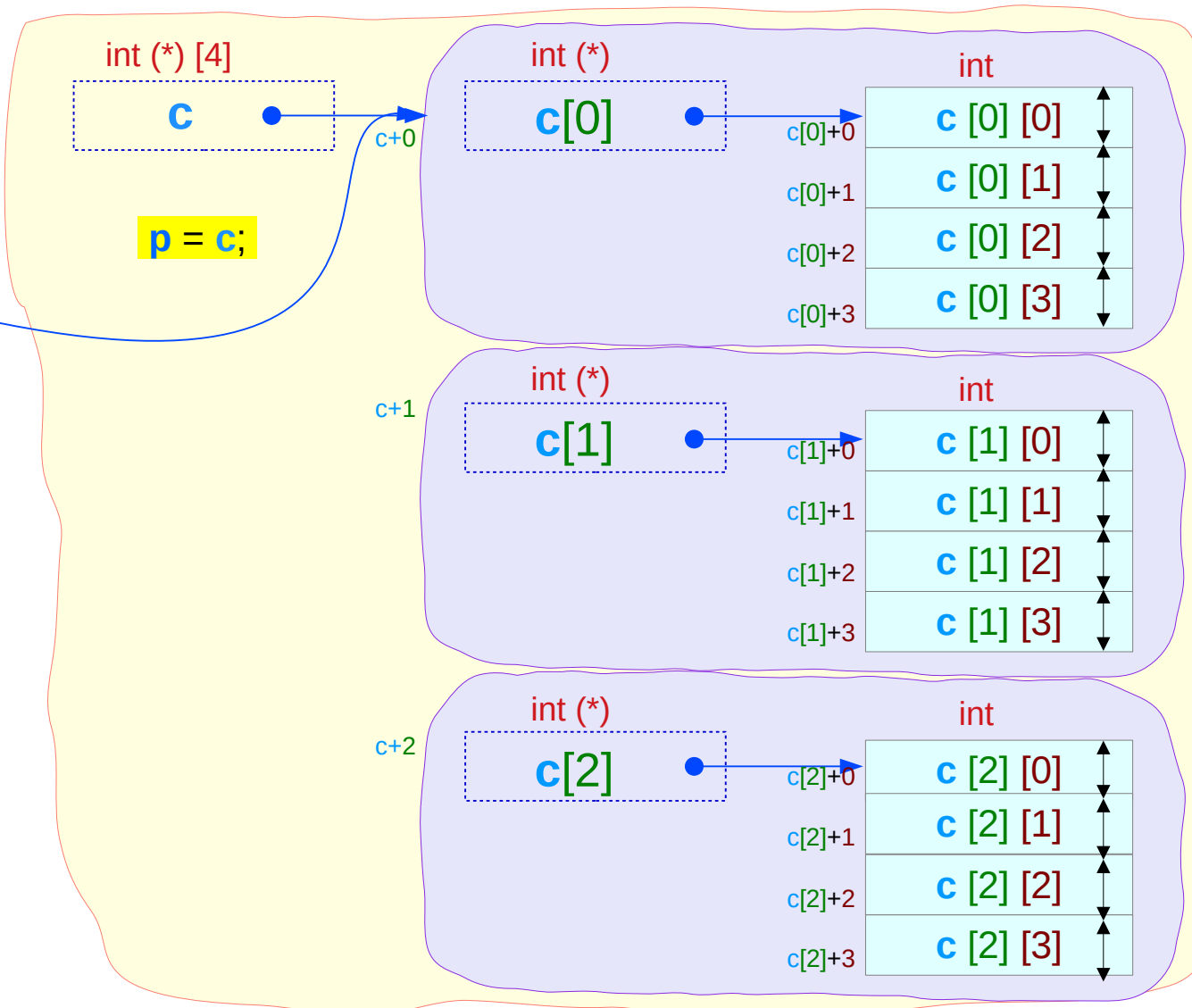

# Pointer $c[i]$ and integer $c[i][0]$

```
int c[3][4];
```

non-real pointer  $c[i]$  :  $\text{value}(c[i]) = \&c[i][0]$

0-d array pointer

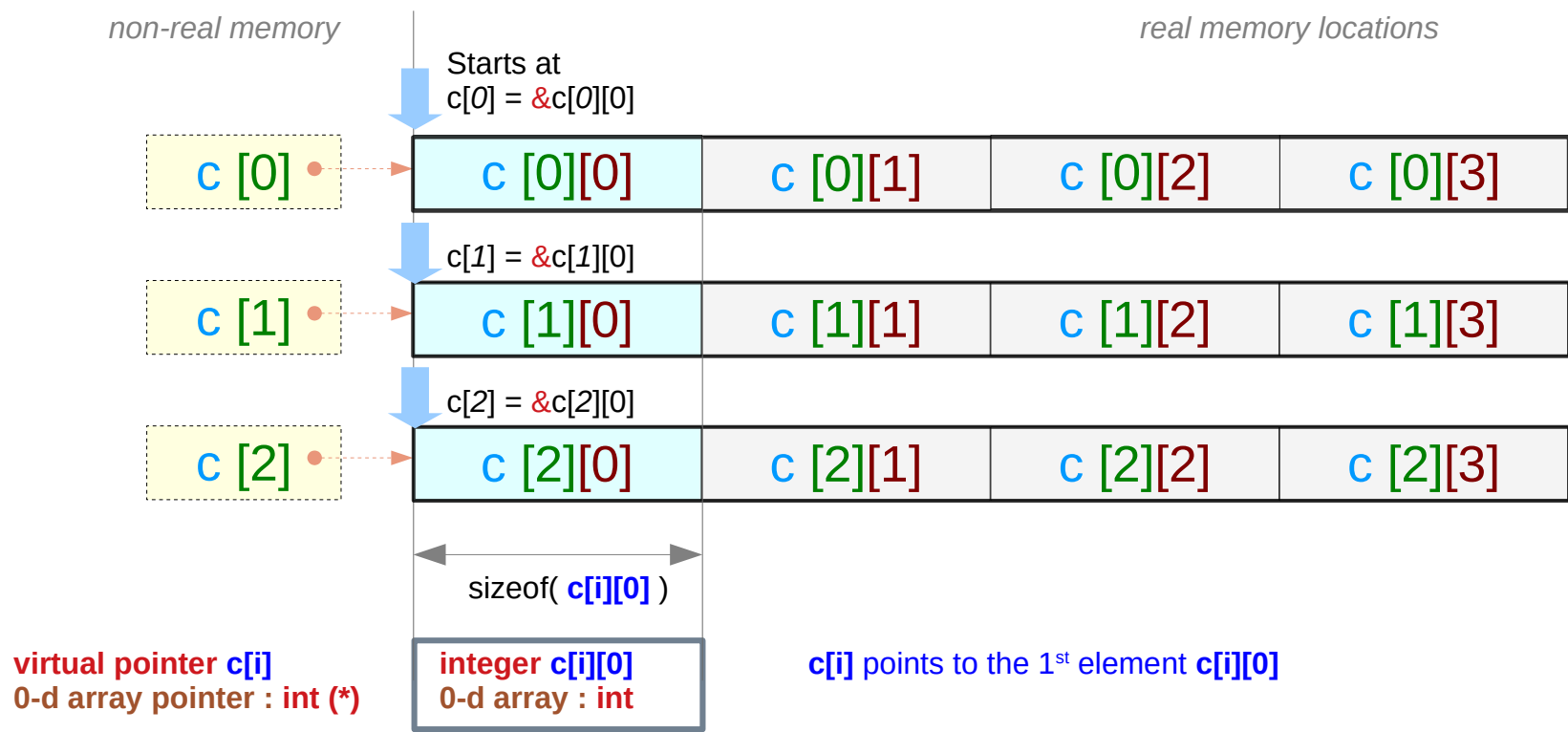

# Pointer **c** and abstract data **c[i]**

```
int c [3] [4];
```

non-real pointer **c** :  $\text{value}(c) = \&c[0] = \&c[0][0]$   
abstract data **c[i]** :  $\text{sizeof}(c[i]) = 4 * \text{sizeof}(\text{int})$

**1-d** array pointer  
**1-d** array

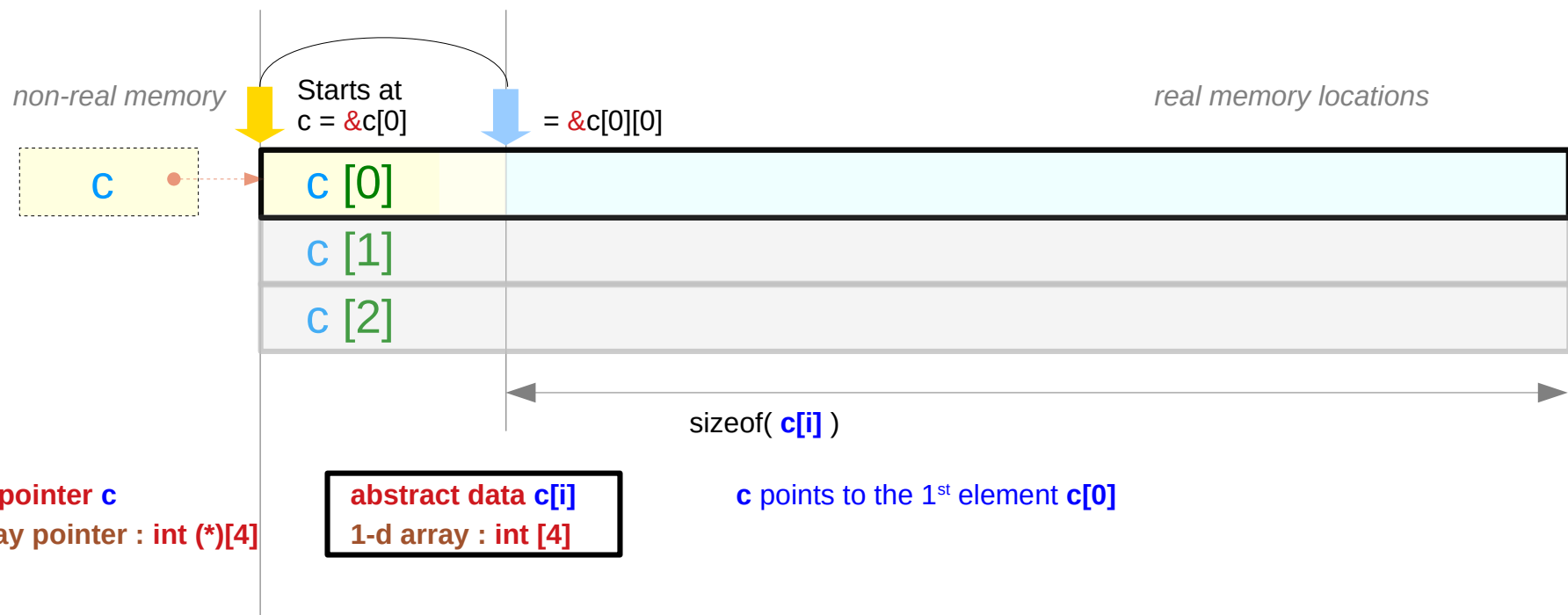

# Abstract data **c**

```
int c [3] [4];
```

abstract data **c**:  $\text{sizeof}(\mathbf{c}) = 3 * \text{sizeof}(\mathbf{c}[\mathbf{i}])$

**2-d** array

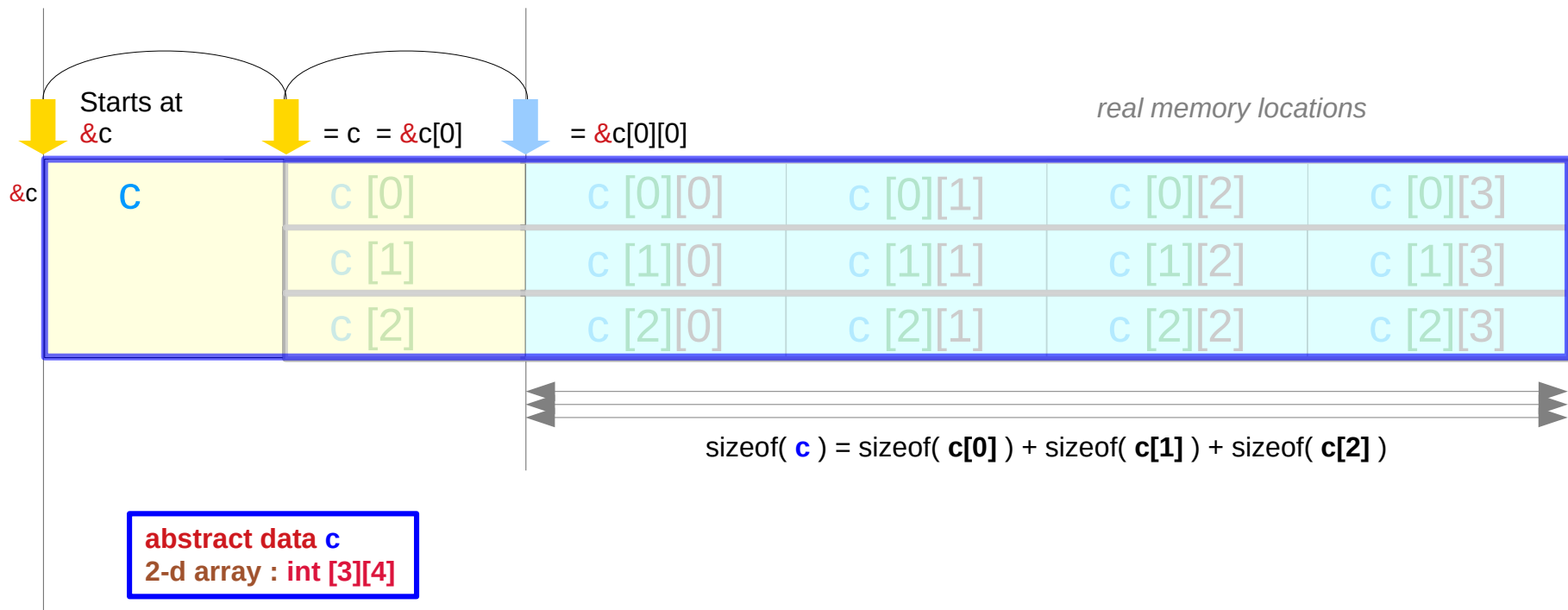

# Rows and columns of a 2-d array **c**

```
int c[3][4];
```

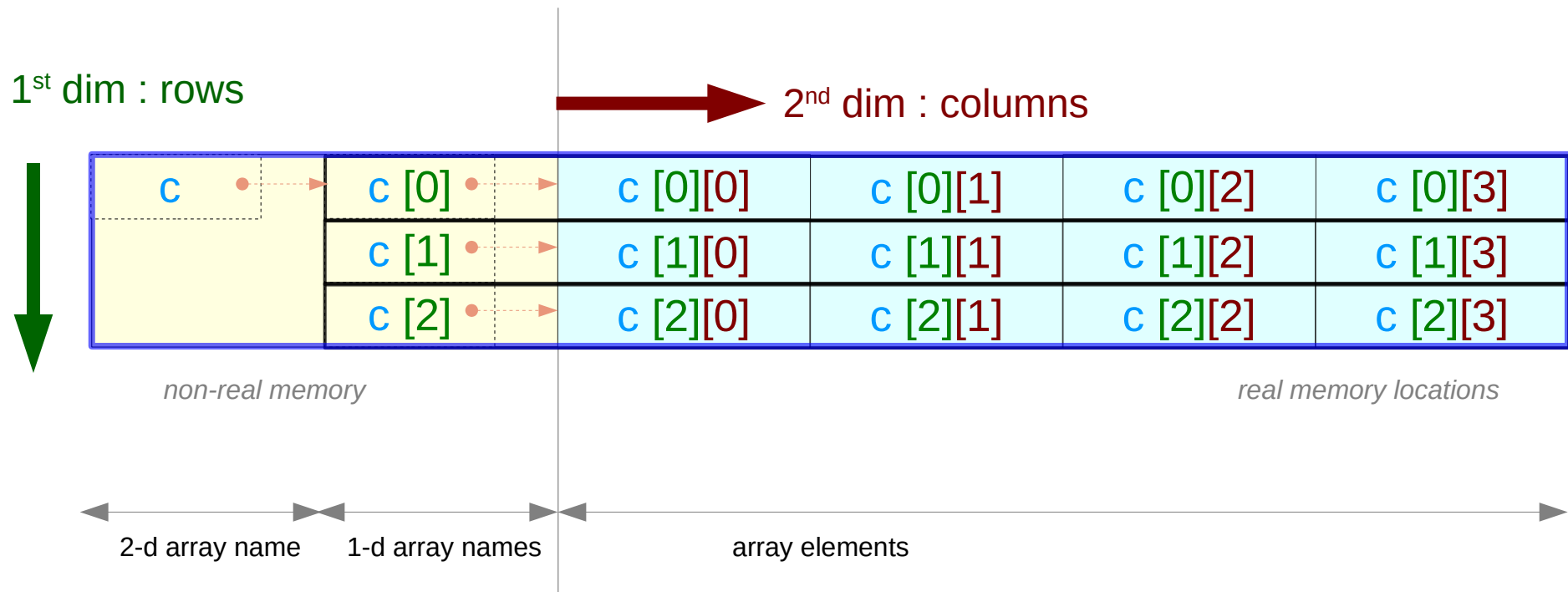

---

# Determining types of sub-arrays

## from the declaration of an array

# Types of array names

```
int a[4];
```

**a** is the name of the 1-d array

**int [4]**

`sizeof(a)` = 4 \* 4

[3] is declared;  
[0], [1], [2] are used

```
int c[3][4];
```

**c[i]** is the name of the 1-d subarray

**int [4]**

`sizeof(c[i])` = 4 \* 4

```
int c[3][4];
```

**c** is the name of the 2-d array

**int [3][4]**

`sizeof(c)` = 3 \* 4 \* 4

# Values of array names



the value of **a** is the starting address of an array with 4 elements of **int** type

**int (\*)**

**a**: pointer to the first element

**a = &a[0]**

[3] is declared;  
[0], [1], [2] are used

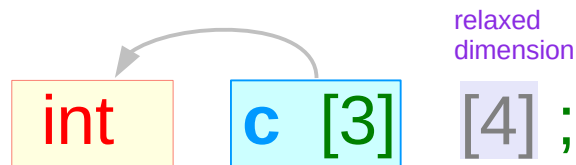

each value of **c[i]** is the starting address of an array with 4 elements of **int** type

**int (\*)**

**c[i]**: pointer to the first element

**c[i] = &c[i][0]**

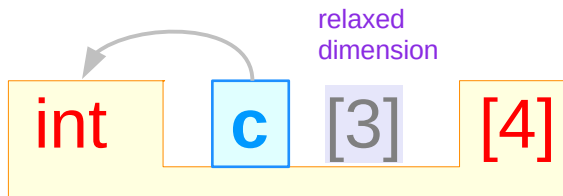

the value of **c** is the starting address of an array with 3 elements of **int [4]** type

**int (\*) [4]**

**c**: pointer to the first element

**c = &c[0]**



# Array and pointer types in a 1-d array

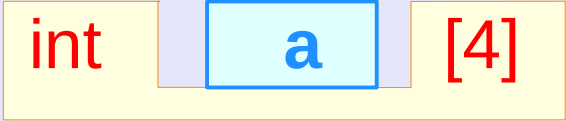

**a** 1-d array  
type : `int [4]`  
size : `4 * 4`

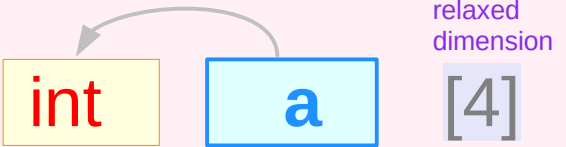

**a** 0-d array pointer  
type : `int (*)`  
value : `&a[0]`

a points to the 1<sup>st</sup> `int` element  
there are 4 `int` elements

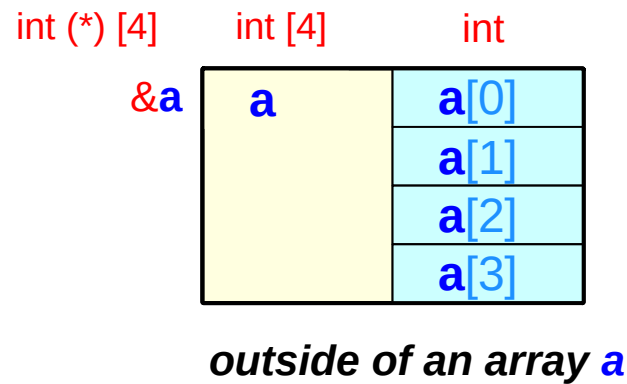

`int (*) [4]`    `int [4]`    `int`

`&a`    **a**    `a[0]`  
`a[1]`  
`a[2]`  
`a[3]`

*outside of an array a*

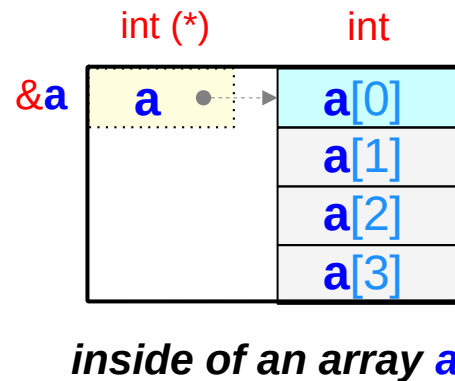

`int (*)`    `int`

`&a`    **a**    `a[0]`  
`a[1]`  
`a[2]`  
`a[3]`

*inside of an array a*

# 2-d array type

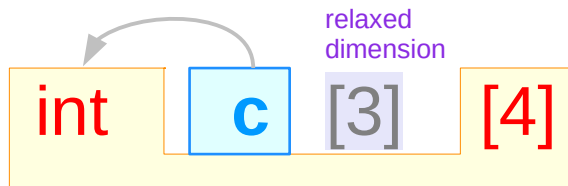
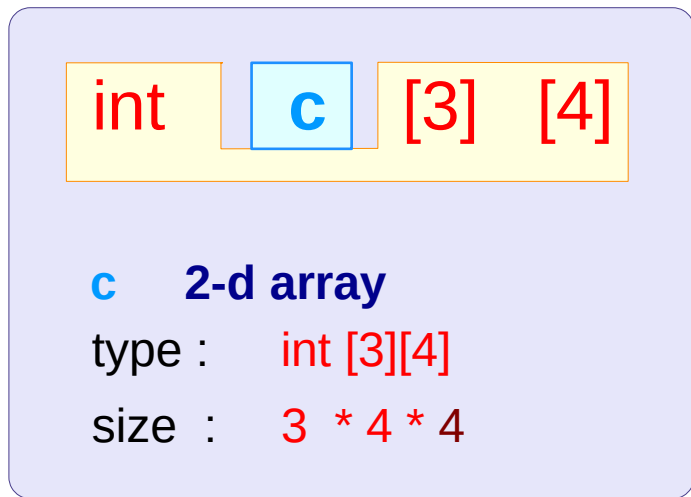

int (\*) [3][4]  
&c

int [3][4]	int [4]	int
<b>c</b>	<b>c</b> [0]	<b>c</b> [0][0]
		<b>c</b> [0][1]
		<b>c</b> [0][2]
		<b>c</b> [0][3]
	<b>c</b> [1]	<b>c</b> [1][0]
		<b>c</b> [1][1]
		<b>c</b> [1][2]
		<b>c</b> [1][3]
	<b>c</b> [2]	<b>c</b> [2][0]
		<b>c</b> [2][1]
		<b>c</b> [2][2]
		<b>c</b> [2][3]

outside of an array **c**  
 (**c** as an abstract data)

# 1-d array pointer type

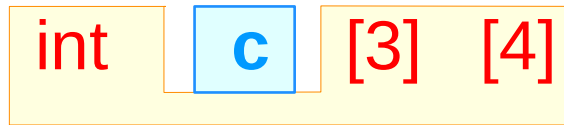

**c** 2-d array

type : `int [3][4]`

size : `3 * 4 * 4`

A diagram showing the declaration of a 1D array pointer. It consists of three boxes: a yellow box containing the text 'int', a blue box containing the text 'c', and a yellow box containing the text '[3] [4]'. An arrow points from the 'c' box to the first '[4]' box, with the text 'relaxed dimension' written above it.

**c** 1-d array pointer

type : `int (*) [4]`

value : `c = &c[0][0]`

**c** points to the 1<sup>st</sup> `int [4]` element  
There are 3 `int [4]` elements

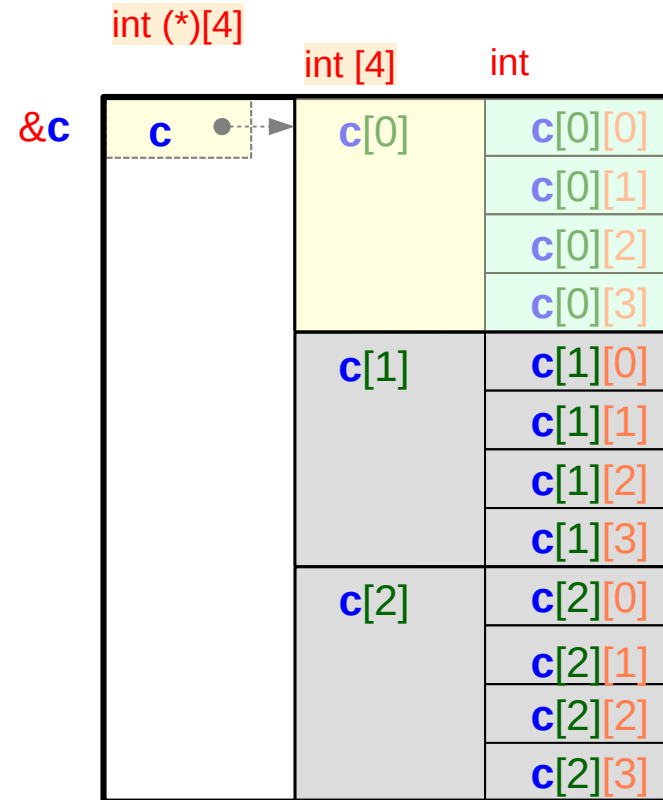

# 1-d array type

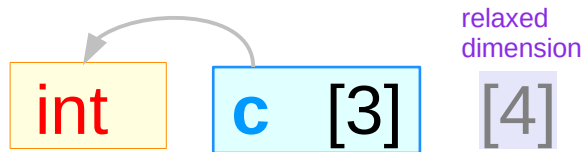
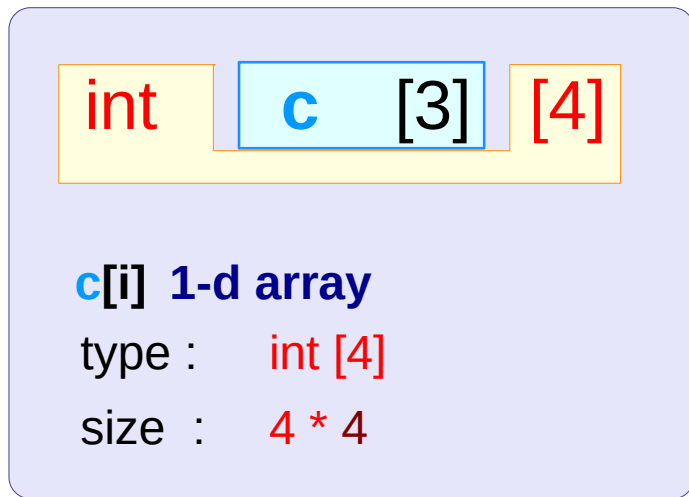

**c[i] 0-d array pointer**

type : `int (*)`

value : `c[i] = &c[i][0]`

`c[i]` points to the 1<sup>st</sup> `int` element  
There are 4 `int` elements

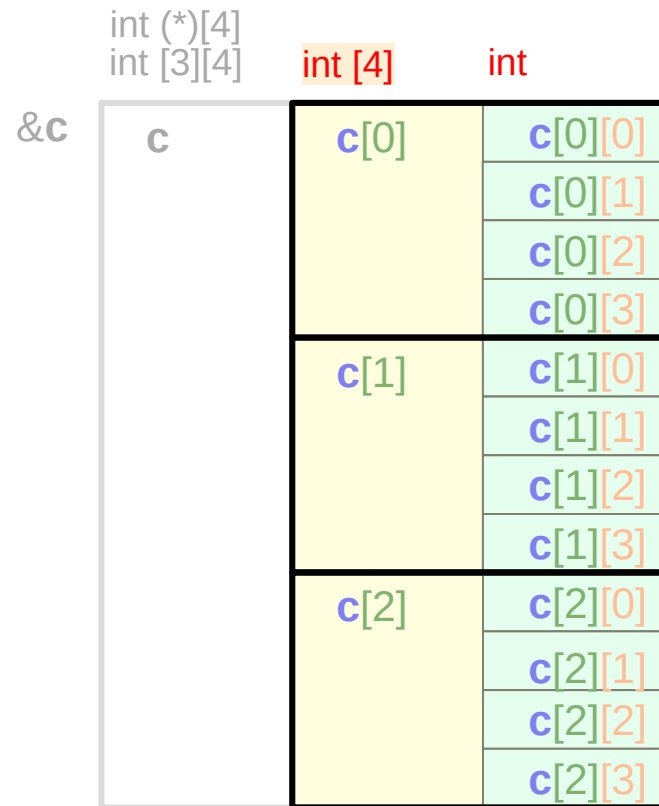

# 0-d array pointer type

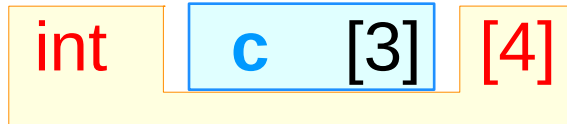

**c[i]** 1-d array

type : int [4]

size : 4 \* 4

A diagram showing a yellow box labeled 'int' pointing to a light blue box labeled 'c' with '[3]' and '[4]' next to it. A purple label 'relaxed dimension' points to the '[4]'.

**c[i]** 0-d array pointer

type : int (\*)

value :  $c[i] = \&c[i][0]$

**c[i]** points to the 1<sup>st</sup> int element  
There are 4 int elements

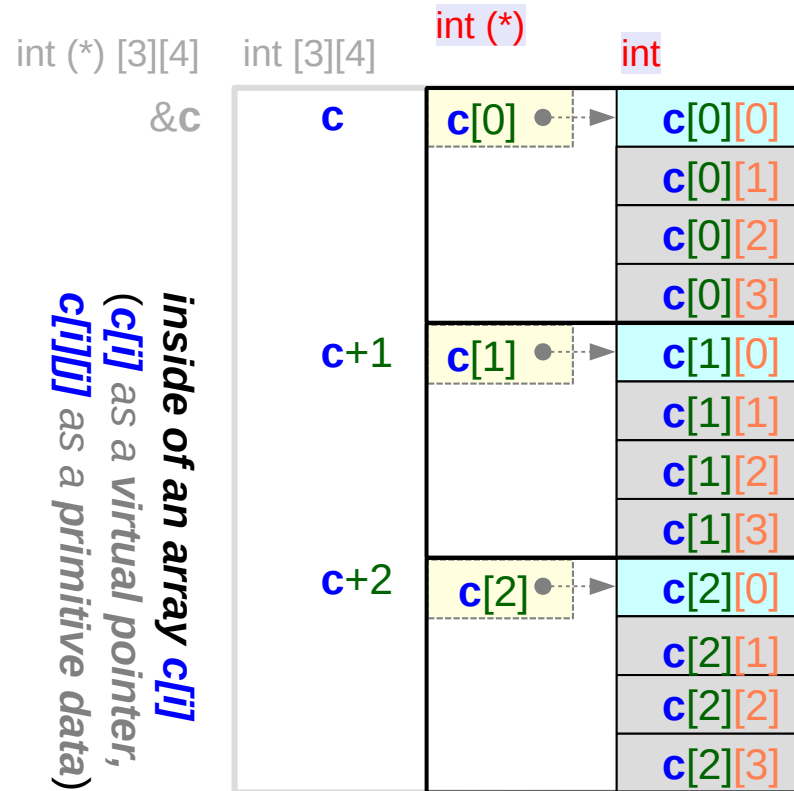

# Types in a 2-d array

**int** **c** [3] [4]

**c** 2-d array  
type : **int [3][4]**  
size : **3 \* 4 \* 4**

relaxing the 1<sup>st</sup> dimension



**int** **c** [3] [4]

**c** 1-d array pointer (virtual)  
type : **int (\*) [4]**  
value : **&c[0][0]**

relaxed dimension

**int** **c** [3] [4]

**c[i]** 1-d array  
type : **int [4]**  
size : **4 \* 4**

relaxing the 1<sup>st</sup> dimension

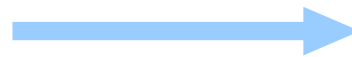

**int** **c** [3] [4]

**c[i]** 0-d array pointer (virtual)  
type : **int (\*)**  
value : **&c[i][0]**

relaxed dimension

# The name of a 2-d array

```
int    a [4];
```

```
int    c [4] [4];
```

1. the name of the nested array (recursive definition)
2. a double pointer
3. a pointer to an array

# 2-d array c and 1-d array q

```
int c [3] [4];
```

c	c[0]	c[0]+0	c[0][0]
		c[0]+1	c[0][1]
		c[0]+2	c[0][2]
		c[0]+3	c[0][3]
	c[1]	c[1]+0	c[1][0]
		c[1]+1	c[1][1]
		c[1]+2	c[1][2]
		c[1]+3	c[1][3]
	c[2]	c[2]+0	c[2][0]
		c[2]+1	c[2][1]
		c[2]+2	c[2][2]
		c[2]+3	c[2][3]

```
int q [3*4];
```

q	q+0	q[0*4+0]
	q+1	q[0*4+1]
	q+2	q[0*4+2]
	q+3	q[0*4+3]
	q+4	q[1*4+0]
	q+5	q[1*4+1]
	q+6	q[1*4+2]
	q+7	q[1*4+3]
	q+8	q[2*4+0]
	q+9	q[2*4+1]
	q+10	q[2*4+2]
	q+11	q[2*4+3]



# 2-d and 1-d interpretations of linear memories

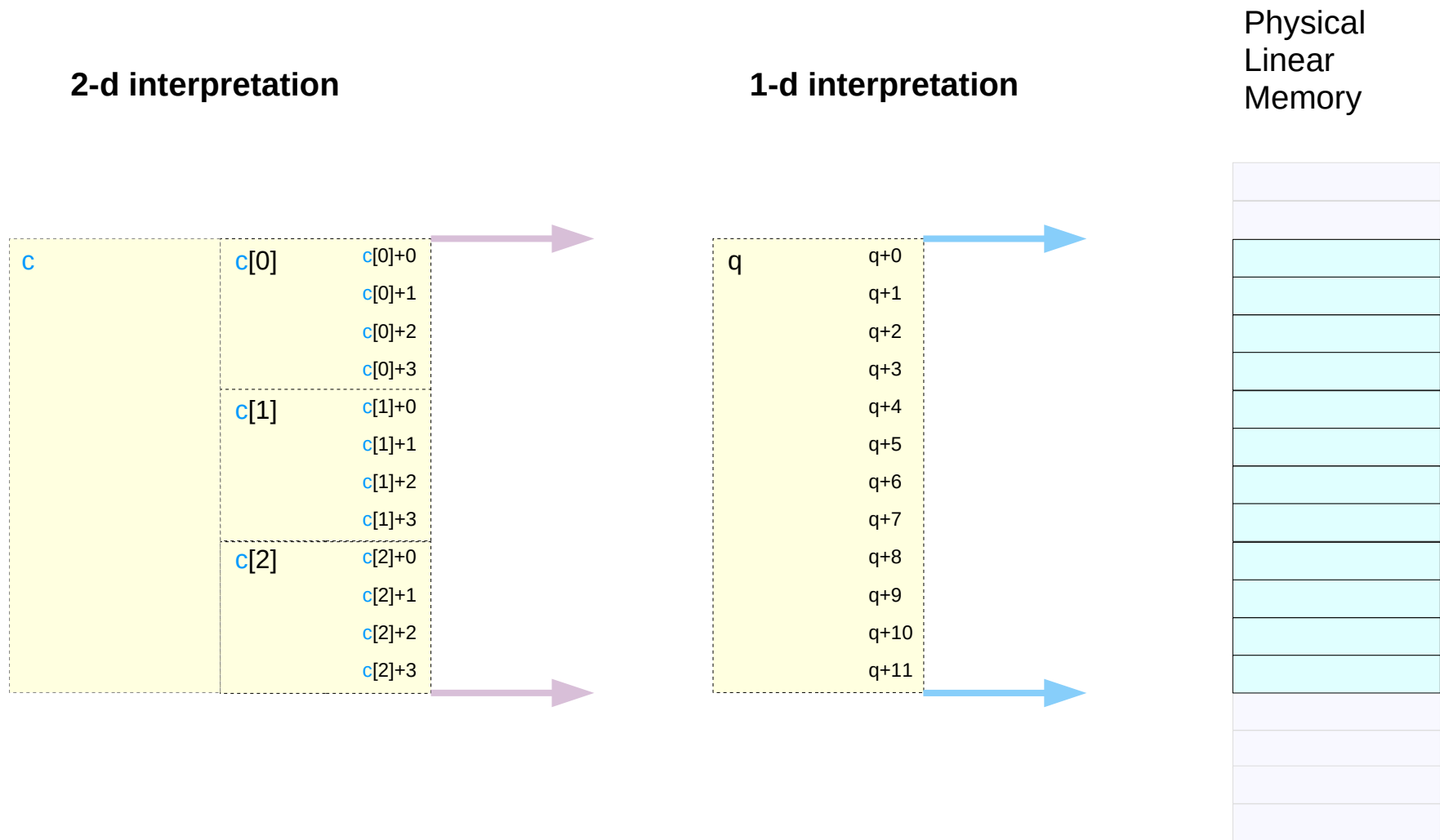

# A 2-d array stored as a 1-d array (row major order)

```
int c [3] [4];
```

```
c[i][j]
```

```
[i*4+j]
```

```
[k]
```

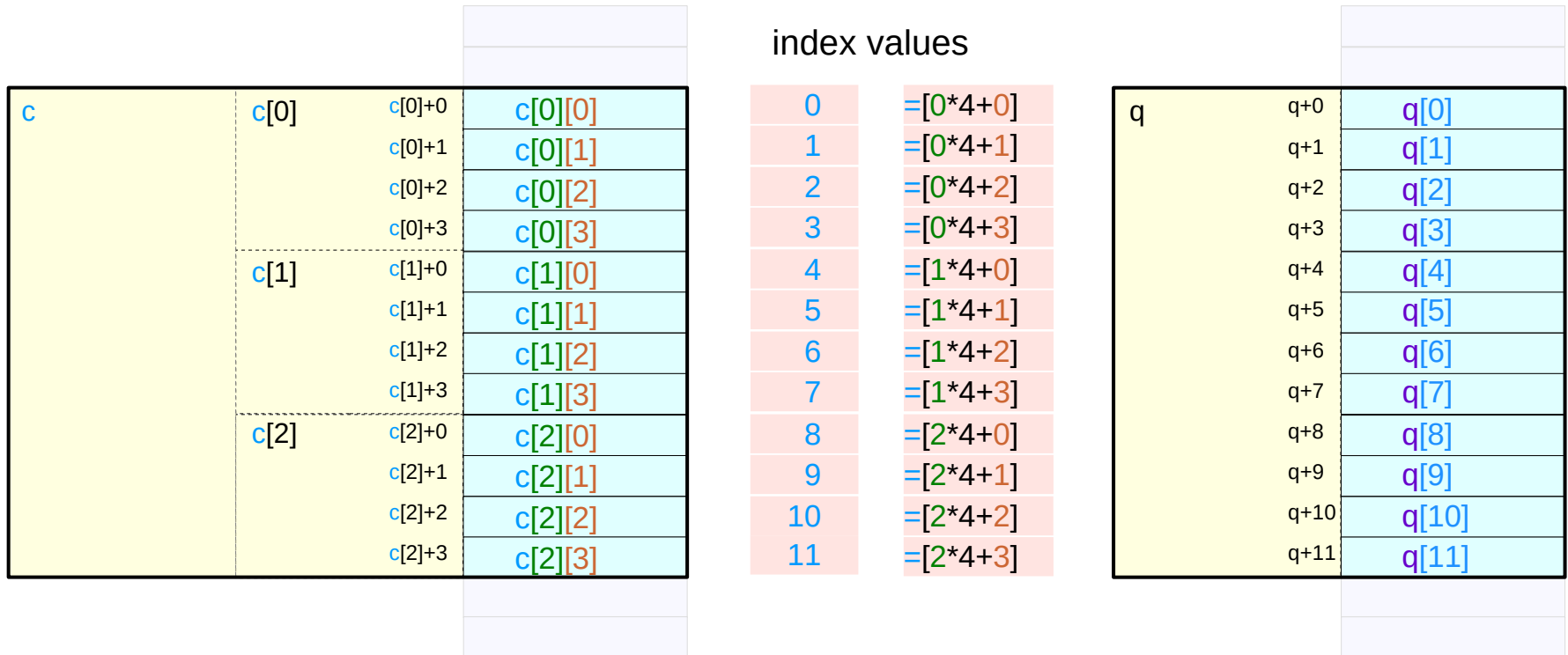

## 2-d array access via a single pointer

```
int *p = c[0];
```



```
int c [3][4];
```

```
p[ i*4 + j ]
```



```
c[ i ][ j ]
```

```
*(p + i*4 + j)
```



```
*(*(c+i)+ j)
```

```
*(p +k)    i = k / 4;  
           j = k % 4;
```

# View a 2-d array as a 1-d array

```
int c [3][4];
```

```
int *p = c[0];
```

c, c[0],  
&c[0][0]

0-d array pointer int (\*)

p

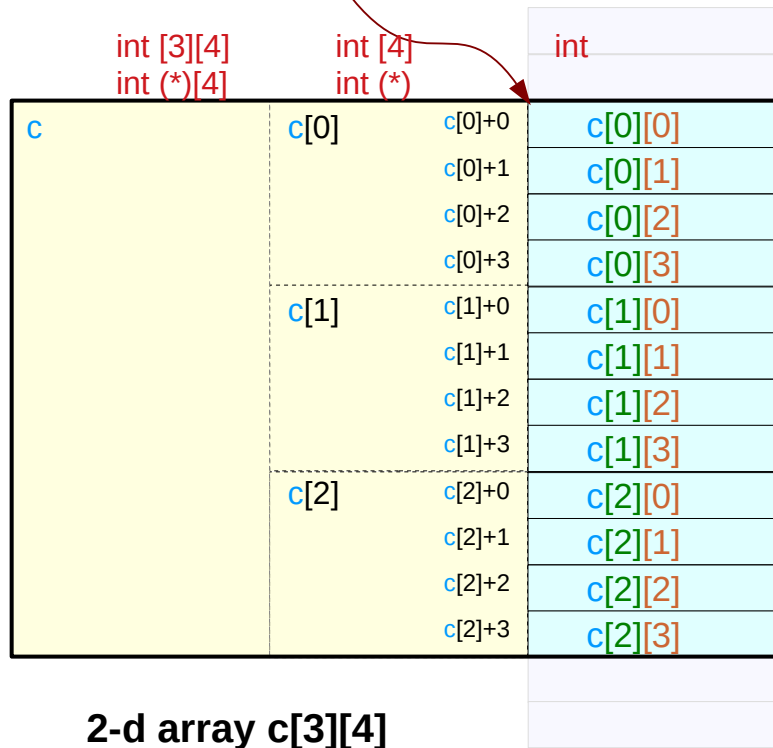

0-d array pointer int (\*)

p

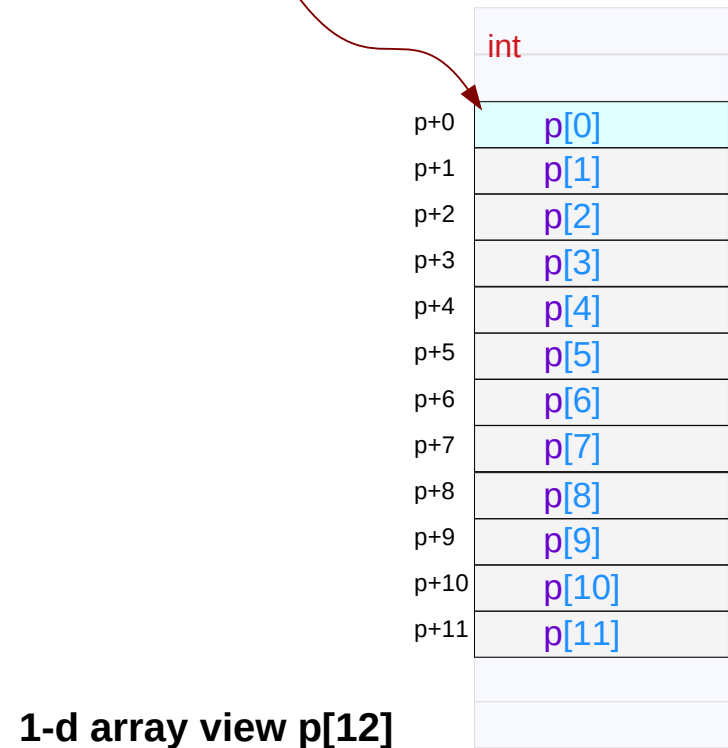

# View a 2-d array as another 2-d array

```
int c [3][4];
```

```
int (*q) [3] = (int (*) [3]) c;
```

`c`, `c[0]`,  
&`c[0][0]`

1-d array pointer `int (*) [3]`

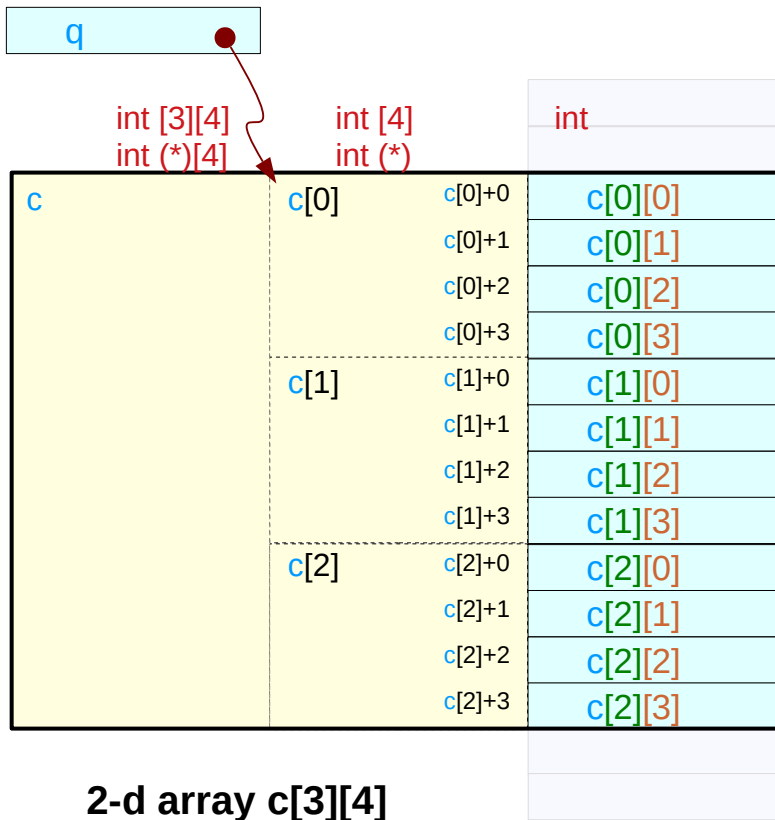

1-d array pointer `int (*) [3]`

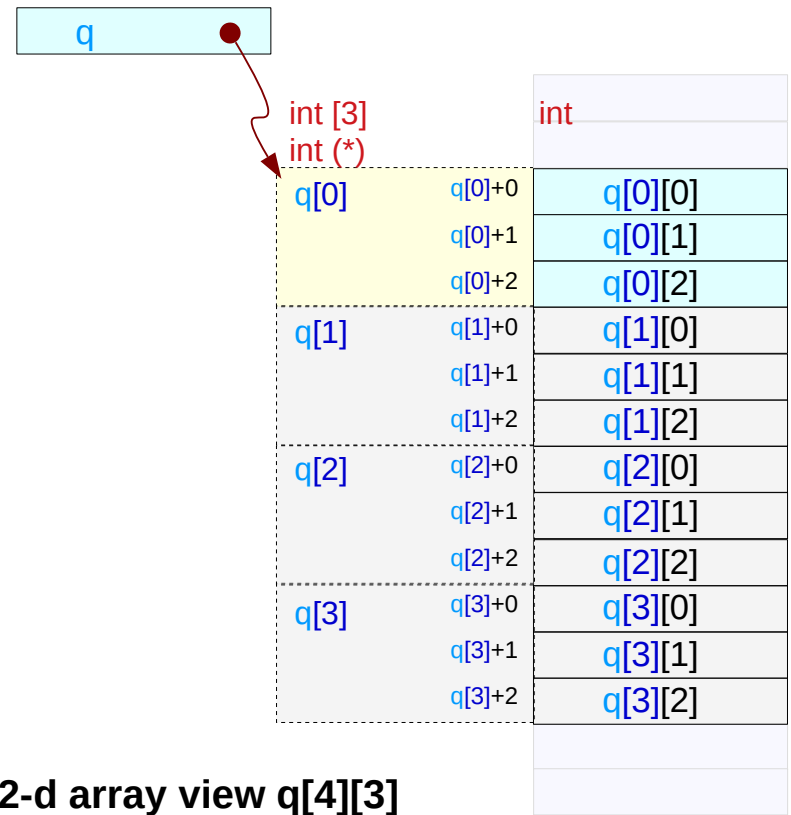

# A 2-d array stored as a 1-d array (row major order)

```
int c [3] [4];
```

```
int (*r) [2][2] = (int (*) [2][2]) c;
```

c, c[0],  
&c[0][0]

2-d array pointer int (\*) [2][2]

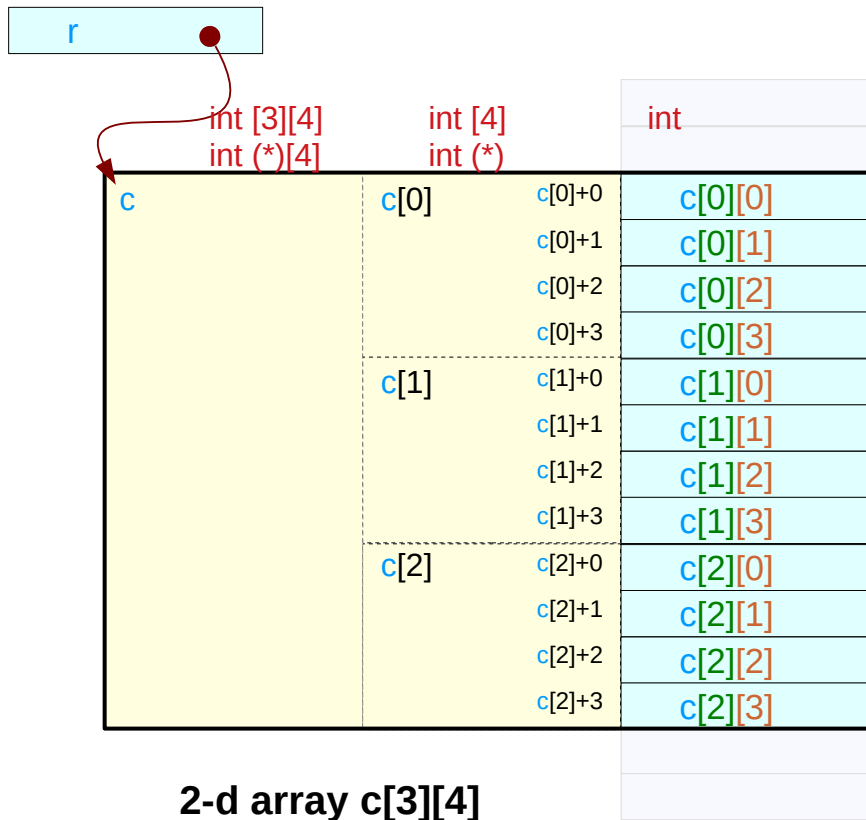

2-d array pointer int (\*) [2][2]

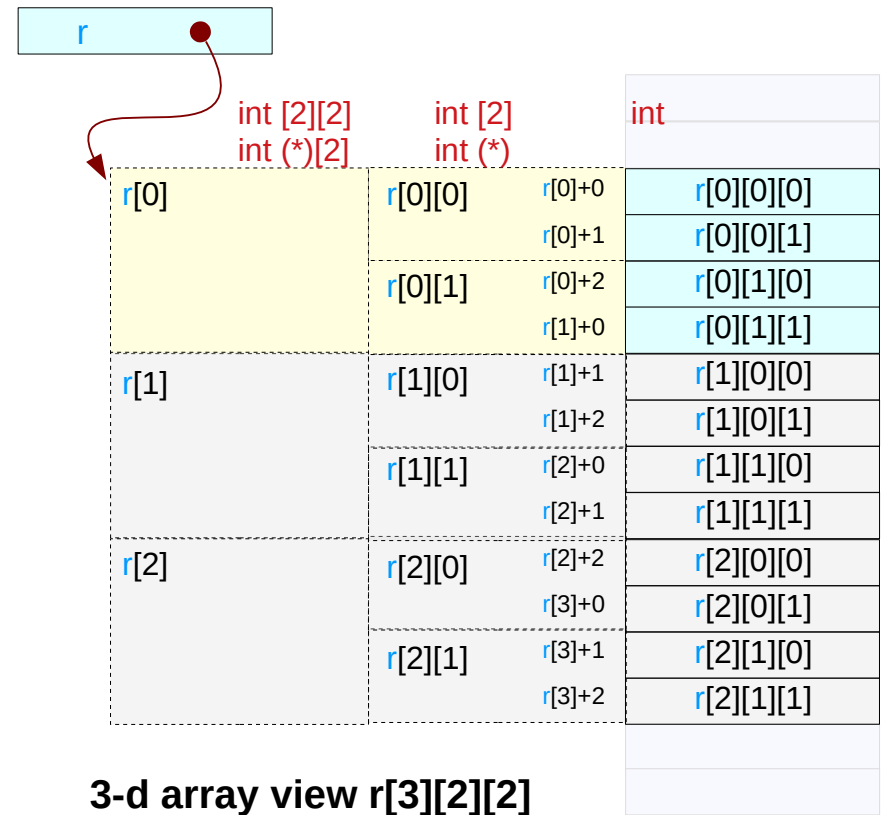

## 2-d array access via pointers

```
int c [3][4];
```

### 1. recursive pointers

```
c [ i ][ j ]
```

```
(*(c+i))[ j ]
```

→ `int (*p)[4];`

```
*(c[ i ]+ j)
```

```
*(*(c+i)+ j)
```

→ `int **q;`

```
int *p = c[0] ;
```

### 2. linear array pointers

```
p[ i*4 + j ]
```

```
*(p+ i*4 + j)
```

# Static Allocation of a 2-d Array

```
int A [3][4];
```

A in %eax,  
i in %edx,  
j in %ecx

```
sall    $2, %ecx           ;; j * 4  
leal   (%edx, %edx, 2), %edx  ;; i * 3  
leal   (%ecx, %edx, 4), %edx  ;; j * 4 + i * 12  
movl   (%eax, %edx), %eax     ;; read M[ XA+4(3i +j) ]
```

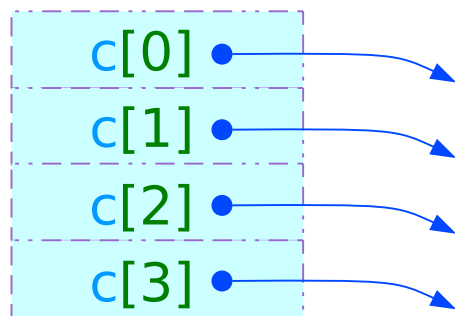

The pointer array :  
not allocated  
in the memory

c[0]+0	*(c [0]+0)
c[0]+1	*(c [0]+1)
c[0]+2	*(c [0]+2)
c[0]+3	*(c [0]+3)
c[1]+0	*(c [1]+0)
c[1]+1	*(c [1]+1)
c[1]+2	*(c [1]+2)
c[1]+3	*(c [1]+3)
c[2]+0	*(c [2]+0)
c[2]+1	*(c [2]+1)
c[2]+2	*(c [2]+2)
c[2]+3	*(c [2]+3)



---

# Pointers, arrays, and operator precedence

# Equivalences between \*, &, and [] operators

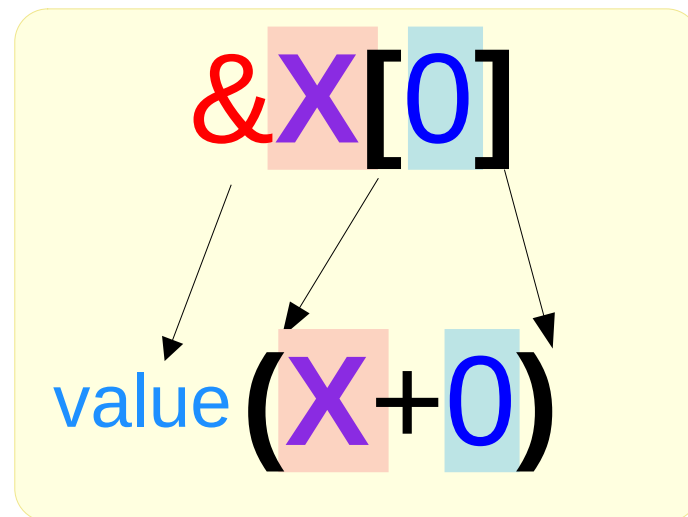
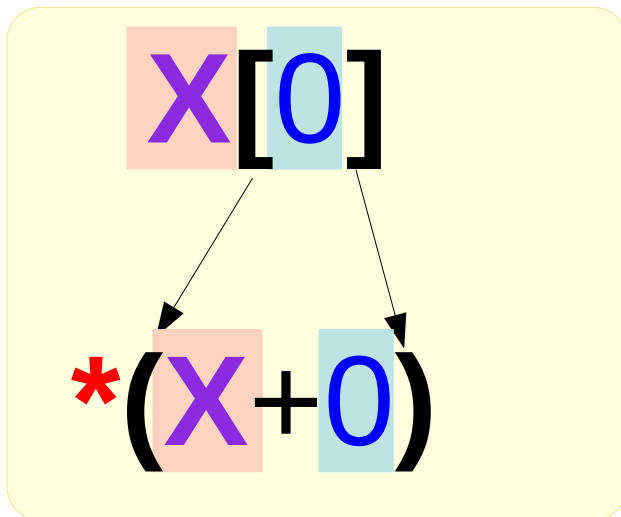
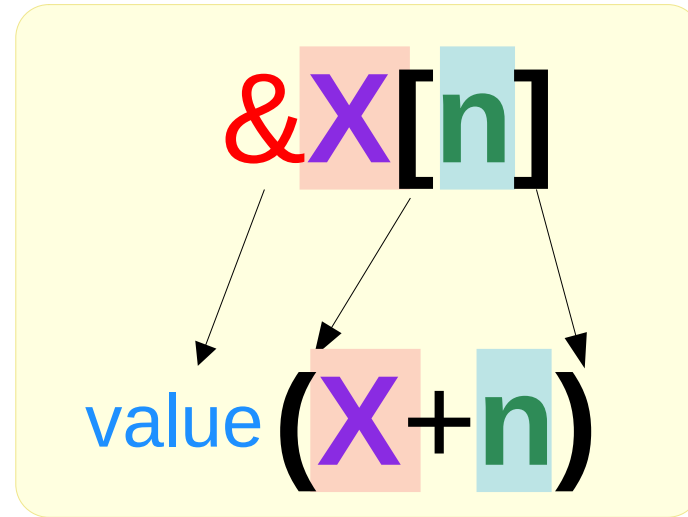
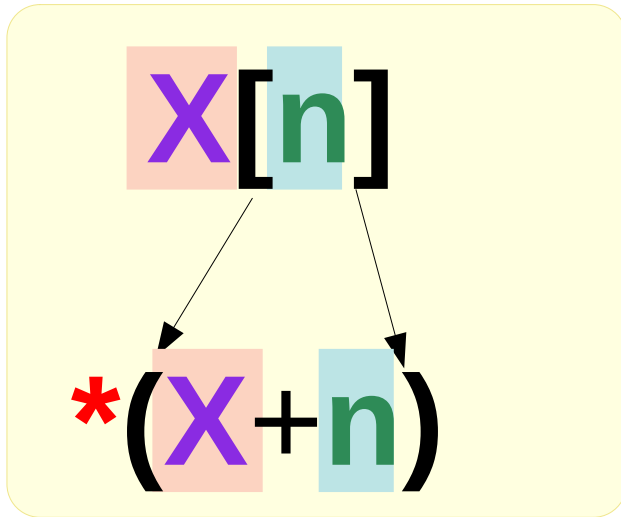

# Operator Precedence of \* and [ ]

$$*x[m] \equiv *(x[m])$$

$$x[m][n] \equiv (x[m])[n]$$

$$**x \equiv>(*x)$$

[ ] has a **higher** priority than \*

[ ] has **left-to-right** associativity

\* has **right-to-left** associativity

$$(*x)[m][n] \leftrightarrow ((*x)[m])[n]$$

red parentheses ( ) must not be removed  
gray parentheses ( ) can be removed

$$(*x[m])[n] \leftrightarrow (*(x[m]))[n]$$

# Operator Precedence of \* and [ ]

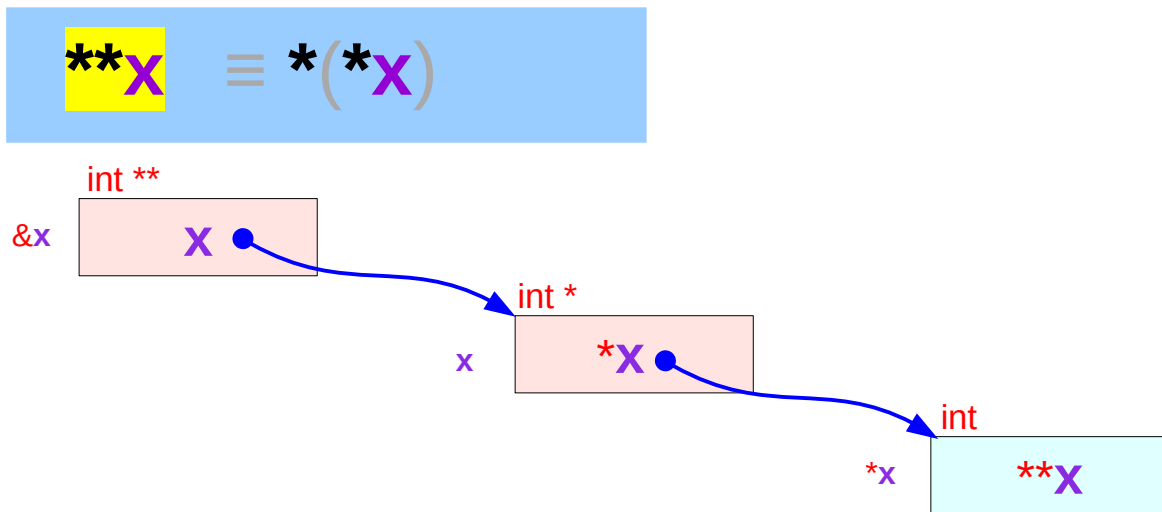
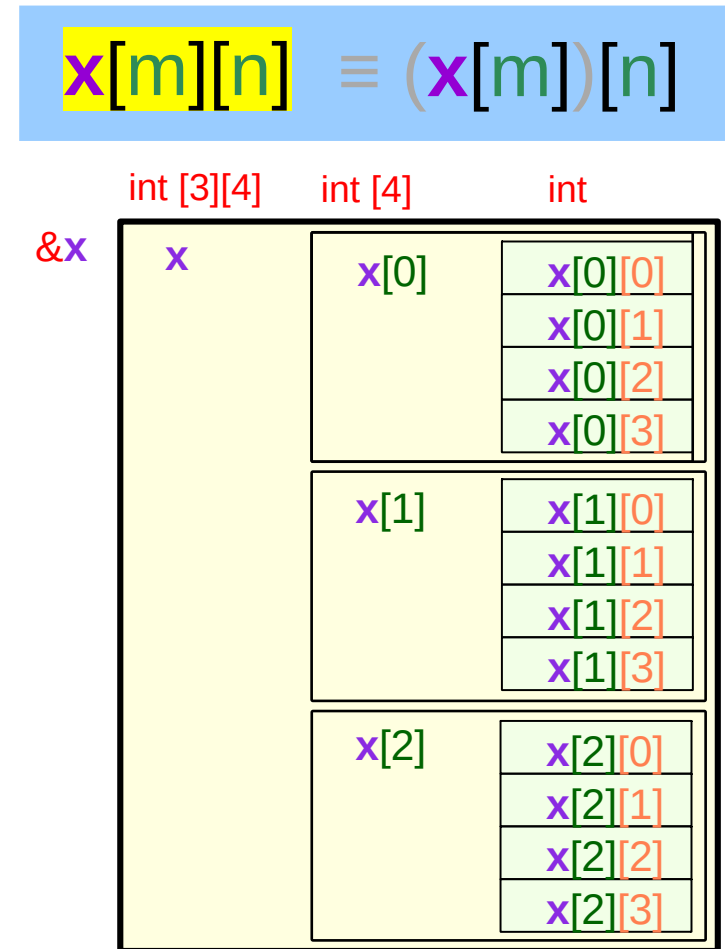
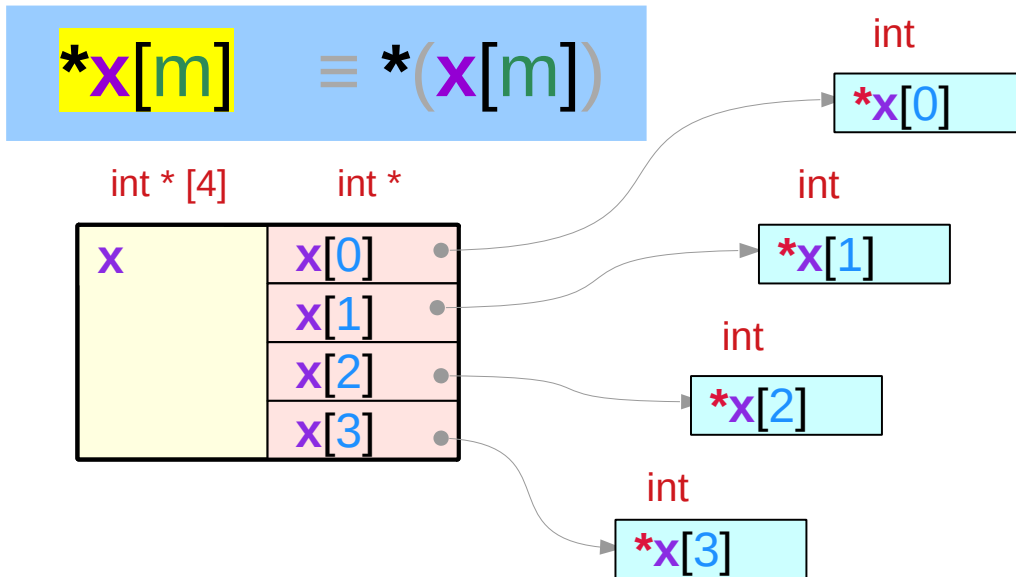

# Abstract Data $x$ and $x[i]$

$x[3]$   $x$  has 3 elements

$\text{int } [3][4]$     $\text{int } [4]$

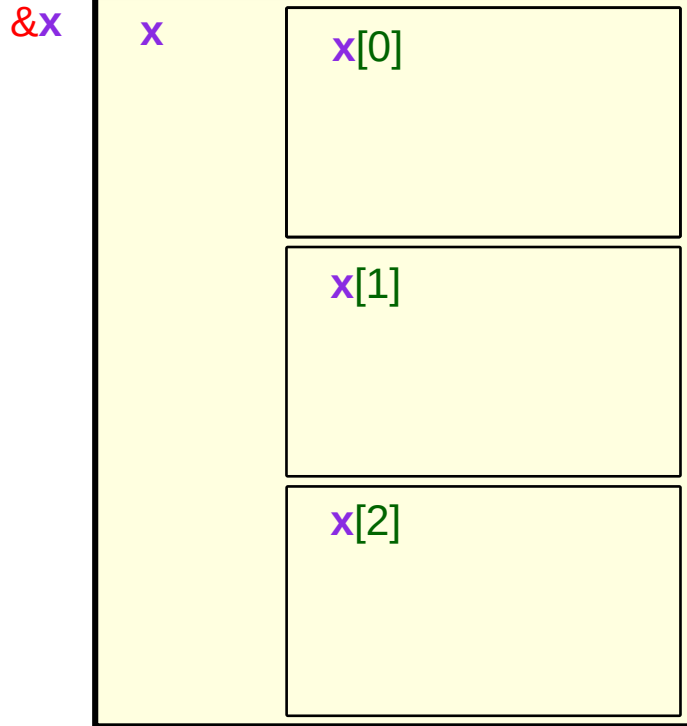

array element  $x[i]$

$(x[3])[4]$  each  $x[i]$  has 4 elements

$\text{int } [3][4]$     $\text{int } [4]$     $\text{int}$

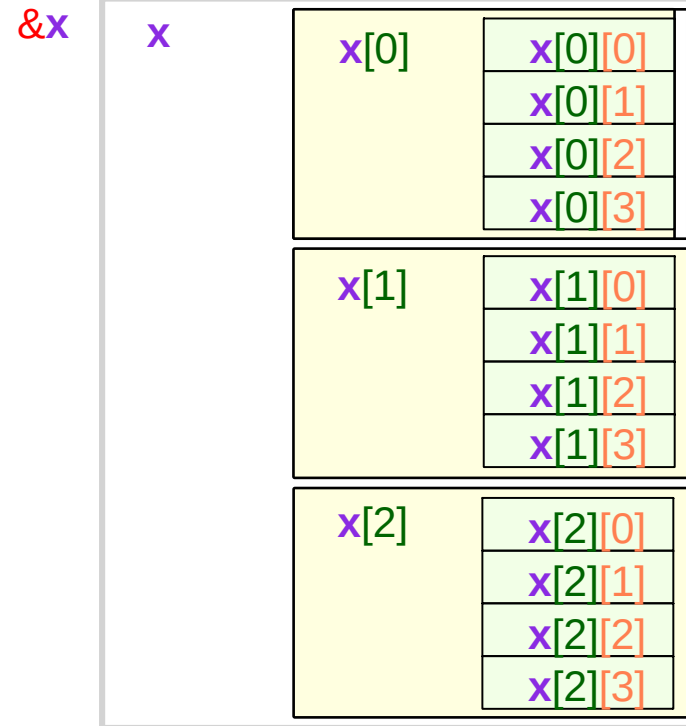

array name  $x[i][j]$

# Virtual Pointers $x$ and $x[i]$

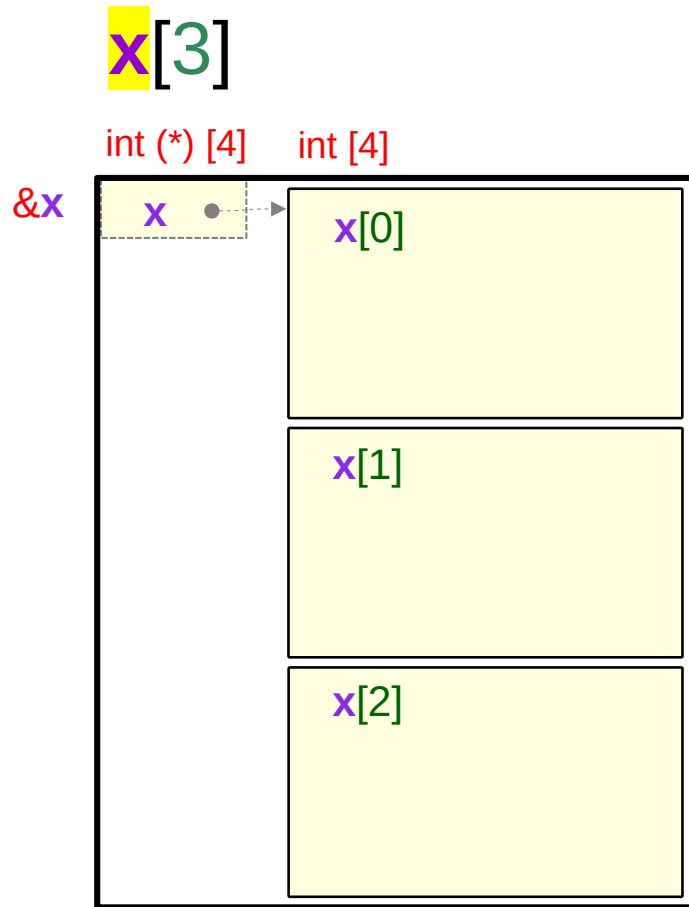

array name  $x$  ..... virtual pointer  
array element  $x[i]$  ..... abstract data

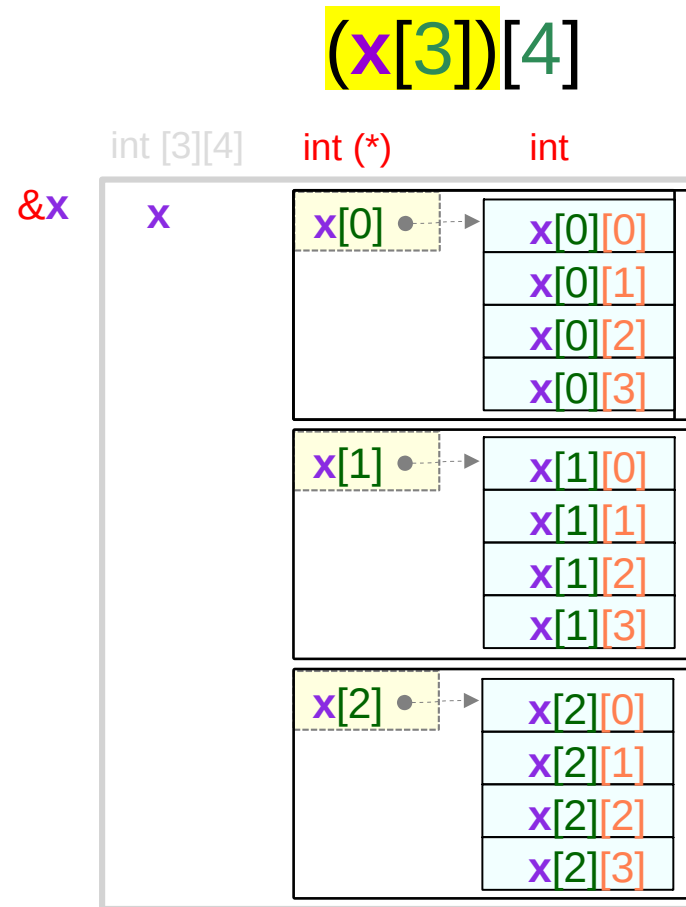

array name  $x[i]$  ..... virtual pointer  
array element  $x[i][j]$  ..... primitive data

# Left-to-right and right-to-left associative operators

$p[i] \equiv p[i]$   
 $p[i][j] \equiv (p[i])[j]$   
 $p[i][j][k] \equiv ((p[i])[j])[k]$

$\rightarrow *(p+i)$   
 $\rightarrow *(*(p+i)+j)$   
 $\rightarrow *((*(p+i)+j)+k)$

$*p \equiv *(p)$   
 $**p \equiv *((*(p))$   
 $***p \equiv *((*(*(p)))$

$\rightarrow p[0]$   
 $\rightarrow (p[0])[0]$   
 $\rightarrow ((p[0])[0])[0]$

# Equivalence on relaxing outer most dimension

$p[i] \equiv *(p+i)$   
 $p[i][j] \equiv *(p[i]+j)$   
 $p[i][j][k] \equiv *(p[i][j]+k)$

$\&p[i] \equiv \text{value}(p+i)$   
 $\&p[i][j] \equiv \text{value}(p[i]+j)$   
 $\&p[i][j][k] \equiv \text{value}(p[i][j]+k)$

$p[0] \equiv *p$   
 $p[i][0] \equiv *p[i]$   
 $p[i][j][0] \equiv *p[i][j]$

$\&p[0] \equiv \text{value}(p)$   
 $\&p[i][0] \equiv \text{value}(p[i])$   
 $\&p[i][j][0] \equiv \text{value}(p[i][j])$

valid for proper  $i, j, k$  values



# Relaxing all the dimensions

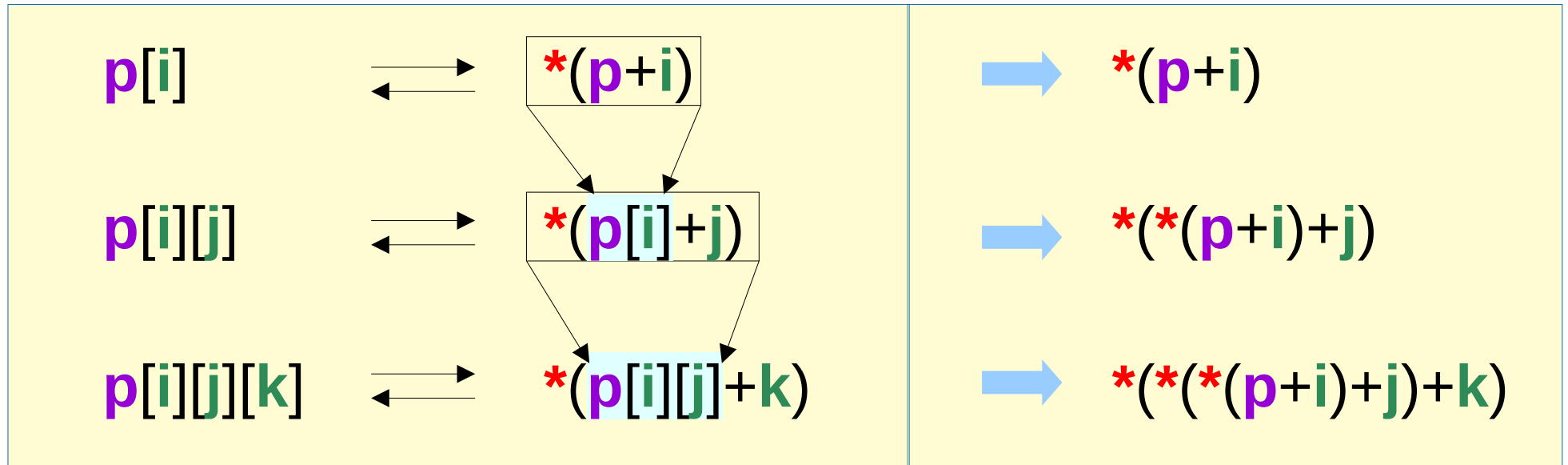

$$*(X+n) \equiv X[n]$$

valid for proper  $i, j, k$  values

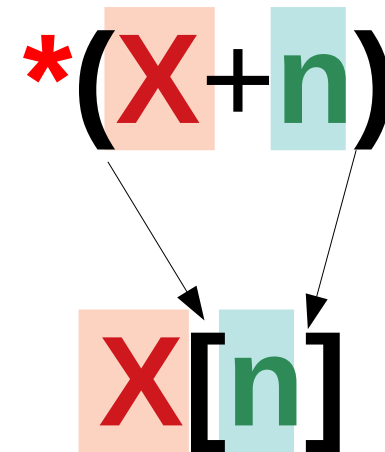

# Equivalences on relaxing all the dimensions

$p[i] \equiv *(p+i)$   
 $p[i][j] \equiv *(*p+i)+j$   
 $p[i][j][k] \equiv *(*(*p+i)+j)+k$

$\&p[i] \equiv \text{value}(p+i)$   
 $\&p[i][j] \equiv \text{value}(*p+i)+j$   
 $\&p[i][j][k] \equiv \text{value}(*(*p+i)+j)+k$

$p[0] \equiv *p$   
 $p[0][0] \equiv **p$   
 $p[0][0][0] \equiv ***p$

$\&p[0] \equiv \text{value}(p)$   
 $\&p[0][0] \equiv \text{value}(*p)$   
 $\&p[0][0][0] \equiv \text{value}(**p)$

valid for proper  $i, j, k$  values

# Address Calculation (1) Array Pointer Approach

```
int c [2][3][4] ;
```

```
c[i]      ≡ *(c + i)
c[i][j]   ≡ *(c[i] + j)
c[i][j][k] ≡ *(c[i][j] + k)
```

```
&c[i]      ≡ value(c + i)
&c[i][j]   ≡ value(c[i] + j)
&c[i][j][k] ≡ value(c[i][j] + k)
```

## address replication

```
value(c[i][j][k]) ≠ value(&c[i][j][k]) ← primitive data & address
value(c[i][j])    = value(&c[i][j])      = value(&c[i][j][0])
value(c[i])       = value(&c[i])          = value(&c[i][0][0])
value(c)          = value(&c)             = value(&c[0][0][0])
```

```
skip i elements of c
skip j elements of c[i]
skip k elements of c[i][j]
```

```
skip i*3*4 primitive elements of c
skip j*4    primitive elements of c
skip k      primitive elements of c
```

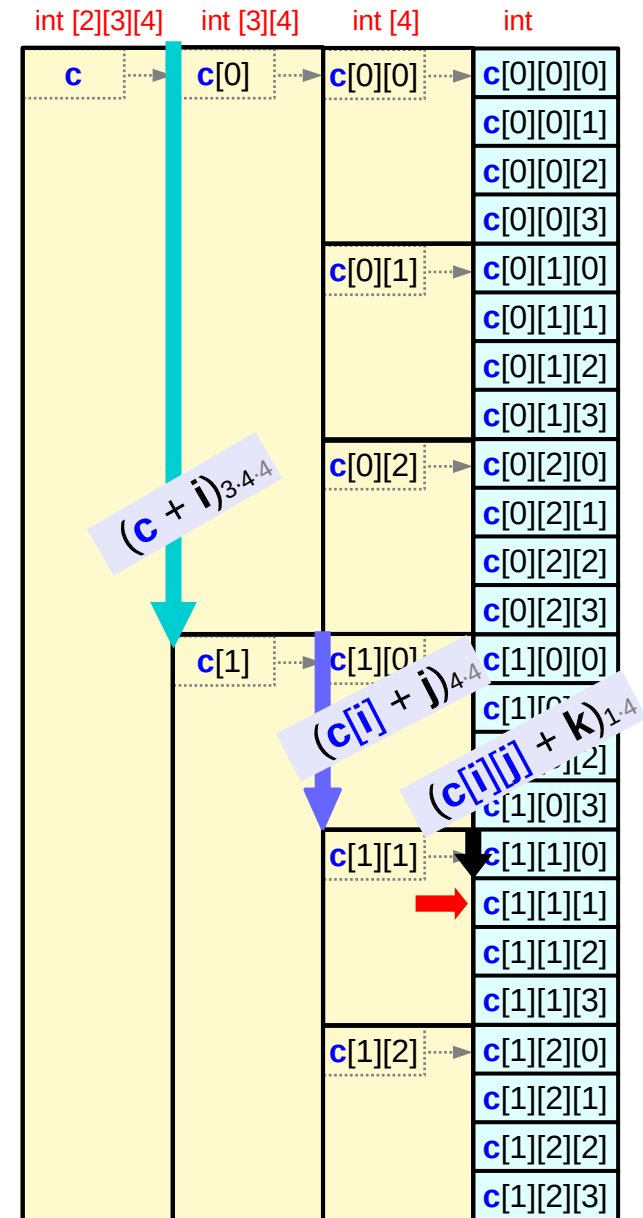

# Address Calculation (2) Pointer Array Approach

```
int ** c [2];
int *  b [2*3];
int   a [2*3*4];
```

$b[j] \equiv (a+j*4)$   
 $*(b[j]+k) = *(a+j*4+k);$   
 $b[j][k] \equiv a[j*4+k]$

$c[i] \equiv (b+i*3)$   
 $*(c[i]+j) = *(b+i*3+j);$   
 $c[i][j] \equiv b[i*3+j]$

$c[i][j] \equiv (a+(i*3+j)*4)$   
 $*(c[i][j]+k) = *(a+(i*3+j)*4+k);$   
 $c[i][j][k] \equiv a[(i*3+j)*4+k]$

$c[i] = \&b[3*i] \quad (= b + 3*i)$   
 $b[j] = \&a[4*j] \quad (= a + 4*j)$

skip  $i$  elements of  $c$  → skip  $i*3*4$  elements of  $a$   
 skip  $j$  elements of  $b$  → skip  $j*4$  elements of  $a$   
 skip  $k$  elements of  $a$  → skip  $k$  elements of  $a$

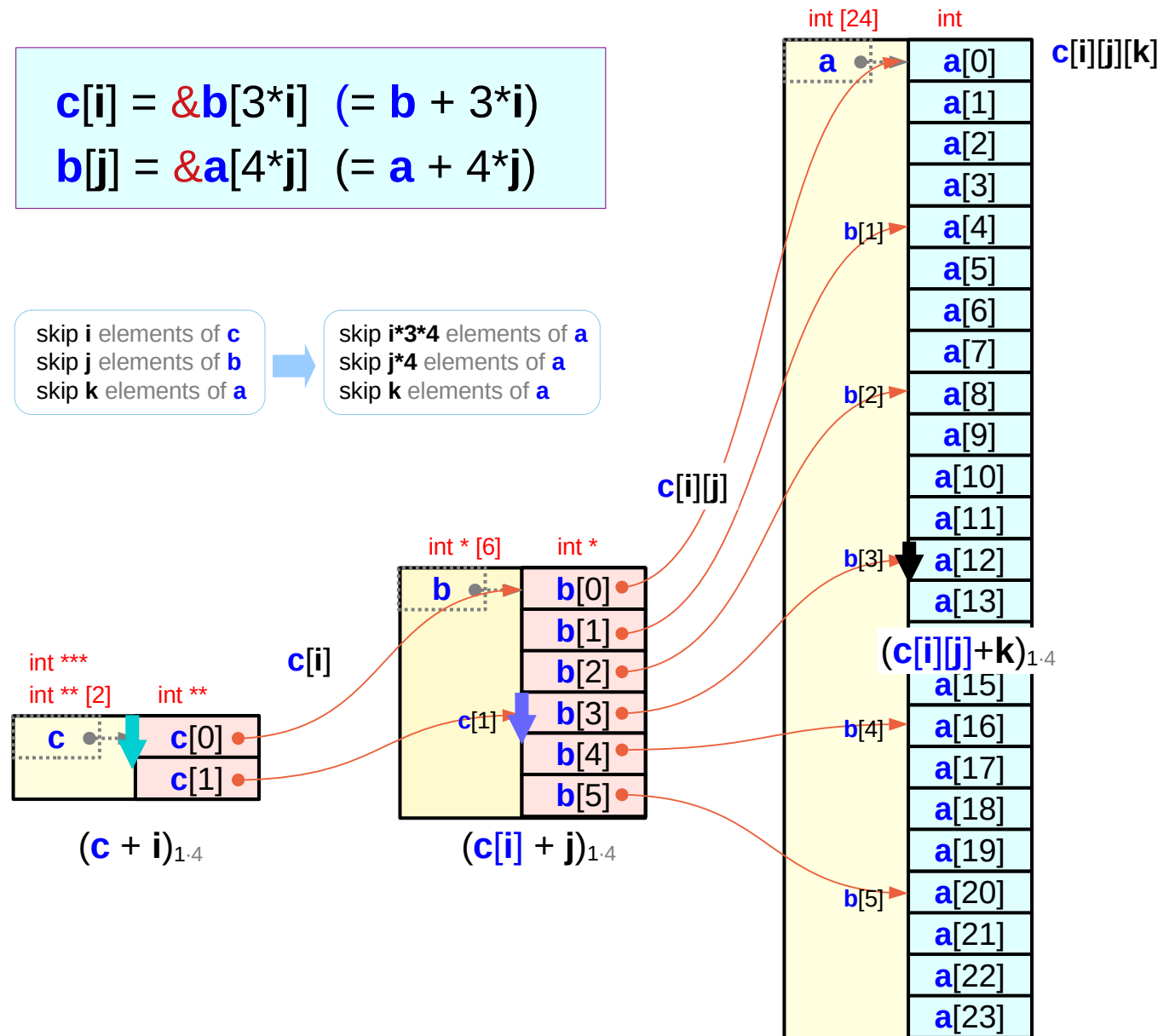

# Address Calculation (3)

$$\begin{aligned} \text{value}(\mathbf{c} + \mathbf{i}) &= \text{value}(\mathbf{c}) + \mathbf{i} * 3 * 4 * 4 \\ \text{value}(\mathbf{c}[\mathbf{i}] + \mathbf{j}) &= \text{value}(\mathbf{c}[\mathbf{i}]) + \mathbf{j} * 4 * 4 \\ \text{value}(\mathbf{c}[\mathbf{i}][\mathbf{j}] + \mathbf{k}) &= \text{value}(\mathbf{c}[\mathbf{i}][\mathbf{j}]) + \mathbf{k} * 4 \end{aligned}$$

$$\begin{aligned} \text{value}(\mathbf{c} + \mathbf{i}) &= \text{value}(\mathbf{c}) + \mathbf{i} * \text{sizeof}(*\mathbf{c}) \\ \text{value}(\mathbf{c}[\mathbf{i}] + \mathbf{j}) &= \text{value}(\mathbf{c}[\mathbf{i}]) + \mathbf{j} * \text{sizeof}(*\mathbf{c}[\mathbf{i}]) \\ \text{value}(\mathbf{c}[\mathbf{i}][\mathbf{j}] + \mathbf{k}) &= \text{value}(\mathbf{c}[\mathbf{i}][\mathbf{j}]) + \mathbf{k} * \text{sizeof}(*\mathbf{c}[\mathbf{i}][\mathbf{j}]) \end{aligned}$$

## Array Pointer Approach

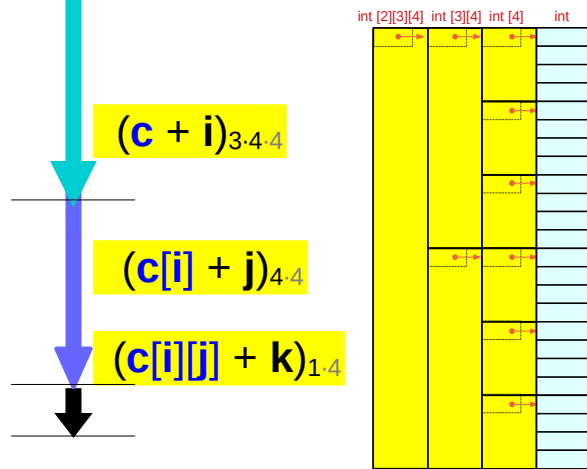

$$\begin{aligned} \mathbf{c}[\mathbf{i}] &\equiv *(\mathbf{c} + \mathbf{i}) \\ \mathbf{c}[\mathbf{i}][\mathbf{j}] &\equiv *(\mathbf{c}[\mathbf{i}] + \mathbf{j}) \\ \mathbf{c}[\mathbf{i}][\mathbf{j}][\mathbf{k}] &\equiv *(\mathbf{c}[\mathbf{i}][\mathbf{j}] + \mathbf{k}) \end{aligned}$$

$$\begin{aligned} \&\mathbf{c}[\mathbf{i}] &\equiv \text{value}(\mathbf{c} + \mathbf{i}) \\ \&\mathbf{c}[\mathbf{i}][\mathbf{j}] &\equiv \text{value}(\mathbf{c}[\mathbf{i}] + \mathbf{j}) \\ \&\mathbf{c}[\mathbf{i}][\mathbf{j}][\mathbf{k}] &\equiv \text{value}(\mathbf{c}[\mathbf{i}][\mathbf{j}] + \mathbf{k}) \end{aligned}$$

$$\begin{aligned} \text{value}(\mathbf{c} + \mathbf{i}) &= \text{value}(\mathbf{c}) + \mathbf{i} * 4 \\ \text{value}(\mathbf{c}[\mathbf{i}] + \mathbf{j}) &= \text{value}(\mathbf{c}[\mathbf{i}]) + \mathbf{j} * 4 \\ \text{value}(\mathbf{c}[\mathbf{i}][\mathbf{j}] + \mathbf{k}) &= \text{value}(\mathbf{c}[\mathbf{i}][\mathbf{j}]) + \mathbf{k} * 4 \end{aligned}$$

$$(\mathbf{c} + \mathbf{i})_{1 \cdot 4} \quad (\mathbf{c}[\mathbf{i}] + \mathbf{j})_{1 \cdot 4} \quad (\mathbf{c}[\mathbf{i}][\mathbf{j}] + \mathbf{k})_{1 \cdot 4}$$

## Pointer Array Approach

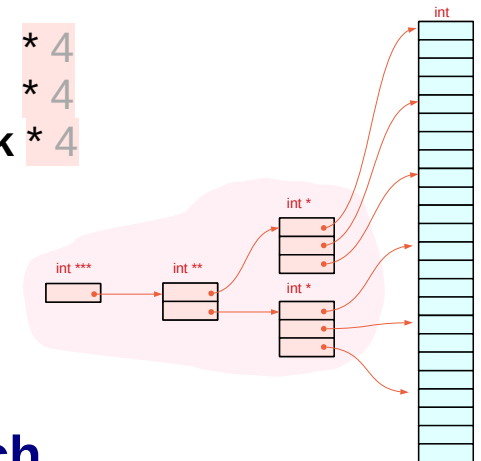

# Subscript [ ] and dereference \* notations (2a)

$p[i]$   $\longleftrightarrow$   $*(p+i)$

from  $p$ , skip  
 $i \cdot M \cdot N$  integers

$\&p[i] = \text{value}((p + i)_{M \cdot N \cdot 4})$   
 $= \text{value}(p + i * M \cdot N \cdot 4)$

$p[i][j]$   $\longleftrightarrow$   $((*(p+i)+j)$

from  $p[i]$ , skip  
 $j \cdot N$  integers

$\&p[i][j] = \text{value}((p[i] + j)_{N \cdot 4})$   
 $= \text{value}(p[i] + j * N \cdot 4)$

$p[i][j][k]$   $\longleftrightarrow$   $(**(*(p+i)+j)+k)$

from  $p[i][j]$ , skip  
 $k$  integers

$\&p[i][j][k] = \text{value}((p[i][j]+k)_{1 \cdot 4})$   
 $= \text{value}(p[i][j] + k * 1 \cdot 4)$

$\text{int } p[L][M][N]$

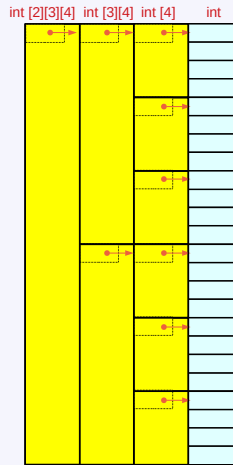

**Array Pointer Approach**

*address replications*

$\text{value}(p[i]) = \&p[i] = \text{value}(p + i)$

$\text{value}(p[i][j]) = \&p[i][j] = \text{value}(p[i] + j)$

$\&p[i][j][k] = \text{value}(p + i * M \cdot N \cdot 4 + j * N \cdot 4 + k * 4)$

# Subscript [ ] and dereference \* notations (2b)

$p[i]$   $\longleftrightarrow$   $*(p+i)$

$p[i][j]$   $\longleftrightarrow$   $((*(p+i)+j)$

$p[i][j][k]$   $\longleftrightarrow$   $((*(* (p+i)+j)+k)$

skip  $i$  pointers  
from  $p$

$\&p[i] = \text{value}(p + i)_{1..4}$   
 $= \text{value}(p + i * 4)$

skip  $j$  pointers  
from  $p[i]$

$\&p[i][j] = \text{value}(p[i] + j)_{1..4}$   
 $= \text{value}(p[i] + j * 4)$

skip  $k$  integers  
from  $p[i][j]$

$\&p[i][j][k] = \text{value}(p[i][j] + k)_{1..4}$   
 $= \text{value}(p[i][j] + k * 4)$

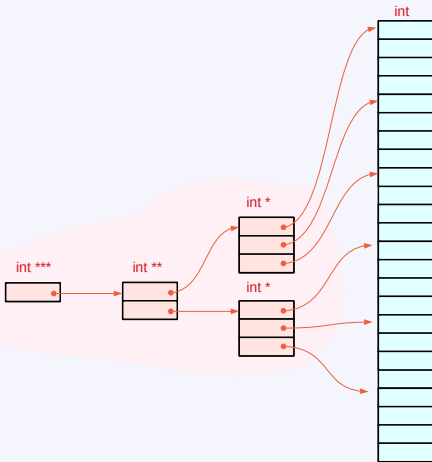

$\text{int } ** p [L];$   
 $\text{int } * q [L \cdot M];$   
 $\text{int } r [L \cdot M \cdot N];$

**Pointer Array Approach**

## address dereferences

$\text{value}(p[i]) = \&p[i] = * \text{value}(p + i)$

$\text{value}(p[i][j]) = \&p[i][j] = * \text{value}(p[i] + j)$

$\text{value}(p[i][j][k]) = \&p[i][j][k] = * \text{value}(p[i][j] + k)$

$\&p[i][j][k]$   
 $= \text{value}( * \text{value}( * \text{value}(p + i * 4) + j * 4 ) + k * 4)$

# Equivalences (3)

$p[i] \equiv *(p+i)$   
 $p[i][j] \equiv *(*p+i)+j)$   
 $p[i][j][k] \equiv *(*(*p+i)+j)+k)$

C Expressions

$\&p[i] \equiv \text{value}(p+i)$   
 $\&p[i][j] \equiv \text{value}(*p+i)+j)$   
 $\&p[i][j][k] \equiv \text{value}(*(*p+i)+j)+k)$

C Expressions

`int p [L][M][N] ;`

$\text{value}(*X) = \text{value}(X)$  (address replication)

$p[i] \longrightarrow *(p+i)_{M \cdot N \cdot 4}$   
 $p[i][j] \longrightarrow *(*p+i)_{M \cdot N \cdot 4} + j)_{N \cdot 4}$   
 $p[i][j][k] \longrightarrow *(*(*p+i)_{M \cdot N \cdot 4} + j)_{N \cdot 4} + k)_{1 \cdot 4}$

Math Expressions

$\&p[i] \longrightarrow \text{value}(p+i)_{M \cdot N \cdot 4}$   
 $\&p[i][j] \longrightarrow \text{value}((p+i)_{M \cdot N \cdot 4} + j)_{N \cdot 4}$   
 $\&p[i][j][k] \longrightarrow \text{value}(((p+i)_{M \cdot N \cdot 4} + j)_{N \cdot 4} + k)_{1 \cdot 4}$

Math Expressions

`int ** p[L], * q[L·M], r[L·M·N] ;`

$p[i] \longrightarrow *(p+i)_{1 \cdot 4}$   
 $p[i][j] \longrightarrow *(*p+i)_{1 \cdot 4} + j)_{1 \cdot 4}$   
 $p[i][j][k] \longrightarrow *(*(*p+i)_{1 \cdot 4} + j)_{1 \cdot 4} + k)_{1 \cdot 4}$

Math Expressions

$\&p[i] \longrightarrow \text{value}(p+i)_{1 \cdot 4}$   
 $\&p[i][j] \longrightarrow \text{value}(*p+i)_{1 \cdot 4} + j)_{1 \cdot 4}$   
 $\&p[i][j][k] \longrightarrow \text{value}(*(*p+i)_{1 \cdot 4} + j)_{1 \cdot 4} + k)_{1 \cdot 4}$

Math Expressions



# Equivalences (4)

**int p [L][M][N] ;**

value(\*X) = value(X) (address replication)

$$\begin{aligned} \&p[i] &= \text{value}((p + i)_{M \cdot N \cdot 4}) &= \boxed{\text{value}(p + i * M \cdot N \cdot 4)} \\ \&p[i][j] &= \text{value}((p[i] + j)_{N \cdot 4}) &= \boxed{\text{value}(p[i] + j * N \cdot 4)} \\ \&p[i][j][k] &= \text{value}((p[i][j] + k)_{1 \cdot 4}) &= \boxed{\text{value}(p[i][j] + k * 1 \cdot 4)} \\ \&p[i][j][k] &= \text{value}(p + i * M \cdot N \cdot 4 + j * N \cdot 4 + k * 4) \end{aligned}$$

$$\begin{aligned} \&p[i] &\longrightarrow &\text{value}(p+i)_{M \cdot N \cdot 4} \\ \&p[i][j] &\longrightarrow &\text{value}((p+i)_{M \cdot N \cdot 4} + j)_{N \cdot 4} \\ \&p[i][j][k] &\longrightarrow &\text{value}(((p+i)_{M \cdot N \cdot 4} + j)_{N \cdot 4} + k)_{1 \cdot 4} \end{aligned}$$

Math Expressions

**int \*\* p[L], \* q[L·M], r[L·M·N] ;**

$$\begin{aligned} \&p[i] &= \text{value}(p + i)_{1 \cdot 4} &= \boxed{\text{value}(p + i * 1 \cdot 4)} \\ \&p[i][j] &= \text{value}(p[i] + j)_{1 \cdot 4} &= \boxed{\text{value}(p[i] + j * 1 \cdot 4)} \\ \&p[i][j][k] &= \text{value}(p[i][j] + k)_{1 \cdot 4} &= \boxed{\text{value}(p[i][j] + k * 1 \cdot 4)} \\ \&p[i][j][k] &= \text{value}(*\text{value}(*\text{value}(p + i * 4) + j * 4) + k * 4) \end{aligned}$$

$$\begin{aligned} \&p[i] &\longrightarrow &\text{value}(p+i)_{1 \cdot 4} \\ \&p[i][j] &\longrightarrow &\text{value}(*(p+i)_{1 \cdot 4} + j)_{1 \cdot 4} \\ \&p[i][j][k] &\longrightarrow &\text{value}(*( *(p+i)_{1 \cdot 4} + j)_{1 \cdot 4} + k)_{1 \cdot 4} \end{aligned}$$

Math Expressions

# \* and [ ] notations (1)

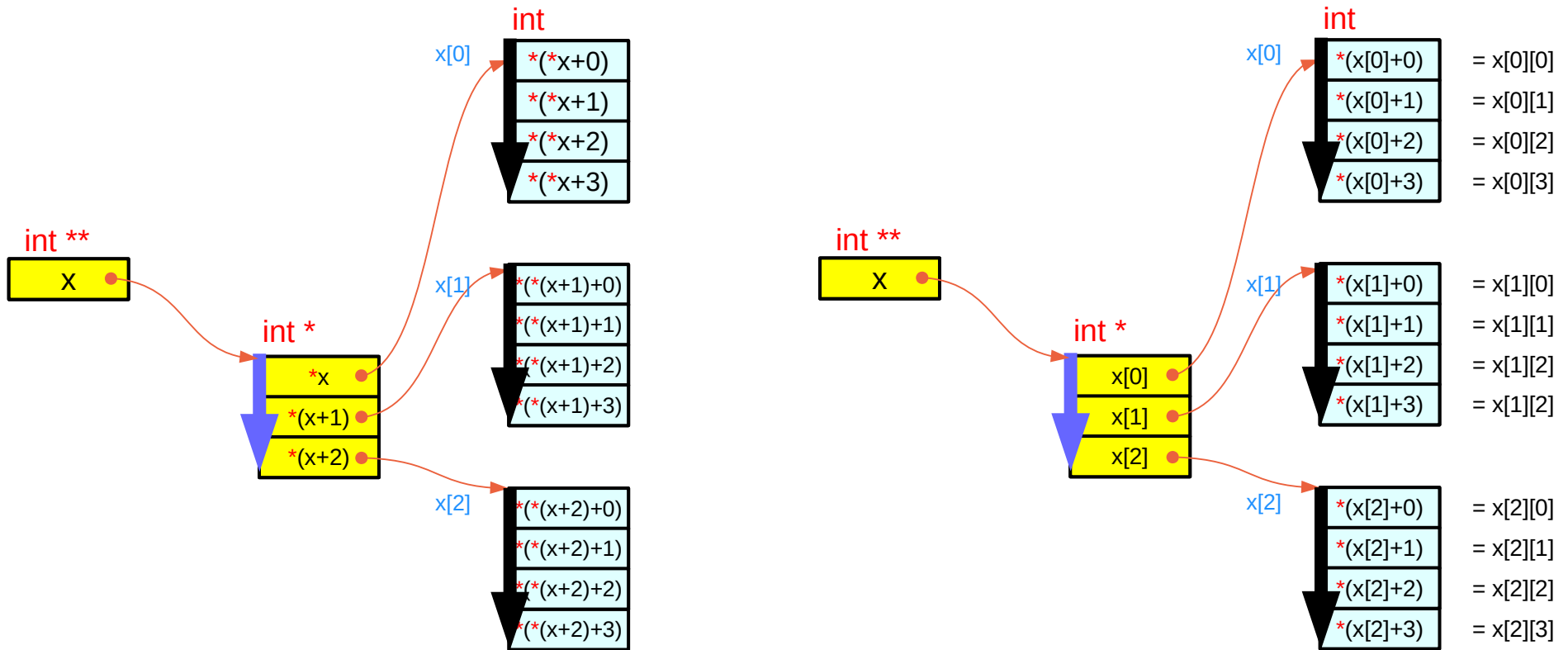

C expression

$*(*(x+i)+j)$



$x[i][j]$

Math expression

$*(*(x+i)_{1..4}+j)_{1..4}$

# \* and [ ] notations (2)

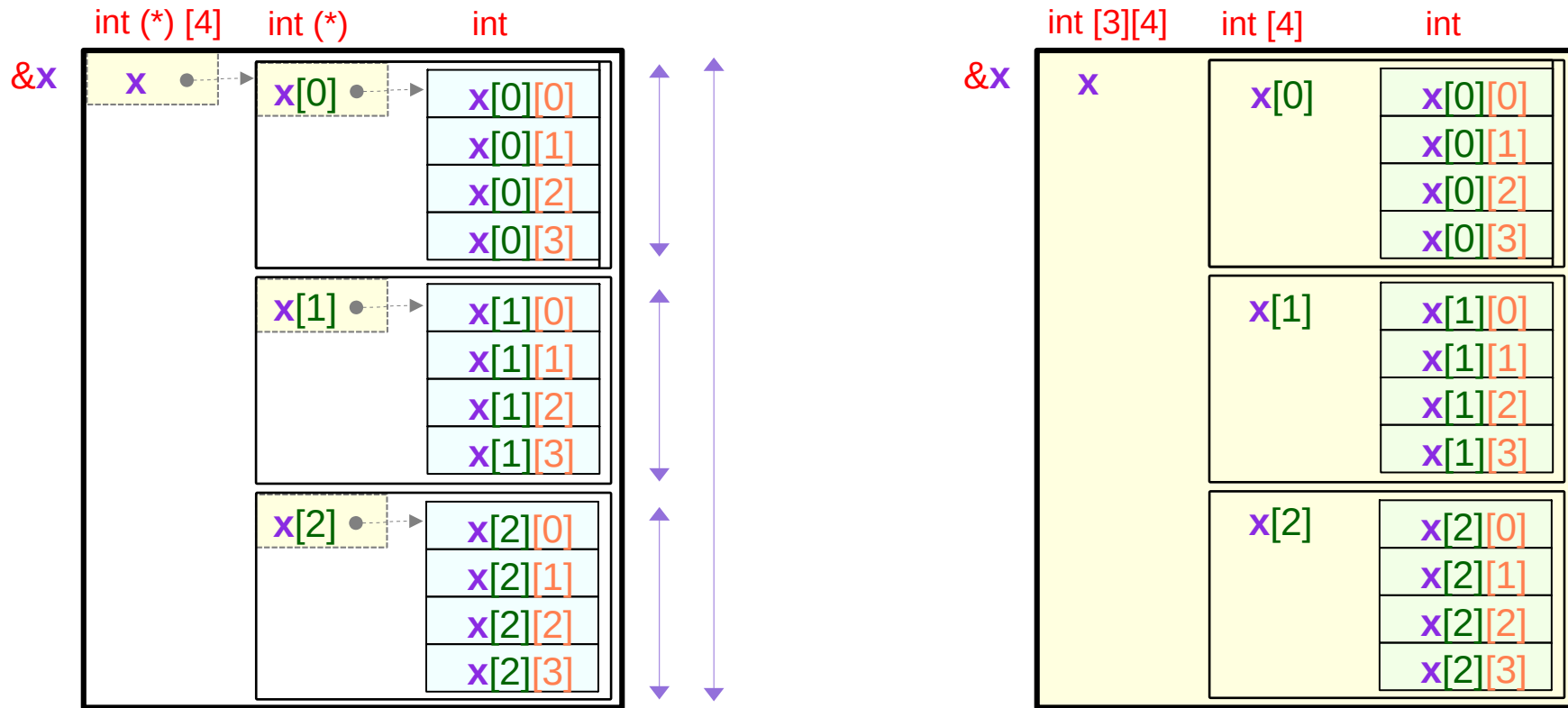

C expression

$$*(*(\mathbf{x} + \mathbf{i}) + \mathbf{j})$$



$$\mathbf{x}[\mathbf{i}][\mathbf{j}]$$

Math expression

$$*(*(\mathbf{x} + \mathbf{i})_{4 \cdot 4} + \mathbf{j})_{1 \cdot 4}$$

# Virtual pointers vs. real pointers (1)

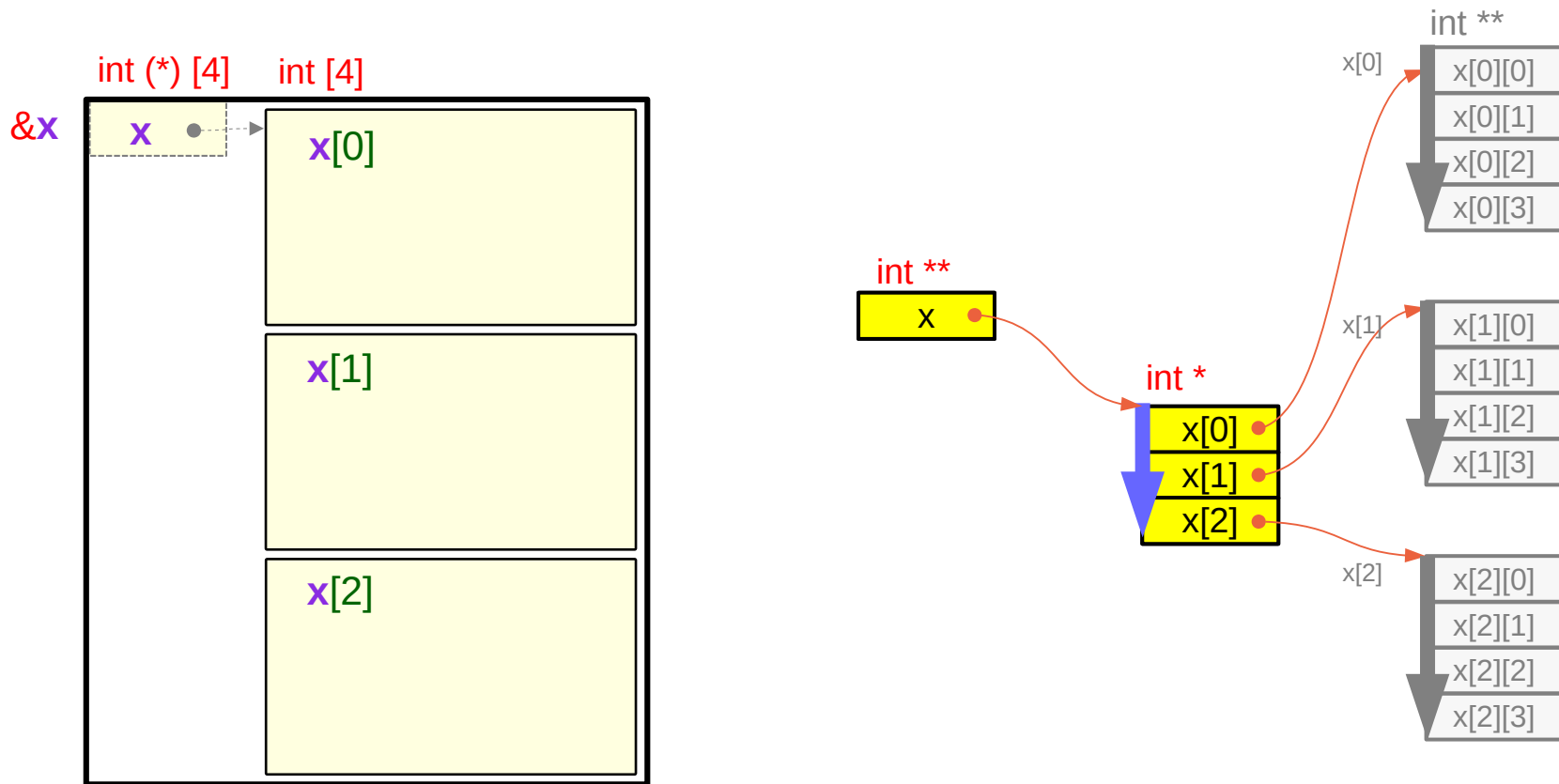

`&x = x`      `sizeof(x) = 3 * sizeof(*x)`

`x[i] = *(x + i)4,4`

`value(x+i) = value(x) + i * sizeof(*x)`  
`= value(x) + i * 4 * 4`

`&x ≠ x`      `sizeof(x) = sizeof(*x) = 4`

`x[i] = *(x + i)1,4`

`value(x+i) = value(x) + i * sizeof(*x)`  
`= value(x) + i * 4`

# Virtual pointers vs. real pointers (2)

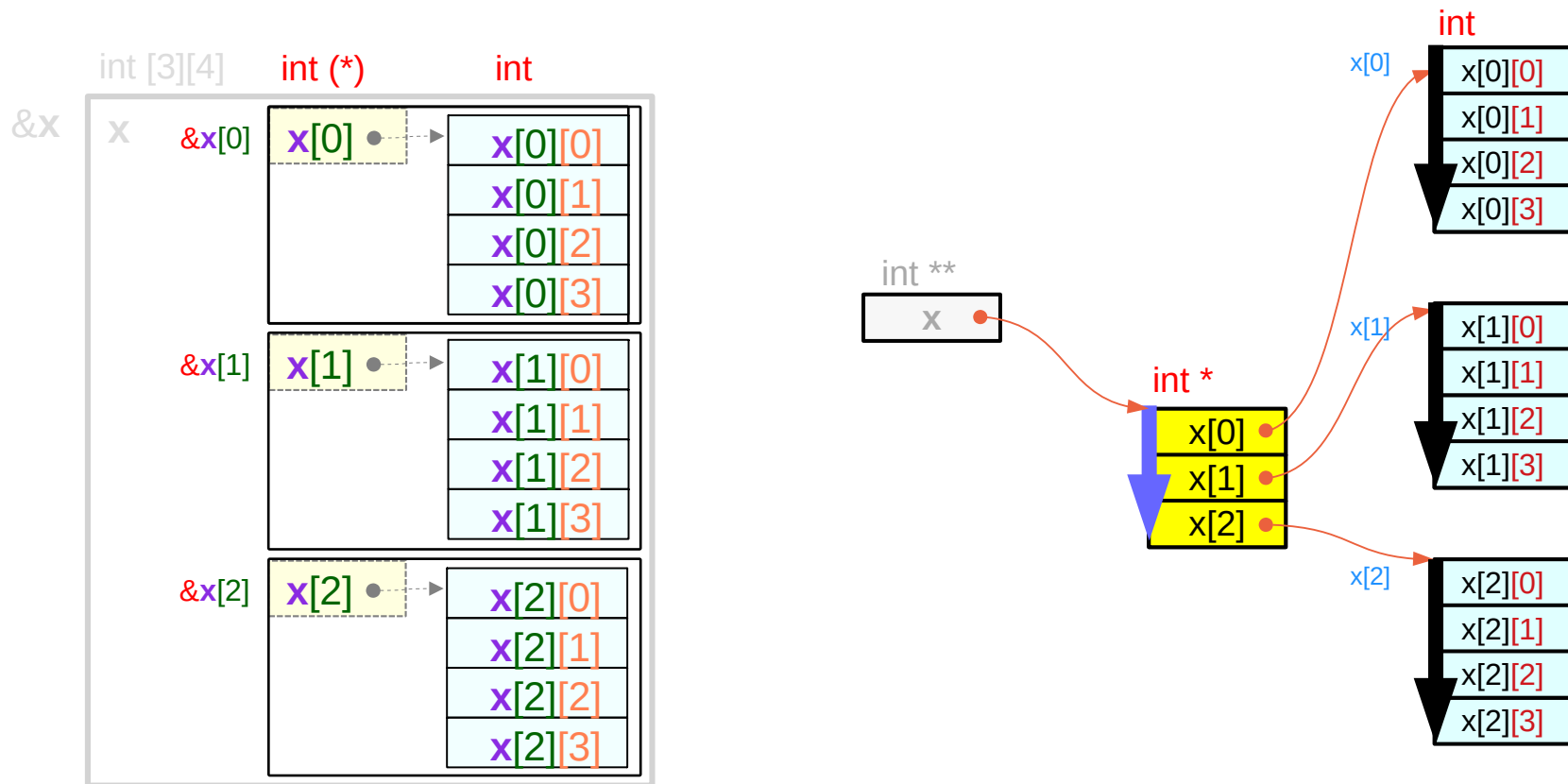

$$\&x[i] = x[i] \quad \text{sizeof}(x[i]) = 4 * \text{sizeof}(*x[i])$$

$$x[i] = *(x + i)_{1..4}$$

$$\begin{aligned} \text{value}(x[i]+j) &= \text{value}(x[i]) + j * \text{sizeof}(*x[i]) \\ &= \text{value}(x[i]) + j * 4 \end{aligned}$$

$$\&x[i] = x[i] \quad \text{sizeof}(x[i]) = \text{sizeof}(*x[i]) = 4$$

$$x[i][j] = *(x[i] + j)_{1..4}$$

$$\begin{aligned} \text{value}(x[i]+j) &= \text{value}(x[i]) + j * \text{sizeof}(*x[i]) \\ &= \text{value}(x[i]) + j * 4 \end{aligned}$$

# Operator Precedence

Precedence	Operator	Description	Associativity
1	++ -- () [] .br/>-> (type){list}	Suffix/postfix increment and decrement Function call <b>Array subscripting</b> Structure and union member access member access through pointer Compound literal(C99)	Left-to-right  (((x[m])[n])[p])  —————→
2	++ -- + - ! ~ (type) * & sizeof _Alignof	Prefix increment and decrement Unary plus and minus Logical NOT and bitwise NOT Type cast <b>Indirection (dereference)</b> Address-of Size-of Alignment requirement(C11)	Right-to-left    *( *(* (*X) ) )  ←—————

[https://en.cppreference.com/w/c/language/operator\\_precedence](https://en.cppreference.com/w/c/language/operator_precedence)

# Limitations

---

No index Range Checking

Array Size must be a constant expression

Variable Array Size

Arrays cannot be Copied or Compared

Aggregate Initialization and Global Arrays

Precedence Rule

Index Type Must be Integral

# References

- [1] Essential C, Nick Parlante
- [2] Efficient C Programming, Mark A. Weiss
- [3] C A Reference Manual, Samuel P. Harbison & Guy L. Steele Jr.
- [4] C Language Express, I. K. Chun
- [5] <https://pdos.csail.mit.edu/6.828/2008/readings/pointers.pdf>