

Laurent Series and z-Transform

- Geometric Series

Permutations B

20240429 Mon

Copyright (c) 2024 - 2016 Young W. Lim.

Permission is granted to copy, distribute and/or modify this document under the terms of the GNU Free Documentation License, Version 1.2 or any later version published by the Free Software Foundation; with no Invariant Sections, no Front-Cover Texts, and no Back-Cover Texts. A copy of the license is included in the section entitled "GNU Free Documentation License".

Unshifted Sequence

(1) $a^n u(n)$

(2) $a^{-n} u(n)$

(3) $a^n u(-n)$

(4) $a^{-n} u(-n)$

(5) $a^n u(-n-1)$

(6) $a^{-n} u(-n-1)$

(7) $a^n u(n-1)$

(8) $a^{-n} u(n-1)$

Shifted Sequence

$a^{n+i} u(n)$ (1')

$a^{-n-i} u(n)$ (2')

$a^{n-i} u(-n)$ (3')

$a^{-n+i} u(-n)$ (4')

$a^{n+i} u(-n-1)$ (5')

$a^{-n-i} u(-n-1)$ (6')

$a^{n-i} u(n-1)$ (7')

$a^{-n+i} u(n-1)$ (8')

Inter-permutations over unshifted sequence and shifted sequence

Intra-permutations over unshifted sequence

Intra-permutations over shifted sequence

Inter-permutation

(x) \dashrightarrow (x')

(1)~(8) \dashrightarrow (1')~(8')

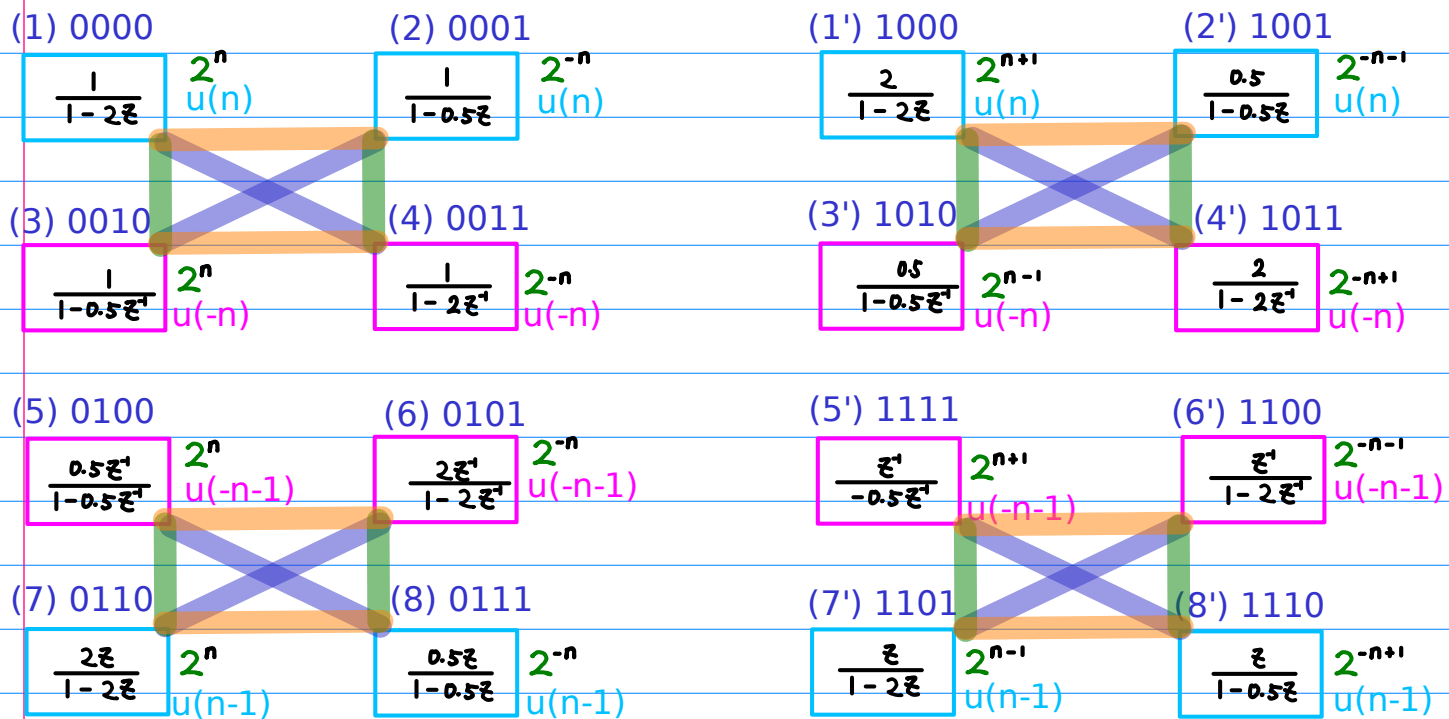

(1)	0 0 0 0	\rightarrow	1 0 0 0	(1')	n	\rightarrow	$n+1$	shl(n)
(2)	0 0 0 1	\rightarrow	1 0 0 1	(2')	n	\rightarrow	$n+1$	shl(n)
(3)	0 0 1 0	\rightarrow	1 0 1 0	(3')	n	\rightarrow	$n-1$	shr(n)
(4)	0 0 1 1	\rightarrow	1 0 1 1	(4')	n	\rightarrow	$n-1$	shr(n)
(5)	0 1 0 0	\rightarrow	1 1 0 0	(5')	n	\rightarrow	$n+1$	shl(n)
(6)	0 1 0 1	\rightarrow	1 1 0 1	(6')	n	\rightarrow	$n+1$	shl(n)
(7)	0 1 1 0	\rightarrow	1 1 1 0	(7')	n	\rightarrow	$n-1$	shr(n)
(8)	0 1 1 1	\rightarrow	1 1 1 1	(7')	n	\rightarrow	$n-1$	shr(n)

$\text{shl}(n) = n + 1$
 $\text{shr}(n) = n - 1$

(1) -- (1')
(5) -- (5')

2^n

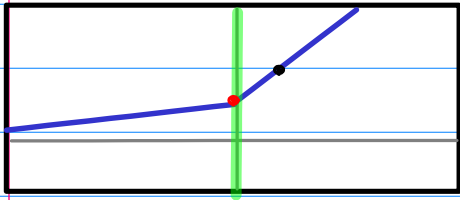

shift left
 $n \leftarrow n+1$

2^{n+1}

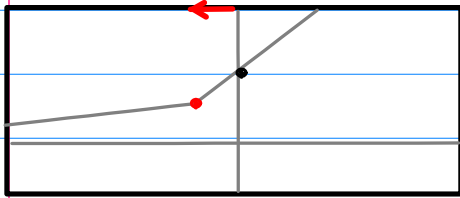

(2) -- (2')
(6) -- (6')

2^{-n}

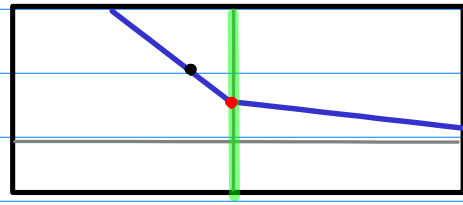

shift left
 $n \leftarrow n+1$

$2^{-(n+1)}$

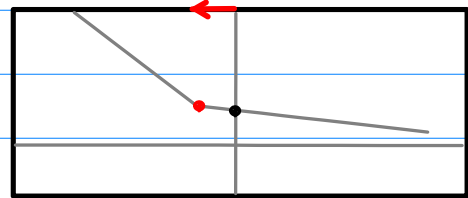

(3) -- (3')
(7) -- (7')

2^n

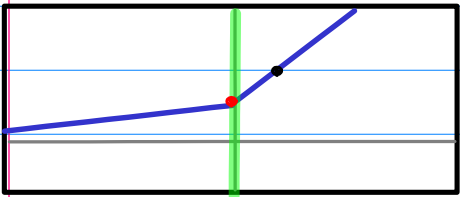

shift right
 $n \leftarrow n-1$

2^{n-1}

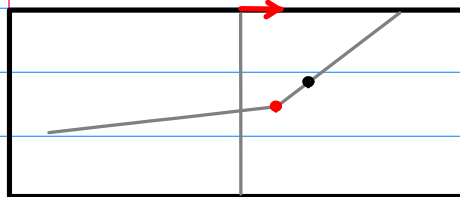

(4) -- (4')
(8) -- (8')

2^{-n}

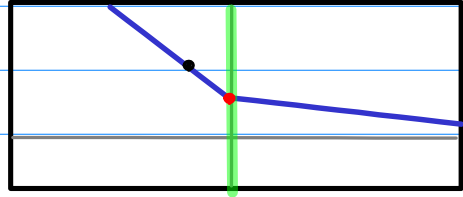

shift right
 $n \leftarrow n-1$

$2^{-(n-1)}$

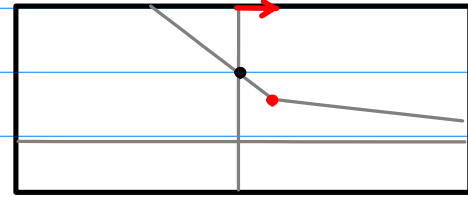

(1) - (1')
(7) - (7')
(5) - (5')
(3) - (3')

(2) - (2')
(8) - (8')
(6) - (6')
(4) - (4')

(1) - (1')
(2) - (2')
(3) - (3')
(4) - (4')

(5) - (5')
(6) - (6')
(7) - (7')
(8) - (8')

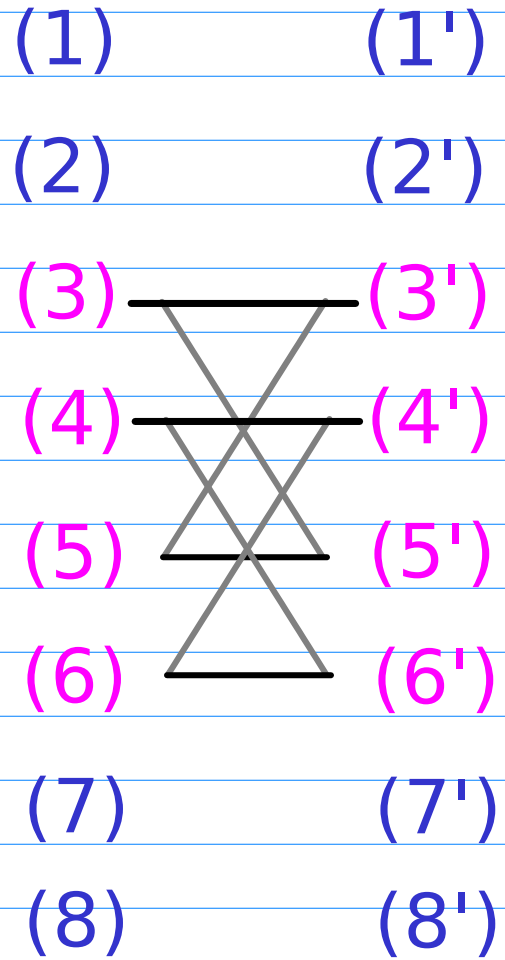
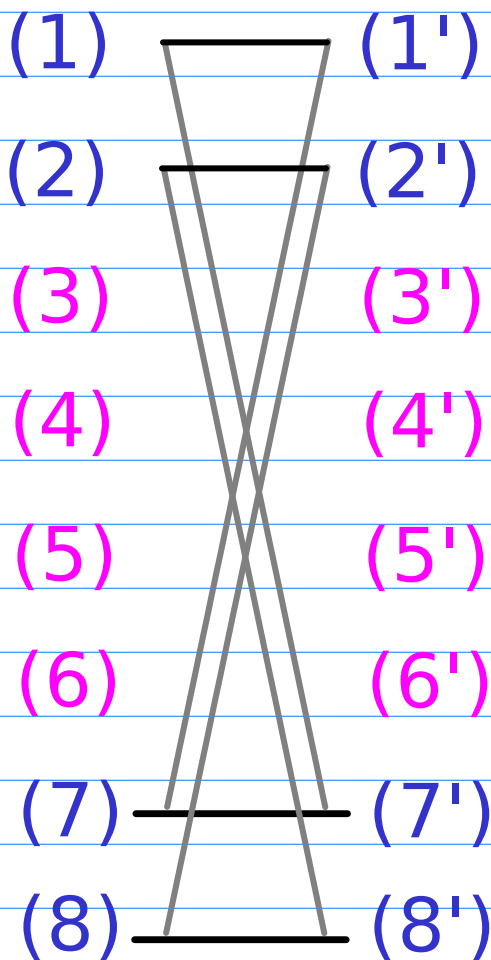
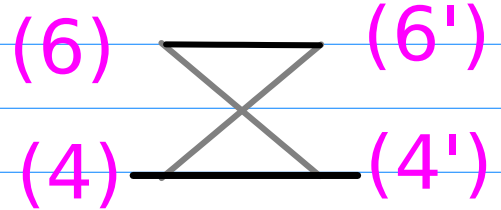
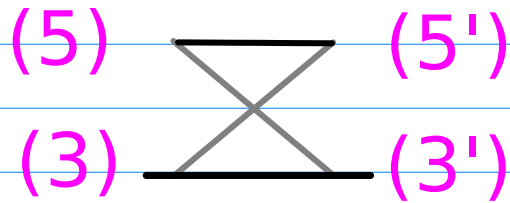
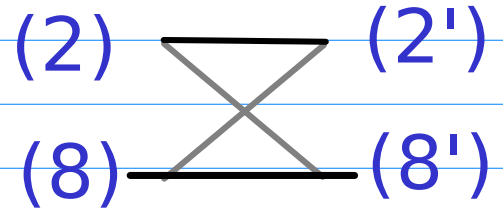
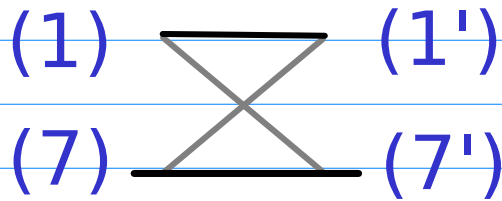

Butterfly Relations

(*) unit starting

(1) $*a \leftarrow (SL, id)$ (1') **SL**

$/z \leftarrow (SL, SL)$

$*z \Rightarrow (SR, SR)$

(7) $/a \rightarrow (SR, id)$ (7') **SR**

$/a \rightarrow (SR, id)$

C.R. starting

(*) unit starting

(2) $/a \leftarrow (SL, id)$ (2') **SL**

$/z \leftarrow (SL, SL)$

C.R. starting $*z \Rightarrow (SR, SR)$

(8) $*a \rightarrow (SR, id)$ (8') **SR**

$*a \rightarrow (SR, id)$

(*) C.R. starting

(5) $*a \leftarrow (SL, id)$ (5') **SL**

$/z \leftarrow (SL, SL)$

$*z \Rightarrow (SR, SR)$

(3) $/a \rightarrow (SR, id)$ (3') **SR**

$/a \rightarrow (SR, id)$

unit starting

(*) C.R. starting

(6) $/a \leftarrow (SL, id)$ (6') **SL**

$/z \leftarrow (SL, SL)$

unit starting $*z \Rightarrow (SR, SR)$

(4) $*a \rightarrow (SR, id)$ (4') **SR**

$*a \rightarrow (SR, id)$

unit starting

(Exp Shift, Range Shift)

Decomposition of Exp and Rng Shifts

(* unit starting

(1)

(1') SL

(id, SR)

C.R. starting

(7)

*z ⇒ (SR, SR)

/a → (SR, id)

(7') SR

(* unit starting

(2)

(2') SL

(id, SR)

C.R. starting

(8)

*z ⇒ (SR, SR)

*a → (SR, id)

(8') SR

(* unit starting

(1)

(1') SL

(id, SL)

C.R. starting

(7)

*a ← (SL, id)

/z ⇐ (SL, SL)

(7') SR

(* unit starting

(2)

(2') SL

(id, SL)

C.R. starting

(8)

/a ← (SL, id)

/z ⇐ (SL, SL)

(8') SR

$$(id, SR) + (SR, id) = (SR, SR)$$

$$(id, SL) + (SL, id) = (SR, SL)$$

$$(id, SR) + (SR, id) = (SR, SR)$$

$$(id, SL) + (SL, id) = (SR, SL)$$

Decomposition of Exp and Rng Shifts

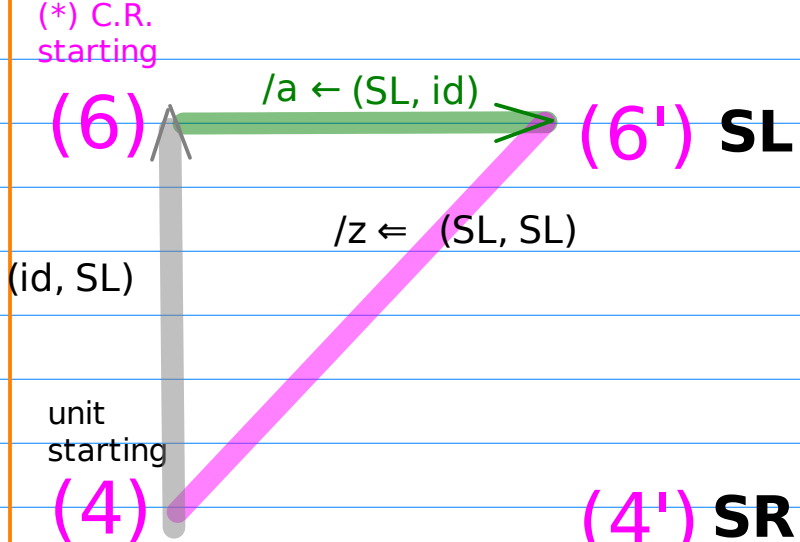
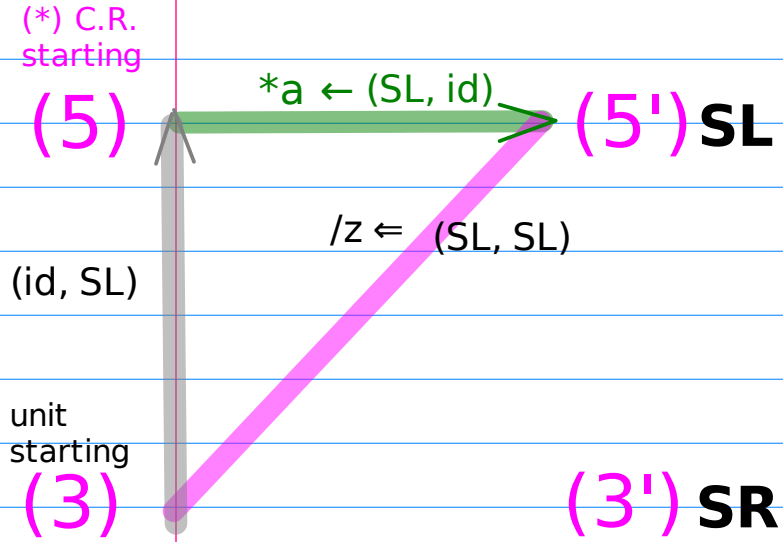
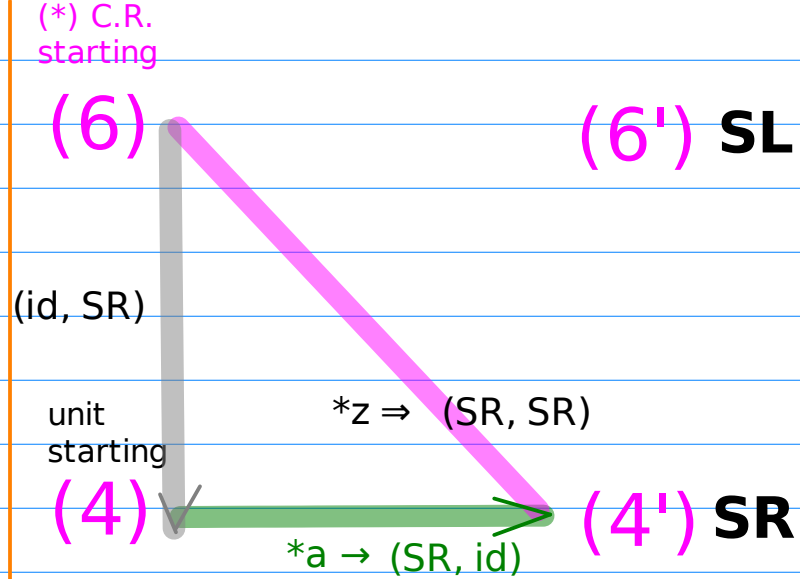
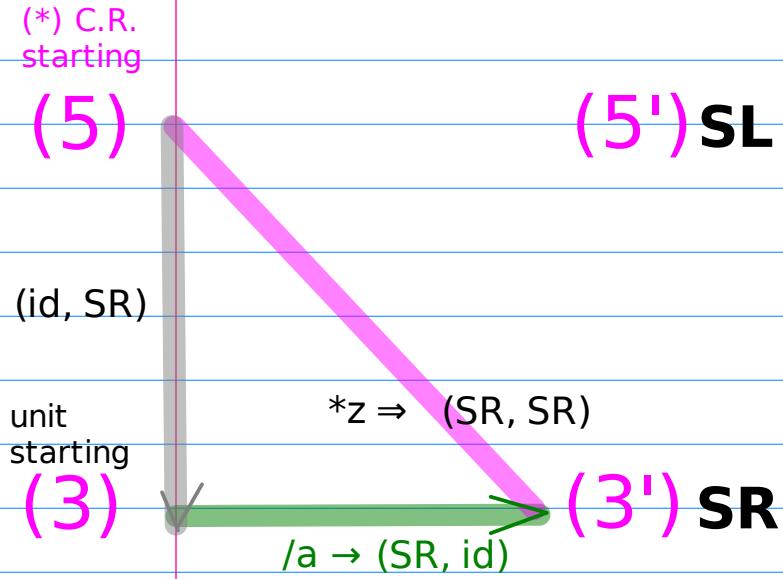

$$(id, SR) + (SR, id) = (SR, SR)$$

$$(id, SL) + (SL, id) = (SR, SL)$$

$$(id, SR) + (SR, id) = (SR, SR)$$

$$(id, SL) + (SL, id) = (SR, SL)$$

Exponent Shifts

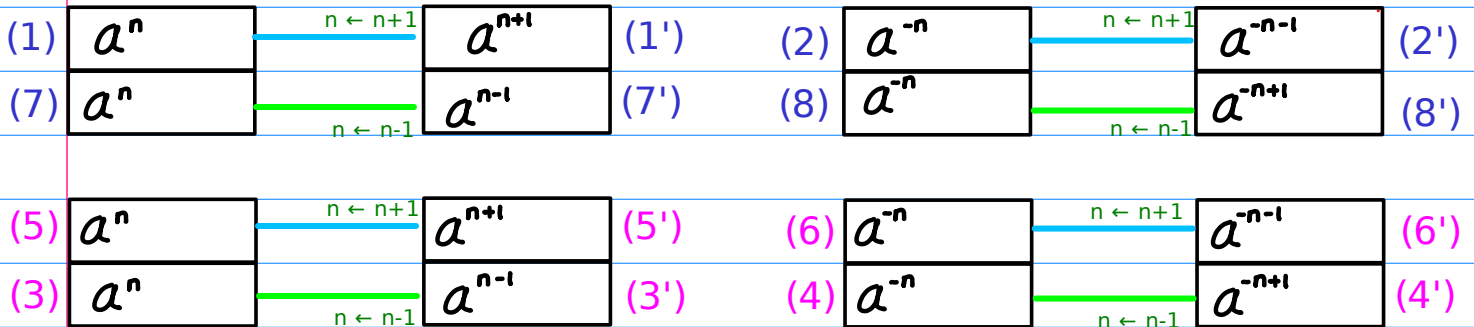

Range Shifts

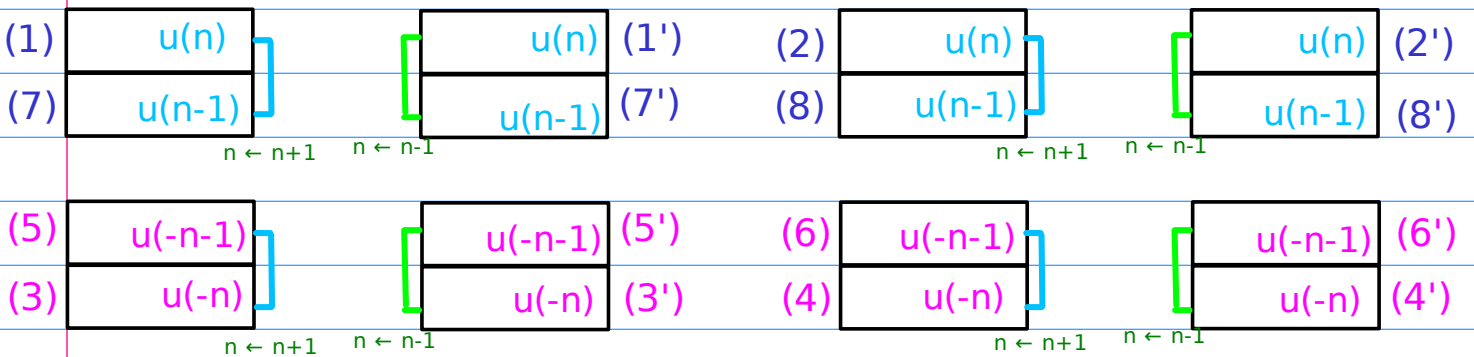

Exponent & Range Permutations

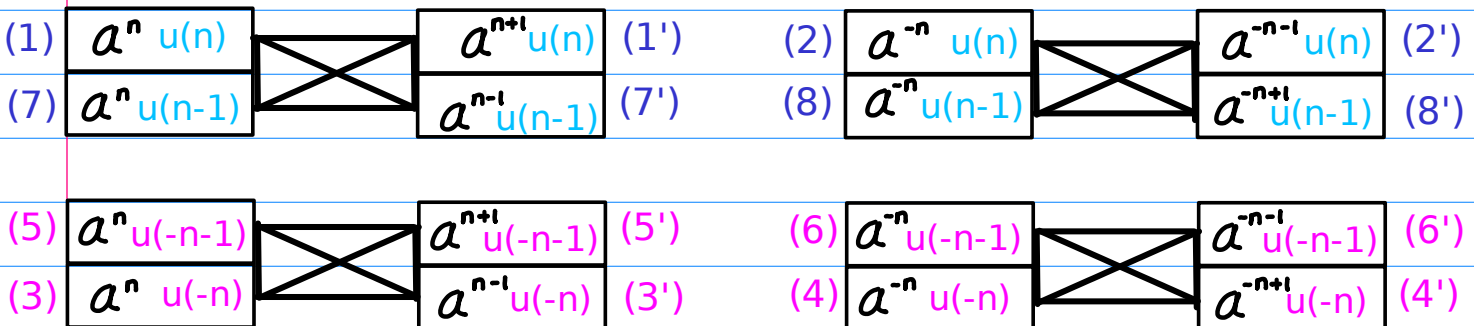

$R(n)$			$SHR(n)$
$u(n)$	$n \leftarrow n-1$	shr	$u(n-1)$
$u(n-1)$	$n \leftarrow n+1$	shl	$u(n)$
$u(-n)$	$n \leftarrow n+1$	shl	$u(-n-1)$
$u(-n-1)$	$n \leftarrow n-1$	shr	$u(-n)$

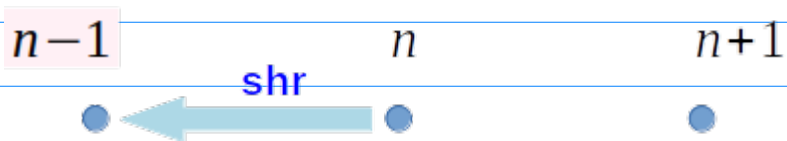
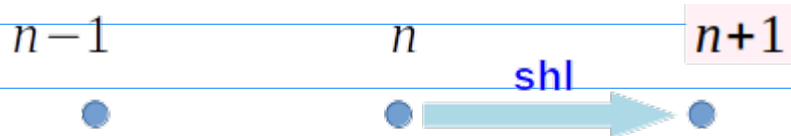

Exponent Permutations

$$\begin{array}{l} (1) \\ (7) \end{array} \begin{array}{|c|} \hline a^n u(n) \\ \hline a^n u(n-1) \\ \hline \end{array} \begin{array}{c} \diagdown \quad \diagup \\ \diagup \quad \diagdown \end{array} \begin{array}{|c|} \hline a^{n+1} u(n) \\ \hline a^{n-1} u(n-1) \\ \hline \end{array} \begin{array}{l} (1') \\ (7') \end{array}$$

$$\begin{array}{l} (2) \\ (8) \end{array} \begin{array}{|c|} \hline a^{-n} u(n) \\ \hline a^{-n} u(n-1) \\ \hline \end{array} \begin{array}{c} \diagdown \quad \diagup \\ \diagup \quad \diagdown \end{array} \begin{array}{|c|} \hline a^{-n-1} u(n) \\ \hline a^{-n+1} u(n-1) \\ \hline \end{array} \begin{array}{l} (2') \\ (8') \end{array}$$

$$\begin{array}{l} (5) \\ (3) \end{array} \begin{array}{|c|} \hline a^n u(-n-1) \\ \hline a^n u(-n) \\ \hline \end{array} \begin{array}{c} \diagdown \quad \diagup \\ \diagup \quad \diagdown \end{array} \begin{array}{|c|} \hline a^{n+1} u(-n-1) \\ \hline a^{n-1} u(-n) \\ \hline \end{array} \begin{array}{l} (5') \\ (3') \end{array}$$

$$\begin{array}{l} (6) \\ (4) \end{array} \begin{array}{|c|} \hline a^{-n} u(-n-1) \\ \hline a^{-n} u(-n) \\ \hline \end{array} \begin{array}{c} \diagdown \quad \diagup \\ \diagup \quad \diagdown \end{array} \begin{array}{|c|} \hline a^{-n-1} u(-n-1) \\ \hline a^{-n+1} u(-n) \\ \hline \end{array} \begin{array}{l} (6') \\ (4') \end{array}$$

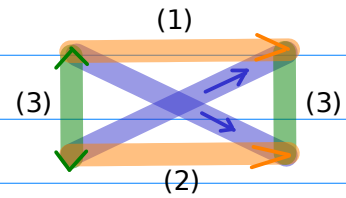
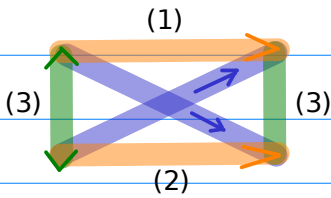

(1) shift left exponent

(2) shift right exponent

(3) shift right/left range

(1) shift left exponent

(2) shift right exponent

(3) shift right/left range

(SR, id) shift right exponent

(id, SR) shift right range

(SR, SR)

(SR, id) shift right exponent

(id, SR) shift right range

(SR, SR)

(SL, id) shift left exponent

(id, SL) shift left range

(SL, SL)

(SL, id) shift left exponent

(id, SL) shift left range

(SL, SL)

$$\begin{aligned} (id, SR) + (SR, id) &= (SR, SR) \\ (id, SL) + (SL, id) &= (SR, SL) \end{aligned}$$

$$\begin{aligned} (id, SR) + (SR, id) &= (SR, SR) \\ (id, SL) + (SL, id) &= (SR, SL) \end{aligned}$$

Unshifted Sequence

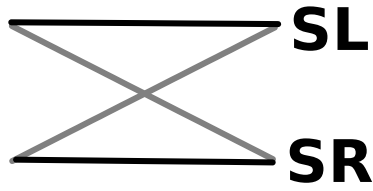

Shifted Sequence

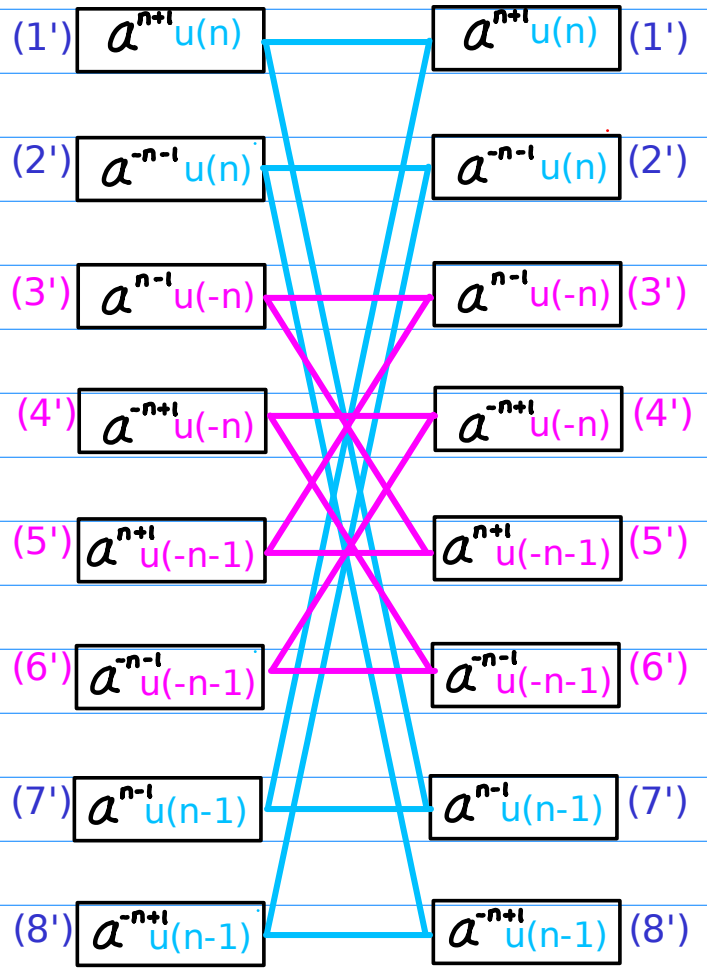
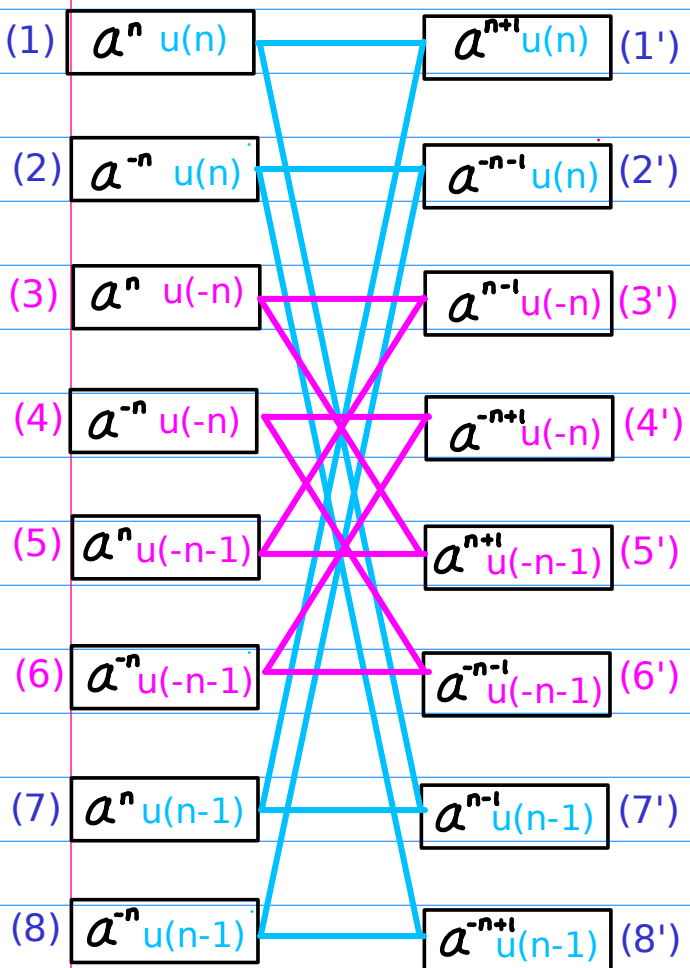
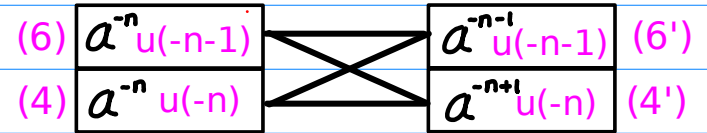
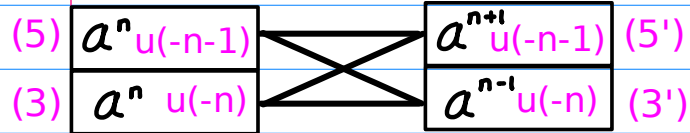
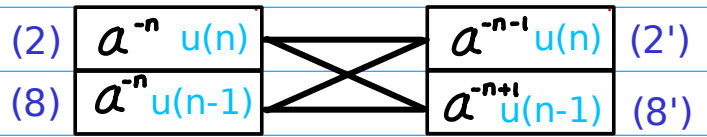
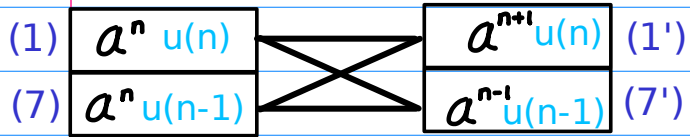



Intra-Permutations over (1) ~ (8)

(1) $a^n u(n)$	$a^{n+i} u(n)$ (1')
(2) $a^{-n} u(n)$	$a^{-n-i} u(n)$ (2')
(3) $a^n u(-n)$	$a^{n-i} u(-n)$ (3')
(4) $a^{-n} u(-n)$	$a^{-n+i} u(-n)$ (4')
(5) $a^n u(-n-1)$	$a^{n+i} u(-n-1)$ (5')
(6) $a^{-n} u(-n-1)$	$a^{-n-i} u(-n-1)$ (6')
(7) $a^n u(n-1)$	$a^{n-i} u(n-1)$ (7')
(8) $a^{-n} u(n-1)$	$a^{-n+i} u(n-1)$ (8')

A. Flipping

Base Inverting
Range Flipping

B. Range Shifting = Range Flipping + Range Complementing

Range Flipping
Range Complementing

C. Complementary Inverting

Base Inverting
Range Complementing

a^n \times $R(n)$

a^n	a^{-n}	\times	$u(n)$	$u(-n-1)$
		\times	$u(n-1)$	$u(-n)$

(1)	$a^n u(n)$	$a^{-n} u(n)$	(1)
-----	------------	---------------	-----

(7)	$a^n u(n-1)$	$a^{-n} u(n-1)$	(7)
-----	--------------	-----------------	-----

(5)	$a^n u(-n-1)$	$a^{-n} u(-n-1)$	(5)
-----	---------------	------------------	-----

(3)	$a^n u(-n)$	$a^{-n} u(-n)$	(3)
-----	-------------	----------------	-----

(1)	$a^n u(n)$	$a^{-n} u(n)$	(2)
-----	------------	---------------	-----

(3)	$a^n u(-n)$	$a^{-n} u(-n)$	(4)
-----	-------------	----------------	-----

(5)	$a^n u(-n-1)$	$a^{-n} u(-n-1)$	(6)
-----	---------------	------------------	-----

(7)	$a^n u(n-1)$	$a^{-n} u(n-1)$	(8)
-----	--------------	-----------------	-----

Intra-Permutations over (1') ~ (8')

(1) $a^n u(n)$

(2) $a^{-n} u(n)$

(3) $a^n u(-n)$

(4) $a^{-n} u(-n)$

(5) $a^n u(-n-1)$

(6) $a^{-n} u(-n-1)$

(7) $a^n u(n-1)$

(8) $a^{-n} u(n-1)$

$a^{n+i} u(n)$ (1')

$a^{-n-i} u(n)$ (2')

$a^{n-i} u(-n)$ (3')

$a^{-n+i} u(-n)$ (4')

$a^{n+i} u(-n-1)$ (5')

$a^{-n-i} u(-n-1)$ (6')

$a^{n-i} u(n-1)$ (7')

$a^{-n+i} u(n-1)$ (8')

D. Flipping2

Base Inverting

Shifted Range Flipping = Exponent Shifting2 + Range Flipping

E. Shifting2 = Exponent Shifting2 + Range Shifting

Shifted Range Flipping = Exponent Shifting2 + Range Flipping

Range Complementing

F. Complementary Inverting

Base Inverting

Range Complementing

a^n \times $R(n)$

a^{n+1}	a^{-n-1}
a^{n-1}	a^{-n+1}

 \times

$u(n)$	$u(-n-1)$
$u(n-1)$	$u(-n)$

(1')	$a^{n+1} u(n)$	$a^{-n-1} u(n)$
(7')	$a^{n-1} u(n-1)$	$a^{-n+1} u(n-1)$
(5')	$a^{n+1} u(-n-1)$	$a^{-n-1} u(-n-1)$
(3')	$a^{n-1} u(-n)$	$a^{-n+1} u(-n)$

(2')	$a^{n-1} u(n)$	$a^{-n+1} u(n)$
(8')	$a^{n+1} u(n-1)$	$a^{-n-1} u(n-1)$
(6')	$a^{n-1} u(-n-1)$	$a^{-n+1} u(-n-1)$
(4')	$a^{n+1} u(-n)$	$a^{-n-1} u(-n)$

(1')	$a^{n+1} u(n)$	$a^{-n-1} u(n)$
(3')	$a^{n-1} u(-n)$	$a^{-n+1} u(-n)$
(5')	$a^{n+1} u(-n-1)$	$a^{-n-1} u(-n-1)$
(7')	$a^{n-1} u(n-1)$	$a^{-n+1} u(n-1)$

(2')	$a^{n-1} u(n)$	$a^{-n+1} u(n)$
(4')	$a^{n+1} u(-n)$	$a^{-n-1} u(-n)$
(6')	$a^{n-1} u(-n-1)$	$a^{-n+1} u(-n-1)$
(8')	$a^{n+1} u(n-1)$	$a^{-n-1} u(n-1)$

$$a^n \quad \times \quad R(n)$$

a^{n+1}	a^{-n-1}	\times	$u(n)$	$u(-n-1)$
a^{n-1}	a^{-n+1}	\times	$u(n-1)$	$u(-n)$

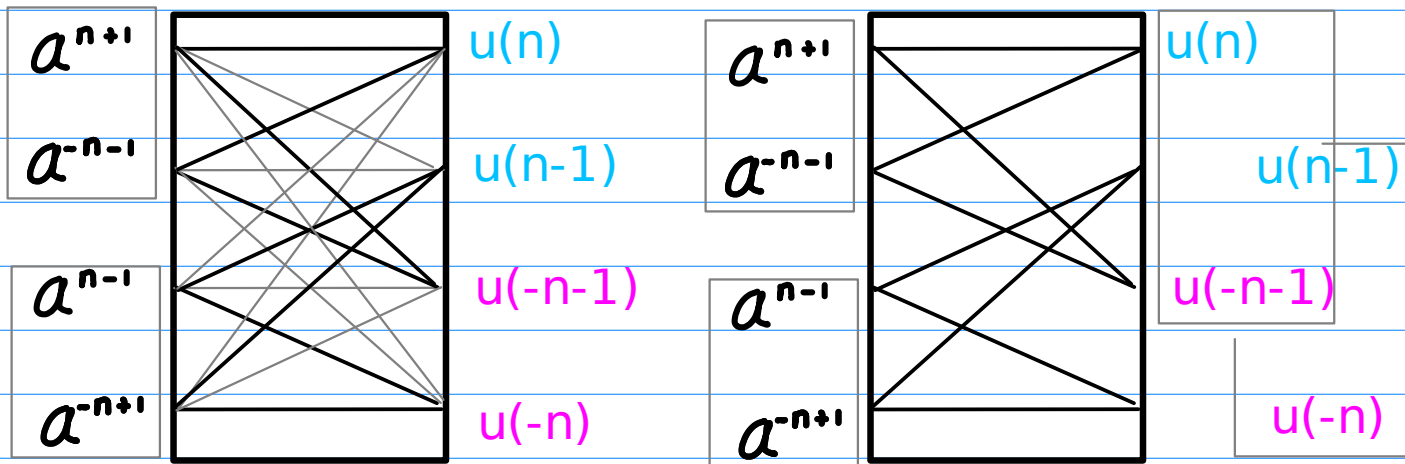

$n \leftarrow n+2$ or
$n \leftarrow n-2$

(1') a^{n+1}	$u(n)$	a^{-n-1}	$u(n)$	(2')	a^{n-1}	$u(n)$	a^{-n+1}	$u(n)$	
(3')	a^{n-1}	$u(-n)$	a^{-n+1}	$u(-n)$	(4')	a^{n+1}	$u(-n)$	a^{-n-1}	$u(-n)$
(5')	a^{n+1}	$u(-n-1)$	a^{-n-1}	$u(-n-1)$	(6')	a^{n-1}	$u(-n-1)$	a^{-n+1}	$u(-n-1)$
(7')	a^{n-1}	$u(n-1)$	a^{-n+1}	$u(n-1)$	(8')	a^{n+1}	$u(n-1)$	a^{-n-1}	$u(n-1)$

permutation over (1) ~ (8)

A. Flipping

Base Inverting
Range Flipping

B. Range Shifting = Range Flipping + Range Complementing

Range Flipping
Range Complementing

C. Complementary Inverting

Base Inverting
Range Complementing

permutation over (1') ~ (8')

D. Flipping²

Base Inverting
Shifted Range Flipping = Exponent Shifting² + Range Flipping

E. Shifting² = Exponent Shifting² + Range Shifting

Shifted Range Flipping = Exponent Shifting² + Range Flipping
Range Complementing

F. Complementary Inverting

Base Inverting
Range Complementing

Range Shifting = Range Flipping + Range Complementing

Shifted Range Flipping = Exponent Shifting² + Range Flipping

Shifting² = Shifted Range Flipping + Range Complementing

= Exponent Shifting² + Range (Flipping+Complementing)

= Exponent Shifting² + Range Shifting

permutation over (1) ~ (8)

A. Flipping	(1) - (4)	(5) - (8)
Base Inverting	(2) - (3)	(6) - (7)
Range Flipping	(3) - (2)	(7) - (6)
	(4) - (1)	(8) - (5)
B. Range Shifting	(1) - (7)	(5) - (3)
Range Flipping	(2) - (8)	(6) - (4)
Range Complementing	(3) - (5)	(7) - (1)
	(4) - (6)	(8) - (2)
C. Complementary Inverting	(1) - (6)	(5) - (2)
Base Inverting	(6) - (1)	(6) - (1)
Range Complementing	(2) - (5)	(7) - (4)
	(5) - (2)	(8) - (3)

permutation over (1') ~ (8')

D. Flipping2	(1') - (4')	(5') - (8')
Base Inverting	(2') - (3')	(6') - (7')
Shifted Range Flipping	(3') - (2')	(7') - (6')
	(4') - (1')	(8') - (5')
E. Shifting2	(1') - (7')	(5') - (3')
Shifted Range Flipping	(2') - (8')	(6') - (4')
Range Complementing	(3') - (5')	(7') - (1')
	(4') - (6')	(8') - (2')
F. Complementary Inverting	(1') - (6')	(5') - (2')
Base Inverting	(6') - (1')	(6') - (1')
Range Complementing	(2') - (5')	(7') - (4')
	(5') - (2')	(8') - (3')



permutation over (1) ~ (8)

	A	B	C
Base Inverting	X		X
Range Flipping	X	X	
Range Complementing		X	X

permutation over (1') ~ (8')

	D	E	F
Base Inverting	X		X
Shifted Range Flipping	X	X	
Range Complementing		X	X

Range Shifting = Range Flipping + Range Complementing
Shifted Range Flipping = Exponent Shifting2 + Range Flipping

Shifting2 = Shifted Range Flipping + Range Complementing
= Exponent Shifting2 + Range (Flipping+Complementing)
= Exponent Shifting2 + Range Shifting



Over (1) ~ (8)

Base Inverting

$$a^n \longleftrightarrow a^{-n}$$

Range Flipping

$$R(n) \longleftrightarrow R(-n)$$

Range Complementing

$$R(n) \longleftrightarrow \overline{R(n)}$$

Over (1') ~ (8')

Base Inverting

$$a^n \longleftrightarrow a^{-n}$$

Shifted Range Flipping

$$a^n R(n) \longleftrightarrow a^{sh2(n)} R(-n)$$

Range Complementing

$$R(n) \longleftrightarrow \overline{R(n)}$$

A.I Flipping
Base Inverting
Range Flipping

$$a^n \longleftrightarrow a^{-n}$$

$$R(n) \longleftrightarrow R(-n)$$

$$a^n R(n) \longleftrightarrow a^{-n} R(-n)$$

D.I Flipping2
Base Inverting
Shifted Range Flipping

$$a^n \longleftrightarrow a^{-n}$$

$$a^n R(n) \longleftrightarrow a^{sh2(n)} R(-n)$$

$$a^n R(n) \longleftrightarrow a^{-sh2(n)} R(-n)$$

B.I Range Shifting
Range Flipping
Range Complementing

$$R(n) \longleftrightarrow R(-n)$$

$$R(n) \longleftrightarrow \overline{R(n)}$$

$$R(n) \longleftrightarrow \overline{R(-n)}$$

E.I Shifting2
Shifted Range Flipping
Range Complementing

$$a^n R(n) \longleftrightarrow a^{sh2(n)} R(-n)$$

$$R(n) \longleftrightarrow \overline{R(n)}$$

$$a^n R(n) \longleftrightarrow a^{sh2(n)} \overline{R(-n)}$$

C.I Complementary Inverting
Base Inverting
Range Complementing

$$a^n \longleftrightarrow a^{-n}$$

$$R(n) \longleftrightarrow \overline{R(n)}$$

$$a^n R(n) \longleftrightarrow a^{-n} \overline{R(n)}$$

F.I Complementary Inverting
Base Inverting
Range Complementing

$$a^n \longleftrightarrow a^{-n}$$

$$R(n) \longleftrightarrow \overline{R(n)}$$

$$a^n R(n) \longleftrightarrow a^{-n} \overline{R(n)}$$

A.I Flipping
Base Inverting
Range Flipping

D.I Flipping2
Base Inverting
Shifted Range Flipping

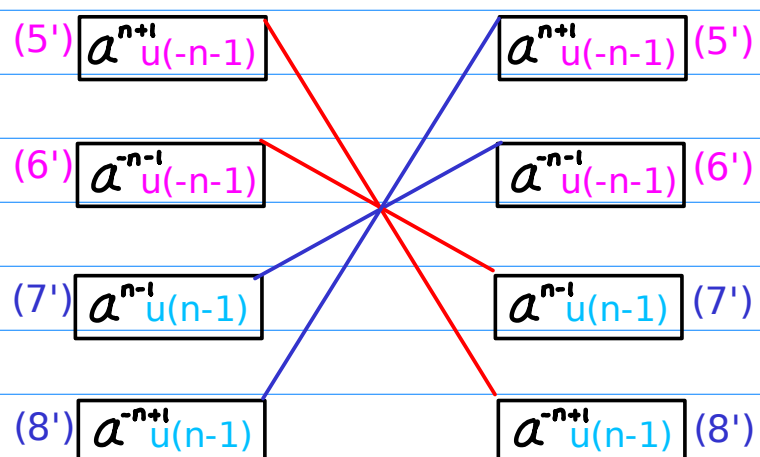
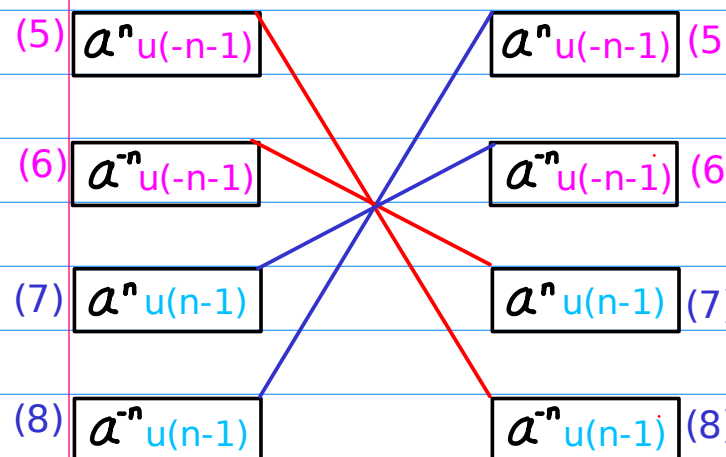
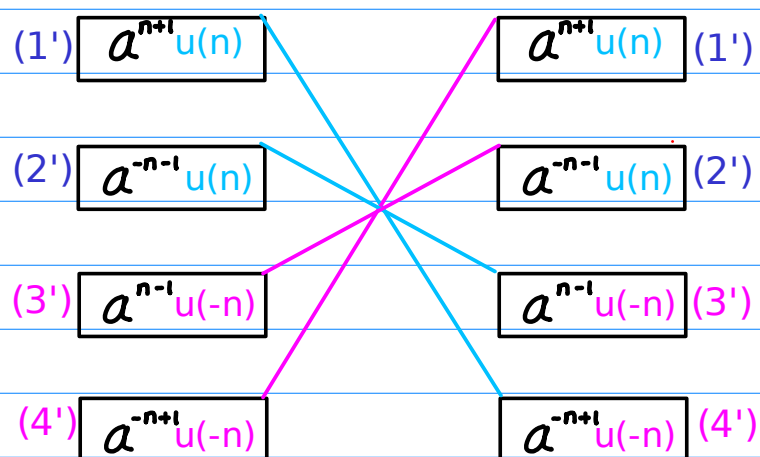
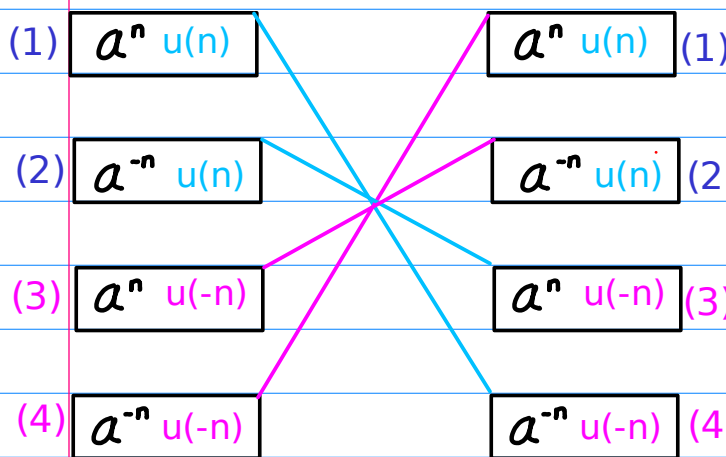
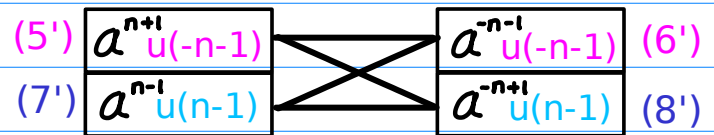
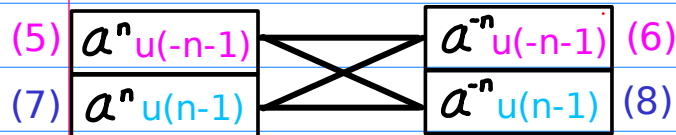
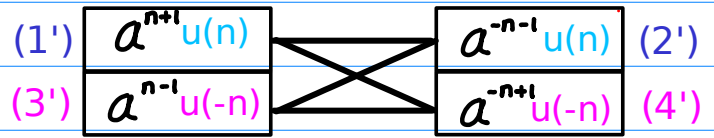
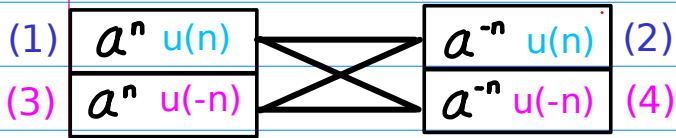

(1) - (4) (5) - (8)
 (2) - (3) (6) - (7)
 (3) - (2) (7) - (6)
 (4) - (1) (8) - (5)

(1') - (4') (5') - (8')
 (2') - (3') (6') - (7')
 (3') - (2') (7') - (6')
 (4') - (1') (8') - (5')

**B.I Range Shifting
Range Flipping
Range Complementing**

**E.I Shifting2
Shifted Range Flipping
Range Complementing**

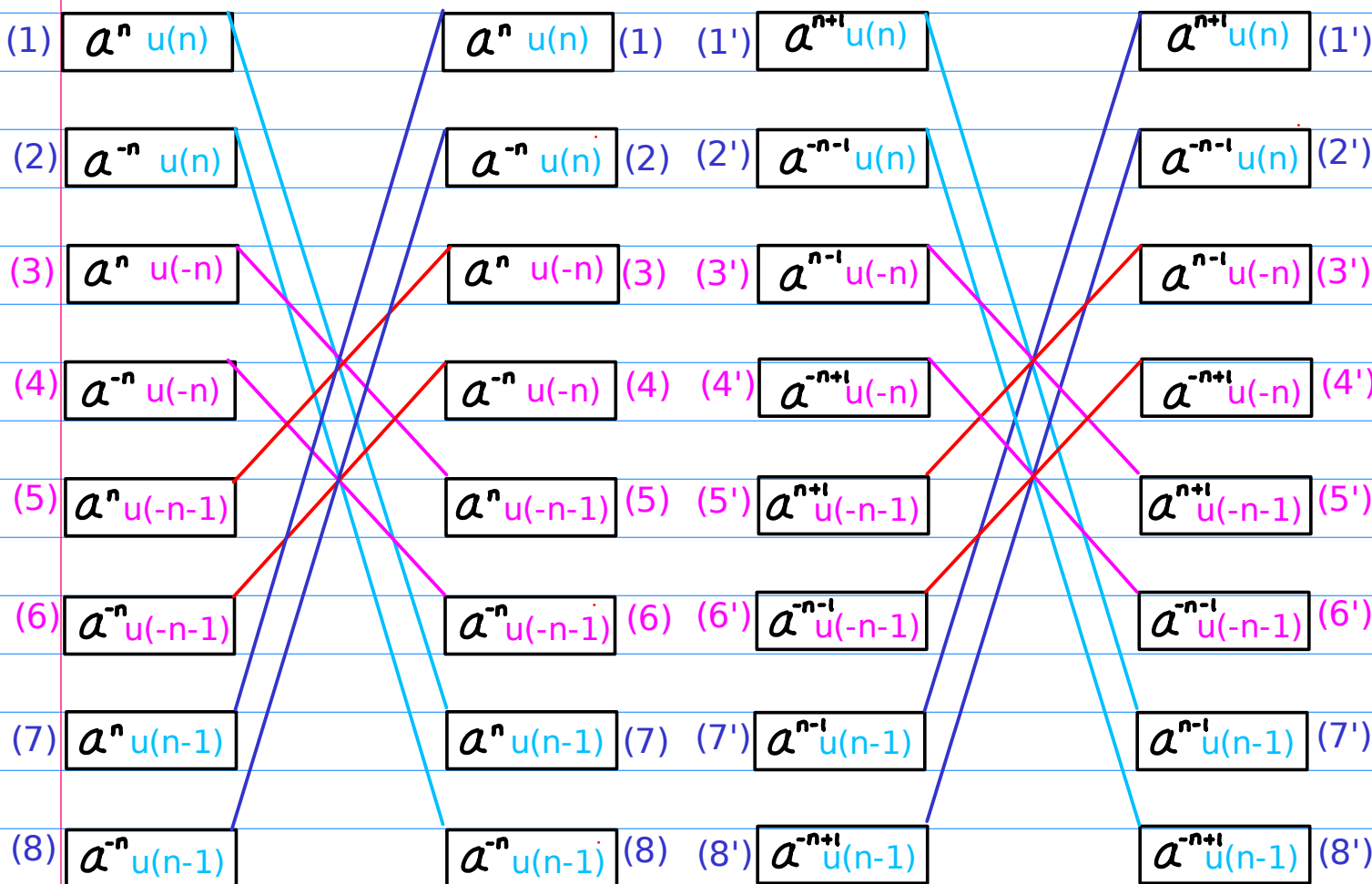
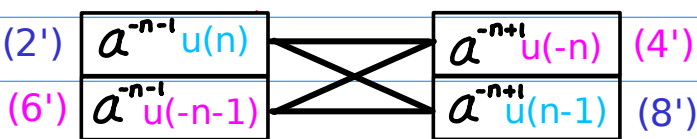
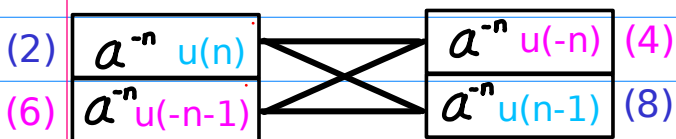
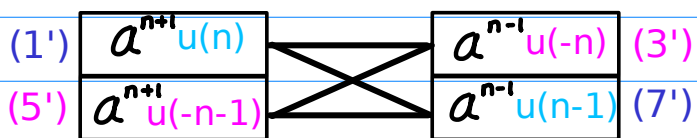
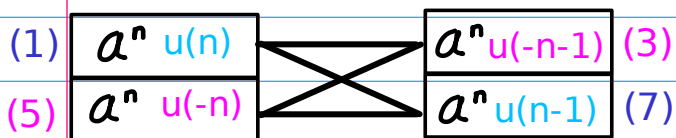

(1) - (7) (5) - (3)
 (2) - (8) (6) - (4)
 (3) - (5) (7) - (1)
 (4) - (6) (8) - (2)

(1') - (7') (5') - (3')
 (2') - (8') (6') - (4')
 (3') - (5') (7') - (1')
 (4') - (6') (8') - (2')

C.I Complementary Inverting Base Inverting Range Complementing

F.I Complementary Inverting Base Inverting Range Complementing

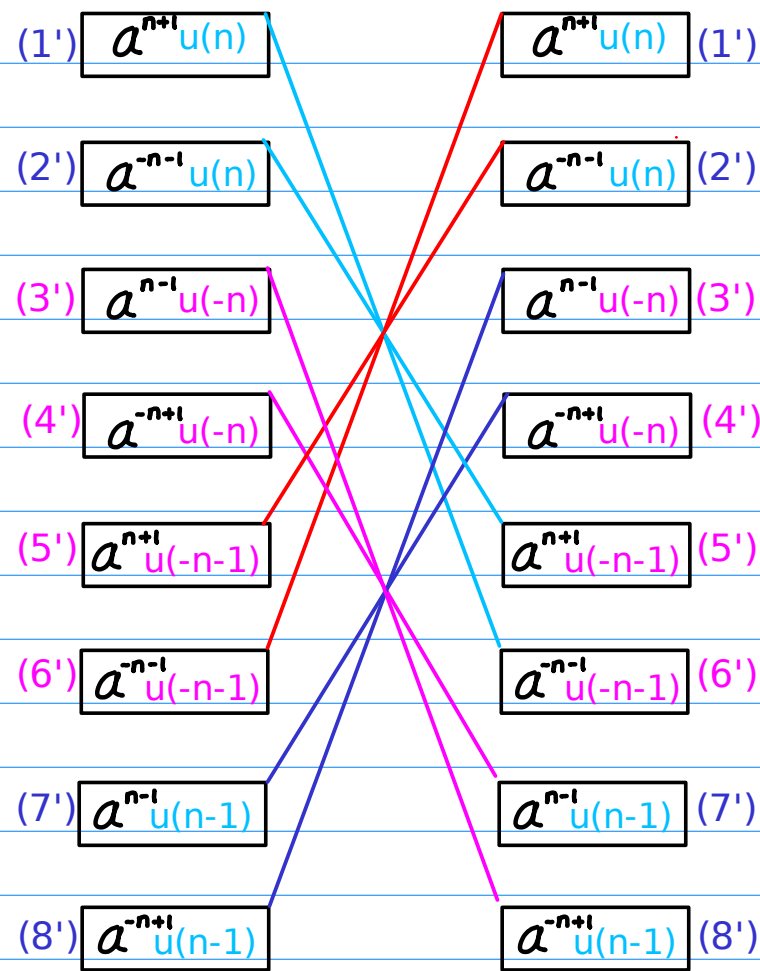
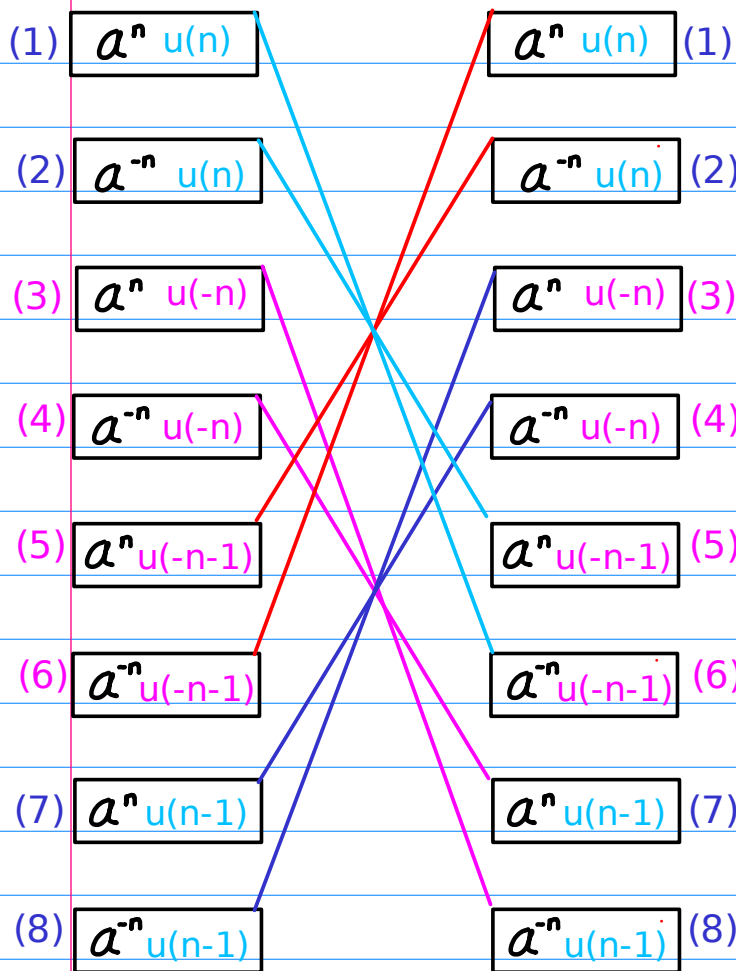
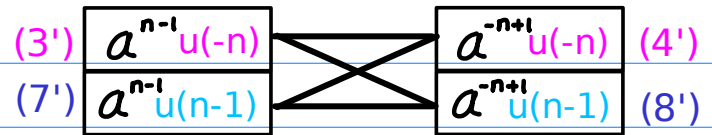
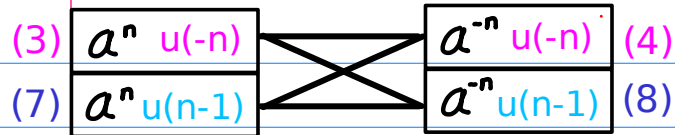
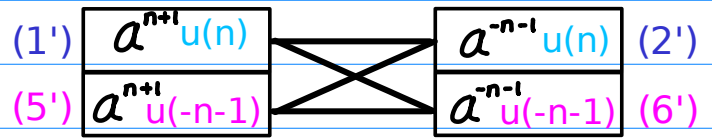
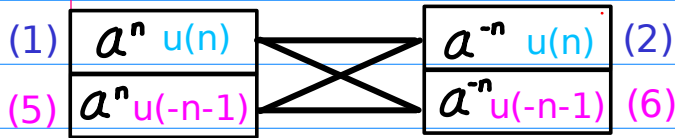

- (1) - (6)
- (6) - (1)
- (2) - (5)
- (5) - (2)
- (5) - (2)
- (8) - (3)

- (1') - (6')
- (6') - (1')
- (2') - (5')
- (5') - (2')
- (5') - (2')
- (8') - (3')



A.I Flipping

- (1) Base Inverting
- (2) Range Flipping

$$\begin{array}{|c|} \hline (1) \ a^n u(n) \\ \hline (3) \ a^n u(-n) \\ \hline \end{array} \begin{array}{c} \diagdown \quad \diagup \\ \diagup \quad \diagdown \end{array} \begin{array}{|c|} \hline a^{-n} u(n) \quad (2) \\ \hline a^{-n} u(-n) \quad (4) \\ \hline \end{array}$$

$$\begin{array}{|c|} \hline (5) \ a^n u(-n-1) \\ \hline (7) \ a^n u(n-1) \\ \hline \end{array} \begin{array}{c} \diagdown \quad \diagup \\ \diagup \quad \diagdown \end{array} \begin{array}{|c|} \hline a^{-n} u(-n-1) \quad (6) \\ \hline a^{-n} u(n-1) \quad (8) \\ \hline \end{array}$$

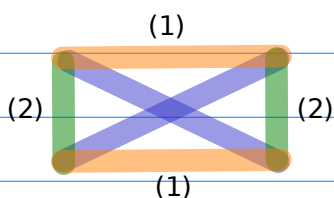

$$\begin{array}{ccc} a^n & \xleftrightarrow{(1)} & a^{-n} \\ R(n) & \xleftrightarrow{(2)} & R(-n) \\ a^n R(n) & \longleftrightarrow & a^{-n} R(-n) \end{array}$$

b^n	b^{-n}
a^n	a^{-n}
a^{-n}	a^n

$R(n)$	$R(-n)$
$u(n)$	$u(-n)$
$u(n-1)$	$u(-n-1)$
$u(-n)$	$u(n)$
$u(-n-1)$	$u(n-1)$

D.I Flipping2

- (1) Base Inverting
- (2) Shifted Range Flipping

$$\begin{array}{|c|} \hline (1') \ a^{n+1} u(n) \\ \hline (3') \ a^{n-1} u(-n) \\ \hline \end{array} \begin{array}{c} \diagdown \quad \diagup \\ \diagup \quad \diagdown \end{array} \begin{array}{|c|} \hline a^{-n-1} u(n) \quad (2') \\ \hline a^{-n+1} u(-n) \quad (4') \\ \hline \end{array}$$

$$\begin{array}{|c|} \hline (5') \ a^{n+1} u(-n-1) \\ \hline (7') \ a^{n-1} u(n-1) \\ \hline \end{array} \begin{array}{c} \diagdown \quad \diagup \\ \diagup \quad \diagdown \end{array} \begin{array}{|c|} \hline a^{-n-1} u(-n-1) \quad (6') \\ \hline a^{-n+1} u(n-1) \quad (8') \\ \hline \end{array}$$

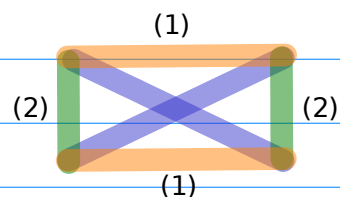

$$\begin{array}{ccc} a^n & \xleftrightarrow{(1)} & a^{-n} \\ a^n R(n) & \xleftrightarrow{(2)} & a^{sh2(n)} R(-n) \\ a^n R(n) & \longleftrightarrow & a^{-sh2(n)} R(-n) \end{array}$$

b^n	$b^{-sh2(n)}$
$a^{(n+1)}$	$a^{-(n-1)}$
$a^{-(n+1)}$	$a^{(n-1)}$
$a^{(n-1)}$	$a^{-(n+1)}$
$a^{-(n-1)}$	$a^{(n+1)}$

$R(n)$	$R(-n)$
$u(n)$	$u(-n)$
$u(n-1)$	$u(-n-1)$
$u(-n)$	$u(n)$
$u(-n-1)$	$u(n-1)$

B.I Range Shifting

(1) Range Complementing
(2) Range Flipping

E.I Shifting2

(1) Shifted Range Flipping
(2) Range Complementing

$$\begin{array}{l} (1) \ a^n u(n) \\ (5) \ a^n u(-n) \end{array} \begin{array}{c} \diagdown \quad \diagup \\ \diagup \quad \diagdown \end{array} \begin{array}{l} a^n u(-n-1) \quad (3) \\ a^n u(n-1) \quad (7) \end{array}$$

$$\begin{array}{l} (1') \ a^{n+1} u(n) \\ (5') \ a^{n+1} u(-n-1) \end{array} \begin{array}{c} \diagdown \quad \diagup \\ \diagup \quad \diagdown \end{array} \begin{array}{l} a^{n+1} u(-n) \quad (3') \\ a^{n+1} u(n-1) \quad (7') \end{array}$$

$$\begin{array}{l} (2) \ a^{-n} u(n) \\ (6) \ a^{-n} u(-n-1) \end{array} \begin{array}{c} \diagdown \quad \diagup \\ \diagup \quad \diagdown \end{array} \begin{array}{l} a^{-n} u(-n) \quad (4) \\ a^{-n} u(n-1) \quad (8) \end{array}$$

$$\begin{array}{l} (2') \ a^{-n-1} u(n) \\ (6') \ a^{-n-1} u(-n-1) \end{array} \begin{array}{c} \diagdown \quad \diagup \\ \diagup \quad \diagdown \end{array} \begin{array}{l} a^{-n-1} u(-n) \quad (4') \\ a^{-n-1} u(n-1) \quad (8') \end{array}$$

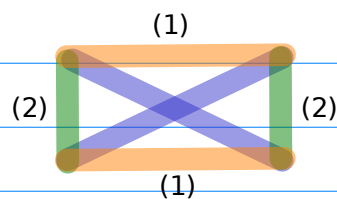
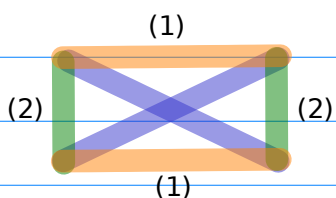

$$R(n) \xleftrightarrow{(1)} R(-n)$$

$$R(n) \xleftrightarrow{(2)} \overline{R(n)}$$

$$R(n) \longleftrightarrow \overline{R(-n)}$$

$$a^n R(n) \xleftrightarrow{(1)} a^{sh2(n)} \overline{R(-n)}$$

$$R(n) \xleftrightarrow{(2)} \overline{R(n)}$$

$$a^n R(n) \longleftrightarrow a^{sh2(n)} \overline{R(-n)}$$

$$b^n \qquad b^{sh2(n)}$$

$$a^{(n+1)} \qquad a^{(n-1)}$$

$$a^{-(n+1)} \qquad a^{-(n-1)}$$

$$a^{(n-1)} \qquad a^{(n+1)}$$

$$a^{-(n-1)} \qquad a^{-(n+1)}$$

$$\overline{R(n)} \qquad \overline{R(-n)}$$

$$u(n) \qquad u(n-1)$$

$$u(n-1) \qquad u(n)$$

$$u(-n) \qquad u(-n-1)$$

$$u(-n-1) \qquad u(-n)$$

$$\overline{R(n)} \qquad \overline{R(-n)}$$

$$u(n) \qquad u(n-1)$$

$$u(n-1) \qquad u(n)$$

$$u(-n) \qquad u(-n-1)$$

$$u(-n-1) \qquad u(-n)$$

C.I Complementary Inverting

(1) Base Inverting
(2) Range Complementing

F.I Complementary Inverting

(1) Base Inverting
(2) Range Complementing

$$\begin{array}{|c|} \hline (1) \ a^n u(n) \\ \hline (5) \ a^n u(-n-1) \\ \hline \end{array} \begin{array}{c} \diagdown \quad \diagup \\ \diagup \quad \diagdown \end{array} \begin{array}{|c|} \hline a^{-n} u(n) \ (2) \\ \hline a^{-n} u(-n-1) \ (6) \\ \hline \end{array}$$

$$\begin{array}{|c|} \hline (1') \ a^{n+1} u(n) \\ \hline (5') \ a^{n+1} u(-n-1) \\ \hline \end{array} \begin{array}{c} \diagdown \quad \diagup \\ \diagup \quad \diagdown \end{array} \begin{array}{|c|} \hline a^{-n-1} u(n) \ (2') \\ \hline a^{-n-1} u(-n-1) \ (6') \\ \hline \end{array}$$

$$\begin{array}{|c|} \hline (3) \ a^n u(-n) \\ \hline (7) \ a^n u(n-1) \\ \hline \end{array} \begin{array}{c} \diagdown \quad \diagup \\ \diagup \quad \diagdown \end{array} \begin{array}{|c|} \hline a^{-n} u(-n) \ (4) \\ \hline a^{-n} u(n-1) \ (8) \\ \hline \end{array}$$

$$\begin{array}{|c|} \hline (3') \ a^{-n-1} u(-n) \\ \hline (7') \ a^{-n-1} u(n-1) \\ \hline \end{array} \begin{array}{c} \diagdown \quad \diagup \\ \diagup \quad \diagdown \end{array} \begin{array}{|c|} \hline a^{-n+1} u(-n) \ (4') \\ \hline a^{-n+1} u(n-1) \ (8') \\ \hline \end{array}$$

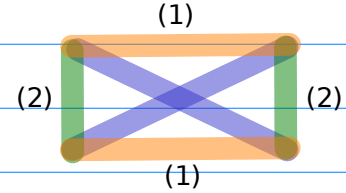
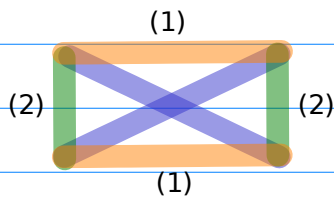

$$\begin{array}{ccc} a^n & \xleftrightarrow{(1)} & a^{-n} \\ R(n) & \xleftrightarrow{(2)} & \overline{R(n)} \\ a^n R(n) & \longleftrightarrow & a^{-n} \overline{R(n)} \end{array}$$

$$\begin{array}{ccc} a^n & \xleftrightarrow{(1)} & a^{-n} \\ R(n) & \xleftrightarrow{(2)} & \overline{R(n)} \\ a^n R(n) & \longleftrightarrow & a^{-n} \overline{R(n)} \end{array}$$

b^n	b^{-n}
a^n	a^{-n}
a^{-n}	a^n

b^n	b^{-n}
$a^{(n+1)}$	$a^{-(n+1)}$
$a^{-(n+1)}$	$a^{(n+1)}$
$a^{(n-1)}$	$a^{-(n-1)}$
$a^{-(n-1)}$	$a^{(n-1)}$

$R(n)$	$\overline{R(n)}$
$u(n)$	$u(-n-1)$
$u(n-1)$	$u(-n)$
$u(-n)$	$u(n)$
$u(-n-1)$	$u(n-1)$

$R(n)$	$\overline{R(n)}$
$u(n)$	$u(-n-1)$
$u(n-1)$	$u(-n)$
$u(-n)$	$u(n)$
$u(-n-1)$	$u(n-1)$

A.I Flipping

- (1) Base Inverting
- (2) Range Flipping

$$\begin{array}{ccc}
 a^n & \xleftrightarrow{(1)} & a^{-n} \\
 R(n) & \xleftrightarrow{(2)} & R(-n) \\
 a^n R(n) & \longleftrightarrow & a^{-n} R(-n)
 \end{array}$$

D.I Flipping2

- (1) Base Inverting
- (2) Shifted Range Flipping

$$\begin{array}{ccc}
 a^n & \xleftrightarrow{(1)} & a^{-n} \\
 a^n R(n) & \xleftrightarrow{(2)} & a^{sh2(n)} R(-n) \\
 a^n R(n) & \longleftrightarrow & a^{-sh2(n)} R(-n)
 \end{array}$$

$$\begin{array}{ccc}
 a^n R(n) & \xrightarrow{(1)} & a^{-n} R(n) \\
 & \xrightarrow{(2)} & a^{-n} R(-n)
 \end{array}$$

$$\begin{array}{ccc}
 a^n R(n) & \xrightarrow{(1)} & a^{-n} R(n) \\
 & \xrightarrow{(2)} & a^{-sh2(n)} R(-n)
 \end{array}$$

$$\begin{array}{ccc}
 a^n R(n) & \xrightarrow{(2)} & a^n R(-n) \\
 & \xrightarrow{(1)} & a^{-n} R(-n)
 \end{array}$$

$$\begin{array}{ccc}
 a^n R(n) & \xrightarrow{(2)} & a^{sh2(n)} R(-n) \\
 & \xrightarrow{(1)} & a^{-sh2(n)} R(-n)
 \end{array}$$

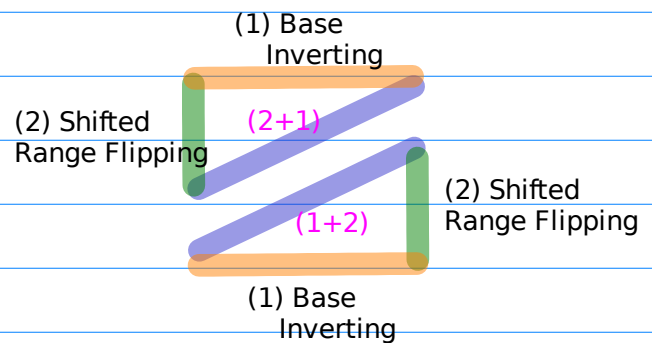
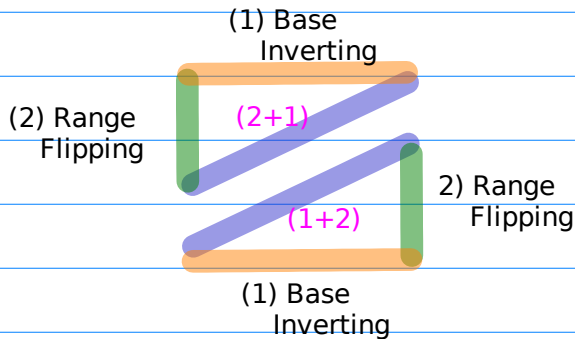
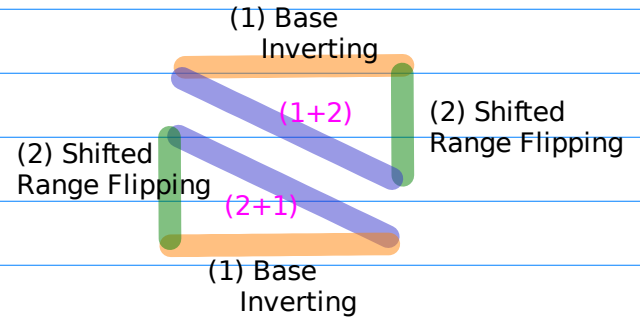
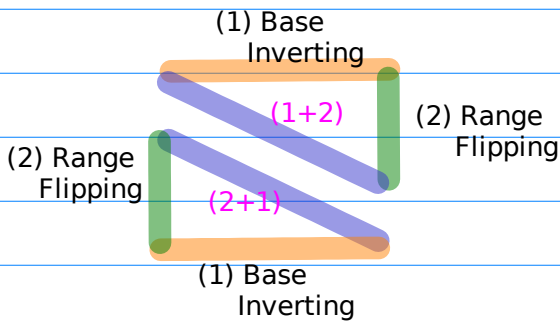

B.I Range Shifting
(1) Range Complementing
(2) Range Flipping

E.I Shifting2
(1) Shifted Range Flipping
(2) Range Complementing

$$R(n) \xleftrightarrow{(1)} R(-n)$$

$$R(n) \xleftrightarrow{(2)} \overline{R(n)}$$

$$R(n) \longleftrightarrow \overline{R(-n)}$$

$$a^n R(n) \xleftrightarrow{(1)} a^{sh2(n)} R(-n)$$

$$R(n) \xleftrightarrow{(2)} \overline{R(n)}$$

$$a^n R(n) \longleftrightarrow a^{sh2(n)} \overline{R(-n)}$$

$$a^n R(n) \xrightarrow{(1)} a^{-n} R(n)$$

$$\xrightarrow{(2)} a^{-n} \overline{R(n)}$$

$$a^n R(n) \xrightarrow{(1)} a^{-n} R(n)$$

$$\xrightarrow{(2)} a^{-sh2(n)} R(-n)$$

$$a^n rng(n) \xrightarrow{(2)} a^n \overline{R(n)}$$

$$\xrightarrow{(1)} a^{-n} \overline{R(n)}$$

$$a^n R(n) \xrightarrow{(2)} a^{sh2(n)} R(-n)$$

$$\xrightarrow{(1)} a^{-sh2(n)} R(-n)$$

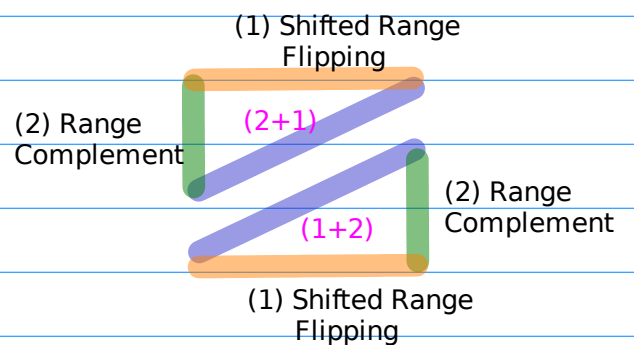
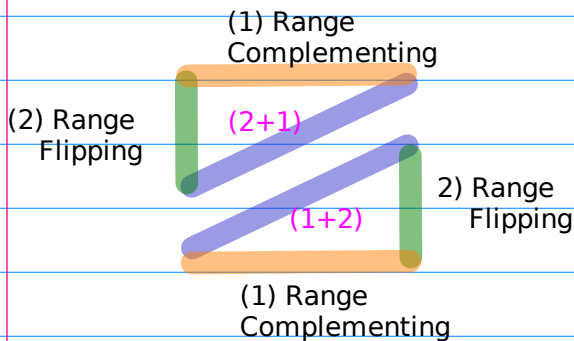
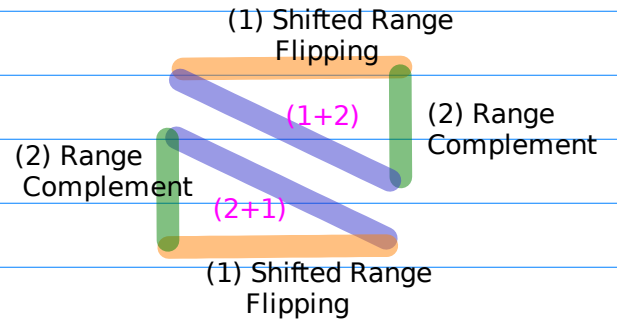
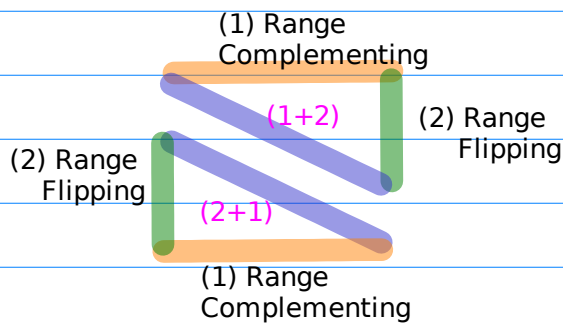

C.I Complementary Inverting

(1) Base Inverting
(2) Range Complementing

F.I Complementary Inverting

(1) Base Inverting
(2) Range Complementing

$$\begin{array}{ccc}
 a^n & \xleftrightarrow{(1)} & a^{-n} \\
 R(n) & \xleftrightarrow{(2)} & \overline{R(n)} \\
 a^n R(n) & \longleftrightarrow & a^{-n} \overline{R(n)}
 \end{array}$$

$$\begin{array}{ccc}
 a^n & \xleftrightarrow{(1)} & a^{-n} \\
 R(n) & \xleftrightarrow{(2)} & \overline{R(n)} \\
 a^n R(n) & \longleftrightarrow & a^{-n} \overline{R(n)}
 \end{array}$$

$$\begin{array}{ccc}
 a^n R(n) & \xrightarrow{(1)} & a^{-n} R(n) \\
 & \xrightarrow{(2)} & a^{-n} \overline{R(n)}
 \end{array}$$

$$\begin{array}{ccc}
 a^n R(n) & \xrightarrow{(1)} & a^{-n} R(n) \\
 & \xrightarrow{(2)} & a^{-n} \overline{R(n)}
 \end{array}$$

$$\begin{array}{ccc}
 a^n R(n) & \xrightarrow{(2)} & a^n \overline{R(n)} \\
 & \xrightarrow{(1)} & a^{-n} \overline{R(n)}
 \end{array}$$

$$\begin{array}{ccc}
 a^n R(n) & \xrightarrow{(2)} & a^n \overline{R(n)} \\
 & \xrightarrow{(1)} & a^{-n} \overline{R(n)}
 \end{array}$$

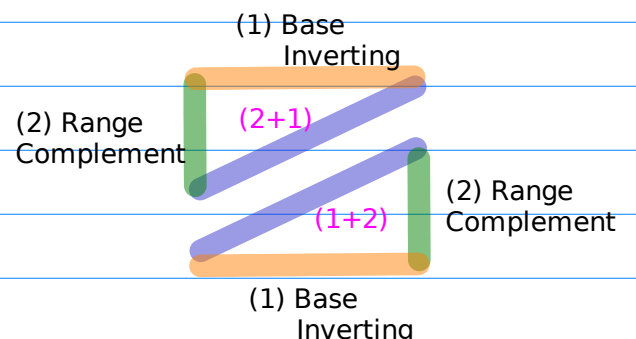
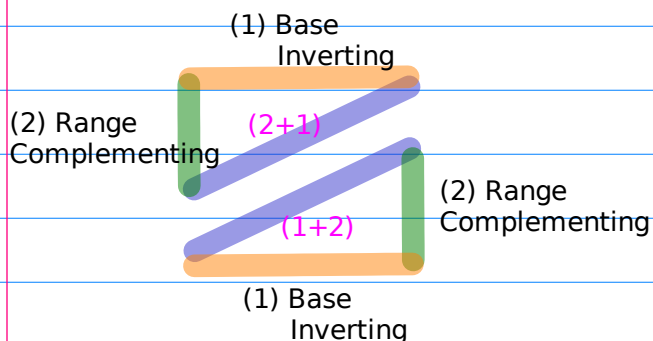
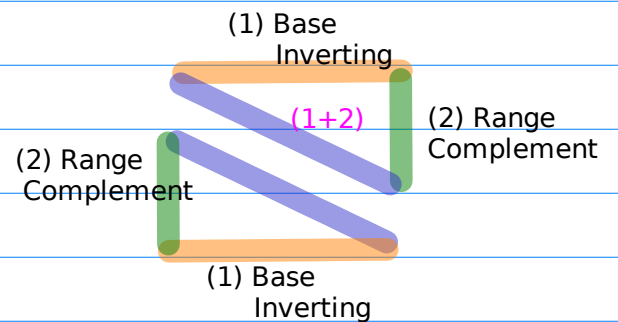
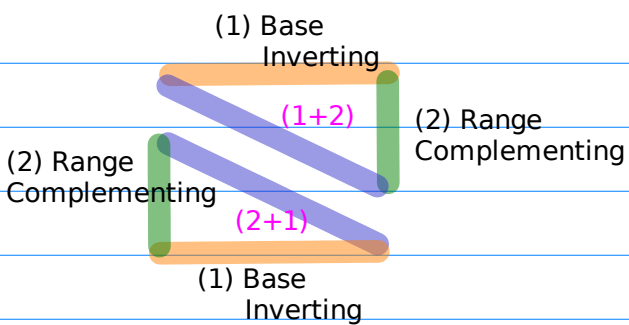





A.I Flipping Base Inverting Range Flipping

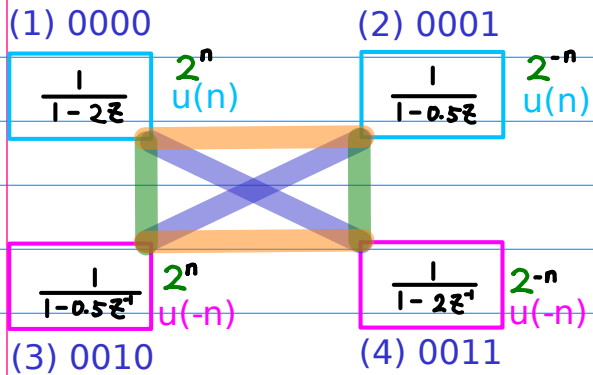

D.I Flipping2 Base Inverting Shifted Range Flipping

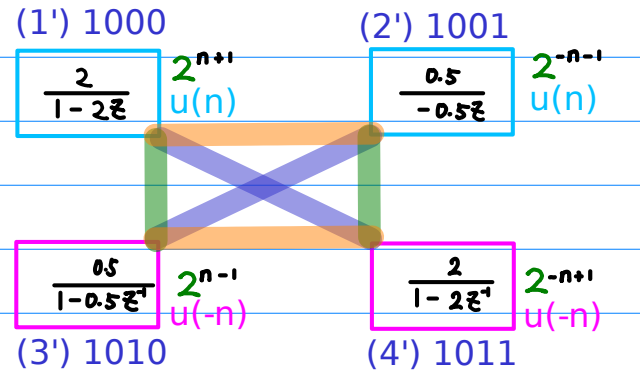

Shifted Range Flipping
= Exponent Shifting2
+ Range Flipping

$$a^n \longleftrightarrow a^{-n}$$

$$R(n) \longleftrightarrow R(-n)$$

$$a^n R(n) \longleftrightarrow a^{-n} R(-n)$$

$$a^n \longleftrightarrow a^{-n}$$

$$a^n R(n) \longleftrightarrow a^{sh2(n)} R(-n)$$

$$a^n R(n) \longleftrightarrow a^{-sh2(n)} R(-n)$$

B.I Range Shifting Range Flipping Range Complementing

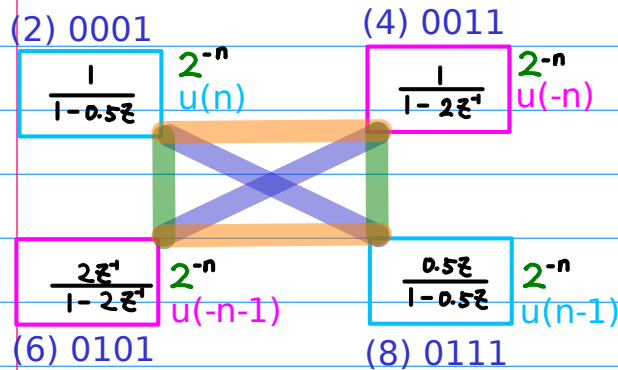
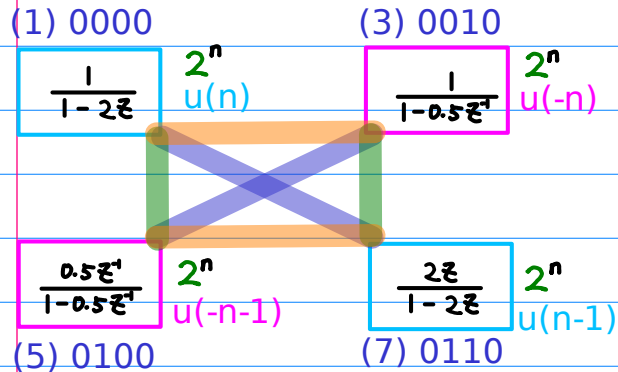

Range Shifting
= Range Flipping
+ Range Complementing

$$R(n) \longleftrightarrow R(-n)$$

$$R(n) \longleftrightarrow \overline{R(n)}$$

$$R(n) \longleftrightarrow \overline{R(-n)}$$

E.I Shifting2 Shifted Range Flipping Range Complementing

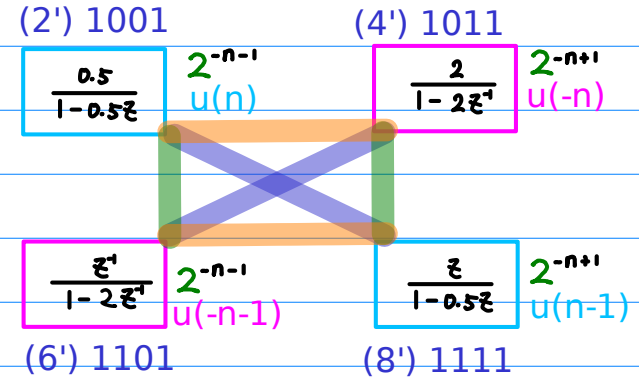
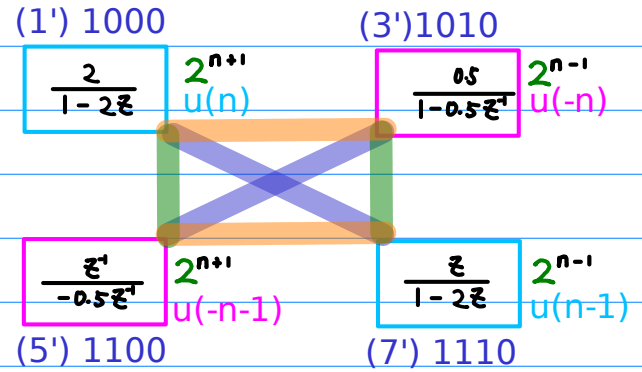

Shifted Range Flipping
= Exponent Shifting2
+ Range Flipping

$$a^n R(n) \longleftrightarrow a^{sh2(n)} R(-n)$$

$$R(n) \longleftrightarrow \overline{R(n)}$$

$$a^n R(n) \longleftrightarrow a^{sh2(n)} \overline{R(-n)}$$

C.I Complementary Inverting Base Inverting Range Complementing

F.I Complementary Inverting Base Inverting Range Complementing

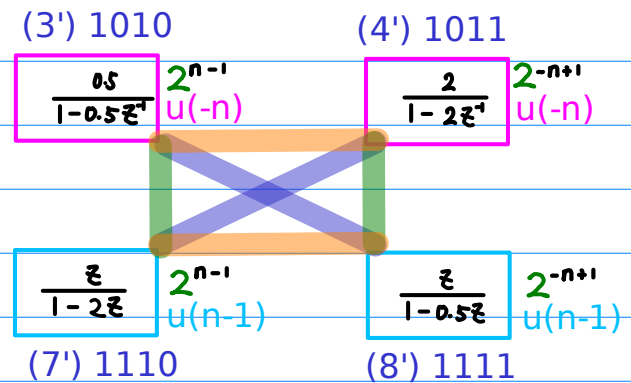
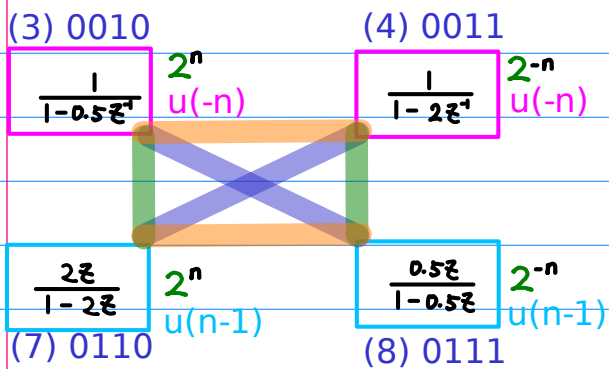
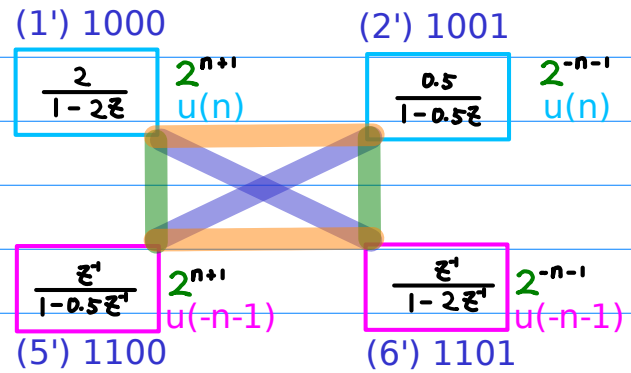
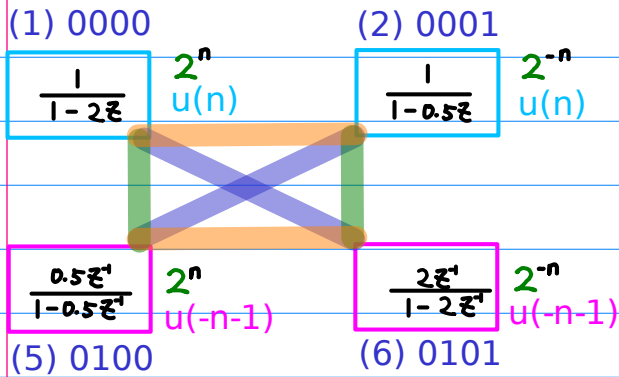

$$a^n \longleftrightarrow a^{-n}$$

$$R(n) \longleftrightarrow \overline{R(n)}$$

$$a^n \longleftrightarrow a^{-n}$$

$$R(n) \longleftrightarrow \overline{R(n)}$$

$$a^n R(n) \longleftrightarrow a^{-n} \overline{R(n)}$$

$$a^n R(n) \longleftrightarrow a^{-n} \overline{R(n)}$$

A.II Flipping Base Inverting Range Flipping

(1) 0000

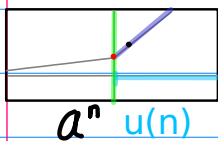

$$a^n u(n)$$

(4) 0011

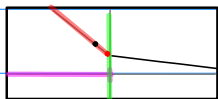

$$a^{-n} u(-n)$$

(3) 0010

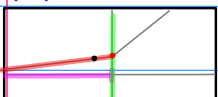

$$a^n u(-n)$$

(2) 0001

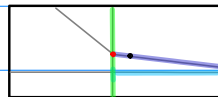

$$a^{-n} u(n)$$

(5) 0100

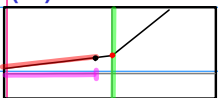

$$a^n u(-n-1)$$

(8) 0111

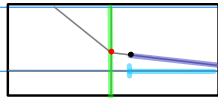

$$a^{-n} u(n-1)$$

(7) 0110

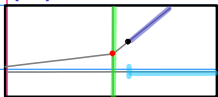

$$a^n u(n-1)$$

(6) 0101

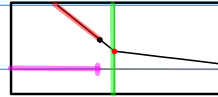

$$a^{-n} u(-n-1)$$

D.II Flipping2 Base Inverting Shifted Range Flipping

(1') 1000

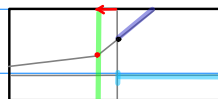

$$a^{n+1} u(n)$$

(4') 1011

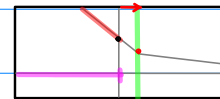

$$a^{-n+1} u(-n)$$

(3') 1010

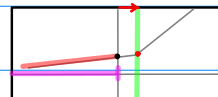

$$a^{n-1} u(-n)$$

(2') 1001

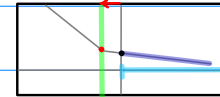

$$a^{-n-1} u(n)$$

(5') 1100

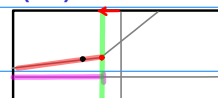

$$a^{n+1} u(-n-1)$$

(8') 1111

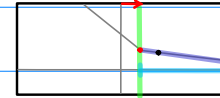

$$a^{-n+1} u(n-1)$$

(7') 1110

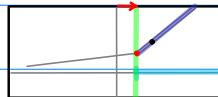

$$a^{n-1} u(n-1)$$

(6') 1101

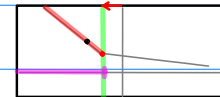

$$a^{-n-1} u(-n-1)$$

Shifted Range Flipping
= Exponent Shifting2
+ Range Flipping

$$a^n R(n) \longleftrightarrow a^{-n} R(-n)$$

$$a^n R(n) \longleftrightarrow a^{-sh2(n)} R(-n)$$

$$a^n \longleftrightarrow a^{-n}$$

$$a^n \longleftrightarrow a^{-n}$$

$$R(n) \longleftrightarrow R(-n)$$

$$a^n R(n) \longleftrightarrow a^{sh2(n)} R(-n)$$

B.II Range Shifting Range Flipping Range Complementing

(1) 0000

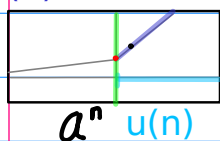

(7) 0110

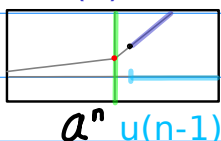

(5) 0100

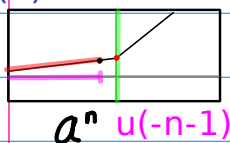

(3) 0010

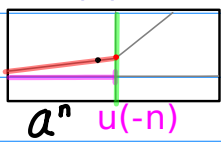

(2) 0001

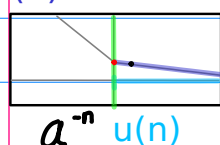

(8) 0111

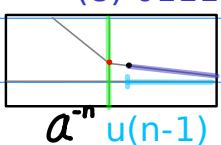

(6) 0101

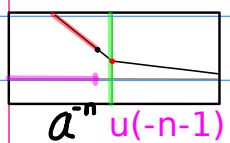

(4) 0011

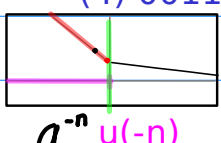

Range Shifting
= Range Flipping
+ Range Complementing

$$R(n) \longleftrightarrow \overline{R(-n)}$$

$$R(n) \longleftrightarrow R(-n)$$

$$R(n) \longleftrightarrow \overline{R(n)}$$

E.II Shifting2 Shifted Range Flipping Range Complementing

(1') 1000

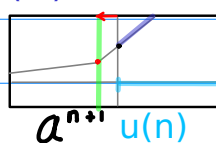

(7') 1110

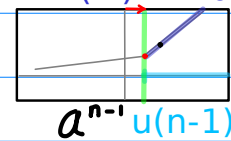

(5') 1100

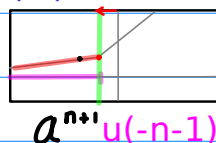

(3') 1010

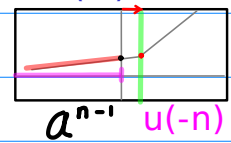

(2') 1001

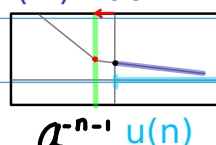

(8') 1111

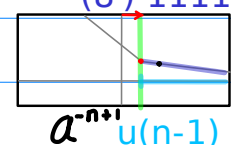

(6') 1101

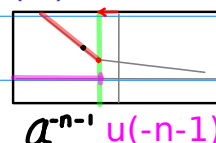

(4') 1011

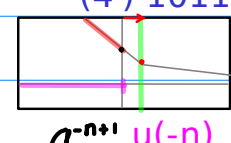

Shifted Range Flipping
= Exponent Shifting2
+ Range Flipping

$$a^n R(n) \longleftrightarrow a^{sh2(n)} \overline{R(-n)}$$

$$a^n R(n) \longleftrightarrow a^{sh2(n)} R(-n)$$

$$R(n) \longleftrightarrow \overline{R(n)}$$

C.II Complementary Inverting Base Inverting Range Complementing

F.II Complementary Inverting Base Inverting Range Complementing

(1) 0000

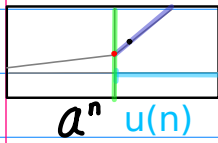

$a^{-n} u(-n-1)$

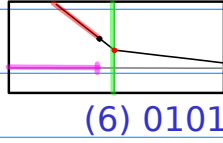

(6) 0101

(1') 1000

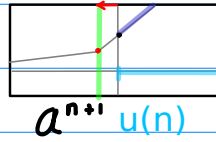

$a^{n+1} u(n)$

$a^{-n-1} u(-n-1)$

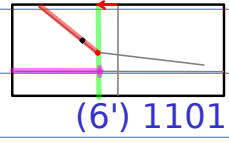

(6') 1101

(5) 0100

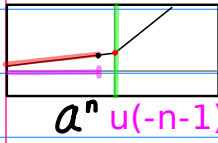

$a^n u(-n-1)$

(2) 0001

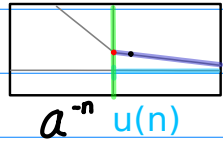

$a^{-n} u(n)$

(5') 1100

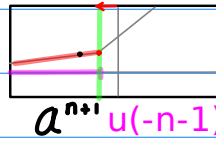

$a^{n+1} u(-n-1)$

(2') 1001

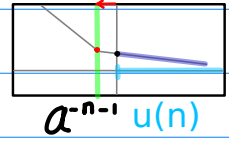

$a^{-n-1} u(n)$

(3) 0010

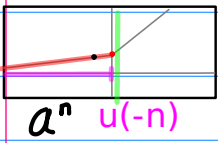

$a^n u(-n)$

(8) 0111

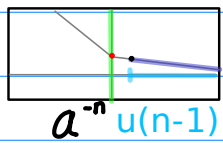

$a^{-n} u(n-1)$

(3') 1010

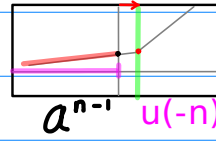

$a^{n-1} u(-n)$

(8') 1111

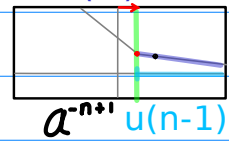

$a^{-n+1} u(n-1)$

(7) 0110

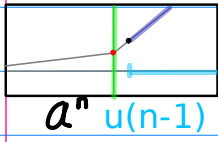

$a^n u(n-1)$

(4) 0011

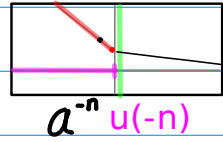

$a^{-n} u(-n)$

(7') 1110

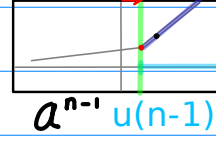

$a^{n-1} u(n-1)$

(4') 1011

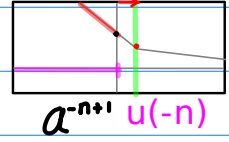

$a^{-n+1} u(-n)$

$$a^n R(n) \longleftrightarrow a^{-n} \overline{R(n)}$$

$$a^n R(n) \longleftrightarrow a^{-n} \overline{R(n)}$$

$$a^n \longleftrightarrow a^{-n}$$

$$R(n) \longleftrightarrow \overline{R(n)}$$

$$a^n \longleftrightarrow a^{-n}$$

$$R(n) \longleftrightarrow \overline{R(n)}$$



A. Flipping

Base Inverting
Range Flipping

B. Range Shifting = Range Flipping + Range Complementing

Range Flipping
Range Complementing

C. Complementary Inverting

Base Inverting
Range Complementing

D. Flipping²

Base Inverting
Shifted Range Flipping = Exponent Shifting² + Range Flipping

E. Shifting² = Exponent Shifting² + Range Shifting

Shifted Range Flipping = Exponent Shifting² + Range Flipping
Range Complementing

F. Complementary Inverting

Base Inverting
Range Complementing

Base Inverting

$$2^{n+1} \longleftrightarrow 2^{-(n+1)}$$

$$2^n \cdot 2^{+1} \longleftrightarrow 2^{-n} \cdot 2^{-1}$$

$$2^{n-1} \longleftrightarrow 2^{-(n-1)}$$

$$2^n \cdot 2^{-1} \longleftrightarrow 2^{-n} \cdot 2^{+1}$$

as a scaling

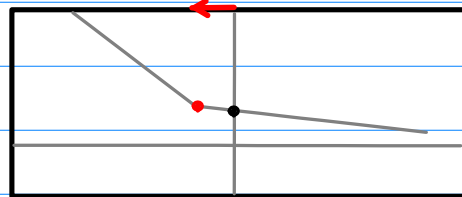
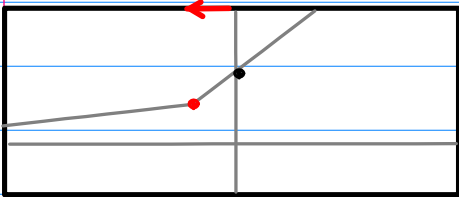
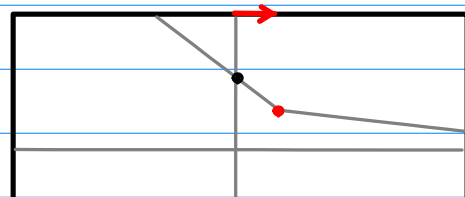
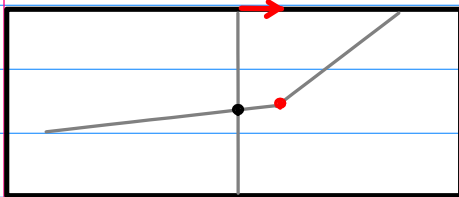
 2^{n+1}

 $2^{-(n+1)}$
 2^{n-1}

 $2^{-(n-1)}$

$$b^n \qquad b^{-n}$$

$$a^n \qquad a^{-n}$$

$$a^{-n} \qquad a^n$$

$$b^n \qquad b^{-sh2(n)}$$

$$a^{(n+1)} \qquad a^{-(n-1)}$$

$$a^{-(n+1)} \qquad a^{(n-1)}$$

$$a^{(n-1)} \qquad a^{-(n+1)}$$

$$a^{-(n-1)} \qquad a^{(n+1)}$$

Exponent Shifting2 sh2(n)

$$2^{n+1} \longleftrightarrow 2^{n-1}$$

$$2^{-(n+1)} \longleftrightarrow 2^{-(n-1)}$$

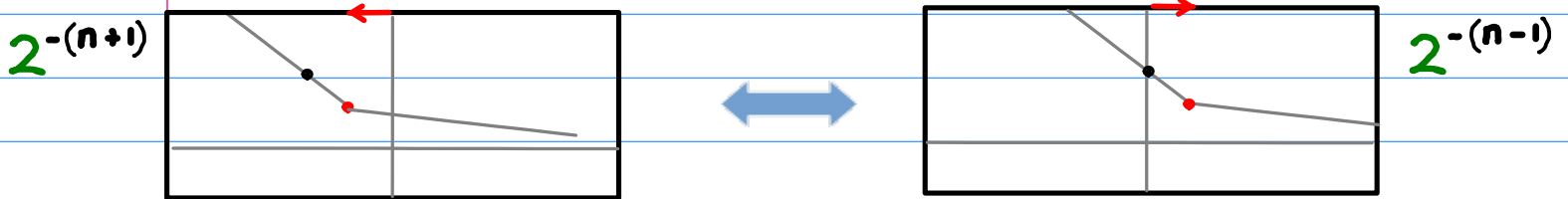
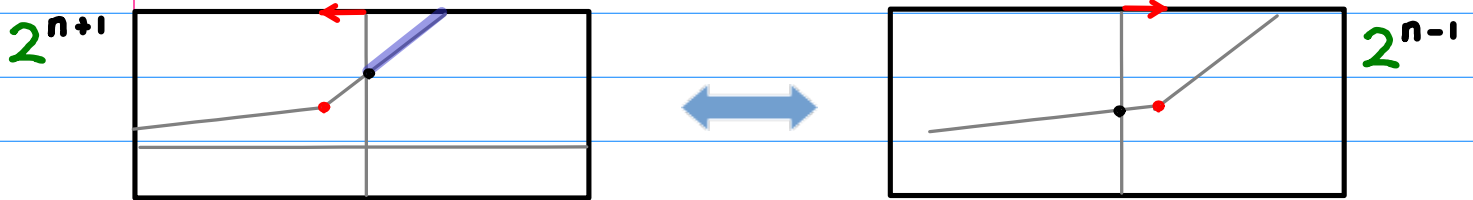

Base Inverting

Shifted Range Flipping

$$a^n \longleftrightarrow a^{-n}$$

$$a^n R(n) \longleftrightarrow a^{sh2(n)} R(-n)$$

Exponent Shifting2	
b^n	$b^{sh2(n)}$
$a^{(n+1)}$	$a^{(n-1)}$
$a^{-(n+1)}$	$a^{-(n-1)}$
$a^{(n-1)}$	$a^{(n+1)}$
$a^{-(n-1)}$	$a^{-(n+1)}$

Exponent Shifting2 **Range Flipping**

$$a^n R(n) \longleftrightarrow a^{-sh2(n)} R(-n)$$

Exponent Shifting2 sh2(n)

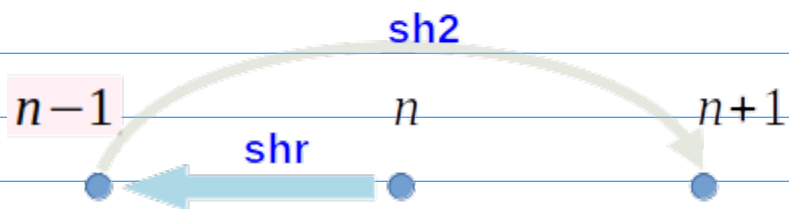
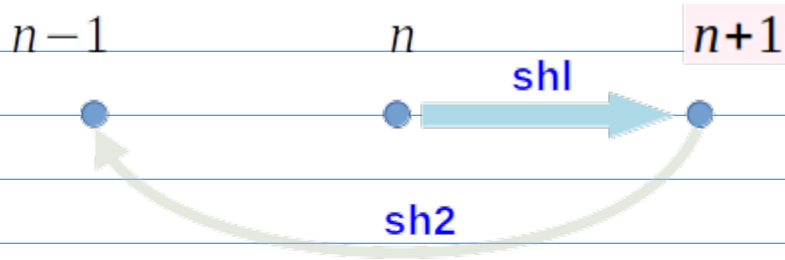

n		$sh2(n)$
$n+1$	$n \leftarrow n-2$	$n-1$
$n-1$	$n \leftarrow n+2$	$n+1$
$-(n+1)$	$n \leftarrow n-2$	$-(n-1)$
$-(n-1)$	$n \leftarrow n+2$	$-(n+1)$

Inverted Shifting2 -sh2(n)

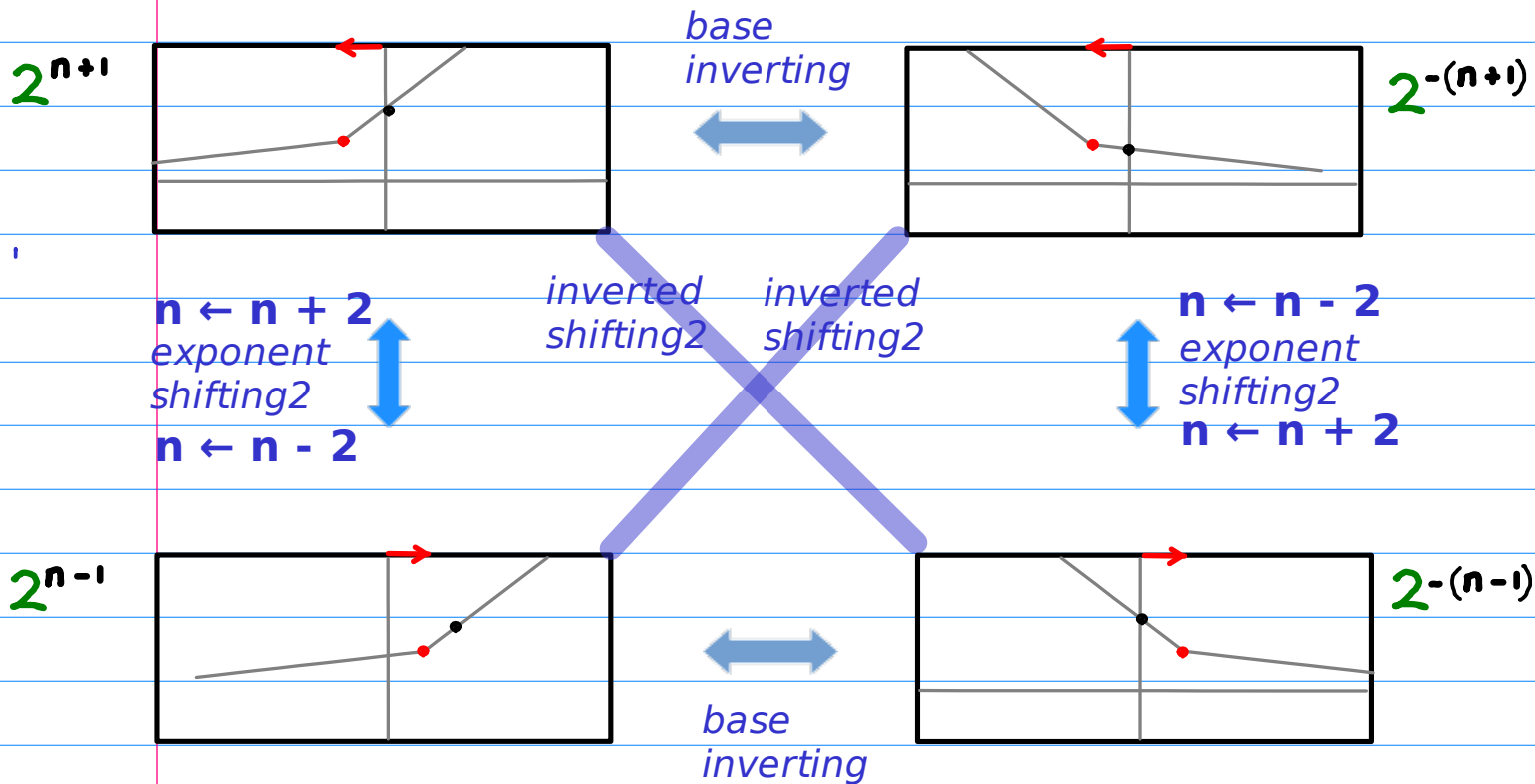

Inverted Shifting2

b^n	$b^{-sh2(n)}$
$a^{(n+1)}$	$a^{-(n-1)}$
$a^{-(n+1)}$	$a^{(n-1)}$
$a^{(n-1)}$	$a^{-(n+1)}$
$a^{-(n-1)}$	$a^{(n+1)}$

$$a^n \longleftrightarrow a^{-n}$$

$$a^n R(n) \longleftrightarrow a^{sh2(n)} R(-n)$$

Exponent Shifting2 **Range Flipping**

$$a^n R(n) \longleftrightarrow a^{-sh2(n)} R(-n)$$

Inverted Shifting2

A.2a Flipping

- Base Inverting
- Range Flipping

$$a^n R(n) \longleftrightarrow a^{-n} R(-n)$$

1) Base Inverting

$$a^n \longleftrightarrow a^{-n}$$

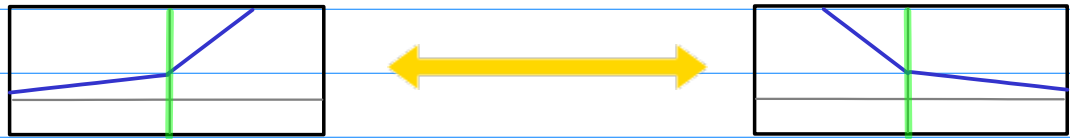

2) Range Flipping

$$R(n) \longleftrightarrow R(-n)$$

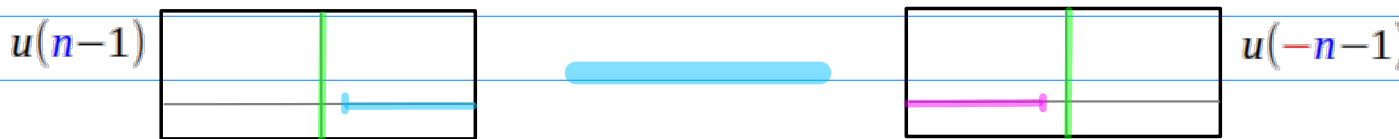
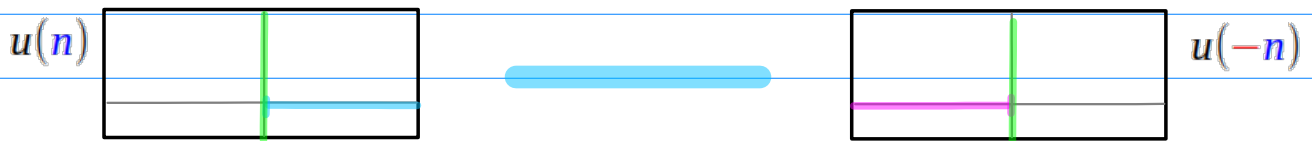

3) Flipping

$$a^n R(n) \longleftrightarrow a^{-n} R(-n)$$

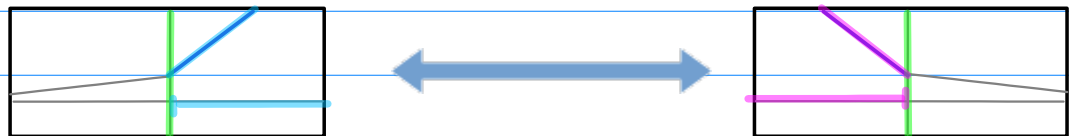

1) Base Inverting

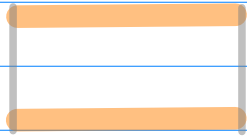
 a^n a^{-n} 

$$\boxed{0} \boxed{b_2} \boxed{b_1} \boxed{b_0} \longrightarrow \boxed{0} \boxed{b_2} \boxed{b_1} \boxed{\bar{b}_0}$$

2) Range Flipping

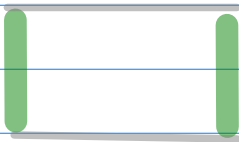

$$\boxed{0} \boxed{b_2} \boxed{b_1} \boxed{b_0} \longrightarrow \boxed{0} \boxed{b_2} \boxed{\bar{b}_1} \boxed{b_0}$$

3) Flipping

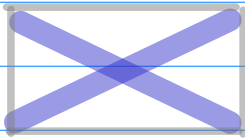

$$\boxed{0} \boxed{b_2} \boxed{b_1} \boxed{b_0} \longrightarrow \boxed{0} \boxed{b_2} \boxed{\bar{b}_1} \boxed{\bar{b}_0}$$

Range Shifting over (1) ~ (8)

$$R(n) \longleftrightarrow \overline{R(-n)}$$

(1) Range Flipping

$$R(n) \longleftrightarrow R(-n)$$

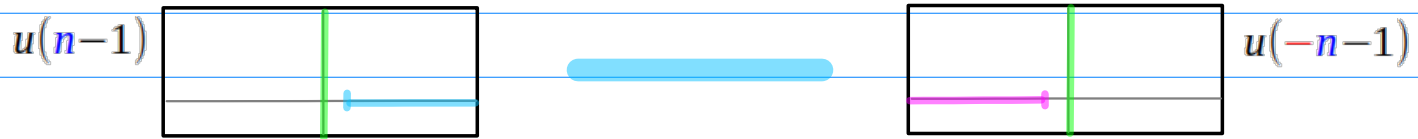
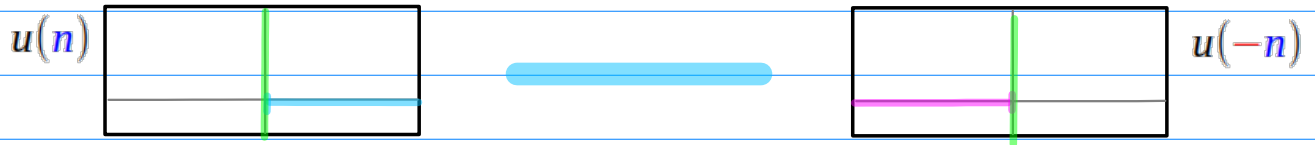

(2) Range Complementing

$$R(n) \longleftrightarrow \overline{R(n)}$$



(1+2) Range Shifting

$$R(n) \longleftrightarrow \overline{R(-n)}$$

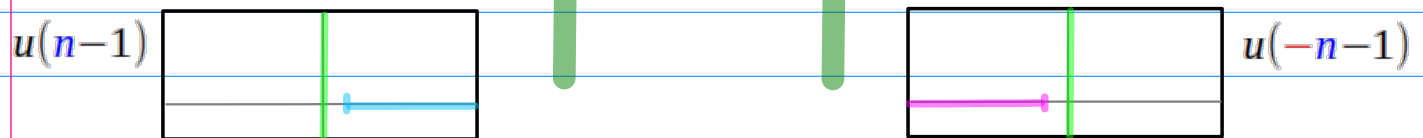
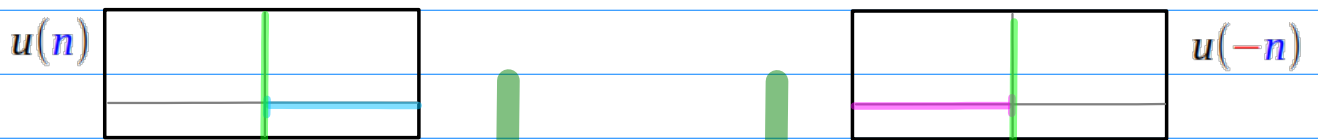

Range Shifting = Range Flipping + Range Complementing

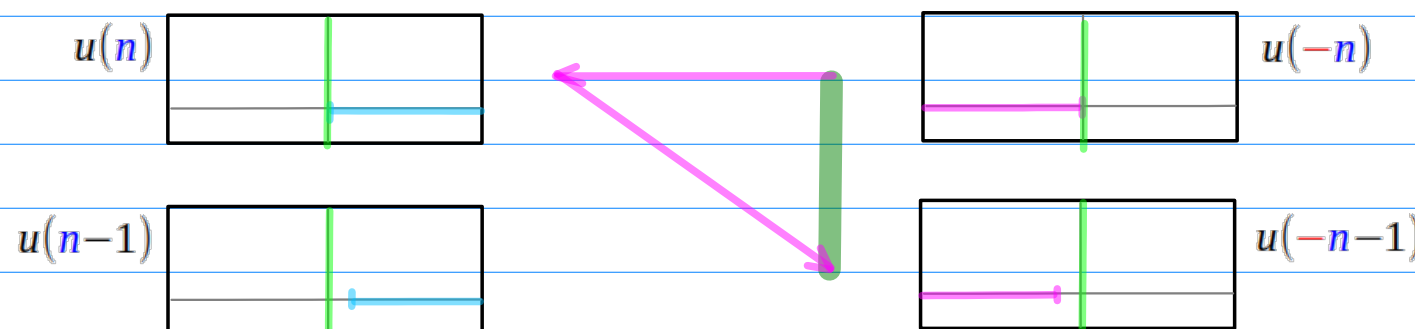
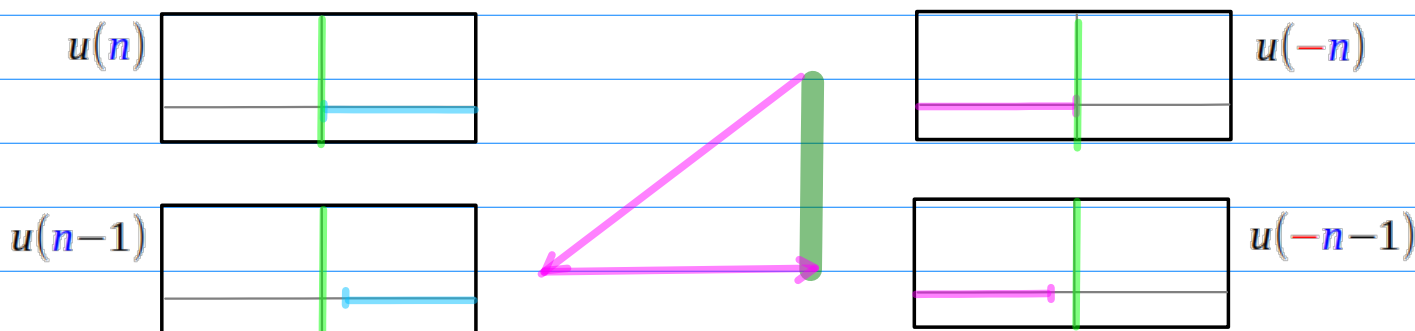
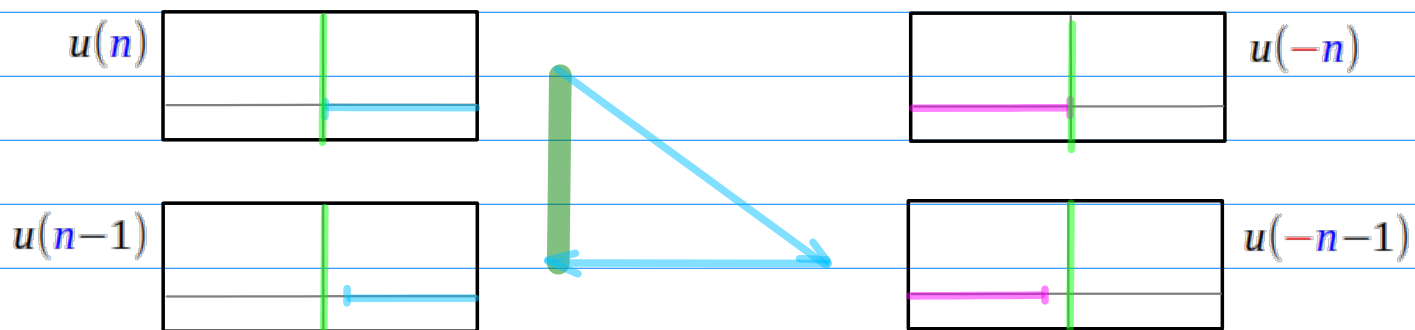
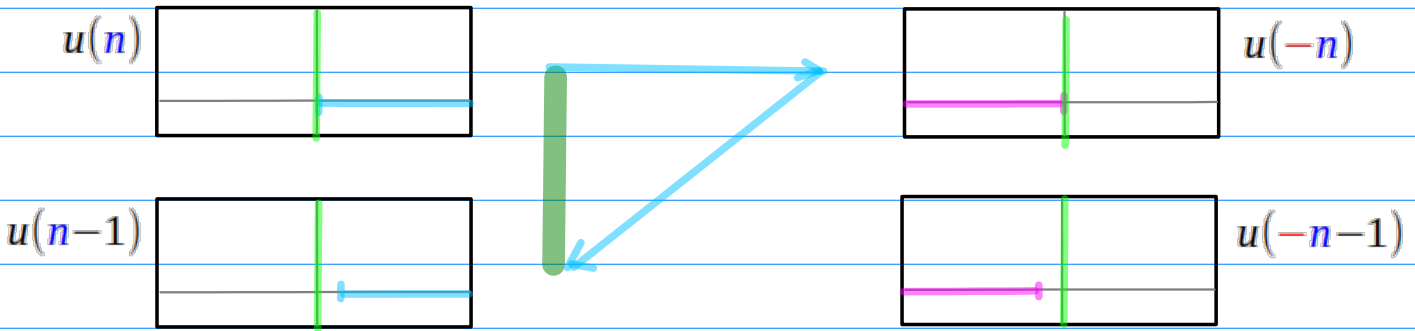

Range Shifting, Range Flipping, Range Complementing

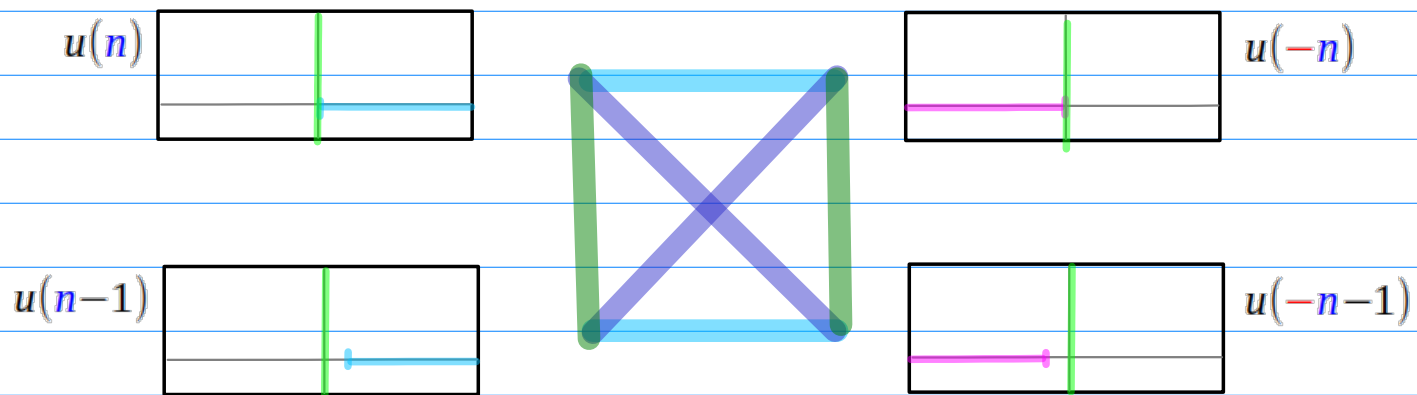

1) Range Flipping

$$R(n) \longleftrightarrow R(-n)$$

2) Range Complementing

$$R(n) \longleftrightarrow \overline{R(n)}$$

3) Range Shifting

$$R(n) \longleftrightarrow \overline{R(-n)}$$

$$R(n) \quad R(-n)$$

$$u(n) \quad u(-n)$$

$$u(n-1) \quad u(-n-1)$$

$$u(-n) \quad u(n)$$

$$u(-n-1) \quad u(n-1)$$

$$R(n) \quad \overline{R(n)}$$

$$u(n) \quad u(-n-1)$$

$$u(n-1) \quad u(-n)$$

$$u(-n) \quad u(n)$$

$$u(-n-1) \quad u(n-1)$$

$$R(n) \quad \overline{R(-n)}$$

$$u(n) \quad u(n-1)$$

$$u(n-1) \quad u(n)$$

$$u(-n) \quad u(-n-1)$$

$$u(-n-1) \quad u(-n)$$

**B.2b Range Shifting
Range Flipping
Range Complementing**

$$R(n) \longleftrightarrow \overline{R(-n)}$$

1) Range Flipping



2) Range Complementing

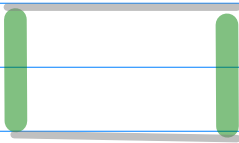

3) Range Shifting

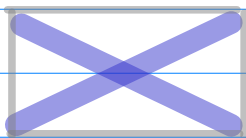



Complementary Inverting over (1) ~ (8)

$$a^n R(n)$$



$$a^{-n} \overline{R(n)}$$

(1) Base Inverting

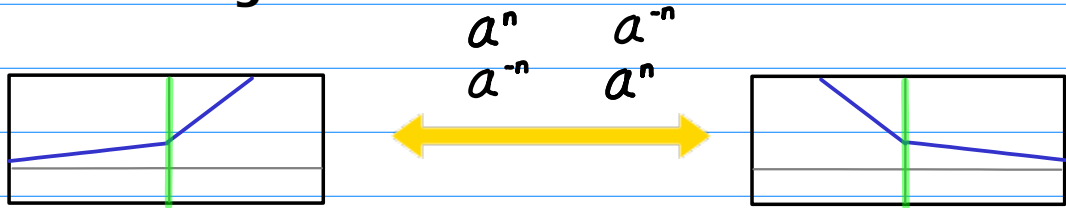

(2) Range Complementing

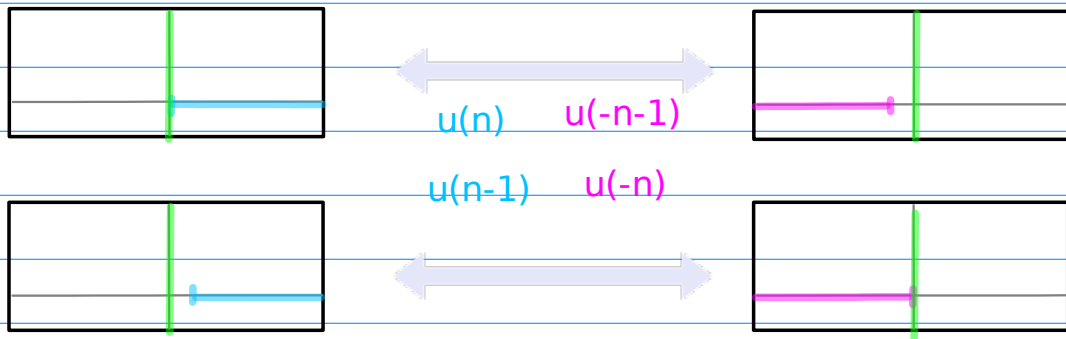

(1+2) Complementary Inverting

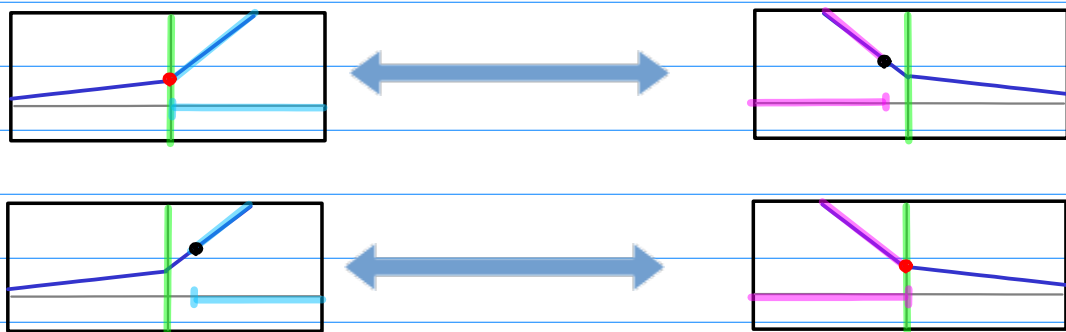

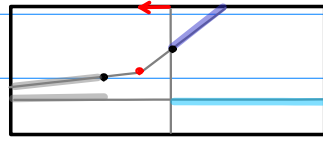

$$a^{n+1}$$

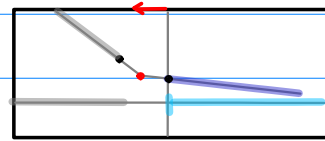

$$a^{-n-1}$$

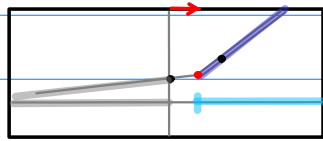

$$a^{n-1}$$

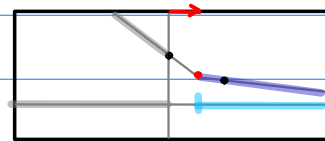

$$a^{-n+1}$$

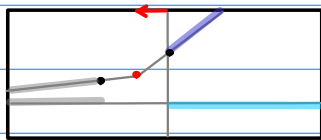

$$a^{n+1} u(n)$$

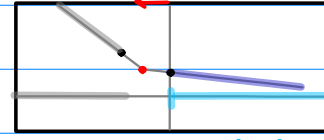

$$a^{-n-1} u(n)$$

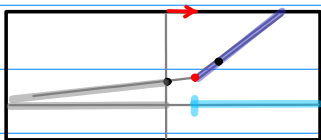

$$a^{n-1} u(n-1)$$

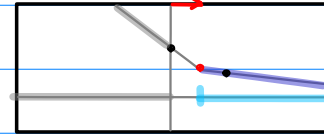

$$a^{-n+1} u(n-1)$$

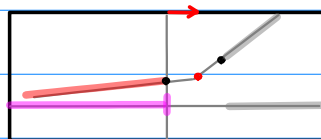

$$a^{n-1} u(-n)$$

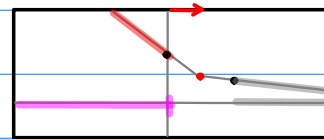

$$a^{-n+1} u(-n)$$

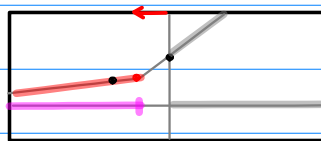

$$a^{n+1} u(-n-1)$$

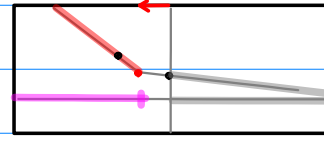

$$a^{-n-1} u(-n-1)$$

**C.2b Complementary Inverting
Exponent Flipping
Range Complementing**

$$a^n R(n) \iff a^{-n} \overline{R(n)}$$

1) Base Inverting

$$a^n$$

$$a^{-n}$$

2) Range Complementing

3) Complementary Flipping

Shifted Range Flipping

$$a^n R(n) \longleftrightarrow a^{sh2(n)} R(-n)$$

Exponent Shifting2

$$a^n \longleftrightarrow a^{sh2(n)}$$

+ Base Inverting

$$a^n \longleftrightarrow a^{-sh2(n)}$$

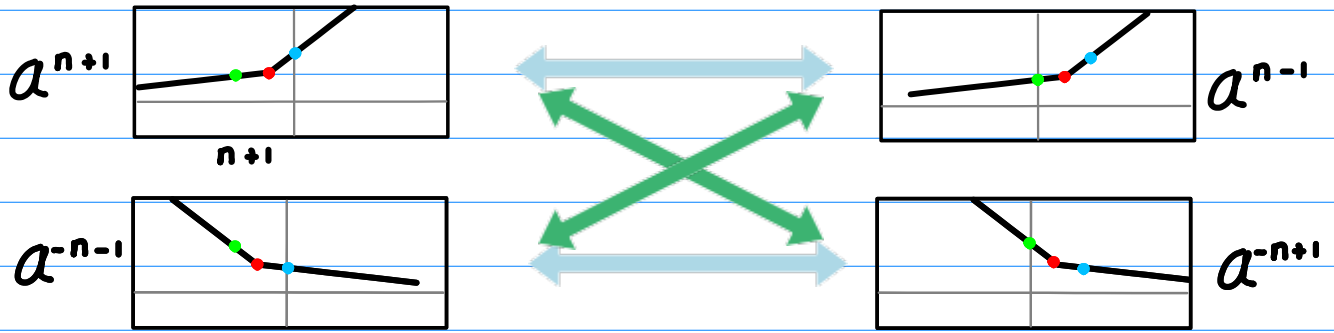

Range Flipping

$$R(n) \longleftrightarrow R(-n)$$

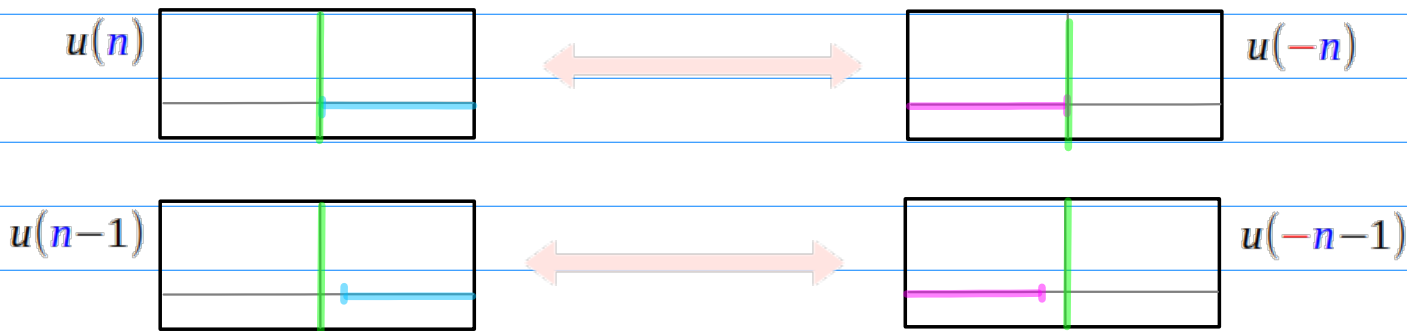

b^n	$b^{-sh2(n)}$
$a^{(n+1)}$	$a^{-(n-1)}$
$a^{-(n+1)}$	$a^{(n-1)}$
$a^{(n-1)}$	$a^{-(n+1)}$
$a^{-(n-1)}$	$a^{(n+1)}$

$R(n)$	$R(-n)$
$u(n)$	$u(-n)$
$u(n-1)$	$u(-n-1)$
$u(-n)$	$u(n)$
$u(-n-1)$	$u(n-1)$



Shifted Range Flipping

Flipping2

$$a^n R(n) \longleftrightarrow a^{sh2(n)} R(-n)$$

$$a^n R(n) \longleftrightarrow a^{-sh2(n)} R(-n)$$

Flipping2 = Base Inverting + Shifted Range Flipping
 = Base Inverting + Exponent Shifting2 + Range Flipping

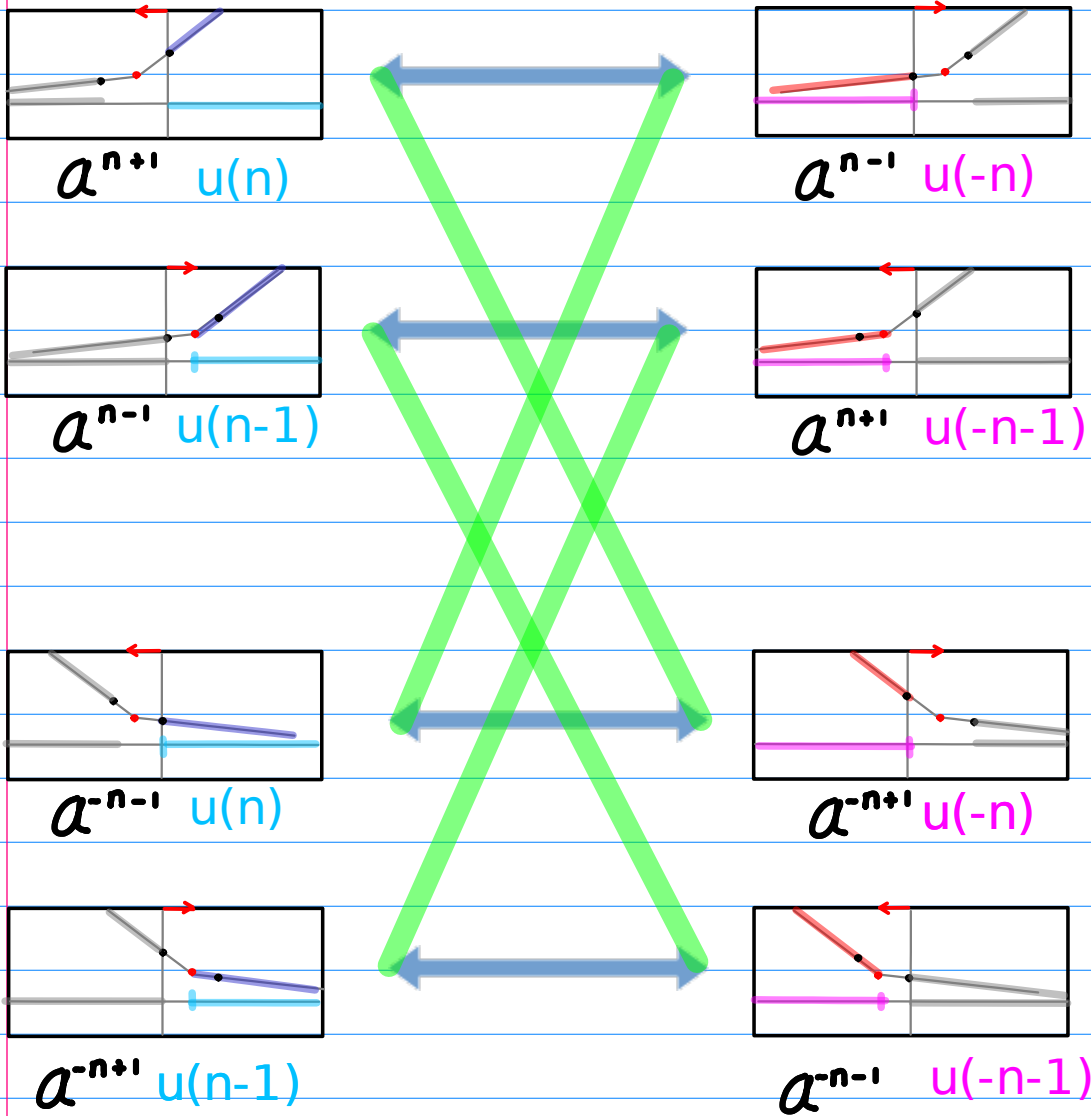

Shifted Range Flipping

$$a^n R(n) \longleftrightarrow a^{sh2(n)} R(-n)$$

Shifting2

$$a^n R(n) \longleftrightarrow a^{sh2(n)} \overline{R(-n)}$$

shifting2 = Shifted Range Flipping + Range Complementing
 = Exponent Shifting2 + Range (Flipping + Complementing)
 = Exponent Shifting2 + Range Shifting

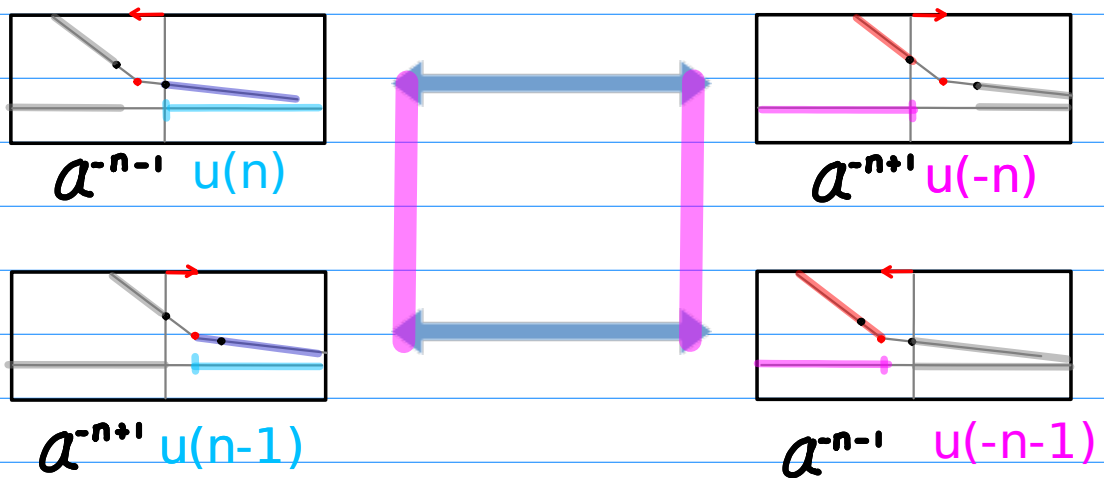
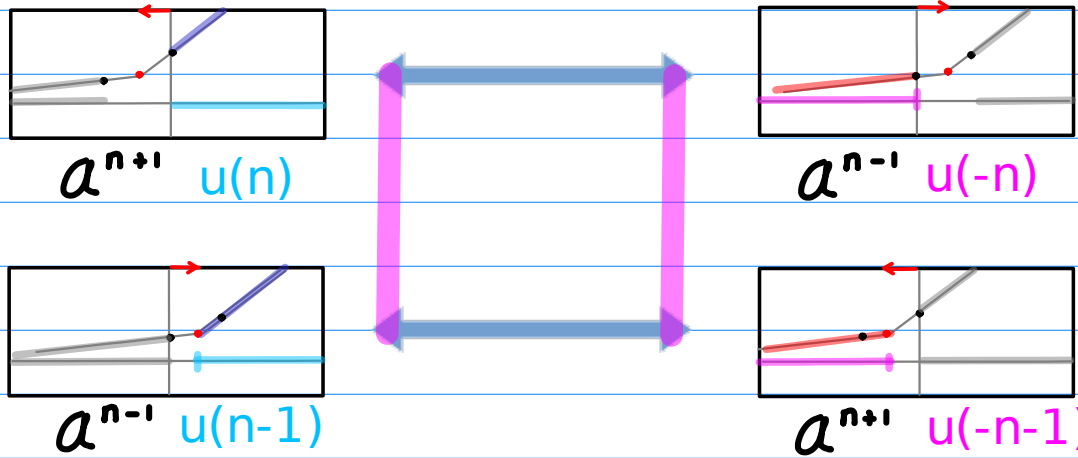

Shifted Range Flipping

Complementary Inverting

$$a^n R(n) \longleftrightarrow a^{sh2(n)} R(-n)$$

$$a^n R(n) \longleftrightarrow a^{-n} \overline{R(n)}$$

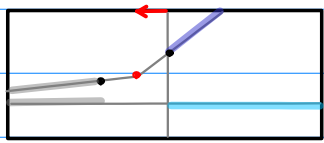

$$a^{n+1} u(n)$$

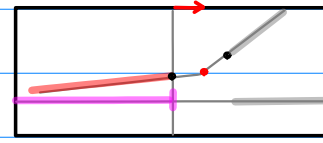

$$a^{n-1} u(-n)$$

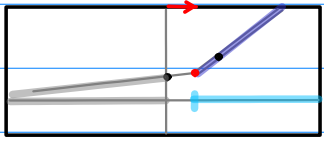

$$a^{n-1} u(n-1)$$

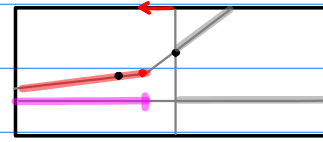

$$a^{n+1} u(-n-1)$$

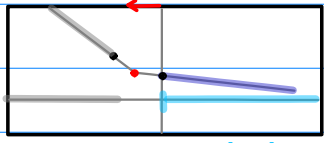

$$a^{-n-1} u(n)$$

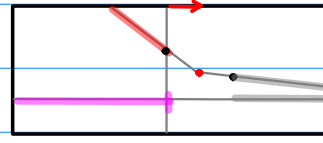

$$a^{-n+1} u(-n)$$

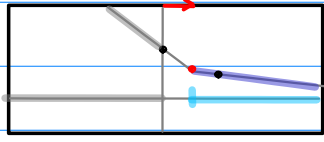

$$a^{-n+1} u(n-1)$$

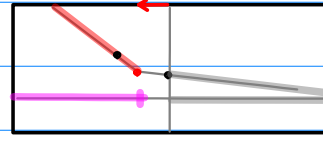

$$a^{-n-1} u(-n-1)$$

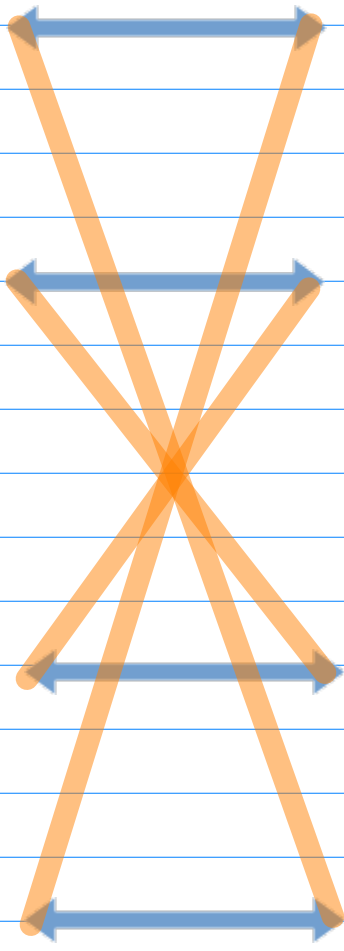

D. Flipping2

$$a^n R(n) \longleftrightarrow a^{-sh2(n)} R(-n)$$

$$a^n \longleftrightarrow a^{-n}$$

$$a^n R(n) \longleftrightarrow a^{sh2(n)} R(-n)$$

n		$sh2(n)$
$n+1$	$n \leftarrow n-2$	$n-1$
$n-1$	$n \leftarrow n+1$	$n+1$
$-(n+1)$	$n \leftarrow n+1$	$-(n-1)$
$-(n-1)$	$n \leftarrow n-1$	$-(n+1)$

$R(n)$	$R(-n)$
$u(n)$	$u(-n)$
$u(n-1)$	$u(-n-1)$
$u(-n)$	$u(n)$
$u(-n-1)$	$u(n-1)$

E. Shifting2

$$a^n R(n) \longleftrightarrow a^{\text{sh}2(n)} \overline{R(-n)}$$

$$a^n R(n) \longleftrightarrow a^{\text{sh}2(n)} R(-n)$$

$$R(n) \longleftrightarrow R(n)$$

F. Complementary Inverting

$$a^n R(n) \longleftrightarrow a^{-n} \overline{R(n)}$$

$$\begin{array}{ccc} a^n & \longleftrightarrow & a^{-n} \\ R(n) & \longleftrightarrow & \overline{R(n)} \end{array}$$

<u>$R(n)$</u>	<u>$\overline{R(n)}$</u>
<u>$u(n)$</u>	<u>$u(-n-1)$</u>
$u(n-1)$	$u(-n)$
$u(-n)$	$u(n)$
<u>$u(-n-1)$</u>	<u>$u(n-1)$</u>

A.1 Flipping Base Inverting Range Flipping

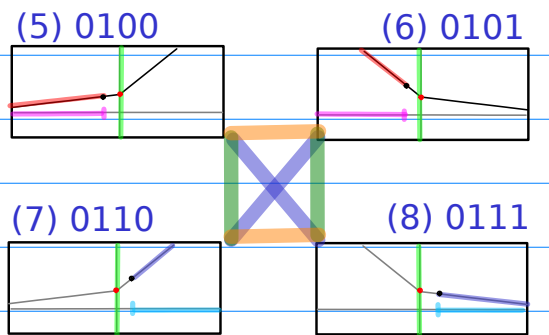
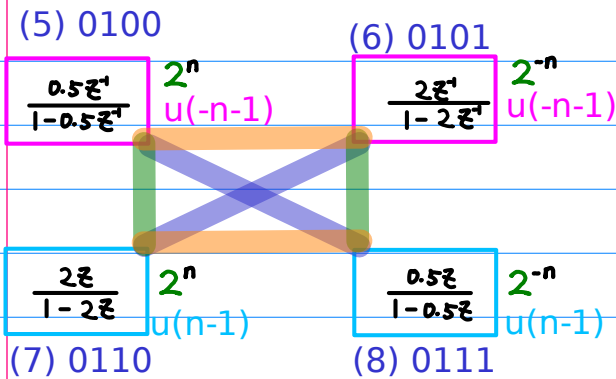
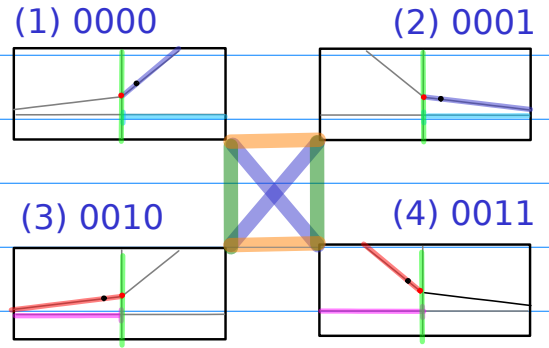
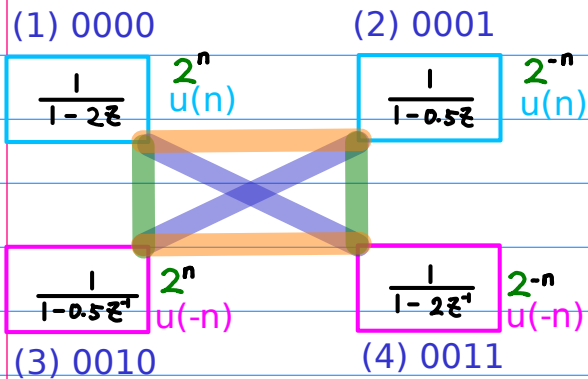

Base Inverting

$$0 \ b_2 \ b_1 \ b_0 \longrightarrow 0 \ b_2 \ b_1 \ b_0$$

$$(1) \ 0 \ 0 \ 0 \ 0 \quad 0 \ 0 \ 0 \ 1 \quad (2)$$

Range Flipping

$$0 \ b_2 \ b_1 \ b_0 \longrightarrow 0 \ b_2 \ \bar{b}_1 \ b_0$$

$$(3) \ 0 \ 0 \ 1 \ 0 \quad 0 \ 0 \ 1 \ 1 \quad (4)$$

Flipping

$$0 \ b_2 \ b_1 \ b_0 \longrightarrow 0 \ b_2 \ \bar{b}_1 \ \bar{b}_0$$

$$(5) \ 0 \ 1 \ 0 \ 0 \quad 0 \ 1 \ 0 \ 1 \quad (6)$$

$$(7) \ 0 \ 1 \ 1 \ 0 \quad 0 \ 1 \ 1 \ 1 \quad (8)$$

$$a^n \longleftrightarrow a^{-n}$$

$$R(n) \longleftrightarrow R(-n)$$

$$a^n R(n) \longleftrightarrow a^{-n} R(-n)$$

B.1 Range Shifting = Range Flipping + Range Complementing

Range Flipping

Range Complementing

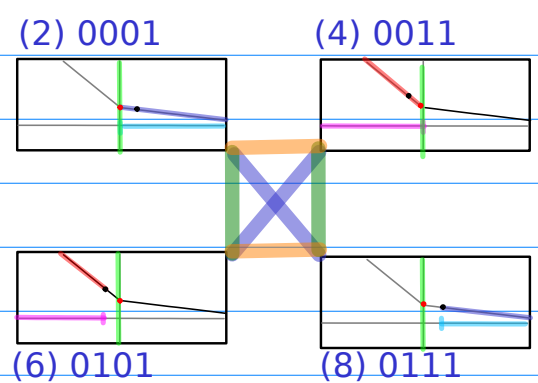
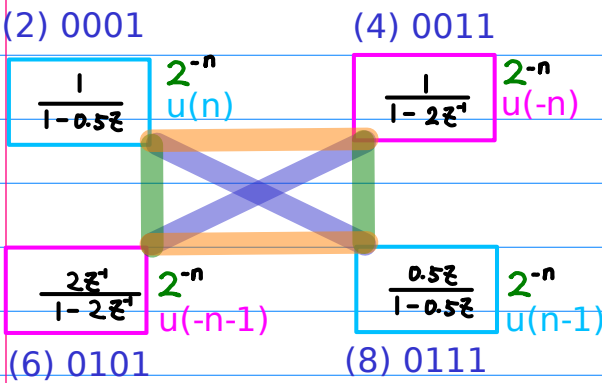
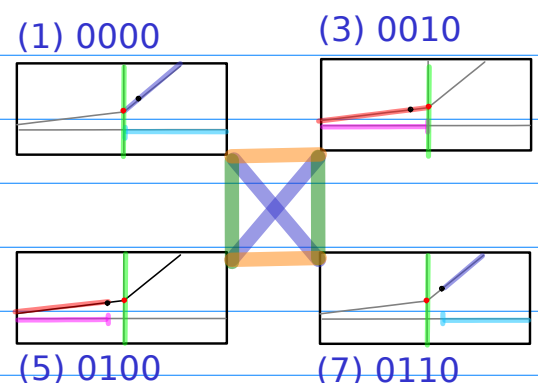
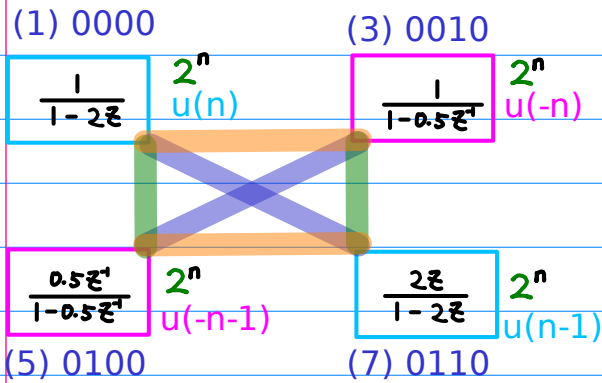

Range Flipping

$$0 \quad b_2 \quad b_1 \quad b_0 \longrightarrow 0 \quad b_2 \quad \bar{b}_1 \quad b_0$$

Range Complementing

$$0 \quad b_2 \quad b_1 \quad b_0 \longrightarrow 0 \quad \bar{b}_2 \quad b_1 \quad b_0$$

Range Shifting

$$0 \quad b_2 \quad b_1 \quad b_0 \longrightarrow 0 \quad \bar{b}_2 \quad \bar{b}_1 \quad b_0$$

$$R(n) \longleftrightarrow R(-n)$$

$$R(n) \longleftrightarrow \overline{R(n)}$$

$$R(n) \longleftrightarrow \overline{R(-n)}$$

$$(1) \quad 0 \quad 0 \quad 0 \quad 0 \quad \quad \quad 0 \quad 0 \quad 1 \quad 0 \quad (3)$$

$$(5) \quad 0 \quad 1 \quad 0 \quad 0 \quad \quad \quad 0 \quad 1 \quad 1 \quad 0 \quad (7)$$

$$(2) \quad 0 \quad 0 \quad 0 \quad 1 \quad \quad \quad 0 \quad 0 \quad 1 \quad 1 \quad (4)$$

$$(6) \quad 0 \quad 1 \quad 0 \quad 1 \quad \quad \quad 0 \quad 1 \quad 1 \quad 1 \quad (8)$$

C.1 Complementary Inverting Base Inverting Range Complementing

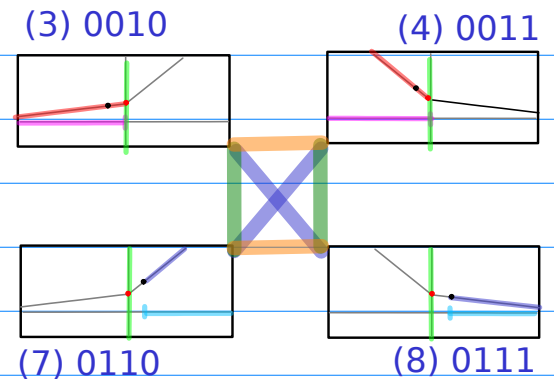
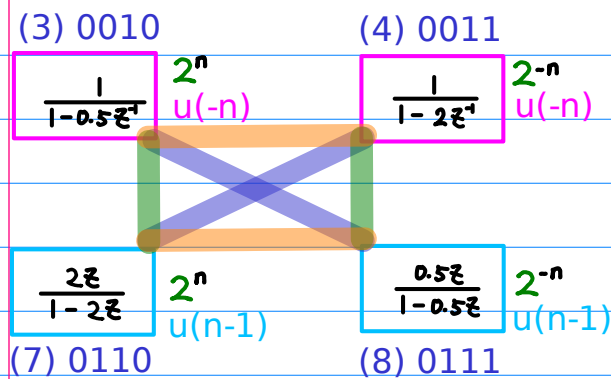
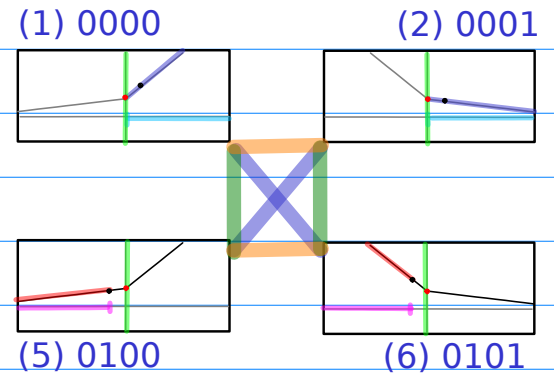
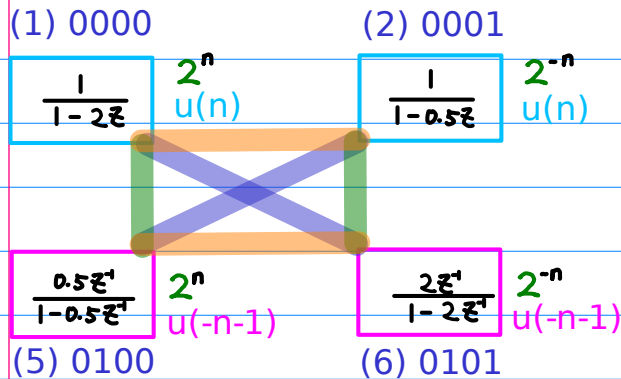

Base Inverting

$$0 \ b_2 \ b_1 \ b_0 \longrightarrow 0 \ b_2 \ b_1 \ \bar{b}_0$$

$$(1) 0 \ 0 \ 0 \ 0 \qquad 0 \ 0 \ 0 \ 1 \ (2)$$

Range Complementing

$$0 \ b_2 \ b_1 \ b_0 \longrightarrow 0 \ \bar{b}_2 \ b_1 \ b_0$$

$$(5) 0 \ 1 \ 0 \ 0 \qquad 0 \ 1 \ 0 \ 1 \ (6)$$

Complementary Flipping

$$0 \ b_2 \ b_1 \ b_0 \longrightarrow 0 \ \bar{b}_2 \ b_1 \ \bar{b}_0$$

$$(3) 0 \ 0 \ 1 \ 0 \qquad 0 \ 0 \ 1 \ 1 \ (4)$$

$$(7) 0 \ 1 \ 1 \ 0 \qquad 0 \ 1 \ 1 \ 1 \ (8)$$

$$a^n \longleftrightarrow a^{-n}$$

$$R(n) \longleftrightarrow \overline{R(n)}$$

$$a^n R(n) \longleftrightarrow a^{-n} \overline{R(n)}$$

D.1 Flipping2

Base Inverting

Shifted Range Flipping = Exponent Shifting2 + Range Flipping

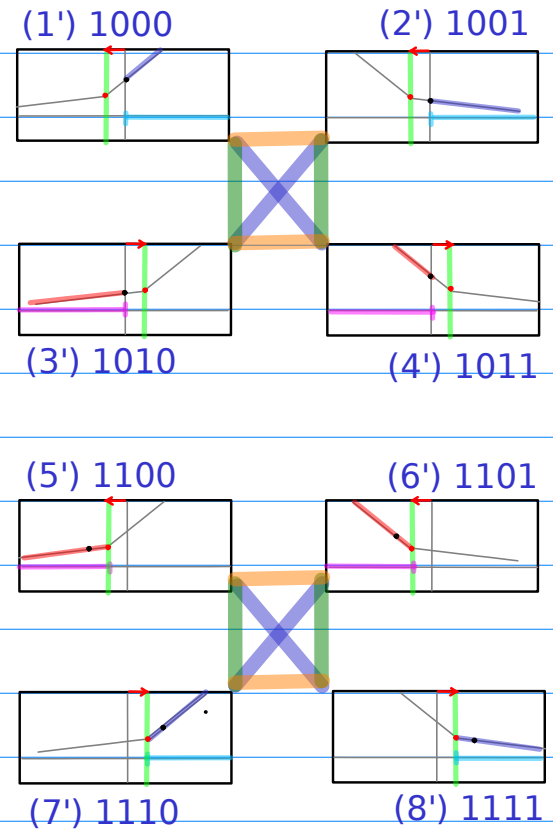
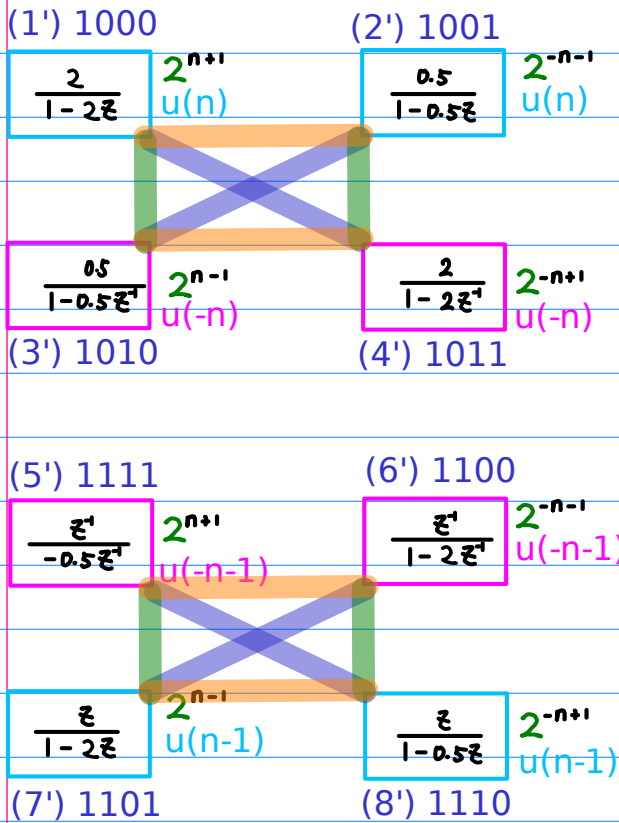

Base Inverting



(1) 1 0 0 0 1 0 0 1 (2)

Shifted Range Flipping



(3) 1 0 1 0 1 0 1 1 (4)

Flipping2



(5) 1 1 0 0 1 1 0 1 (6)

(7) 1 1 1 0 1 1 1 1 (8)

$$a^n \longleftrightarrow a^{-n}$$

$$a^n R(n) \longleftrightarrow a^{sh2(n)} R(-n)$$

$$a^n R(n) \longleftrightarrow a^{-sh2(n)} R(-n)$$

E.1 Shifting2 = Exponent Shifting2 + Range Complementing
Shifted Range Flipping = Exponent Shifting2 + Range Flipping
Range Complementing

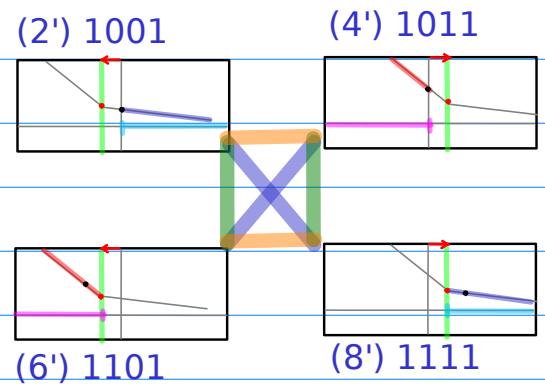
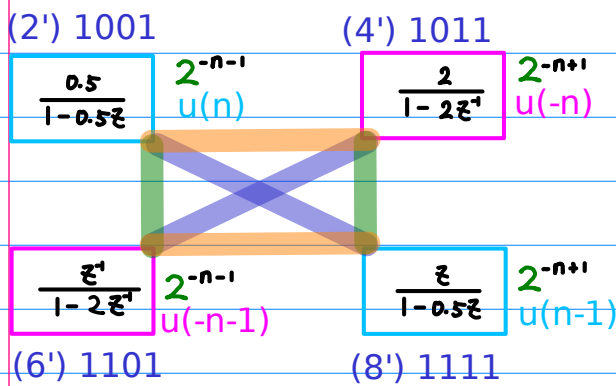
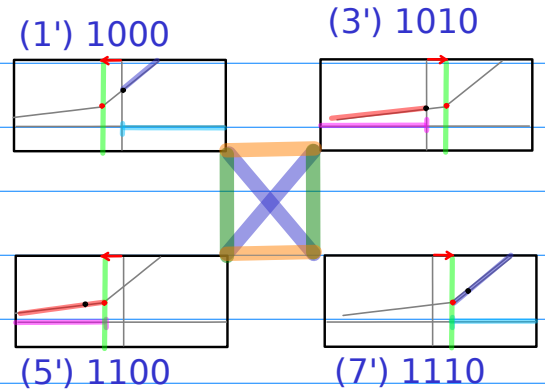
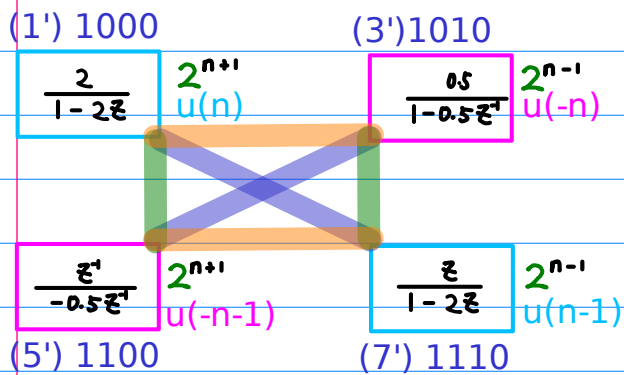

Shifted Range Flipping



Range Complementing



Shifting2



(1) 1 0 0 0 1 0 1 0 (3)

(5) 1 1 0 0 1 1 1 0 (7)

(2) 1 0 0 1 1 0 1 1 (4)

(6) 1 1 0 1 1 1 1 1 (8)

$$a^n R(n) \longleftrightarrow a^{sh2(n)} R(-n)$$

$$R(n) \longleftrightarrow R(n)$$

$$a^n R(n) \longleftrightarrow a^{sh2(n)} \overline{R(-n)}$$

F.1 Complementary Inverting Base Inverting Range Complementing

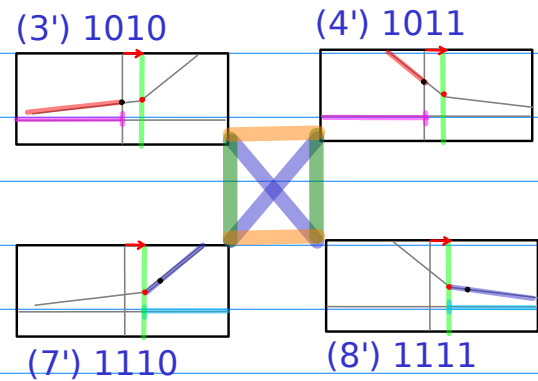
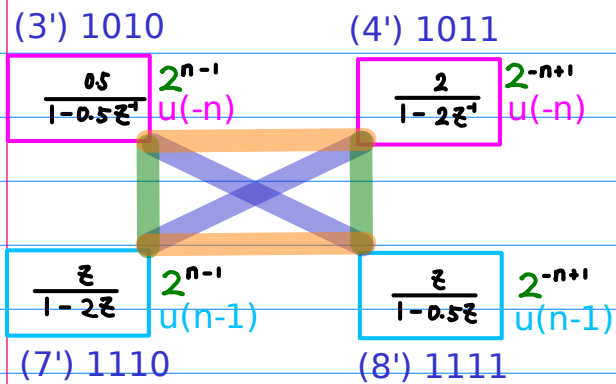
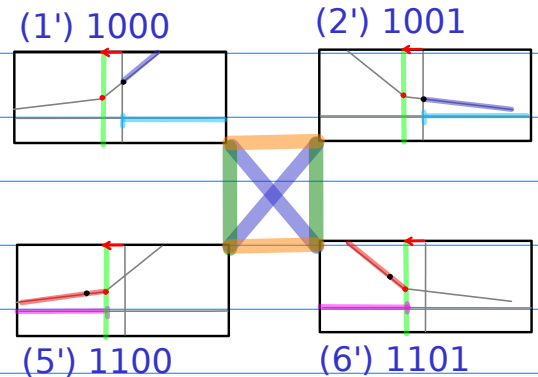
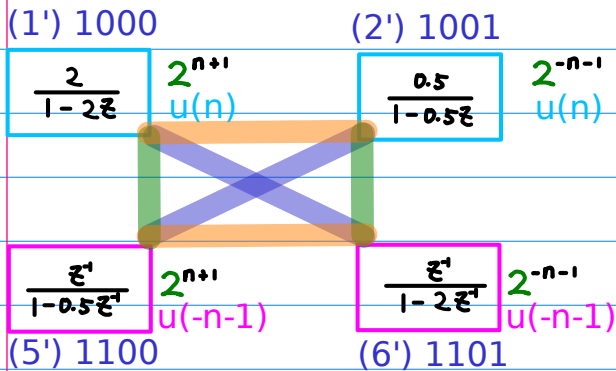

Base Inverting



$$(1) \ 1 \ 0 \ 0 \ 0 \qquad 1 \ 0 \ 0 \ 1 \ (2)$$

Range Complementing



$$(5) \ 1 \ 1 \ 0 \ 0 \qquad 1 \ 1 \ 0 \ 1 \ (6)$$

Complementary Inverting



$$(3) \ 1 \ 0 \ 1 \ 0 \qquad 1 \ 0 \ 1 \ 1 \ (4)$$

$$(7) \ 1 \ 1 \ 1 \ 0 \qquad 1 \ 1 \ 1 \ 1 \ (8)$$

$$a^n \longleftrightarrow a^{-n}$$

$$R(n) \longleftrightarrow \overline{R(n)}$$

$$a^n R(n) \longleftrightarrow a^{-n} \overline{R(n)}$$





A.2b Flipping Base Inverting Range Flipping

$$a^n R(n) \longleftrightarrow a^{-n} R(-n)$$

1) Base Inverting

$$\boxed{0} \boxed{b_2} \boxed{b_1} \boxed{b_0} \longrightarrow \boxed{0} \boxed{b_2} \boxed{b_1} \boxed{\bar{b}_0}$$

2) Range Flipping

$$\boxed{0} \boxed{b_2} \boxed{b_1} \boxed{b_0} \longrightarrow \boxed{0} \boxed{b_2} \boxed{\bar{b}_1} \boxed{b_0}$$

3) Flipping

$$\boxed{0} \boxed{b_2} \boxed{b_1} \boxed{b_0} \longrightarrow \boxed{0} \boxed{b_2} \boxed{\bar{b}_1} \boxed{\bar{b}_0}$$

**B.2a Range Shifting
Range Flipping
Range Complementing**

$$R(n) \longleftrightarrow \overline{R(-n)}$$

1) Range Flipping

$$R(n) \longleftrightarrow R(-n)$$

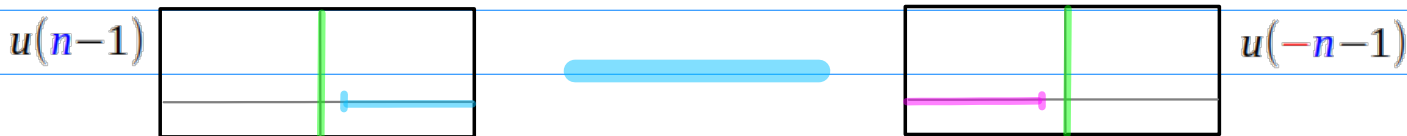
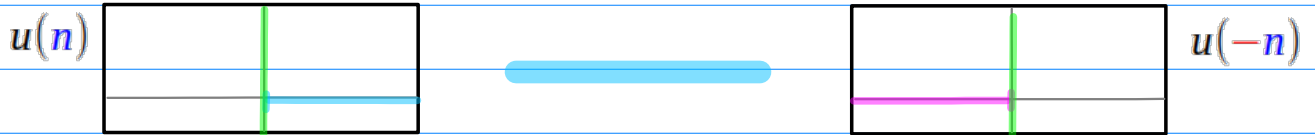

2) Range Complementing

$$R(n) \longleftrightarrow \overline{R(n)}$$



3) Range Shifting

$$R(n) \longleftrightarrow \overline{R(-n)}$$

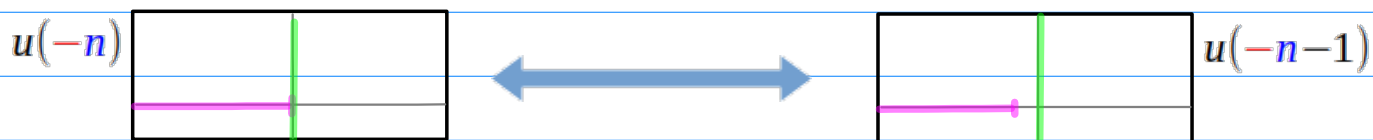
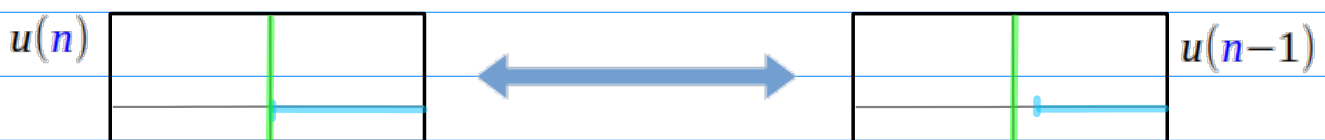

B.2b Range Shifting Range Flipping Range Complementing

$$R(n) \longleftrightarrow \overline{R(-n)}$$

1) Range Flipping

$$\boxed{0} \boxed{b_2} \boxed{b_1} \boxed{b_0} \longrightarrow \boxed{0} \boxed{b_2} \boxed{\overline{b_1}} \boxed{b_0}$$

2) Range Complementing

$$\boxed{0} \boxed{b_2} \boxed{b_1} \boxed{b_0} \longrightarrow \boxed{0} \boxed{\overline{b_2}} \boxed{b_1} \boxed{b_0}$$

3) Range Shifting

$$\boxed{0} \boxed{b_2} \boxed{b_1} \boxed{b_0} \longrightarrow \boxed{0} \boxed{\overline{b_2}} \boxed{\overline{b_1}} \boxed{b_0}$$



C.2a Complementary Inverting Base Inverting Range Complementing

$$a^n R(n) \longleftrightarrow a^{-n} \overline{R(n)}$$

1) Base Inverting

$$0 \ b_2 \ b_1 \ b_0 \longrightarrow 0 \ b_2 \ b_1 \ \overline{b_0}$$

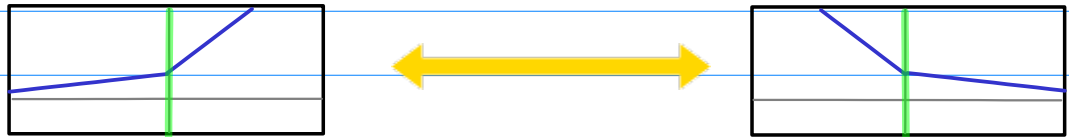

2) Range Complementing

$$0 \ b_2 \ b_1 \ b_0 \longrightarrow 0 \ \overline{b_2} \ b_1 \ b_0$$

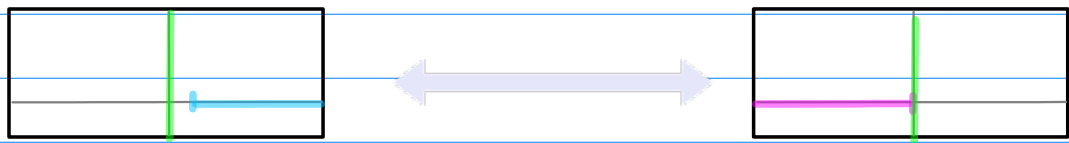
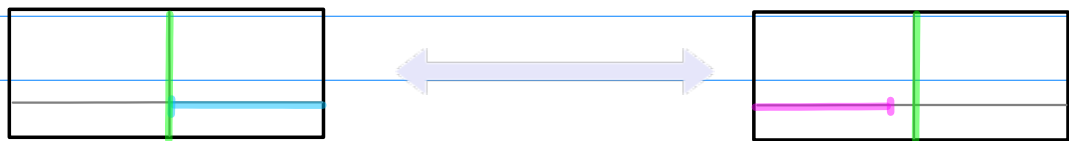

3) Complementary Flipping

$$0 \ b_2 \ b_1 \ b_0 \longrightarrow 0 \ \overline{b_2} \ b_1 \ \overline{b_0}$$

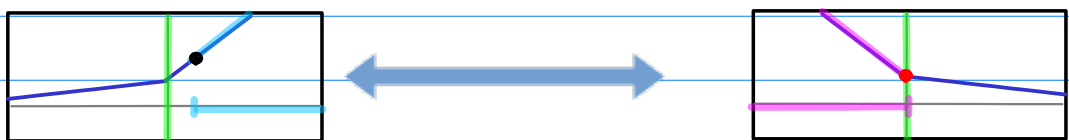
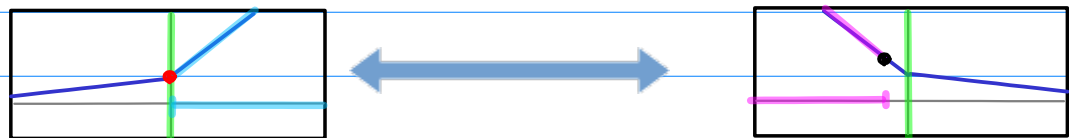

D.2a Flipping2
Base Inverting
Shifted Range Flipping

$$a^n \longleftrightarrow a^{-n}$$

$$a^n R(n) \longleftrightarrow a^{sh(n)} R(-n)$$

1) Base Inverting

$$a^n \longleftrightarrow a^{-n}$$

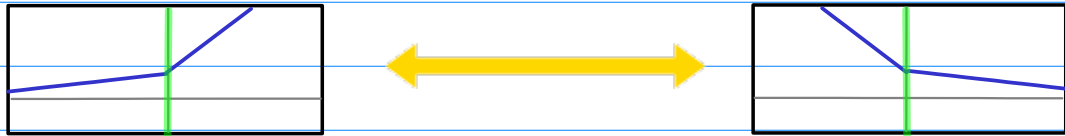

2) Shifted Range Flipping

$$a^n R(n) \longleftrightarrow a^{-sh2(n)} R(-n)$$

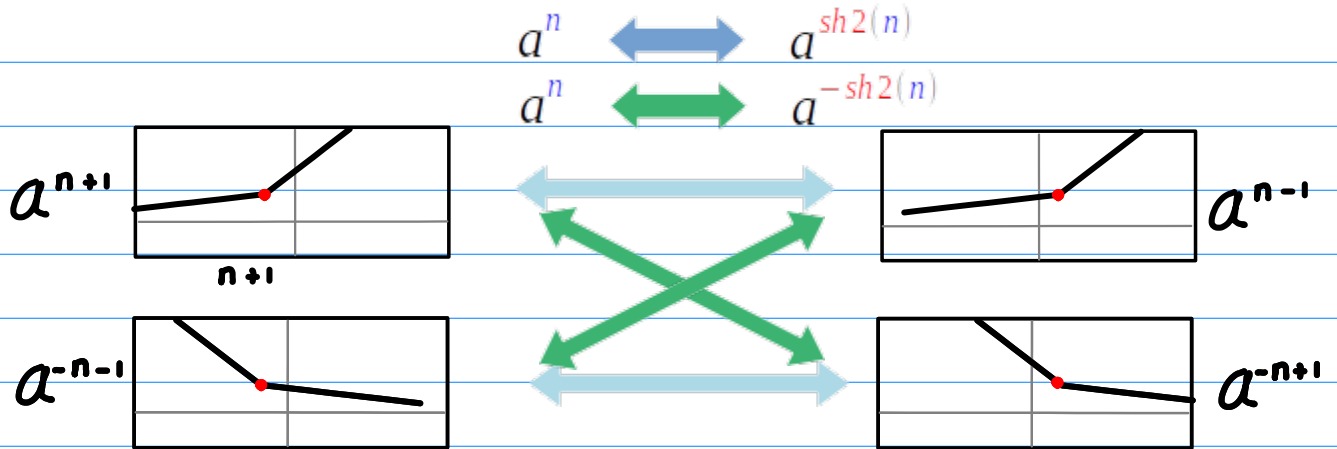

$$R(n) \longleftrightarrow R(-n)$$

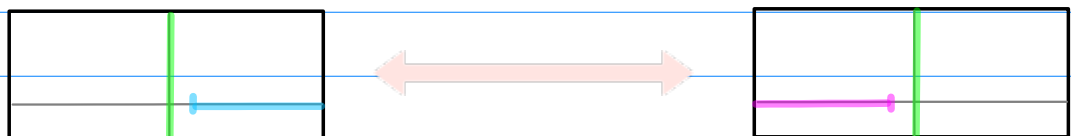
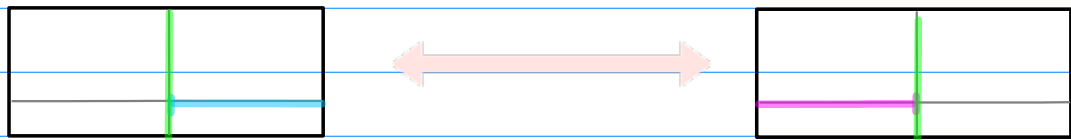

2) Shifted Range Flipping $a^n R(n) \longleftrightarrow a^{sh2(n)} R(-n)$

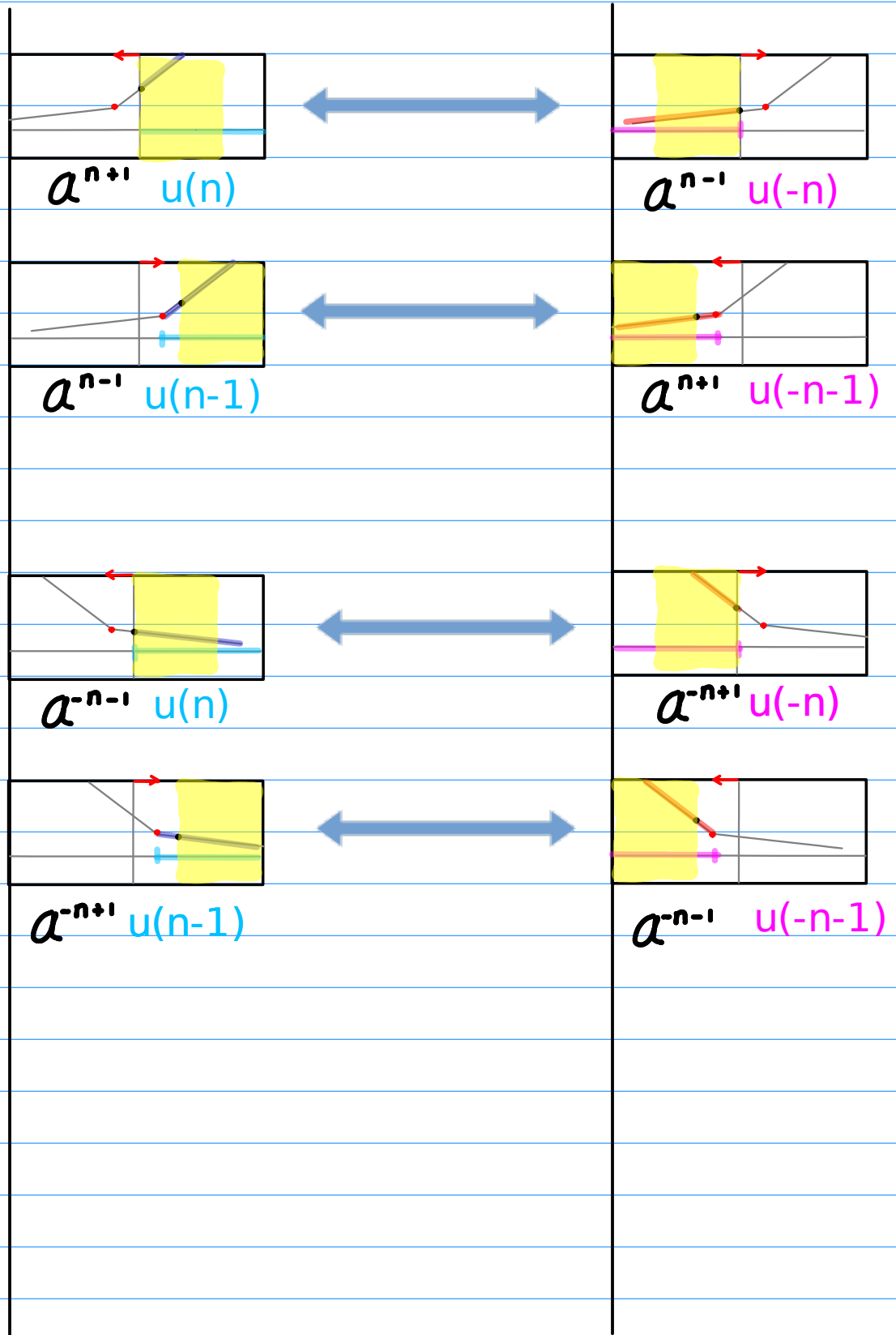

3) Flipping2

$$a^n R(n) \xleftrightarrow{a^{sh(n)}} a^{-sh2(n)} R(-n)$$

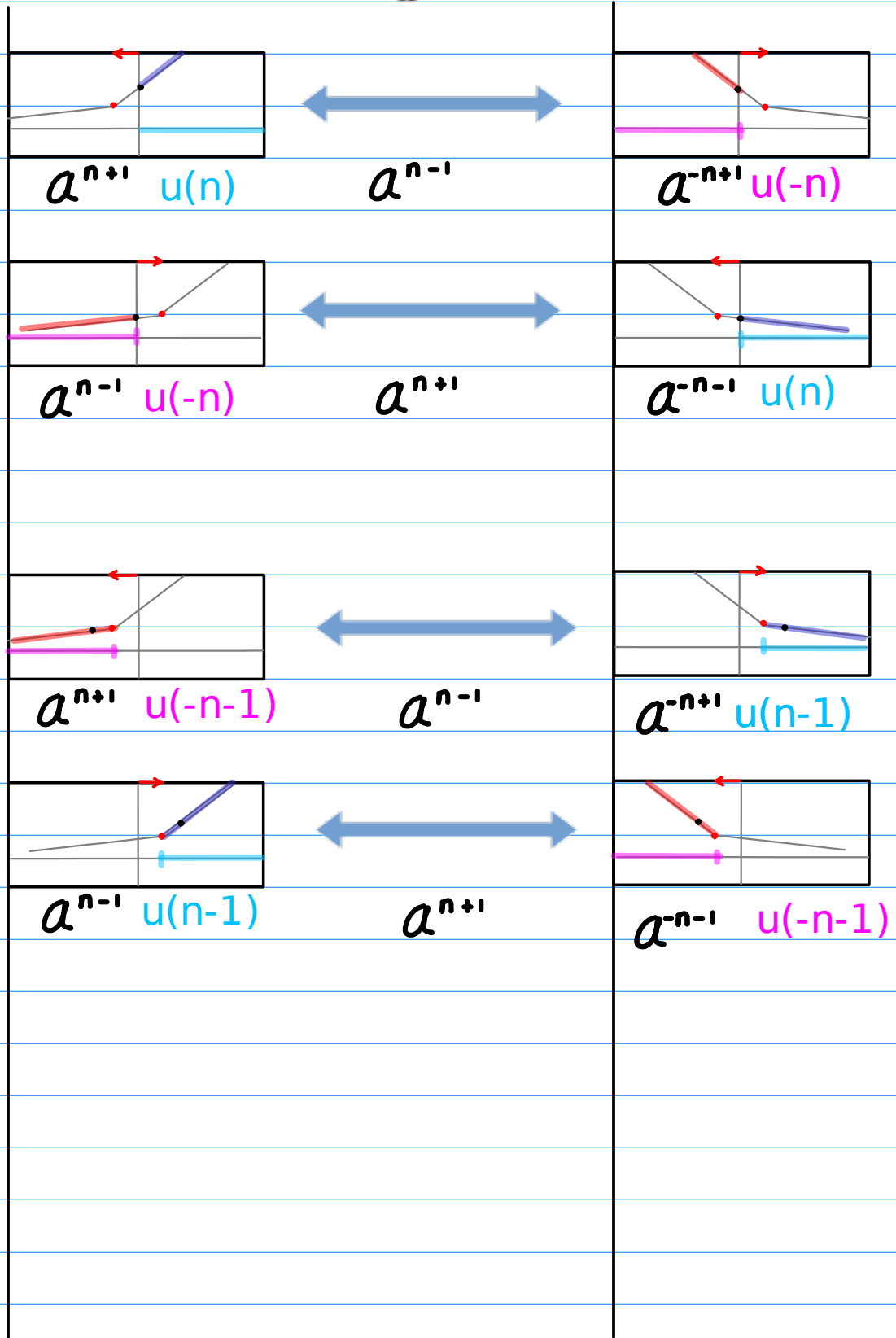



D. Flipping2

Base Inverting

Shifted Range Flipping = Exponent Shifting2 + Range Flipping

(1') 1000

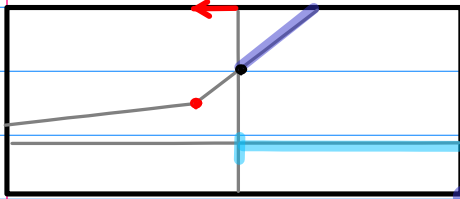

2^{n+1}
 $u(n)$

(2') 1001

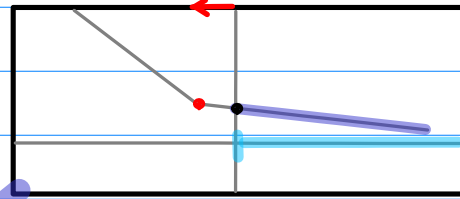

2^{-n-1}
 $u(n)$

(3') 1010

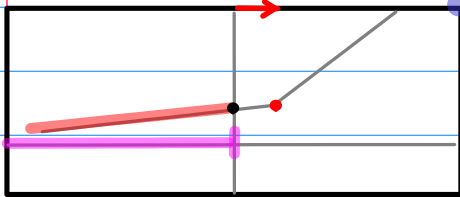

2^{n-1}
 $u(-n)$

(4') 1011

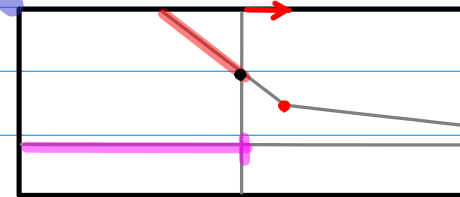

2^{-n+1}
 $u(-n)$

(5') 1111

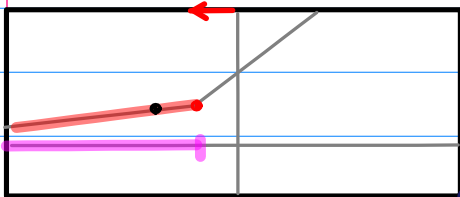

2^{n+1}
 $u(-n-1)$

(6') 1100

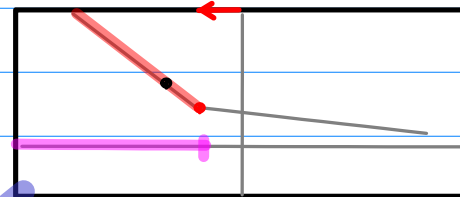

2^{-n-1}
 $u(-n-1)$

(7') 1101

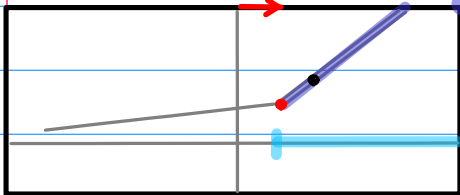

2^{n-1}
 $u(n-1)$

(8') 1110

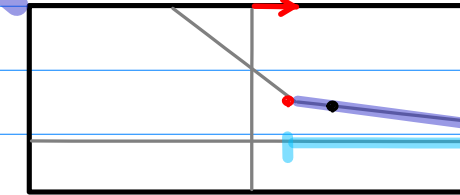

2^{-n+1}
 $u(n-1)$

D. Flipping2

Base Inverting

Shifted Range Flipping = Exponent Shifting2 + Range Flipping

1) Exponent Flipping = (Base Inverting, Exponent Shifting)

$$2^{n+1} \longleftrightarrow 2^{-(n-1)}$$

$$2^{n-1} \longleftrightarrow 2^{-(n+1)}$$

2) Range Flipping

$$u(n) \longleftrightarrow u(-n)$$

$$u(n-1) \longleftrightarrow u(-n-1)$$

3) Exponent Flipping + Range Flipping

$$\begin{array}{|c|} \hline 2^{n+1} \\ \hline u(n) \\ \hline \end{array} \longleftrightarrow \begin{array}{|c|} \hline 2^{-(n-1)} \\ \hline u(-n) \\ \hline \end{array} \quad \begin{array}{|c|} \hline 2^{n+1} \\ \hline u(-n-1) \\ \hline \end{array} \longleftrightarrow \begin{array}{|c|} \hline 2^{-(n-1)} \\ \hline u(n-1) \\ \hline \end{array}$$

$$\begin{array}{|c|} \hline 2^{n-1} \\ \hline u(-n) \\ \hline \end{array} \longleftrightarrow \begin{array}{|c|} \hline 2^{-(n+1)} \\ \hline u(n) \\ \hline \end{array} \quad \begin{array}{|c|} \hline 2^{n-1} \\ \hline u(n-1) \\ \hline \end{array} \longleftrightarrow \begin{array}{|c|} \hline 2^{-(n+1)} \\ \hline u(-n-1) \\ \hline \end{array}$$

E. Shifting2 = Exponent Shifting2 + Range Shifting
Shifted Range Flipping = Exponent Shifting2 + Range Flipping
Range Complementing

(1') 1000

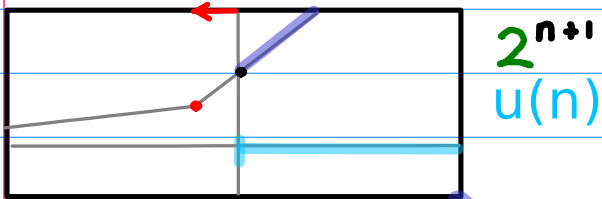

(3') 1010

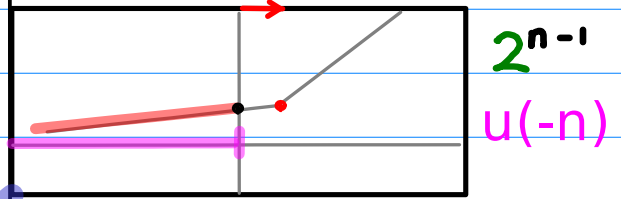

(5') 1111

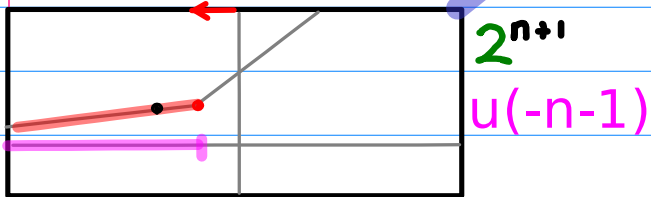

(7') 1101

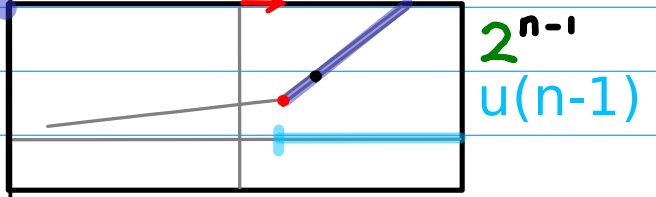

(2') 1001

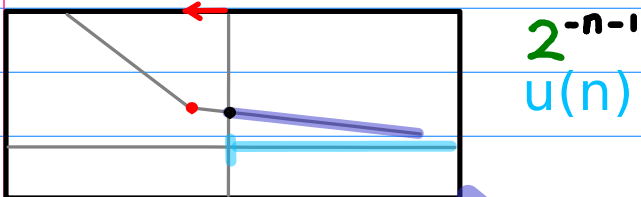

(4') 1011

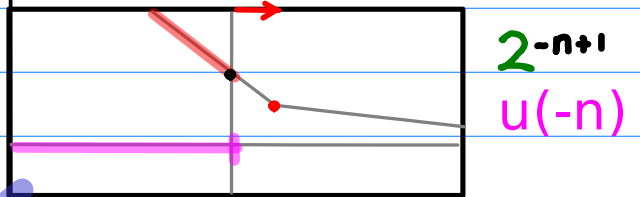

(6') 1100

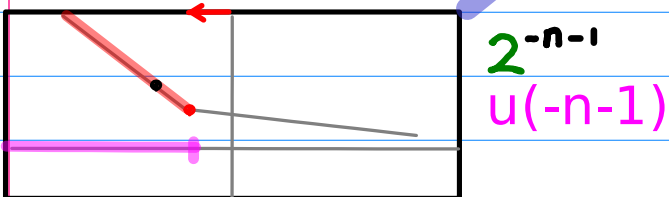

(8') 1110

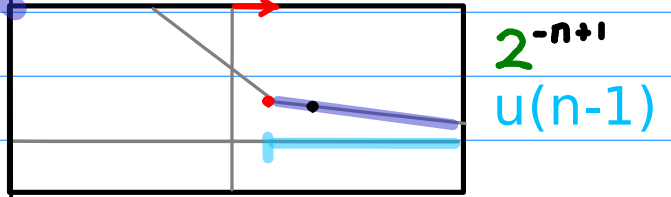

E. Shifting2 = Exponent Shifting2 + Range Shifting
Shifted Range Flipping = Exponent Shifting2 + Range Flipping
Range Complementing

1) Exponent Shifting = (Exponent Shifting, ID)

$$2^{n+1} \longleftrightarrow 2^{n-1}$$

$$2^{-(n+1)} \longleftrightarrow 2^{-(n-1)}$$

2) Range Shifting

$$u(n) \longleftrightarrow u(n-1)$$

$$u(-n-1) \longleftrightarrow u(-n)$$

3) Shifting

$$\begin{array}{|c|} \hline 2^{n+1} \\ \hline u(n) \\ \hline \end{array} \longleftrightarrow \begin{array}{|c|} \hline 2^{n-1} \\ \hline u(n-1) \\ \hline \end{array} \quad \begin{array}{|c|} \hline 2^{-(n+1)} \\ \hline u(n) \\ \hline \end{array} \longleftrightarrow \begin{array}{|c|} \hline 2^{-(n-1)} \\ \hline u(n-1) \\ \hline \end{array}$$

$$\begin{array}{|c|} \hline 2^{n-1} \\ \hline u(-n) \\ \hline \end{array} \longleftrightarrow \begin{array}{|c|} \hline 2^{n+1} \\ \hline u(-n-1) \\ \hline \end{array} \quad \begin{array}{|c|} \hline 2^{-(n-1)} \\ \hline u(-n) \\ \hline \end{array} \longleftrightarrow \begin{array}{|c|} \hline 2^{-(n+1)} \\ \hline u(-n-1) \\ \hline \end{array}$$

F. Complementary Inverting Base Inverting Range Complementing

(1') 1000

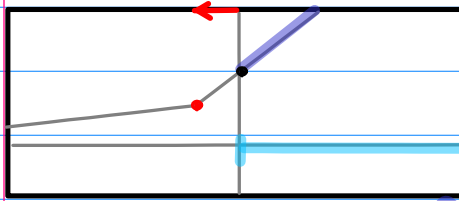

2^{n+1}
 $u(n)$

(2') 1001

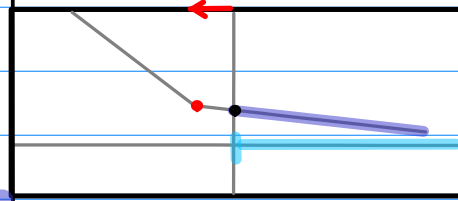

2^{-n-1}
 $u(n)$

(5') 1111

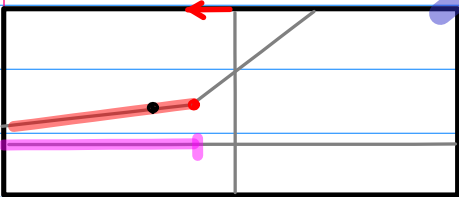

2^{n+1}
 $u(-n-1)$

(6') 1100

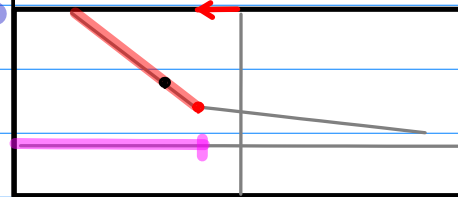

2^{-n-1}
 $u(-n-1)$

(3') 1010

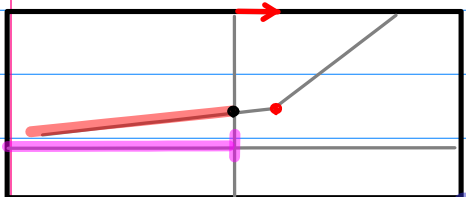

2^{n-1}
 $u(-n)$

(4') 1011

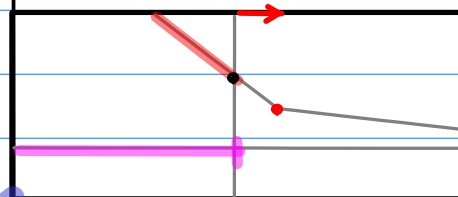

2^{-n+1}
 $u(-n)$

(7') 1101

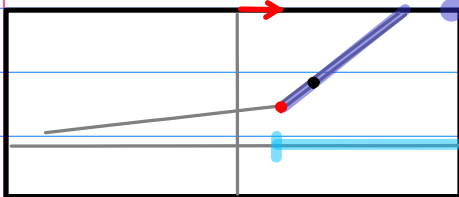

2^{n-1}
 $u(n-1)$

(8') 1110

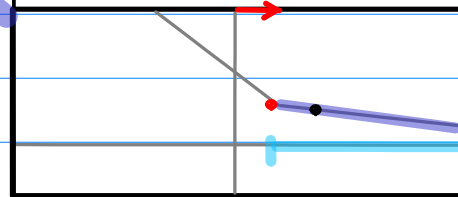

2^{-n+1}
 $u(n-1)$

F. Complementary Inverting Base Inverting Range Complementing

1) Base Inverting = (Base Inverting, ID)

$$2^{n+1} \longleftrightarrow 2^{-(n+1)}$$

$$2^{n-1} \longleftrightarrow 2^{-(n-1)}$$

2) Range Complementing

$$u(n) \longleftrightarrow u(-n-1)$$

$$u(n-1) \longleftrightarrow u(-n)$$

3) Complementary Inverting

$$\begin{array}{|c|} \hline 2^{n+1} \\ \hline u(n) \\ \hline \end{array} \longleftrightarrow \begin{array}{|c|} \hline 2^{-(n+1)} \\ \hline u(-n-1) \\ \hline \end{array} \quad \begin{array}{|c|} \hline 2^{n-1} \\ \hline u(-n) \\ \hline \end{array} \longleftrightarrow \begin{array}{|c|} \hline 2^{-(n-1)} \\ \hline u(n-1) \\ \hline \end{array}$$

$$\begin{array}{|c|} \hline 2^{-(n+1)} \\ \hline u(n) \\ \hline \end{array} \longleftrightarrow \begin{array}{|c|} \hline 2^{n+1} \\ \hline u(-n-1) \\ \hline \end{array} \quad \begin{array}{|c|} \hline 2^{-(n-1)} \\ \hline u(-n) \\ \hline \end{array} \longleftrightarrow \begin{array}{|c|} \hline 2^{n-1} \\ \hline u(n-1) \\ \hline \end{array}$$



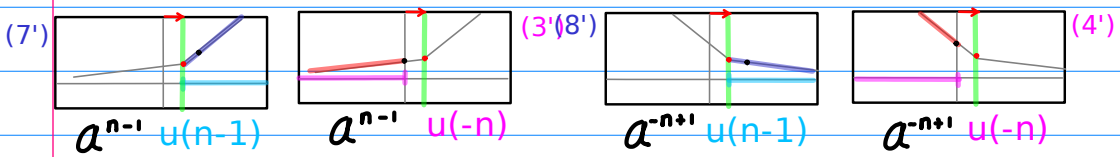
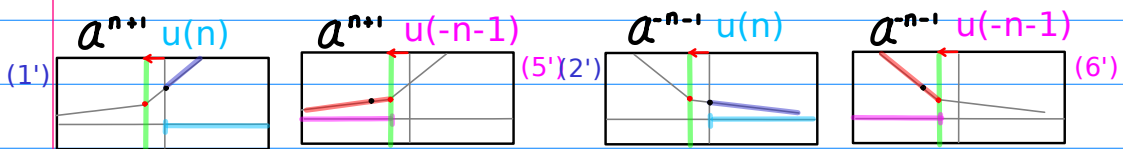
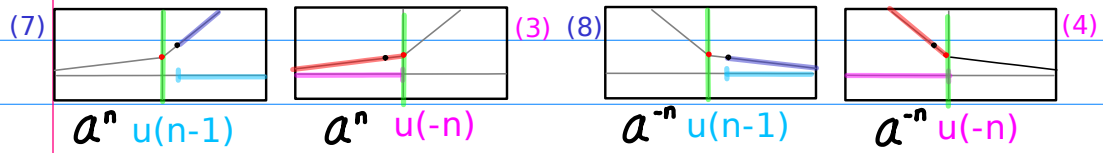
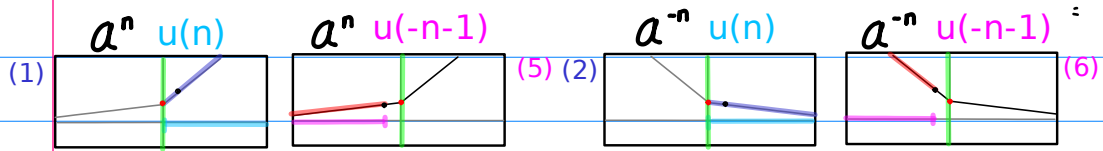

(1) 0000

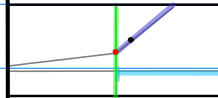

$$a^n u(n)$$

$$a^n u(-n-1)$$

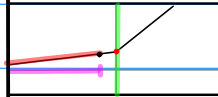

(5) 0100

(2) 0001

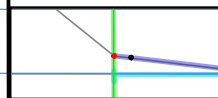

$$a^{-n} u(n)$$

$$a^{-n} u(-n-1)$$

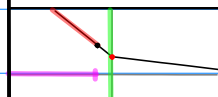

(6) 0101

(3) 0010

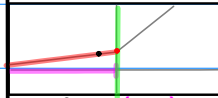

$$a^n u(-n)$$

$$a^n u(n-1)$$

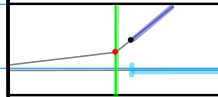

(7) 0110

(4) 0011

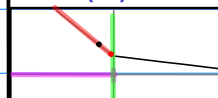

$$a^{-n} u(-n)$$

$$a^{-n} u(n-1)$$

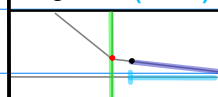

(8) 0111

(1') 1000

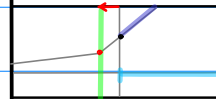

$$a^{n+1} u(n)$$

$$a^{n+1} u(-n-1)$$

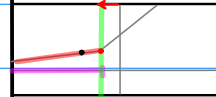

(5') 1100

(2') 1001

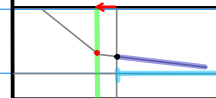

$$a^{-n-1} u(n)$$

$$a^{-n-1} u(-n-1)$$

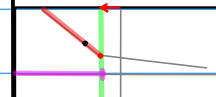

(6') 1101

(3') 1010

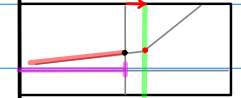

$$a^{n-1} u(-n)$$

$$a^{n-1} u(n-1)$$

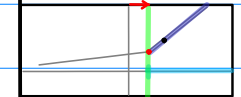

(7') 1110

(4') 1011

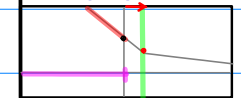

$$a^{-n+1} u(-n)$$

$$a^{-n+1} u(n-1)$$

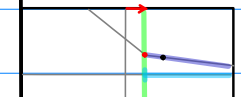

(8') 1111



