

Laurent Series and z-Transform

- Geometric Series

Double Pole Examples A

20220701 Fri

Copyright (c) 2022 - 2016 Young W. Lim.

Permission is granted to copy, distribute and/or modify this document under the terms of the GNU Free Documentation License, Version 1.2 or any later version published by the Free Software Foundation; with no Invariant Sections, no Front-Cover Texts, and no Back-Cover Texts. A copy of the license is included in the section entitled "GNU Free Documentation License".

Common ratios in geometric series

Assume $a \geq 1$

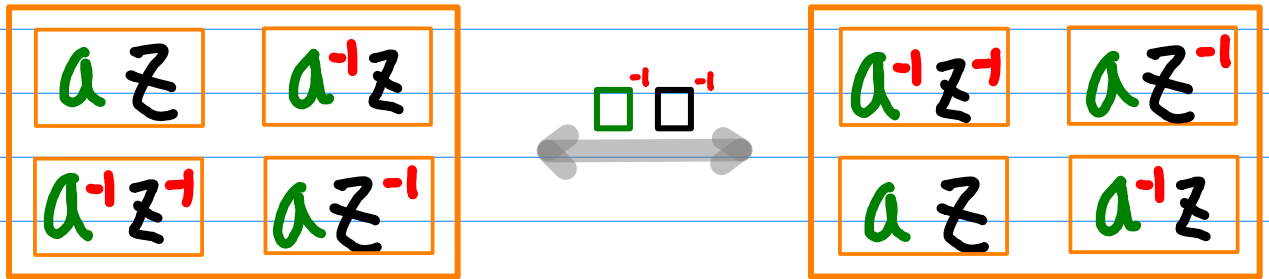

considered geometric series forms

unit starting

$$\frac{1}{1 - \text{C.R.}}$$

C.R. starting

$$\frac{\text{C.R.}}{1 - \text{C.R.}}$$

Representing geometric series

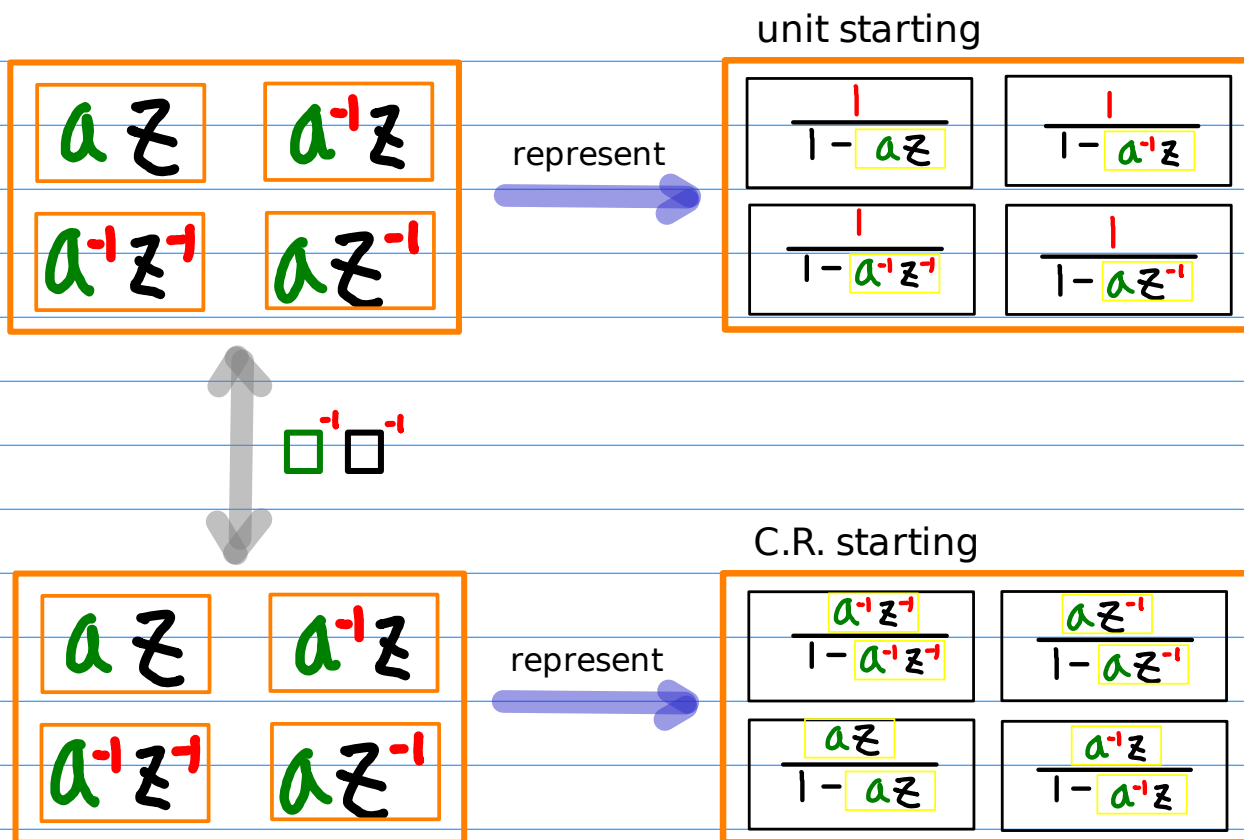

Numbering combinations

$\frac{1}{1 - \text{C.R.}}$	(1)	az	$\frac{1}{1 - az}$	$\frac{1}{1 - a^{-1}z}$	$a^{-1}z$	(2)
	(3)	$a^{-1}z^{-1}$	$\frac{1}{1 - a^{-1}z^{-1}}$	$\frac{1}{1 - az^{-1}}$	az^{-1}	(4)
$\frac{\text{C.R.}}{1 - \text{C.R.}}$	(5)	$a^{-1}z^{-1}$	$\frac{a^{-1}z^{-1}}{1 - a^{-1}z^{-1}}$	$\frac{az^{-1}}{1 - az^{-1}}$	az^{-1}	(6)
	(7)	az	$\frac{az}{1 - az}$	$\frac{a^{-1}z}{1 - a^{-1}z}$	$a^{-1}z$	(8)

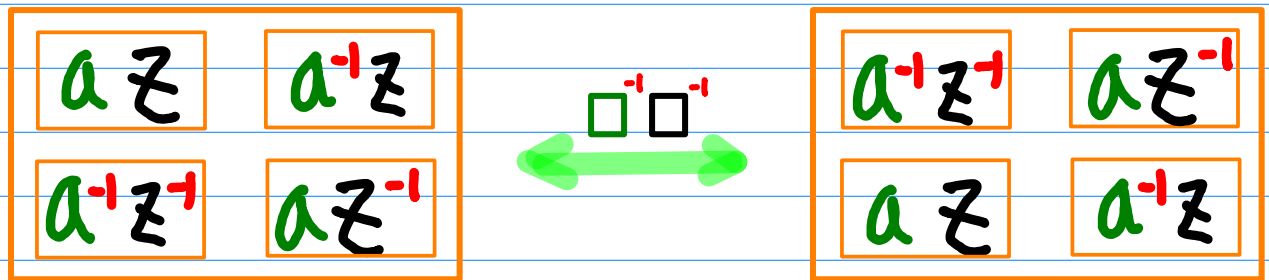

unit starting

(1), (2)
(3), (4)

C.R. starting

(5), (6)
(7), (8)



Decoding Geometric Series

Positive Exponent

$$az, a^{-1}z^{-1} \rightarrow a^n$$

even number of -1 exponent

Negative Exponent

$$a^{-1}z, az^{-1} \rightarrow a^{-n}$$

odd number of -1 exponent

Causal

$$\square z \rightarrow u(n), u(n-1)$$

$$\frac{1}{1 - \square z} \rightarrow u(n)$$

$$\frac{\square z}{1 - \square z} \rightarrow u(n-1)$$

Anti-causal

$$\square z^{-1} \rightarrow u(-n), u(-n-1)$$

$$\frac{1}{1 - \square z^{-1}} \rightarrow u(-n)$$

$$\frac{\square z^{-1}}{1 - \square z^{-1}} \rightarrow u(-n-1)$$

Decoding examples

Positive Exponent

Negative Exponent

(1) o-including

$$\frac{1}{1 - az} \quad |z| < a^{-1}$$

$$az \Rightarrow a^n$$

$$1, az \Rightarrow u(n)$$

(2) o-including

$$\frac{1}{1 - a^{-1}z} \quad |z| < a$$

$$a^{-1}z \Rightarrow a^{-n}$$

$$1, a^{-1}z \Rightarrow u(n)$$

(3) o-including

$$\frac{1}{1 - a^{-1}z^{-1}} \quad |z| > a^{-1}$$

$$a^{-1}z^{-1} \Rightarrow a^n$$

$$1, a^{-1}z^{-1} \Rightarrow u(-n)$$

(4) o-including

$$\frac{1}{1 - az^{-1}} \quad |z| > a$$

$$az^{-1} \Rightarrow a^{-n}$$

$$1, az^{-1} \Rightarrow u(-n)$$

(5) o-excluding

$$\frac{a^{-1}z^{-1}}{1 - a^{-1}z^{-1}} \quad |z| > a^{-1}$$

$$a^{-1}z^{-1} \Rightarrow a^n$$

$$a^{-1}z^{-1}, a^{-1}z^{-1} \Rightarrow u(-n-1)$$

(6) o-excluding

$$\frac{az^{-1}}{1 - az^{-1}} \quad |z| > a$$

$$az^{-1} \Rightarrow a^{-n}$$

$$az^{-1}, az^{-1} \Rightarrow u(-n-1)$$

(7) o-excluding

$$\frac{az}{1 - az} \quad |z| < a^{-1}$$

$$az \Rightarrow a^n$$

$$az, az \Rightarrow u(n-1)$$

(8) o-excluding

$$\frac{a^{-1}z}{1 - a^{-1}z} \quad |z| < a$$

$$a^{-1}z \Rightarrow a^{-n}$$

$$a^{-1}z, a^{-1}z \Rightarrow u(n-1)$$

Inverse power, Symmetric range relations

origin including geometric sequences

$$\frac{1}{1 - \square}$$

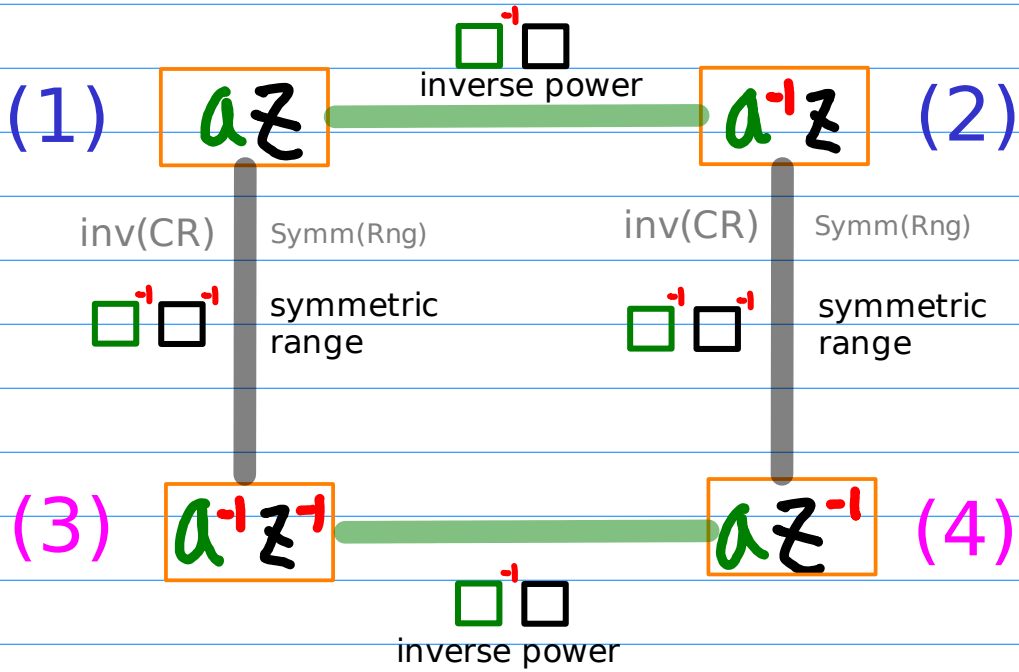

origin excluding geometric sequences

$$\frac{\square}{1 - \square}$$

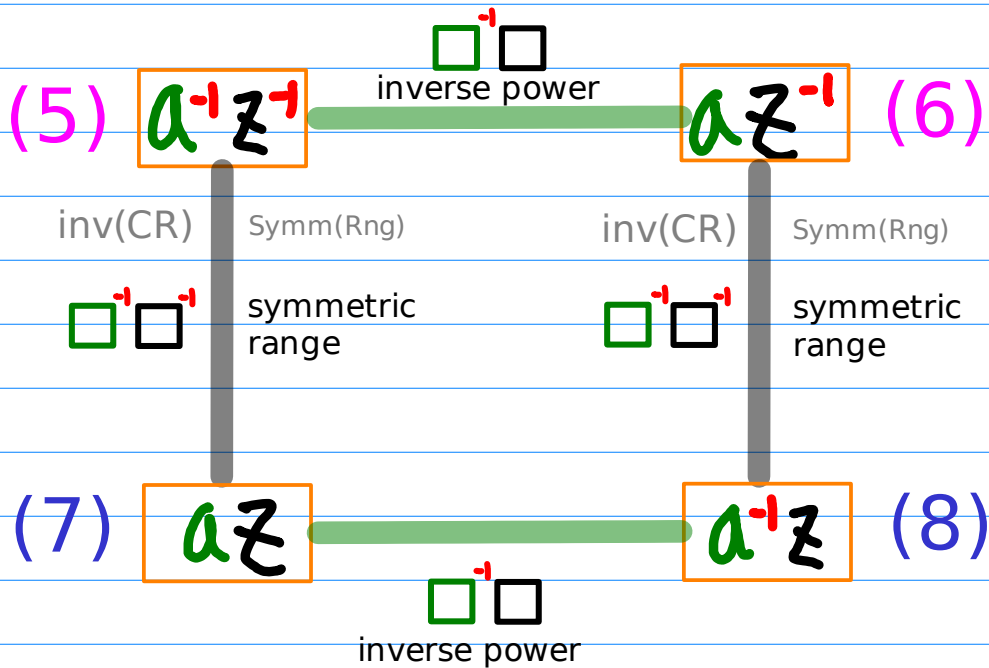

Complementary range relations

origin including geometric sequences

$$\frac{1}{1 - \square}$$

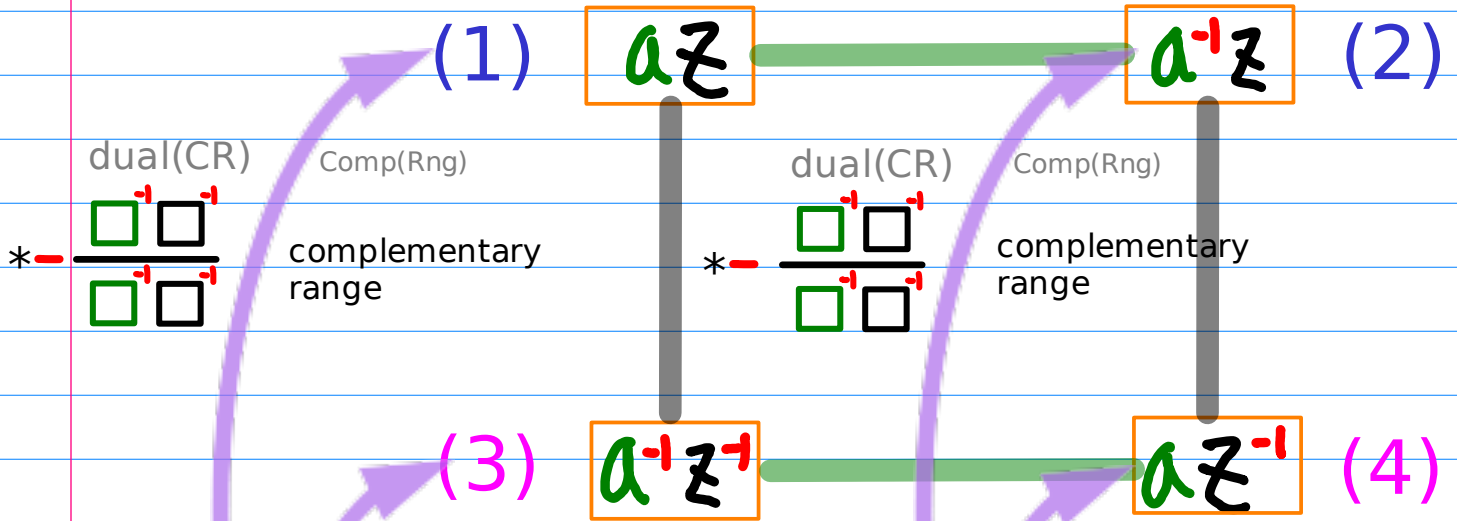

origin excluding geometric sequences

$$\frac{\square}{1 - \square}$$

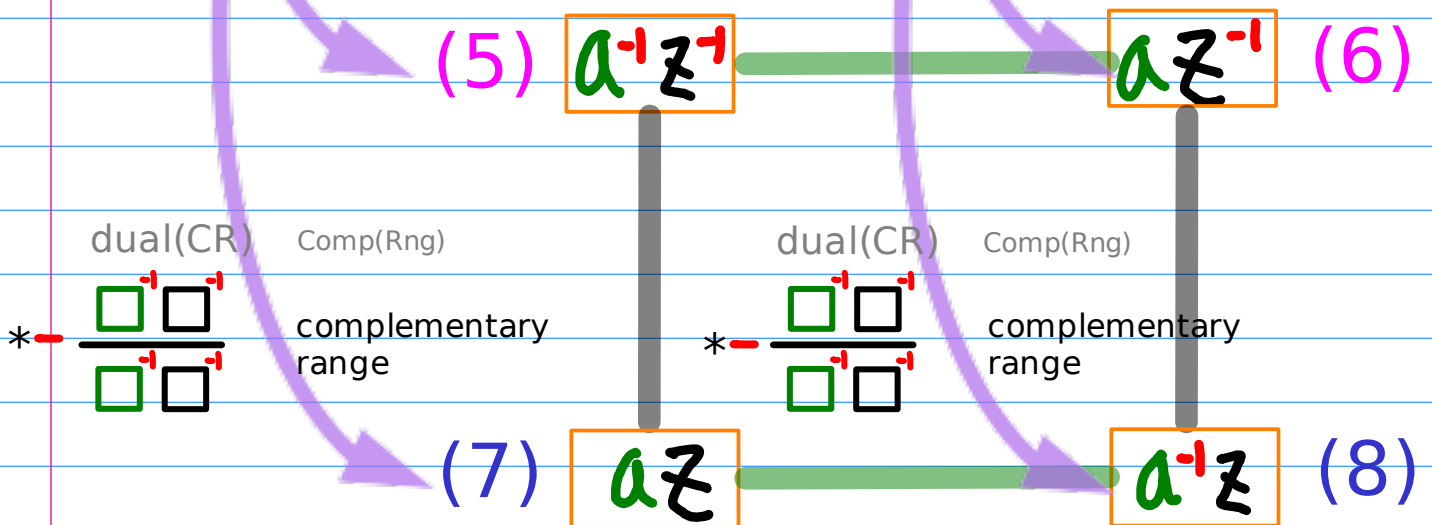

Shifting relations (a)

- (1)
- (7)
- (5)
- (3)
- (2)
- (8)
- (6)
- (4)

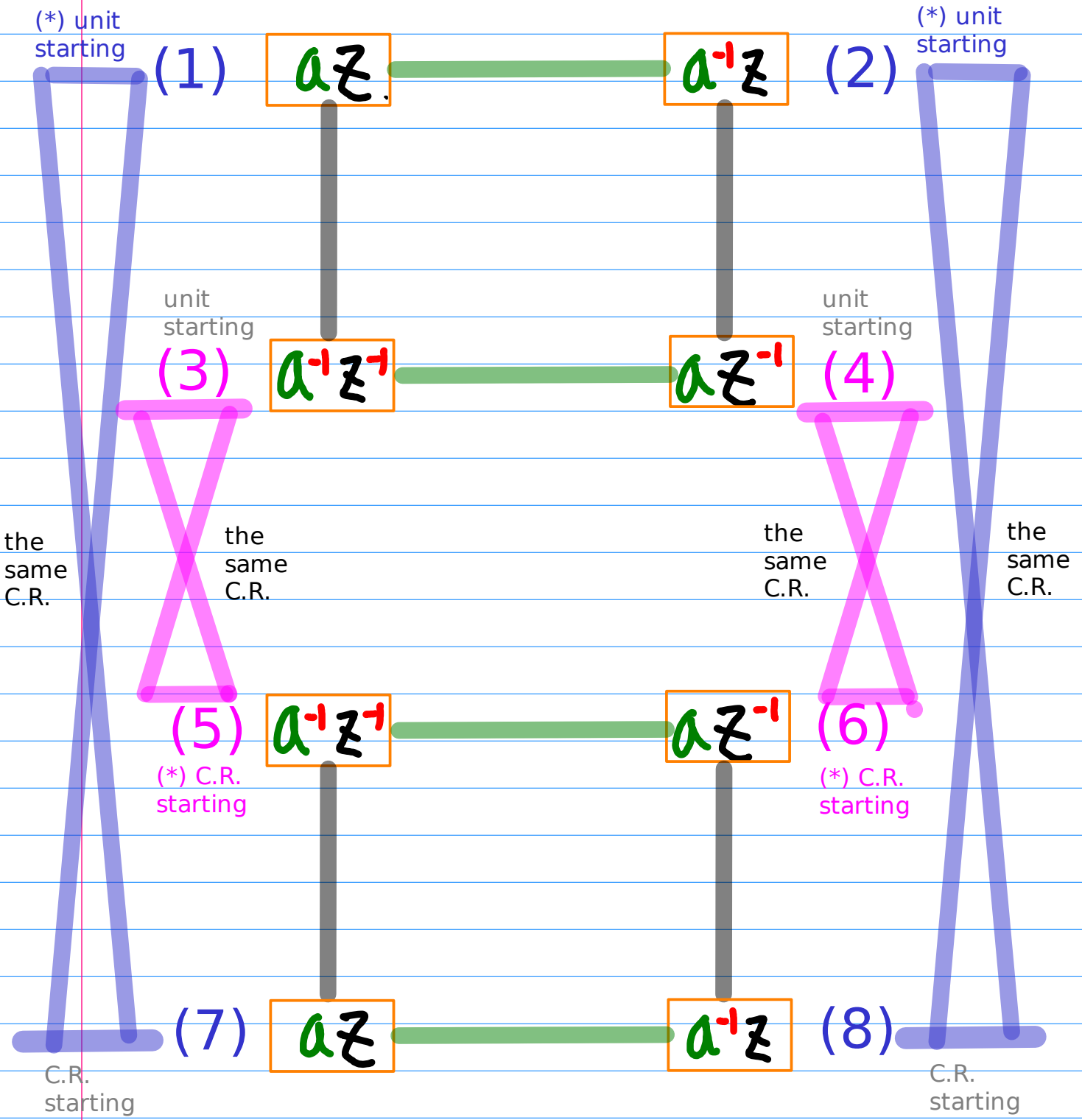

Shifting relations (b)

(exponent, range)

$\begin{cases} \text{SL} \\ \text{SR} \end{cases}$
 $\begin{cases} \text{SL} \\ \text{SR} \\ \text{id} \end{cases}$

(1) (2)
 (7) (8)
 (5) (6)
 (3) (4)

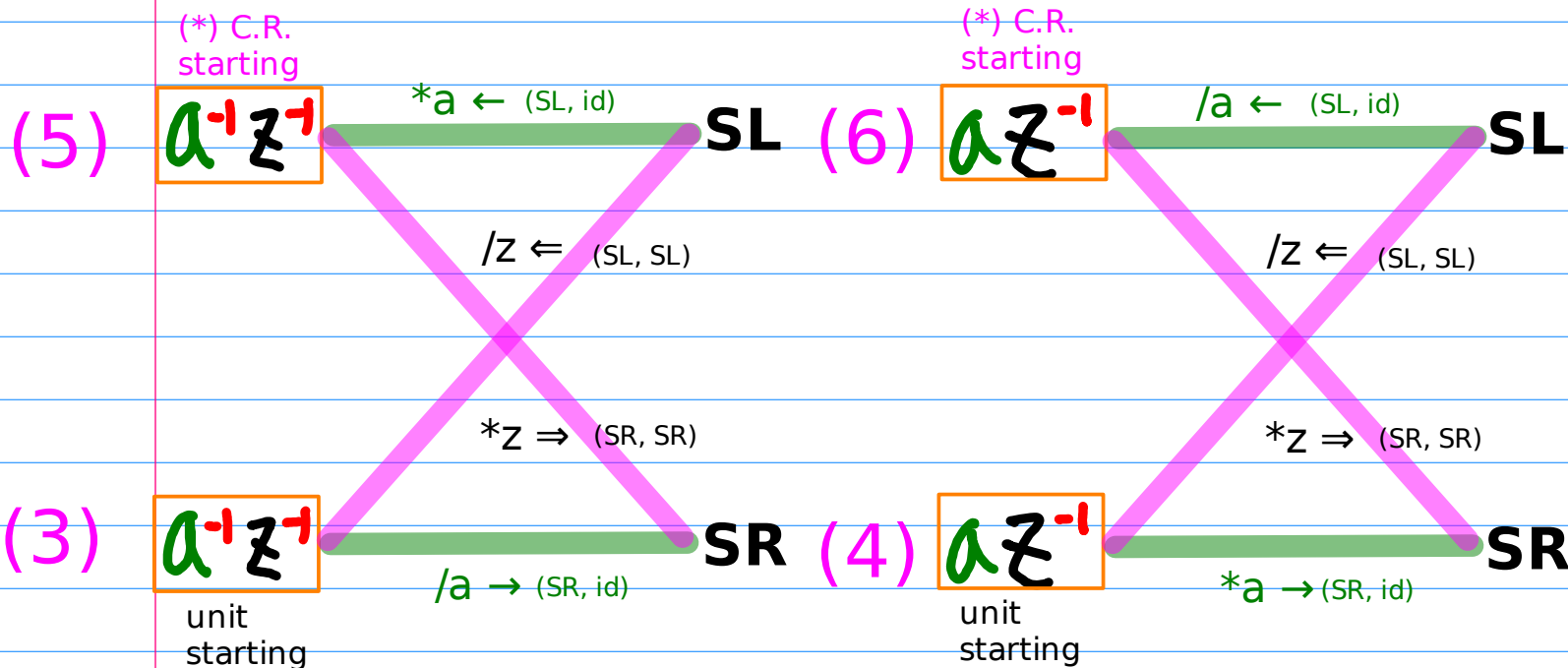
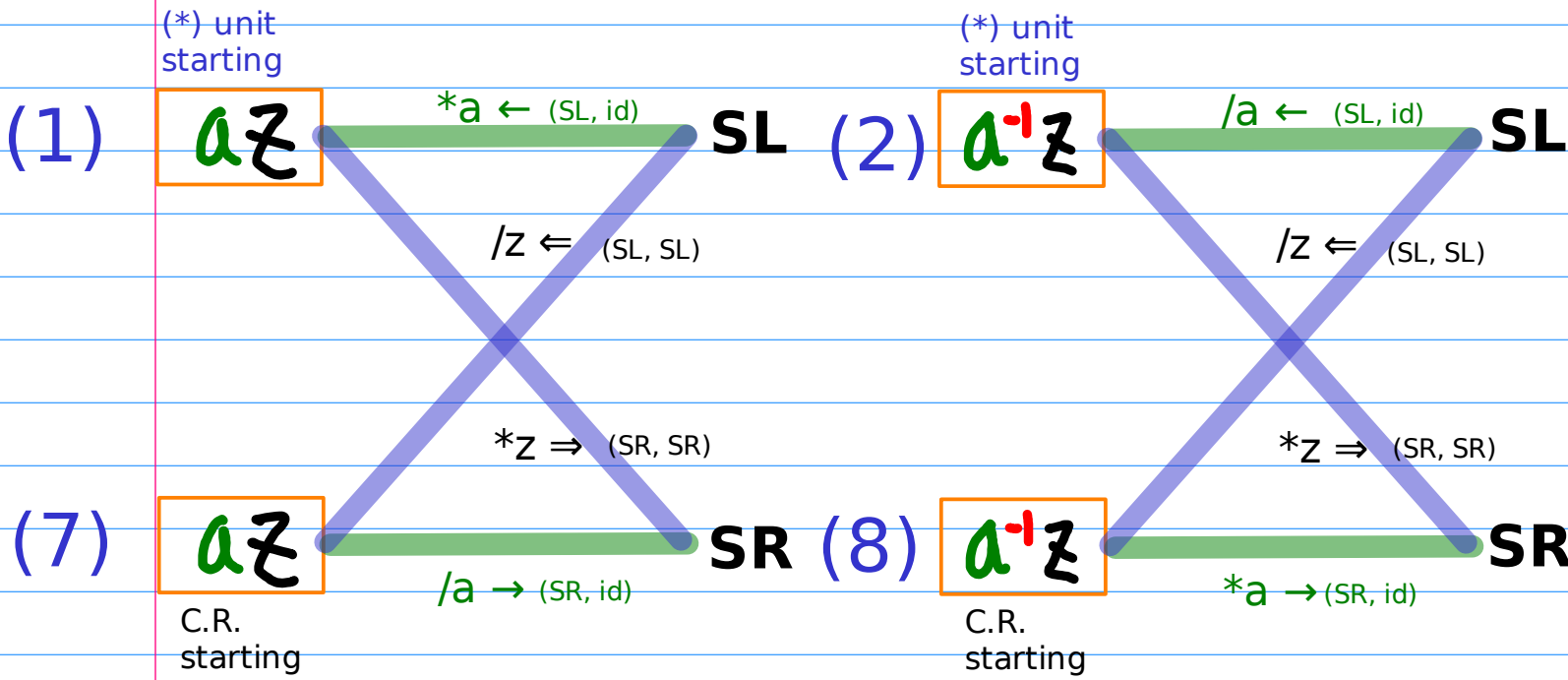

Unit starting

origin including

(1) $\frac{1}{1 - az}$

$a^n u(n)$

(2) $\frac{1}{1 - a^{-1}z}$

$a^{-n} u(n)$

(3) $\frac{1}{1 - a^{-1}z^{-1}}$

$-a^n u(-n)$

(4) $\frac{1}{1 - az^{-1}}$

$-a^{-n} u(-n)$

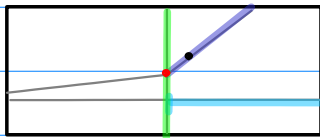

$a^n u(n)$

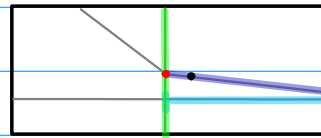

$a^{-n} u(n)$

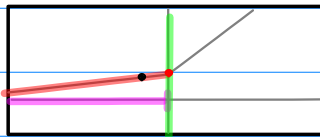

$a^n u(-n)$

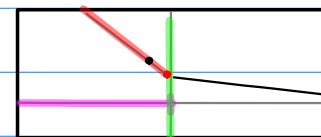

$a^{-n} u(-n)$

C.R. starting

origin excluding

$$(5) \frac{a^{-1}z^{-1}}{1-a^{-1}z^{-1}} - a^n u(-n-1)$$

$$(6) \frac{az^{-1}}{1-az^{-1}} - a^{-n} u(-n-1)$$

$$(7) \frac{az}{1-az} a^n u(n-1)$$

$$(8) \frac{a^{-1}z}{1-a^{-1}z} a^{-n} u(n-1)$$

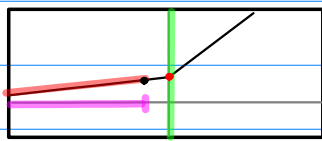

$a^n u(-n-1)$

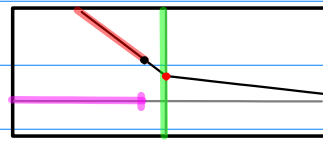

$a^{-n} u(-n-1)$

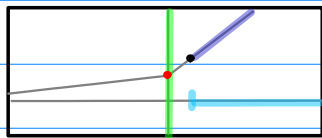

$a^n u(n-1)$

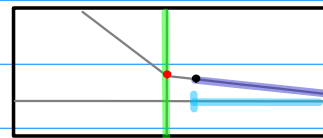

$a^{-n} u(n-1)$

Range Combinations (1)

Symmetric Range

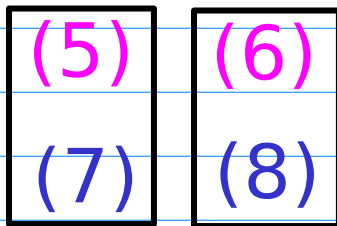
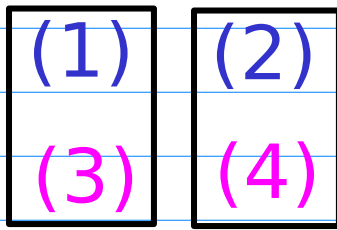

Complementary Range

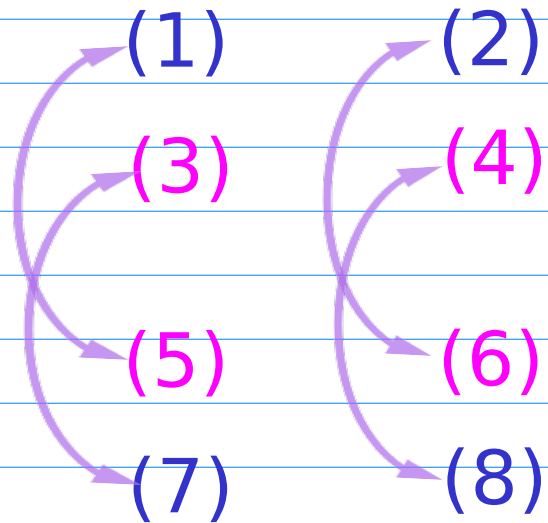

Shifted Range

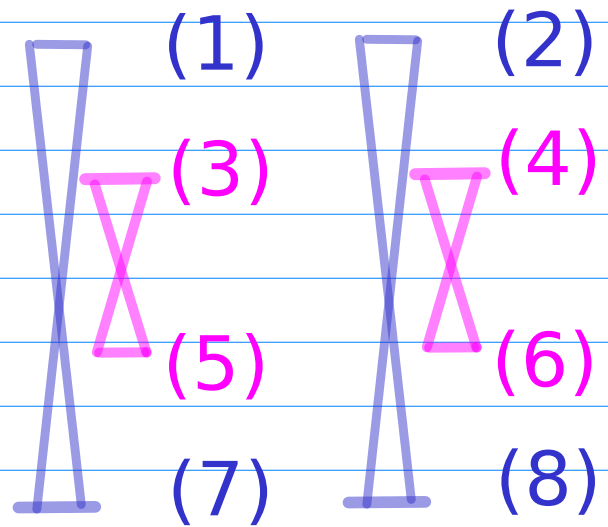

Range Combinations (2)

Symmetric Range

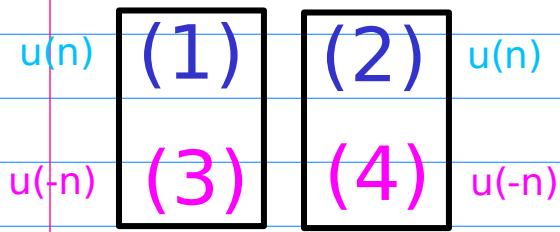

Complementary Range

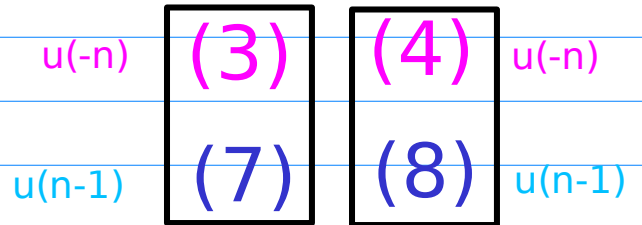
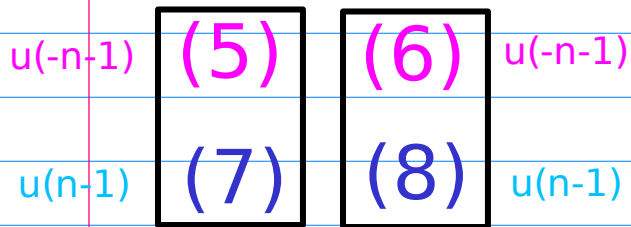
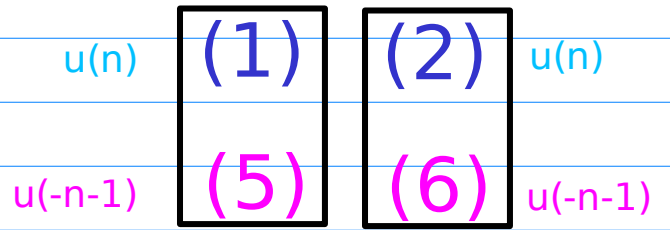

Shifted Range

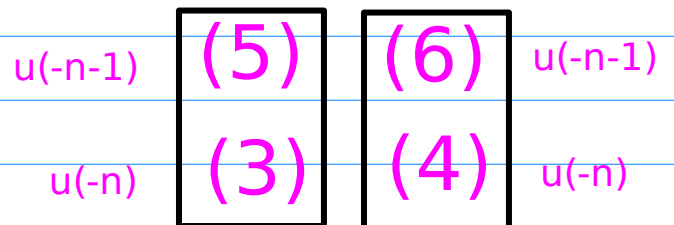
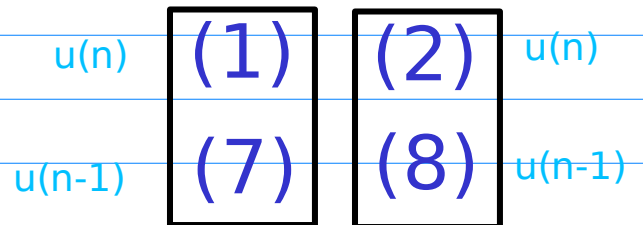

(1) (5)	(2) (6)
(7) (3)	(8) (4)
(1') (5')	(2')(6')
(7')(3')	(8')(4')

Complementary, Shifted, Symmetric Ranges

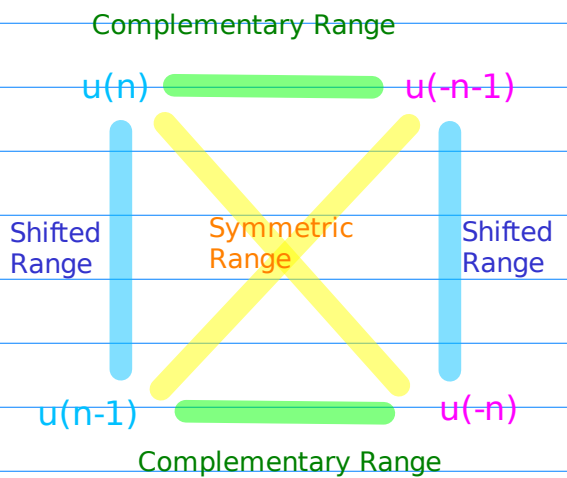
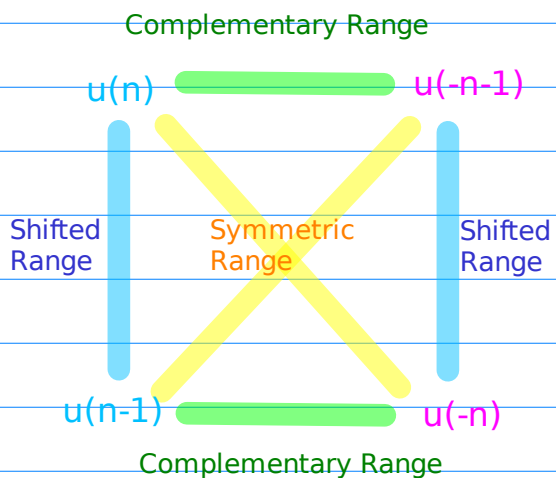
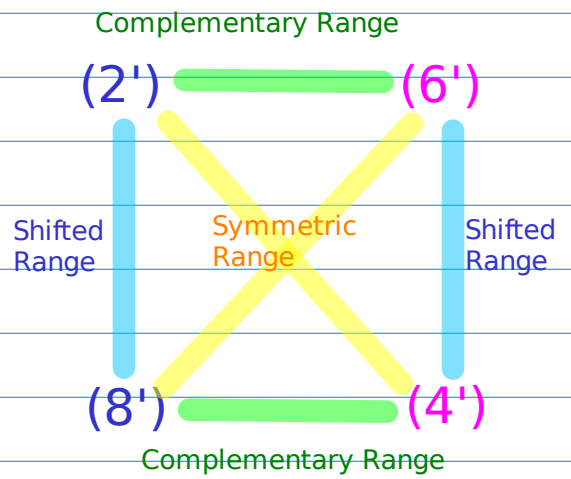
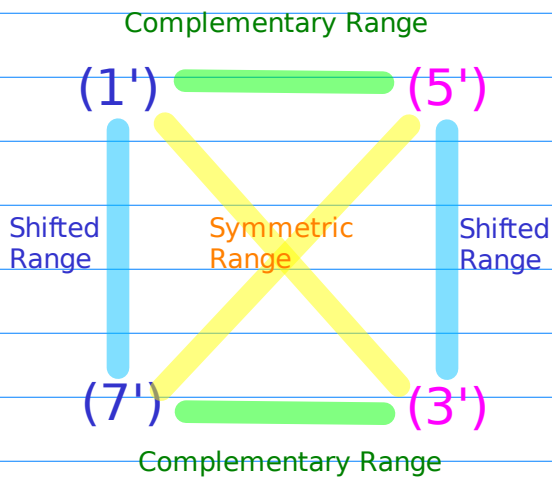
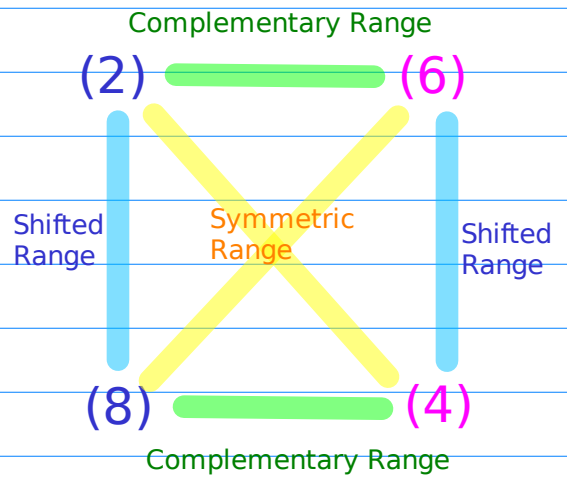
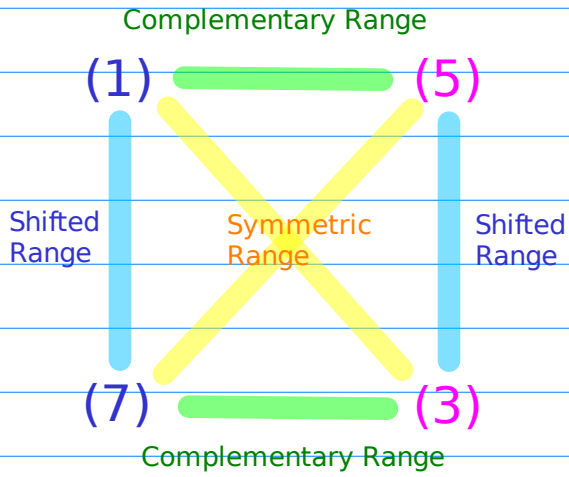



Partial Fraction Decompositions

$$P_1 = 0.5$$

$$P_2 = 2$$

$$\begin{aligned} \frac{3}{2} \frac{1}{(z-0.5)(z-2)} &= \left(\frac{1}{z-0.5} - \frac{1}{z-2} \right) \\ &= \frac{(z-2) - (z-0.5)}{(z-0.5)(z-2)} \\ &= \frac{-1.5}{(z-0.5)(z-2)} \end{aligned}$$

$$\begin{aligned} \frac{3}{2} \frac{z^2}{(z-0.5)(z-2)} &= \left(\frac{0.5z}{z-0.5} - \frac{2z}{z-2} \right) \\ &= \frac{0.5z^2 - z - 2z^2 + z}{(z-0.5)(z-2)} \\ &= \frac{-1.5z^2}{(z-0.5)(z-2)} \end{aligned}$$

$$\begin{aligned} -3 \frac{z}{(z-0.5)(z-2)} &= \left(\frac{1}{z-0.5} - \frac{4}{z-2} \right) \\ &= \frac{(z-2) - 4(z-0.5)}{(z-0.5)(z-2)} \\ &= \frac{-3z}{(z-0.5)(z-2)} \end{aligned}$$

Partial fractions as geometric power series

$$\frac{3}{2} \frac{-1}{(z-0.5)(z-2)} = \left(\frac{1}{z-0.5} - \frac{1}{z-2} \right)$$

$$P_1 = 0.5$$

$$P_2 = 2$$

Simple Pole Form

$$\frac{1}{z-0.5}$$

/0.5

/z

$$-\frac{2}{1-2z}$$

$$\frac{z^1}{1-0.5z^1}$$

Geometric Power Series Forms

Simple Pole Form

$$\frac{1}{z-2}$$

/2

/z

$$-\frac{0.5}{1-0.5z}$$

$$\frac{z^1}{1-2z^1}$$

Geometric Power Series Forms

$$-\frac{3}{2} \frac{z^2}{(z-0.5)(z-2)} = \left(\frac{0.5z}{z-0.5} - \frac{2z}{z-2} \right)$$

$$P_1 = 0.5$$

$$P_2 = 2$$

Simple Pole Form

$$\frac{0.5z}{z-0.5}$$

/0.5

/z

$$-\frac{z}{1-2z}$$

$$\frac{0.5}{1-0.5z^1}$$

Geometric Power Series Forms

Simple Pole Form

$$\frac{2z}{z-2}$$

/2

/z

$$-\frac{z}{1-0.5z}$$

$$\frac{2}{1-2z^1}$$

Geometric Power Series Forms

ROC Cases for irreducible polynomials $(z-0.5), (z-2)$

$$\frac{\square}{(z-0.5)(z-2)}$$

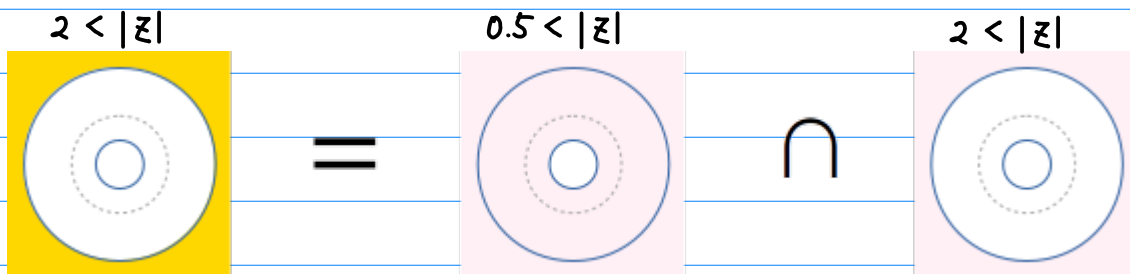
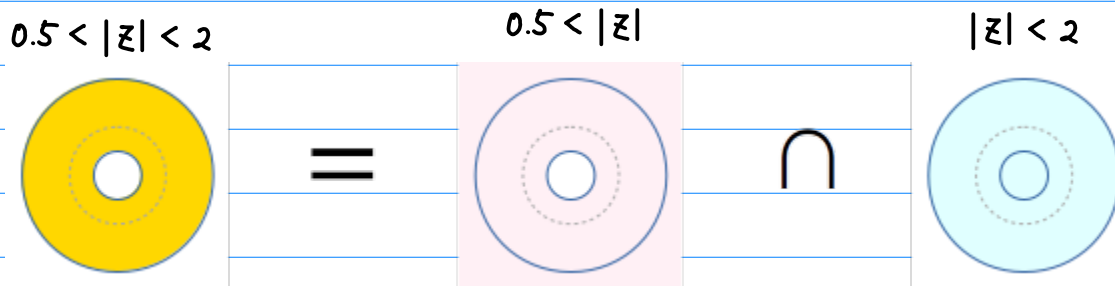
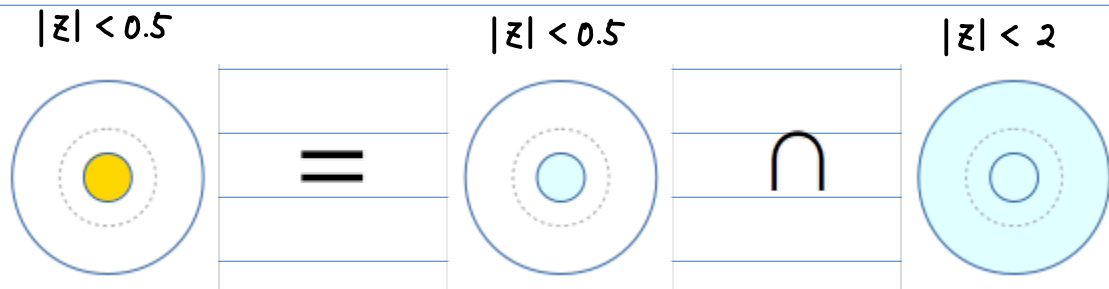

Finding a common ratio

$$P_1 = 0.5$$

$$P_2 = 2$$

$$-\frac{3}{2} \frac{1}{(z-0.5)(z-2)}$$

$$-\frac{3}{2} \frac{z^2}{(z-0.5)(z-2)}$$

$$-\frac{3}{2} \frac{z}{(z-0.5)(z-2)}$$

Irreducible Polynomials

$$(z-0.5)$$

$$(z-2)$$

Geometric Power Series From

$$\frac{1}{(z-0.5)}$$

$$\frac{1}{(z-2)}$$

↓

↓

$$-\frac{2}{1-2z}$$

$$-\frac{2^1}{1-2^1 z}$$

↓

↓

$$(1) \quad 2z$$

$$2^{-1}z \quad (2)$$

$$2^n u(n)$$

$$2^{-n} u(n)$$

Finding a geometric series

$$P_1 = 0.5$$

$$P_2 = 2$$

Irreducible Polynomials

$$(z - 0.5) \quad (z - 2)$$

Geometric Power Series From

$$\frac{1}{(z - 0.5)} \quad \frac{1}{(z - 2)}$$

$$-\frac{2}{1 - 2z} \quad -\frac{2^i}{1 - 2^i z}$$

$$\Downarrow \quad \Downarrow$$

$$2 \cdot \frac{1}{1 - 2z} \quad 2^i \cdot \frac{1}{1 - 2^i z}$$

$$a = 2$$

$$a^{-1} = 2^{-1}$$

$(1) \quad 2^n u(n)$ $a z$	$+$ $\frac{1}{1 - a z}$	$+$ $\frac{1}{1 - a^{-1} z}$	$2^{-n} u(n)$ $a^{-1} z$	(2)
$(3) \quad a^{-1} z^{-1}$	$-$ $\frac{1}{1 - a^{-1} z^{-1}}$	$-$ $\frac{1}{1 - a z^{-1}}$	$a z^{-1}$	(4)
$(5) \quad a^{-1} z^{-1}$	$-$ $\frac{a^{-1} z^{-1}}{1 - a^{-1} z^{-1}}$	$-$ $\frac{a z^{-1}}{1 - a z^{-1}}$	$a z^{-1}$	(6)
$(7) \quad a z$	$+$ $\frac{a z}{1 - a z}$	$+$ $\frac{a^{-1} z}{1 - a^{-1} z}$	$a^{-1} z$	(8)

$$\begin{matrix} (1) (1') \\ (7) (7') \end{matrix} \quad \begin{matrix} (2) (2') \\ (8) (8') \end{matrix}$$

$$\begin{matrix} (5) (5') \\ (3') \end{matrix} \quad \begin{matrix} (6) (6') \\ (4) (4') \end{matrix}$$

$$P_1 = 0.5$$

$$P_2 = 2$$

Irreducible Polynomials

Geometric Power Series From

$$(z - 0.5)$$

$$(z - 2)$$

$$\frac{1}{(z - 0.5)}$$

$$\frac{1}{(z - 2)}$$

$$\rightarrow -\frac{2}{1 - 2z}$$

$$\rightarrow -\frac{2^i}{1 - 2^i z}$$

↓

↓

$$\rightarrow 2 \cdot \frac{1}{1 - 2z}$$

$$\rightarrow 2^i \cdot \frac{1}{1 - 2^i z}$$

$$a = 2$$

$$a^{-1} = 2^{-1}$$

(1) $\frac{1}{1 - az}$ $\xrightarrow{*a \leftarrow}$ $\frac{a}{1 - az}$
 $a^n u(n)$ $\quad \quad \quad a^{n+1} u(n)$

(2) $\frac{1}{1 - a^{-1}z}$ $\xrightarrow{/a \leftarrow}$ $\frac{a^{-1}}{1 - a^{-1}z}$
 $a^{-n} u(n)$ $\quad \quad \quad a^{-n-1} u(n)$

(7) $\frac{az}{1 - az}$ $\xrightarrow{/a \rightarrow}$ $\frac{z}{1 - az}$
 $a^n u(n-1)$ $\quad \quad \quad a^{n-1} u(n-1)$

(8) $\frac{a^{-1}z}{1 - a^{-1}z}$ $\xrightarrow{*a \rightarrow}$ $\frac{z}{1 - a^{-1}z}$
 $a^{-n} u(n-1)$ $\quad \quad \quad a^{-n+1} u(n-1)$

(5) $-\frac{a^{-1}z^{-1}}{1 - a^{-1}z^{-1}}$ $\xrightarrow{*a \leftarrow}$ $-\frac{z^{-1}}{1 - a^{-1}z^{-1}}$
 $a^n u(-n-1)$ $\quad \quad \quad a^{n+1} u(-n-1)$

(6) $-\frac{az^{-1}}{1 - az^{-1}}$ $\xrightarrow{/a \leftarrow}$ $-\frac{z^{-1}}{1 - az^{-1}}$
 $a^{-n} u(-n-1)$ $\quad \quad \quad a^{-n-1} u(-n-1)$

(3) $-\frac{1}{1 - a^{-1}z^{-1}}$ $\xrightarrow{/a \rightarrow}$ $-\frac{a^{-1}}{1 - a^{-1}z^{-1}}$
 $a^n u(-n)$ $\quad \quad \quad a^{n-1} u(-n)$

(4) $-\frac{1}{1 - az^{-1}}$ $\xrightarrow{*a \rightarrow}$ $-\frac{a}{1 - az^{-1}}$
 $a^{-n} u(-n)$ $\quad \quad \quad a^{-n+1} u(-n)$

Decoding Geometric Series

Positive Exponent

$$2z, 2^{-1}z^{-1} \rightarrow 2^n$$

Negative Exponent

$$2^{-1}z, 2z^{-1} \rightarrow 2^{-n}$$

Causal

$$\square z \rightarrow u(n), u(n-1)$$

Anti-causal

$$\square z^{-1} \rightarrow u(-n), u(-n-1)$$

$$\frac{1}{1-\square z} \rightarrow u(n)$$

$$\frac{1}{1-\square z^{-1}} \rightarrow u(-n)$$

$$\frac{\square z}{1-\square z} \rightarrow u(n-1)$$

$$\frac{\square z^{-1}}{1-\square z^{-1}} \rightarrow u(-n-1)$$

$$a=2$$

- (1) (2)
- (3) (4)
- (5) (6)
- (7) (8)

	$2^n u(n)$	$2^{n+1} u(n)$		$2^{-n} u(n)$	$2^{-n-1} u(n)$
(1)	$\frac{1}{1-2z}$	$\xrightarrow{*2 \leftarrow}$	$\frac{2}{1-2z}$	$2z$	$2^{-1}z$
(2)	$\frac{1}{1-2^{-1}z}$	$\xrightarrow{/2 \leftarrow}$	$\frac{2^{-1}}{1-2^{-1}z}$		
(3)	$\frac{1}{1-2^1 z^{-1}}$	$\xrightarrow{/2 \rightarrow}$	$\frac{2^{-1}}{1-2^1 z^{-1}}$	$2^{-1}z^{-1}$	$2z^{-1}$
(4)	$\frac{1}{1-2z^{-1}}$	$\xrightarrow{*2 \rightarrow}$	$\frac{2}{1-2z^{-1}}$		
	$2^n u(-n)$		$2^{n-1} u(-n)$		$2^{-n} u(-n)$
				$2^{-n} u(-n)$	$2^{-n+1} u(-n)$
	$2^n u(-n-1)$		$2^{n+1} u(-n-1)$		$2^{-n} u(-n-1)$
(5)	$\frac{2^1 z^{-1}}{1-2^1 z^{-1}}$	$\xrightarrow{*2 \leftarrow}$	$\frac{z^{-1}}{1-2^1 z^{-1}}$	$2^{-1}z^{-1}$	$2z^{-1}$
(6)	$\frac{2z^{-1}}{1-2z^{-1}}$	$\xrightarrow{/2 \leftarrow}$	$\frac{z^{-1}}{1-2z^{-1}}$		
(7)	$\frac{2z}{1-2z}$	$\xrightarrow{/2 \rightarrow}$	$\frac{z}{1-2z}$	$2z$	$2^{-1}z$
(8)	$\frac{2^{-1}z}{1-2^{-1}z}$	$\xrightarrow{*2 \rightarrow}$	$\frac{z}{1-2^{-1}z}$		
	$2^n u(n-1)$		$2^{n-1} u(n-1)$		$2^{-n} u(n-1)$
					$2^{-n+1} u(n-1)$



$$\frac{3}{2} \frac{-1}{(z-0.5)(z-2)} = \left(\frac{1}{z-0.5} - \frac{1}{z-2} \right)$$

$$P_1 = 0.5$$

$$P_2 = 2$$

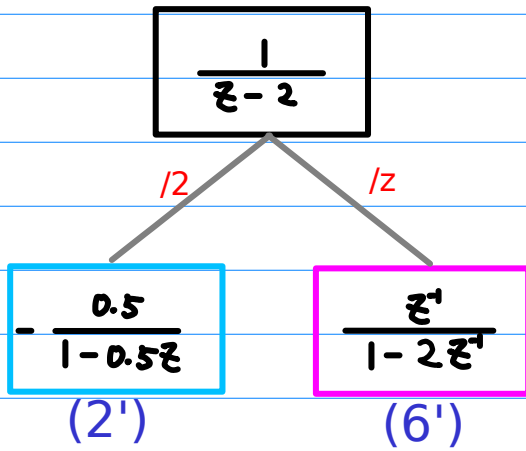
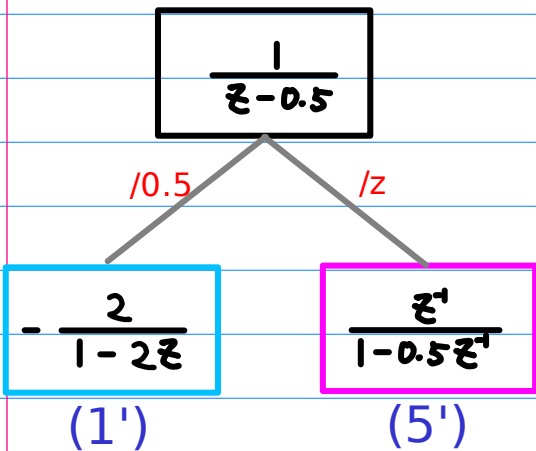

Complementary Ranges

Complementary Ranges

$$-2 \cdot \frac{1}{1-2z}$$

$$2 \cdot \frac{0.5z^{-1}}{1-0.5z^{-1}}$$

$$-0.5 \cdot \frac{1}{1-0.5z}$$

$$0.5 \cdot \frac{2z^{-1}}{1-2z^{-1}}$$

$$-2^{n+1} u(n)$$

$$2^{n+1} u(-n-1)$$

$$-\left(\frac{1}{2}\right)^{n+1} u(n)$$

$$\left(\frac{1}{2}\right)^{n+1} u(-n-1)$$

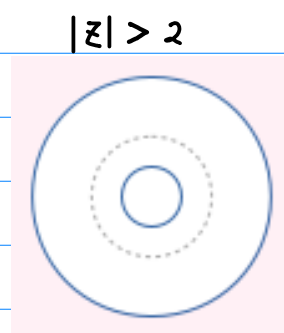
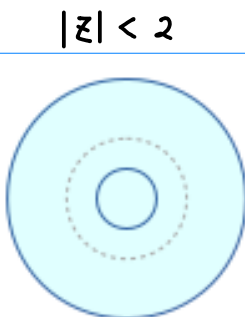
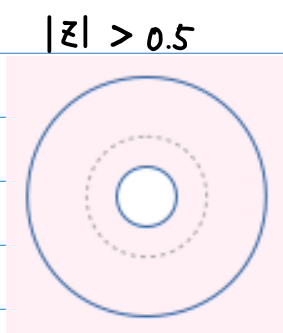
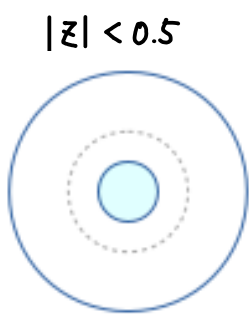

(A)

(B)

(C)

(A)

(B)

(C)

Case A $|z| < 0.5$

(1') (2')

Case B $0.5 < |z| < 2$

(5') (2')

Case C $2 < |z|$

(5') (6')

$$\frac{3}{2} \frac{-z^2}{(z-0.5)(z-2)} = \left(\frac{0.5z}{z-0.5} - \frac{2z}{z-2} \right)$$

$$P_1 = 0.5$$

$$P_2 = 2$$

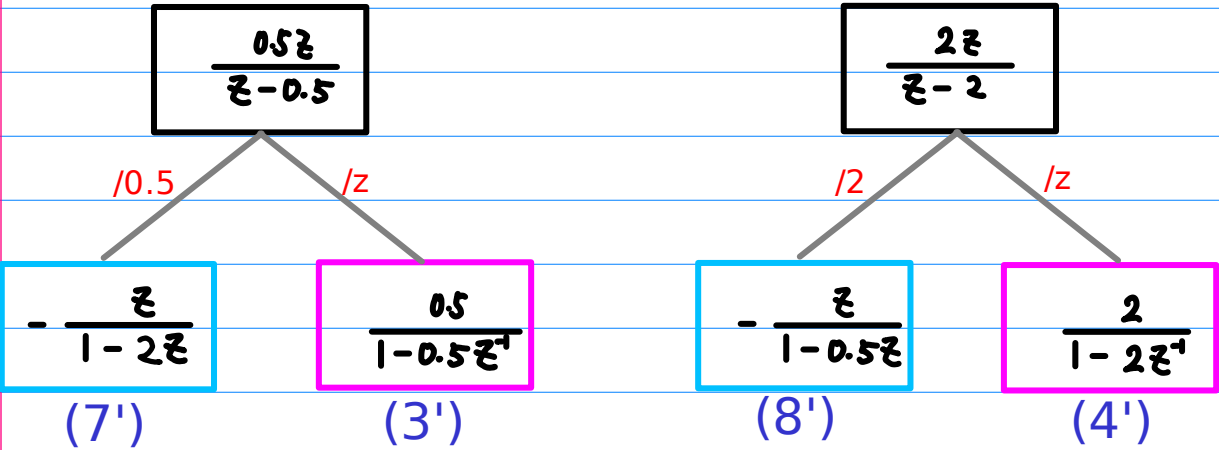

Complementary Ranges

Complementary Ranges

$$-0.5 \cdot \frac{2z}{1-2z}$$

$$0.5 \cdot \frac{1}{1-0.5z^{-1}}$$

$$-2 \cdot \frac{0.5z}{1-0.5z}$$

$$2 \cdot \frac{1}{1-2z^{-1}}$$

$$-2^{n-1} u(n-1)$$

$$2^{n-1} u(-n)$$

$$-\left(\frac{1}{2}\right)^{n-1} u(n-1)$$

$$\left(\frac{1}{2}\right)^{n-1} u(-n)$$

$$|z| < 0.5$$

$$|z| > 0.5$$

$$|z| < 2$$

$$|z| > 2$$

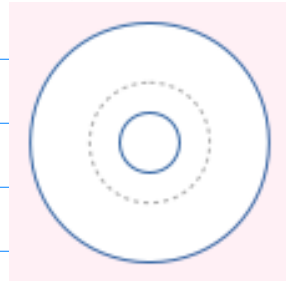
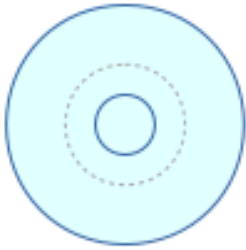
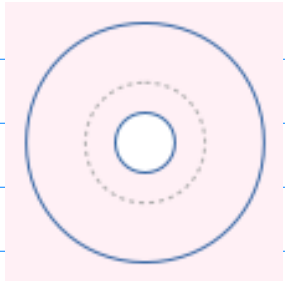
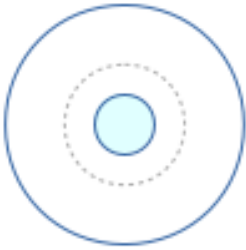

(A)

(B)
(C)

(A)
(B)

(C)

Case A $|z| < 0.5$

Case B $0.5 < |z| < 2$

Case C $2 < |z|$

(7') (8')

(3') (8')

(3') (4')



Reciprocal Pole Relation (p=2)

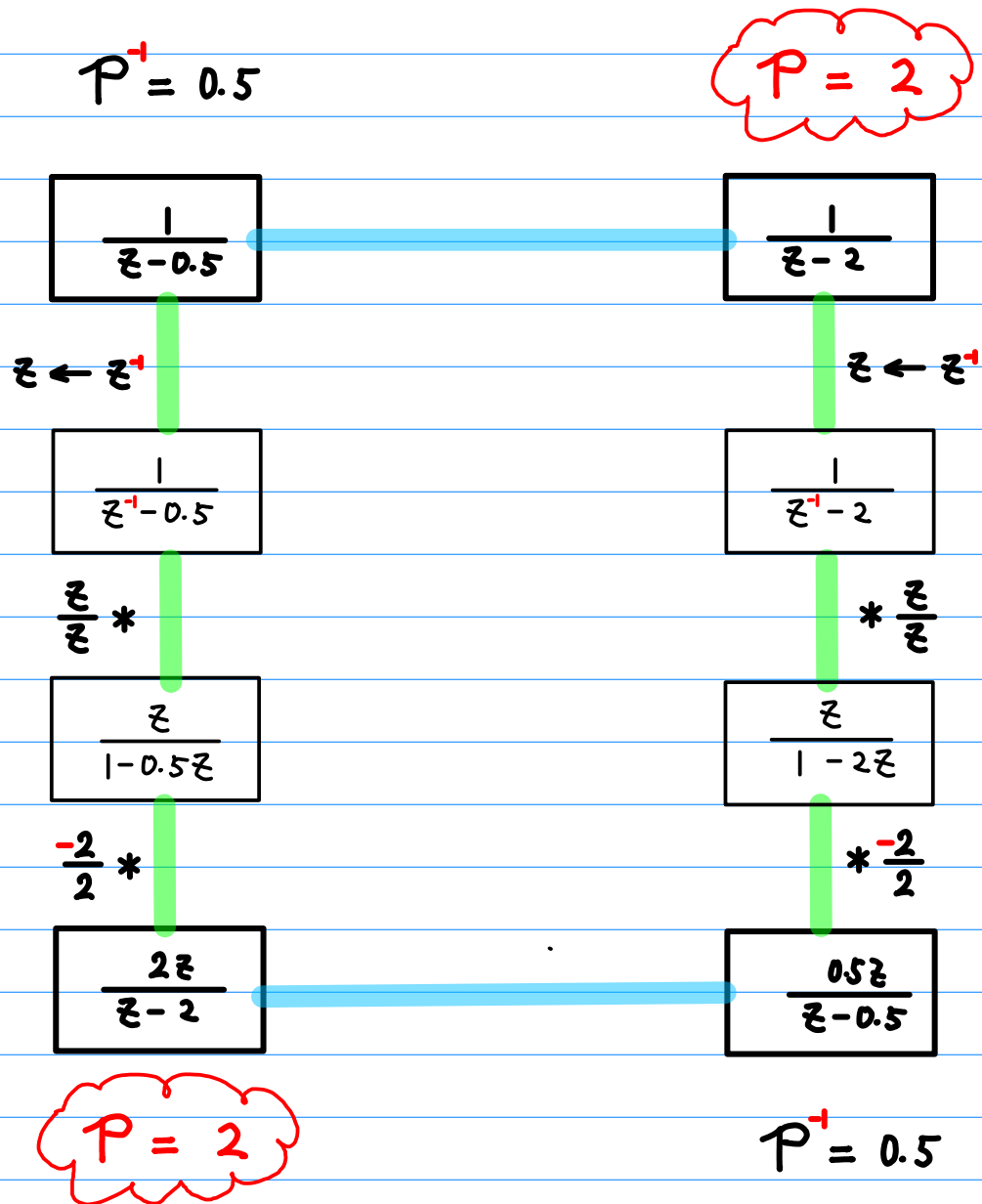

Reciprocal Pole Partial Fractions (p=2)

$$P^{-1} = 0.5$$

$$P = 2$$

$$\frac{3}{2} \frac{-1}{(z-0.5)(z-2)} = \left(\frac{1}{z-0.5} - \frac{1}{z-2} \right)$$

$$z \leftarrow z^{-1}$$

$$\frac{3}{2} \frac{-1}{(z^{-1}-0.5)(z^{-1}-2)} = \left(\frac{1}{z^{-1}-0.5} - \frac{1}{z^{-1}-2} \right)$$

$$* \frac{z}{z}$$

$-1, z^{-1}$

$$\frac{3}{2} \frac{-z^2}{(1-0.5z)(1-2z)} = \left(\frac{z}{(1-0.5z)} - \frac{z}{(1-2z)} \right)$$

$$* \frac{2}{2}$$

$$\frac{3}{2} \frac{-z^2 \cdot 2 \cdot 0.5}{(2-z)(0.5-z)} = \left(\frac{2z}{(2-z)} - \frac{0.5z}{(0.5-z)} \right)$$

$$* -1$$

$$\frac{3}{2} \frac{-z^2}{(z-0.5)(z-2)} = \left(\frac{0.5z}{z-0.5} - \frac{2z}{z-2} \right)$$

Reciprocal Pole Relation : Partial Fractions and Geometric Power Series

$$P^{-1} = 0.5$$

$$P = 2$$

$$\frac{3}{2} \frac{-1}{(z-0.5)(z-2)} = \left(\frac{1}{z-0.5} - \frac{1}{z-2} \right)$$

$-1, z^{-1}$

$$\frac{3}{2} \frac{-z^2}{(z-0.5)(z-2)} = \left(\frac{0.5z}{z-0.5} - \frac{2z}{z-2} \right)$$

$$\frac{1}{z-0.5}$$

/0.5

/z

$$-\frac{2}{1-2z}$$

-(1')

$$-2^{n+1} u(n)$$

$$\frac{z^1}{1-0.5z^1}$$

(5')

$$2^{n+1} u(-n-1)$$

$$\frac{1}{z-2}$$

/2

/z

$$-\frac{0.5}{1-0.5z}$$

-(2')

$$-\left(\frac{1}{2}\right)^{n+1} u(n)$$

$$\frac{z^1}{1-2z^1}$$

(6')

$$\left(\frac{1}{2}\right)^{n+1} u(-n-1)$$

$$\frac{0.5z}{z-0.5}$$

/0.5

/z

$$-\frac{z}{1-2z}$$

-(7')

$$-2^{n-1} u(n-1)$$

$$\frac{0.5}{1-0.5z^1}$$

(3')

$$2^{n-1} u(-n)$$

$$\frac{2z}{z-2}$$

/2

/z

$$-\frac{z}{1-0.5z}$$

-(8')

$$-\left(\frac{1}{2}\right)^{n-1} u(n-1)$$

$$\frac{2}{1-2z^1}$$

(4')

$$\left(\frac{1}{2}\right)^{n-1} u(-n)$$

Reciprocal poles in Simple Pole Forms ($p=2$)

$$P^+ = 0.5$$

$$P = 2$$

$$P^+ = 0.5$$

$$P = 2$$

$$\frac{1}{z-0.5}$$

$$\frac{1}{z-2}$$

$$\frac{1}{z^+ - 0.5}$$

$$\frac{1}{z^+ - 2}$$

$$\frac{z}{1-0.5z}$$

$$\frac{z}{1-2z}$$

$$-\frac{2z}{z-2}$$

$$-\frac{0.5z}{z-0.5}$$

$$\frac{3}{2} \frac{-1}{(z-0.5)(z-2)} = \left(\frac{1}{z-0.5} - \frac{1}{z-2} \right)$$

$$\frac{1}{z-0.5}$$

$$\frac{1}{z-2}$$

$-1, z^+$

$-1, z^+$

$$\frac{0.5z}{z-0.5}$$

$$\frac{2z}{z-2}$$

$-1, z^+$

$$\frac{3}{2} \frac{-z^2}{(z-0.5)(z-2)} = \left(\frac{0.5z}{z-0.5} - \frac{2z}{z-2} \right)$$

Reciprocal poles in Geometric Series Forms

(p=2) Causal

$$P^{-1} = 0.5$$

$$P = 2$$

$$-\frac{2}{1-2z}$$

$$-\frac{0.5}{1-0.5z}$$

$$-\frac{2}{1-2z^{-1}}$$

$$-\frac{0.5}{1-0.5z^{-1}}$$

$$-\frac{2z}{z-2}$$

$$-\frac{0.5z}{z-0.5}$$

$$\frac{z}{1-0.5z}$$

$$\frac{z}{1-2z}$$

$$\frac{3}{2} \frac{-1}{(z-0.5)(z-2)} = \left(\frac{1}{z-0.5} - \frac{1}{z-2} \right)$$

$$-(1') \quad -2^{n+1} u(n) \quad -\frac{2}{1-2z}$$

$$-(2') \quad -\left(\frac{1}{2}\right)^{n+1} u(n) \quad -\frac{0.5}{1-0.5z}$$

$$-(7') \quad -2^{n-1} u(n-1) \quad -\frac{z}{1-2z}$$

$$-(8') \quad -\left(\frac{1}{2}\right)^{n-1} u(n-1) \quad -\frac{z}{1-0.5z}$$

$-1, z^{-1}$

$$\frac{3}{2} \frac{-z^2}{(z-0.5)(z-2)} = \left(\frac{0.5z}{z-0.5} - \frac{2z}{z-2} \right)$$

Reciprocal poles in Geometric Series Forms $\mathcal{P}^{-1} = 0.5$
 (p=2) Anti-causal $\mathcal{P} = 2$

$$\mathcal{P}^{-1} = 0.5$$

$$\mathcal{P} = 2$$

$$\frac{z^{-1}}{1-0.5z^{-1}}$$

$$\frac{z^{-1}}{1-2z^{-1}}$$

$$\frac{z^{-n}}{1-0.5z^{-n}}$$

$$\frac{z^{-n}}{1-2z^{-n}}$$

$$\frac{1}{z^{-1}-0.5}$$

$$\frac{1}{z^{-1}-2}$$

$$-\frac{2}{1-2z^{-1}}$$

$$-\frac{0.5}{1-0.5z^{-1}}$$

$$\frac{3}{2} \frac{-1}{(z-0.5)(z-2)} = \left(\frac{1}{z-0.5} - \frac{1}{z-2} \right)$$

$$(5') \quad \frac{z^{-1}}{1-0.5z^{-1}} \quad 2^{n+1} u(-n-1)$$

$$(6') \quad \frac{z^{-1}}{1-2z^{-1}} \quad \left(\frac{1}{2}\right)^{n+1} u(-n-1)$$

$$(3') \quad \frac{0.5}{1-0.5z^{-1}} \quad 2^{n-1} u(-n)$$

$$(4') \quad \frac{2}{1-2z^{-1}} \quad \left(\frac{1}{2}\right)^{n-1} u(-n)$$

$$\frac{3}{2} \frac{-z^2}{(z-0.5)(z-2)} = \left(\frac{0.5z}{z-0.5} - \frac{2z}{z-2} \right)$$

$-1, z^{-1}$

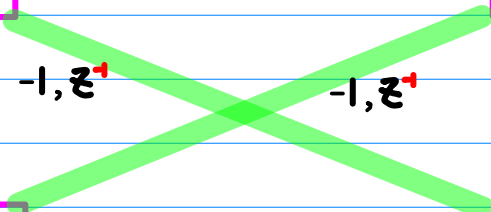
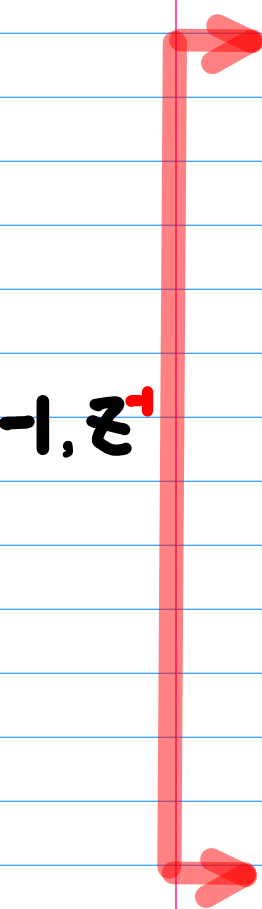

Reciprocal Pole Relation :
 Shifted version and
 Unshifted version

$$P^{-1} = 0.5$$

$$P = 2$$

$$\frac{1}{z-0.5} \quad \frac{1}{z-2}$$

$-1, z^{-1}$ $-1, z^{-1}$

$$\frac{0.5z}{z-0.5} \quad \frac{2z}{z-2}$$

$$\frac{3}{2} \frac{-1}{(z-0.5)(z-2)}$$

$-1, z^{-1}$

$$-\frac{3}{2} \frac{z^2}{(z-0.5)(z-2)}$$

-(1')

$$-\frac{2}{1-2z}$$

$-1, z^{-1}$ $-1, z^{-1}$

$$-\frac{z}{1-2z}$$

-(7')

-(2')

$$-\frac{0.5}{1-0.5z}$$

$-1, z^{-1}$

$$-\frac{z}{1-0.5z}$$

-(8')

(5')

$$\frac{z^{-1}}{1-0.5z^{-1}}$$

$-1, z^{-1}$

$$\frac{0.5}{1-0.5z^{-1}}$$

(3')

(6')

$$\frac{z^{-1}}{1-2z^{-1}}$$

$-1, z^{-1}$

$$\frac{2}{1-2z^{-1}}$$

(4')

-(1)

$$-\frac{1}{1-2z}$$

$-1, z^{-1}$ $-1, z^{-1}$

$$-\frac{2z}{1-2z}$$

-(7)

-(2)

$$-\frac{1}{1-0.5z}$$

$-1, z^{-1}$

$$-\frac{0.5z}{1-0.5z}$$

-(8)

(5)

$$\frac{0.5z^{-1}}{1-0.5z^{-1}}$$

$-1, z^{-1}$

$$\frac{1}{1-0.5z^{-1}}$$

(3)

(6)

$$\frac{2z^{-1}}{1-2z^{-1}}$$

$-1, z^{-1}$

$$\frac{1}{1-2z^{-1}}$$

(4)



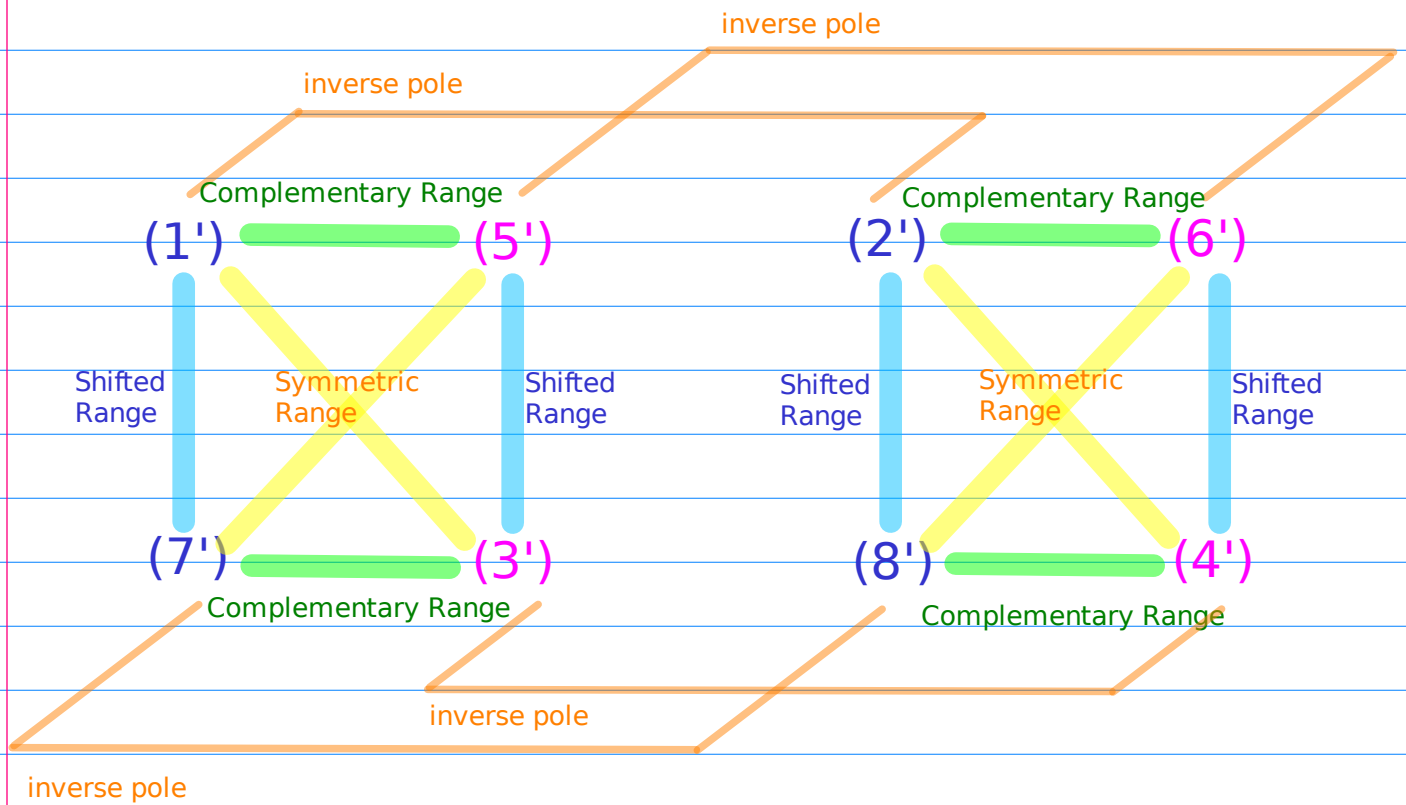
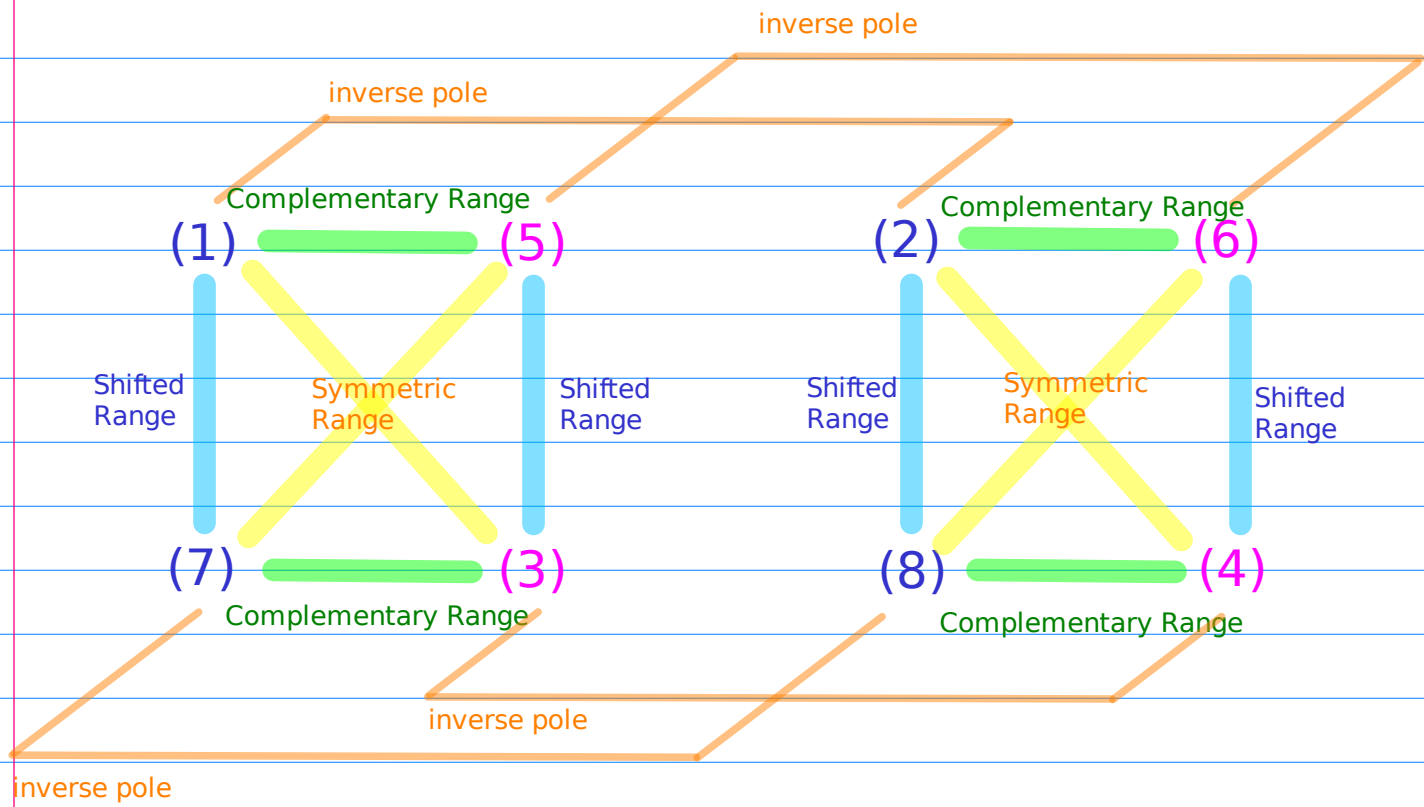

-(1)

$$-\frac{1}{1-2z}$$

$-2^n u(n)$

(5)

$$\frac{0.5z^{-1}}{1-0.5z^{-1}}$$

$2^n u(-n-1)$

-(2)

$$-\frac{1}{1-0.5z}$$

$-2^{-n} u(n)$

(6)

$$\frac{2z^{-1}}{1-2z^{-1}}$$

$2^{-n} u(-n-1)$

-(7)

$$-\frac{2z}{1-2z}$$

$-2^n u(n-1)$

(3)

$$\frac{1}{1-0.5z^{-1}}$$

$2^n u(-n)$

-(8)

$$-\frac{0.5z}{1-0.5z}$$

$-2^{-n} u(n-1)$

(4)

$$\frac{1}{1-2z^{-1}}$$

$2^{-n} u(-n)$

-(1')

$$-\frac{2}{1-2z}$$

(5')

$$\frac{z^{-1}}{1-0.5z^{-1}}$$

-(2')

$$-\frac{0.5}{1-0.5z}$$

(6')

$$\frac{z^{-1}}{1-2z^{-1}}$$

-(7')

$$-\frac{z}{1-2z}$$

(3')

$$\frac{0.5}{1-0.5z^{-1}}$$

-(8')

$$-\frac{z}{1-0.5z}$$

(4')

$$\frac{2}{1-2z^{-1}}$$

$$n \leftarrow -n$$

$$u(n) \leftrightarrow u(n-1)$$

$$u(-n) \leftrightarrow u(-n-1)$$

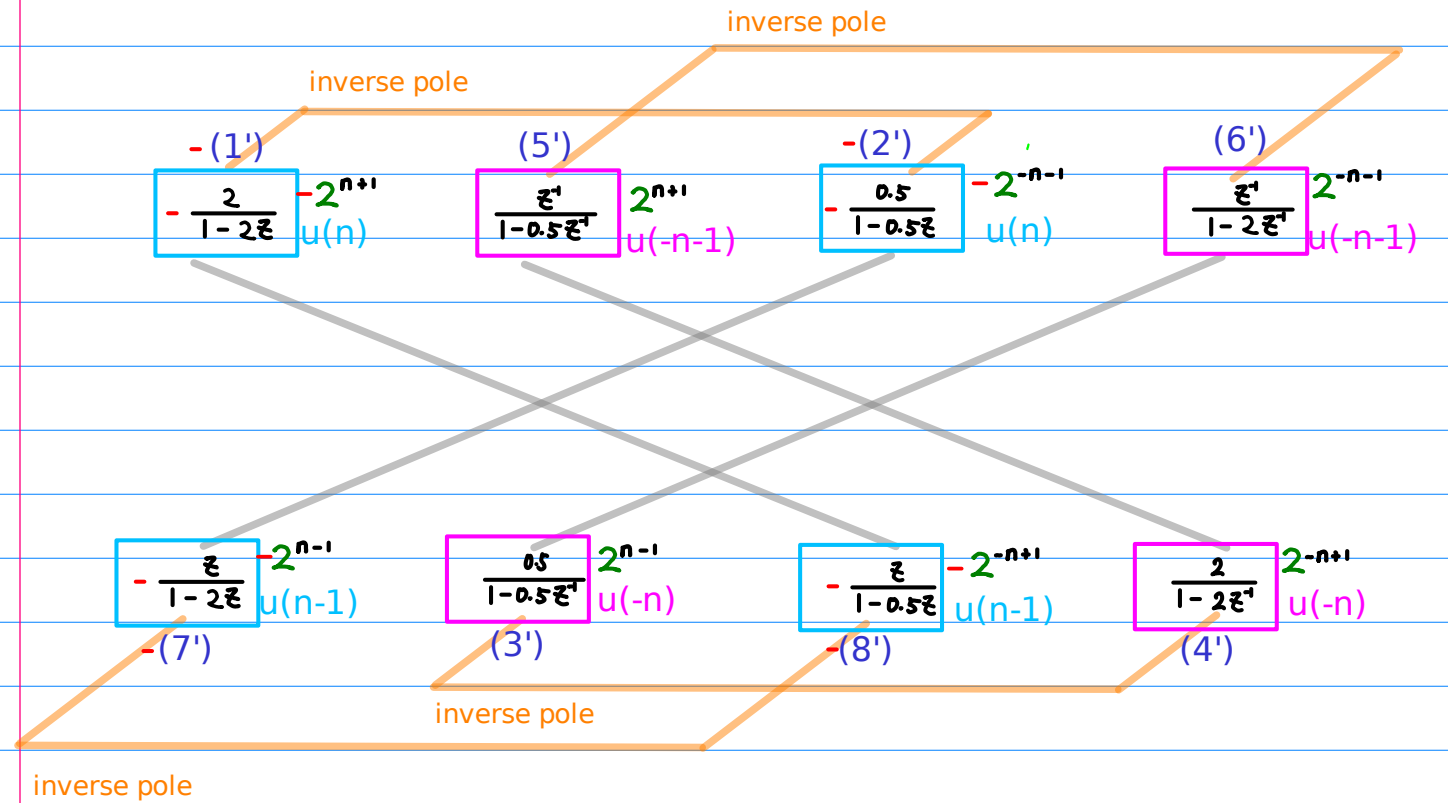
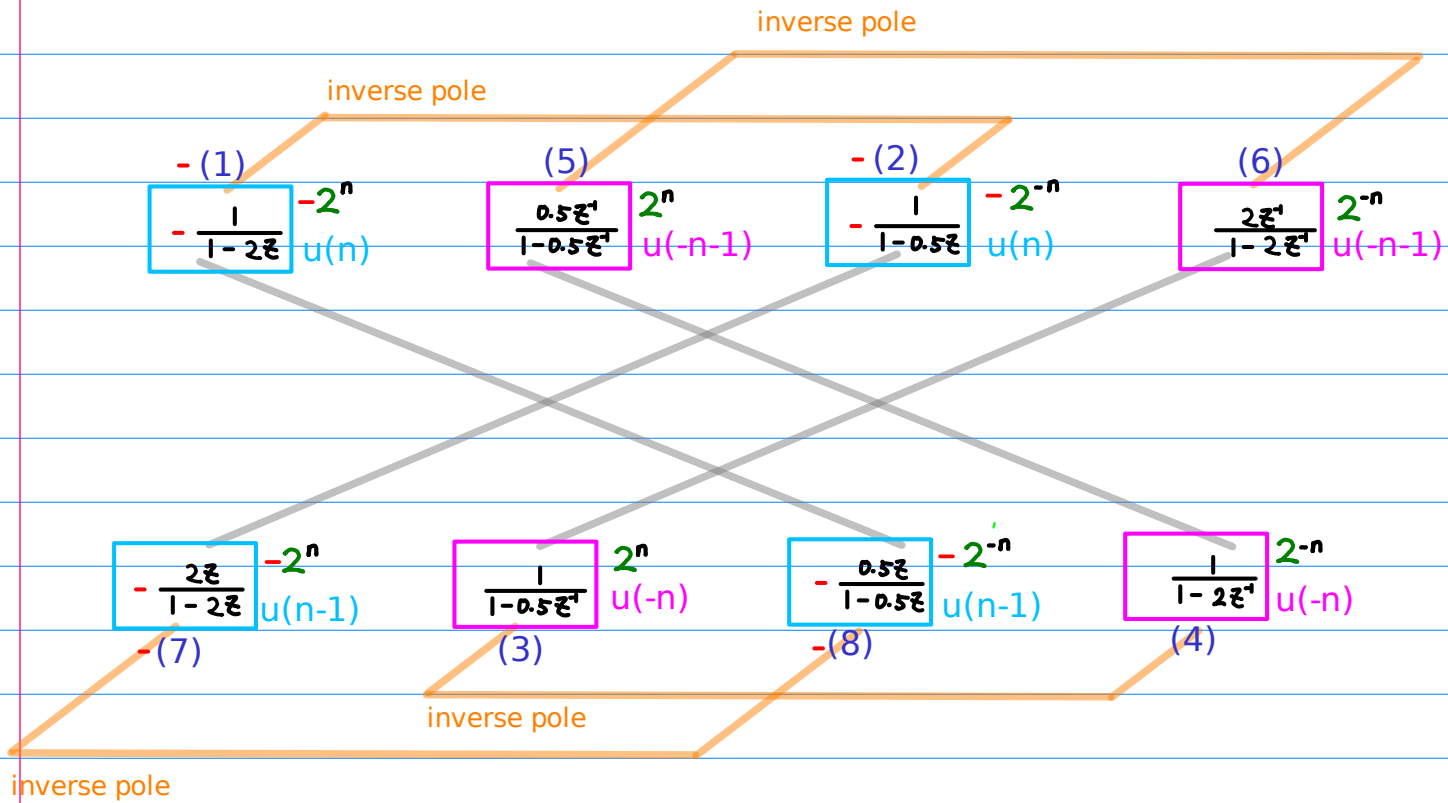

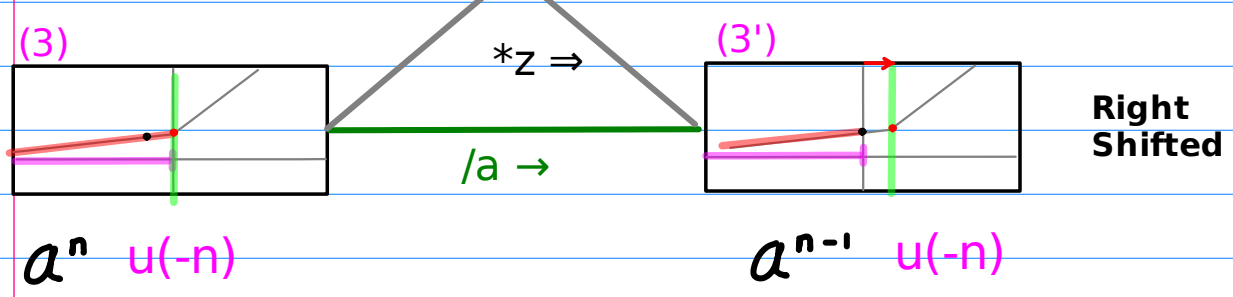
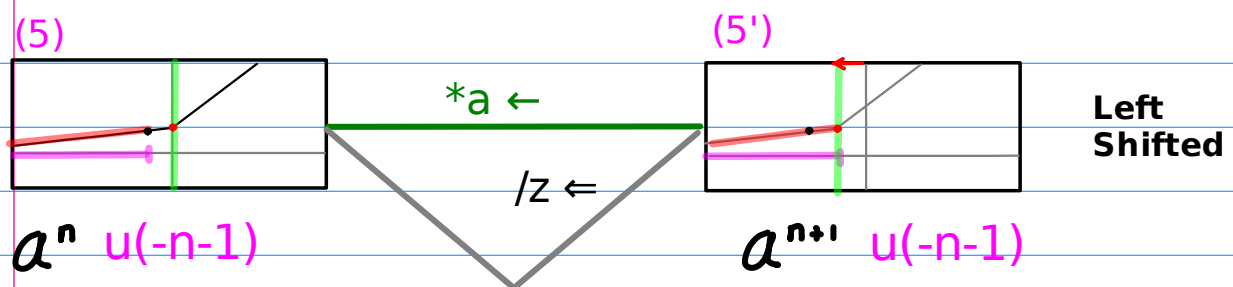
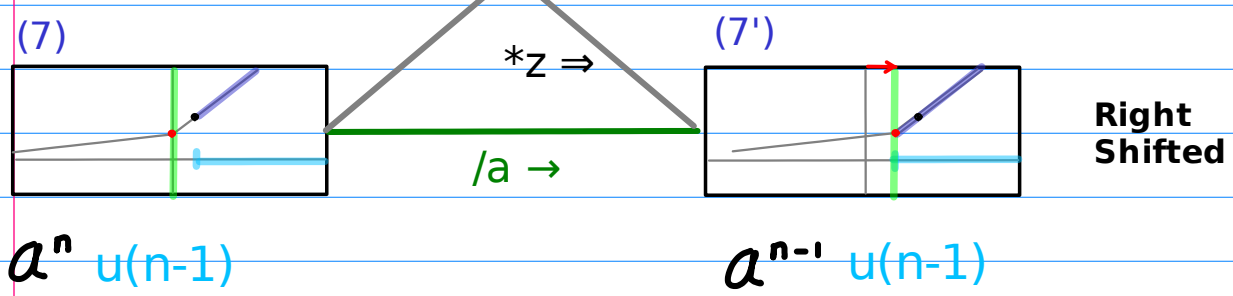
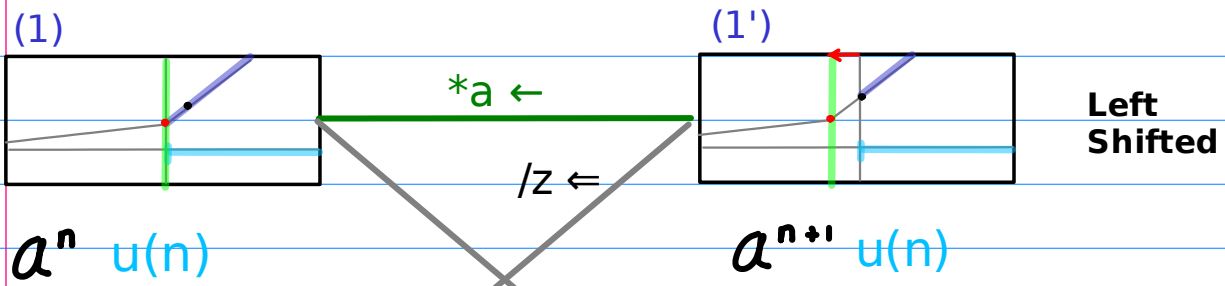

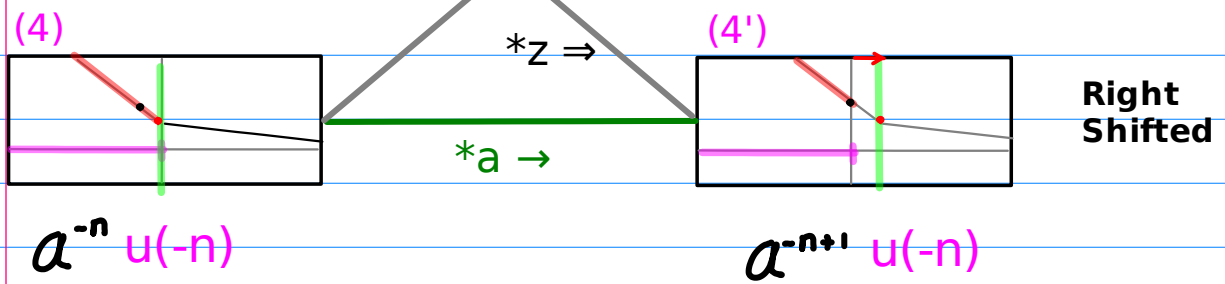
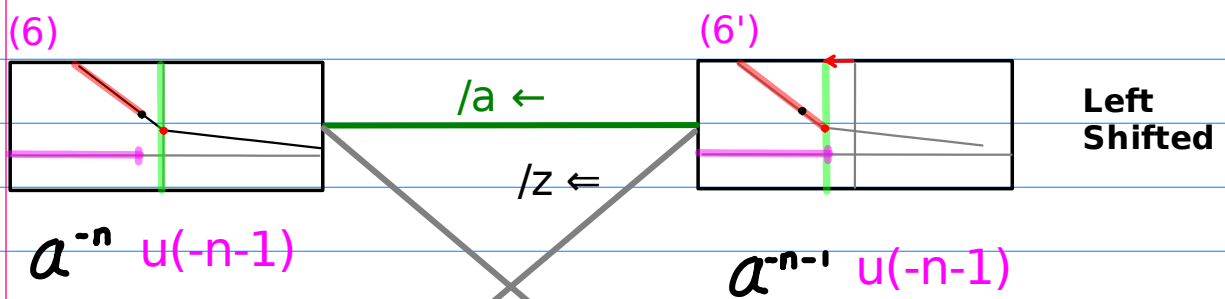
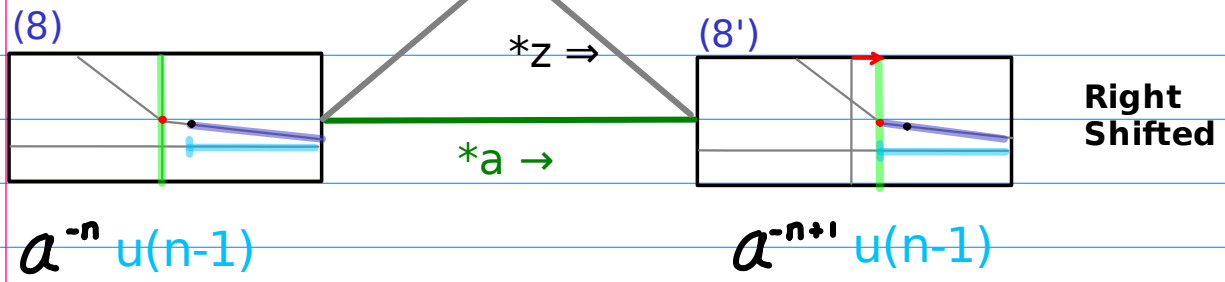
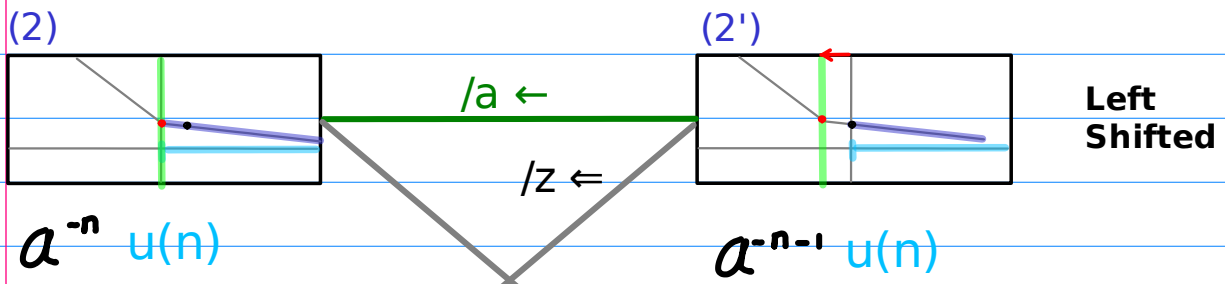

$$n \leftarrow -n$$

$$u(n) \leftrightarrow u(n-1)$$
$$u(-n) \leftrightarrow u(-n-1)$$

(1)

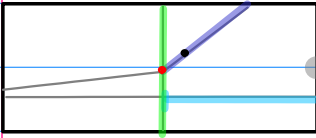

$$a^n u(n)$$

(8)

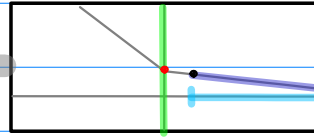

$$a^{-n} u(n-1)$$

Left
Shifted

(5)

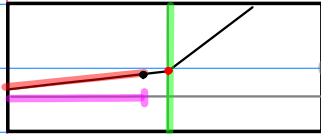

$$a^n u(-n-1)$$

(4)

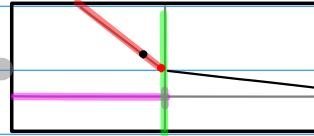

$$a^{-n} u(-n)$$

Left
Shifted

(7)

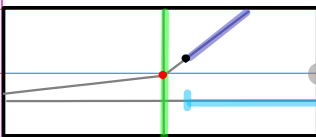

$$a^n u(n-1)$$

(2)

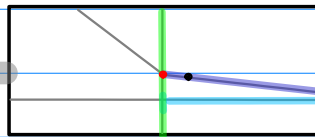

$$a^{-n} u(n)$$

Right
Shifted

(3)

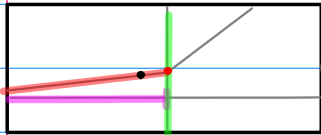

$$a^n u(-n)$$

(6)

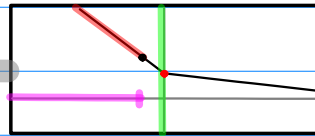

$$a^{-n} u(-n-1)$$

Right
Shifted

$$n \leftarrow -n$$

$$u(n) \leftrightarrow u(n-1)$$

$$u(-n) \leftrightarrow u(-n-1)$$

(1')

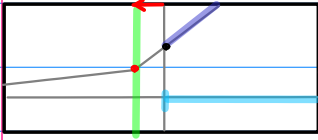

$$a^{n+1} u(n)$$

(8')

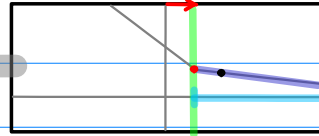

$$a^{-n+1} u(n-1)$$

(5')

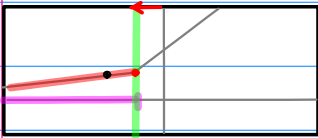

$$a^{n+1} u(-n-1)$$

(4')

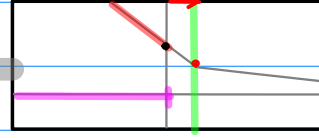

$$a^{-n+1} u(-n)$$

(7')

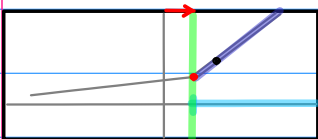

$$a^{n-1} u(n-1)$$

(2')

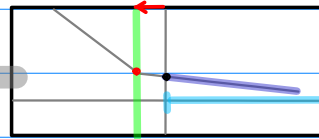

$$a^{-n-1} u(n)$$

(3')

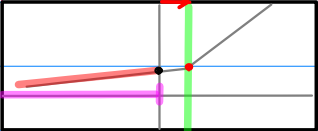

$$a^{n-1} u(-n)$$

(6')

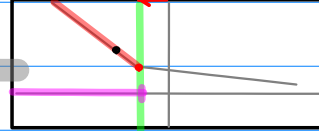

$$a^{-n-1} u(-n-1)$$



Time Reversal $-1, z^{-1}$

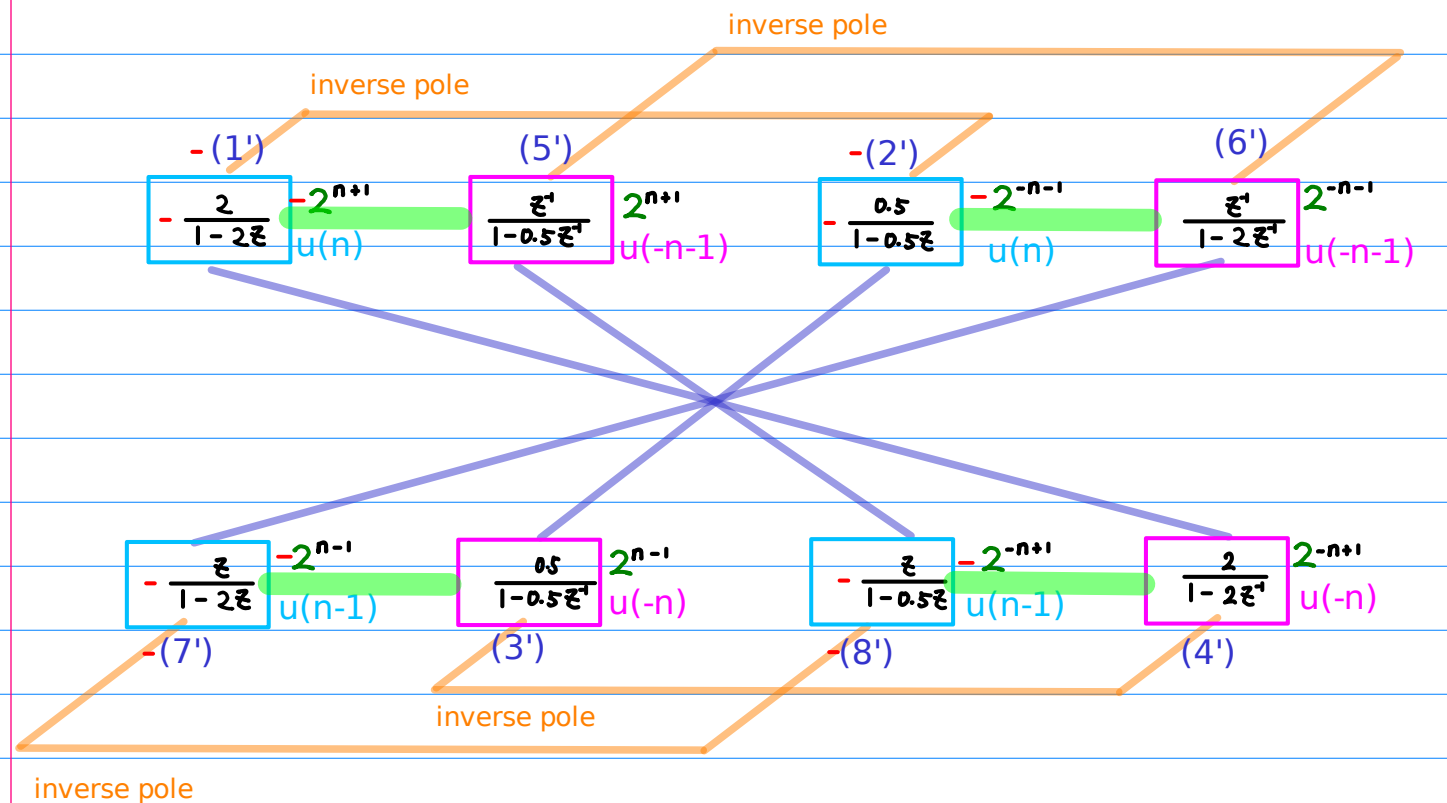
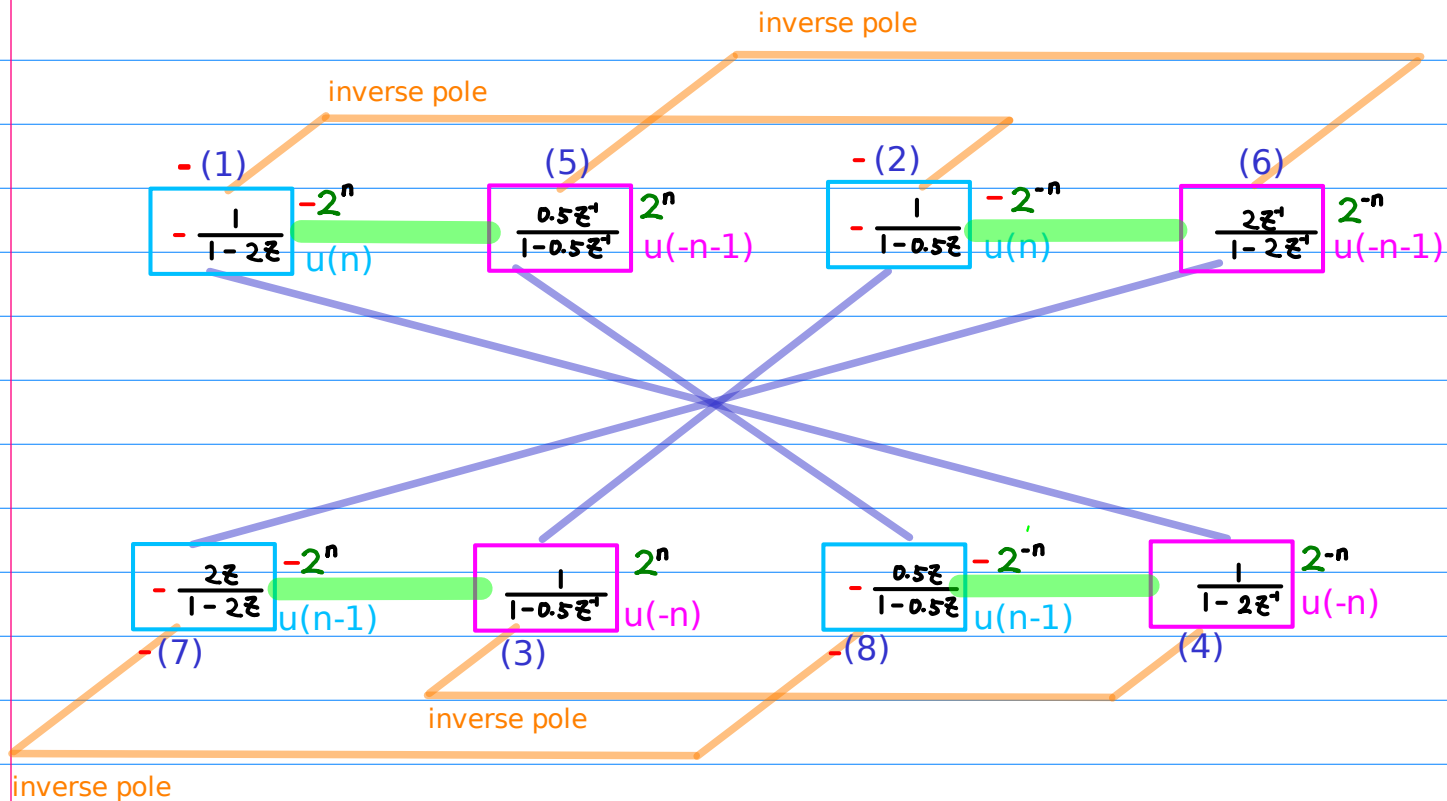

Time Reversal $-1, z^{-1}$

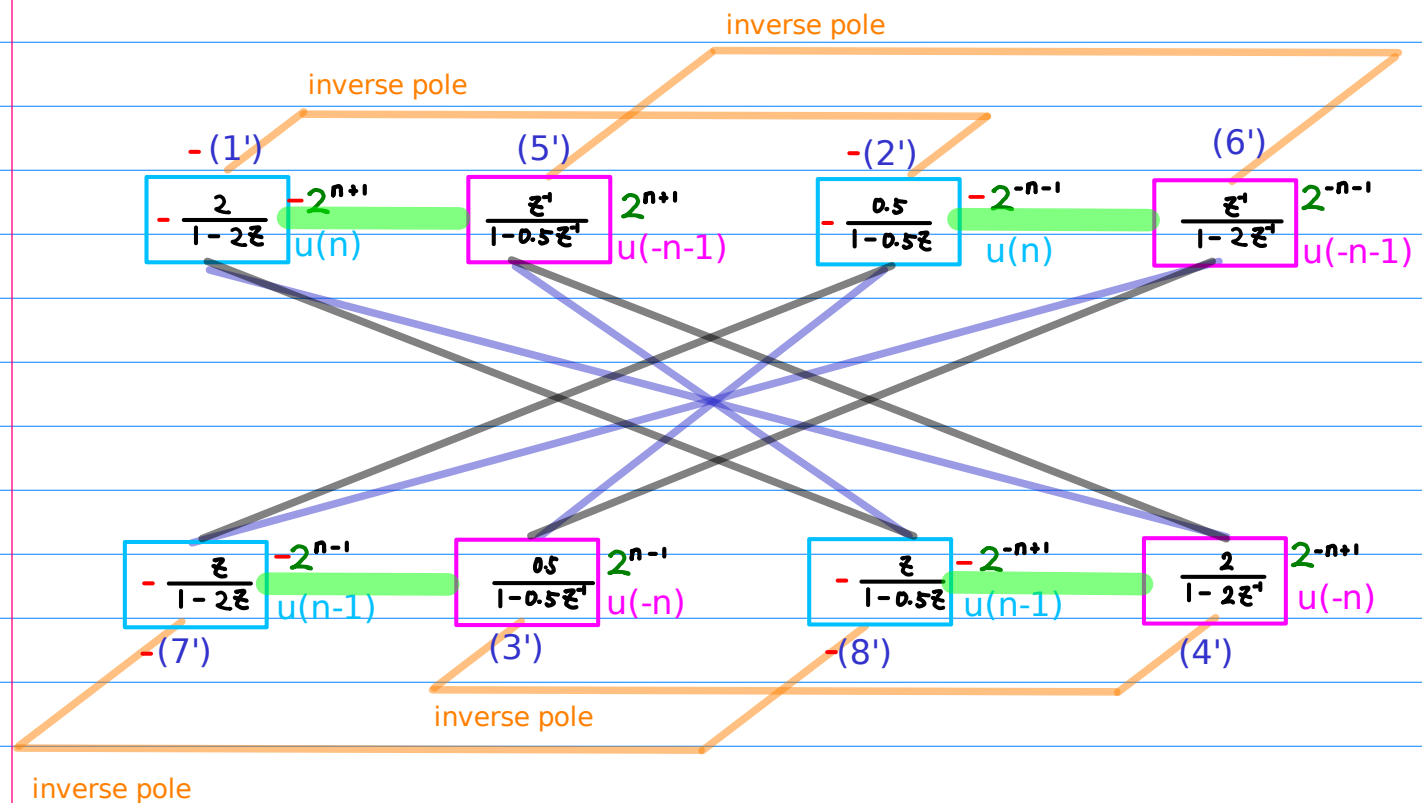
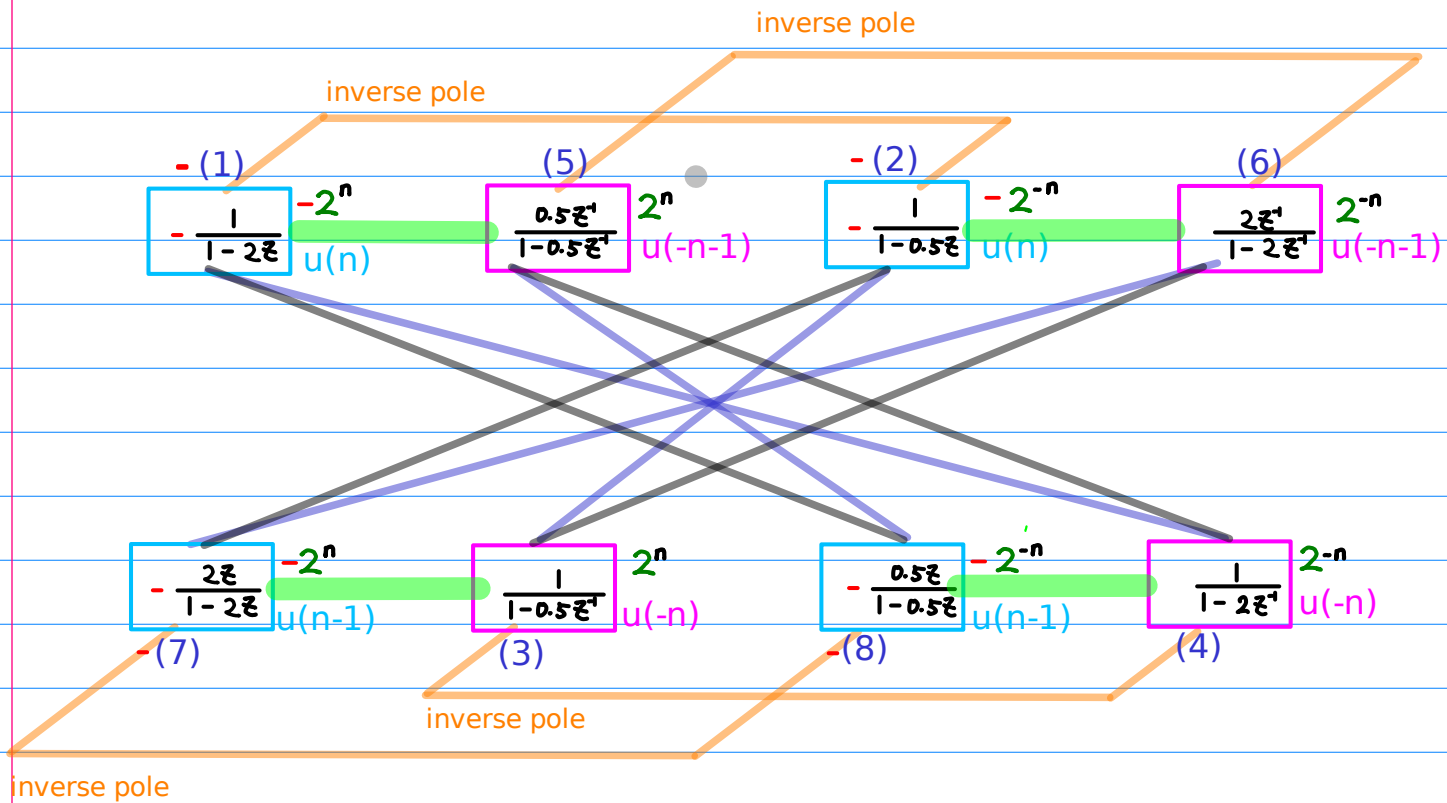

Time Reversal $-1, z^{-1}$

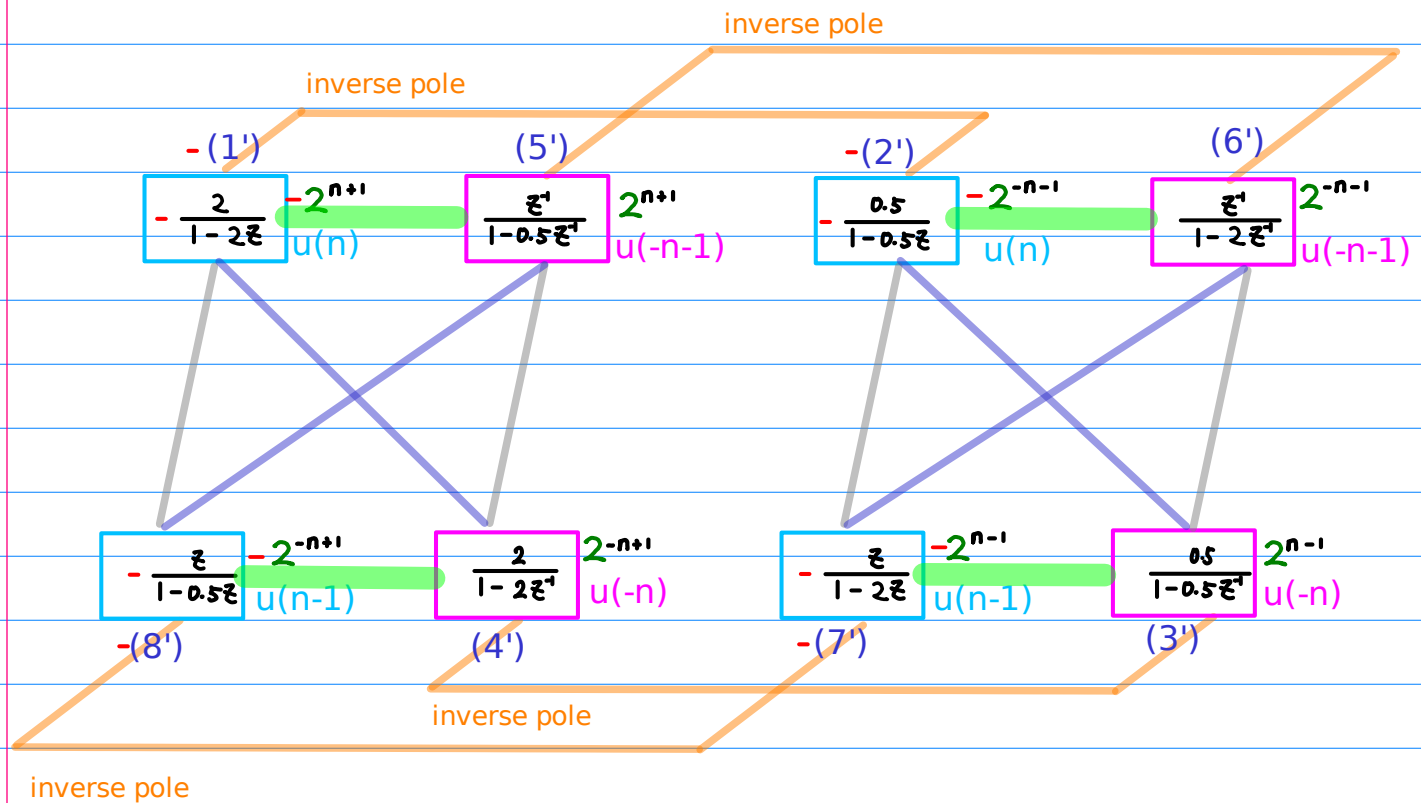
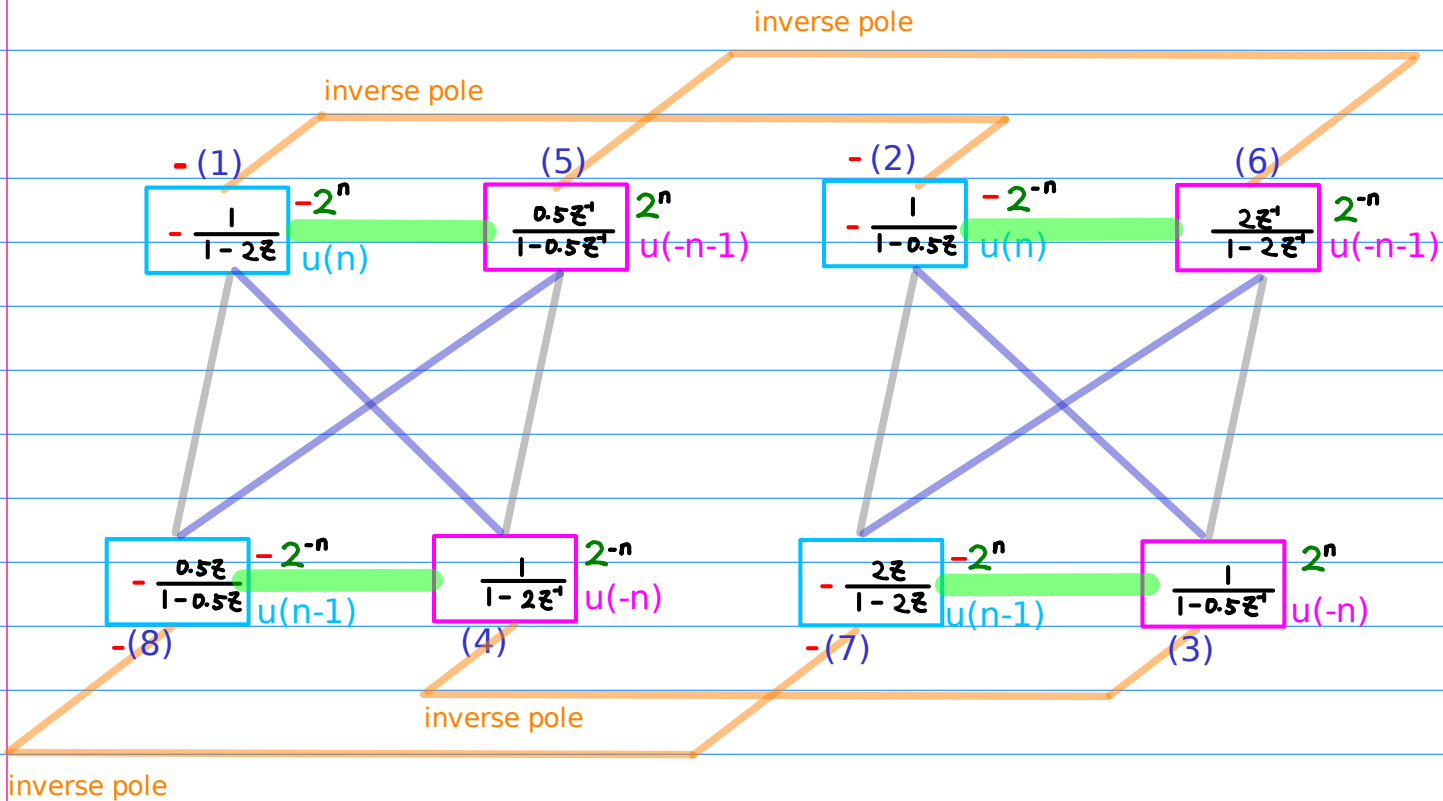

Time Reversal in z-Transform

Time reversal

$x[-n]$

$X(z^{-1})$

$$\begin{aligned} \mathcal{Z}\{x(-n)\} &= \sum_{n=-\infty}^{\infty} x(-n) z^{-n} \\ &= \sum_{m=-\infty}^{\infty} x(m) z^m \\ &= \sum_{m=-\infty}^{\infty} x(m) (z^{-1})^{-m} \\ &= X(z^{-1}) \end{aligned}$$

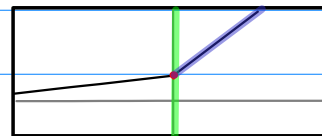
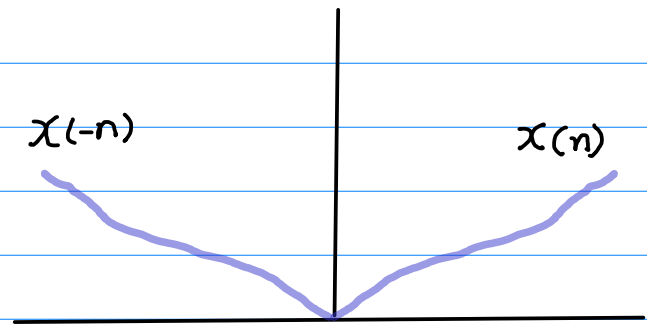

2^n
 $u(n)$

2^{-n}
 $u(-n)$

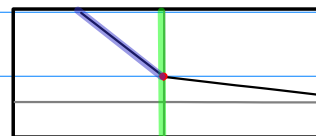

Reciprocal Pole and Shift Relations

$$P = 0.5$$

$$P = 2$$

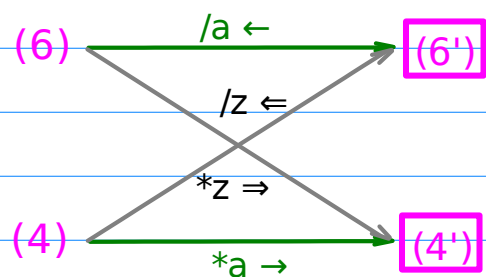
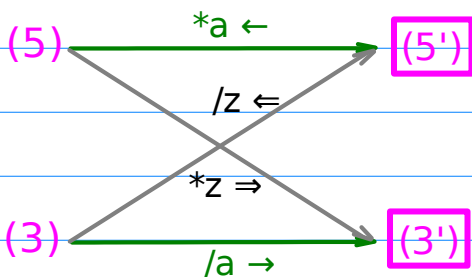
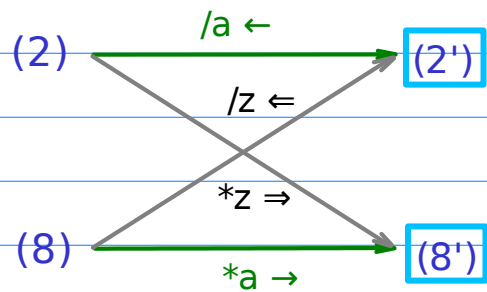
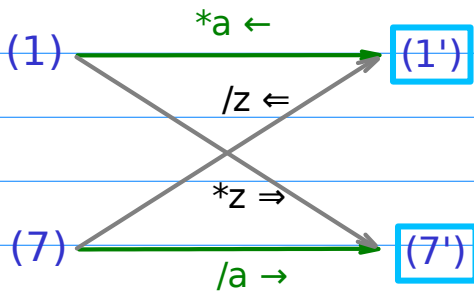
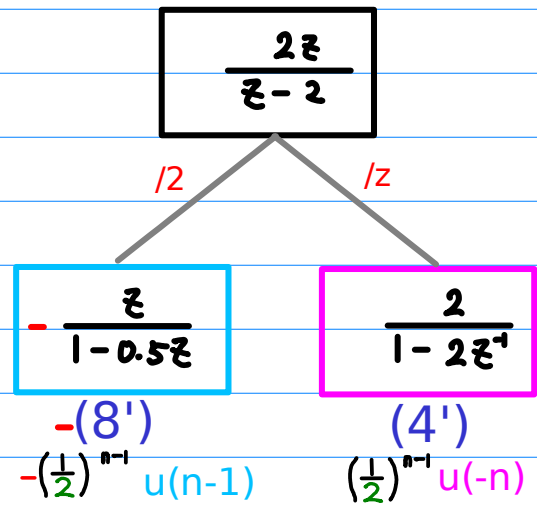
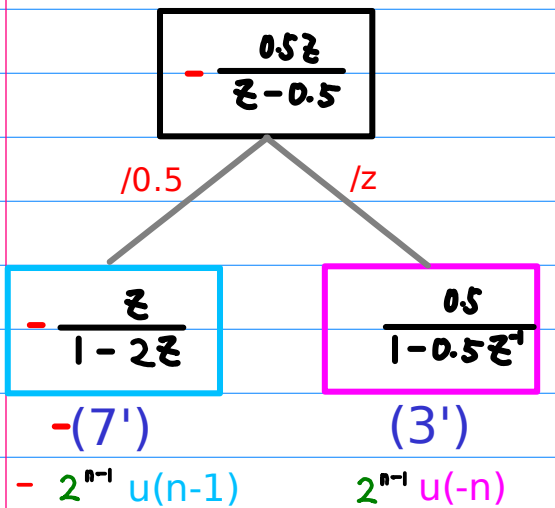
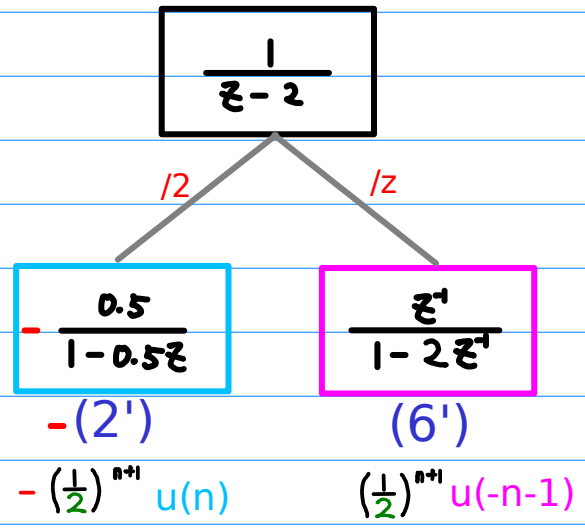
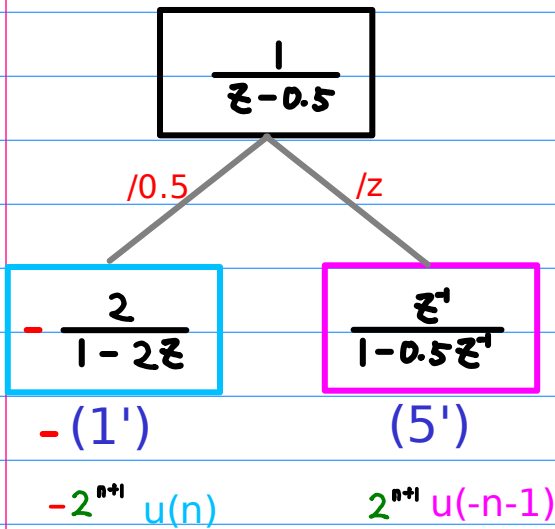

(1) (5) (2) (6)
(7) (3) (8) (4)

(1') (5') (2') (6')
(7') (3') (8') (4')

Partial fractions and geometric power series

$$\mathcal{P}^{-1} = 0.5$$
$$\mathcal{P} = 2$$

-(1)
$$-\frac{1}{1-2z}$$
$$-2^n u(n)$$

(5)
$$\frac{0.5z^{-1}}{1-0.5z^{-1}}$$
$$2^n u(-n-1)$$

-(2)
$$-\frac{1}{1-0.5z}$$
$$-2^{-n} u(n)$$

(6)
$$\frac{2z^{-1}}{1-2z^{-1}}$$
$$2^{-n} u(-n-1)$$

-(7)
$$-\frac{2z}{1-2z}$$
$$-2^n u(n-1)$$

(3)
$$\frac{1}{1-0.5z^{-1}}$$
$$2^n u(-n)$$

-(8)
$$-\frac{0.5z}{1-0.5z}$$
$$-2^{-n} u(n-1)$$

(4)
$$\frac{1}{1-2z^{-1}}$$
$$2^{-n} u(-n)$$

-(1')
$$-\frac{2}{1-2z}$$
$$-2^{n+1} u(n)$$

(5')
$$\frac{z^{-1}}{1-0.5z^{-1}}$$
$$2^{n+1} u(-n-1)$$

-(2')
$$-\frac{0.5}{1-0.5z}$$
$$-2^{-n-1} u(n)$$

(6')
$$\frac{z^{-1}}{1-2z^{-1}}$$
$$2^{-n-1} u(-n-1)$$

-(7')
$$-\frac{z}{1-2z}$$
$$-2^{n-1} u(n-1)$$

(3')
$$\frac{0.5}{1-0.5z^{-1}}$$
$$2^{n-1} u(-n)$$

-(8')
$$-\frac{z}{1-0.5z}$$
$$-2^{-n-1} u(n-1)$$

(4')
$$\frac{2}{1-2z^{-1}}$$
$$2^{-n-1} u(-n)$$

$$P^{-1} = 0.5$$

$$P = 2$$

(Exp, Range)

(1) $\frac{1}{1-2z}$ $\xrightarrow{*a \leftarrow}$ $\frac{2}{1-2z}$ (1')

$$\begin{array}{ccc} 2^n & \xrightarrow{(n \rightarrow n+1, id)} & 2^{n+1} \\ u(n) & & u(n) \end{array}$$

(7) $\frac{2z}{1-2z}$ $\xrightarrow{/z \leftarrow}$ $\frac{z}{1-2z}$ (7')

$$\begin{array}{ccc} 2^n & \xrightarrow{(n \rightarrow n+1, id)} & 2^{n+1} \\ u(n) & & u(n) \\ (id, n \rightarrow n+1) & & (n \rightarrow n-2, n \rightarrow n-1) \\ 2^n & \xrightarrow{(n \rightarrow n-1, id)} & 2^{n-1} \\ u(n-1) & & u(n-1) \end{array}$$

(5) $\frac{0.5z^1}{1-0.5z^1}$ $\xrightarrow{*a \leftarrow}$ $\frac{z^1}{1-0.5z^1}$ (5')

$$\begin{array}{ccc} 2^n & \xrightarrow{(n \rightarrow n+1, id)} & 2^{n+1} \\ u(-n-1) & & u(-n-1) \end{array}$$

(3) $\frac{1}{1-0.5z^1}$ $\xrightarrow{/a \rightarrow}$ $\frac{0.5}{1-0.5z^1}$ (3')

$$\begin{array}{ccc} 2^n & \xrightarrow{(n \rightarrow n+1, id)} & 2^{n+1} \\ u(-n) & & u(-n) \\ (id, n \rightarrow n+1) & & (n \rightarrow n-2, n \rightarrow n-1) \\ 2^n & \xrightarrow{(n \rightarrow n-1, id)} & 2^{n-1} \\ u(-n) & & u(-n) \end{array}$$

(2) $\frac{1}{1-0.5z}$ $\xrightarrow{/a \leftarrow}$ $\frac{0.5}{1-0.5z}$ (2')

$$\begin{array}{ccc} (\frac{1}{2})^n & \xrightarrow{(n \rightarrow n+1, id)} & (\frac{1}{2})^{n+1} \\ u(n) & & u(n) \end{array}$$

(8) $\frac{0.5z}{1-0.5z}$ $\xrightarrow{*z \Rightarrow}$ $\frac{z}{1-0.5z}$ (8')

$$\begin{array}{ccc} (\frac{1}{2})^n & \xrightarrow{(n \rightarrow n+1, id)} & (\frac{1}{2})^{n+1} \\ u(n-1) & & u(n-1) \\ (id, n \rightarrow n+1) & & (n \rightarrow n-2, n \rightarrow n-1) \\ (\frac{1}{2})^n & \xrightarrow{(n \rightarrow n-1, id)} & (\frac{1}{2})^{n-1} \\ u(n-1) & & u(n-1) \end{array}$$

(6) $\frac{2z^1}{1-2z^1}$ $\xrightarrow{/a \leftarrow}$ $\frac{z^1}{1-2z^1}$ (6')

$$\begin{array}{ccc} (\frac{1}{2})^n & \xrightarrow{(n \rightarrow n+1, id)} & (\frac{1}{2})^{n+1} \\ u(-n-1) & & u(-n-1) \end{array}$$

(4) $\frac{1}{1-2z^1}$ $\xrightarrow{/z \leftarrow}$ $\frac{2}{1-2z^1}$ (4')

$$\begin{array}{ccc} (\frac{1}{2})^n & \xrightarrow{(n \rightarrow n+1, id)} & (\frac{1}{2})^{n+1} \\ u(-n) & & u(-n) \\ (id, n \rightarrow n+1) & & (n \rightarrow n-2, n \rightarrow n-1) \\ (\frac{1}{2})^n & \xrightarrow{(n \rightarrow n-1, id)} & (\frac{1}{2})^{n-1} \\ u(-n) & & u(-n) \end{array}$$

$$P^{-1} = 0.5$$

$$P = 2$$

$$\frac{1}{1-2z} \xrightarrow[*a \leftarrow]{/z \leftarrow} \frac{2}{1-2z}$$

$$\frac{2z}{1-2z} \xrightarrow[*z \Rightarrow]{/a \rightarrow} \frac{z}{1-2z}$$

$$\frac{0.5z^{-1}}{1-0.5z^{-1}} \xrightarrow[*a \leftarrow]{/z \leftarrow} \frac{z^{-1}}{1-0.5z^{-1}}$$

$$\frac{1}{1-0.5z^{-1}} \xrightarrow[*z \Rightarrow]{/a \rightarrow} \frac{0.5}{1-0.5z^{-1}}$$

$$\frac{1}{1-0.5z} \xrightarrow[*a \leftarrow]{/z \leftarrow} \frac{0.5}{1-0.5z}$$

$$\frac{0.5z}{1-0.5z} \xrightarrow[*z \Rightarrow]{*a \rightarrow} \frac{z}{1-0.5z}$$

$$\frac{2z^{-1}}{1-2z^{-1}} \xrightarrow[*a \leftarrow]{/z \leftarrow} \frac{z^{-1}}{1-2z^{-1}}$$

$$\frac{1}{1-2z^{-1}} \xrightarrow[*z \Rightarrow]{/*} \frac{2}{1-2z^{-1}}$$

$$2^n u(n) \xrightarrow{(n \rightarrow n+1, n \rightarrow n+1)} 2^{n+1} u(n)$$

$$2^n u(n-1) \xrightarrow{(n \rightarrow n-1, n \rightarrow n-1)} 2^{n-1} u(n-1)$$

$$2^n u(n-1) \xrightarrow{(n \rightarrow n+1, n \rightarrow n+1)} 2^{n+1} u(n-1)$$

$$2^n u(n) \xrightarrow{(n \rightarrow n-1, n \rightarrow n-1)} 2^{n-1} u(n)$$

$$\left(\frac{1}{2}\right)^n u(n) \xrightarrow{(n \rightarrow n+1, n \rightarrow n+1)} \left(\frac{1}{2}\right)^{n+1} u(n)$$

$$\left(\frac{1}{2}\right)^n u(n-1) \xrightarrow{(n \rightarrow n-1, n \rightarrow n-1)} \left(\frac{1}{2}\right)^{n-1} u(n-1)$$

$$\left(\frac{1}{2}\right)^n u(n-1) \xrightarrow{(n \rightarrow n+1, n \rightarrow n+1)} \left(\frac{1}{2}\right)^{n+1} u(n-1)$$

$$\left(\frac{1}{2}\right)^n u(n) \xrightarrow{(n \rightarrow n-1, n \rightarrow n-1)} \left(\frac{1}{2}\right)^{n-1} u(n)$$



Shifting Geometric Series (1) positive exponent

Negative Exponent $a=2$ /z $n \leftarrow n+1$ *z $n \leftarrow n-1$

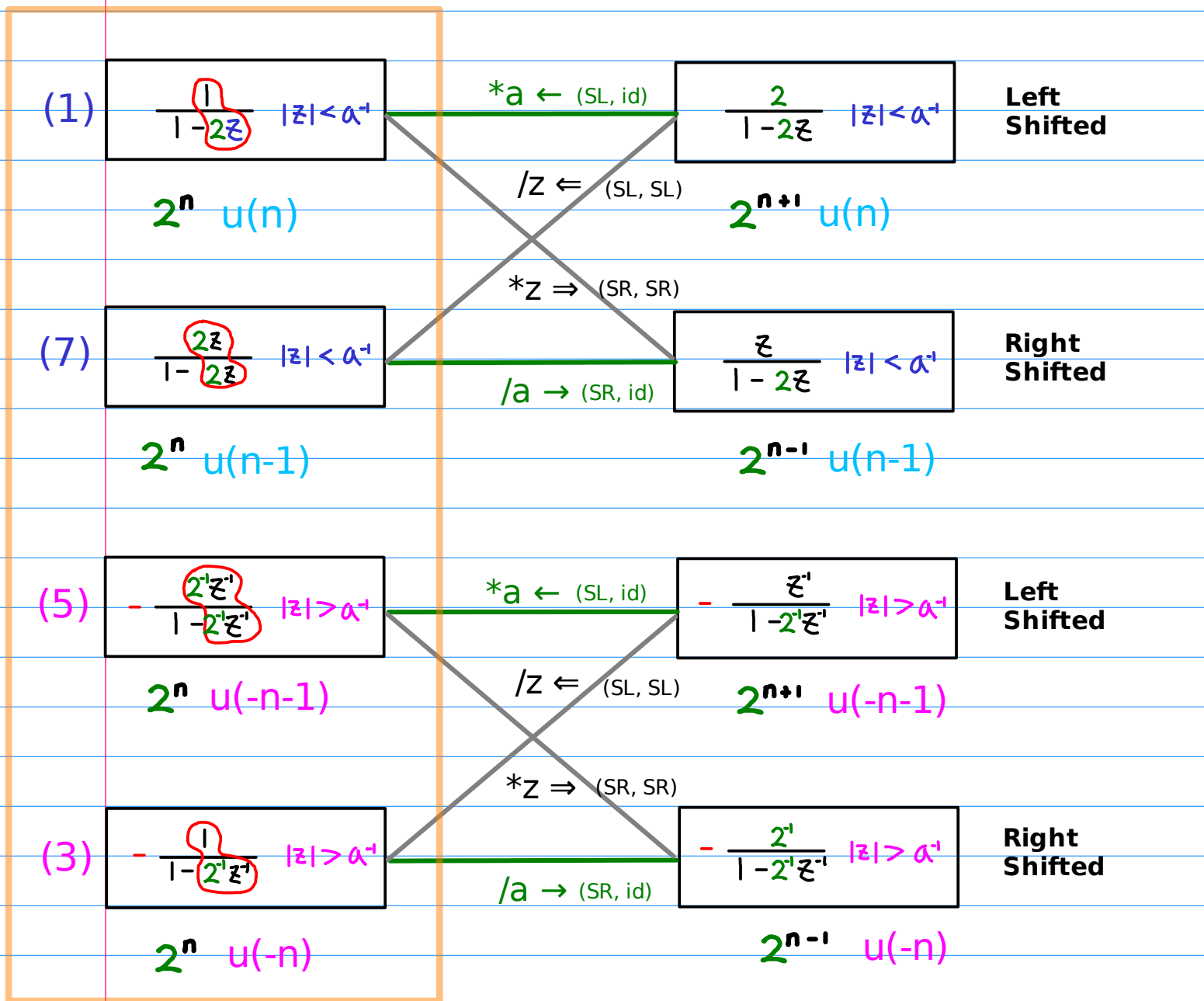

Causal	$u(n)$	(1)	(2)	butterfly pair ordering
	$u(n-1)$	(7)	(8)	
Anti-Causal	$u(-n-1)$	(5)	(6)	
	$u(-n)$	(3)	(4)	

Shifting Geometric Series (2) negative exponent

Negative Exponent $a^{-1} = z^{-1}$ $/z \leftarrow n \leftarrow n+1$ $*z \rightarrow n \leftarrow n-1$

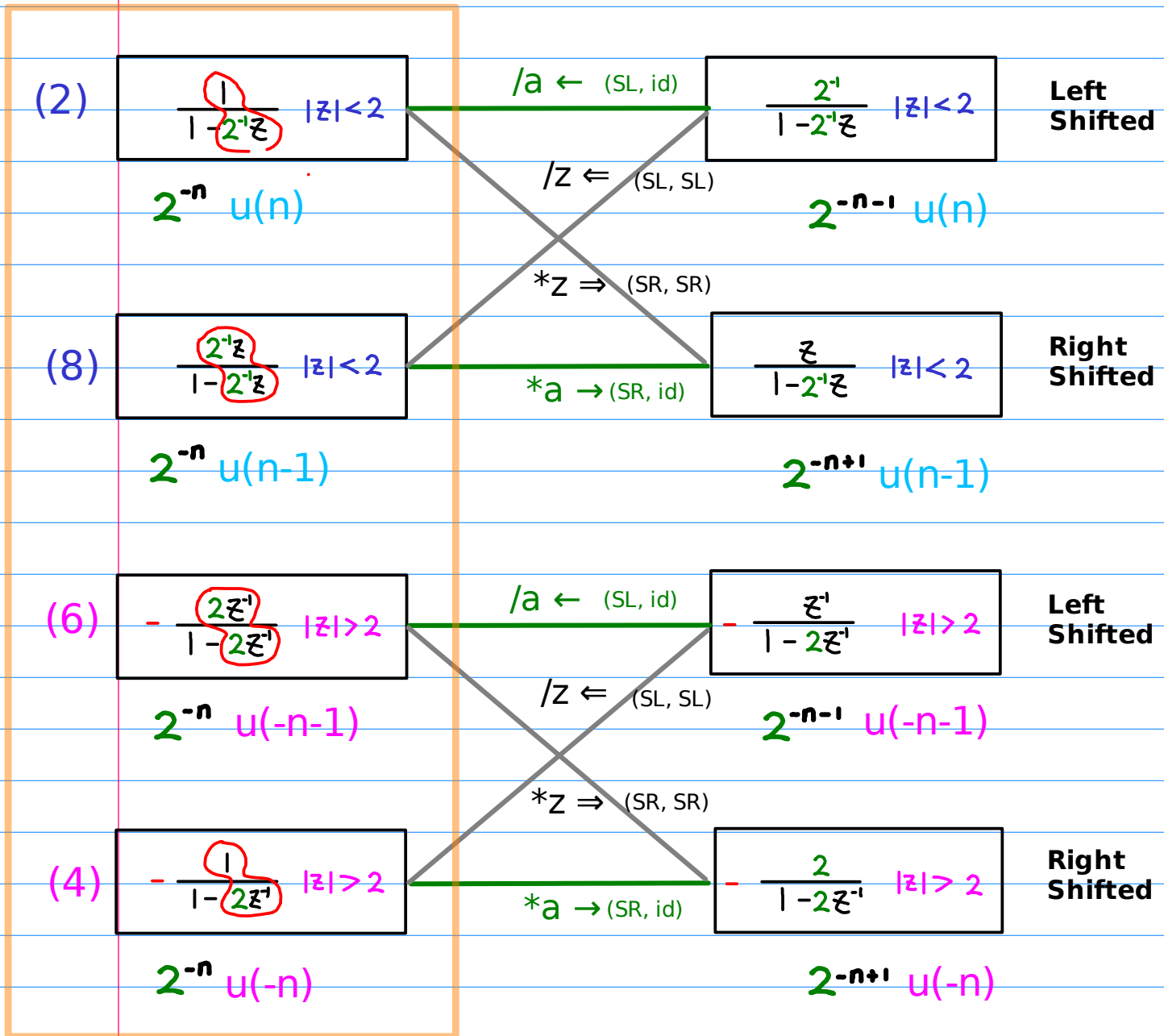

Causal	$u(n)$	(1)	(2)
	$u(n-1)$	(7)	(8)
Anti-Causal	$u(-n-1)$	(5)	(6)
	$u(-n)$	(3)	(4)

butterfly pair ordering

$a=2$

(1) (2)
(3) (4)

Unshifted combinations

$\mathcal{P}_1 = 0.5$

$a^{-1}=2^{-1}$

(5) (6)
(7) (8)

including the origin

$\mathcal{P}_2 = 2$

$a=2$

$a^{-1}=2^{-1}$

(1)

$f(z) = \frac{1}{1-2z}$	$ z < 2^{-1}$
$2^n u(n)$	$(n \geq 0)$

(2)

$g(z) = \frac{1}{1-2^{-1}z}$	$ z < 2$
$(\frac{1}{2})^n u(n)$	$(n \geq 0)$

(3)

$\bar{f}_1(z) = \frac{1}{1-2^{-1}z^{-1}}$	$ z > 2^{-1}$
$2^n u(-n)$	$(n < 0)$

(4)

$\bar{g}_1(z) = \frac{1}{1-2z^{-1}}$	$ z > 2$
$(\frac{1}{2})^n u(-n)$	$(n < 0)$

(5)

$\bar{f}(z) = \frac{2^{-1}z^{-1}}{1-2^{-1}z^{-1}}$	$ z > 2^{-1}$
$2^n u(-n-1)$	$(n < 0)$

(6)

$\bar{g}(z) = \frac{2z^{-1}}{1-2z^{-1}}$	$ z > 2$
$(\frac{1}{2})^n u(-n-1)$	$(n < 0)$

(7)

$f_1(z) = \frac{2z}{1-2z}$	$ z < 2^{-1}$
$2^n u(n-1)$	$(n \geq 1)$

(8)

$g_1(z) = \frac{2^{-1}z}{1-2^{-1}z}$	$ z < 2$
$(\frac{1}{2})^n u(n-1)$	$(n \geq 1)$

$a=2$

$(1') (2')$
 $(3') (4')$

Shifted combinations

$P_1 = 0.5$

$a^{-1}=2^{-1}$

$(5') (6')$
 $(7') (8')$

excluding the origin

$P_2 = 2$

$a=2$

$a^{-1}=2^{-1}$

(1')

(2')

$2z$

$f_2(z) = \frac{2}{1-2z}$	$ z < 2^{-1}$
$2^{n+1} u(n)$	$(n \geq 0)$

$2^{-1}z$

$g_2(z) = \frac{2^{-1}}{1-2^{-1}z}$	$ z < 2$
$(\frac{1}{2})^{n+1} u(n)$	$(n \geq 0)$

(3')

(4')

$2^{-1}z^{-1}$

$\bar{f}_3(z) = \frac{2^{-1}}{1-2^{-1}z^{-1}}$	$ z > 2^{-1}$
$2^{n+1} u(-n)$	$(n < 0)$

$2z^{-1}$

$\bar{g}_3(z) = \frac{2}{1-2z^{-1}}$	$ z > 2$
$(\frac{1}{2})^{n+1} u(-n)$	$(n < 0)$

(5')

(6')

$2^{-1}z^{-1}$

$\bar{f}_2(z) = \frac{z^{-1}}{1-2^{-1}z^{-1}}$	$ z > 2^{-1}$
$2^{n+1} u(-n-1)$	$(n < 0)$

$2z^{-1}$

$\bar{g}_2(z) = \frac{z^{-1}}{1-2z^{-1}}$	$ z > 2$
$(\frac{1}{2})^{n+1} u(-n-1)$	$(n < 0)$

(7')

(8')

$2z$

$f_3(z) = \frac{z}{1-2z}$	$ z < 2^{-1}$
$2^{n+1} u(n-1)$	$(n \geq 1)$

$2^{-1}z$

$g_3(z) = \frac{z}{1-2^{-1}z}$	$ z < 2$
$(\frac{1}{2})^{n+1} u(n-1)$	$(n \geq 1)$



(1') (2')
(1) (2)

Geometric series for unshifted combinations

$$-\frac{3}{2} \frac{1}{(z-0.5)(z-2)}$$

(5') (6')
(5) (6)

$$a=2$$

$$a^{-1}=2^{-1}$$

(1')

$f_2(z) = \frac{2}{1-2z}$	$ z < 2^{-1}$
$2^{n+1} u(n)$	$(n \geq 0)$

(2')

$g_2(z) = \frac{2^{-1}}{1-2^{-1}z}$	$ z < 2$
$(\frac{1}{2})^{n+1} u(n)$	$(n \geq 0)$

(1)

$f(z) = \frac{1}{1-2z}$	$ z < 2^{-1}$
$2^n u(n)$	$(n \geq 0)$

(2)

$g(z) = \frac{1}{1-2^{-1}z}$	$ z < 2$
$(\frac{1}{2})^n u(n)$	$(n \geq 0)$

(5')

$\bar{f}_2(z) = \frac{z^{-1}}{1-2^{-1}z^{-1}}$	$ z > 2^{-1}$
$2^{n+1} u(-n-1)$	$(n < 0)$

(6')

$\bar{g}_2(z) = \frac{z^{-1}}{1-2z^{-1}}$	$ z > 2$
$(\frac{1}{2})^{n+1} u(-n-1)$	$(n < 0)$

(5)

$\bar{f}(z) = \frac{2^{-1}z^{-1}}{1-2^{-1}z^{-1}}$	$ z > 2^{-1}$
$2^n u(-n-1)$	$(n < 0)$

(6)

$\bar{g}(z) = \frac{2z^{-1}}{1-2z^{-1}}$	$ z > 2$
$(\frac{1}{2})^n u(-n-1)$	$(n < 0)$

(7') (8')
(7) (8)

Geometric series for unshifted combinations

$$-\frac{3}{2} \frac{z^2}{(z-0.5)(z-2)}$$

(3') (4')
(3) (4)

$a=2$

(7')

$f_3(z) = \frac{z}{1-2z}$	$ z < 2'$
$2^{n-1} u(n-1)$	$(n \geq 1)$

(7)

$f_1(z) = \frac{2z}{1-2z}$	$ z < 2'$
$2^n u(n-1)$	$(n \geq 1)$

(3')

$\bar{f}_3(z) = \frac{z^{-1}}{1-2z^{-1}}$	$ z > 2'$
$2^{n-1} u(-n)$	$(n < 1)$

(3)

$\bar{f}_1(z) = \frac{1}{1-2z^{-1}}$	$ z > 2'$
$2^n u(-n)$	$(n < 1)$

$a^{-1}=2^{-1}$

(8')

$g_3(z) = \frac{z}{1-2^{-1}z}$	$ z < 2$
$(\frac{1}{2})^{n-1} u(n-1)$	$(n \geq 1)$

(8)

$g_1(z) = \frac{2^{-1}z}{1-2^{-1}z}$	$ z < 2$
$(\frac{1}{2})^n u(n-1)$	$(n \geq 1)$

(4')

$\bar{g}_3(z) = \frac{2}{1-2z^{-1}}$	$ z > 2$
$(\frac{1}{2})^{n-1} u(-n)$	$(n < 1)$

(4)

$\bar{g}_1(z) = \frac{1}{1-2z^{-1}}$	$ z > 2$
$(\frac{1}{2})^n u(-n)$	$(n < 1)$

$$\frac{3}{2} \frac{-1}{(z-0.5)(z-2)} = \left(\frac{1}{z-0.5} - \frac{1}{z-2} \right)$$

Case A $|z| < 0.5$

$$-\frac{3}{2} \frac{1}{(z-0.5)(z-2)}$$

$$\frac{3}{2} \frac{-1}{(z-0.5)(z-2)} = \left(\frac{1}{z-0.5} - \frac{1}{z-2} \right)$$

Simple Pole Form

$$\frac{1}{z-0.5}$$

$$\frac{1}{z-2}$$

Geometric Power Series Forms

$$-\frac{2}{1-2z}$$

$$-\frac{0.5}{1-0.5z}$$

$|z| < 0.5$

$|z| < 0.5$

$|z| < 2$



=

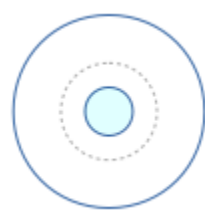

∩

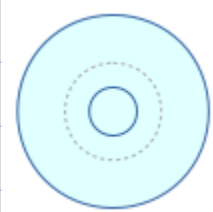

$$-2^{n+1} u(n)$$

$$-\left(\frac{1}{2}\right)^{n+1} u(n)$$

$|z| < 0.5$

$$f(z) = -\frac{2}{1-2z} + \frac{0.5}{1-0.5z}$$

$$-2^{n+1} u(n) + \left(\frac{1}{2}\right)^{n+1} u(n)$$

(1')

$f_2(z) = \frac{2}{1-2z}$	$ z < 2$
$2^{n+1} u(n)$	$(n \geq 0)$

(2')

$g_2(z) = \frac{2^1}{1-2^1 z}$	$ z < 2$
$\left(\frac{1}{2}\right)^{n+1} u(n)$	$(n \geq 0)$

(1)

$f(z) = \frac{1}{1-2z}$	$ z < 2$
$2^n u(n)$	$(n \geq 0)$

(2)

$g(z) = \frac{1}{1-2^1 z}$	$ z < 2$
$\left(\frac{1}{2}\right)^n u(n)$	$(n \geq 0)$

Case B $0.5 < |z| < 2$

$$-\frac{3}{2} \frac{1}{(z-0.5)(z-2)}$$

$$\frac{3}{2} \frac{-1}{(z-0.5)(z-2)} = \left(\frac{1}{z-0.5} - \frac{1}{z-2} \right)$$

Simple Pole Form

$$\frac{1}{z-0.5}$$

$$\frac{1}{z-2}$$

Geometric Power Series Forms

$$\frac{z^{-1}}{1-0.5z^{-1}}$$

$$-\frac{0.5}{1-0.5z}$$

$0.5 < |z| < 2$

$0.5 < |z|$

$|z| < 2$



=

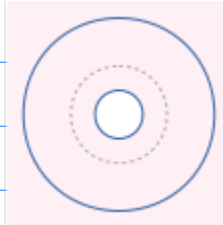

∩

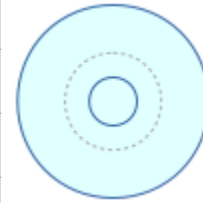

$$2^{n+1} u(-n-1)$$

$$-\left(\frac{1}{2}\right)^{n+1} u(n)$$

$$0.5 < |z| < 2 \quad f(z) = \frac{z^{-1}}{1-0.5z^{-1}} + \frac{0.5}{1-0.5z} \quad 2^{n+1} u(-n-1) + \left(\frac{1}{2}\right)^{n+1} u(n)$$

(5')

$$\bar{f}_2(z) = \frac{z^{-1}}{1-2^{-1}z^{-1}} \quad |z| > 2^{-1}$$

$$2^{n+1} u(-n-1) \quad (n < 0)$$

(2')

$$g_2(z) = \frac{2^{-1}}{1-2^{-1}z} \quad |z| < 2$$

$$\left(\frac{1}{2}\right)^{n+1} u(n) \quad (n \geq 0)$$

(5)

$$\bar{f}(z) = \frac{2^{-1}z^{-1}}{1-2^{-1}z^{-1}} \quad |z| > 2^{-1}$$

$$2^n u(-n-1) \quad (n < 0)$$

(2)

$$g(z) = \frac{1}{1-2^{-1}z} \quad |z| < 2$$

$$\left(\frac{1}{2}\right)^n u(n) \quad (n \geq 0)$$

Case C $2 < |z|$

$$-\frac{3}{2} \frac{1}{(z-0.5)(z-2)}$$

$$\frac{3}{2} \frac{-1}{(z-0.5)(z-2)} = \left(\frac{1}{z-0.5} - \frac{1}{z-2} \right)$$

Simple Pole Form

$$\frac{1}{z-0.5}$$

$$\frac{1}{z-2}$$

Geometric Power Series Forms

$$\frac{z^{-1}}{1-0.5z^{-1}}$$

$$\frac{z^{-1}}{1-2z^{-1}}$$

$2 < |z|$

$0.5 < |z|$

$2 < |z|$

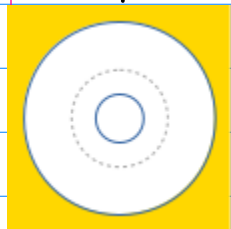

=

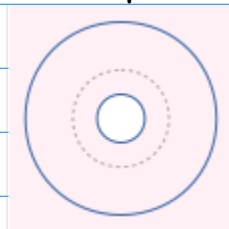

∩

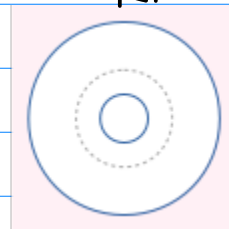

$$2^{n+1} u(-n-1)$$

$$\left(\frac{1}{2}\right)^{n+1} u(-n-1)$$

$2 < |z|$

$$f(z) = \frac{z^{-1}}{1-0.5z^{-1}} - \frac{z^{-1}}{1-2z^{-1}}$$

$$2^{n+1} u(-n-1) - \left(\frac{1}{2}\right)^{n+1} u(-n-1)$$

(5')

$$\bar{f}_2(z) = \frac{z^{-1}}{1-2^{-1}z^{-1}} \quad |z| > 2^{-1}$$

$$2^{n+1} u(-n-1) \quad (n < 0)$$

(6')

$$\bar{g}_2(z) = \frac{z^{-1}}{1-2z^{-1}} \quad |z| > 2$$

$$\left(\frac{1}{2}\right)^{n+1} u(-n-1) \quad (n < 0)$$

(5)

$$\bar{f}(z) = \frac{2^{-1}z^{-1}}{1-2^{-1}z^{-1}} \quad |z| > 2^{-1}$$

$$2^n u(-n-1) \quad (n < 0)$$

(6)

$$\bar{g}(z) = \frac{2z^{-1}}{1-2z^{-1}} \quad |z| > 2$$

$$\left(\frac{1}{2}\right)^n u(-n-1) \quad (n < 0)$$

Laurent Series and z Transform

$$-\frac{3}{2} \frac{1}{(z-0.5)(z-2)}$$

$$\frac{3}{2} \frac{-1}{(z-0.5)(z-2)} = \left(\frac{1}{z-0.5} - \frac{1}{z-2} \right)$$

$$|z| < 0.5 \quad f(z) = -\frac{2}{1-2z} + \frac{0.5}{1-0.5z}$$

Laurent Series

$$-2^{n+1} u(n) + \left(\frac{1}{2}\right)^{n+1} u(n)$$

z Transform

$$-2^{n+1} u(-n) + \left(\frac{1}{2}\right)^{-n+1} u(-n) \\ -\left(\frac{1}{2}\right)^{n-1} u(-n) + 2^{n-1} u(-n)$$

$$0.5 < |z| < 2 \quad f(z) = \frac{z^{-1}}{1-0.5z^{-1}} + \frac{0.5}{1-0.5z}$$

Laurent Series

$$2^{n+1} u(-n-1) + \left(\frac{1}{2}\right)^{n+1} u(n)$$

z Transform

$$2^{n+1} u(n-1) + \left(\frac{1}{2}\right)^{-n+1} u(-n) \\ \left(\frac{1}{2}\right)^{n-1} u(n-1) + 2^{n-1} u(-n)$$

$$2 < |z| \quad f(z) = \frac{z^{-1}}{1-0.5z^{-1}} - \frac{z^{-1}}{1-2z^{-1}}$$

Laurent Series

$$2^{n+1} u(-n-1) - \left(\frac{1}{2}\right)^{n+1} u(-n-1)$$

z Transform

$$2^{n+1} u(n-1) - \left(\frac{1}{2}\right)^{-n+1} u(n-1) \\ \left(\frac{1}{2}\right)^{n-1} u(n-1) + 2^{n-1} u(n-1)$$

$$-\frac{3}{2} \frac{z^2}{(z-0.5)(z-2)} = \left(\frac{0.5z}{z-0.5} - \frac{2z}{z-2} \right)$$

Case A $|z| < 0.5$

$$-\frac{3}{2} \frac{z^2}{(z-0.5)(z-2)}$$

$$-\frac{3}{2} \frac{z^2}{(z-0.5)(z-2)} = \left(\frac{0.5z}{z-0.5} - \frac{2z}{z-2} \right)$$

Simple Pole Form

$$\frac{0.5z}{z-0.5}$$

$$\frac{2z}{z-2}$$

Geometric Power Series Forms

$$-\frac{z}{1-2z}$$

$$-\frac{z}{1-0.5z}$$

$|z| < 0.5$

$|z| < 0.5$

$|z| < 2$



=

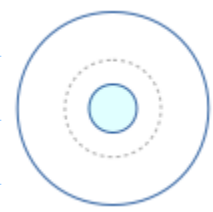

∩

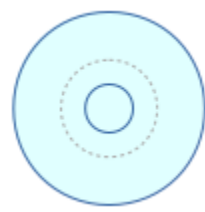

$$-2^{n-1} u(n)$$

$$-\left(\frac{1}{2}\right)^{n-1} u(n)$$

$|z| < 0.5$

$$f(z) = -\frac{z}{1-2z} + \frac{z}{1-0.5z}$$

$$-2^{n-1} u(n) + \left(\frac{1}{2}\right)^{n-1} u(n)$$

(7')

$$f_3(z) = \frac{z}{1-2z} \quad |z| < 2'$$

$$2^{n-1} u(n-1) \quad (n \geq 1)$$

(8')

$$g_3(z) = \frac{z}{1-2^{-1}z} \quad |z| < 2$$

$$\left(\frac{1}{2}\right)^{n-1} u(n-1) \quad (n \geq 1)$$

(7)

$$f_1(z) = \frac{2z}{1-2z} \quad |z| < 2'$$

$$2^n u(n-1) \quad (n \geq 1)$$

(8)

$$g_1(z) = \frac{2^{-1}z}{1-2^{-1}z} \quad |z| < 2$$

$$\left(\frac{1}{2}\right)^n u(n-1) \quad (n \geq 1)$$

Case B $0.5 < |z| < 2$

$$-\frac{3}{2} \frac{z^2}{(z-0.5)(z-2)}$$

$$-\frac{3}{2} \frac{z^2}{(z-0.5)(z-2)} = \left(\frac{0.5z}{z-0.5} - \frac{2z}{z-2} \right)$$

Simple Pole Form

$$\frac{0.5z}{z-0.5}$$

$$\frac{2z}{z-2}$$

Geometric Power Series Forms

$$\frac{0.5}{1-0.5z^{-1}}$$

$$-\frac{z}{1-0.5z}$$

$0.5 < |z| < 2$

$0.5 < |z|$

$|z| < 2$



=

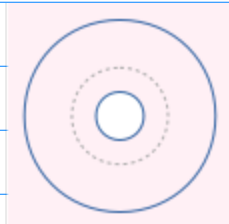

∩

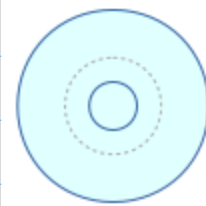

$$2^{n-1} u(-n-1)$$

$$-\left(\frac{1}{2}\right)^{n-1} u(n)$$

$$0.5 < |z| < 2 \quad f(z) = \frac{0.5}{1-0.5z^{-1}} + \frac{z}{1-0.5z} \quad 2^{n-1} u(-n-1) + \left(\frac{1}{2}\right)^{n-1} u(n)$$

(3')

$$\bar{f}_3(z) = \frac{z^{-1}}{1-z^{-1}z^{-1}} \quad |z| > 2^{-1}$$

$$2^{n-1} u(-n) \quad (n < 1)$$

(8')

$$g_3(z) = \frac{z}{1-2^{-1}z} \quad |z| < 2$$

$$\left(\frac{1}{2}\right)^{n-1} u(n-1) \quad (n \geq 1)$$

(3)

$$\bar{f}_1(z) = \frac{1}{1-2^{-1}z^{-1}} \quad |z| > 2^{-1}$$

$$2^n u(-n) \quad (n < 1)$$

(8)

$$g_1(z) = \frac{2^{-1}z}{1-2^{-1}z} \quad |z| < 2$$

$$\left(\frac{1}{2}\right)^n u(n-1) \quad (n \geq 1)$$

Case C $2 < |z|$

$$-\frac{3}{2} \frac{z^2}{(z-0.5)(z-2)}$$

$$-\frac{3}{2} \frac{z^2}{(z-0.5)(z-2)} = \left(\frac{0.5z}{z-0.5} - \frac{2z}{z-2} \right)$$

Simple Pole Form

$$\frac{0.5z}{z-0.5}$$

$$\frac{2z}{z-2}$$

Geometric Power Series Forms

$$\frac{0.5}{1-0.5z^{-1}}$$

$$\frac{2}{1-2z^{-1}}$$

$2 < |z|$

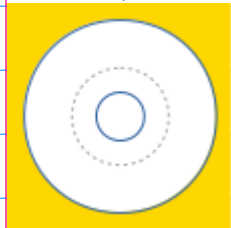

=

$0.5 < |z|$

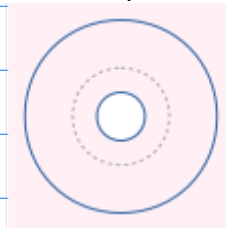

∩

$2 < |z|$

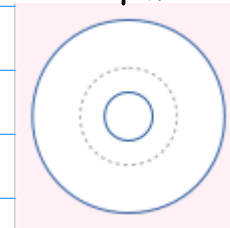

$$2^{n-1} u(-n-1)$$

$$\left(\frac{1}{2}\right)^{n-1} u(-n-1)$$

$2 < |z|$

$$f(z) = \frac{0.5}{1-0.5z^{-1}} - \frac{2}{1-2z^{-1}}$$

$$2^{n-1} u(-n-1) - \left(\frac{1}{2}\right)^{n-1} u(-n-1)$$

(3')

$$\bar{f}_3(z) = \frac{2^n}{1-2^{-n}z^{-1}} \quad |z| > 2^n$$

$$2^{n-1} u(-n) \quad (n < 1)$$

(4')

$$\bar{g}_3(z) = \frac{2}{1-2z^{-1}} \quad |z| > 2$$

$$\left(\frac{1}{2}\right)^{n-1} u(-n) \quad (n < 1)$$

(3)

$$\bar{f}_1(z) = \frac{1}{1-2^{-n}z^{-1}} \quad |z| > 2^n$$

$$2^n u(-n) \quad (n < 1)$$

(4)

$$\bar{g}_1(z) = \frac{1}{1-2z^{-1}} \quad |z| > 2$$

$$\left(\frac{1}{2}\right)^n u(-n) \quad (n < 1)$$

Laurent Series and z Transform

$$-\frac{3}{2} \frac{z^2}{(z-0.5)(z-2)}$$

$$-\frac{3}{2} \frac{z^2}{(z-0.5)(z-2)} = \left(\frac{0.5z}{z-0.5} - \frac{2z}{z-2} \right)$$

$$|z| < 0.5 \quad f(z) = -\frac{z}{1-2z} + \frac{z}{1-0.5z}$$

Laurent Series

$$-2^{n-1} u(n) + \left(\frac{1}{2}\right)^{n-1} u(n)$$

z Transform

$$-2^{-n-1} u(-n) + \left(\frac{1}{2}\right)^{-n-1} u(-n) \\ -\left(\frac{1}{2}\right)^{n+1} u(-n) + 2^{n+1} u(-n)$$

$$0.5 < |z| < 2 \quad f(z) = \frac{0.5}{1-0.5z^{-1}} + \frac{z}{1-0.5z}$$

Laurent Series

$$2^{n-1} u(-n-1) + \left(\frac{1}{2}\right)^{n-1} u(n)$$

z Transform

$$2^{-n-1} u(n-1) + \left(\frac{1}{2}\right)^{-n-1} u(-n) \\ \left(\frac{1}{2}\right)^{n+1} u(n-1) + 2^{n+1} u(-n)$$

$$2 < |z| \quad f(z) = \frac{0.5}{1-0.5z^{-1}} - \frac{2}{1-2z^{-1}}$$

Laurent Series

$$2^{n-1} u(-n-1) - \left(\frac{1}{2}\right)^{n-1} u(-n-1)$$

z Transform

$$2^{-n-1} u(n-1) - \left(\frac{1}{2}\right)^{-n-1} u(n-1) \\ \left(\frac{1}{2}\right)^{n+1} u(n-1) + 2^{n+1} u(n-1)$$



$$-3 \frac{z}{(z-0.5)(z-2)} = \left(\frac{1}{z-0.5} - \frac{4}{z-2} \right)$$

$$= \frac{(z-2) - 4(z-0.5)}{(z-0.5)(z-2)}$$

$$= \frac{-3z}{(z-0.5)(z-2)}$$









