

SOC HW #3

20160416

Copyright (c) 2016 Young W. Lim.

Permission is granted to copy, distribute and/or modify this document under the terms of the GNU Free Documentation License, Version 1.2 or any later version published by the Free Software Foundation; with no Invariant Sections, no Front-Cover Texts, and no Back-Cover Texts. A copy of the license is included in the section entitled "GNU Free Documentation License".

* clock buffer

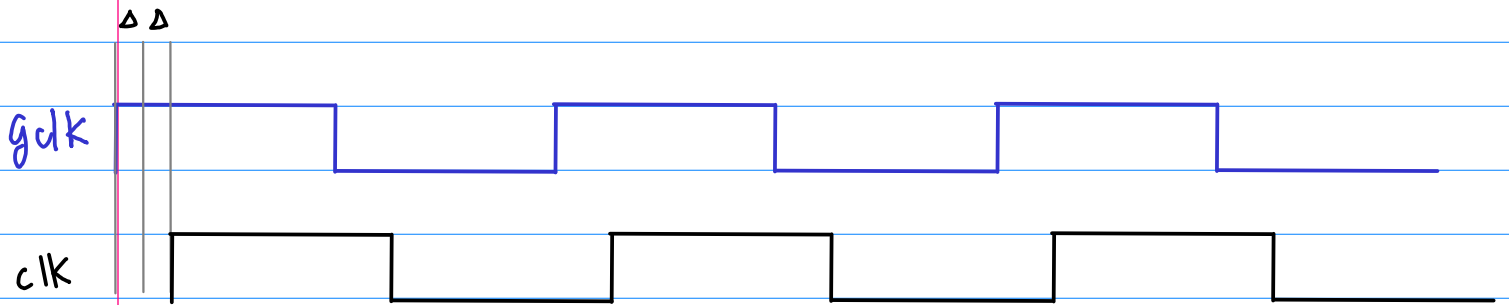
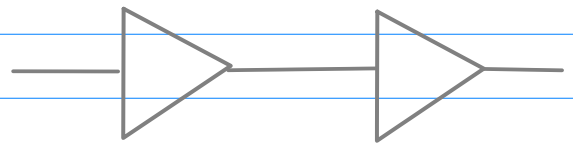
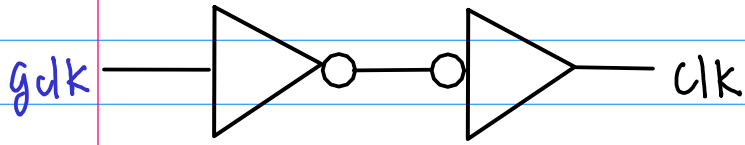

* Enabled / Qualified / Gated clock

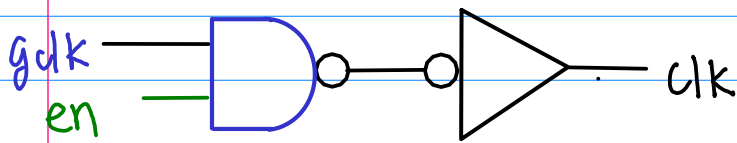

assume en=1

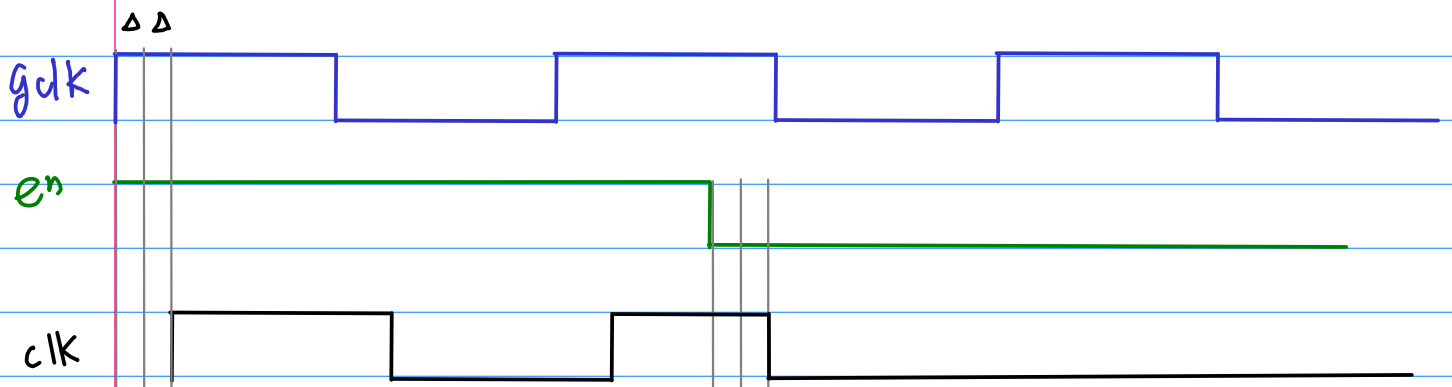



* Stretched Clocks

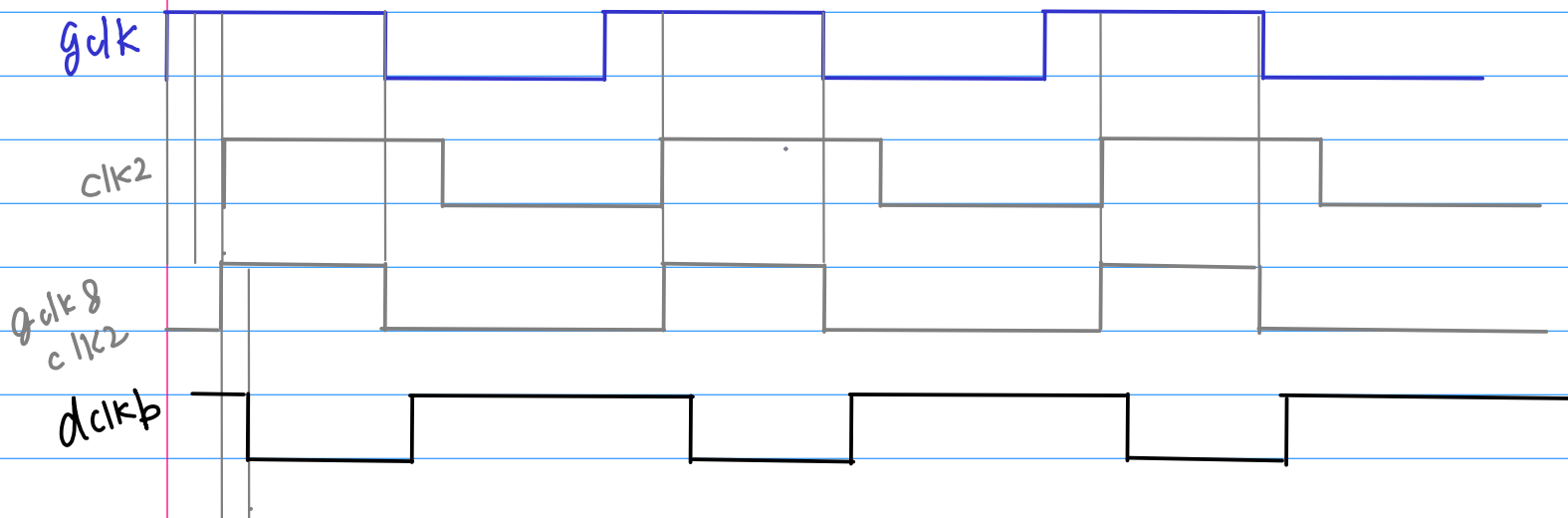
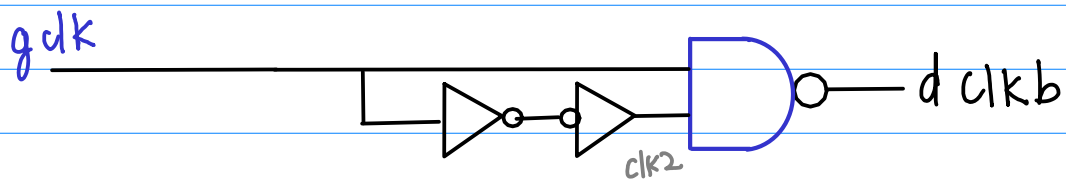
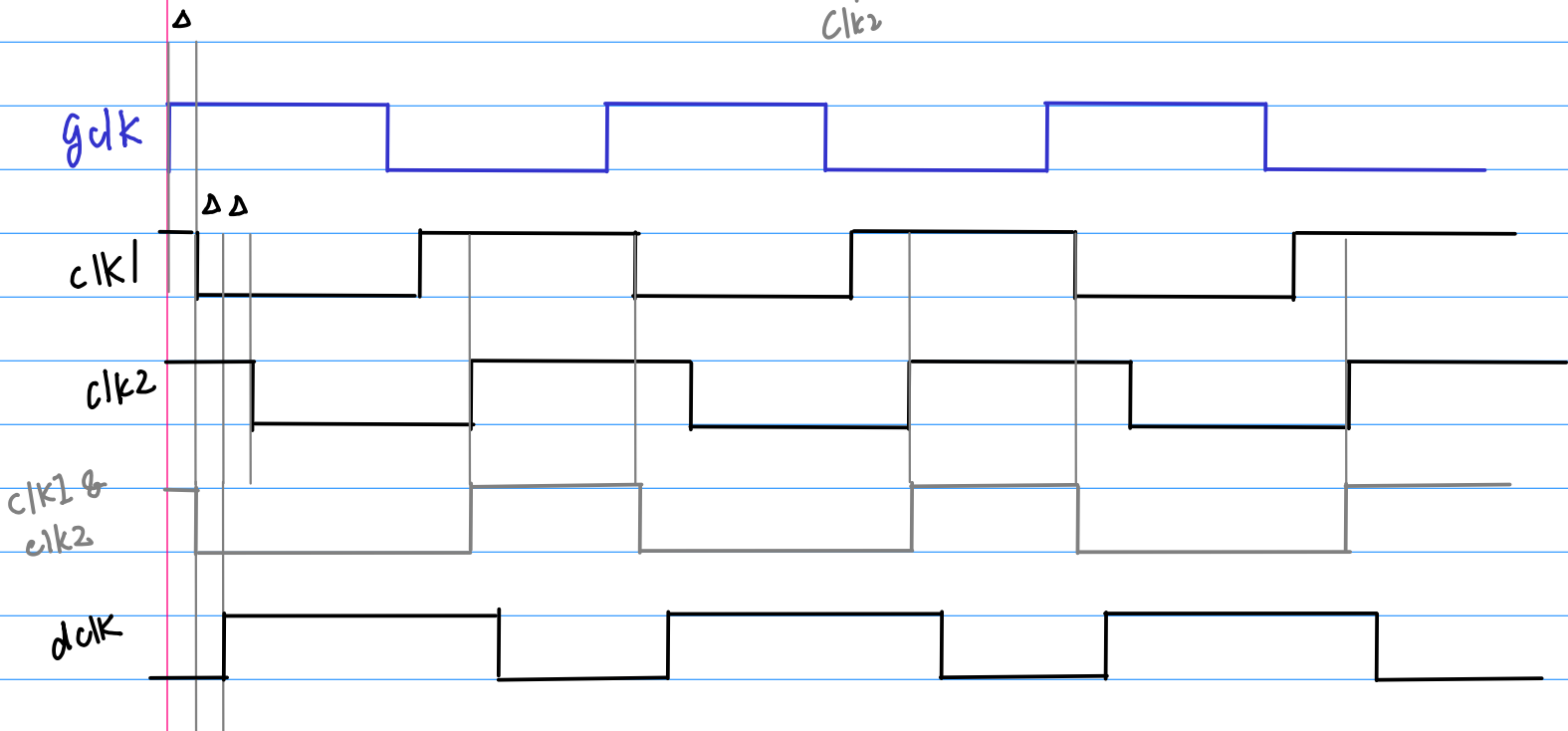
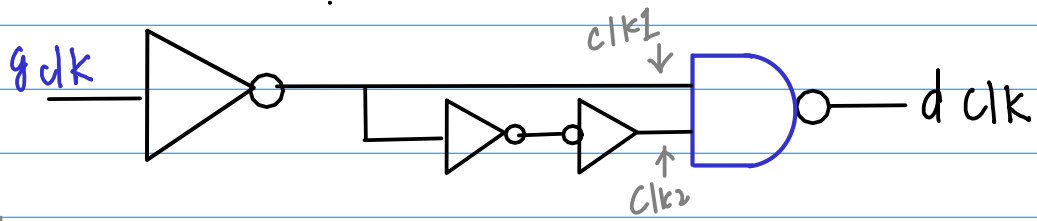

★ Non-overlapping clocks

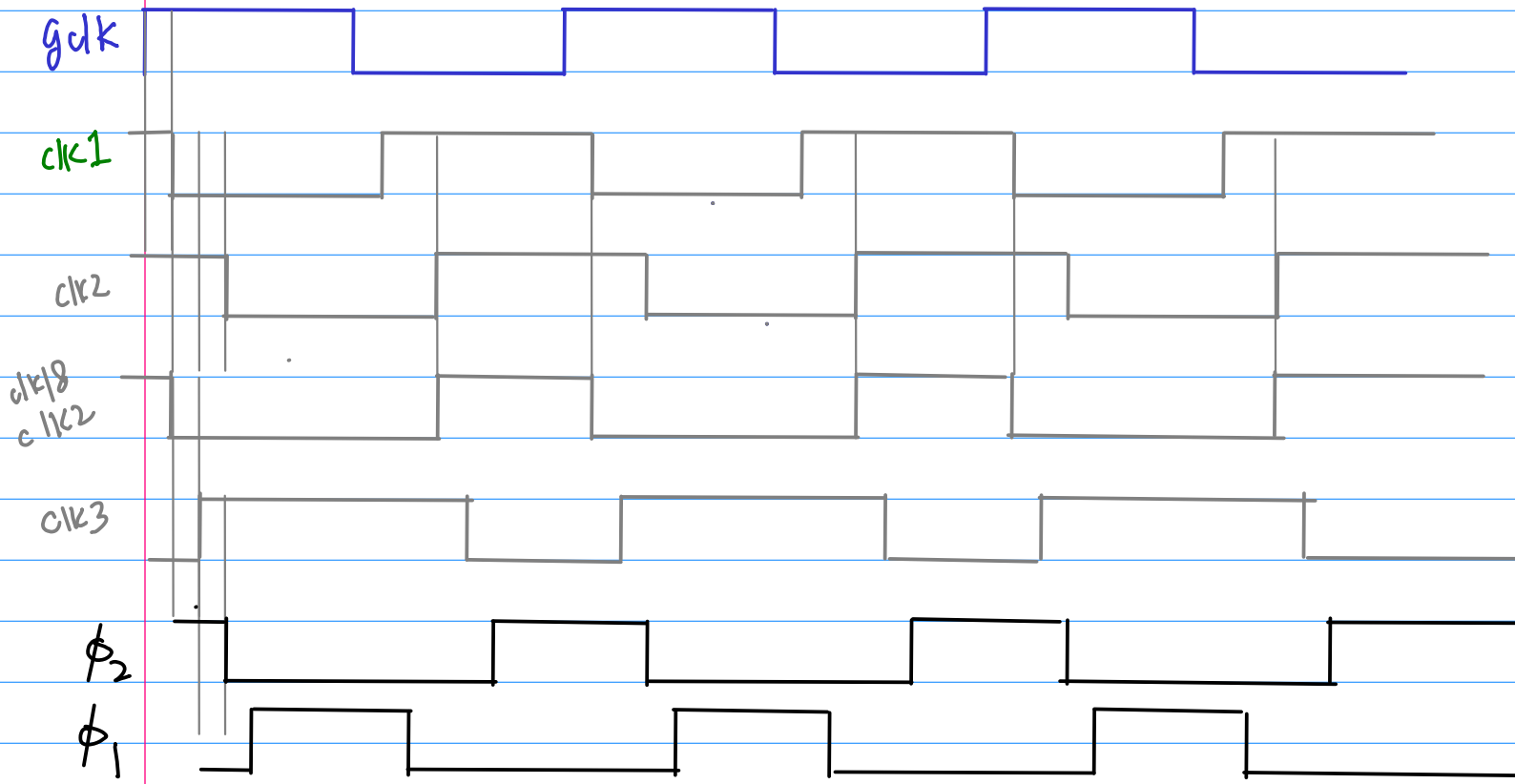
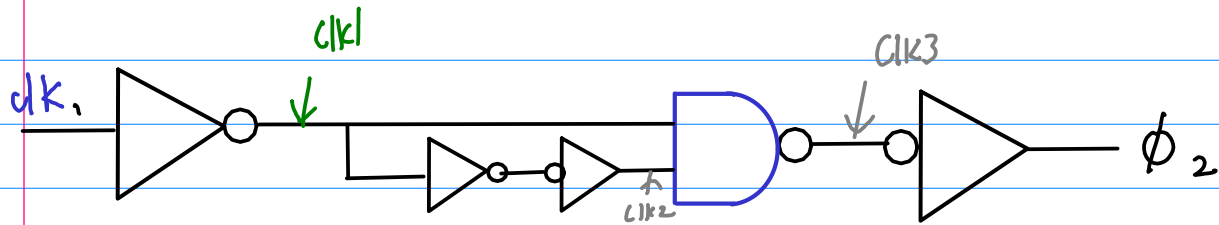
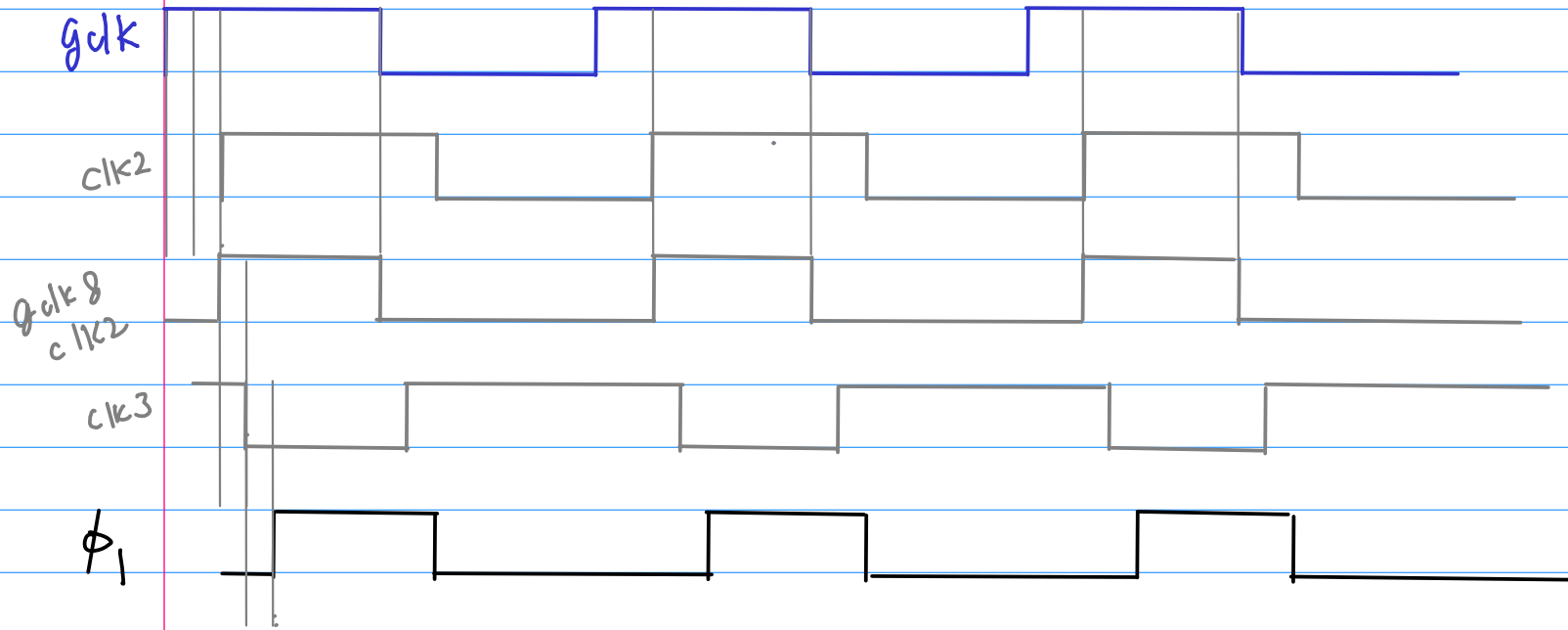
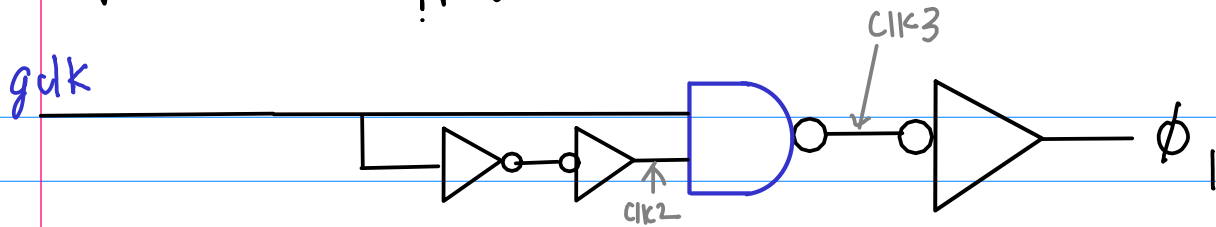

★ Complementary Clocks

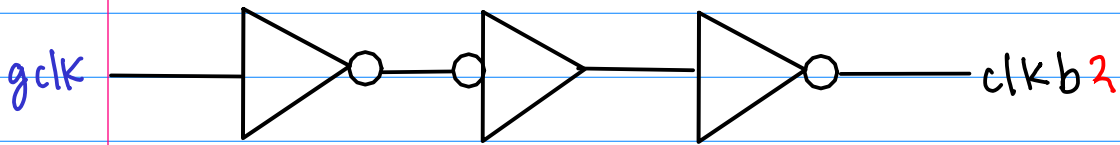
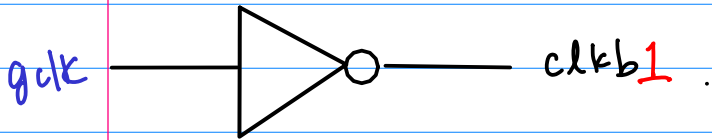

★ delayed clocks

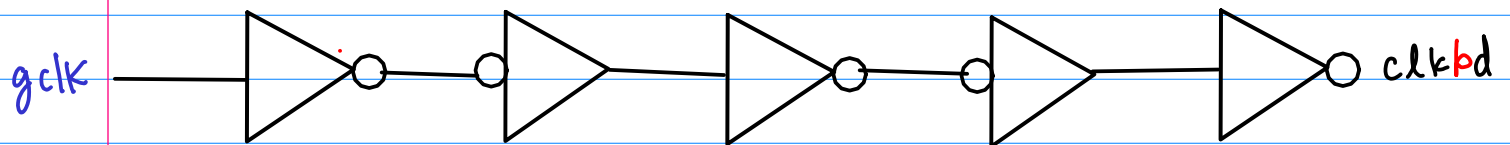
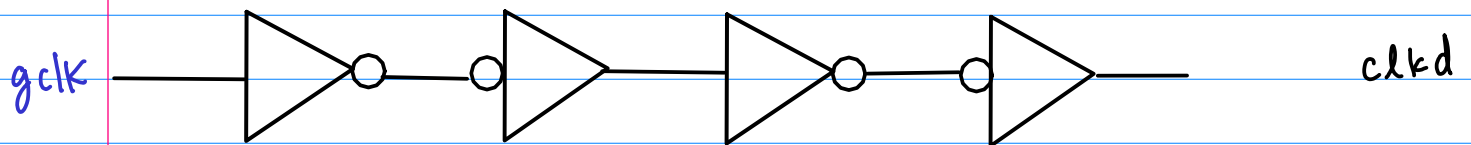

★ Pulsed Clocks

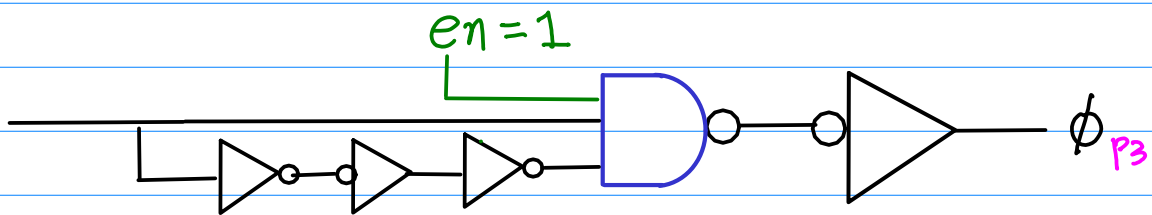
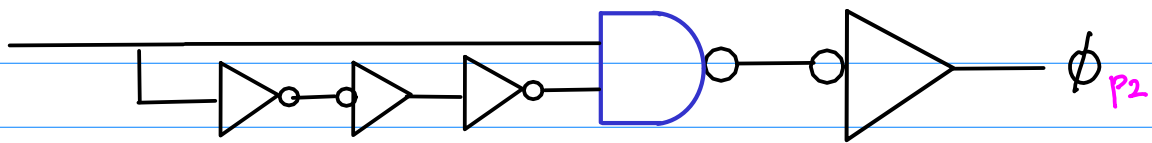
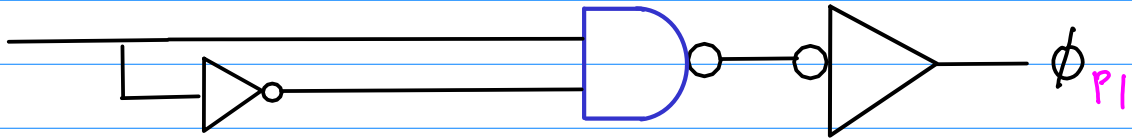

★ Clock Doubler

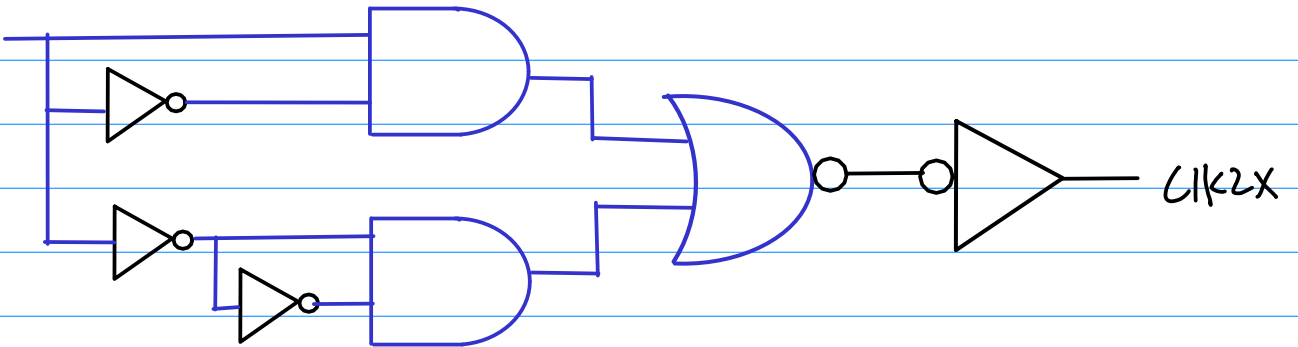

Edge Detector (1)

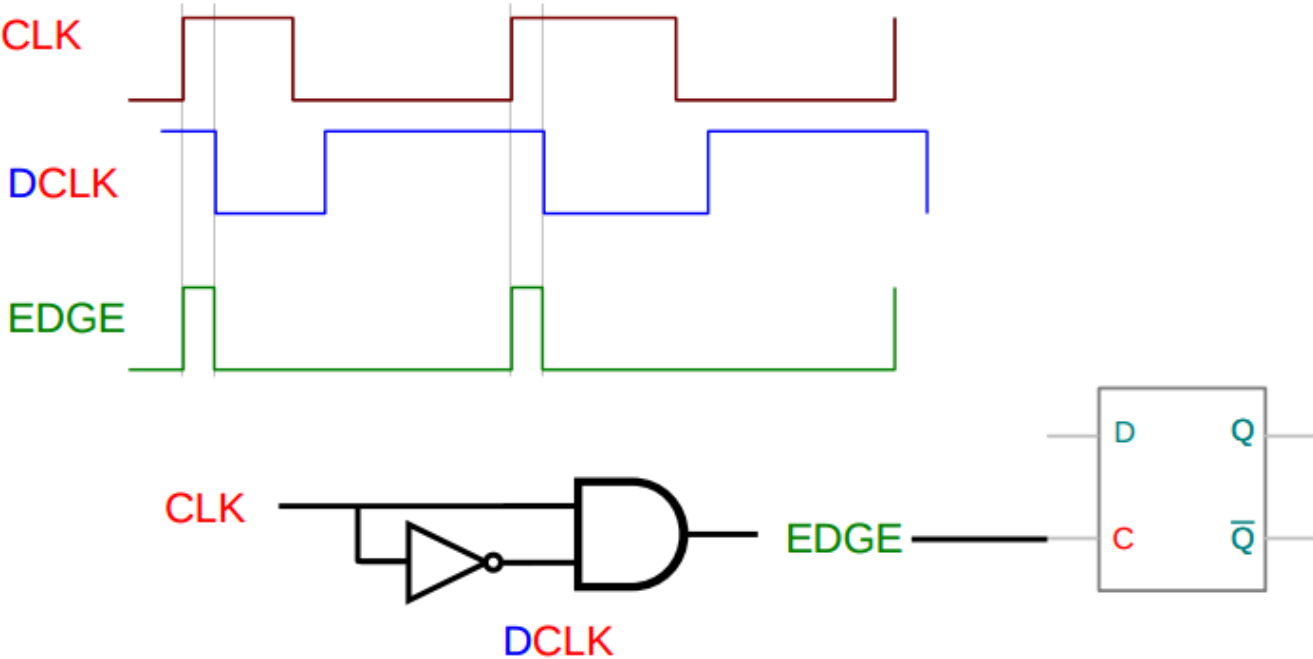

Edge Detector (2)

