

Problems in AI

- Hanoi Tower

Copyright (c) 2010 Young W. Lim.

Permission is granted to copy, distribute and/or modify this document under the terms of the GNU Free Documentation License, Version 1.2 or any later version published by the Free Software Foundation; with no Invariant Sections, no Front-Cover Texts, and no Back-Cover Texts. A copy of the license is included in the section entitled "GNU Free Documentation License".

Please send corrections (or suggestions) to youngwlim@hotmail.com.

This document was produced by using OpenOffice and Octave.

Hanoi Tower - Notation

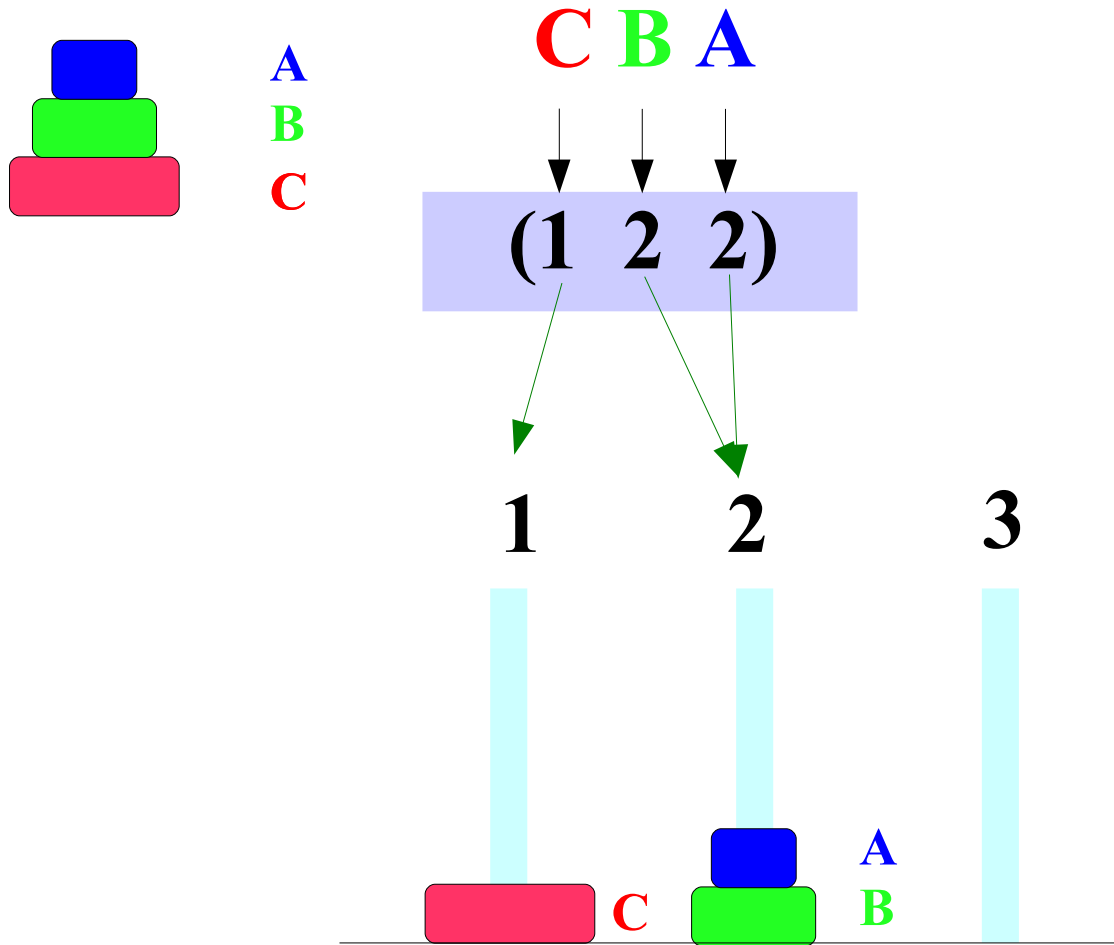

Hanoi Tower - Problem

Initial State

(1 1 1)

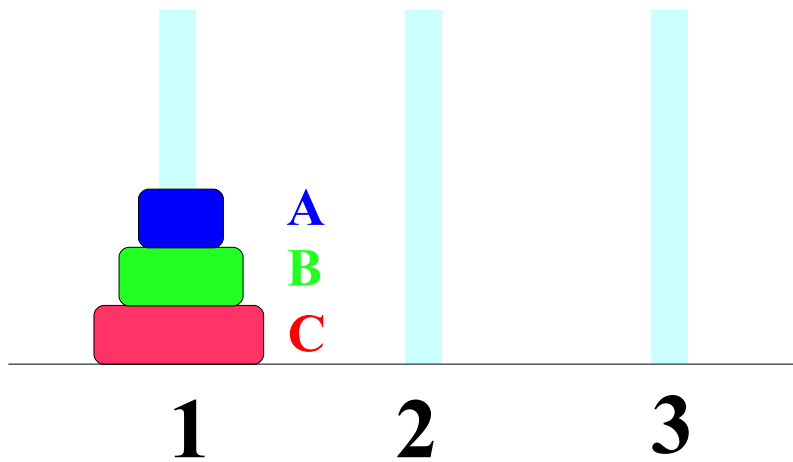

Final State

(3 3 3)

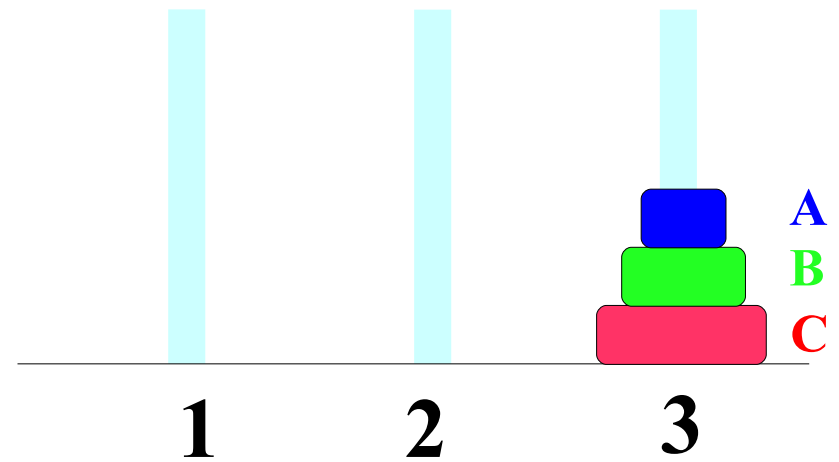

Hanoi Tower – Problem Reduction

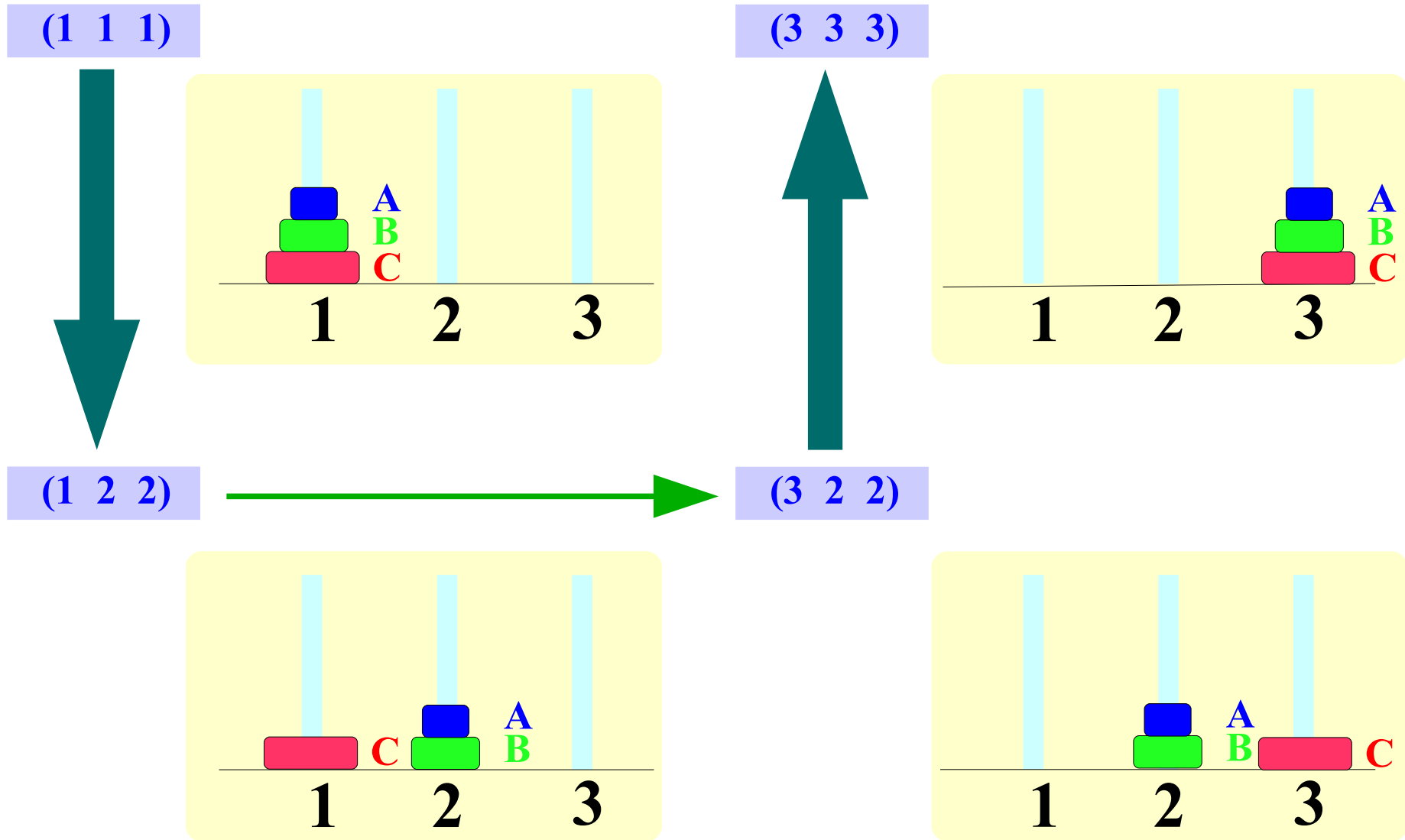

Hanoi Tower – State Space (1)

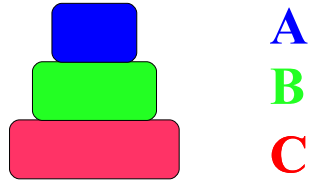

A
B
C

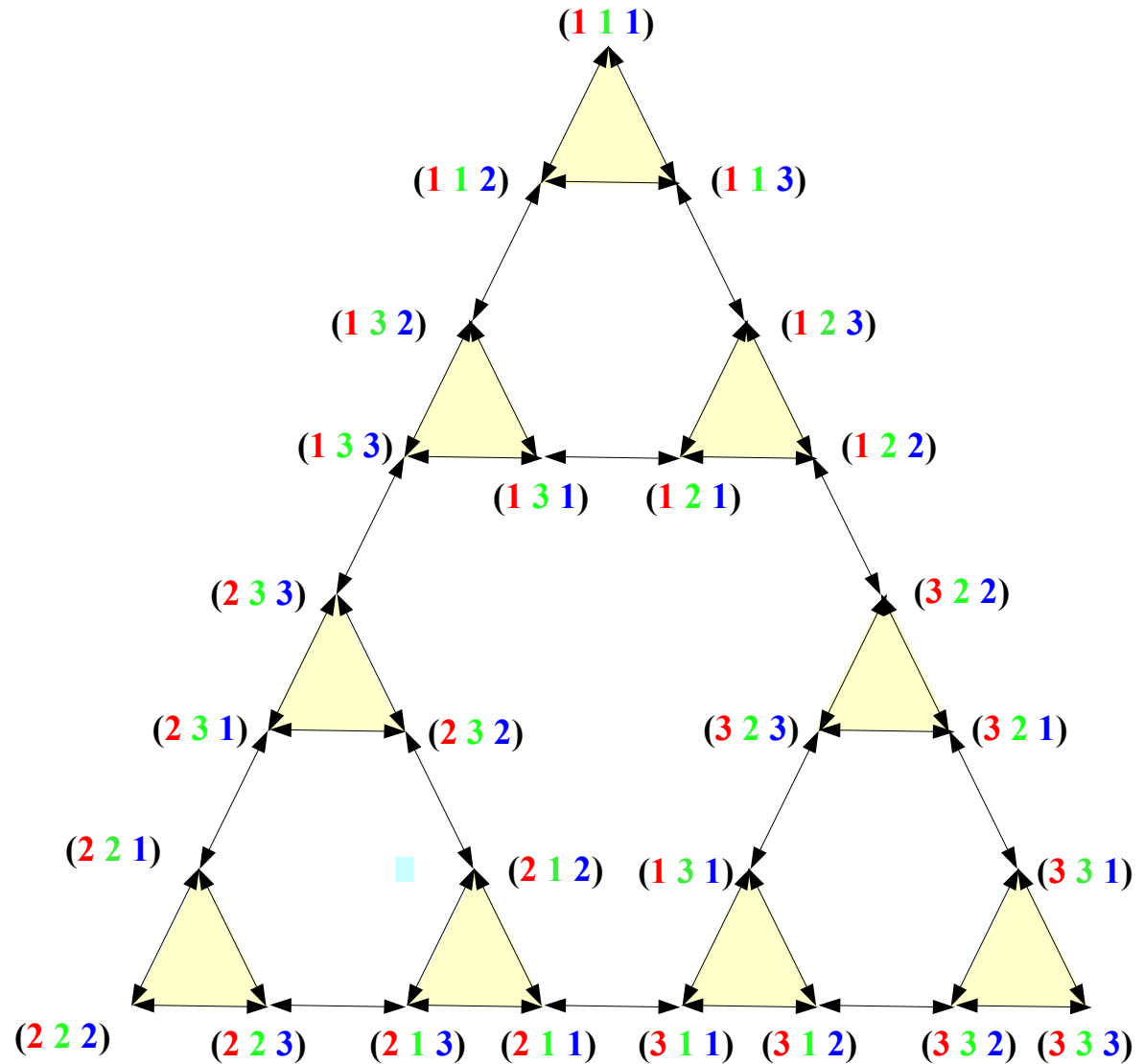
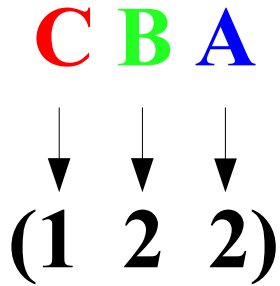

Hanoi Tower – State Space (2)

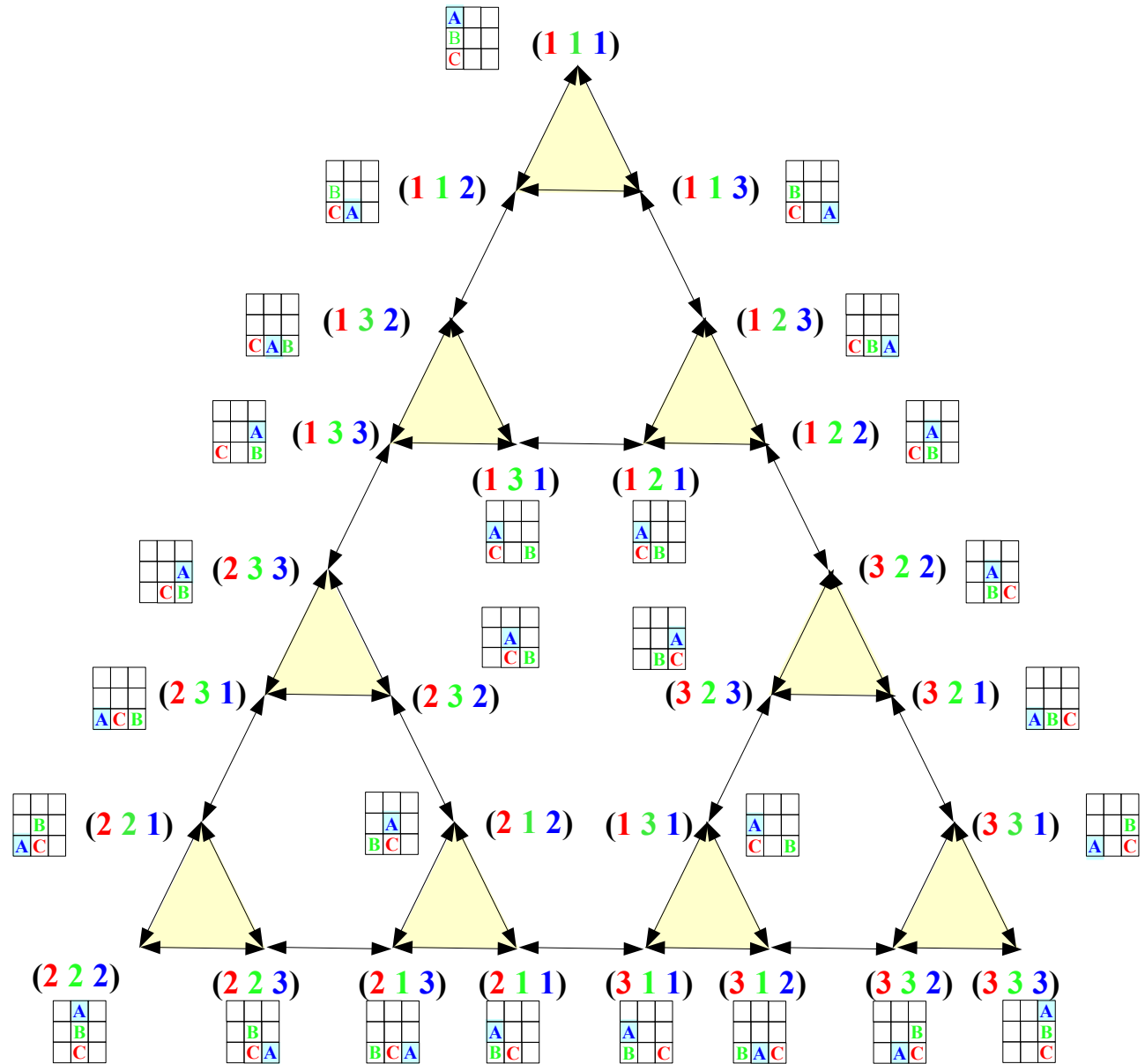

Hanoi Tower – State Space (3)

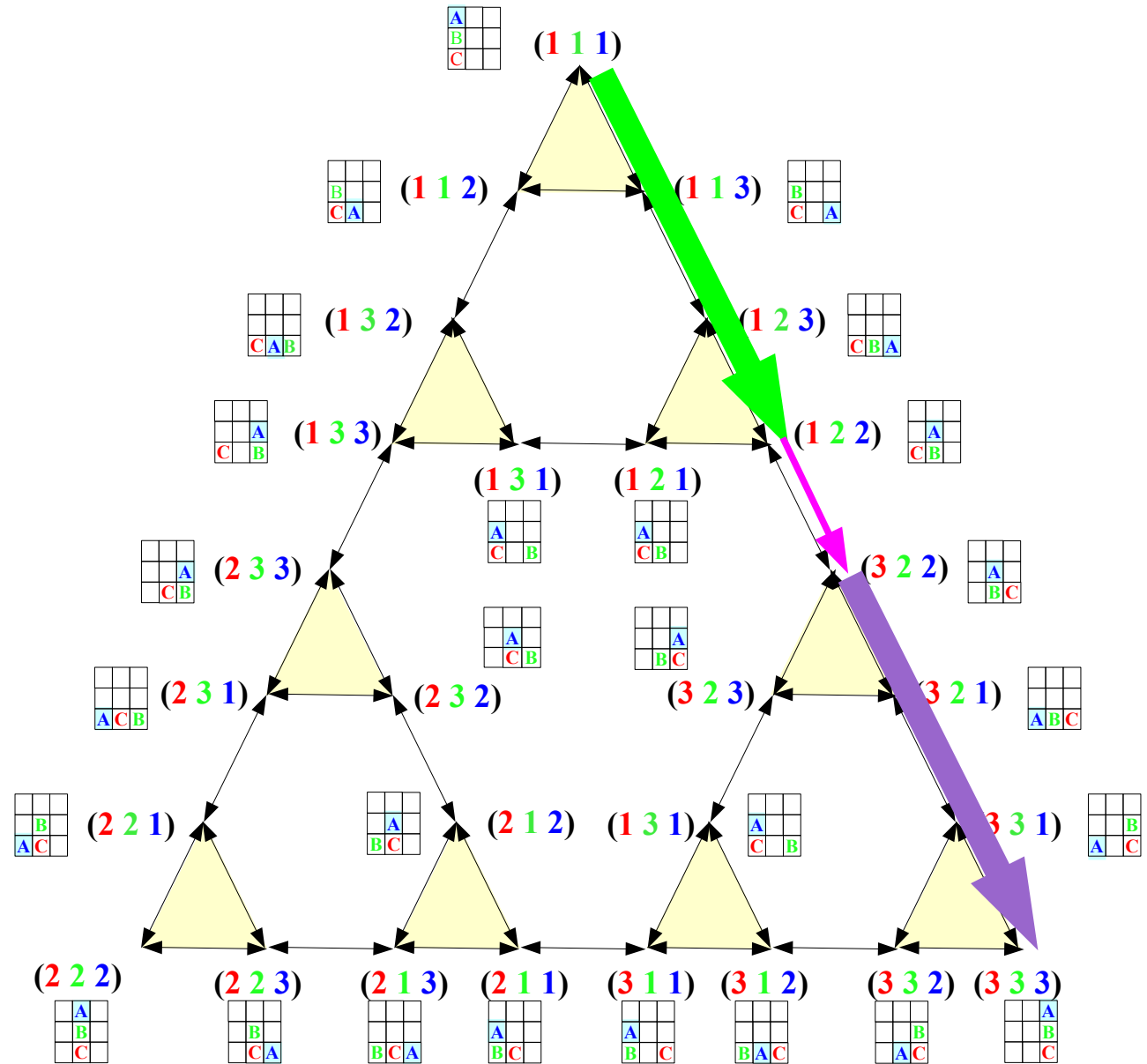

References

[1] <http://en.wikipedia.org/>

[2] 인공지능개론, 이광형, 조충호, 홍릉과학출판사, 2000