

Laurent Series and z-Transform

- Geometric Series

Applications

(A)

20201006 Tue

Copyright (c) 2016 - 2020 Young W. Lim.

Permission is granted to copy, distribute and/or modify this document under the terms of the GNU Free Documentation License, Version 1.2 or any later version published by the Free Software Foundation; with no Invariant Sections, no Front-Cover Texts, and no Back-Cover Texts. A copy of the license is included in the section entitled "GNU Free Documentation License".

2 formulas

Simple Pole Form

in terms of p

in terms of $1/p$

simple pole p

simple pole $1/p$

simple pole $1/p$

simple pole p

$$\frac{1}{z - p}$$

$$\frac{1}{z^{-1} - p}$$

$$\frac{1}{z - p^{-1}}$$

$$\frac{1}{z^{-1} - p^{-1}}$$

$$/p \quad \frac{p^{-1}}{1 - p^{-1}z}$$

$$/p \quad \frac{p^{-1}}{1 - p^{-1}z^{-1}}$$

$$*p \quad \frac{p}{1 - pz}$$

$$*p \quad \frac{p}{1 - pz^{-1}}$$

$$/z \quad \frac{z^{-1}}{1 - pz^{-1}}$$

$$*z \quad \frac{z}{1 - pz}$$

$$/z \quad \frac{z^{-1}}{1 - p^{-1}z^{-1}}$$

$$*z \quad \frac{z}{1 - p^{-1}z}$$

$$z^{-1}$$

$$z^{-1}$$

$$p^{-1}$$

when the pole is expressed as p

2 formulas

Simple Pole Form

$$\frac{1}{z - p}$$

$$\frac{1}{z^{-1} - p}$$

2 representations each

Shifted Geometric Series Form

$$\frac{1}{z - p} \begin{cases} \cong \frac{p^{-1}}{1 - p^{-1}z} \triangleq f(z) = \chi(z^{-1}) \\ \cong \frac{z^{-1}}{1 - pz^{-1}} \triangleq \gamma(z) = g(z^{-1}) \end{cases}$$

causal
Laurent
=
anti-causal
z-transform

||
||

causal
z-transform
=
anti-causal
Laurent

$$\frac{1}{z^{-1} - p} \begin{cases} \cong -\frac{p^{-1}}{1 - p^{-1}z^{-1}} \triangleq \chi(z) = f(z^{-1}) \\ \cong \frac{z}{1 - pz} \triangleq g(z) = \gamma(z^{-1}) \end{cases}$$

causal
z-transform
=
anti-causal
Laurent

||
||

causal
Laurent
=
anti-causal
z-transform

Simple Pole Form

Shifted Geometric Series Form

when the pole is expressed as $1/p$

2 formulas

Simple Pole Form

$$\frac{1}{z - p^{-1}}$$

$$\frac{1}{z^{-1} - p^{-1}}$$

2 representations each

Shifted Geometric Series Form

$\frac{1}{z - p^{-1}}$	$\frac{p}{1 - pz}$	\triangleq	$f(z) =$	$\chi(z^{-1})$
$\frac{1}{z^{-1} - p^{-1}}$	$\frac{z^{-1}}{1 - p^{-1}z^{-1}}$	\triangleq	$\gamma(z) =$	$g(z^{-1})$
			causal z-transform	anti-causal Laurent

$\frac{1}{z^{-1} - p^{-1}}$	$\frac{p}{1 - pz}$	\triangleq	$\chi(z) =$	$f(z^{-1})$
$\frac{1}{z^{-1} - p^{-1}}$	$\frac{z}{1 - p^{-1}z}$	\triangleq	$g(z) =$	$\gamma(z^{-1})$
			causal Laurent	anti-causal z-transform

Simple Pole Form

Shifted Geometric Series Form

Shifted Geometric Series (1a) p

from unshifted series

2 formulas

Simple Pole Form

$$\frac{1}{z - p}$$

$$\frac{1}{z^{-1} - p}$$

2 representations each

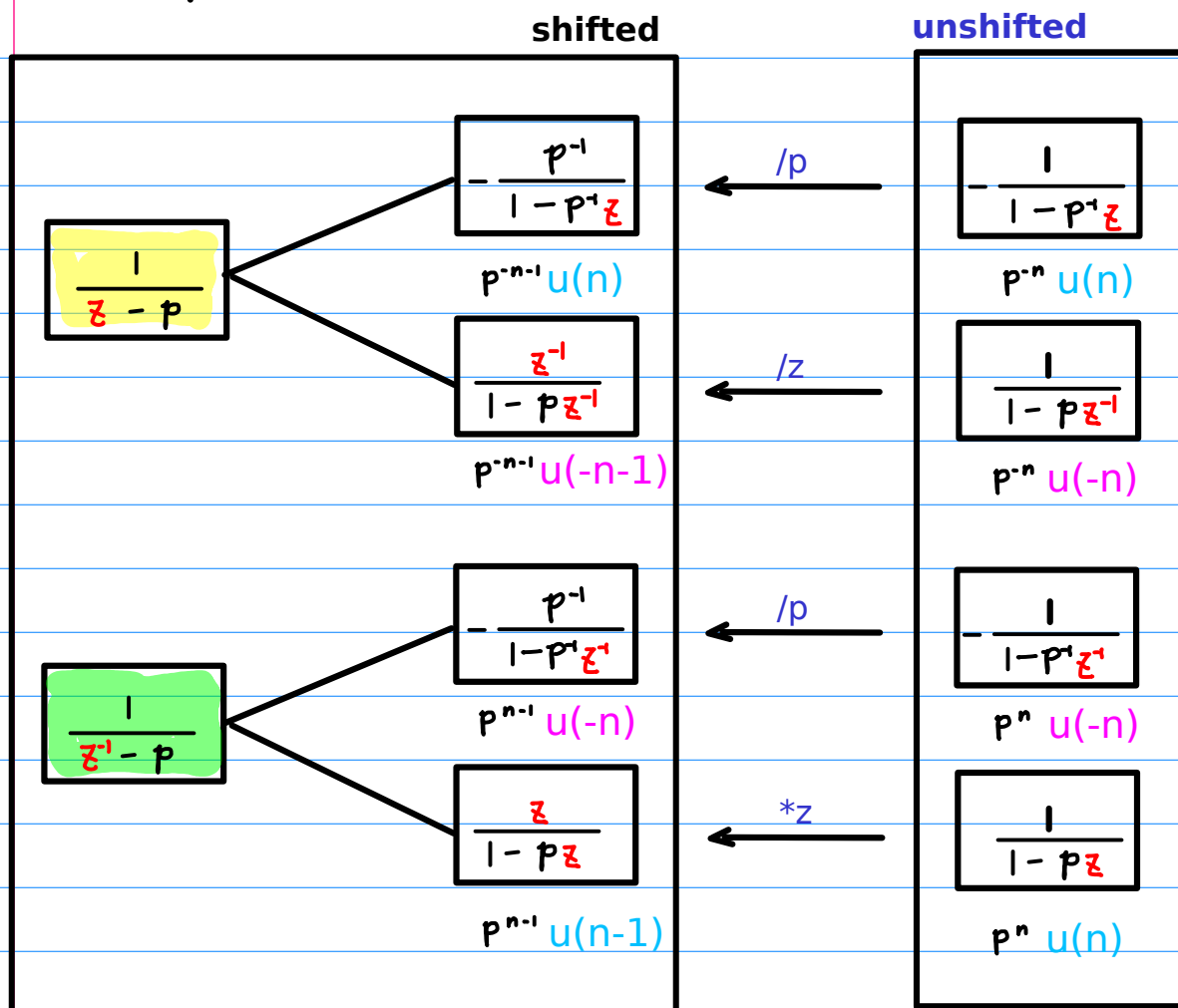

Simple Pole Form

Shifted Geometric Series Form

Unit nominator

Un-shifted Geometric Series Form

$u(n)$ $u(-n)$

Shifted Geometric Series (1b) 1/p

from unshifted series

2 formulas

Simple Pole Form

$$\frac{1}{z - p^{-1}}$$

$$\frac{1}{z^{-1} - p^{-1}}$$

2 representations each

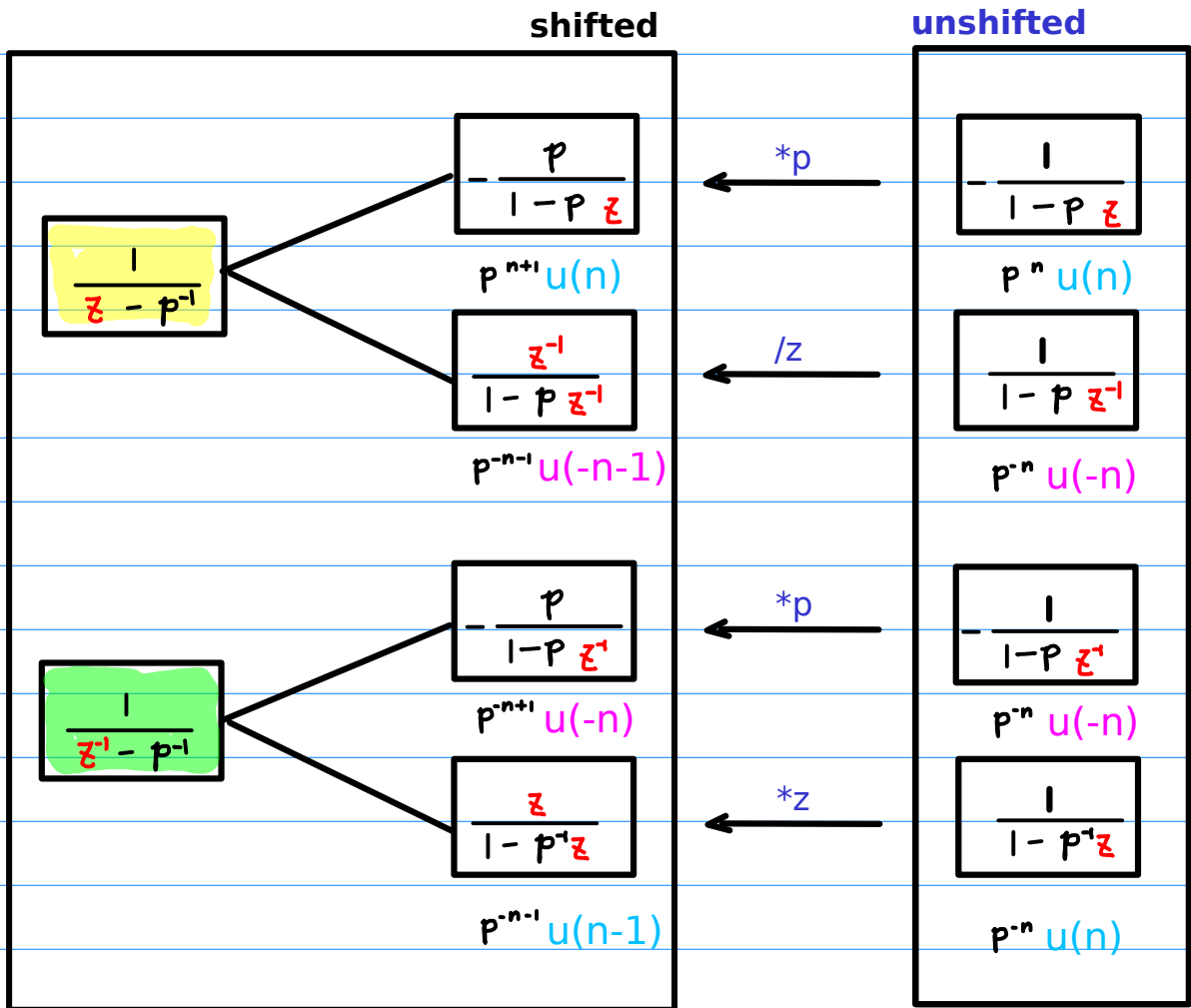

Simple Pole Form

Shifted Geometric Series Form

Unit nominator

Un-shifted Geometric Series Form

$u(n)$ $u(-n)$

Shifted Geometric Series (2a) p from complementary unshifted series

2 formulas

Simple Pole Form

$$\frac{1}{z - p}$$

$$\frac{1}{z^{-1} - p}$$

2 representations each

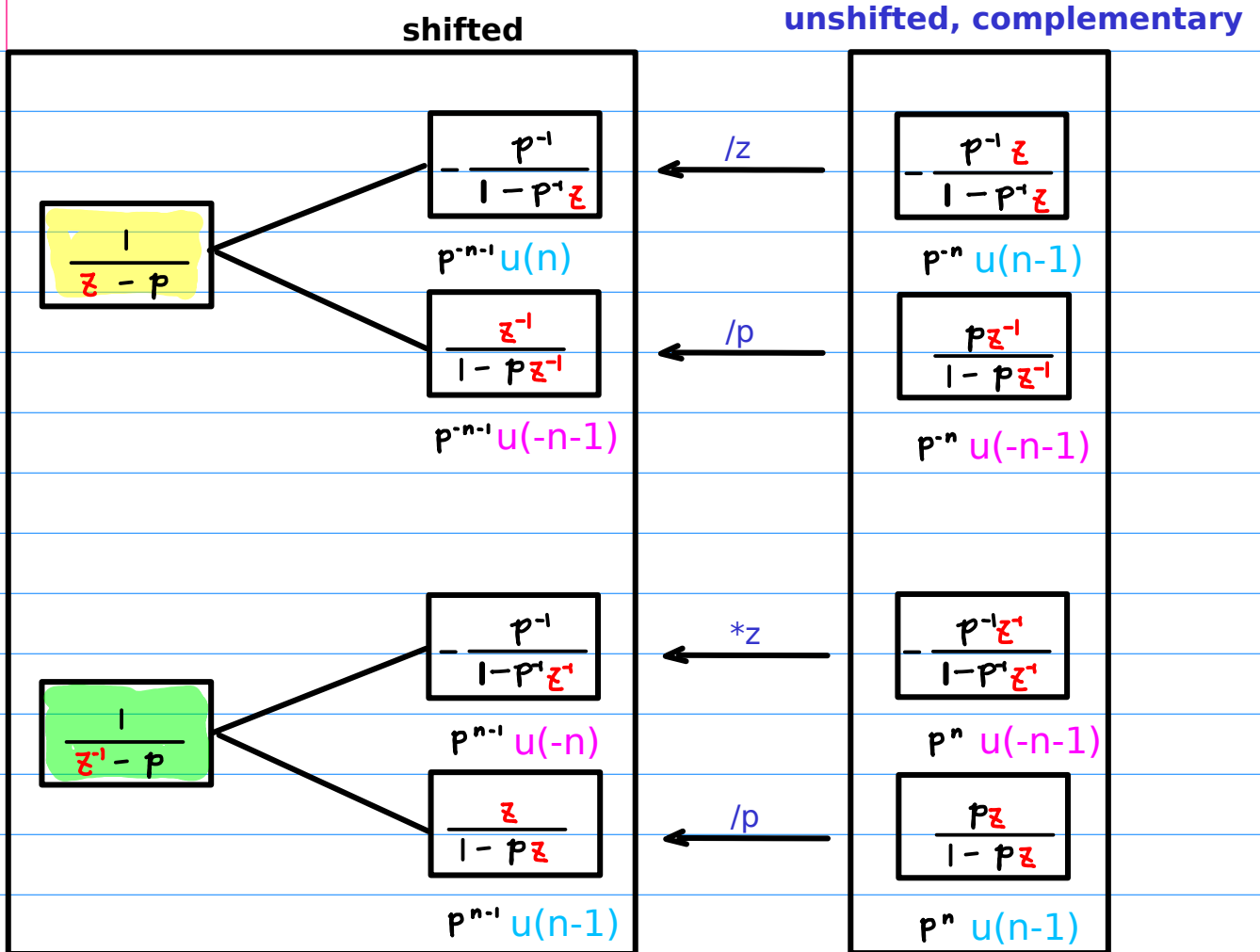

Simple Pole Form

Shifted Geometric Series Form

Common Ratio nominator

Un-shifted Geometric Series Form

$u(n-1)$ $u(-n-1)$

Shifted Geometric Series (2b) 1/p

from complementary unshifted series

2 formulas

Simple Pole Form

$$\frac{1}{z - p^{-1}}$$

$$\frac{1}{z^{-1} - p^{-1}}$$

2 representations each

shifted

unshifted, complementary

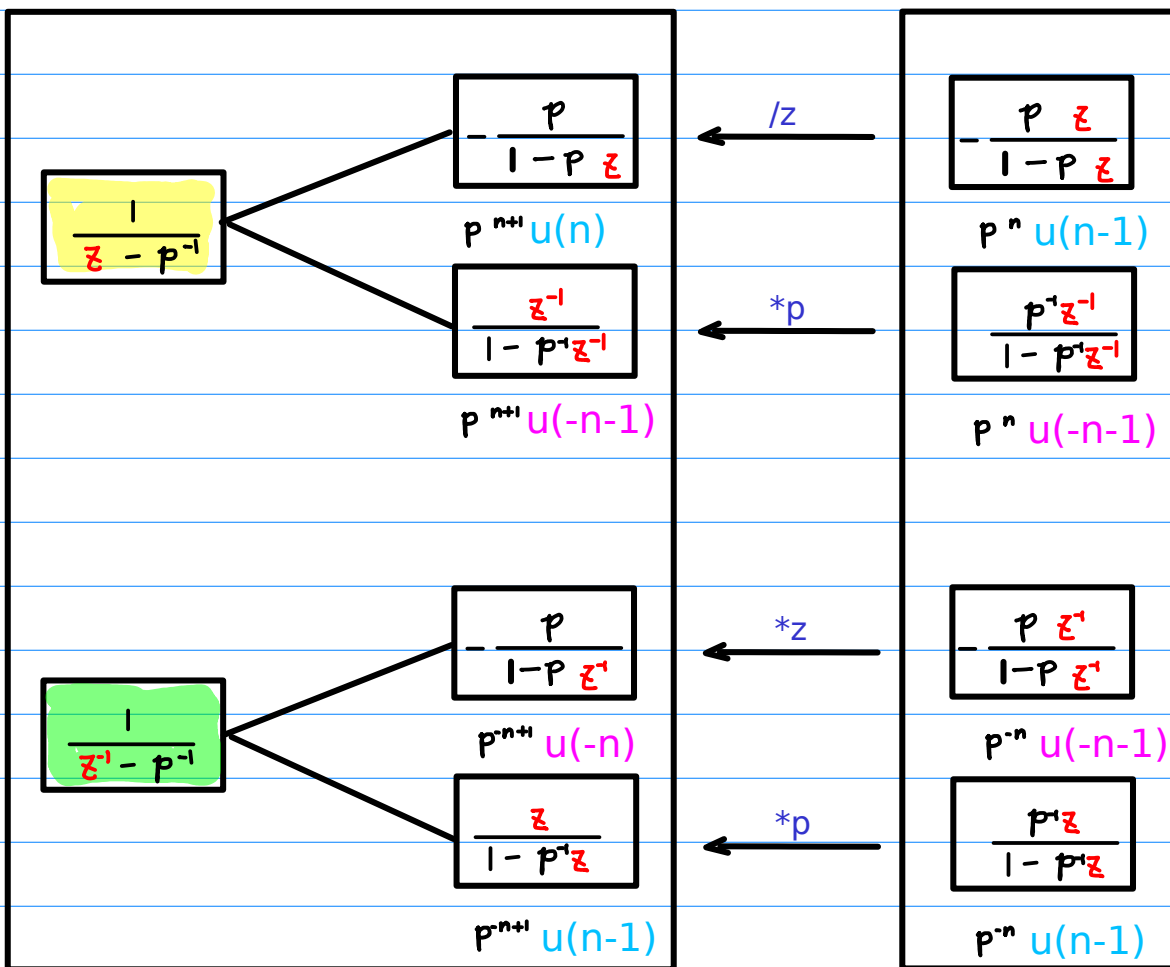

Simple Pole Form

Shifted Geometric Series Form

Common Ratio nominator

Un-shifted Geometric Series Form

$u(n-1)$ $u(-n-1)$

Shifted Geometric Series (3a) p

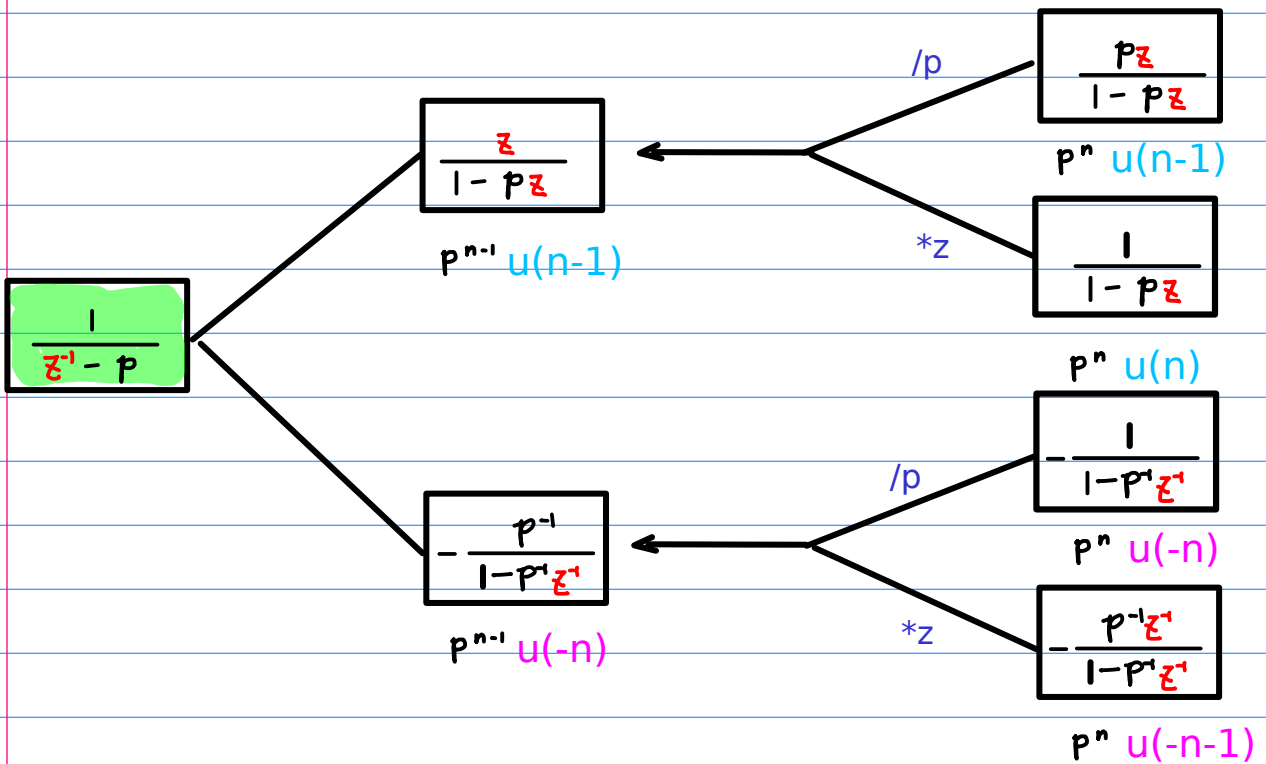
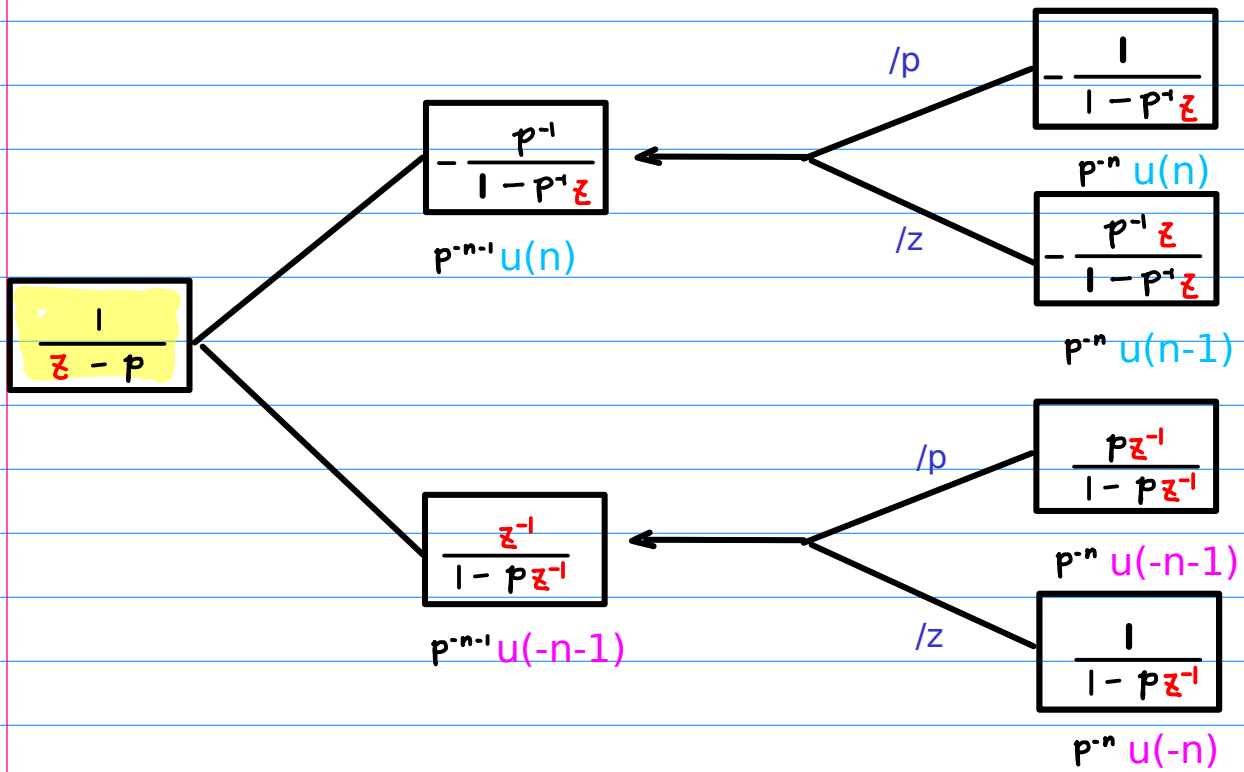

Shifted Geometric Series (3b) 1/p

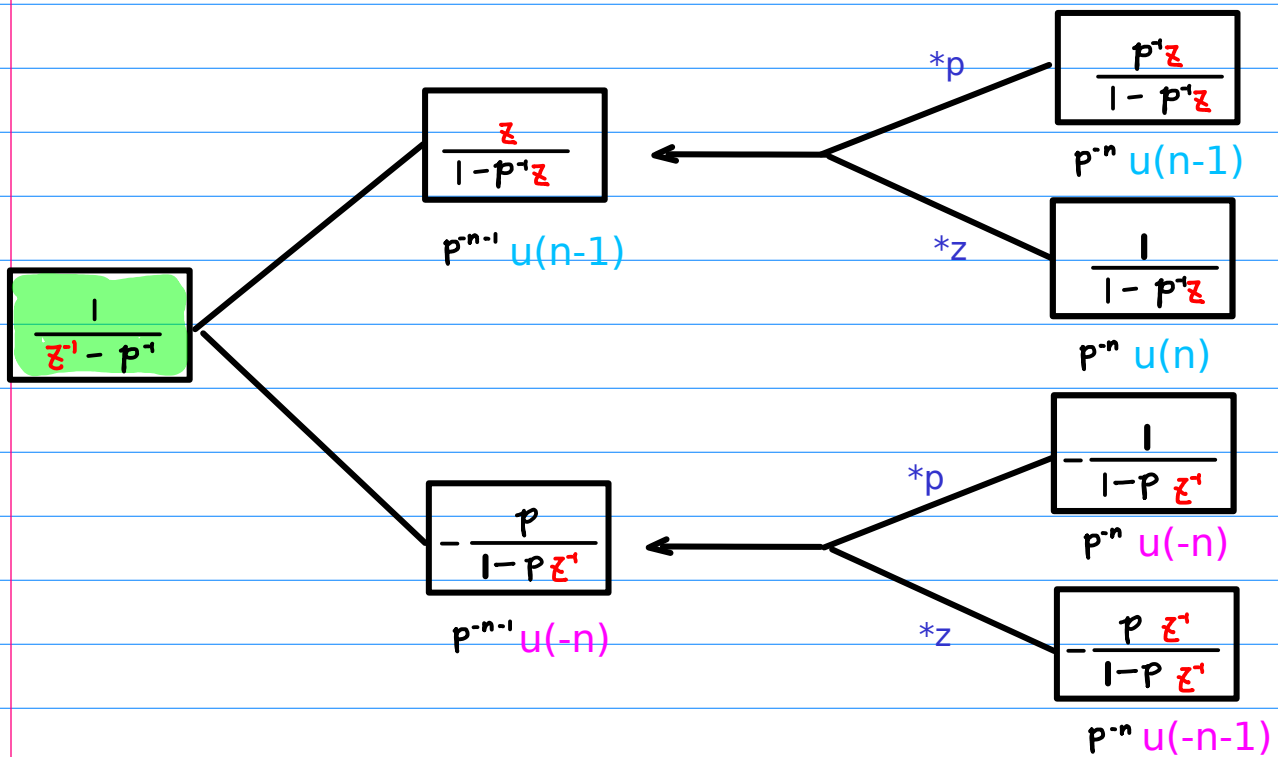
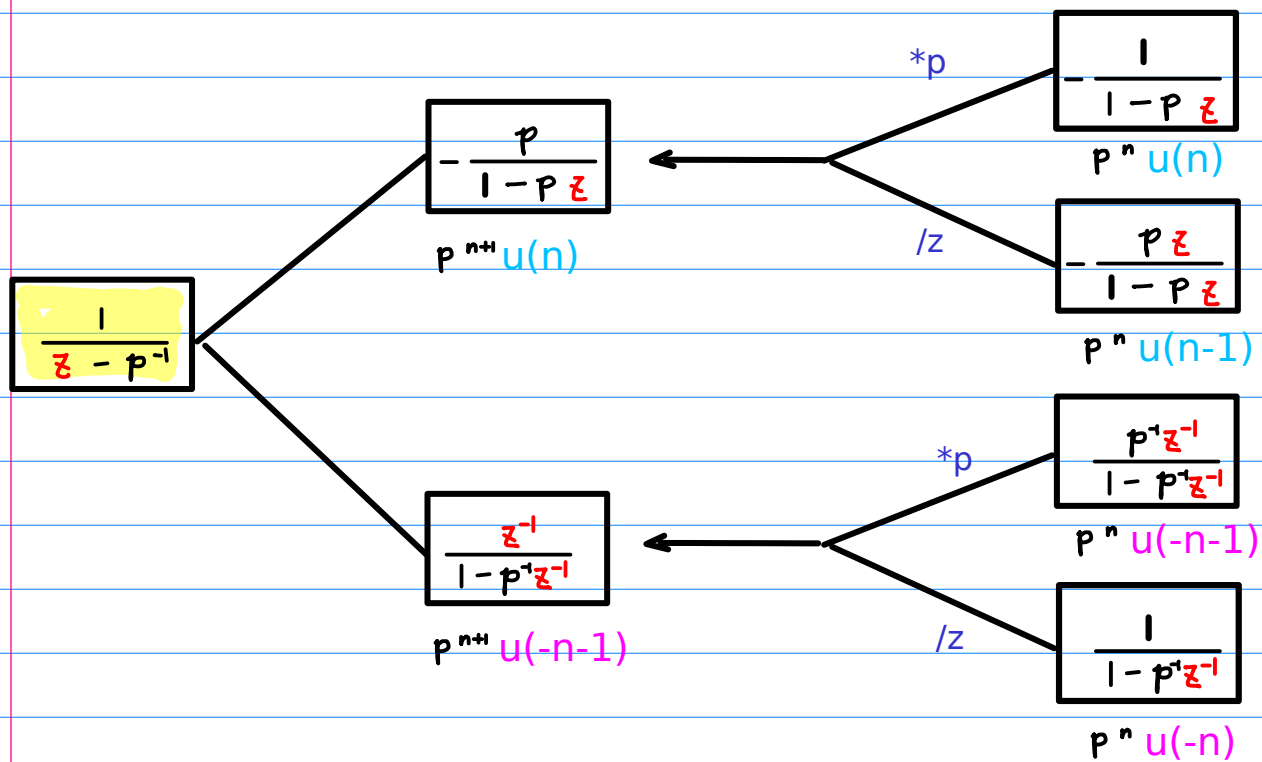

$$\frac{1}{1 - az} \rightarrow u(n)$$

$$\frac{1}{1 - az^{-1}} \rightarrow u(-n)$$

$$az, a^{-1}z^{-1} \rightarrow a^n$$

$$a^{-1}z, az^{-1} \rightarrow a^{-n}$$

$$\frac{1}{1 - az} \quad |z| < a^{-1}$$

$$a^n u(n)$$

$$\frac{1}{1 - a^{-1}z} \quad |z| < a$$

$$a^{-n} u(n)$$

$$\frac{az}{1 - az} \quad |z| < a^{-1}$$

$$a^n u(n-1)$$

$$\frac{a^{-1}z}{1 - a^{-1}z} \quad |z| < a$$

$$a^{-n} u(n-1)$$

$$-\frac{a^{-1}z^{-1}}{1 - a^{-1}z^{-1}} \quad |z| > a^{-1}$$

$$a^n u(-n-1)$$

$$-\frac{az^{-1}}{1 - az^{-1}} \quad |z| > a$$

$$a^{-n} u(-n-1)$$

$$-\frac{1}{1 - a^{-1}z^{-1}} \quad |z| > a^{-1}$$

$$a^n u(-n)$$

$$-\frac{1}{1 - az^{-1}} \quad |z| > a$$

$$a^{-n} u(-n)$$

$$\frac{a^n}{1-a^n z} \quad |z| < a$$

$$a^{-n-1} u(n)$$

$$\frac{1}{1-a^n z} \quad |z| < a$$

$$a^{-n} u(n) \times a^{-1}$$

$$\frac{z}{1-a^n z} \quad |z| < a$$

$$a^{-n+1} u(n-1)$$

$$\frac{a^n z}{1-a^n z} \quad |z| < a$$

$$a^{-n} u(n-1) \times a$$

$$-\frac{z^{-1}}{1-a^n z^{-1}} \quad |z| > a$$

$$a^{-n-1} u(-n-1)$$

$$-\frac{a^n z^{-1}}{1-a^n z^{-1}} \quad |z| > a$$

$$a^{-n} u(-n-1) \times a^{-1}$$

$$-\frac{a}{1-a^n z^{-1}} \quad |z| > a$$

$$a^{-n+1} u(-n)$$

$$-\frac{1}{1-a^n z^{-1}} \quad |z| > a$$

$$a^{-n} u(-n) \times a$$

$$z \quad n \leftarrow n-1$$

$$z^{-1} \quad n \leftarrow n+1$$

$$\frac{a^n}{1-a^n z} \quad |z| < a$$

$$a^{-n-1} u(n)$$

$$\frac{a^n z}{1-a^n z} \quad |z| < a$$

$$n \leftarrow n+1$$

$$a^{-n} u(n-1) \times z^{-1}$$

$$\frac{z}{1-a^n z} \quad |z| < a$$

$$a^{-n+1} u(n-1)$$

$$\frac{1}{1-a^n z} \quad |z| < a$$

$$n \leftarrow n-1$$

$$a^{-n} u(n) \times z$$

$$-\frac{z^{-1}}{1-a^n z^{-1}} \quad |z| > a$$

$$a^{-n-1} u(-n-1)$$

$$-\frac{1}{1-a^n z^{-1}} \quad |z| > a$$

$$n \leftarrow n+1$$

$$a^{-n} u(-n) \times z^{-1}$$

$$-\frac{a}{1-a^n z^{-1}} \quad |z| > a$$

$$a^{-n+1} u(-n)$$

$$-\frac{a z^{-1}}{1-a^n z^{-1}} \quad |z| > a$$

$$a^{-n} u(-n-1) \times z$$

a^n

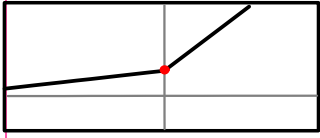

Shifting a sequence

$/z \quad n \leftarrow n+1 \quad *z \quad n \leftarrow n-1$

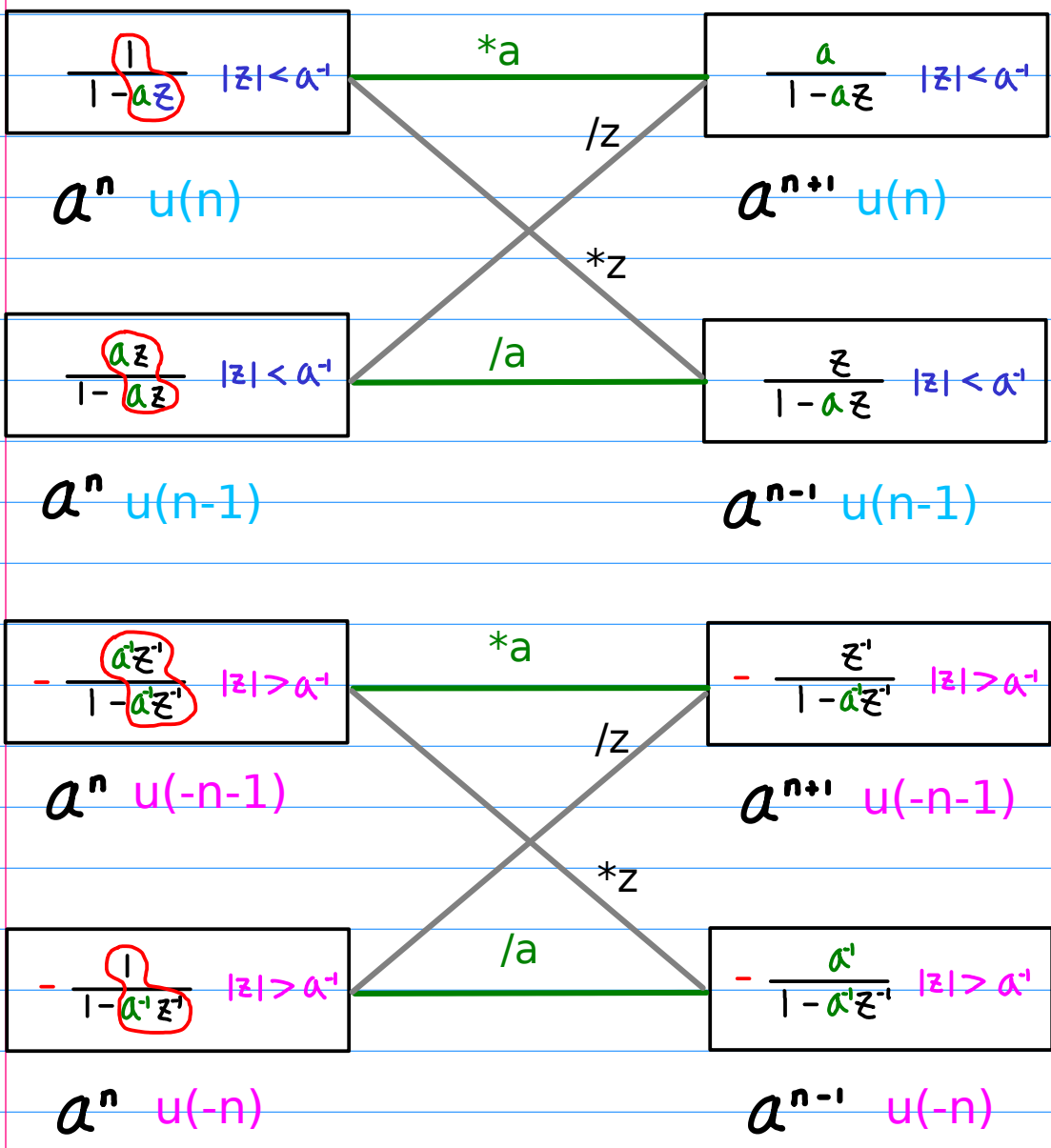

a^{-n}

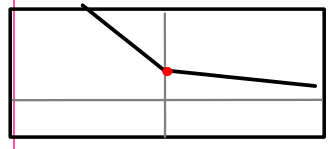

Shifting a sequence

$/z \quad n \leftarrow n+1 \quad *z \quad n \leftarrow n-1$

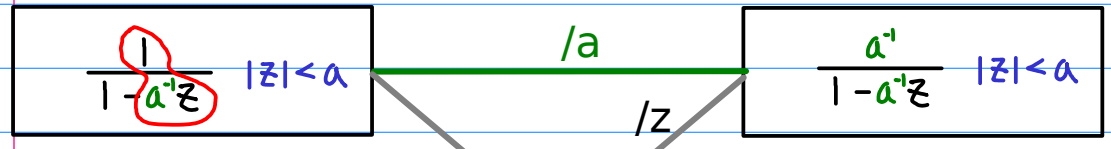

$a^{-n} u(n)$

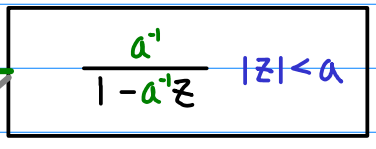

$a^{-n-1} u(n)$

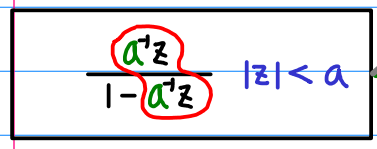

$a^{-n} u(n-1)$

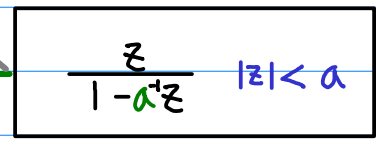
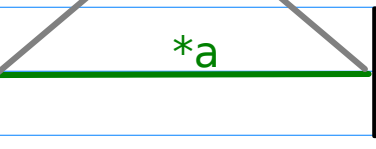

$a^{-n+1} u(n-1)$

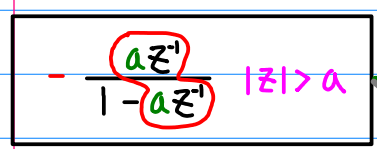

$a^{-n} u(-n-1)$

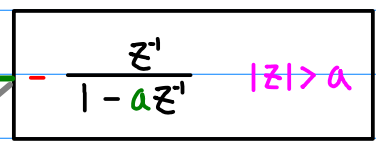
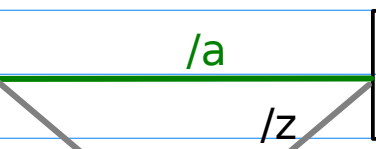

$a^{-n-1} u(-n-1)$

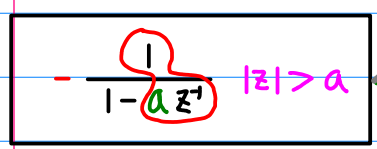

$a^{-n} u(-n)$

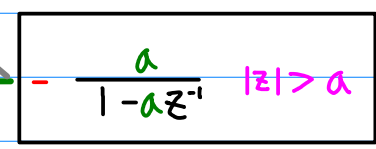
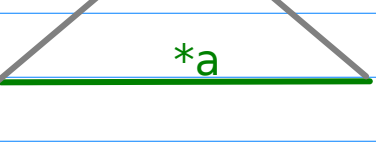

$a^{-n+1} u(-n)$

a^n

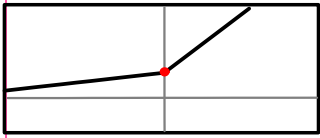

Shifting a sequence

$/z \quad n \leftarrow n+1 \quad *z \quad n \leftarrow n-1$

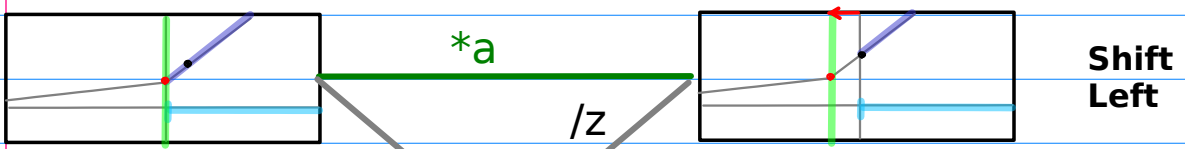

$a^n u(n)$

$a^{n+1} u(n)$

Shift Left

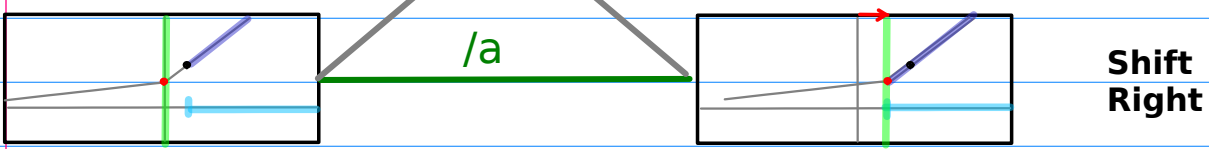

$a^n u(n-1)$

$a^{n-1} u(n-1)$

Shift Right

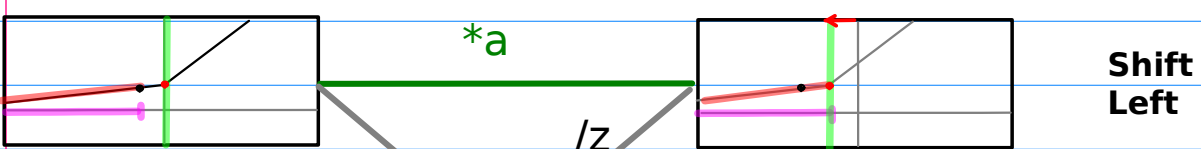

$a^n u(-n-1)$

$a^{n+1} u(-n-1)$

Shift Left

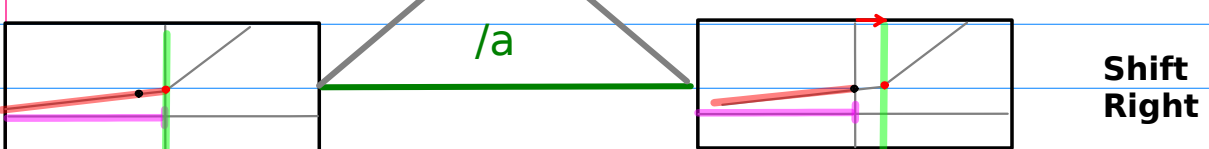

$a^n u(-n)$

$a^{n-1} u(-n)$

Shift Right

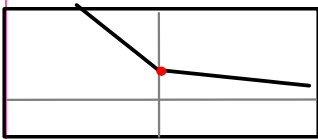
a^{-n} 

Shifting a sequence

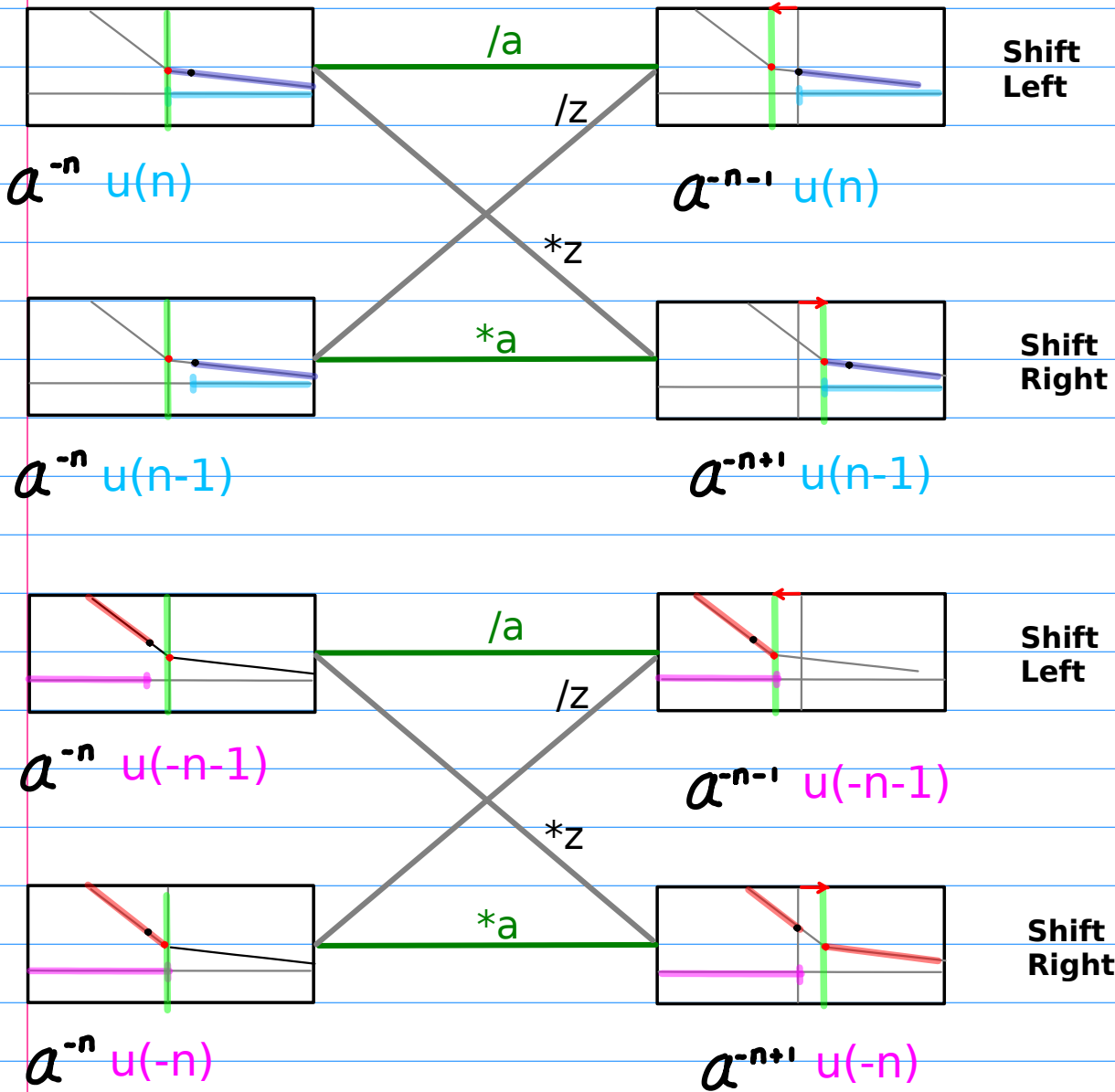
 $/z \quad n \leftarrow n+1$
 $*z \quad n \leftarrow n-1$

Geometric Series Form Combinations with a unit start term unshifted

$$(1) \quad + \frac{1}{1 - az}$$

$a^n u(n)$

$$(2) \quad + \frac{1}{1 - a^{-1}z}$$

$a^{-n} u(n)$

$$(3) \quad - \frac{1}{1 - a^{-1}z^{-1}}$$

$-a^n u(-n)$

$$(4) \quad - \frac{1}{1 - az^{-1}}$$

$-a^{-n} u(-n)$

$$(1)' \quad + \frac{1}{1 - a^{-1}z}$$

$a^n u(n)$

$$(2)' \quad + \frac{1}{1 - az}$$

$a^n u(n)$

$$(3)' \quad - \frac{1}{1 - az^{-1}}$$

$-a^{-n} u(-n)$

$$(4)' \quad - \frac{1}{1 - a^{-1}z^{-1}}$$

$-a^{-n} u(-n)$

Geometric Series Form Combinations with a common-ratio start term **unshifted, complementary**

$$(5) \quad \frac{a^{-1}z^{-1}}{1 - a^{-1}z^{-1}} \quad -a^n u(-n-1)$$

$$(6) \quad \frac{az^{-1}}{1 - az^{-1}} \quad -a^{-n} u(-n-1)$$

$$(7) \quad \frac{az}{1 - az} \quad a^n u(n-1)$$

$$(8) \quad \frac{a^{-1}z}{1 - a^{-1}z} \quad a^{-n} u(n-1)$$

$$(5)' \quad \frac{az^{-1}}{1 - az^{-1}} \quad -a^{-n} u(-n-1)$$

$$(6)' \quad \frac{a^{-1}z^{-1}}{1 - a^{-1}z^{-1}} \quad -a^n u(-n-1)$$

$$(7)' \quad \frac{a^{-1}z}{1 - a^{-1}z} \quad a^{-n} u(n-1)$$

$$(8)' \quad \frac{az}{1 - az} \quad a^n u(n-1)$$

Geometric Series - a unit start term

Laurent Series unshifted

Geometric Series - a unit start term

z-Transform unshifted

Geometric Series - a unit start term

Laurent Series vs. z-Transform unshifted

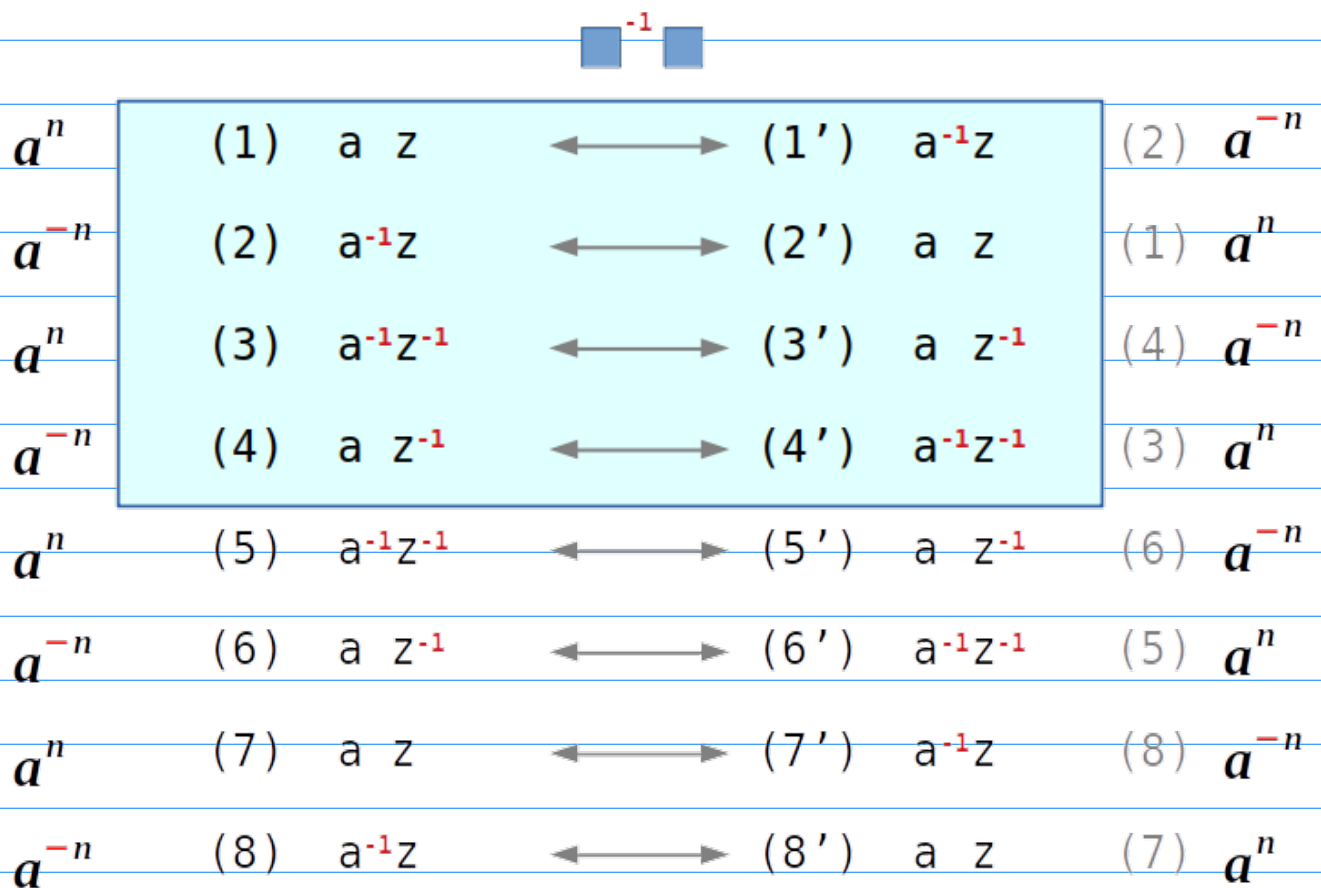

(1') ~ (8') redundant cases

Geometric Series - a unit start term

Laurent Series

(1) $\frac{1}{1 - az}$ $|z| < a^{-1}$

$$(a^0 z^0 + a^1 z^1 + a^2 z^2 + \dots)$$

$$a^n u(n) \quad (n \geq 0)$$

(2) $\frac{1}{1 - a^{-1}z}$ $|z| < a$

$$(a^0 z^0 + a^1 z^1 + a^2 z^2 + \dots)$$

$$\left(\left(\frac{1}{a}\right)^0 z^0 + \left(\frac{1}{a}\right)^1 z^1 + \left(\frac{1}{a}\right)^2 z^2 + \dots\right)$$

$$\left(\frac{1}{a}\right)^n u(n) \quad (n \geq 0)$$

(3) $\frac{1}{1 - a^{-1}z^{-1}}$ $|z| > a^{-1}$

$$- (a^0 z^0 + a^1 z^1 + a^2 z^2 + \dots)$$

$$-a^n u(-n) \quad (n < 1)$$

(4) $\frac{1}{1 - az^{-1}}$ $|z| > a$

$$- (a^0 z^0 + a^1 z^1 + a^2 z^2 + \dots)$$

$$- \left(\left(\frac{1}{a}\right)^0 z^0 + \left(\frac{1}{a}\right)^1 z^1 + \left(\frac{1}{a}\right)^2 z^2 + \dots\right)$$

$$-\left(\frac{1}{a}\right)^n u(-n) \quad (n < 1)$$

(1') $\frac{1}{1 - a^{-1}z}$ $|z| < a$

$$(a^0 z^0 + a^1 z^1 + a^2 z^2 + \dots)$$

$$\left(\left(\frac{1}{a}\right)^0 z^0 + \left(\frac{1}{a}\right)^1 z^1 + \left(\frac{1}{a}\right)^2 z^2 + \dots\right)$$

$$\left(\frac{1}{a}\right)^n u(n) \quad (n \geq 0)$$

(2') $\frac{1}{1 - az}$ $|z| < a^{-1}$

$$(a^0 z^0 + a^1 z^1 + a^2 z^2 + \dots)$$

$$a^n u(n) \quad (n \geq 0)$$

(3') $\frac{1}{1 - az^{-1}}$ $|z| > a$

$$- (a^0 z^0 + a^1 z^1 + a^2 z^2 + \dots)$$

$$- \left(\left(\frac{1}{a}\right)^0 z^0 + \left(\frac{1}{a}\right)^1 z^1 + \left(\frac{1}{a}\right)^2 z^2 + \dots\right)$$

$$-\left(\frac{1}{a}\right)^n u(-n) \quad (n < 1)$$

(4') $\frac{1}{1 - a^{-1}z^{-1}}$ $|z| > a^{-1}$

$$- (a^0 z^0 + a^1 z^1 + a^2 z^2 + \dots)$$

$$-a^n u(-n) \quad (n < 1)$$

Geometric Series - a unit start term

z-Transform ($n \rightarrow -n$)

(1)
$$+ \frac{1}{1 - az}$$
 $|z| < a^{-1}$

$$(a^0 z^0 + a^1 z^1 + a^2 z^2 + \dots)$$

$$\left(\frac{1}{a}\right)^0 z^0 + \left(\frac{1}{a}\right)^1 z^1 + \left(\frac{1}{a}\right)^2 z^2 + \dots$$

$$a^n u(-n) \quad (n \geq 0)$$

$$\left(\frac{1}{a}\right)^n u(-n) \quad (n < 0)$$

(2)
$$+ \frac{1}{1 - a^{-1}z}$$
 $|z| < a$

$$(a^0 z^0 + a^1 z^1 + a^2 z^2 + \dots)$$

$$\left(\frac{1}{a}\right)^0 z^0 + \left(\frac{1}{a}\right)^1 z^1 + \left(\frac{1}{a}\right)^2 z^2 + \dots$$

$$\left(\frac{1}{a}\right)^{-n} u(-n) \quad (n \geq 0)$$

$$a^n u(-n) \quad (n < 0)$$

(3)
$$- \frac{1}{1 - a^{-1}z^{-1}}$$
 $|z| > a^{-1}$

$$- (a^0 z^0 + a^1 z^1 + a^2 z^2 + \dots)$$

$$- \left(\frac{1}{a}\right)^0 z^0 + \left(\frac{1}{a}\right)^1 z^1 + \left(\frac{1}{a}\right)^2 z^2 + \dots$$

$$- a^n u(-(-n)) \quad (n < 0)$$

$$- \left(\frac{1}{a}\right)^n u(n) \quad (n \geq 0)$$

(4)
$$- \frac{1}{1 - az^{-1}}$$
 $|z| > a$

$$- (a^0 z^0 + a^1 z^1 + a^2 z^2 + \dots)$$

$$- \left(\frac{1}{a}\right)^0 z^0 + \left(\frac{1}{a}\right)^1 z^1 + \left(\frac{1}{a}\right)^2 z^2 + \dots$$

$$- \left(\frac{1}{a}\right)^n u(-(-n)) \quad (n < 0)$$

$$- a^n u(n) \quad (n \geq 0)$$

(1')
$$+ \frac{1}{1 - a^{-1}z}$$
 $|z| < a$

$$(a^0 z^0 + a^1 z^1 + a^2 z^2 + \dots)$$

$$\left(\frac{1}{a}\right)^0 z^0 + \left(\frac{1}{a}\right)^1 z^1 + \left(\frac{1}{a}\right)^2 z^2 + \dots$$

$$\left(\frac{1}{a}\right)^{-n} u(-n) \quad (n \geq 0)$$

$$a^n u(-n) \quad (n < 0)$$

(2')
$$+ \frac{1}{1 - az}$$
 $|z| < a^{-1}$

$$(a^0 z^0 + a^1 z^1 + a^2 z^2 + \dots)$$

$$\left(\frac{1}{a}\right)^0 z^0 + \left(\frac{1}{a}\right)^1 z^1 + \left(\frac{1}{a}\right)^2 z^2 + \dots$$

$$a^n u(-n) \quad (n \geq 0)$$

$$\left(\frac{1}{a}\right)^n u(-n) \quad (n < 0)$$

(3')
$$- \frac{1}{1 - az^{-1}}$$
 $|z| > a$

$$- (a^0 z^0 + a^1 z^1 + a^2 z^2 + \dots)$$

$$- \left(\frac{1}{a}\right)^0 z^0 + \left(\frac{1}{a}\right)^1 z^1 + \left(\frac{1}{a}\right)^2 z^2 + \dots$$

$$- \left(\frac{1}{a}\right)^{-n} u(-(-n)) \quad (n < 0)$$

$$- a^n u(n) \quad (n \geq 0)$$

(4')
$$- \frac{1}{1 - a^{-1}z^{-1}}$$
 $|z| > a^{-1}$

$$- (a^0 z^0 + a^1 z^1 + a^2 z^2 + \dots)$$

$$- \left(\frac{1}{a}\right)^0 z^0 + \left(\frac{1}{a}\right)^1 z^1 + \left(\frac{1}{a}\right)^2 z^2 + \dots$$

$$- a^n u(-(-n)) \quad (n < 0)$$

$$- \left(\frac{1}{a}\right)^n u(n) \quad (n \geq 0)$$

Geometric Series - a unit start term

Laurent Series vs. z-Transform ($n \rightarrow -n$)

(1) $\boxed{+ \frac{1}{1 - az}} \quad \boxed{|z| < a^{-1}}$ $\boxed{+ \frac{1}{1 - a^{-1}z}} \quad \boxed{|z| < a}$ (2)

$$(a^0 z^0 + a^1 z^1 + a^2 z^2 + \dots)$$

$$(a^0 z^0 + a^1 z^1 + a^2 z^2 + \dots)$$

$$\left(\left(\frac{1}{a}\right)^0 z^0 + \left(\frac{1}{a}\right)^1 z^1 + \left(\frac{1}{a}\right)^2 z^2 + \dots\right)$$

$$\left(\left(\frac{1}{a}\right)^0 z^0 + \left(\frac{1}{a}\right)^1 z^1 + \left(\frac{1}{a}\right)^2 z^2 + \dots\right)$$

Laurent	$a^n u(n)$	$(n \geq 0)$
z-Trans	$\left(\frac{1}{a}\right)^n u(-n)$	$(n < 1)$

Laurent	$\left(\frac{1}{a}\right)^n u(n)$	$(n \geq 0)$
z-Trans	$a^n u(-n)$	$(n < 1)$

(3) $\boxed{- \frac{1}{1 - a^{-1}z^{-1}}} \quad \boxed{|z| > a^{-1}}$ $\boxed{- \frac{1}{1 - az^{-1}}} \quad \boxed{|z| > a}$ (4)

$$- (a^0 z^0 + a^1 z^1 + a^2 z^2 + \dots)$$

$$- (a^0 z^0 + a^1 z^1 + a^2 z^2 + \dots)$$

$$- \left(\left(\frac{1}{a}\right)^0 z^0 + \left(\frac{1}{a}\right)^1 z^1 + \left(\frac{1}{a}\right)^2 z^2 + \dots\right)$$

$$- \left(\left(\frac{1}{a}\right)^0 z^0 + \left(\frac{1}{a}\right)^1 z^1 + \left(\frac{1}{a}\right)^2 z^2 + \dots\right)$$

Laurent	$-a^n u(-n)$	$(n < 1)$
z-Trans	$-\left(\frac{1}{a}\right)^n u(n)$	$(n \geq 0)$

Laurent	$-\left(\frac{1}{a}\right)^n u(-n)$	$(n < 1)$
z-Trans	$-a^n u(n)$	$(n \geq 0)$

(1') $\boxed{+ \frac{1}{1 - a^{-1}z}} \quad \boxed{|z| < a}$ $\boxed{+ \frac{1}{1 - az}} \quad \boxed{|z| < a^{-1}}$ (2')

$$(a^0 z^0 + a^1 z^1 + a^2 z^2 + \dots)$$

$$(a^0 z^0 + a^1 z^1 + a^2 z^2 + \dots)$$

$$\left(\left(\frac{1}{a}\right)^0 z^0 + \left(\frac{1}{a}\right)^1 z^1 + \left(\frac{1}{a}\right)^2 z^2 + \dots\right)$$

$$\left(\left(\frac{1}{a}\right)^0 z^0 + \left(\frac{1}{a}\right)^1 z^1 + \left(\frac{1}{a}\right)^2 z^2 + \dots\right)$$

Laurent	$\left(\frac{1}{a}\right)^n u(n)$	$(n \geq 0)$
z-Trans	$a^n u(-n)$	$(n < 1)$

Laurent	$a^n u(n)$	$(n \geq 0)$
z-Trans	$\left(\frac{1}{a}\right)^n u(-n)$	$(n < 1)$

(3') $\boxed{- \frac{1}{1 - az^{-1}}} \quad \boxed{|z| > a}$ $\boxed{- \frac{1}{1 - a^{-1}z^{-1}}} \quad \boxed{|z| > a^{-1}}$ (4')

$$- (a^0 z^0 + a^1 z^1 + a^2 z^2 + \dots)$$

$$- (a^0 z^0 + a^1 z^1 + a^2 z^2 + \dots)$$

$$- \left(\left(\frac{1}{a}\right)^0 z^0 + \left(\frac{1}{a}\right)^1 z^1 + \left(\frac{1}{a}\right)^2 z^2 + \dots\right)$$

$$- \left(\left(\frac{1}{a}\right)^0 z^0 + \left(\frac{1}{a}\right)^1 z^1 + \left(\frac{1}{a}\right)^2 z^2 + \dots\right)$$

Laurent	$-\left(\frac{1}{a}\right)^n u(-n)$	$(n < 1)$
z-Trans	$-a^n u(n)$	$(n \geq 0)$

Laurent	$-a^n u(-n)$	$(n < 1)$
z-Trans	$-\left(\frac{1}{a}\right)^n u(n)$	$(n \geq 0)$

Geometric Series - a non-unit start term

Laurent Series unshifted, complementary

Geometric Series - a non-unit start term

z-Transform unshifted, complementary

Geometric Series - a non-unit start term

Laurent Series vs. z-Transform unshifted, complementary

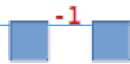

a^n (1) $a z$ \longleftrightarrow (1') $a^{-1}z$ (2) a^{-n}

a^{-n} (2) $a^{-1}z$ \longleftrightarrow (2') $a z$ (1) a^n

a^n (3) $a^{-1}z^{-1}$ \longleftrightarrow (3') $a z^{-1}$ (4) a^{-n}

a^{-n} (4) $a z^{-1}$ \longleftrightarrow (4') $a^{-1}z^{-1}$ (3) a^n

a^n (5) $a^{-1}z^{-1}$ \longleftrightarrow (5') $a z^{-1}$ (6) a^{-n}

a^{-n} (6) $a z^{-1}$ \longleftrightarrow (6') $a^{-1}z^{-1}$ (5) a^n

a^n (7) $a z$ \longleftrightarrow (7') $a^{-1}z$ (8) a^{-n}

a^{-n} (8) $a^{-1}z$ \longleftrightarrow (8') $a z$ (7) a^n

(1') ~ (8') redundant cases

Geometric Series - a non-unit start term

Laurent Series

(5)
$$-\frac{a^{-1}z^{-1}}{1-a^{-1}z^{-1}} \quad |z| > a^{-1}$$

$$-(a^{-1}z^{-1} + a^{-2}z^{-2} + a^{-3}z^{-3} + \dots)$$

$$-a^n u(-n-1) \quad (n < 0)$$

(6)
$$-\frac{az^{-1}}{1-az^{-1}} \quad |z| > a$$

$$-(a^1z^{-1} + a^2z^{-2} + a^3z^{-3} + \dots)$$

$$-((\frac{1}{a})^1z^{-1} + (\frac{1}{a})^2z^{-2} + (\frac{1}{a})^3z^{-3} + \dots)$$

$$-(\frac{1}{a})^n u(-n-1) \quad (n < 0)$$

(7)
$$+\frac{az}{1-az} \quad |z| < a^{-1}$$

$$(a^1z^1 + a^2z^2 + a^3z^3 + \dots)$$

$$a^n u(n-1) \quad (n \geq 1)$$

(8)
$$+\frac{a^{-1}z}{1-a^{-1}z} \quad |z| < a$$

$$(a^{-1}z^1 + a^{-2}z^2 + a^{-3}z^3 + \dots)$$

$$((\frac{1}{a})^1z^1 + (\frac{1}{a})^2z^2 + (\frac{1}{a})^3z^3 + \dots)$$

$$(\frac{1}{a})^n u(n-1) \quad (n \geq 1)$$

(5')
$$-\frac{az^{-1}}{1-az^{-1}} \quad |z| > a$$

$$-(a^1z^{-1} + a^2z^{-2} + a^3z^{-3} + \dots)$$

$$-((\frac{1}{a})^1z^{-1} + (\frac{1}{a})^2z^{-2} + (\frac{1}{a})^3z^{-3} + \dots)$$

$$-(\frac{1}{a})^n u(-n-1) \quad (n < 0)$$

(6')
$$-\frac{a^{-1}z^{-1}}{1-a^{-1}z^{-1}} \quad |z| > a^{-1}$$

$$-(a^{-1}z^{-1} + a^{-2}z^{-2} + a^{-3}z^{-3} + \dots)$$

$$-a^n u(-n-1) \quad (n < 0)$$

(7')
$$+\frac{a^{-1}z}{1-a^{-1}z} \quad |z| < a$$

$$(a^{-1}z^1 + a^{-2}z^2 + a^{-3}z^3 + \dots)$$

$$((\frac{1}{a})^1z^1 + (\frac{1}{a})^2z^2 + (\frac{1}{a})^3z^3 + \dots)$$

$$(\frac{1}{a})^n u(n-1) \quad (n \geq 1)$$

(8')
$$+\frac{az}{1-az} \quad |z| < a^{-1}$$

$$(a^1z^1 + a^2z^2 + a^3z^3 + \dots)$$

$$a^n u(n-1) \quad (n \geq 1)$$

Geometric Series - a non-unit start term

z-Transform ($n \rightarrow -n$)

(5)

$$\frac{a^{-1}z^{-1}}{1 - a^{-1}z^{-1}}$$

$$|z| > a^{-1}$$

$$- (a^{-1}z^{-1} + a^{-2}z^{-2} + a^{-3}z^{-3} + \dots)$$

$$- \left(\left(\frac{1}{a}\right)^1 z^{-1} + \left(\frac{1}{a}\right)^2 z^{-2} + \left(\frac{1}{a}\right)^3 z^{-3} + \dots \right)$$

$$- a^{-n} u(-(-n)-1) \quad (n < 0)$$

$$- \left(\frac{1}{a}\right)^n u(n-1) \quad (n \geq 1)$$

(6)

$$\frac{az^{-1}}{1 - az^{-1}}$$

$$|z| > a$$

$$- (a^1 z^{-1} + a^2 z^{-2} + a^3 z^{-3} + \dots)$$

$$- \left(\left(\frac{1}{a}\right)^1 z^{-1} + \left(\frac{1}{a}\right)^2 z^{-2} + \left(\frac{1}{a}\right)^3 z^{-3} + \dots \right)$$

$$- \left(\frac{1}{a}\right)^n u(-(-n)-1) \quad (n < 0)$$

$$- a^n u(n-1) \quad (n \geq 1)$$

(7)

$$+ \frac{az}{1 - az}$$

$$|z| < a^{-1}$$

$$(a^1 z^1 + a^2 z^2 + a^3 z^3 + \dots)$$

$$\left(\left(\frac{1}{a}\right)^1 z^1 + \left(\frac{1}{a}\right)^2 z^2 + \left(\frac{1}{a}\right)^3 z^3 + \dots \right)$$

$$a^n u((-n)-1) \quad (n \geq 1)$$

$$\left(\frac{1}{a}\right)^n u(-n-1) \quad (n < 0)$$

(8)

$$+ \frac{a^{-1}z}{1 - a^{-1}z}$$

$$|z| < a$$

$$(a^{-1} z^1 + a^{-2} z^2 + a^{-3} z^3 + \dots)$$

$$\left(\left(\frac{1}{a}\right)^1 z^1 + \left(\frac{1}{a}\right)^2 z^2 + \left(\frac{1}{a}\right)^3 z^3 + \dots \right)$$

$$\left(\frac{1}{a}\right)^n u((-n)-1) \quad (n \geq 1)$$

$$a^n u(-n-1) \quad (n < 0)$$

(5')

$$\frac{az^{-1}}{1 - az^{-1}}$$

$$|z| > a$$

$$- (a^1 z^{-1} + a^2 z^{-2} + a^3 z^{-3} + \dots)$$

$$- \left(\left(\frac{1}{a}\right)^1 z^{-1} + \left(\frac{1}{a}\right)^2 z^{-2} + \left(\frac{1}{a}\right)^3 z^{-3} + \dots \right)$$

$$- \left(\frac{1}{a}\right)^n u(-(-n)-1) \quad (n < 0)$$

$$- a^n u(n-1) \quad (n \geq 1)$$

(6')

$$\frac{a^{-1}z^{-1}}{1 - a^{-1}z^{-1}}$$

$$|z| > a^{-1}$$

$$- (a^{-1} z^{-1} + a^{-2} z^{-2} + a^{-3} z^{-3} + \dots)$$

$$- \left(\left(\frac{1}{a}\right)^1 z^{-1} + \left(\frac{1}{a}\right)^2 z^{-2} + \left(\frac{1}{a}\right)^3 z^{-3} + \dots \right)$$

$$- a^{-n} u(-(-n)-1) \quad (n < 0)$$

$$- \left(\frac{1}{a}\right)^n u(n-1) \quad (n \geq 1)$$

(7')

$$+ \frac{a^{-1}z}{1 - a^{-1}z}$$

$$|z| < a$$

$$(a^{-1} z^1 + a^{-2} z^2 + a^{-3} z^3 + \dots)$$

$$\left(\left(\frac{1}{a}\right)^1 z^1 + \left(\frac{1}{a}\right)^2 z^2 + \left(\frac{1}{a}\right)^3 z^3 + \dots \right)$$

$$\left(\frac{1}{a}\right)^n u((-n)-1) \quad (n \geq 1)$$

$$a^n u(-n-1) \quad (n < 0)$$

(8')

$$+ \frac{az}{1 - az}$$

$$|z| < a^{-1}$$

$$(a^1 z^1 + a^2 z^2 + a^3 z^3 + \dots)$$

$$\left(\left(\frac{1}{a}\right)^1 z^1 + \left(\frac{1}{a}\right)^2 z^2 + \left(\frac{1}{a}\right)^3 z^3 + \dots \right)$$

$$a^n u((-n)-1) \quad (n \geq 1)$$

$$\left(\frac{1}{a}\right)^n u(-n-1) \quad (n < 0)$$

Geometric Series - a non-unit start term

Laurent Series vs. z-Transform ($n \rightarrow -n$)

(5) $\frac{a^{-1}z^{-1}}{1-a^{-1}z^{-1}}$ $|z| > a^{-1}$ $\frac{az^{-1}}{1-az^{-1}}$ $|z| > a$ (6)

$$-(a^{-1}z^{-1} + a^{-2}z^{-2} + a^{-3}z^{-3} + \dots)$$

$$-((\frac{1}{a})^1 z^{-1} + (\frac{1}{a})^2 z^{-2} + (\frac{1}{a})^3 z^{-3} + \dots)$$

$$-(a^1 z^{-1} + a^2 z^{-2} + a^3 z^{-3} + \dots)$$

$$-((\frac{1}{a})^1 z^{-1} + (\frac{1}{a})^2 z^{-2} + (\frac{1}{a})^3 z^{-3} + \dots)$$

Laurent	$-a^n u(-n-1)$	$(n < 0)$
z-Trans	$-(\frac{1}{a})^n u(n-1)$	$(n \geq 1)$

Laurent	$-(\frac{1}{a})^n u(-n-1)$	$(n < 0)$
z-Trans	$-a^n u(n-1)$	$(n \geq 1)$

(7) $+\frac{az}{1-az}$ $|z| < a^{-1}$ $+\frac{a^{-1}z}{1-a^{-1}z}$ $|z| < a$ (8)

$$(a^1 z^1 + a^2 z^2 + a^3 z^3 + \dots)$$

$$((\frac{1}{a})^1 z^1 + (\frac{1}{a})^2 z^2 + (\frac{1}{a})^3 z^3 + \dots)$$

$$(a^{-1} z^1 + a^{-2} z^2 + a^{-3} z^3 + \dots)$$

$$((\frac{1}{a})^1 z^1 + (\frac{1}{a})^2 z^2 + (\frac{1}{a})^3 z^3 + \dots)$$

Laurent	$a^n u(n-1)$	$(n \geq 1)$
z-Trans	$(\frac{1}{a})^n u(-n-1)$	$(n < 0)$

Laurent	$(\frac{1}{a})^n u(n-1)$	$(n \geq 1)$
z-Trans	$a^n u(-n-1)$	$(n < 0)$

(5') $\frac{az^{-1}}{1-az^{-1}}$ $|z| > a$ $\frac{a^{-1}z^{-1}}{1-a^{-1}z^{-1}}$ $|z| > a^{-1}$ (6')

$$-(a^1 z^{-1} + a^2 z^{-2} + a^3 z^{-3} + \dots)$$

$$-((\frac{1}{a})^1 z^{-1} + (\frac{1}{a})^2 z^{-2} + (\frac{1}{a})^3 z^{-3} + \dots)$$

$$-(a^{-1} z^{-1} + a^{-2} z^{-2} + a^{-3} z^{-3} + \dots)$$

$$-((\frac{1}{a})^1 z^{-1} + (\frac{1}{a})^2 z^{-2} + (\frac{1}{a})^3 z^{-3} + \dots)$$

Laurent	$-(\frac{1}{a})^n u(-n-1)$	$(n < 0)$
z-Trans	$-a^n u(n-1)$	$(n \geq 1)$

Laurent	$-a^n u(-n-1)$	$(n < 0)$
z-Trans	$-(\frac{1}{a})^n u(n-1)$	$(n \geq 1)$

(7') $+\frac{a^{-1}z}{1-a^{-1}z}$ $|z| < a$ $+\frac{az}{1-az}$ $|z| < a^{-1}$ (8')

$$(a^{-1} z^1 + a^{-2} z^2 + a^{-3} z^3 + \dots)$$

$$((\frac{1}{a})^1 z^1 + (\frac{1}{a})^2 z^2 + (\frac{1}{a})^3 z^3 + \dots)$$

$$(a^1 z^1 + a^2 z^2 + a^3 z^3 + \dots)$$

$$((\frac{1}{a})^1 z^1 + (\frac{1}{a})^2 z^2 + (\frac{1}{a})^3 z^3 + \dots)$$

Laurent	$(\frac{1}{a})^n u(n-1)$	$(n \geq 1)$
z-Trans	$a^n u(-n-1)$	$(n < 0)$

Laurent	$a^n u(n-1)$	$(n \geq 1)$
z-Trans	$(\frac{1}{a})^n u(-n-1)$	$(n < 0)$

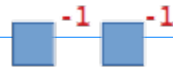

a^n	(1) a z	\longleftrightarrow	(5) $a^{-1}z^{-1}$	a^n
a^{-n}	(2) $a^{-1}z$	\longleftrightarrow	(6) a z ⁻¹	a^{-n}
a^n	(3) $a^{-1}z^{-1}$	\longleftrightarrow	(7) a z	a^n
a^{-n}	(4) a z ⁻¹	\longleftrightarrow	(8) $a^{-1}z$	a^{-n}
a^{-n}	(2) (1') $a^{-1}z$	\longleftrightarrow	(5') a z ⁻¹ (6)	a^{-n}
a^n	(1) (2') a z	\longleftrightarrow	(6') $a^{-1}z^{-1}$ (5)	a^n
a^{-n}	(4) (3') a z ⁻¹	\longleftrightarrow	(7') $a^{-1}z$ (8)	a^{-n}
a^n	(3) (4') $a^{-1}z^{-1}$	\longleftrightarrow	(8') a z (7)	a^n

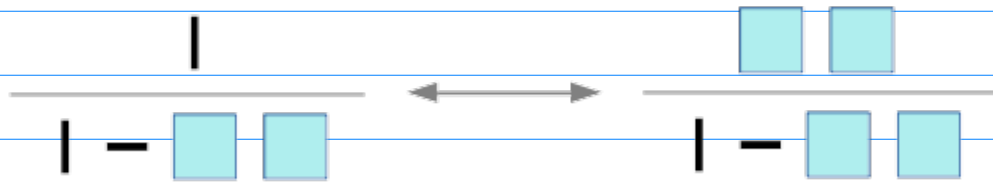

a unit start term

unshifted

a non-unit start term

unshifted, complementary

(1') ~ (8') redundant cases

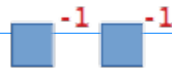

a^n	(1) a z	\longleftrightarrow	(5) $a^{-1}z^{-1}$	a^n
a^n	(3) $a^{-1}z^{-1}$	\longleftrightarrow	(7) a z	a^n
a^{-n}	(2) $a^{-1}z$	\longleftrightarrow	(6) a z ⁻¹	a^{-n}
a^{-n}	(4) a z ⁻¹	\longleftrightarrow	(8) $a^{-1}z$	a^{-n}
a^n	(1) (2') a z	\longleftrightarrow	(6') $a^{-1}z^{-1}$ (5)	a^n
a^n	(3) (4') $a^{-1}z^{-1}$	\longleftrightarrow	(8') a z (7)	a^n
a^{-n}	(2) (1') $a^{-1}z$	\longleftrightarrow	(5') a z ⁻¹ (6)	a^{-n}
a^{-n}	(4) (3') a z ⁻¹	\longleftrightarrow	(7') $a^{-1}z$ (8)	a^{-n}

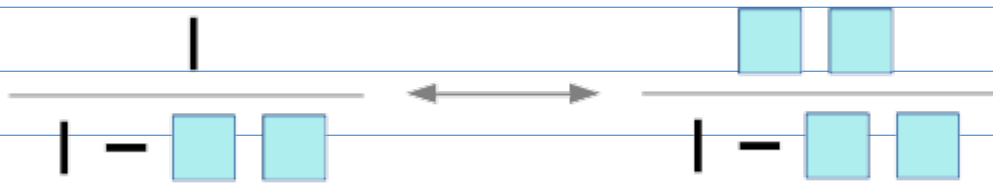

a unit start term
unshifted

a non-unit start term
unshifted, complementary

(1') ~ (8') redundant cases

unshifted
complementary

$$\begin{array}{l} (1) \quad a z \quad \mathbf{a}^n \\ (5) \quad a^{-1} z^{-1} \quad \mathbf{a}^n \end{array}$$

$$\begin{array}{l} (2) \quad a^{-1} z \quad \mathbf{a}^{-n} \\ (6) \quad a z^{-1} \quad \mathbf{a}^{-n} \end{array}$$

unshifted
complementary

$$\begin{array}{l} (3) \quad a^{-1} z^{-1} \quad \mathbf{a}^n \\ (7) \quad a z \quad \mathbf{a}^n \end{array}$$

$$\begin{array}{l} (4) \quad a z^{-1} \quad \mathbf{a}^{-n} \\ (8) \quad a^{-1} z \quad \mathbf{a}^{-n} \end{array}$$

unshifted
complementary

$$\begin{array}{l} (1') \quad a^{-1} z \quad \mathbf{a}^{-n} \\ (5') \quad a z^{-1} \quad \mathbf{a}^{-n} \end{array}$$

$$\begin{array}{l} (2') \quad a z \quad \mathbf{a}^n \\ (6') \quad a^{-1} z^{-1} \quad \mathbf{a}^n \end{array}$$

unshifted
complementary

$$\begin{array}{l} (3') \quad a z^{-1} \quad \mathbf{a}^{-n} \\ (7') \quad a^{-1} z \quad \mathbf{a}^{-n} \end{array}$$

$$\begin{array}{l} (4') \quad a^{-1} z^{-1} \quad \mathbf{a}^n \\ (8') \quad a z \quad \mathbf{a}^n \end{array}$$

unshifted
complementary

$$\begin{array}{l} (1) \quad a z \quad \mathbf{*a} \\ (5) \quad a^{-1} z^{-1} \quad \mathbf{*a} \end{array}$$

$$\begin{array}{l} (2) \quad a^{-1} z \quad \mathbf{*z} \\ (6) \quad a z^{-1} \quad \mathbf{*z} \end{array}$$

unshifted
complementary

$$\begin{array}{l} (3) \quad a^{-1} z^{-1} \quad \mathbf{/z} \\ (7) \quad a z \quad \mathbf{/z} \end{array}$$

$$\begin{array}{l} (4) \quad a z^{-1} \quad \mathbf{*a} \\ (8) \quad a^{-1} z \quad \mathbf{*a} \end{array}$$

unshifted
complementary

$$\begin{array}{l} (1') \quad a^{-1} z \quad \mathbf{/a} \\ (5') \quad a z^{-1} \quad \mathbf{/a} \end{array}$$

$$\begin{array}{l} (2') \quad a z \quad \mathbf{*z} \\ (6') \quad a^{-1} z^{-1} \quad \mathbf{*z} \end{array}$$

unshifted
complementary

$$\begin{array}{l} (3') \quad a z^{-1} \quad \mathbf{/z} \\ (7') \quad a^{-1} z \quad \mathbf{/z} \end{array}$$

$$\begin{array}{l} (4') \quad a^{-1} z^{-1} \quad \mathbf{/a} \\ (8') \quad a z \quad \mathbf{/a} \end{array}$$

unshifted
complementary

$$\begin{array}{l} (1) \quad a \quad z \quad \mathbf{a}^n \\ (5) \quad a^{-1}z^{-1} \quad \mathbf{a}^n \end{array}$$

$$\begin{array}{l} (2) \quad a^{-1}z \quad \mathbf{a}^{-n} \\ (6) \quad a \quad z^{-1} \quad \mathbf{a}^{-n} \end{array}$$

unshifted
complementary

$$\begin{array}{l} (3) \quad a^{-1}z^{-1} \quad \mathbf{a}^n \\ (7) \quad a \quad z \quad \mathbf{a}^n \end{array}$$

$$\begin{array}{l} (4) \quad a \quad z^{-1} \quad \mathbf{a}^{-n} \\ (8) \quad a^{-1}z \quad \mathbf{a}^{-n} \end{array}$$

unshifted
complementary

$$\begin{array}{l} (2') \quad a \quad z \quad \mathbf{a}^n \\ (6') \quad a^{-1}z^{-1} \quad \mathbf{a}^n \end{array}$$

$$\begin{array}{l} (1') \quad a^{-1}z \quad \mathbf{a}^{-n} \\ (5') \quad a \quad z^{-1} \quad \mathbf{a}^{-n} \end{array}$$

unshifted
complementary

$$\begin{array}{l} (4') \quad a^{-1}z^{-1} \quad \mathbf{a}^n \\ (8') \quad a \quad z \quad \mathbf{a}^n \end{array}$$

$$\begin{array}{l} (3') \quad a \quad z^{-1} \quad \mathbf{a}^{-n} \\ (7') \quad a^{-1}z \quad \mathbf{a}^{-n} \end{array}$$

unshifted
complementary

$$\begin{array}{l} (1) \quad a \quad z \quad \mathbf{*a} \\ (5) \quad a^{-1}z^{-1} \quad \mathbf{*a} \end{array}$$

$$\begin{array}{l} (2) \quad a^{-1}z \quad \mathbf{*z} \\ (6) \quad a \quad z^{-1} \quad \mathbf{*z} \end{array}$$

unshifted
complementary

$$\begin{array}{l} (3) \quad a^{-1}z^{-1} \quad \mathbf{/z} \\ (7) \quad a \quad z \quad \mathbf{/z} \end{array}$$

$$\begin{array}{l} (4) \quad a \quad z^{-1} \quad \mathbf{*a} \\ (8) \quad a^{-1}z \quad \mathbf{*a} \end{array}$$

unshifted
complementary

$$\begin{array}{l} (2') \quad a \quad z \quad \mathbf{*z} \\ (6') \quad a^{-1}z^{-1} \quad \mathbf{*z} \end{array}$$

$$\begin{array}{l} (1') \quad a^{-1}z \quad \mathbf{/a} \\ (5') \quad a \quad z^{-1} \quad \mathbf{/a} \end{array}$$

unshifted
complementary

$$\begin{array}{l} (4') \quad a^{-1}z^{-1} \quad \mathbf{/a} \\ (8') \quad a \quad z \quad \mathbf{/a} \end{array}$$

$$\begin{array}{l} (3') \quad a \quad z^{-1} \quad \mathbf{/z} \\ (7') \quad a^{-1}z \quad \mathbf{/z} \end{array}$$

Complement ROC Pairs - Original Geometric Series Form Combinations

(1) / (5)		
unit	$\frac{1}{1-az}$ $ z < a^{-1}$	$a^n u(n)$
non-unit	$-\frac{a^{-1}z^{-1}}{1-a^{-1}z^{-1}}$ $ z > a^{-1}$	$-a^n u(-n-1)$
(3) / (7)		
unit	$-\frac{1}{1-a^{-1}z^{-1}}$ $ z > a^{-1}$	$-a^n u(-n)$
non-unit	$\frac{az}{1-az}$ $ z < a^{-1}$	$a^n u(n-1)$

(2) / (6)		
unit	$\frac{1}{1-a^{-1}z}$ $ z < a$	$(\frac{1}{a})^n u(n)$
non-unit	$-\frac{az^{-1}}{1-az^{-1}}$ $ z > a$	$-(\frac{1}{a})^n u(-n-1)$
(4) / (8)		
unit	$-\frac{1}{1-az^{-1}}$ $ z > a$	$-(\frac{1}{a})^n u(-n)$
non-unit	$\frac{a^{-1}z}{1-a^{-1}z}$ $ z < a$	$(\frac{1}{a})^n u(n-1)$

(1') / (5')		
unit	$\frac{1}{1-a^{-1}z}$ $ z < a$	$(\frac{1}{a})^n u(n)$
non-unit	$-\frac{az^{-1}}{1-az^{-1}}$ $ z > a$	$-(\frac{1}{a})^n u(-n-1)$
(3') / (7')		
unit	$-\frac{1}{1-az^{-1}}$ $ z > a$	$-(\frac{1}{a})^n u(-n)$
non-unit	$\frac{a^{-1}z}{1-a^{-1}z}$ $ z < a$	$(\frac{1}{a})^n u(n-1)$

(2') / (6')		
unit	$\frac{1}{1-az}$ $ z < a^{-1}$	$a^n u(n)$
non-unit	$-\frac{a^{-1}z^{-1}}{1-a^{-1}z^{-1}}$ $ z > a^{-1}$	$-a^n u(-n-1)$
(4') / (8')		
unit	$-\frac{1}{1-a^{-1}z^{-1}}$ $ z > a^{-1}$	$-a^n u(-n)$
non-unit	$\frac{az}{1-az}$ $ z < a^{-1}$	$a^n u(n-1)$

start term

Complement ROC Pairs - Shifted Geometric Series Form Combinations

(1) / (5) *a

$$\frac{a}{1-az} \quad |z| < a^{-1} \quad a^{n+1} u(n)$$

$$-\frac{z^{-1}}{1-a^{-1}z^{-1}} \quad |z| > a^{-1} \quad -a^{n+1} u(-n-1)$$

(3) / (7) /z

$$-\frac{z^{-1}}{1-a^{-1}z^{-1}} \quad |z| > a^{-1} \quad -a^{n+1} u(-n-1)$$

$$\frac{a}{1-az} \quad |z| < a^{-1} \quad a^{n+1} u(n)$$

(2) / (6) *z

$$\frac{z}{1-a^{-1}z} \quad |z| < a \quad \left(\frac{1}{a}\right)^{n-1} u(n-1)$$

$$-\frac{a}{1-az^{-1}} \quad |z| > a \quad -\left(\frac{1}{a}\right)^{n-1} u(-n)$$

(4) / (8) *a

$$-\frac{a}{1-az^{-1}} \quad |z| > a \quad -\left(\frac{1}{a}\right)^{n-1} u(-n)$$

$$\frac{z}{1-a^{-1}z} \quad |z| < a \quad \left(\frac{1}{a}\right)^{n-1} u(n-1)$$

(1') / (5') /a

$$\frac{a^{-1}}{1-a^{-1}z} \quad |z| < a \quad \left(\frac{1}{a}\right)^{n+1} u(n)$$

$$-\frac{z^{-1}}{1-az^{-1}} \quad |z| > a \quad -\left(\frac{1}{a}\right)^{n+1} u(-n-1)$$

(3') / (7') /z

$$-\frac{z^{-1}}{1-az^{-1}} \quad |z| > a \quad -\left(\frac{1}{a}\right)^{n+1} u(-n-1)$$

$$\frac{a^{-1}}{1-a^{-1}z} \quad |z| < a \quad \left(\frac{1}{a}\right)^{n+1} u(n)$$

(2') / (6') *z

$$\frac{z}{1-az} \quad |z| < a^{-1} \quad a^{n-1} u(n-1)$$

$$-\frac{a^{-1}}{1-a^{-1}z^{-1}} \quad |z| > a^{-1} \quad -a^{n-1} u(-n)$$

(4') / (8') /a

$$-\frac{a^{-1}}{1-a^{-1}z^{-1}} \quad |z| > a^{-1} \quad -a^{n-1} u(-n)$$

$$\frac{z}{1-az} \quad |z| < a^{-1} \quad a^{n-1} u(n-1)$$

a^n

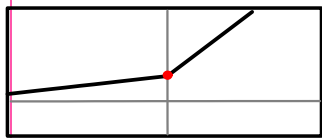

*a
/a

Shifting a sequence

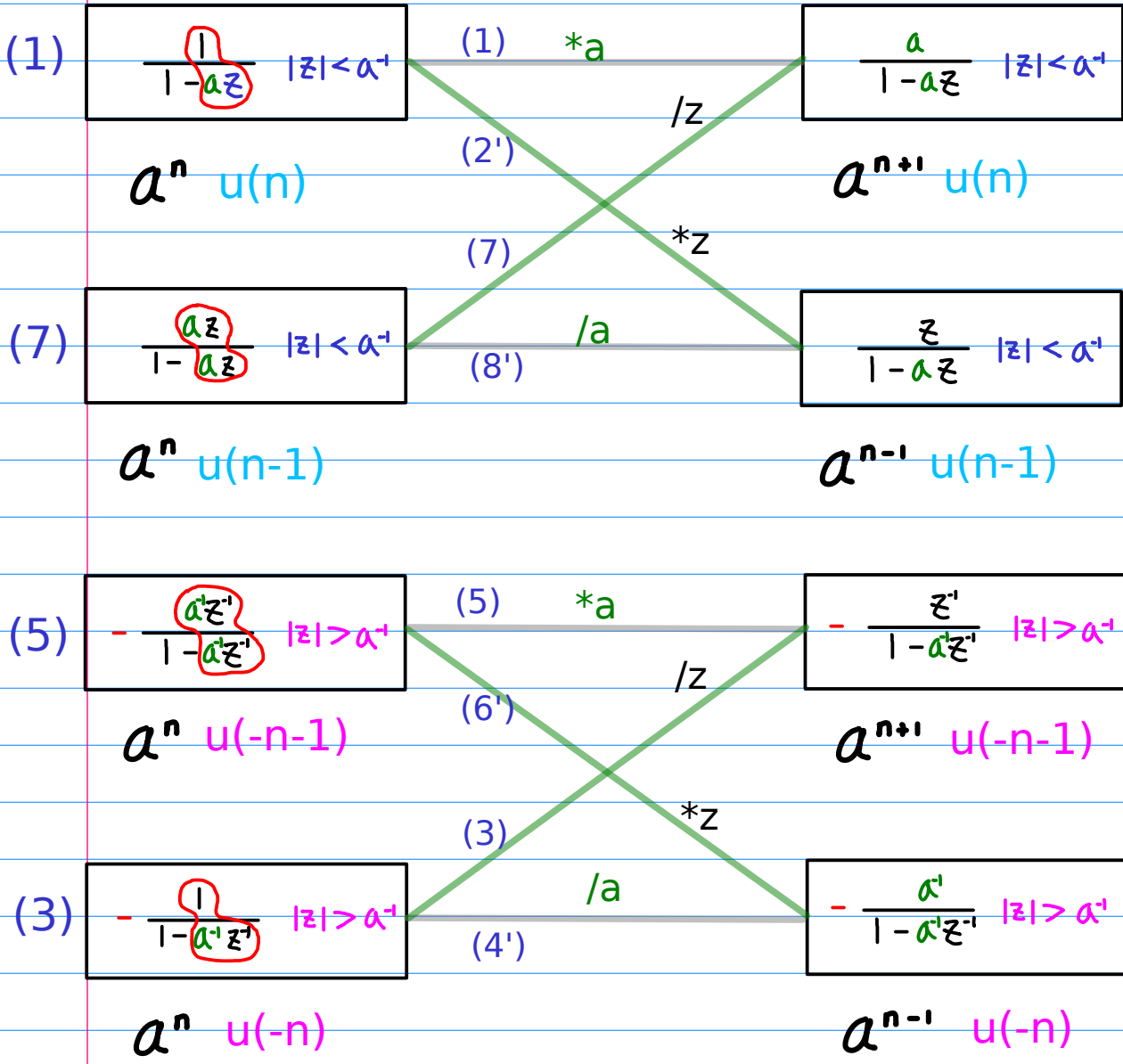

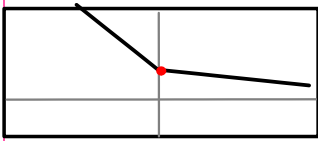
a^{-n} 

/a

*a

Shifting a sequence

(2) $\frac{1}{1-a^2z} \quad |z| < a$ $\xrightarrow{(1') \ /a}$ $\frac{a^{-1}}{1-a^2z} \quad |z| < a$

$a^{-n} u(n)$ $\xrightarrow{(2) \ /z}$ $a^{-n-1} u(n)$

(8) $\frac{a^2z}{1-a^2z} \quad |z| < a$ $\xrightarrow{(7') \ /z}$ $\frac{z}{1-a^2z} \quad |z| < a$

$a^{-n} u(n-1)$ $\xrightarrow{(8) \ *a}$ $a^{-n+1} u(n-1)$

(6) $-\frac{a^2z^{-1}}{1-a^2z^{-1}} \quad |z| > a$ $\xrightarrow{(5') \ /a}$ $-\frac{z^{-1}}{1-a^2z^{-1}} \quad |z| > a$

$a^{-n} u(-n-1)$ $\xrightarrow{(6) \ /z}$ $a^{-n-1} u(-n-1)$

(4) $-\frac{1}{1-a^2z^{-1}} \quad |z| > a$ $\xrightarrow{(3') \ /z}$ $-\frac{a}{1-a^2z^{-1}} \quad |z| > a$

$a^{-n} u(-n)$ $\xrightarrow{(4) \ *a}$ $a^{-n+1} u(-n)$

a^n

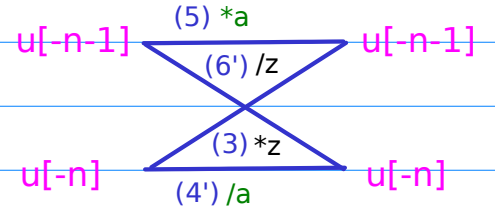
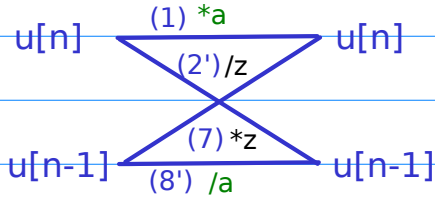
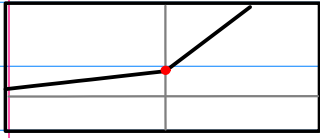

a^{-n}

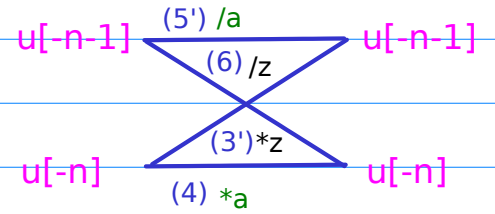
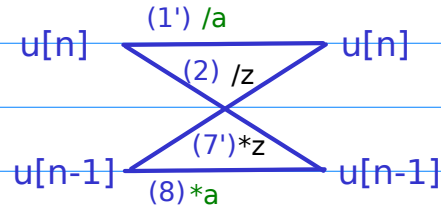
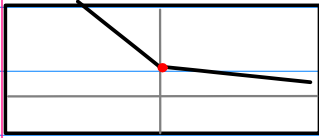

Complement ROC Pairs - Reduced Shifted Geometric Series Form Combinations

$\frac{a}{1-az}$ $ z < a^{-1}$	$a^{n+1} u(n)$	$-\frac{a}{1-az^{-1}}$ $ z > a$	$-(\frac{1}{a})^{n-1} u(-n)$
$-\frac{z^{-1}}{1-a^{-1}z^{-1}}$ $ z > a^{-1}$	$-a^{n+1} u(-n-1)$	$\frac{z}{1-a^{-1}z}$ $ z < a$	$(\frac{1}{a})^{n-1} u(n-1)$

$\frac{a^{-1}}{1-a^{-1}z}$ $ z < a$	$(\frac{1}{a})^{n+1} u(n)$	$-\frac{a^{-1}}{1-a^{-1}z^{-1}}$ $ z > a^{-1}$	$-a^{n-1} u(-n)$
$-\frac{z^{-1}}{1-az^{-1}}$ $ z > a$	$-(\frac{1}{a})^{n+1} u(-n-1)$	$\frac{z}{1-az}$ $ z < a^{-1}$	$a^{n-1} u(n-1)$

$$2z$$

$$2z^{-1}$$

$$2^{-1}z^{-1}$$

$$2^{-1}z$$

$$|z| < 0.5$$

$$|z| > 2$$

$$|z| > 0.5$$

$$|z| < 2$$

$$- \frac{2}{1-2z} \xleftrightarrow{z^{-1}} - \frac{2}{1-2z^{-1}}$$

$$\cdot \frac{(2z)^{-1}}{(2z)^{-1}} \cdot \frac{(2z)}{(2z)}$$

$$\cdot \frac{(2z^{-1})^{-1}}{(2z^{-1})^{-1}} \cdot \frac{(2z^{-1})}{(2z^{-1})}$$

$$+ \frac{z^{-1}}{1-0.5z^{-1}} \xleftrightarrow{z^{-1}} + \frac{z}{1-0.5z}$$

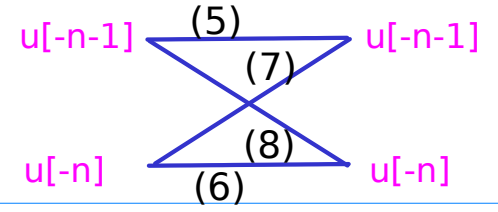
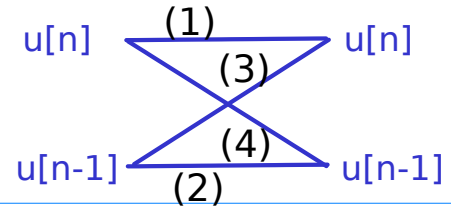

(1) (1)	$\frac{1}{1-az} \quad z < a^{-1}$	$\frac{a}{1-az} \quad z < a^{-1}$	$a^n u(n)$ (a^0, a^1, a^2, \dots)	$a^{n+1} u(n)$ (a^1, a^2, a^3, \dots)
---------	-------------------------------------	-------------------------------------	--	--

(7) (2)	$\frac{az}{1-az} \quad z < a^{-1}$	$\frac{z}{1-az} \quad z < a^{-1}$	$a^n u(n-1)$ (a^1, a^2, a^3, \dots)	$a^{n-1} u(n-1)$ (a^0, a^1, a^2, \dots)
---------	--------------------------------------	-------------------------------------	--	--

(7) (3)	$\frac{az}{1-az} \quad z < a^{-1}$	$\frac{a}{1-az} \quad z < a^{-1}$	$a^n u(n-1)$ (a^1, a^2, a^3, \dots)	$a^{n+1} u(n)$ (a^1, a^2, a^3, \dots)
---------	--------------------------------------	-------------------------------------	--	--

(1) (4)	$\frac{1}{1-az} \quad z < a^{-1}$	$\frac{z}{1-az} \quad z < a^{-1}$	$a^n u(n)$ (a^0, a^1, a^2, \dots)	$a^{n-1} u(n-1)$ (a^0, a^1, a^2, \dots)
---------	-------------------------------------	-------------------------------------	--	--

(5) (5)	$-\frac{a^1 z^{-1}}{1-a^1 z^{-1}} \quad z > a^{-1}$	$-\frac{z^{-1}}{1-a^1 z^{-1}} \quad z > a^{-1}$	$-a^n u(-n-1)$ $-(\dots, \frac{1}{a^2}, \frac{1}{a^3}, \frac{1}{a^4})$	$-a^{n+1} u(-n-1)$ $-(\dots, \frac{1}{a^3}, \frac{1}{a^4}, \frac{1}{a^5})$
---------	---	---	---	---

(3) (6)	$-\frac{1}{1-a^1 z^{-1}} \quad z > a^{-1}$	$-\frac{a^1}{1-a^1 z^{-1}} \quad z > a^{-1}$	$-a^n u(-n)$ $-(\dots, \frac{1}{a^2}, \frac{1}{a^3}, \frac{1}{a^4})$	$-a^{n-1} u(-n)$ $-(\dots, \frac{1}{a^3}, \frac{1}{a^4}, \frac{1}{a^5})$
---------	--	--	---	---

(3) (7)	$-\frac{1}{1-a^1 z^{-1}} \quad z > a^{-1}$	$-\frac{z^{-1}}{1-a^1 z^{-1}} \quad z > a^{-1}$	$-a^n u(-n)$ $-(\dots, \frac{1}{a^2}, \frac{1}{a^3}, \frac{1}{a^4})$	$-a^{n+1} u(-n-1)$ $-(\dots, \frac{1}{a^3}, \frac{1}{a^4}, \frac{1}{a^5})$
---------	--	---	---	---

(5) (8)	$-\frac{a^1 z^{-1}}{1-a^1 z^{-1}} \quad z > a^{-1}$	$-\frac{a^1}{1-a^1 z^{-1}} \quad z > a^{-1}$	$-a^n u(-n-1)$ $-(\dots, \frac{1}{a^2}, \frac{1}{a^3}, \frac{1}{a^4})$	$-a^{n-1} u(-n)$ $-(\dots, \frac{1}{a^3}, \frac{1}{a^4}, \frac{1}{a^5})$
---------	---	--	---	---

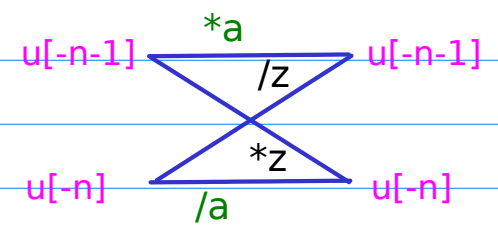
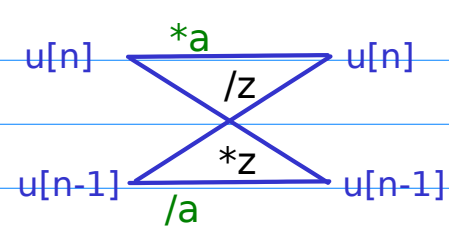

a^{-n}

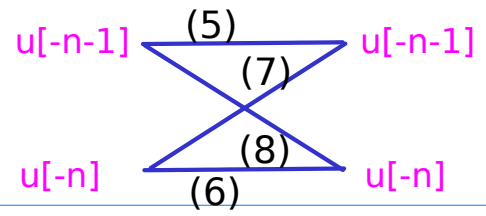
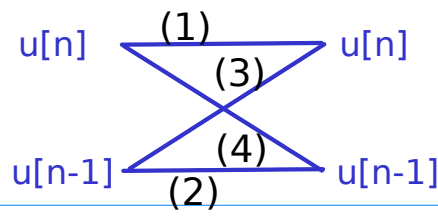
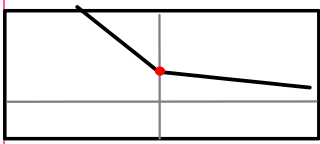

(2) (1)

$$\frac{1}{1-a^1 z} \quad |z| < a$$

$$\frac{a^1}{1-a^1 z} \quad |z| < a$$

$$\left(\frac{1}{a}\right)^n u(n)$$

$$\left(\frac{1}{a^0}, \frac{1}{a^1}, \frac{1}{a^2}, \dots\right)$$

$$\left(\frac{1}{a}\right)^{n+1} u(n)$$

$$\left(\frac{1}{a^1}, \frac{1}{a^2}, \frac{1}{a^3}, \dots\right)$$

(8) (2)

$$\frac{a^1 z}{1-a^1 z} \quad |z| < a$$

$$\frac{z}{1-a^1 z} \quad |z| < a$$

$$\left(\frac{1}{a}\right)^n u(n-1)$$

$$\left(\frac{1}{a^1}, \frac{1}{a^2}, \frac{1}{a^3}, \dots\right)$$

$$\left(\frac{1}{a}\right)^{n-1} u(n-1)$$

$$\left(\frac{1}{a^0}, \frac{1}{a^1}, \frac{1}{a^2}, \dots\right)$$

(8) (3)

$$\frac{a^1 z}{1-a^1 z} \quad |z| < a$$

$$\frac{a^1}{1-a^1 z} \quad |z| < a$$

$$\left(\frac{1}{a}\right)^n u(n-1)$$

$$\left(\frac{1}{a^1}, \frac{1}{a^2}, \frac{1}{a^3}, \dots\right)$$

$$\left(\frac{1}{a}\right)^{n+1} u(n)$$

$$\left(\frac{1}{a^1}, \frac{1}{a^2}, \frac{1}{a^3}, \dots\right)$$

(2) (4)

$$\frac{1}{1-a^1 z} \quad |z| < a$$

$$\frac{z}{1-a^1 z} \quad |z| < a$$

$$\left(\frac{1}{a}\right)^n u(n)$$

$$\left(\frac{1}{a^0}, \frac{1}{a^1}, \frac{1}{a^2}, \dots\right)$$

$$\left(\frac{1}{a}\right)^{n-1} u(n-1)$$

$$\left(\frac{1}{a^0}, \frac{1}{a^1}, \frac{1}{a^2}, \dots\right)$$

(6) (5)

$$-\frac{a z^{-1}}{1-a z^{-1}} \quad |z| > a$$

$$-\frac{z^{-1}}{1-a z^{-1}} \quad |z| > a$$

$$-\left(\frac{1}{a}\right)^n u(-n-1)$$

$$-\left(\dots, a^3, a^2, a^1\right)$$

$$-\left(\frac{1}{a}\right)^{n+1} u(-n-1)$$

$$-\left(\dots, a^2, a^1, a^0\right)$$

(4) (6)

$$-\frac{1}{1-a z^{-1}} \quad |z| > a$$

$$-\frac{a}{1-a z^{-1}} \quad |z| > a$$

$$-\left(\frac{1}{a}\right)^n u(-n)$$

$$-\left(\dots, a^2, a^1, a^0\right)$$

$$-\left(\frac{1}{a}\right)^{n-1} u(-n)$$

$$-\left(\dots, a^1, a^0, a^{-1}\right)$$

(4) (7)

$$-\frac{1}{1-a z^{-1}} \quad |z| > a$$

$$-\frac{z^{-1}}{1-a z^{-1}} \quad |z| > a$$

$$-\left(\frac{1}{a}\right)^n u(-n)$$

$$-\left(\dots, a^2, a^1, a^0\right)$$

$$-\left(\frac{1}{a}\right)^{n+1} u(-n-1)$$

$$-\left(\dots, a^2, a^1, a^0\right)$$

(6) (8)

$$-\frac{a z^{-1}}{1-a z^{-1}} \quad |z| > a$$

$$-\frac{a}{1-a z^{-1}} \quad |z| > a$$

$$-\left(\frac{1}{a}\right)^n u(-n-1)$$

$$-\left(\dots, a^3, a^2, a^1\right)$$

$$-\left(\frac{1}{a}\right)^{n-1} u(-n)$$

$$-\left(\dots, a^3, a^2, a^1\right)$$

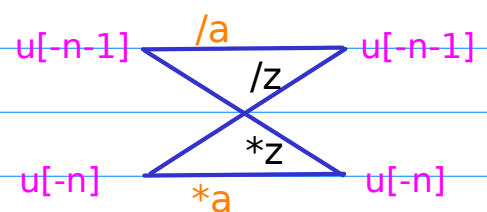
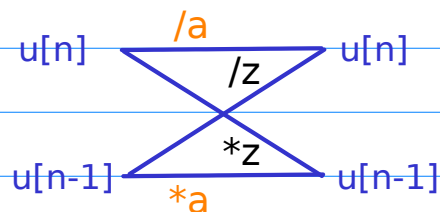

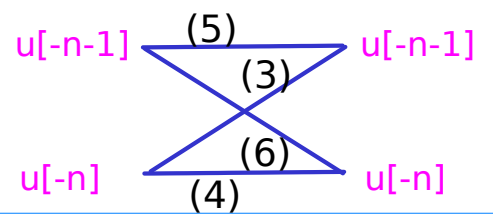
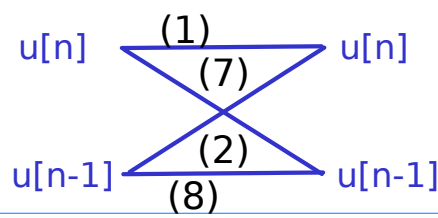

(1) / (5)

scale(a)

(2) / (6)

scale(z)

	$\frac{1}{1-az} \quad z < a^{-1}$	$\frac{a}{1-az} \quad z < a^{-1}$	$\frac{1}{1-a^{-1}z} \quad z < a$	$\frac{z}{1-a^{-1}z} \quad z < a$
Comp.ROC	$-\frac{a^{-1}z^{-1}}{1-a^{-1}z^{-1}} \quad z > a^{-1}$	$-\frac{z^{-1}}{1-a^{-1}z^{-1}} \quad z > a^{-1}$	$-\frac{a^{-1}z^{-1}}{1-a^{-1}z^{-1}} \quad z > a$	$-\frac{a}{1-a^{-1}z^{-1}} \quad z > a$

(3) / (7)

scale(1/z)

(4) / (8)

scale(a)

	$-\frac{1}{1-a^{-1}z^{-1}} \quad z > a^{-1}$	$-\frac{z^{-1}}{1-a^{-1}z^{-1}} \quad z > a^{-1}$	$-\frac{1}{1-a^{-1}z^{-1}} \quad z > a$	$-\frac{a}{1-a^{-1}z^{-1}} \quad z > a$
Comp.ROC	$\frac{az}{1-az} \quad z < a^{-1}$	$\frac{a}{1-az} \quad z < a^{-1}$	$\frac{a^{-1}z}{1-a^{-1}z} \quad z < a$	$\frac{z}{1-a^{-1}z} \quad z < a$

(1') / (5')

scale(1/a)

(2') / (6')

scale(z)

	$\frac{1}{1-a^{-1}z} \quad z < a$	$\frac{a^{-1}}{1-a^{-1}z} \quad z < a$	$\frac{1}{1-az} \quad z < a^{-1}$	$\frac{z}{1-az} \quad z < a^{-1}$
Comp.ROC	$-\frac{a^{-1}z^{-1}}{1-a^{-1}z^{-1}} \quad z > a$	$-\frac{z^{-1}}{1-a^{-1}z^{-1}} \quad z > a$	$-\frac{a^{-1}z^{-1}}{1-a^{-1}z^{-1}} \quad z > a^{-1}$	$-\frac{a^{-1}}{1-a^{-1}z^{-1}} \quad z > a^{-1}$

(3') / (7')

scale(1/z)

(4') / (8')

scale(1/a)

	$-\frac{1}{1-az^{-1}} \quad z > a$	$-\frac{z^{-1}}{1-az^{-1}} \quad z > a$	$-\frac{1}{1-a^{-1}z^{-1}} \quad z > a^{-1}$	$-\frac{a^{-1}}{1-a^{-1}z^{-1}} \quad z > a^{-1}$
Comp.ROC	$\frac{a^{-1}z}{1-a^{-1}z} \quad z < a$	$\frac{a^{-1}}{1-a^{-1}z} \quad z < a$	$\frac{az}{1-az} \quad z < a^{-1}$	$\frac{z}{1-az} \quad z < a^{-1}$

(1) / (5)

scale(a)

(2) / (6)

scale(z)

Comp.ROC

$\frac{1}{1-az} \quad z < a^{-1}$	$\frac{a}{1-az} \quad z < a^{-1}$	$\frac{1}{1-a^{-1}z} \quad z < a$	$\frac{z}{1-a^{-1}z} \quad z < a$
$-\frac{a^{-1}z^{-1}}{1-a^{-1}z^{-1}} \quad z > a^{-1}$	$-\frac{z^{-1}}{1-a^{-1}z^{-1}} \quad z > a^{-1}$	$-\frac{az^{-1}}{1-a^{-1}z^{-1}} \quad z > a$	$-\frac{a}{1-a^{-1}z^{-1}} \quad z > a$

(3) / (7)

scale(1/z)

(4) / (8)

scale(a)

Comp.ROC

$-\frac{1}{1-a^{-1}z^{-1}} \quad z > a^{-1}$	$-\frac{z^{-1}}{1-a^{-1}z^{-1}} \quad z > a^{-1}$	$-\frac{1}{1-az^{-1}} \quad z > a$	$-\frac{a}{1-az^{-1}} \quad z > a$
$\frac{az}{1-az} \quad z < a^{-1}$	$\frac{a}{1-az} \quad z < a^{-1}$	$\frac{a^{-1}z}{1-a^{-1}z} \quad z < a$	$\frac{z}{1-a^{-1}z} \quad z < a$

(1') / (5')

scale(1/a)

(2') / (6')

scale(z)

Comp.ROC

$\frac{1}{1-a^{-1}z} \quad z < a$	$\frac{a^{-1}}{1-a^{-1}z} \quad z < a$	$\frac{1}{1-az} \quad z < a^{-1}$	$\frac{z}{1-az} \quad z < a^{-1}$
$-\frac{az^{-1}}{1-az^{-1}} \quad z > a$	$-\frac{z^{-1}}{1-az^{-1}} \quad z > a$	$-\frac{a^{-1}z^{-1}}{1-a^{-1}z^{-1}} \quad z > a^{-1}$	$-\frac{a^{-1}}{1-a^{-1}z^{-1}} \quad z > a^{-1}$

(3') / (7')

scale(1/z)

(4') / (8')

scale(1/a)

Comp.ROC

$-\frac{1}{1-az^{-1}} \quad z > a$	$-\frac{z^{-1}}{1-az^{-1}} \quad z > a$	$-\frac{1}{1-a^{-1}z^{-1}} \quad z > a^{-1}$	$-\frac{a^{-1}}{1-a^{-1}z^{-1}} \quad z > a^{-1}$
$\frac{a^{-1}z}{1-a^{-1}z} \quad z < a$	$\frac{a^{-1}}{1-a^{-1}z} \quad z < a$	$\frac{az}{1-az} \quad z < a^{-1}$	$\frac{z}{1-az} \quad z < a^{-1}$

(1) / (5)

SHL.Seq

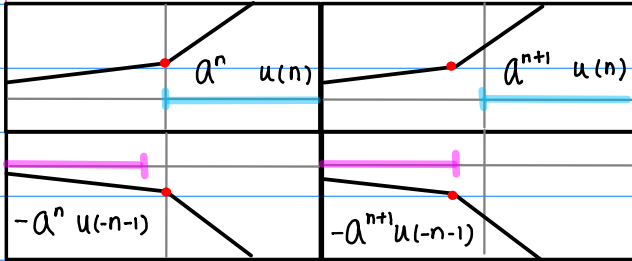

(2) / (6)

SHR.Seq, SHR.Rng

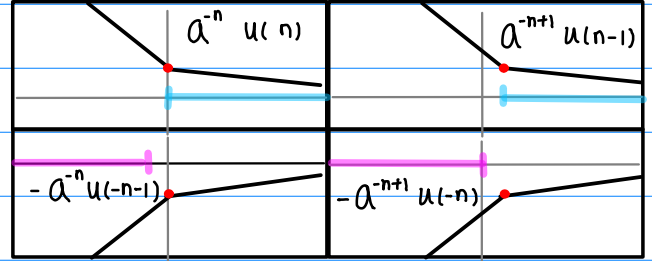

(3) / (7)

SHL.Seq, SHL.Rng

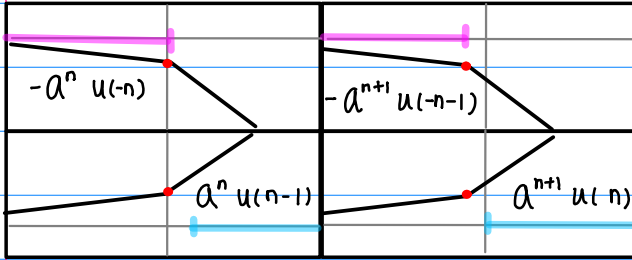

(4) / (8)

SHR.Seq

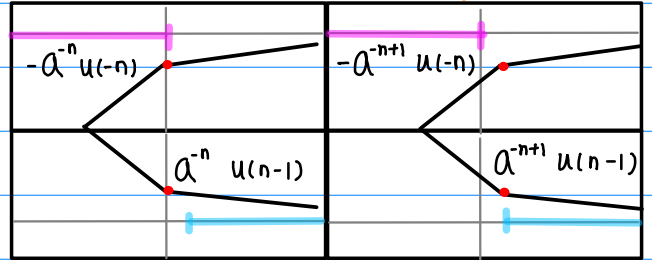

(1') / (5')

SHL.Seq

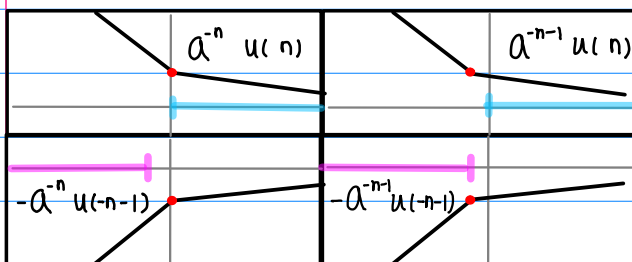

(2') / (6')

SHR.Seq, SHR.Rng

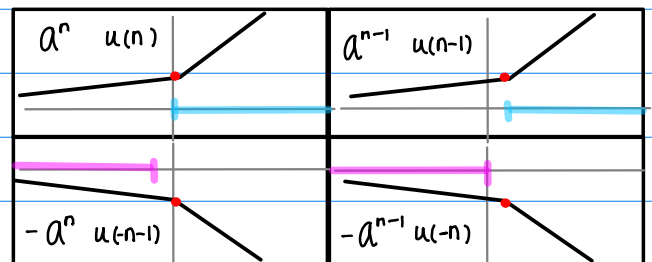

(3') / (7')

SHL.Seq, SHL.Rng

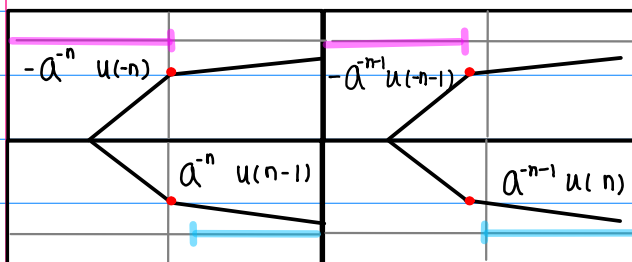

(4') / (8')

SHR.Seq

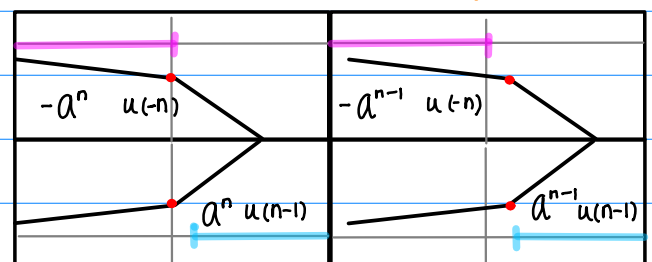

Left Shifted Sequence

Right Shifted Sequence

(1) / (5)

scale(a)

(2) / (6)

scale(z)

Comp.ROC

$\frac{1}{1-az}$ $ z < a^{-1}$	$\frac{a}{1-az}$ $ z < a^{-1}$	$\frac{1}{1-a^{-1}z}$ $ z < a$	$\frac{z}{1-a^{-1}z}$ $ z < a$
$-\frac{a^{-1}z^{-1}}{1-a^{-1}z^{-1}}$ $ z > a^{-1}$	$-\frac{z^{-1}}{1-a^{-1}z^{-1}}$ $ z > a^{-1}$	$-\frac{az^{-1}}{1-a^{-1}z^{-1}}$ $ z > a$	$-\frac{a}{1-a^{-1}z^{-1}}$ $ z > a$

(3) / (7)

scale(1/z)

(4) / (8)

scale(a)

Comp.ROC

$-\frac{1}{1-a^{-1}z^{-1}}$ $ z > a^{-1}$	$-\frac{z^{-1}}{1-a^{-1}z^{-1}}$ $ z > a^{-1}$	$-\frac{1}{1-az^{-1}}$ $ z > a$	$-\frac{a}{1-az^{-1}}$ $ z > a$
$\frac{az}{1-az}$ $ z < a^{-1}$	$\frac{a}{1-az}$ $ z < a^{-1}$	$\frac{a^{-1}z}{1-a^{-1}z}$ $ z < a$	$\frac{z}{1-a^{-1}z}$ $ z < a$

(1') / (5')

scale(1/a)

(2') / (6')

scale(z)

Comp.ROC

$\frac{1}{1-a^{-1}z}$ $ z < a$	$\frac{a^{-1}}{1-a^{-1}z}$ $ z < a$	$\frac{1}{1-az}$ $ z < a^{-1}$	$\frac{z}{1-az}$ $ z < a^{-1}$
$-\frac{az^{-1}}{1-az^{-1}}$ $ z > a$	$-\frac{z^{-1}}{1-az^{-1}}$ $ z > a$	$-\frac{a^{-1}z^{-1}}{1-a^{-1}z^{-1}}$ $ z > a^{-1}$	$-\frac{a^{-1}}{1-a^{-1}z^{-1}}$ $ z > a^{-1}$

(3') / (7')

scale(1/z)

(4') / (8')

scale(1/a)

Comp.ROC

$-\frac{1}{1-az^{-1}}$ $ z > a$	$-\frac{z^{-1}}{1-az^{-1}}$ $ z > a$	$-\frac{1}{1-a^{-1}z^{-1}}$ $ z > a^{-1}$	$-\frac{a^{-1}}{1-a^{-1}z^{-1}}$ $ z > a^{-1}$
$\frac{a^{-1}z}{1-a^{-1}z}$ $ z < a$	$\frac{a^{-1}}{1-a^{-1}z}$ $ z < a$	$\frac{az}{1-az}$ $ z < a^{-1}$	$\frac{z}{1-az}$ $ z < a^{-1}$

(1) / (5)

SHL.Seq

$a^n u(n)$ (a^0, a^1, a^2, \dots)	$a^{n+1} u(n)$ (a^1, a^2, a^3, \dots)
$-a^n u(-n-1)$ $-(\dots, \frac{1}{a^2}, \frac{1}{a^3}, \frac{1}{a^4})$	$-a^{n+1} u(-n-1)$ $-(\dots, \frac{1}{a^2}, \frac{1}{a^3}, \frac{1}{a^4})$

(2) / (6)

SHR.Seq, SHR.Rng

$(\frac{1}{a})^n u(n)$ ($\frac{1}{a^0}, \frac{1}{a^1}, \frac{1}{a^2}, \dots$)	$(\frac{1}{a})^{n-1} u(n-1)$ ($\frac{1}{a^0}, \frac{1}{a^1}, \frac{1}{a^2}, \dots$)
$-(\frac{1}{a})^n u(-n-1)$ $-(\dots, a^3, a^2, a^1)$	$-(\frac{1}{a})^{n-1} u(-n)$ $-(\dots, a^3, a^2, a^1)$

(3) / (7)

SHL.Seq, SHL.Rng

$-a^n u(-n)$ $-(\dots, \frac{1}{a^2}, \frac{1}{a^3}, \frac{1}{a^4})$	$-a^{n+1} u(-n-1)$ $-(\dots, \frac{1}{a^2}, \frac{1}{a^3}, \frac{1}{a^4})$
$a^n u(n-1)$ (a^1, a^2, a^3, \dots)	$a^{n+1} u(n)$ (a^1, a^2, a^3, \dots)

(4) / (8)

SHR.Seq

$-(\frac{1}{a})^n u(-n)$ $-(\dots, a^2, a^1, a^0)$	$-(\frac{1}{a})^{n-1} u(-n)$ $-(\dots, a^3, a^2, a^1)$
$(\frac{1}{a})^n u(n-1)$ ($\frac{1}{a^1}, \frac{1}{a^2}, \frac{1}{a^3}, \dots$)	$(\frac{1}{a})^{n-1} u(n-1)$ ($\frac{1}{a^0}, \frac{1}{a^1}, \frac{1}{a^2}, \dots$)

(1') / (5')

SHL.Seq

$(\frac{1}{a})^n u(n)$ ($\frac{1}{a^0}, \frac{1}{a^1}, \frac{1}{a^2}, \dots$)	$(\frac{1}{a})^{n+1} u(n)$ ($\frac{1}{a^1}, \frac{1}{a^2}, \frac{1}{a^3}, \dots$)
$-(\frac{1}{a})^n u(-n-1)$ $-(\dots, a^3, a^2, a^1)$	$-(\frac{1}{a})^{n+1} u(-n-1)$ $-(\dots, a^2, a^1, a^0)$

(2') / (6')

SHR.Seq, SHR.Rng

$a^n u(n)$ (a^0, a^1, a^2, \dots)	$a^{n-1} u(n-1)$ (a^0, a^1, a^2, \dots)
$-a^n u(-n-1)$ $-(\dots, \frac{1}{a^2}, \frac{1}{a^3}, \frac{1}{a^4})$	$-a^{n-1} u(-n)$ $-(\dots, \frac{1}{a^2}, \frac{1}{a^3}, \frac{1}{a^4})$

(3') / (7')

SHL.Seq, SHL.Rng

$-(\frac{1}{a})^n u(-n)$ $-(\dots, a^2, a^1, a^0)$	$-(\frac{1}{a})^{n+1} u(-n-1)$ $-(\dots, a^2, a^1, a^0)$
$(\frac{1}{a})^n u(n-1)$ ($\frac{1}{a^1}, \frac{1}{a^2}, \frac{1}{a^3}, \dots$)	$(\frac{1}{a})^{n+1} u(n)$ ($\frac{1}{a^1}, \frac{1}{a^2}, \frac{1}{a^3}, \dots$)

(4') / (8')

SHR.Seq

$-a^n u(-n)$ $-(\dots, \frac{1}{a^2}, \frac{1}{a^3}, \frac{1}{a^4})$	$-a^{n-1} u(-n)$ $-(\dots, \frac{1}{a^2}, \frac{1}{a^3}, \frac{1}{a^4})$
$a^n u(n-1)$ (a^1, a^2, a^3, \dots)	$a^{n-1} u(n-1)$ (a^0, a^1, a^2, \dots)

Left Shifted Sequence

Right Shifted Sequence

(1) / (5)

SHL.Seq

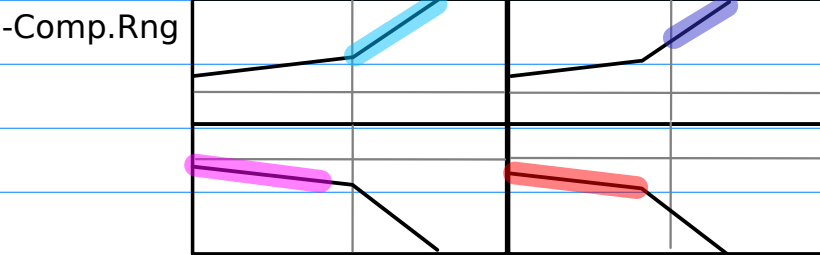

(2) / (6)

SHR.Seq, SHR.Rng

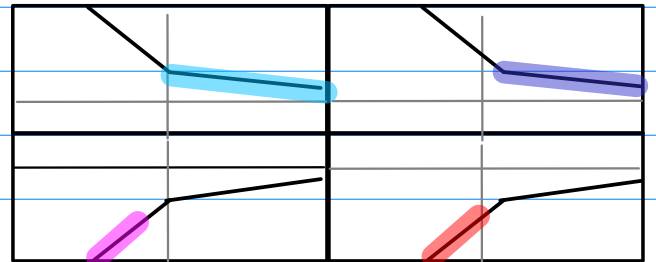

(3) / (7)

SHL.Seq, SHL.Rng

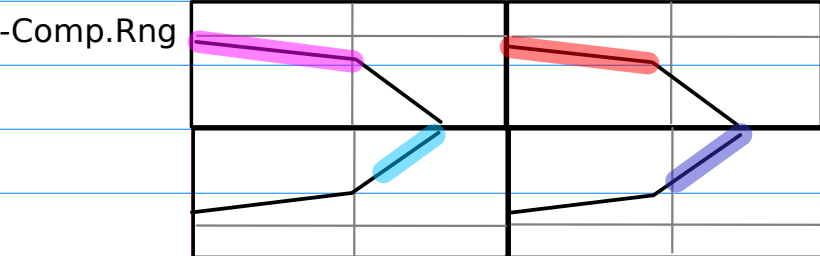

(4) / (8)

SHR.Seq

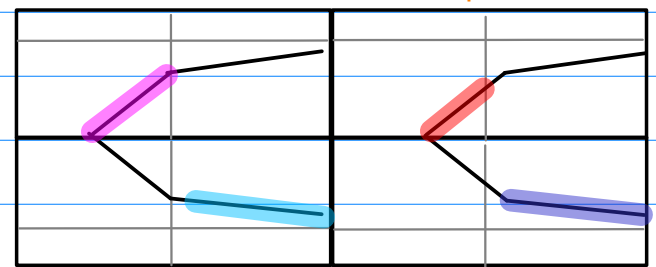

(1') / (5')

SHL.Seq

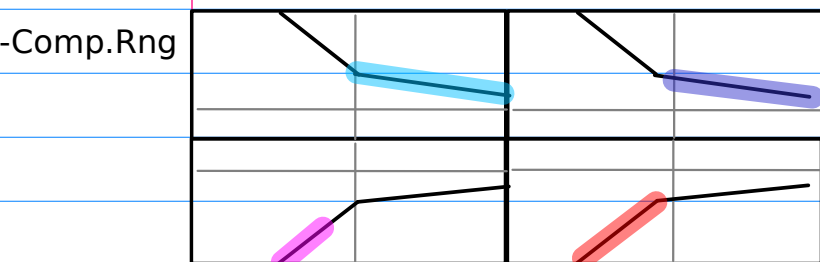

(2') / (6')

SHR.Seq, SHR.Rng

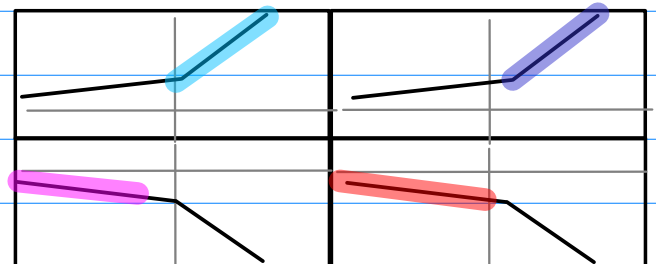

(3') / (7')

SHL.Seq, SHL.Rng

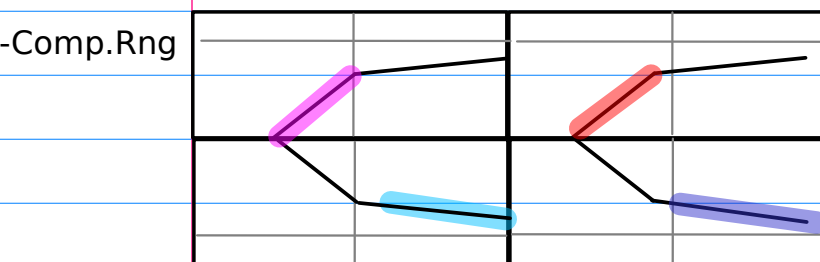

(4') / (8')

SHR.Seq

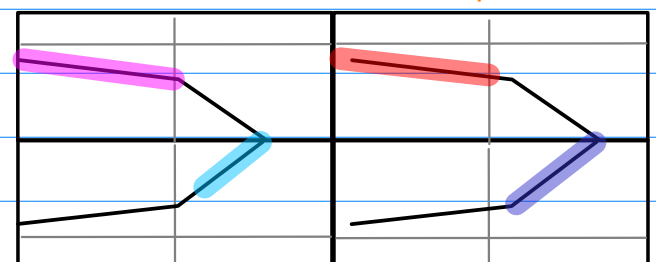

Left Shifted Sequence

Right Shifted Sequence

(1) / (5)

SHL.Seq

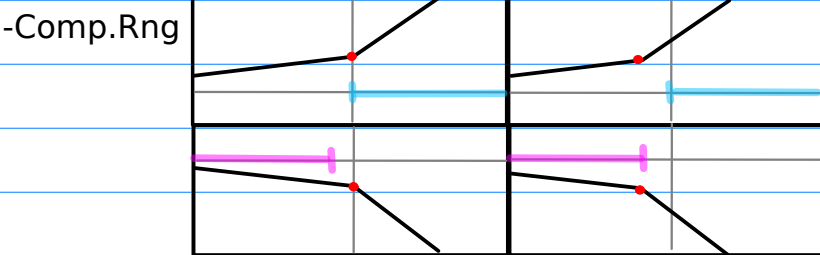

(2) / (6)

SHR.Seq, SHR.Rng

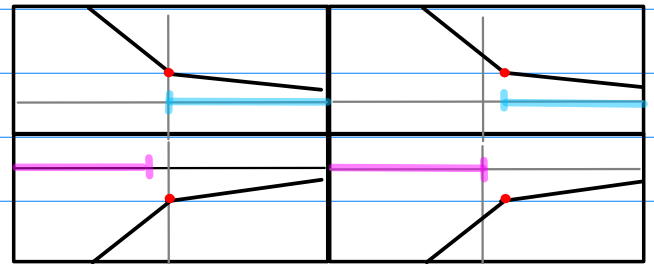

(3) / (7)

SHL.Seq, SHL.Rng

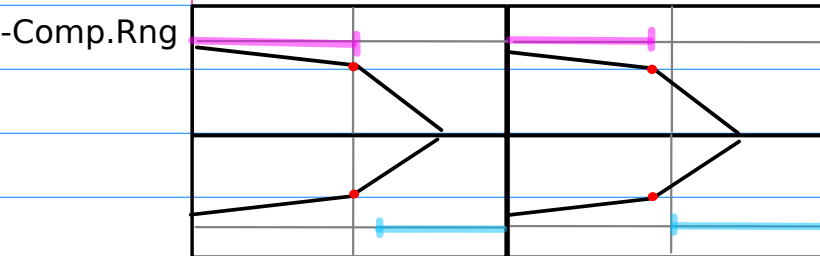

(4) / (8)

SHR.Seq

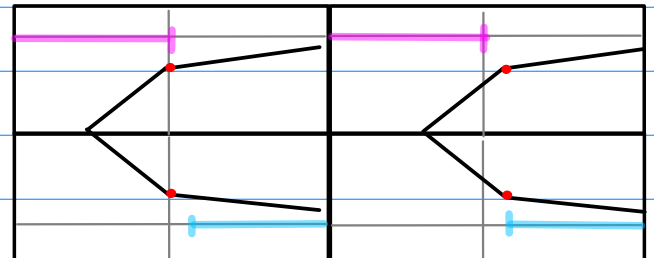

(1') / (5')

SHL.Seq

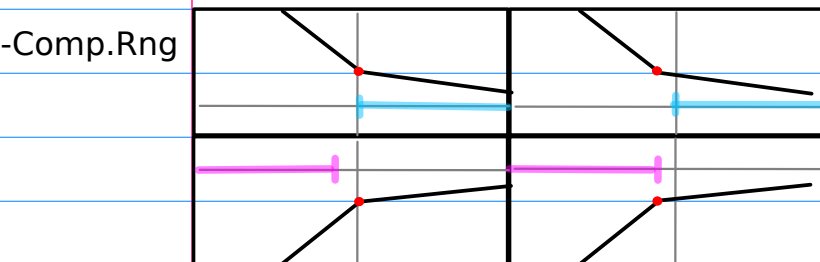

(2') / (6')

SHR.Seq, SHR.Rng

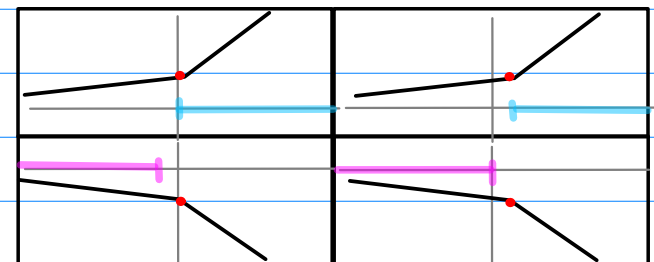

(3') / (7')

SHL.Seq, SHL.Rng

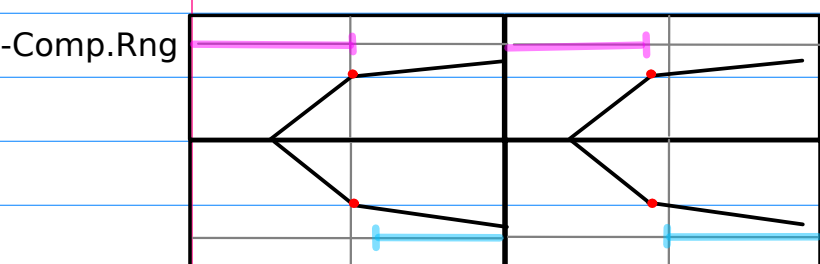

(4') / (8')

SHR.Seq

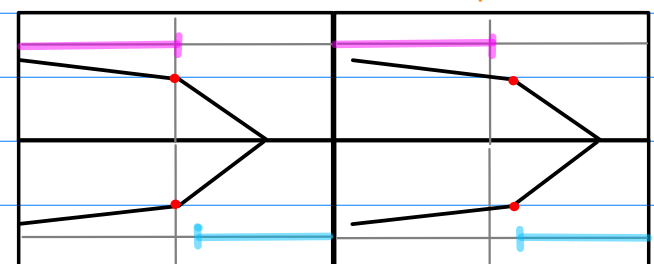

Left Shifted Sequence

Right Shifted Sequence

(1) / (5)

SHL.Seq

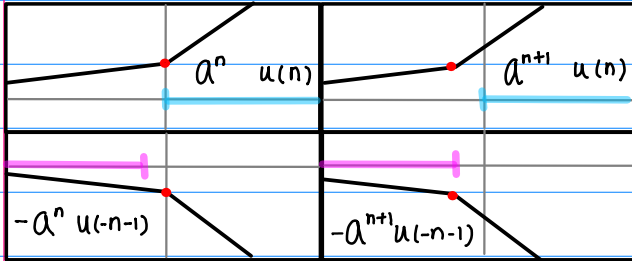

(2) / (6)

SHR.Seq, SHR.Rng

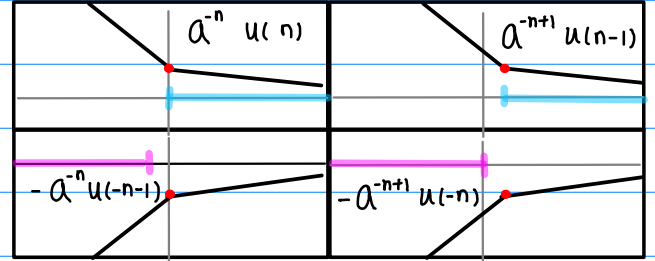

(3) / (7)

SHL.Seq, SHL.Rng

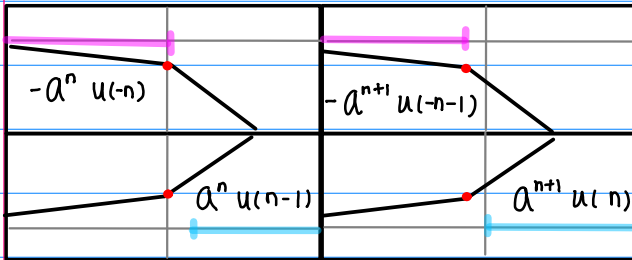

(4) / (8)

SHR.Seq

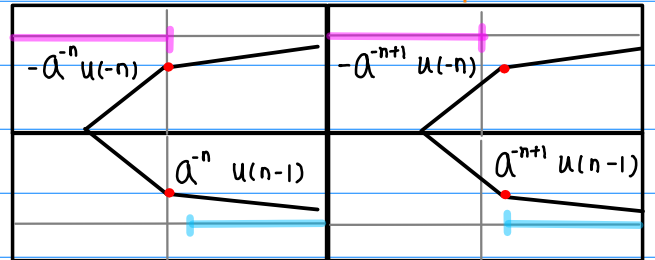

(1') / (5')

SHL.Seq

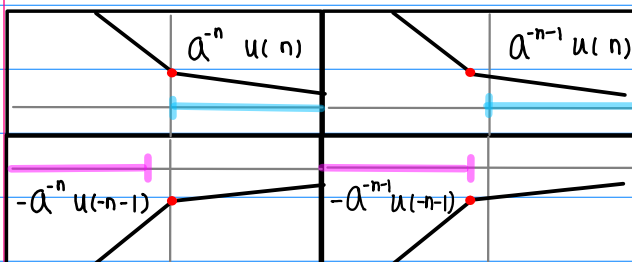

(2') / (6')

SHR.Seq, SHR.Rng

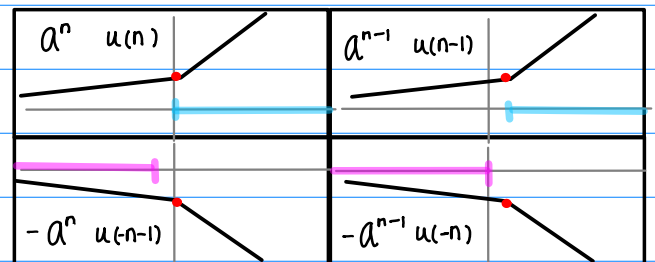

(3') / (7')

SHL.Seq, SHL.Rng

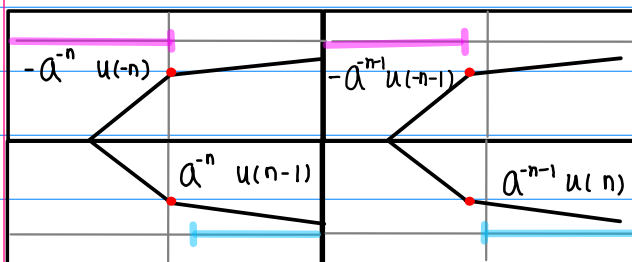

(4') / (8')

SHR.Seq

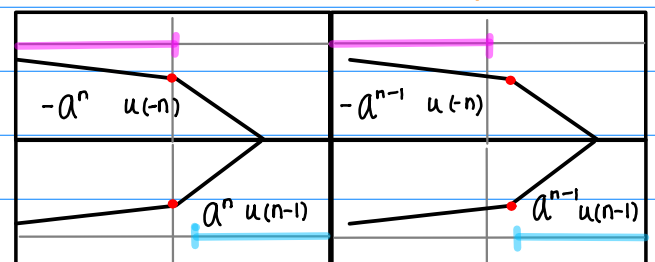

Left Shifted Sequence

Right Shifted Sequence

a Sequence Function

(1) / (5)

SHL.Seq

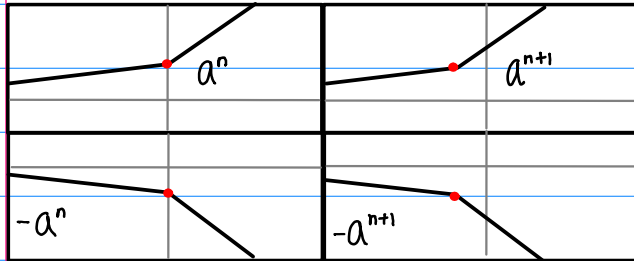

(2) / (6)

SHR.Seq, SHR.Rng

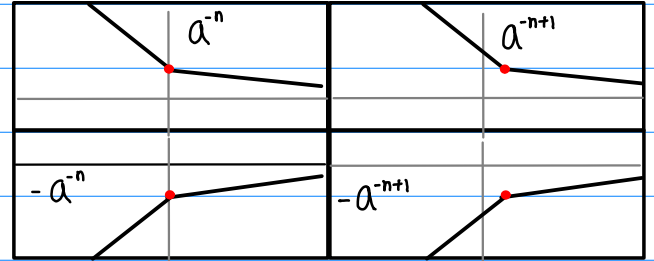

(3) / (7)

SHL.Seq, SHL.Rng

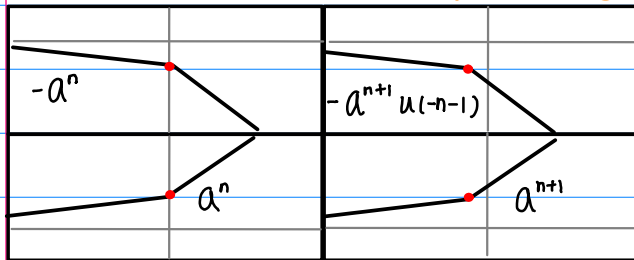

(4) / (8)

SHR.Seq

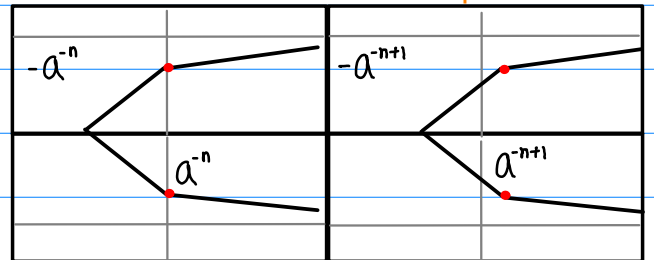

(1') / (5')

SHL.Seq

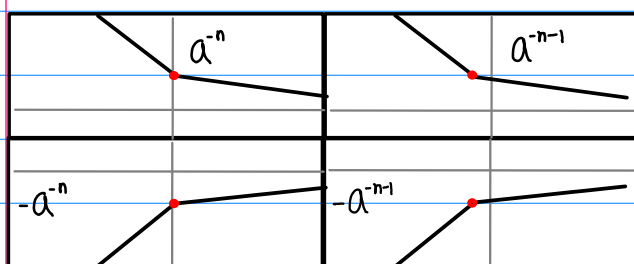

(2') / (6')

SHR.Seq, SHR.Rng

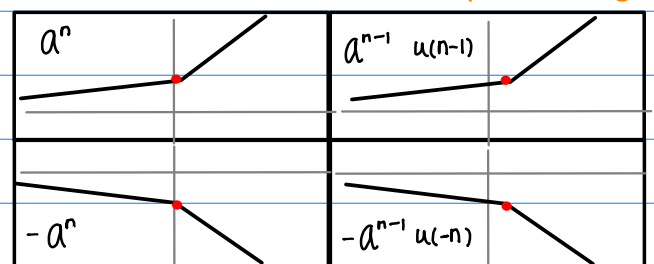

(3') / (7')

SHL.Seq, SHL.Rng

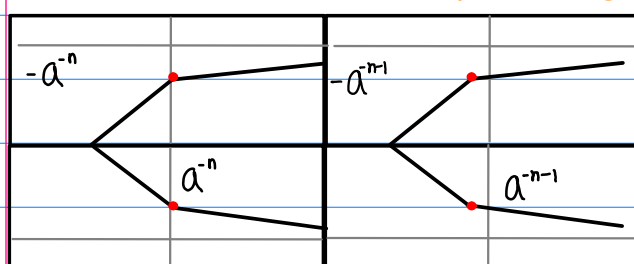

(4') / (8')

SHR.Seq

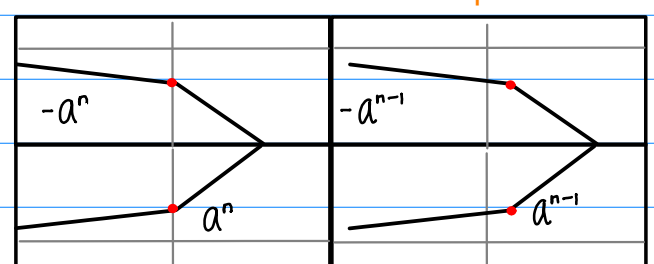

Left Shifted
Sequence

Right Shifted
Sequence

Range of a Sequence

(1) / (5)

SHL.Seq

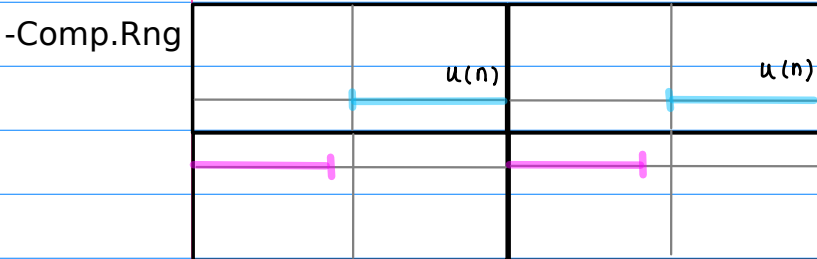

(2) / (6)

SHR.Seq, SHR.Rng

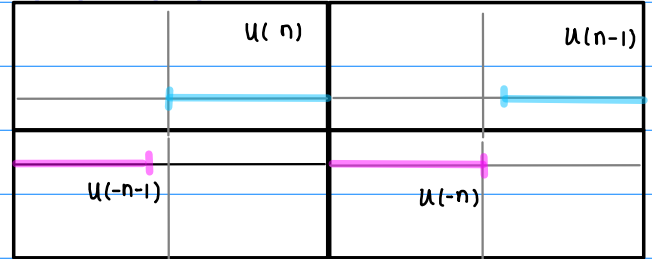

(3) / (7)

SHL.Seq, SHL.Rng

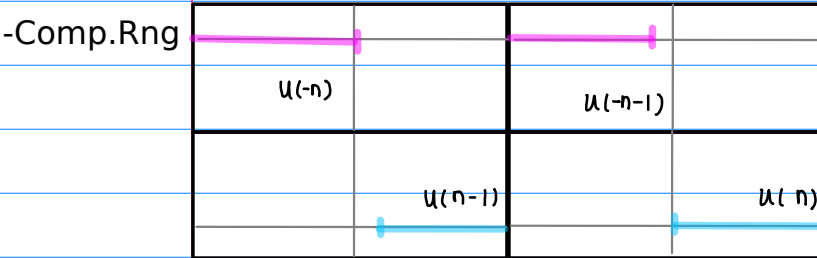

(4) / (8)

SHR.Seq

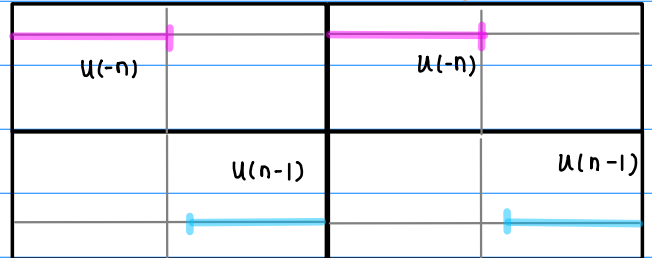

(1') / (5')

SHL.Seq

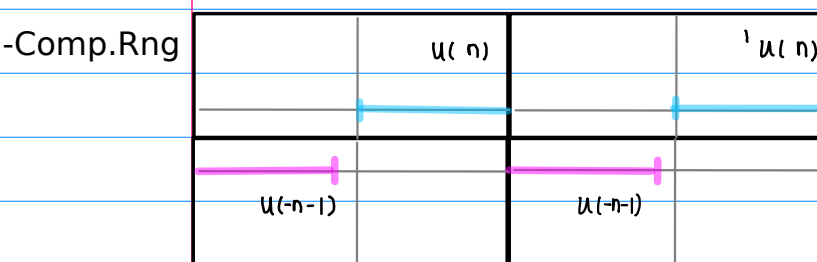

(2') / (6')

SHR.Seq, SHR.Rng

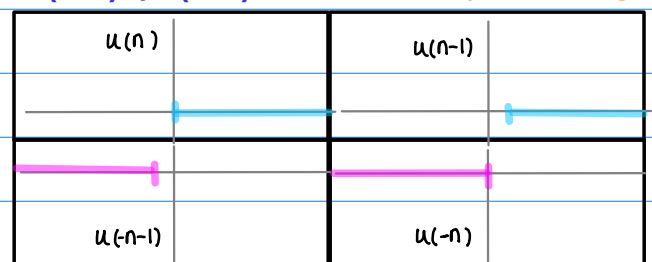

(3') / (7')

SHL.Seq, SHL.Rng

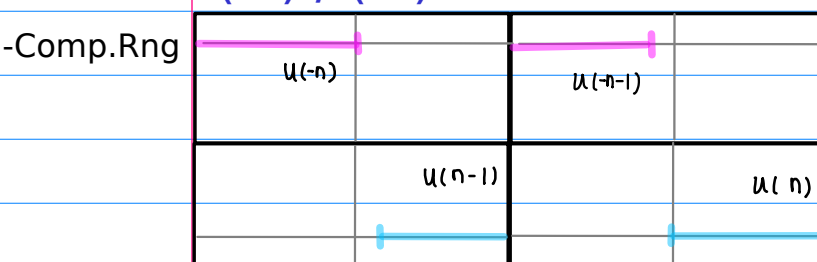

(4') / (8')

SHR.Seq

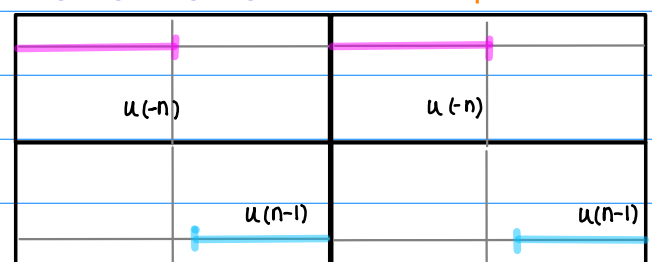

Left Shifted Sequence

Right Shifted Sequence





