

Variable Block Adder (1C)

-
-

Copyright (c) 2024 - 2010 Young W. Lim.

Permission is granted to copy, distribute and/or modify this document under the terms of the GNU Free Documentation License, Version 1.2 or any later version published by the Free Software Foundation; with no Invariant Sections, no Front-Cover Texts, and no Back-Cover Texts. A copy of the license is included in the section entitled "GNU Free Documentation License".

Please send corrections (or suggestions) to youngwlim@hotmail.com.

This document was produced by using OpenOffice and Octave.

Carry Skip Adder

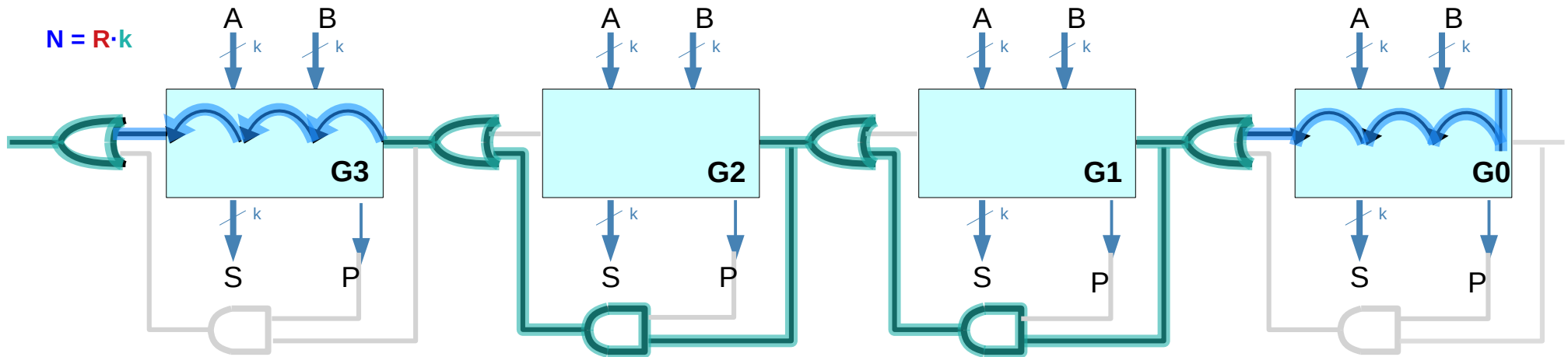

Fixed block size = k bits

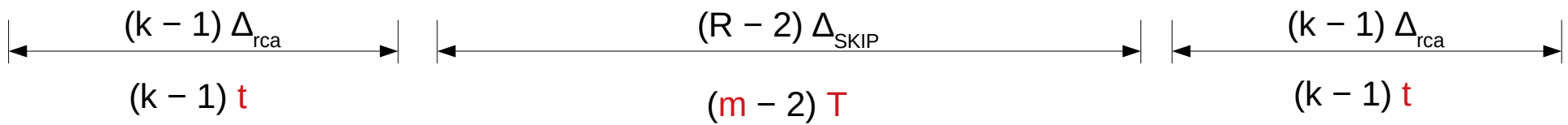

Variable block size = x_i bits for the i -th group

$$(x_i - 1) t \qquad (m - 2) T \qquad (x_j - 1) t$$

t denote the time required for a carry signal to ripple across a bit
 T denote the time required for the signal to skip over a group of bits
 m denotes the optimal number of groups for an n -bit carry chain

Carry Skip Adder – fixed block size

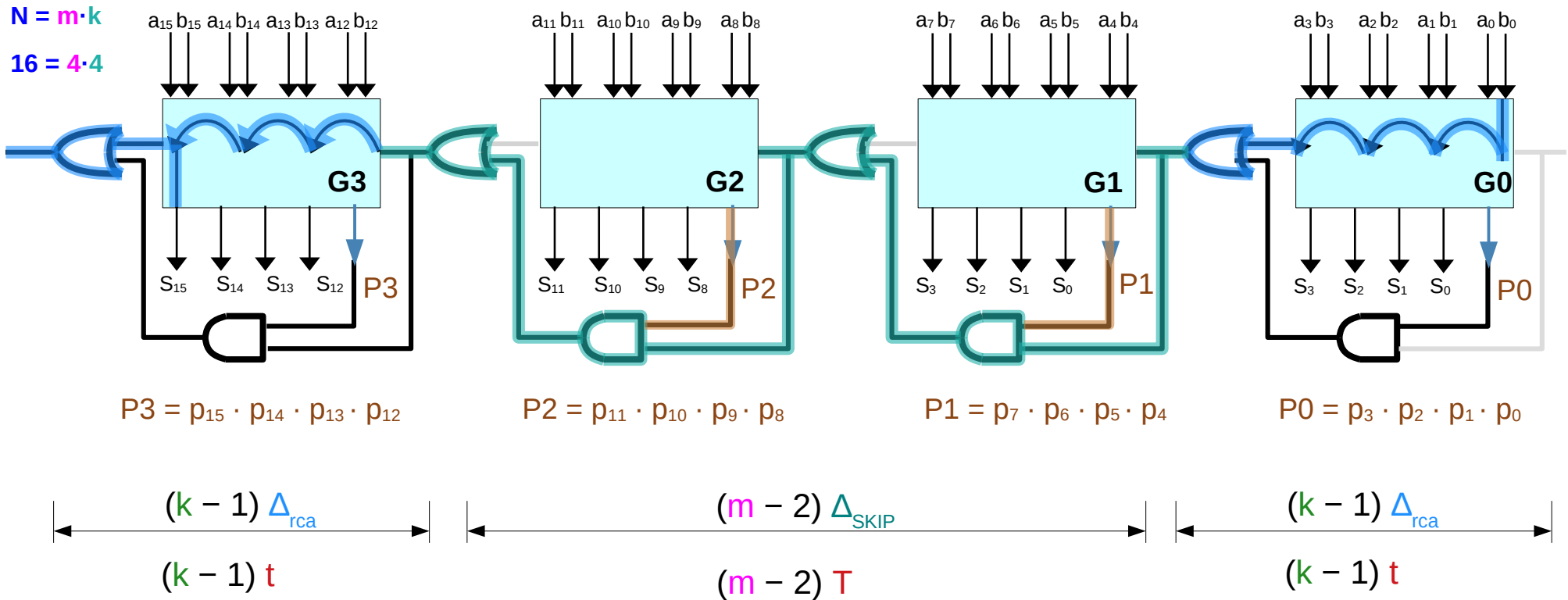

t denote the time required for a carry signal to ripple across a bit
 T denote the time required for the signal to skip over a group of bits
 m denotes the optimal number of groups for an n-bit carry chain

Fixed Block Size \Rightarrow delay(P3) = delay(P2) = delay(P1) = delay(P0) = Fixed Delay

Carry Skip Adder – maximum carry delay (3)

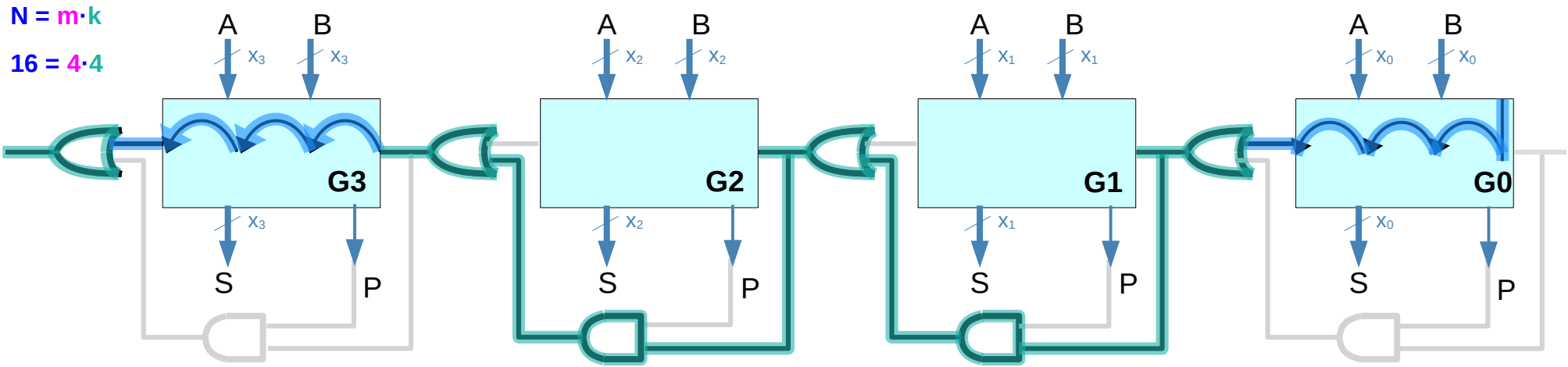

$x_3 = \text{bit size of } G3$

$x_2 = \text{bit size of } G2$

$x_1 = \text{bit size of } G1$

$x_0 = \text{bit size of } G$

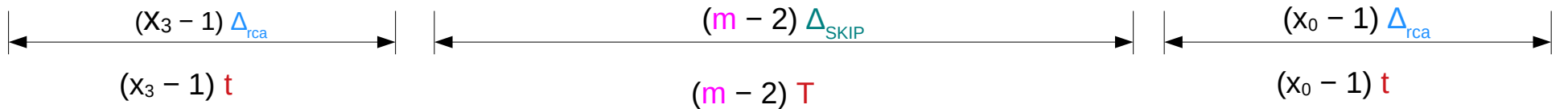

t denote the time required for a carry signal to ripple across a bit
 T denote the time required for the signal to skip over a group of bits
 m denotes the optimal number of groups for an n -bit carry chain

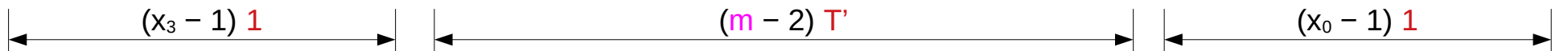

T' normalized delay of T over t

Carry Skip Adder – maximum carry delay (3)

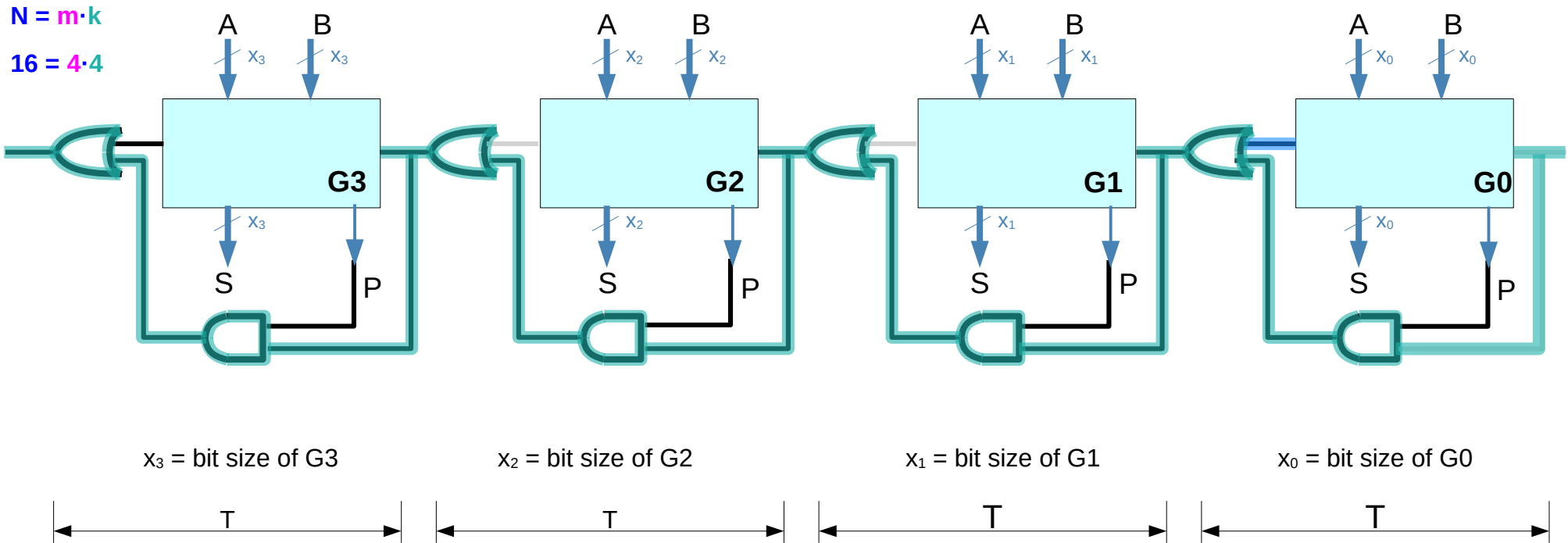

Carry Skip Delays

Carry Skip Adder – maximum carry delay (3)

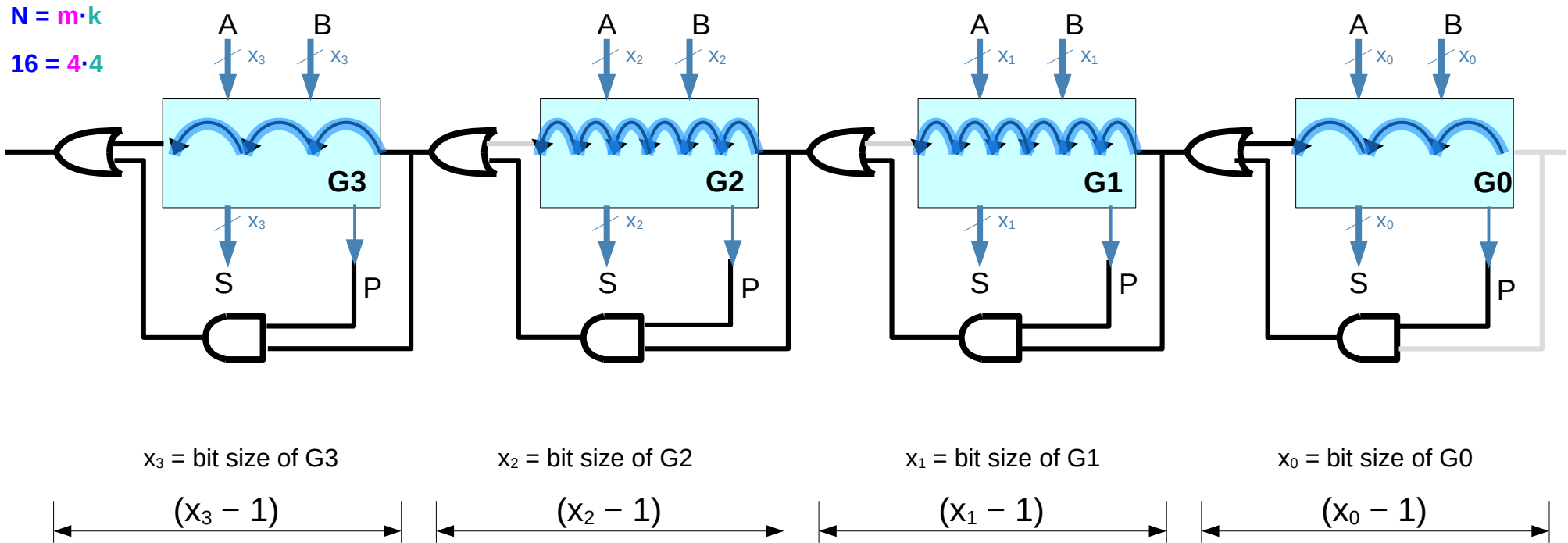

Carry Ripple delays

Minimum skip path delay y_i of the i^{th} group

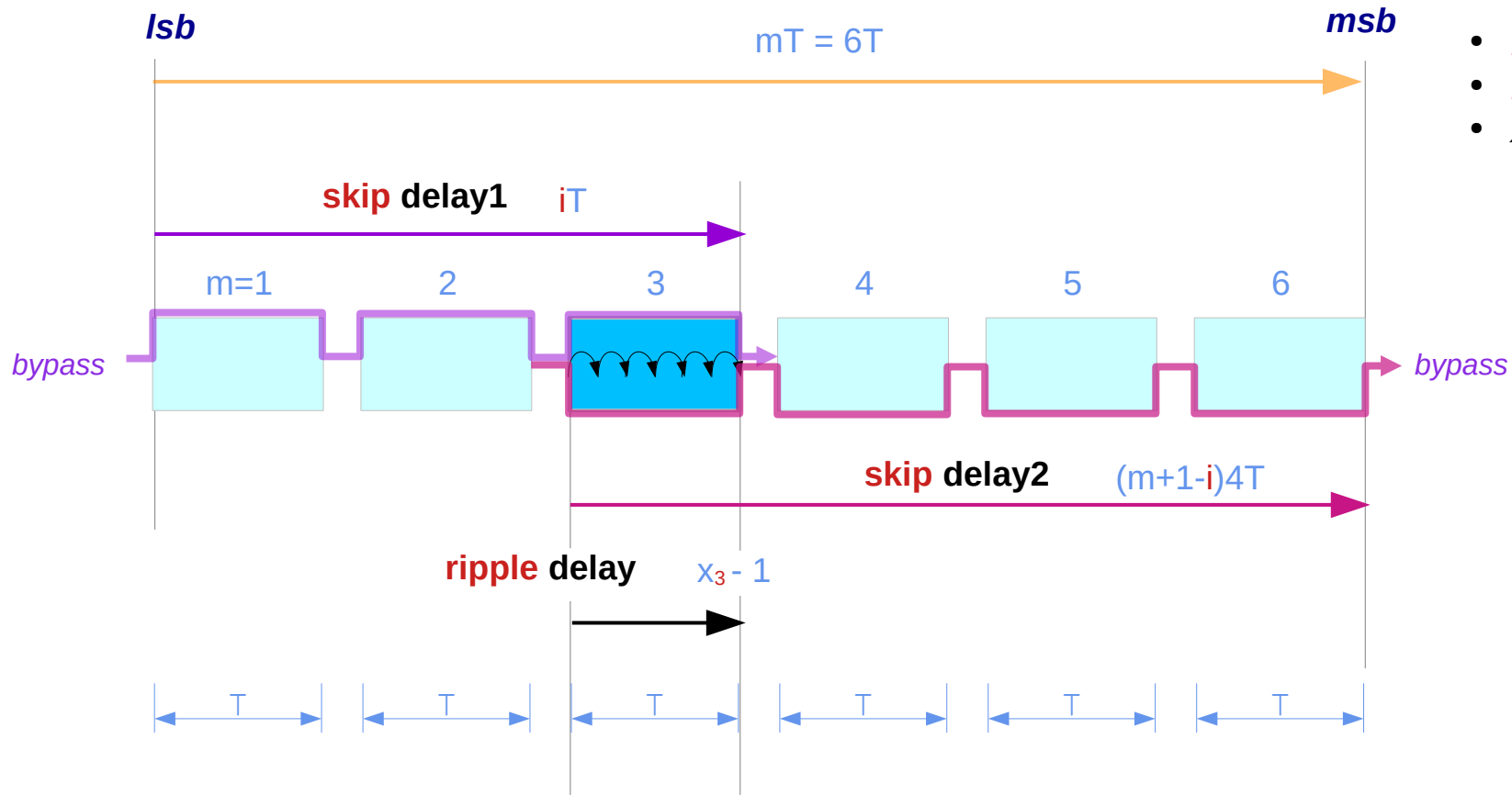

- n bits
- m groups
- x_i group size

terminating carry **ripple delay \leq skip delay1**
 generating carry **ripple delay \leq skip delay2**

Parallel Delay Paths

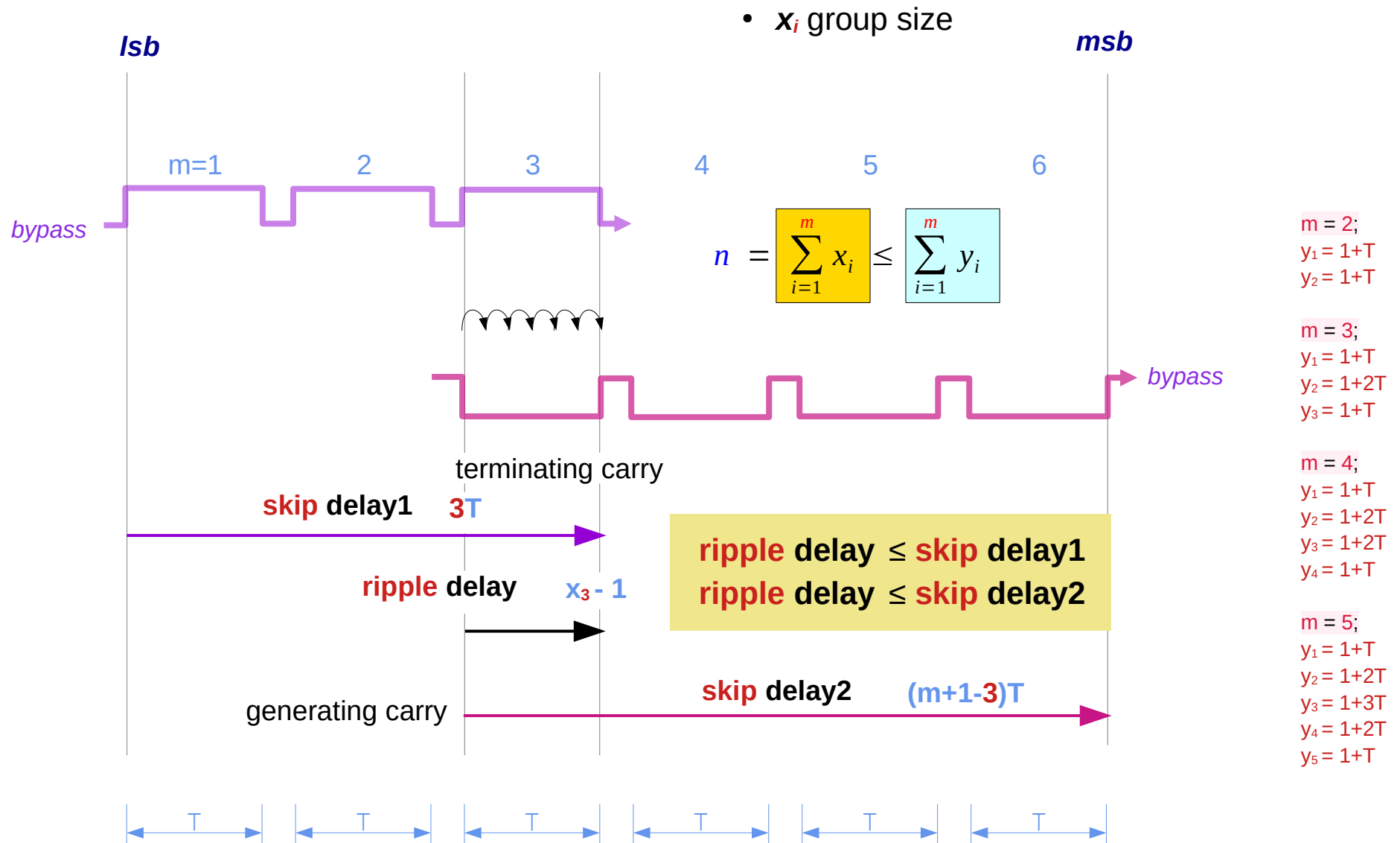

Maximum skip path delay y_i of the i^{th} group

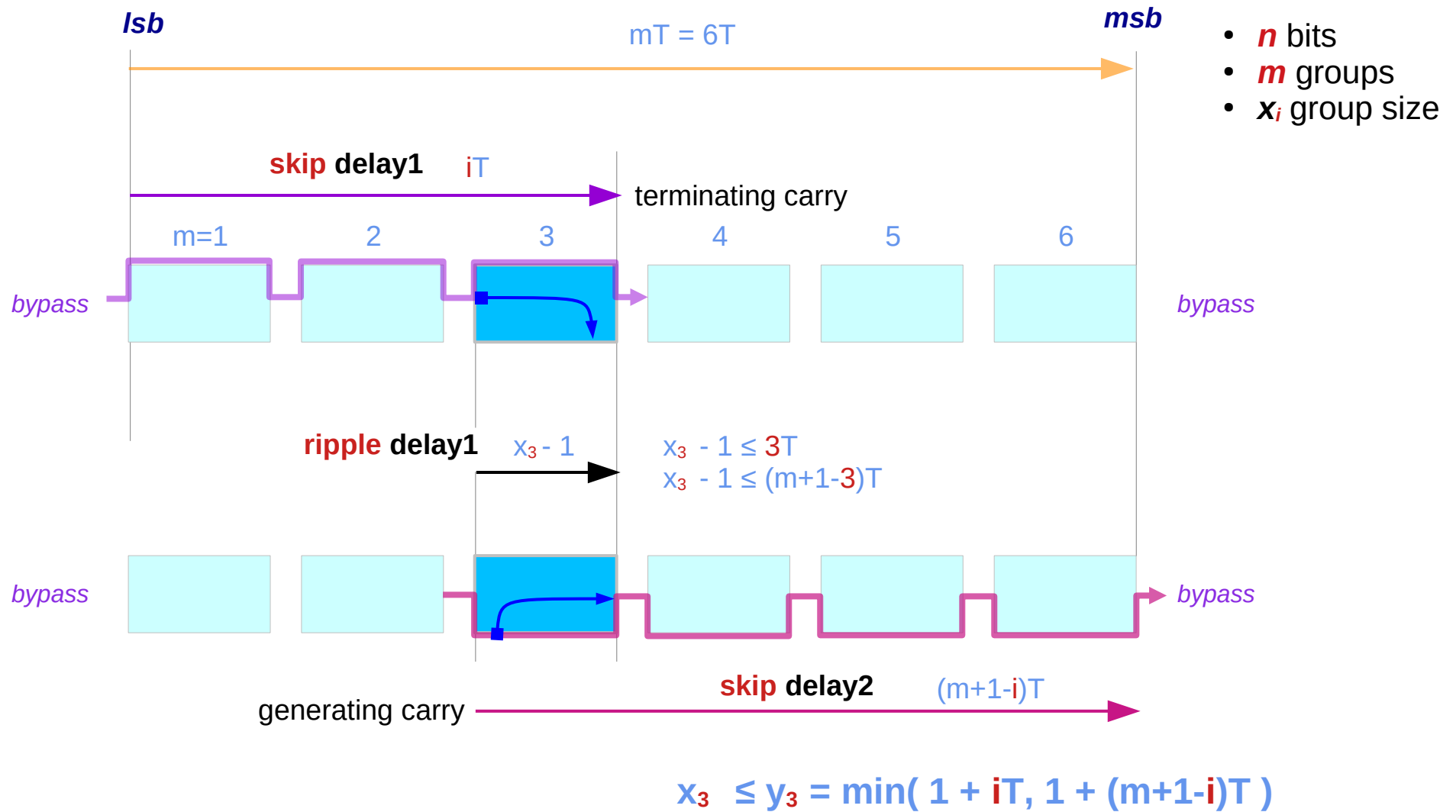

Determining m the number of groups (1)

Method 1 – using a histogram

Let m be the smallest positive integer such that

$$n \leq \sum_{i=1}^{(m)} y_i$$

$m = 2;$
while $(y_1 + \dots + y_m < n)$ $m = m + 1;$

$$y_i = \min\{1 + iT, 1 + (m + 1 - i)T\}, \quad i = 1, \dots, m$$

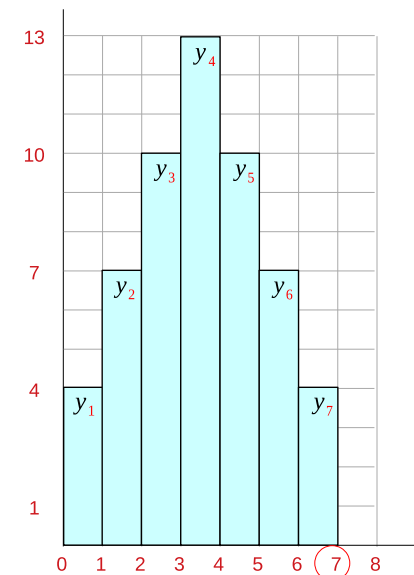

Method 2 – using a *closed formula*

Let m be the smallest positive integer such that

$$n \leq m + \frac{1}{2}mT + \frac{1}{4}m^2T + (1 - (-1)^m) \frac{1}{8}T$$



$$m = 2k$$

$$\frac{m}{2} = k$$

$$y_i = \min\{1 + iT, 1 + (m + 1 - i)T\}, \quad i = 1, \dots, m$$

$y_1 = \min\{1 + 1 \cdot T, 1 + (m - 0) \cdot T\}$	$0 \leq x_1 \leq 1 + 1 \cdot T$
$y_2 = \min\{1 + 2 \cdot T, 1 + (m - 1) \cdot T\}$	$0 \leq x_2 \leq 1 + 2 \cdot T$
$y_3 = \min\{1 + 3 \cdot T, 1 + (m - 2) \cdot T\}$	$0 \leq x_3 \leq 1 + 3 \cdot T$
$y_k = \min\{1 + k \cdot T, 1 + (k + 1) \cdot T\}$	$0 \leq x_k \leq 1 + k \cdot T$
$y_{k+1} = \min\{1 + (k + 1) \cdot T, 1 + k \cdot T\}$	$0 \leq x_{k+1} \leq 1 + k \cdot T$
$y_{m-2} = \min\{1 + (m - 2) \cdot T, 1 + 3 \cdot T\}$	$0 \leq x_{m-2} \leq 1 + 3 \cdot T$
$y_{m-1} = \min\{1 + (m - 1) \cdot T, 1 + 2 \cdot T\}$	$0 \leq x_{m-1} \leq 1 + 2 \cdot T$
$y_{m-0} = \min\{1 + (m - 0) \cdot T, 1 + 1 \cdot T\}$	$0 \leq x_{m-0} \leq 1 + 1 \cdot T$

Oklobdzija: High-Speed VLSI arithmetic units: adders and multipliers

$0 \leq x_i \leq y_i, i = 1, \dots, m$

$\frac{1}{2} \cdot k(k+1)$

Determining m the number of groups (2)

Method 1 – using a histogram

Let m be the smallest positive integer such that

$$n \leq \sum_{i=1}^{(m)} y_i$$

$m = 2;$
while $(y_1 + \dots + y_m < n)$ $m = m + 1;$

$$y_i = \min\{1 + iT, 1 + (m + 1 - i)T\}, \quad i = 1, \dots, m$$

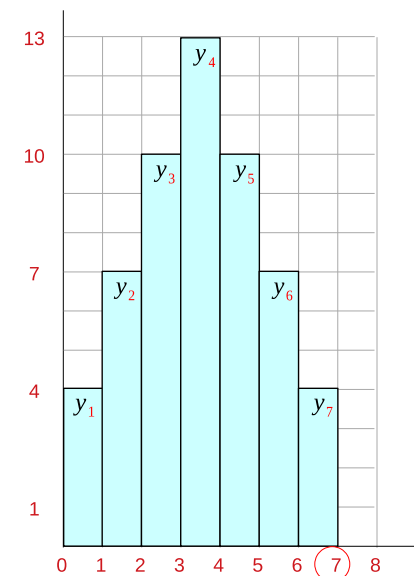

$m = 2; T = 3$

$$y_1 = \min\{1+T, 1+2T\} = 1+T = 4$$

$$y_2 = \min\{1+2T, 1+T\} = 1+T = 4$$

$m = 3; T = 3$

$$y_1 = \min\{1+T, 1+3T\} = 1+T = 4$$

$$y_2 = \min\{1+2T, 1+2T\} = 1+2T = 7$$

$$y_3 = \min\{1+3T, 1+T\} = 1+T = 4$$

$m = 4; T = 3$

$$y_1 = \min\{1+T, 1+4T\} = 1+T = 4$$

$$y_2 = \min\{1+2T, 1+3T\} = 1+2T = 7$$

$$y_3 = \min\{1+3T, 1+2T\} = 1+2T = 7$$

$$y_4 = \min\{1+4T, 1+T\} = 1+T = 4$$

$m = 5; T = 3$

$$y_1 = \min\{1+T, 1+5T\} = 1+T = 4$$

$$y_2 = \min\{1+2T, 1+4T\} = 1+2T = 7$$

$$y_3 = \min\{1+3T, 1+3T\} = 1+3T = 10$$

$$y_4 = \min\{1+4T, 1+2T\} = 1+2T = 7$$

$$y_5 = \min\{1+5T, 1+T\} = 1+T = 4$$

$m = 6; T = 3$

$$y_1 = \min\{1+T, 1+6T\} = 1+T = 4$$

$$y_2 = \min\{1+2T, 1+5T\} = 1+2T = 7$$

$$y_3 = \min\{1+3T, 1+4T\} = 1+3T = 10$$

$$y_4 = \min\{1+4T, 1+3T\} = 1+3T = 10$$

$$y_5 = \min\{1+5T, 1+2T\} = 1+2T = 7$$

$$y_6 = \min\{1+6T, 1+T\} = 1+T = 4$$

$m = 7; T = 3$

$$y_1 = \min\{1+T, 1+7T\} = 1+T = 4$$

$$y_2 = \min\{1+2T, 1+6T\} = 1+2T = 7$$

$$y_3 = \min\{1+3T, 1+5T\} = 1+3T = 10$$

$$y_4 = \min\{1+4T, 1+4T\} = 1+4T = 13$$

$$y_5 = \min\{1+5T, 1+3T\} = 1+3T = 10$$

$$y_6 = \min\{1+6T, 1+2T\} = 1+2T = 7$$

$$y_7 = \min\{1+7T, 1+1T\} = 1+T = 4$$

Determining m the number of groups (3)

Method 1 – using a histogram

Let m be the smallest positive integer such that

$$n \leq \sum_{i=1}^{(m)} y_i$$

$(m) = 2;$
while $(y_1 + \dots + y_{(m)} < n)$ $(m) = m + 1;$

$$y_i = \min\{1 + iT, 1 + ((m) + 1 - i)T\}, \quad i = 1, \dots, m$$

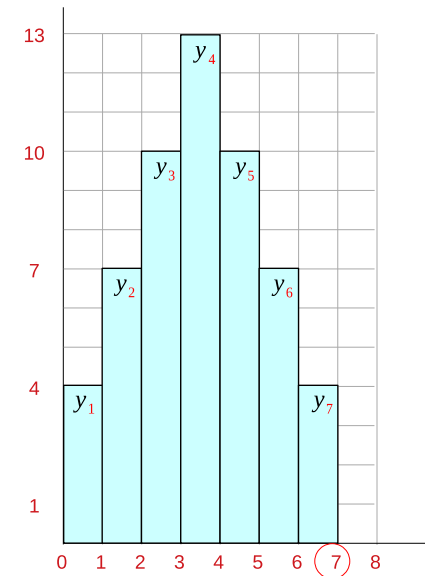

$m = 2$	$m = 3$	$m = 4$	$m = 5$	$m = 6$	$m = 7$
$\sum_{i=1}^2 y_i$	$\sum_{i=1}^3 y_i$	$\sum_{i=1}^4 y_i$	$\sum_{i=1}^5 y_i$	$\sum_{i=1}^6 y_i$	$\sum_{i=1}^7 y_i$
$2 + 2 \cdot T$	$3 + 4 \cdot T$	$4 + 6 \cdot T$	$5 + 9 \cdot T$	$6 + 12 \cdot T$	$7 + 16 \cdot T$
\uparrow	\uparrow	\uparrow	\uparrow	\uparrow	\uparrow
$2 + 2 \cdot T < n$	$3 + 4 \cdot T < n$	$4 + 6 \cdot T < n$	$5 + 9 \cdot T < n$	$6 + 12 \cdot T < n$	$7 + 16 \cdot T > n$
$2 + 2 \cdot 3 < 48$	$3 + 4 \cdot 3 < 48$	$4 + 6 \cdot 3 < 48$	$5 + 9 \cdot 3 < 48$	$6 + 12 \cdot 3 < 48$	$7 + 16 \cdot 3 > 48$
$8 < 48$	$15 < 48$	$22 < 48$	$32 < 48$	$42 < 48$	$55 > 48$
					$m = 7$

$n = 48$
 $T = 3$ \rightarrow $m = 7$

Determining x_i the group size of i^{th} group

construct a **histogram**
whose i -th column has height y_i

so these y_i 's are at least n unit squares
in the histogram, starting with the first row,
shade in n of the squares, row by row

let x_i denote the number of shaded squares
in column i of the histogram,
 $i = 1, \dots, m$

$$0 \leq x_i \leq y_i, \quad i=1, \dots, m$$

$$n = \sum_{i=1}^m x_i \leq \sum_{i=1}^m y_i$$

$$n = \sum_{i=1}^7 x_i$$

$$n = 4+7+8+9+9+7+4=48 < 7+16 \cdot 3=55$$

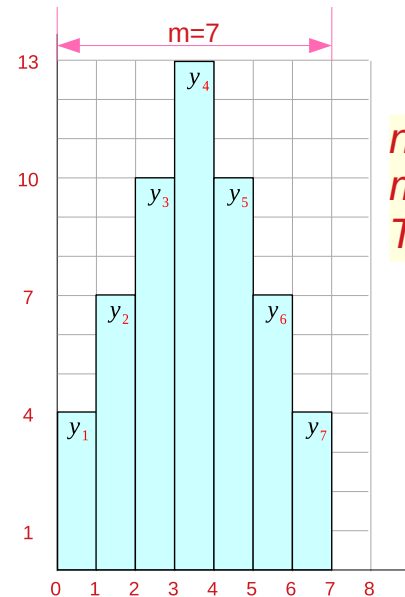

$n = 48$
 $m = 7$
 $T = 3$

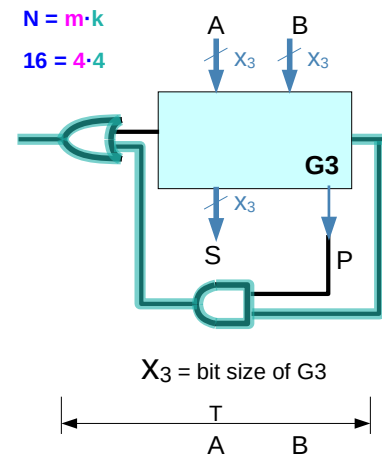
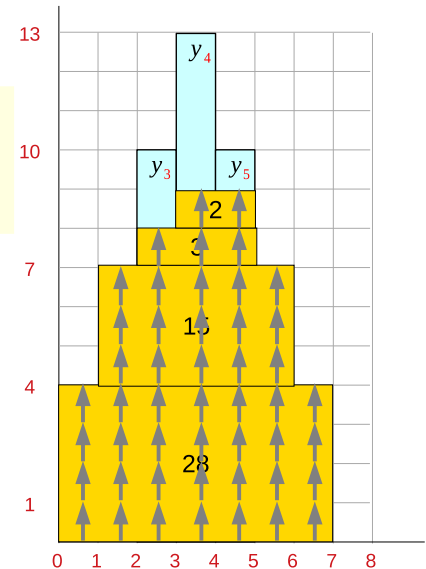

$N = m \cdot k$
 $16 = 4 \cdot 4$

$m = 7; \quad T = 3$
 $x_1 = 4 \leq y_1 = 4$
 $x_2 = 7 \leq y_2 = 7$
 $x_3 = 8 < y_3 = 10$
 $x_4 = 9 < y_4 = 13$
 $x_5 = 9 < y_5 = 10$
 $x_6 = 7 \leq y_6 = 7$
 $x_7 = 4 \leq y_7 = 4$

Maximum delay y_i of the i^{th} group for a given m (1)

$m = 2;$

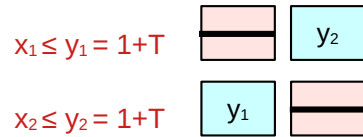

$m = 4;$

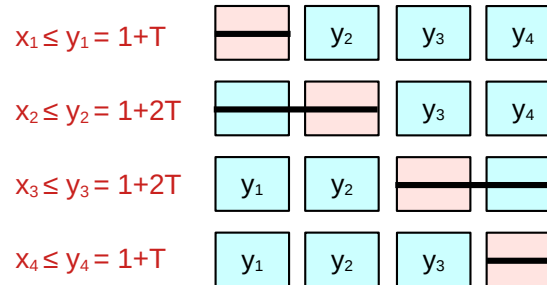

$m = 5;$

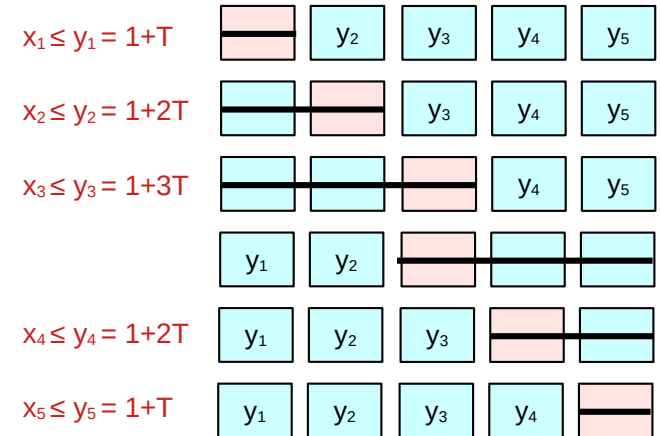

$m = 3;$

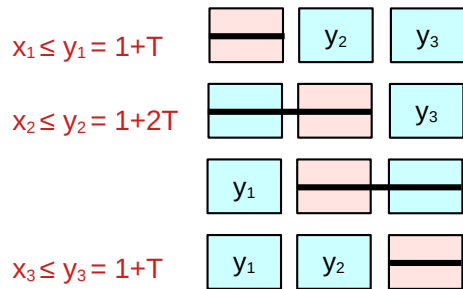

$$n \leq \sum_{i=1}^{(m)} y_i$$

$m = 2;$
while $(y_1 + \dots + y_m < n)$ $m = m+1;$

$$y_i = \min\{1+iT, 1+(m+1-i)T\}, \quad i = 1, \dots, m$$

$$n = \sum_{i=1}^m x_i \leq \sum_{i=1}^m y_i$$

$$0 \leq x_i \leq y_i, \quad i=1, \dots, m$$

Maximum delay y_i of the i^{th} group for a given m (2)

$m = 6;$

$$x_1 \leq y_1 = 1+T$$



$$x_2 \leq y_2 = 1+2T$$



$$x_3 \leq y_3 = 1+3T$$



$$x_4 \leq y_4 = 1+3T$$

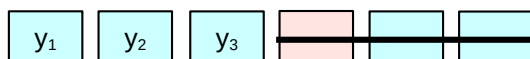

$$x_5 \leq y_5 = 1+2T$$

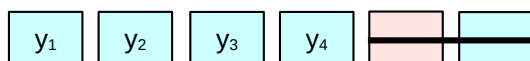

$$x_6 \leq y_6 = 1+T$$

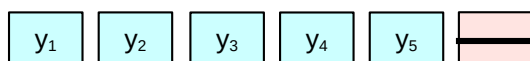

$m = 7;$

$$x_1 \leq y_1 = 1+T$$

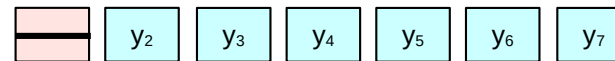

$$x_2 \leq y_2 = 1+2T$$

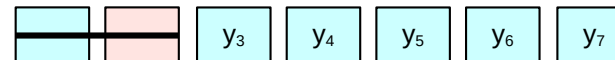

$$x_3 \leq y_3 = 1+3T$$

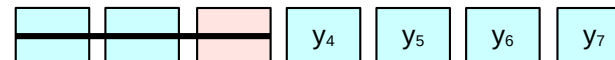

$$x_4 \leq y_4 = 1+4T$$

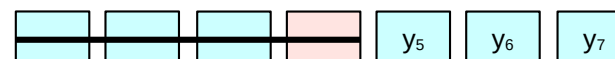

$$x_5 \leq y_5 = 1+3T$$

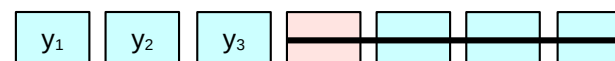

$$x_6 \leq y_6 = 1+2T$$

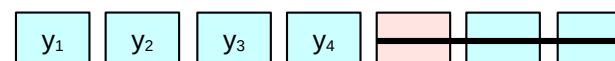

$$x_7 \leq y_7 = 1+T$$

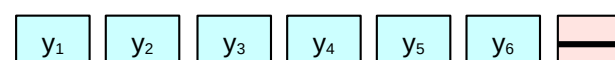

$$n \leq \sum_{i=1}^m y_i$$

$m = 2;$
while $(y_1 + \dots + y_m < n)$ $m = m+1;$

$$y_i = \min\{1+iT, 1+(m+1-i)T\}, \quad i = 1, \dots, m$$

$$n = \sum_{i=1}^m x_i \leq \sum_{i=1}^m y_i$$

$$0 \leq x_i \leq y_i, \quad i=1, \dots, m$$

Procedure

(I) Let m be the smallest positive integer such that

$$n \leq m + \frac{1}{2}mT + \frac{1}{4}m^2T + (1 - (-1)^m)\frac{1}{8}T = \sum_{i=1}^m y_i$$

- total $n = 48$ bits
- $m = 7$ groups
- i -th group has x_i bits (size)
- constant skip delay $T = T(x_i) = 3$

(II) Let

$$y_i = \min\{1 + iT, 1 + (m + 1 - i)T\}, \quad i = 1, \dots, m$$

and construct a **histogram** whose i -th column has height y_i
for example, for $T=3$, and $n=48$, we have $m=7$

(III) It is easily verified that the area of the histogram in (II) is

$$\sum_{i=1}^m y_i = m + \frac{1}{2}mT + \frac{1}{4}m^2T + (1 - (-1)^m)\frac{1}{8}T \geq n$$

so these are at least n unit squares in the histogram
starting with the first row, shade in n of the squares, row by row
Let x_i denote the number of shaded squares in column i of the histogram,
 $i = 1, \dots, m$

$$n = \sum_{i=1}^m x_i \leq \sum_{i=1}^m y_i$$

Maximum propagation time P

$$y_i = \min\{1+iT, 1+(m+1-i)T\}, \quad i = 1, \dots, m$$

the scheme (i), (ii), (iii)
gives the max prop time mT

$$y_1 = \min\{1+1 \cdot T, 1+(m+1-1)T\} = 1+T$$

$$x_1 \leq y_1 = 1+T$$

$$y_m = \min\{1+m \cdot T, 1+(m+1-m)T\} = 1+T$$

$$x_m \leq y_m = 1+T$$

$$y_2 = \min\{1+2 \cdot T, 1+(m+1-2)T\} = 1+2T$$

$$x_2 \leq y_2 = 1+2T$$

$$y_{m-1} = \min\{1+(m-1) \cdot T, 1+(m+1-(m-1))T\} = 1+2T$$

$$x_{m-1} \leq y_{m-1} = 1+2T$$

$$y_3 = \min\{1+3 \cdot T, 1+(m+1-3)T\} = 1+3T$$

$$x_3 \leq y_3 = 1+3T$$

$$y_{m-2} = \min\{1+(m-2) \cdot T, 1+(m+1-(m-2))T\} = 1+3T$$

$$x_{m-2} \leq y_{m-2} = 1+3T$$

Oklobdzija: High-Speed VLSI arithmetic units : adders and multipliers

Maximum propagation time P

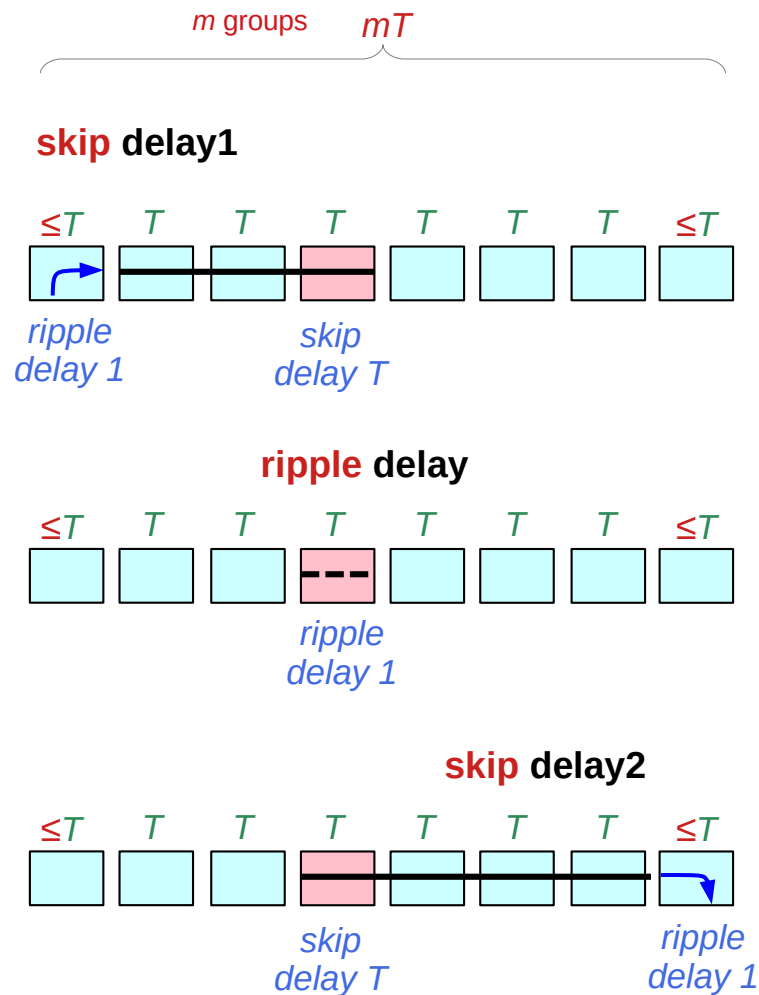

the scheme (i), (ii), (iii)
gives the max prop time mT

- skip delay1** iT generating carry
- ripple delay** $x_i - 1$
- skip delay2** $(m+1-i)T$ terminating carry

$$x_i - 1 \leq iT$$

$$x_i - 1 \leq (m+1-i)T$$

$$x_i \leq 1 + iT$$

$$x_i \leq 1 + (m+1-i)T$$

$$x_i \leq \min \{1 + iT, 1 + (m+1-i)T\}$$

$$x_i \leq y_i$$

$$y_i = \min \{1 + iT, 1 + (m+1-i)T\}$$

Oklobdzija: High-Speed VLSI arithmetic units : adders and multipliers

Maximum propagation time P

$$y_i = \min\{1+iT, 1+(m+1-i)T\}, \quad i = 1, \dots, m$$

the scheme (i), (ii), (iii)
gives the max prop time mT

$$y_1 = \min\{1+1 \cdot T, 1+(m+1-1)T\} = 1+T$$

$$y_m = \min\{1+m \cdot T, 1+(m+1-m)T\} = 1+T$$

$$x_1 \leq y_1 = 1+T$$

$$x_m \leq y_m = 1+T$$

$$\begin{aligned} x_1 - 1 &\leq 1T \\ x_1 - 1 &\leq (m+1-1)T \end{aligned}$$

$$\begin{aligned} x_1 - 1 &\leq T \\ x_1 - 1 &\leq mT \end{aligned}$$

$$\begin{aligned} x_m - 1 &\leq mT \\ x_m - 1 &\leq (m+1-m)T \end{aligned}$$

$$\begin{aligned} x_m - 1 &\leq mT \\ x_m - 1 &\leq T \end{aligned}$$

maximum propagation time

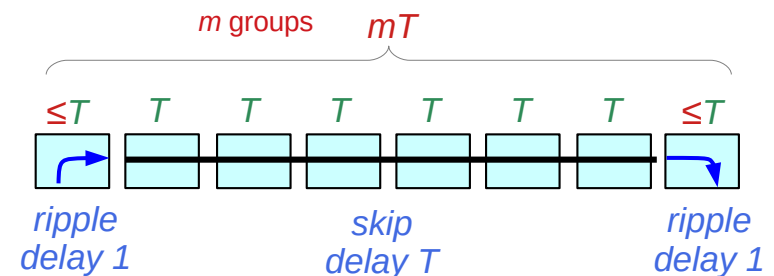

$$P_{max} = P_{1,m} \leq mT$$

$$P = P_{i,j} \leq mT$$

Oklobdzija: High-Speed VLSI arithmetic units : adders and multipliers

Maximum propagation time P

Lemma 1 When the bits of a **carry skip adder** are grouped according to the scheme (i)-(iii), the **maximum propagation time** of a carry signal is mT

The carry generated at the 2^{nd} bit position and terminating at the $(n-1)^{\text{th}}$ bit position clearly has **propagation time** mT .

We must show that *any other* carry signal has propagation time smaller than or equal to mT

propagation time of a carry signal $\leq mT$
the maximum propagation time = mT

the scheme (i), (ii), (iii) gives the max prop time mT

maximum propagation time

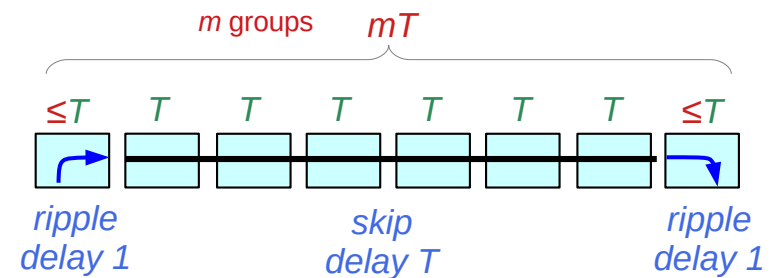

$$P_{max} = P_{1,m} \leq mT$$

Procedure

(I) Let m be the smallest positive integer

$$n \leq \sum_{i=1}^m y_i \quad i = 1, \dots, m$$

(II) Let

$$y_i = \min\{1+iT, 1+(m+1-i)T\}$$

(III) Let $x_i, i = 1, \dots, m$

starting with the first row, row by row

$$n = \sum_{i=1}^m x_i \leq \sum_{i=1}^m y_i$$

Variable block size = x_i bits for the i -th group

find the smallest m

$$n \leq \sum_{i=1}^m y_i = \sum_{i=1}^m \min\{1+iT, 1+(m+1-i)T\}$$

$$\textcircled{m} = 2; \\ \text{while } (y_1 + \dots + y_{\textcircled{m}} < n) \textcircled{m} = m+1;$$

$m = 2;$	$m = 4;$	$m = 5;$	$m = 6;$	$m = 7;$
$y_1 = 1+T$	$y_1 = 1+T$	$y_1 = 1+T$	$y_1 = 1+T$	$y_1 = 1+T$
$y_2 = 1+T$	$y_2 = 1+2T$	$y_2 = 1+2T$	$y_2 = 1+2T$	$y_2 = 1+2T$
	$y_3 = 1+2T$	$y_3 = 1+3T$	$y_3 = 1+3T$	$y_3 = 1+3T$
$m = 3;$	$y_4 = 1+T$	$y_4 = 1+2T$	$y_4 = 1+3T$	$y_4 = 1+4T$
$y_1 = 1+T$		$y_5 = 1+T$	$y_5 = 1+2T$	$y_5 = 1+3T$
$y_2 = 1+2T$			$y_6 = 1+T$	$y_6 = 1+2T$
$y_3 = 1+T$				$y_7 = 1+T$

the scheme (i), (ii), (iii)
gives the **max propagation time** mT

Propagation Time P

find the smallest m

$$n \leq \sum_{i=1}^m y_i = \sum_{i=1}^m \min\{1+iT, 1+(m+1-i)T\}$$

$m = 2$;
while $(y_1 + \dots + y_m < n)$ $m = m + 1$;

the scheme (i), (ii), (iii)
gives the max propagation time mT



propagation time of a carry signal $\leq mT$
the maximum propagation time = mT

propagation time

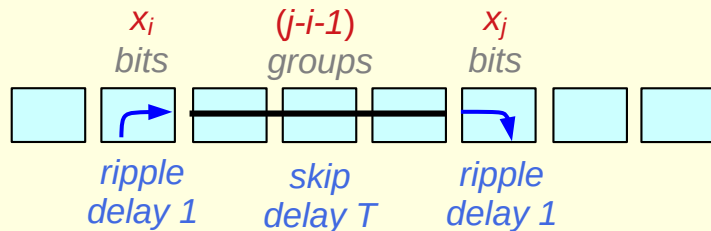

$$P = P_{i,j} \quad \forall i, \forall j \quad 1 \leq i, j \leq m$$

maximum propagation time

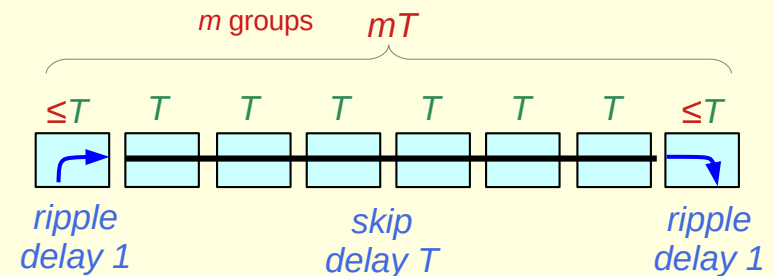

$$P_{max} = P_{1,m} \leq mT$$

Oklobdzija: High-Speed VLSI arithmetic units : adders and multipliers

Maximum delay and optimal group size

the maximum propagation time
 \propto the number of groups

$$D \propto m$$

- not an optimal optimal division
- *larger number of groups* \rightarrow
- *larger delays* \rightarrow

- when group size m is not optimal

then there is an optimal group size $= r$

- the maximum delay with the group size m $D_m = mT$
- the maximum delay with the group size r $D_r = rT$
- r must be smaller than m $r \leq m$

$$D_r < D_m$$

$$\rightarrow rT < mT$$

$$\rightarrow r < m$$

Maximum delay of a carry signal

Lemma 2 Let D denote the **maximum delay** of a carry signal in a n bit carry skip adder with **group sizes** chosen **optimally**. Then

- n bits
- r groups

$$(m-1)T \leq D \leq mT$$

Since we have exhibited a division of the carry chain into **groups** in such a way that the **maximum delay** of a carry signal is mT We clearly have $D \leq mT$

the **maximum delay** = D
the **optimal group size** = m
 $(m-1)T \leq D \leq mT$

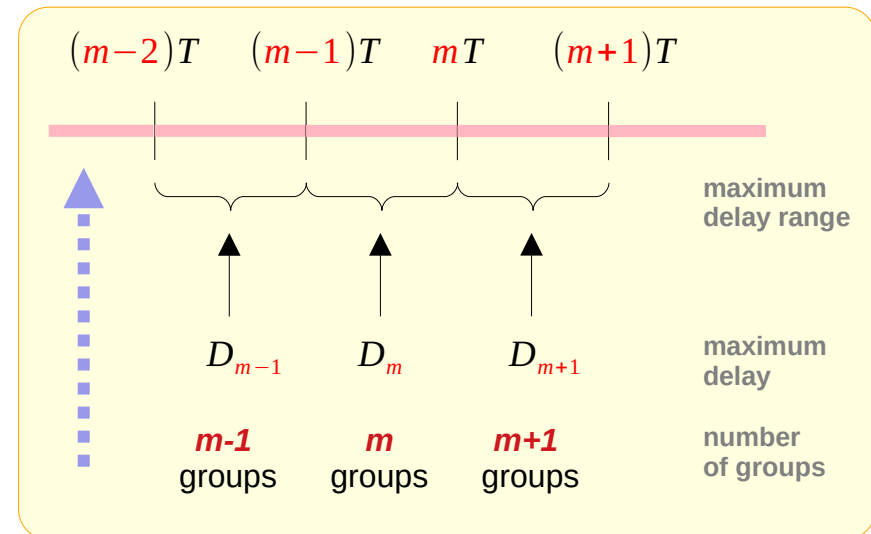

Oklobdzija: High-Speed VLSI arithmetic units : adders and multipliers

Maximum delay of a carry signal

$$(m-1)T \leq D \leq mT$$

Assume there are r groups
then 2 cases : **even r** , **odd r**
for each of these 2 cases

prove $mT - D < T + 1$

➔ $mT - D \leq T$

➔ $(m-1)T \leq D$

P : the propagation delay of
any carry signal path $\leq mT$

upper bound

D : the max of P

➔ $\text{diff}(mT, D) \leq T$

➔ $\text{diff}(mT, \max P) \leq T$

lower bound

$(m-1)T \leq D$

Maximum delays of carry signals ($r = 2k$)

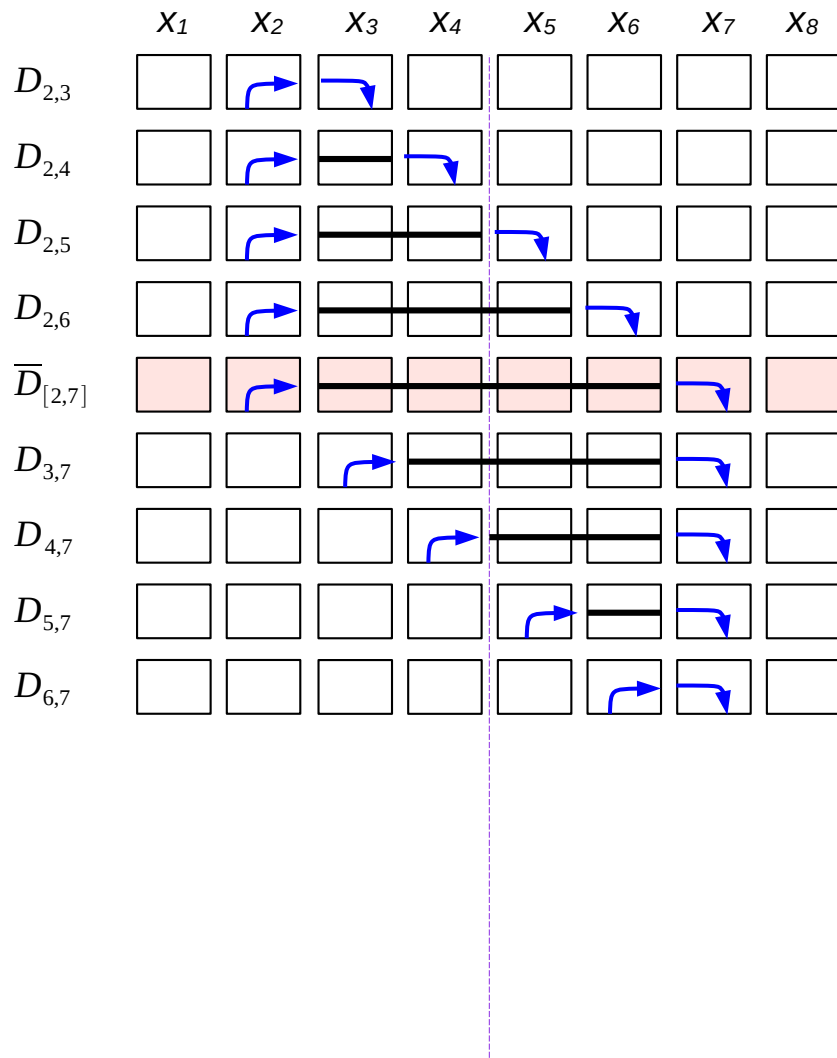

$\bar{D}_{[2,7]}$ = the maximum delay of carry signals $\leq D$ generated in the i -th group and terminated in the j -th group such that $2 \leq i, j \leq 7$

$$\bar{D}_{[2,7]} = \max \left\{ \begin{array}{c} D_{2,3}, D_{2,4}, D_{2,5}, D_{2,6}, \\ D_{2,7}, \\ D_{3,7}, D_{4,7}, D_{5,7}, D_{6,7} \end{array} \right\}$$

$$\bar{D}_{[2,7]} = \bar{D}_{[2,8-2+1]} = \bar{D}_{[s,8-s+1]}, \quad s = 2$$

$\bar{D}_{[s,r-s+1]}$ = the maximum delay of carry signals generated in the i -th group and terminated in the j -th group such that $s \leq i, j \leq r-s+1$

Maximum delays of carry signals ($r = 2k$)

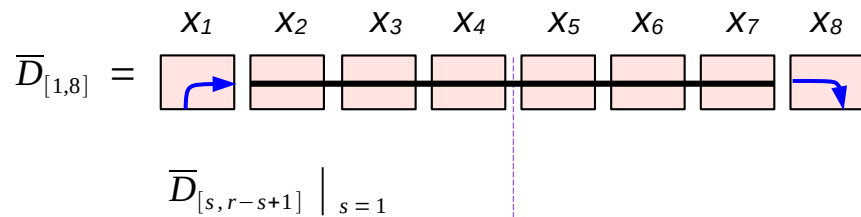

$\bar{D}_{[1,8]} =$ The maximum delay of carry signals $\leq D$ generated in the i -th group or terminated in the j -th group such that $1 \leq i, j \leq 8$

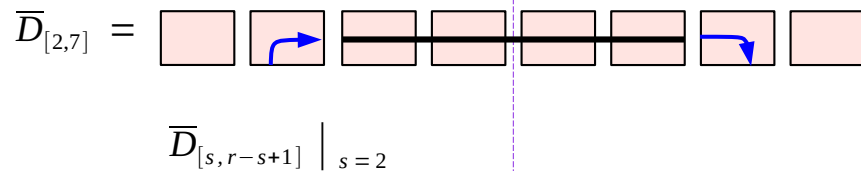

$\bar{D}_{[2,7]} =$ The maximum delay of carry signals $\leq D$ generated in the i -th group or terminated in the j -th group such that $2 \leq i, j \leq 7$

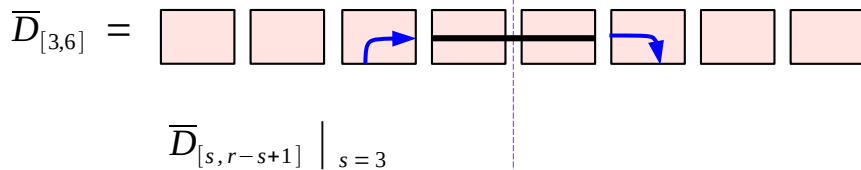

$\bar{D}_{[3,6]} =$ The maximum delay of carry signals $\leq D$ generated in the i -th group or terminated in the j -th group such that $3 \leq i, j \leq 6$

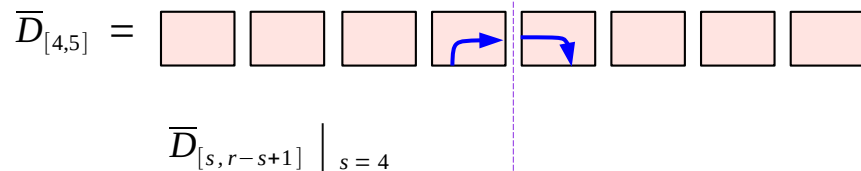

$\bar{D}_{[4,5]} =$ The maximum delay of carry signals $\leq D$ generated in the i -th group or terminated in the j -th group such that $4 \leq i, j \leq 5$

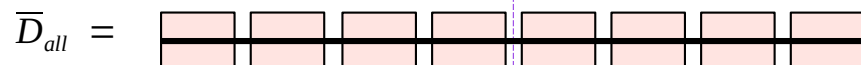

$\bar{D}_{all} =$ All skip delay $\leq D$

$$D = \max\{\bar{D}_{[1,8]}, \bar{D}_{[2,7]}, \bar{D}_{[3,6]}, \bar{D}_{[4,5]}\}$$

Max delay of all carry signals

Oklobdzija: High-Speed VLSI arithmetic units : adders and multipliers

Maximum delays of carry signals ($r = 2k+1$)

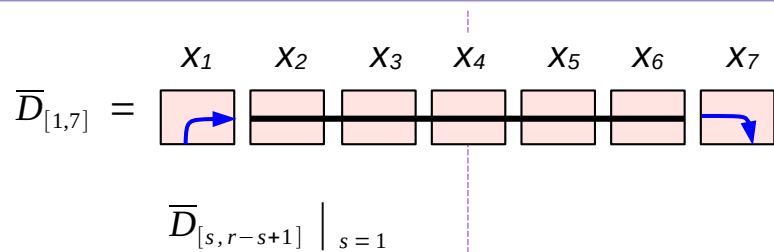

$\bar{D}_{[1,7]} =$ The maximum delay of carry signals $\leq D$ generated in the i -th group or terminated in the j -th group such that $1 \leq i, j \leq 8$

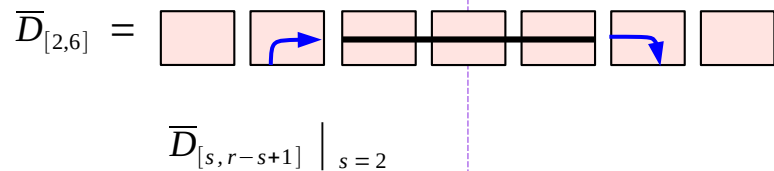

$\bar{D}_{[2,6]} =$ The maximum delay of carry signals $\leq D$ generated in the i -th group or terminated in the j -th group such that $2 \leq i, j \leq 7$

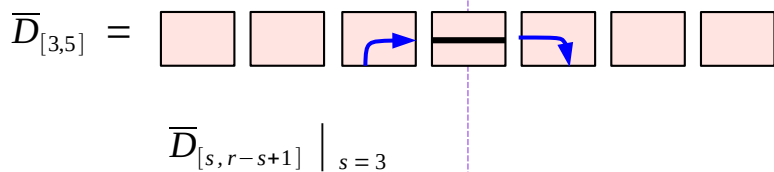

$\bar{D}_{[3,5]} =$ The maximum delay of carry signals $\leq D$ generated in the i -th group or terminated in the j -th group such that $3 \leq i, j \leq 6$



$\bar{D}_{all} =$ All skip delay



$\tilde{D}_{all} =$ Comparable to all skip delay $\leq D$

$$D = \max\{\bar{D}_{[1,8]}, \bar{D}_{[2,7]}, \bar{D}_{[3,6]}, \bar{D}_{[4,5]}\}$$

Max delay of all carry signals

Oklobdzija: High-Speed VLSI arithmetic units : adders and multipliers

Maximum delays of carry signals ($r = 2k$)

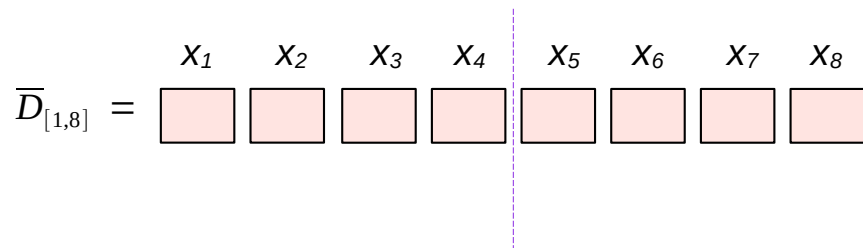

$$D = \max_{s=1}^{r/2} \bar{D}_{[s, r-s+1]}$$

$$= \max_{s=1}^k \bar{D}_{[s, 2k+1-s]}$$

$$= \max_{s=1}^4 \bar{D}_{[s, 9-s]}$$

**Max delay of
all carry signals**

$$\begin{aligned} \bar{D}_{[1,r]} &\leq D \\ \bar{D}_{[2,r-1]} &\leq D \\ &\vdots \\ \bar{D}_{[k,k+1]} &\leq D \end{aligned}$$

$$\bar{D}_{all} \leq D$$

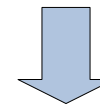

$$(m-1)T \leq D$$

Lower bound of D

Oklobdzija: High-Speed VLSI arithmetic units : adders and multipliers

Maximum delays of carry signals ($r = 2k+1$)

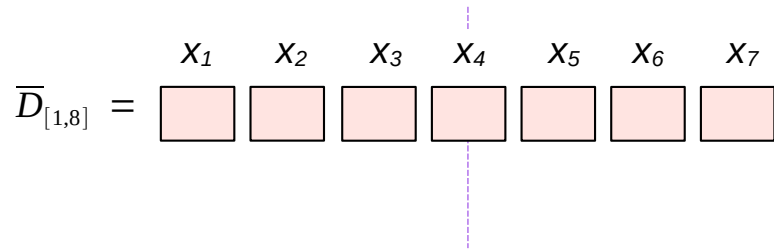

$$D = \max_{s=1}^{\text{floor}(r/2)} \bar{D}_{[s, r-s+1]}$$

$$= \max_{s=1}^k \bar{D}_{[s, 2k+2-s]}$$

$$= \max_{s=1}^3 \bar{D}_{[s, 8-s]}$$

Max delay of
all carry signals

$$\begin{aligned} \bar{D}_{[1,r]} &\leq D \\ \bar{D}_{[2,r-1]} &\leq D \\ &\vdots \\ \bar{D}_{[k,k+1]} &\leq D \end{aligned}$$

$$\tilde{D}_{all} \leq D$$

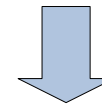

$$(m-1)T \leq D$$

Lower bound of D

Example delays of carry signals ($r = 2k$) (1)

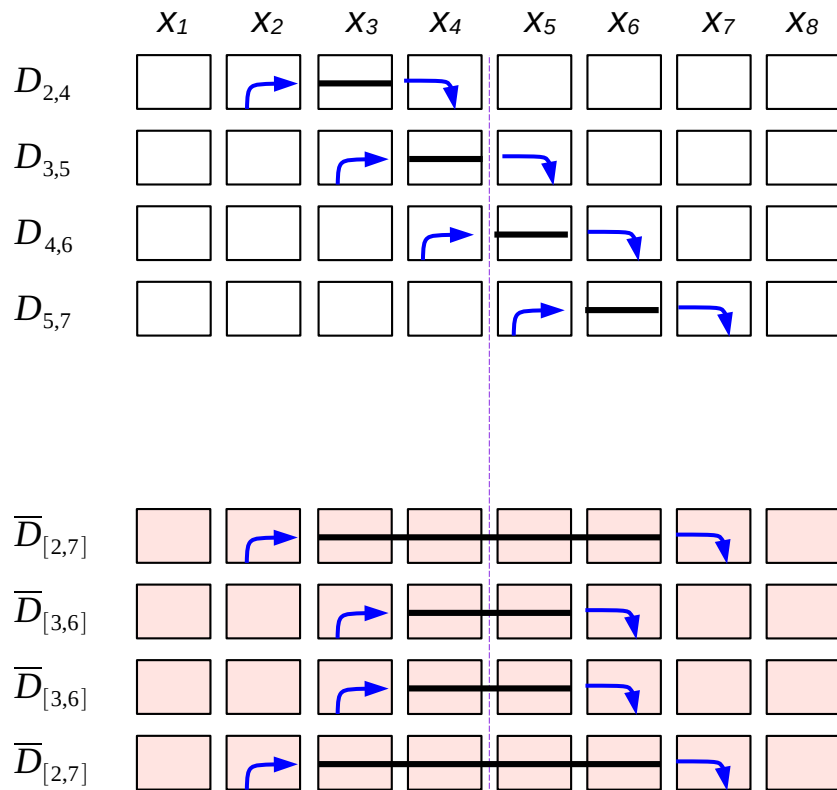

Oklobdzija: High-Speed VLSI arithmetic units : adders and multipliers

Example delays of carry signals ($r = 2k$) (2)

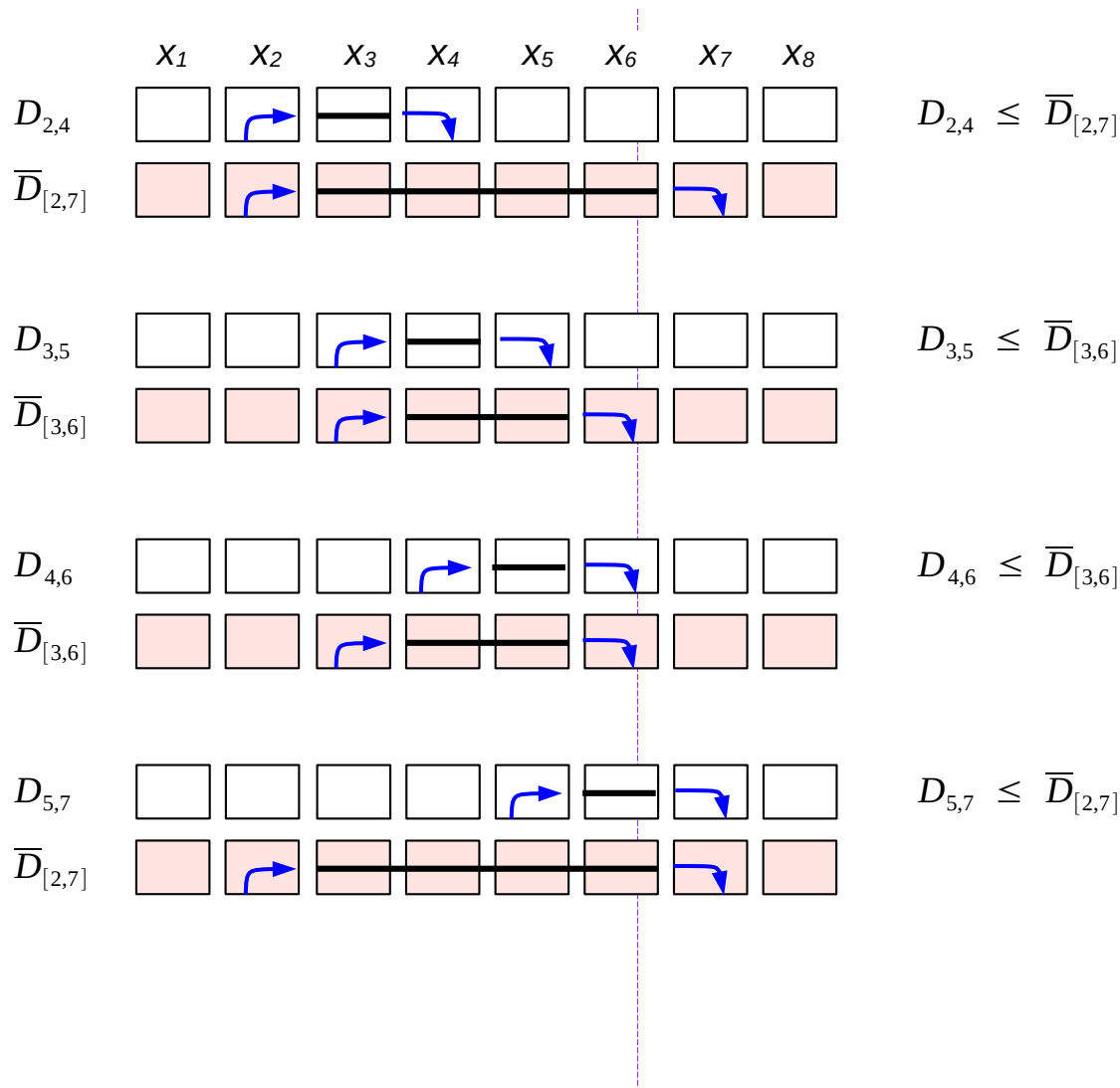

Oklobdzija: High-Speed VLSI arithmetic units : adders and multipliers

Optimal division into groups (1-1)

Theorem 1

The scheme 2(i) – 2(iii) given above for dividing the bits of a carry skip adder into **groups** is **optimal** for $2 \leq T \leq 7$

dividing the bits into groups by the scheme 2(i) – 2(iii) gives **m groups**

propagation time of a carry signal $\leq mT$
the maximum propagation time = mT

the maximum delay = D
the optimal group size = m

$$(m-1)T \leq D \leq mT$$

(I) Let m be the smallest positive integer such that

$$n \leq m + \frac{1}{2}mT + \frac{1}{4}m^2T + (1-(-1)^m)\frac{1}{8}T$$

(II) Let $y_i = \min\{1+iT, 1+(m+1-i)T\}$,
 $i = 1, \dots, m$

and construct a **histogram** whose i -th column has height y_i

(III) the area of the histogram in (II) is

$$m + \frac{1}{2}mT + \frac{1}{4}m^2T + (1-(-1)^m)\frac{1}{8}T \geq n$$

so these are at least n unit squares in the histogram starting with the first row, shade in n of the squares, row by row
Let x_i denote the number of shaded squares in column i of the histogram,
 $i = 1, \dots, m$

Optimal division into groups (1-2)

Assume

- the scheme by 2(i) – 2(iii) (m groups) is not optimal
- let D be the maximum delay corresponding to an optimal division of the bits into groups
- there are r groups in the optimal division.

Since a carry in signal to the least significant bit group can skip over each group

we have $rT \leq D \leq mT$ so $r \leq m$

*if m is not optimal, but r is
then $mT \geq rT$ (smaller delay rT)
thus $m \geq r$ (smaller r exists)*

m groups

- not optimal division
- D = maximum delay
- mT skip delay

r groups

- optimal division
- rT skip delay

skip delay

$$rT \leq D \leq mT$$

$$r \leq m$$

D = max delay is assumed
To be greater than all skip
delay rT of the optimal division

Optimal division into groups (1-2)

If the optimal division gives m groups

m groups  mT

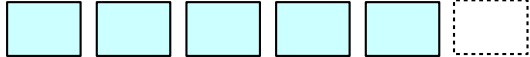
$(m-1)$ groups  $(m-1)T$

$$D \leq mT$$

$$(m-1)T \leq D$$

Normally, by 2(i) – 2(iii) (m groups) is optimal and its maximum delay D is less than all skip delay mT

$$D \leq mT$$

To prove this, first, negate that

- m is not by the optimal division, but r is
- D is greater than all skip delay of the optimal division

- when optimal group size = m
the maximum delay $D_m \leq mT$
- when optimal group size = $(m-1)$
the maximum delay $D_{m-1} \leq (m-1)T$

$D =$ maximum delay

$$rT \leq D \leq mT$$

$$r \leq m \quad \longrightarrow \quad r < (m-1)$$

Optimal division into groups (1-2)

$$rT \leq D \leq mT \quad \text{so } r \leq m$$

Optimal division : r groups

$D' \leq$ all skip delay rT (r groups)

$D =$ maximum delay

Non-optimal division : m groups

$D \leq$ all skip delay mT (m groups)

too many partitions $m \quad r \leq m$

$$rT \leq D \leq mT$$

$$r \leq m \quad \rightarrow \quad r < (m-1)$$

Assume max delay D is greater than all skip delay rT of the optimal division

if m is not optimal, but r is
then $mT \geq rT$ (smaller delay rT)
thus $m \geq r$ (smaller r exists)

D is max delay for m groups
 D' is max delay for r groups
then $D' \leq rT \leq D \leq mT$

Oklobdzija: High-Speed VLSI arithmetic units : adders and multipliers

Optimal division into groups (2)

we have $rT \leq D \leq mT$ so $r \leq m$

If $r = m$
then $D = mT \Rightarrow D = rT \quad rT = D$

If $r = m-1, (r < m)$
 $D \geq (m-1)T \Rightarrow D \geq (m-1)T = rT \quad rT \leq D$

if $r < m-1, (r < m)$
 $D \geq (m-1)T \Rightarrow D \geq (m-1)T > rT \quad rT < D$

Oklobdzija: High-Speed VLSI arithmetic units : adders and multipliers

Optimal division into groups (3)

we have $rT \leq D \leq mT$ so $r \leq m$

If $r = m$ then $D = mT$

and the **theorem** holds by **lemma 1**

When the bits of a carry skip adder are grouped according to the scheme (i)-(iii), the maximum propagation time of a carry signal is mT

$$(m-1)T \leq D \leq mT$$

Lemma 1 When the bits of a *carry skip adder* are *grouped* according to the scheme (i)-(iii), the *maximum propagation time* of a *carry signal* is mT

Theorem 1 The scheme 2(i) – 2(iii) given above for dividing the bits of a carry skip adder into *groups* is *optimal* for $2 \leq T \leq 7$

(5) $r = 2k$ $X = 4 - T^2$

$$mT - D \leq T + \frac{-8(T/n) + 4}{\sqrt{4(T/n) + 8(T/n^2)} + \sqrt{4(T/n) + 4/n^2}}$$

$r = 2k + 1$ $X = 4$

$$mT - D \leq T + \frac{(T-2)^2/n}{\sqrt{4(T/n) + 4(T/n^2)} + \sqrt{4(T/n) + (T/n)^2 + 4/n^2}}$$

m groups – not optimal division
 r groups – optimal division

D = maximum delay

$$rT \leq D \leq mT$$

$$r \leq m$$

Optimal division into groups (3)

If $r = m-1$, ($r < m$)
 m and r have different parities and
it follows from (5)
that $mT - D \leq T$ for $2 \leq T \leq 7$

so that $D \geq (m-1)T$
since $r = m-1$,
 $D \geq (m-1)T = rT \quad rT \leq D$

This means that a signal which
skips over each of the r groups (rT)
has delay less than the maximum D .

$$rT \leq D \leq mT$$

m is not optimal division
 r is optimal division

Oklobdzija: High-Speed VLSI arithmetic units : adders and multipliers

Lemma 1 When the bits of a carry skip adder are grouped according to the scheme (i)-(iii), the maximum propagation time of a carry signal is mT

Theorem 1 The scheme 2(i) – 2(iii) given above for dividing the bits of a carry skip adder into groups is optimal for $2 \leq T \leq 7$

(5) $r = 2k$ $X = 4 - T^2$

$$mT - D \leq T + \frac{-8(T/n) + 4}{\sqrt{4(T/n) + 8(T/n^2)} + \sqrt{4(T/n) + 4/n^2}}$$

$r = 2k+1$ $X = 4$

$$mT - D \leq T + \frac{(T-2)^2/n}{\sqrt{4(T/n) + 4(T/n^2)} + \sqrt{4(T/n) + (T/n)^2 + 4/n^2}}$$

m groups – not optimal division
 r groups – optimal division

D = maximum delay

$$rT \leq D \leq mT$$

$$r \leq m$$

Optimal division into groups (4)

Similarly,

if $r < m-1$, ($r < m$)

$$(m-1)T \leq D$$

since $r < m-1$,

$$rT < (m-1)T \leq D$$

so that a signal which skips over each group has delay $rT < D$.

$$rT < D \leq mT$$

m is not optimal division

r is optimal division

m groups – not optimal division
 r groups – optimal division

D = maximum delay

$$rT \leq D \leq mT$$

$$r \leq m$$

Optimal division into groups (5)

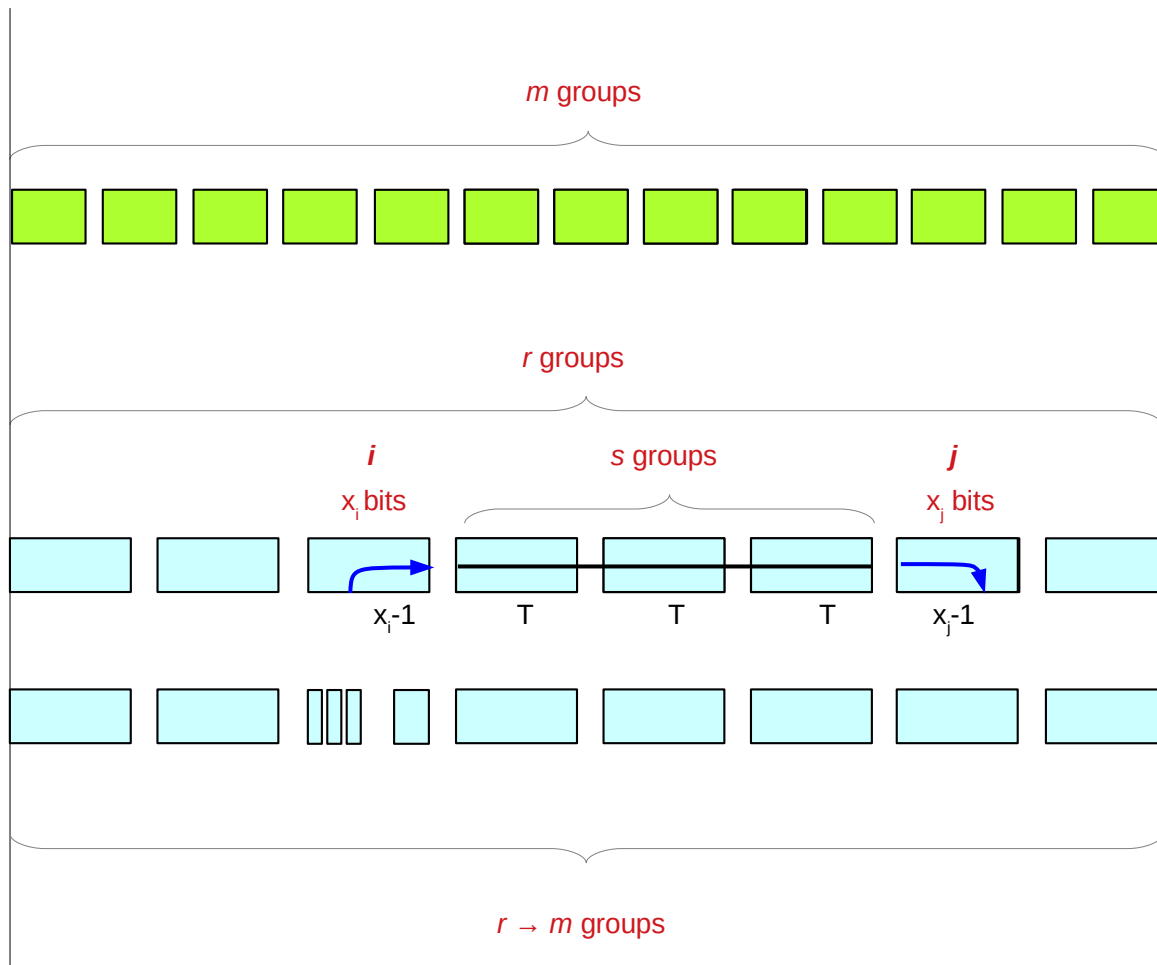

m groups – not optimal division
r groups – optimal division

D = maximum delay

$$rT \leq D \leq mT$$

$$r \leq m$$

if *m* is not optimal, but *r* is

$((r + 1) + 1) + 1) \dots \rightarrow m$
 contradiction! *r* must be *m*

Oklobdzija: High-Speed VLSI arithmetic units : adders and multipliers

Optimal division into groups (5)

It follows that a signal with delay D

must start in a group i ,
ripple to the end of group i ,

then skip over $s < r$ groups and

either terminate, or ripple through
the first few bits of a group $j > i$.

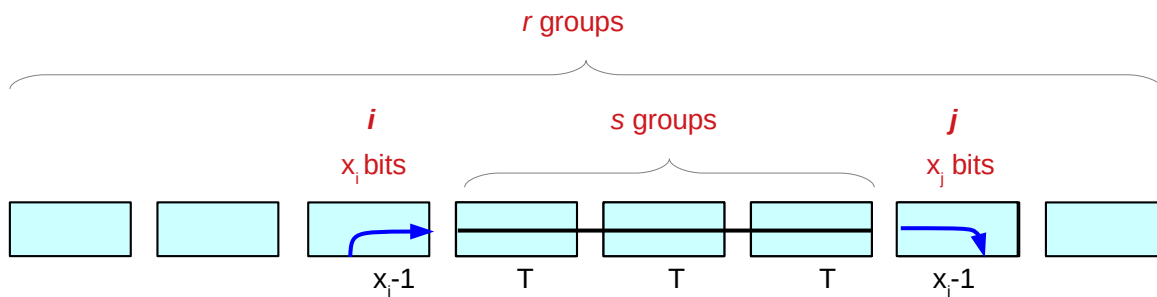

m groups – not optimal division
 r groups – optimal division

$D = \text{maximum delay}$

$$rT \leq D \leq mT$$

$$r \leq m$$

Oklobdzija: High-Speed VLSI arithmetic units : adders and multipliers

Optimal division into groups (6-1)

Let x_i and x_j denote the lengths of the i -th and j -th groups respectively.

Assume that i is chosen as small as possible and j as large as possible. (longer path)

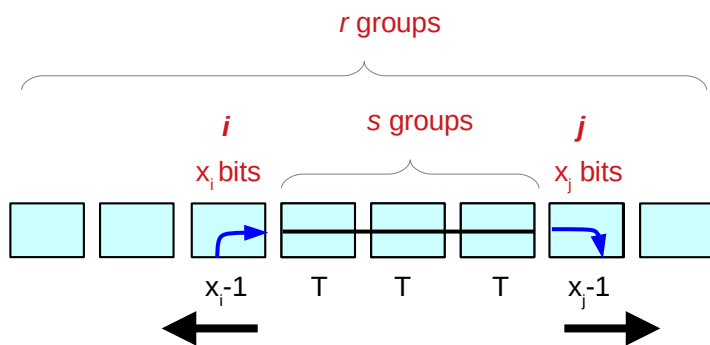

Oklobdzija: High-Speed VLSI arithmetic units : adders and multipliers

Optimal division into groups (6-2)

A signal originating in group i ,
rippling to the end of this group i and
 then skipping over the next s group
 has delay $(x_i - 1) + sT$

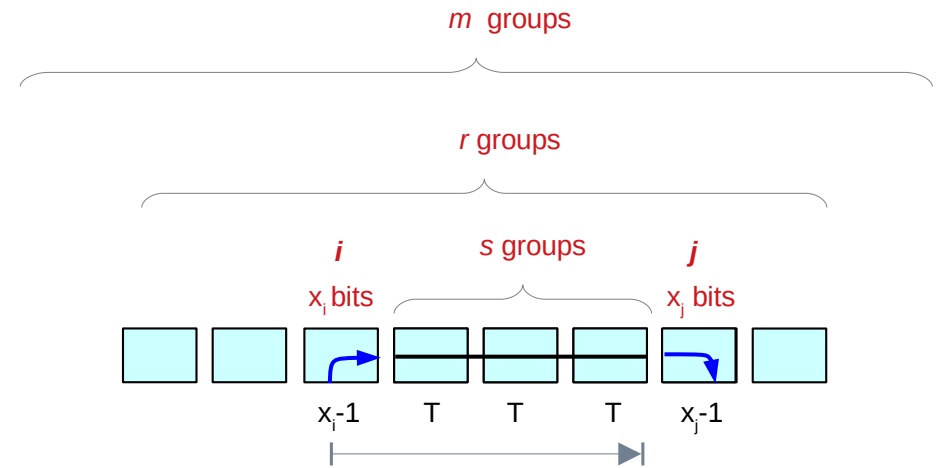

$$\begin{aligned}
 D &\leq (x_i - 1) + sT \\
 &\leq (x_i - 1) + (r - 1)T \\
 &\leq (x_i - 1) + (m - 2)T.
 \end{aligned}$$

$s < r$ groups \Rightarrow
 $r < m$ groups \Rightarrow

$$\begin{aligned}
 &\Rightarrow s \leq (r - 1) \\
 &\Rightarrow r \leq (m - 1)
 \end{aligned}$$

$$\begin{aligned}
 D &\leq (x_i - 1) + sT \\
 &< (x_i - 1) + rT \\
 &< (x_i - 1) + mT.
 \end{aligned}$$

if m is not optimal, but r is

$$\begin{aligned}
 &s < r < m \\
 &s \leq (r - 1) < (m - 1) \\
 &s \leq (r - 1) \leq (m - 2)
 \end{aligned}$$

Optimal division into groups (6-3)

$$\begin{aligned} D &\leq (x_i - 1) + sT \\ &\leq (x_i - 1) + (r - 1)T \\ &\leq (x_i - 1) + (m - 2)T \end{aligned}$$

$$(m - 1)T \leq D$$

$$D \leq (x_i - 1) + (m - 2)T$$

$$(m - 1)T \leq D \leq (x_i - 1) + (m - 2)T$$

$$(m - 1)T \leq (x_i - 1) + (m - 2)T$$

Since $D \geq (m - 1)T$
this implies that $x_i \geq T + 1$

$$T \leq (x_i - 1)$$

$$T + 1 \leq x_i$$

Optimal division into groups (7)

Divide group i into **two** groups such that the group containing the **msb** has size T .

Since the i -th group is the **first** group in which a signal having maximum delay can originate,

this subdivision does not increase the delay of any carry signal of maximum delay

However, it increases the number of **groups** by **1**

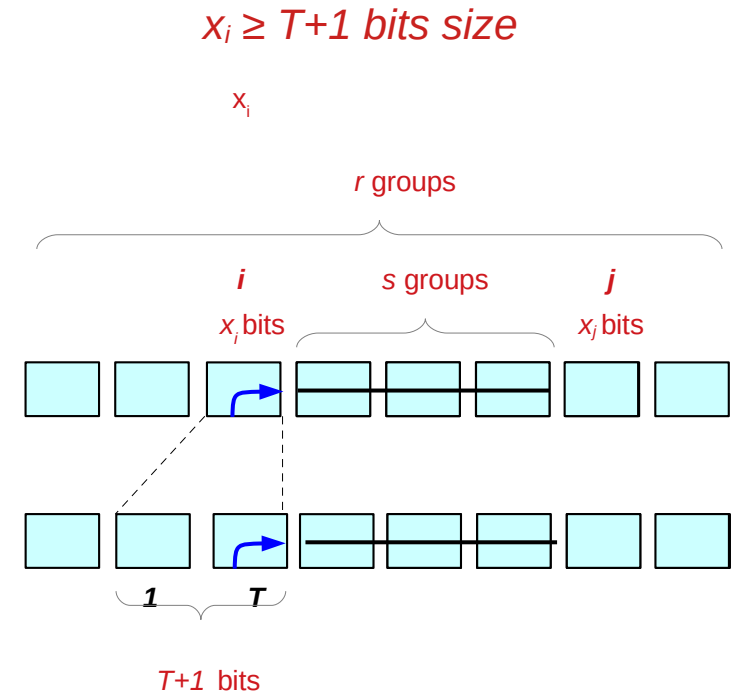

$$\begin{aligned}
 D &\leq (x_i - 1) + sT & (m-1)T &< D \\
 &\leq (x_i - 1) + (r-1)T & D &< (x_i - 1) + (m-2)T \\
 &\leq (x_i - 1) + (m-2)T. & x_i &\geq (T+1)
 \end{aligned}$$

Oklobdzija: High-Speed VLSI arithmetic units : adders and multipliers

Optimal division into groups (8-1)

Suppose now that a carry signal originates in a group i , ripples to its end, skips over $s \leq r-2$ groups and finally ripples through the first few bits of a group j and terminates.

We then have

$$\begin{aligned} D &\leq (x_i - 1) + sT + (x_j - 1) \\ &\leq x_i + x_j - 2 + (m - 3)T \end{aligned}$$

So that **either** $x_i \geq T+1$ **or** $x_j \geq T+1$

$s < r$ groups

$s \leq (r-1)$ groups

$r < m$ groups

$r \leq (m-1)$ groups

$s < r$ groups

$s \leq (r-2)$ groups

$r < m$ groups

$r \leq (m-2)$ groups

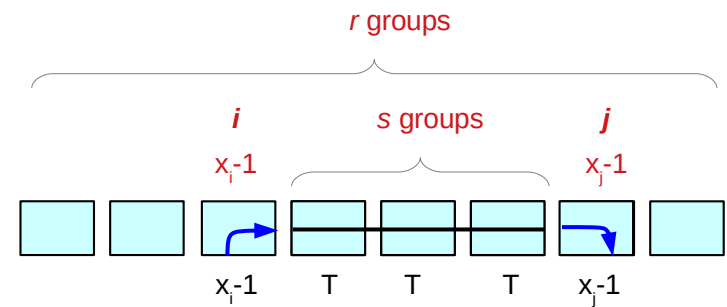

Oklobdzija: High-Speed VLSI arithmetic units : adders and multipliers

Optimal division into groups (8-2)

$$s < r < m$$

$$s \leq (r-1) < (m-1)$$

$$s \leq (r-1) \leq (m-2)$$

$$s \leq (r-2) \leq (m-3)$$

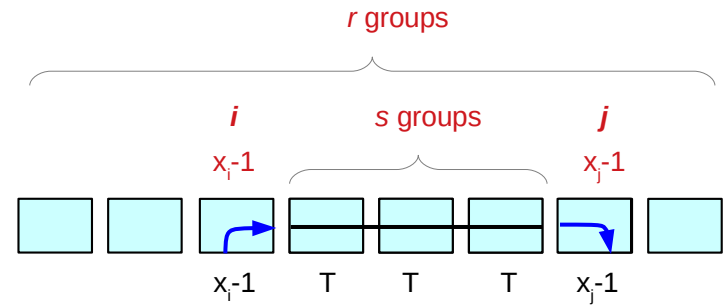

$$s \leq (r-2)$$

$$D \leq (x_i-1) + sT + (x_j-1)$$

$$\leq x_i + x_j - 2 + (r-2)T$$

$$\leq x_i + x_j - 2 + (m-3)T$$

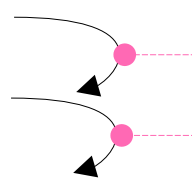

$$(m-1)T < D$$

$$D < (x_i-1) + (m-2)T \iff x_i \geq (T+1)$$

$$D < (x_j-1) + (m-2)T \iff x_j \geq (T+1)$$

So that either $x_i \geq T+1$ or $x_j \geq T+1$

Optimal division into groups (9)

So that either $x_i \geq T+1$ or $x_j \geq T+1$

This means that we can subdivide one of the groups i, j without increasing D not both of them

Continuing in this way, we can always increase the number r of group in an optimal division of a carry chain by 1 without increasing D if $r < m$

This means that we can arrive at an optimal division of the carry chain into m groups.

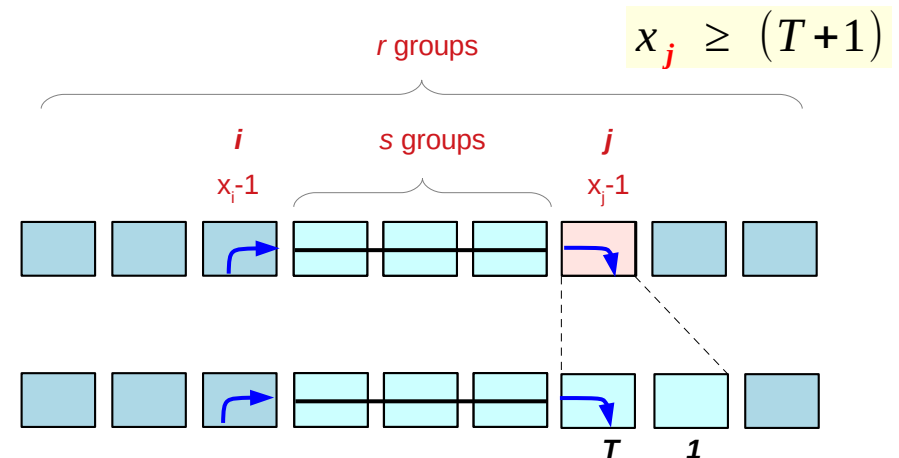
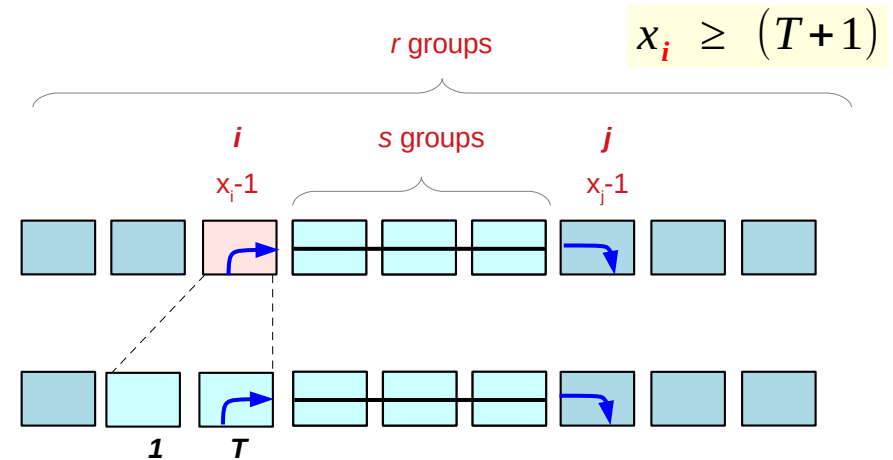

Optimal division into groups (9)

$$x_i \geq (T+1) > (T+2) \dots$$

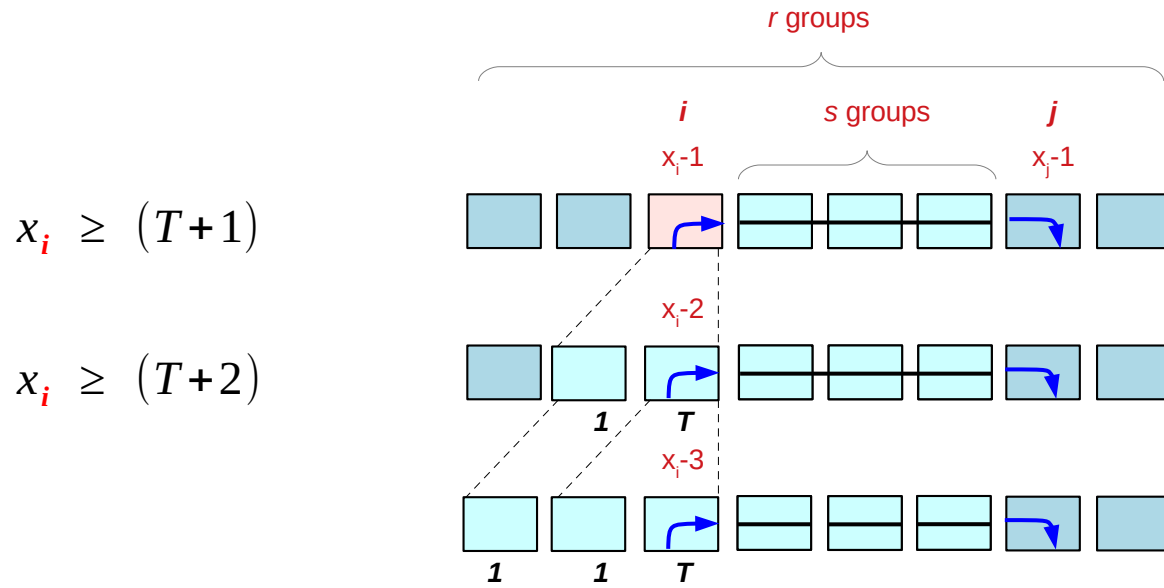

$$\begin{aligned} D &\leq (x_i - 1) + sT \\ &\leq (x_i - 1) + (r - 1)T \\ &\leq (x_i - 1) + (m - 2)T \end{aligned}$$

$$(m - 1)T \leq D \leq (x_i - 1) + (m - 2)T$$

if m is not optimal, but r is

$((r + 1) + 1) + 1) \dots \rightarrow m$
 contradiction! m must be r

Optimal division into groups (9)

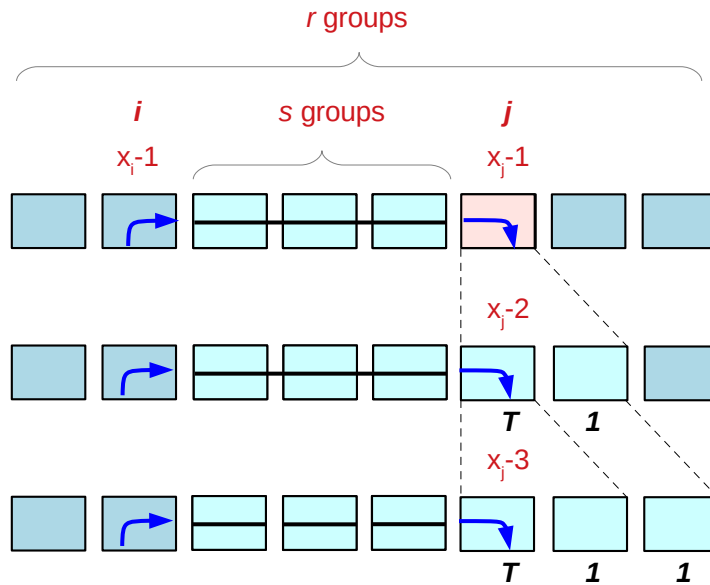

if m is not optimal, but r is

$((r+1)+1)+1) \dots \rightarrow m$
 contradiction! m must be r

$$x_j \geq (T+1) > (T+2) \dots$$

$$x_j \geq (T+1)$$

$$x_j \geq (T+2)$$

$$\begin{aligned} D &\leq (x_i-1) + sT \\ &\leq (x_i-1) + (r-1)T \\ &\leq (x_i-1) + (m-2)T \end{aligned}$$

$$(m-1)T \leq D \leq (x_i-1) + (m-2)T$$

Oklobdzija: High-Speed VLSI arithmetic units : adders and multipliers

Optimal division into groups (9)

$$x_i \geq (T+1) > (T+2) \dots$$

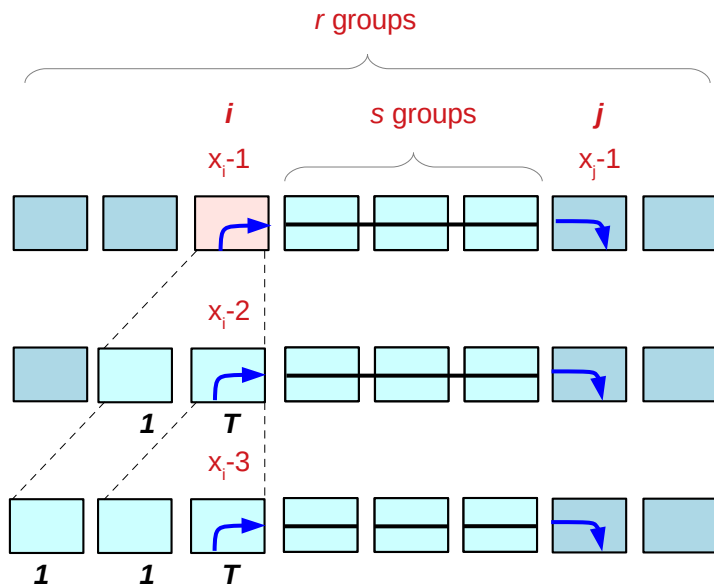

if m is not optimal, but r is

$((r+1)+1)+1 \dots \rightarrow m$
 contradiction! m must be r

$$x_j \geq (T+1) > (T+2) \dots$$

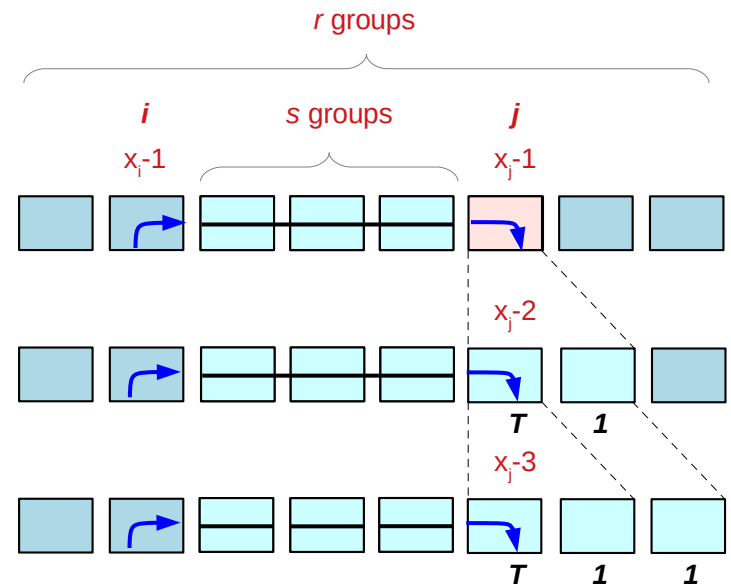

if m is not optimal, but r is

$((r+1)+1)+1 \dots \rightarrow m$
 contradiction! m must be r

Oklobdzija: High-Speed VLSI arithmetic units : adders and multipliers

Optimal division into groups (9)

Normally, by 2(i) – 2(iii) (m groups) is optimal
and its maximum delay D is less than all skip delay mT

$$D \leq mT$$

To prove this, first, negate that

- m is not by the optimal division, but r is
- D is greater than all skip delay of the optimal division

Assume

- the scheme by 2(i) – 2(iii) (m groups) is not optimal
- let D be the maximum delay corresponding to an optimal division
- there are r groups in the optimal division.

$$(\dots(((r+1)+1)+1) \dots +1) \rightarrow m : \text{optimal}$$

if m is not optimal, but r is

$$(\dots((r+1)+1)+1) \dots \rightarrow m$$

contradiction! m must be r

Optimal division into groups (11)

We must then have $D \geq mT$
which, together with **Lemma 2**,
Implies $D = mT$

This completes the proof of the theorem

m groups – not optimal division
 r groups – optimal division

$D =$ maximum delay

$$rT \leq D \leq mT$$

$$r \leq m$$

Lemma 2

Let D denote the maximum delay of a carry signal in a n bit carry skip adder with group sizes chosen optimally.

$$(m-1)T \leq D \leq mT$$

Theorem 1

The scheme 2(i) – 2(iii) given above for dividing the bits of a carry skip adder into groups is optimal for $2 \leq T \leq 7$