

Z Transform (H.1)

Definition

20170109

Copyright (c) 2016 Young W. Lim.

Permission is granted to copy, distribute and/or modify this document under the terms of the GNU Free Documentation License, Version 1.2 or any later version published by the Free Software Foundation; with no Invariant Sections, no Front-Cover Texts, and no Back-Cover Texts. A copy of the license is included in the section entitled "GNU Free Documentation License".

Based on
Complex Analysis for Mathematics and Engineering
J. Mathews

z - Transform

$$X(z) = \sum_{k=-\infty}^{+\infty} x[k] z^{-k}$$

$$z = |r| e^{j2\pi F} = |r| e^{j\Omega}$$

$$x[n] \longleftrightarrow X(z)$$

One Sided z-transform

$$X(z) = \sum_{k=0}^{+\infty} x[k] z^{-k}$$

Inverse z-Transform

$$X(z) = \mathcal{Z}\left[\{x_n\}_{n=0}^{\infty}\right] = \sum_{n=0}^{\infty} x_n z^{-n} = \sum_{n=0}^{\infty} x[n] z^{-n}$$

$$x_n = x[n] = \mathcal{Z}^{-1}[X(z)] = \frac{1}{2\pi i} \int_C X(z) z^{n+1} dz$$

Admissible Form of z -transform

$$X(z) = \sum_{k=0}^{\infty} x[n] z^{-n}$$

admissible z -transform

if $X(z)$ is a rational function

$$X(z) = \frac{P(z)}{Q(z)} = \frac{b_0 + b_1 z^1 + b_2 z^2 + \dots + b_{p-1} z^{p-1} + b_p z^p}{a_0 + a_1 z^1 + a_2 z^2 + \dots + a_{q-1} z^{q-1} + a_q z^q}$$

$P(z)$: a polynomial of degree p

$Q(z)$: a polynomial of degree q

D : Simply connected domain

C : Simple closed contour (CCW) in D

if $f(z)$ is analytic inside C and on C
except at the points z_1, z_2, \dots, z_k in C

then

$$\frac{1}{2\pi i} \int_C f(z) dz = \sum_{j=1}^k \text{Res}(f(z), z_j)$$

$$\oint_C f(z) dz = 2\pi i \sum_{k=1}^n \text{Res}(f(z), z_k)$$

finite number k of
singular points z_k

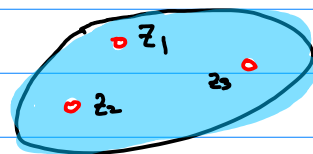

$$\oint_C f(z) dz = 0$$

if $f(z)$ is continuous in D and

$f(z) = F'(z)$: $F(z)$ is an antiderivative of $f(z)$

fundamental theorem of calculus

$$\oint_C f(z) dz = 0$$

if $f(z)$ is analytic within and on C

no singularity

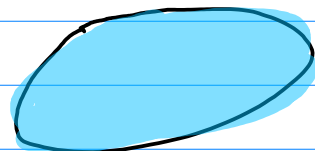

$$f(z) = \sum_{n=n_1}^{\infty} a_n^{(m)} (z - z_m)^n$$

$$\begin{aligned} a_n^{(m)} &= \frac{1}{2\pi i} \oint_C \frac{f(z')}{(z' - z_m)^{n+1}} dz' \\ &= \sum_k \operatorname{Res} \left(\frac{f(z)}{(z - z_m)^{n+1}}, z_k \right) \quad z_k \text{ within } C \\ &= \frac{1}{n!} f^{(n)}(z_m) \quad n \geq 0 \end{aligned}$$

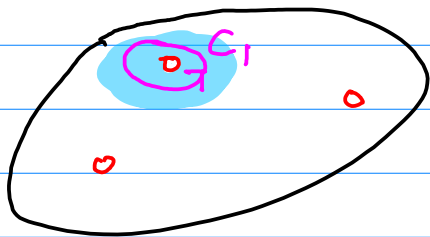

$a_n^{(0)}$ expansion at z_0

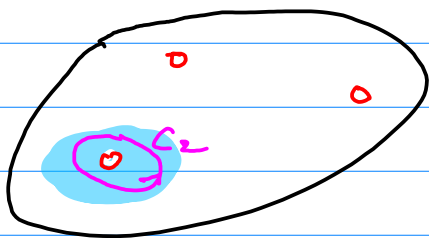

$a_n^{(1)}$ expansion at z_1

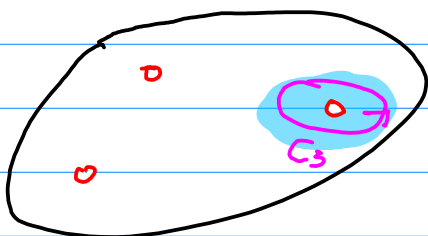

$a_n^{(2)}$ expansion at z_2

$$a_n^{(m)} = \text{Res}(f(z), z_m)$$

the residue of $f(z)$ at z_m using C_m

assumed that

there are several (m) singularities (poles) of $f(z)$ in a region

but that

C is taken to enclose only the pole z_m : C_m

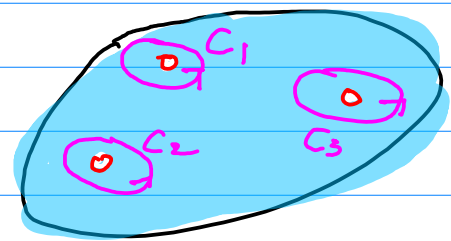
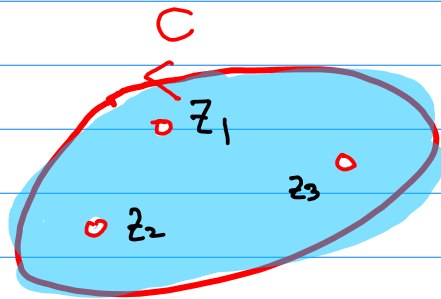

Laurent's Theorem

f : analytic within the annular domain D

$$r < |z - z_0| < R$$

then

$$f(z) = \sum_{k=-\infty}^{+\infty} a_k (z - z_0)^k, \text{ valid for } r < |z - z_0| < R$$

$$a_k = \frac{1}{2\pi i} \oint_C \frac{f(s)}{(s - z_0)^{k+1}} ds, \quad k = 0, \pm 1, \pm 2, \dots$$

C : a simple closed curve
that lies entirely within D
that encloses z_0

$$a_{-1} = \frac{1}{2\pi i} \oint_C f(s) ds \quad \rightarrow \quad \oint_C f(s) ds = 2\pi i \cdot a_{-1}$$

$$a_{-1} = \frac{1}{2\pi i} \oint_C f(s) ds = \text{Res}(f(z), z_0)$$

$$= \begin{cases} \lim_{z \rightarrow z_0} (z - z_0) f(z) & \text{(simple)} \\ \frac{1}{(n-1)!} \lim_{z \rightarrow z_0} \frac{d^{n-1}}{dz^{n-1}} (z - z_0)^n f(z) & \text{(order } n) \end{cases}$$

Cauchy's Residue Theorem

$f(z)$: **analytic** on and within C
except a finite number of **singular points**
 z_1, z_2, \dots, z_n within C

then

$$\int_C f(z) dz = 2\pi i \sum_{k=1}^n \text{Res}(f(z), z_k)$$

D : a simply connected domain

C : a simple closed contour in D

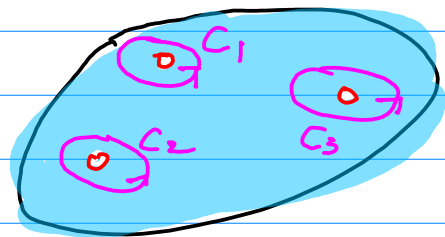
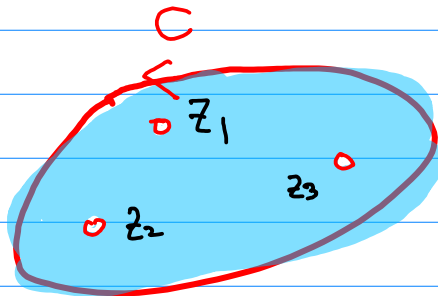

z_1

$$f(z) = \sum_{k=-\infty}^{+\infty} a_k (z - z_1)^k$$

$$a_{-1}^{z_1} = \frac{1}{2\pi i} \oint_{C_1} f(s) ds = \text{Res}(f(z), z_1)$$

z_2

$$f(z) = \sum_{k=-\infty}^{+\infty} a_k (z - z_2)^k$$

$$a_{-1}^{z_2} = \frac{1}{2\pi i} \oint_{C_2} f(s) ds = \text{Res}(f(z), z_2)$$

z_3

$$f(z) = \sum_{k=-\infty}^{+\infty} a_k (z - z_3)^k$$

$$a_{-1}^{z_3} = \frac{1}{2\pi i} \oint_{C_3} f(s) ds = \text{Res}(f(z), z_3)$$

z_1

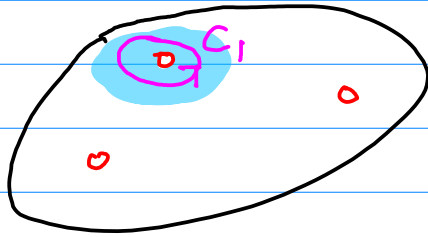

Laurent series expansion at z_1

$$f(z) = \sum_{k=-\infty}^{+\infty} a_k (z - z_1)^k$$

$$a_{-1} = \frac{1}{2\pi i} \oint_{C_1} f(s) ds = \text{Res}(f(z), z_1)$$

z_2

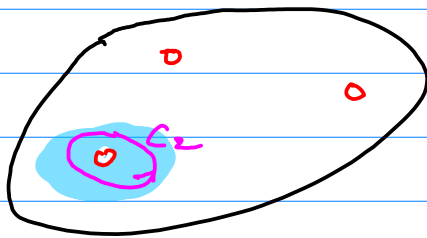

Laurent series expansion at z_2

$$f(z) = \sum_{k=-\infty}^{+\infty} a_k (z - z_2)^k$$

$$a_{-1} = \frac{1}{2\pi i} \oint_{C_2} f(s) ds = \text{Res}(f(z), z_2)$$

z_3

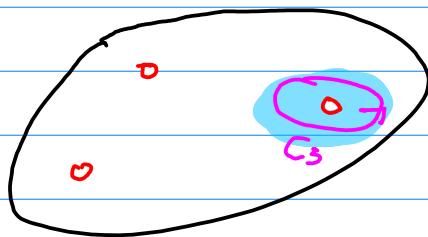

Laurent series expansion at z_3

$$f(z) = \sum_{k=-\infty}^{+\infty} a_k (z - z_3)^k$$

$$a_{-1} = \frac{1}{2\pi i} \oint_{C_3} f(s) ds = \text{Res}(f(z), z_3)$$

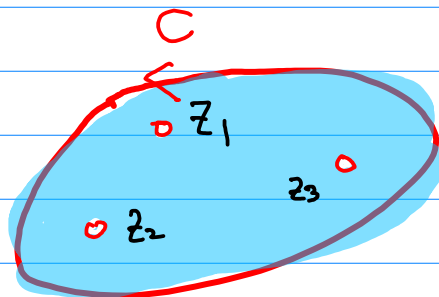

$$\int_C f(z) dz = 2\pi i \sum_{k=1}^n \text{Res}(f(z), z_k)$$

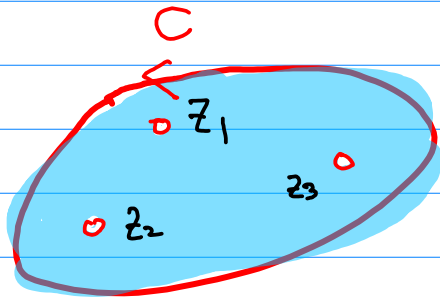

$$\int_C f(z) dz = 2\pi i \operatorname{Res}(f(z), z_1) + 2\pi i \operatorname{Res}(f(z), z_2) + 2\pi i \operatorname{Res}(f(z), z_3)$$

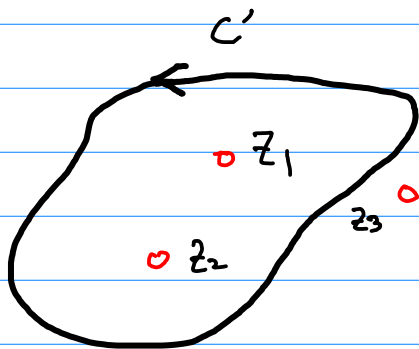

$$\int_{C'} f(z) dz = 2\pi i \operatorname{Res}(f(z), z_1) + 2\pi i \operatorname{Res}(f(z), z_2)$$

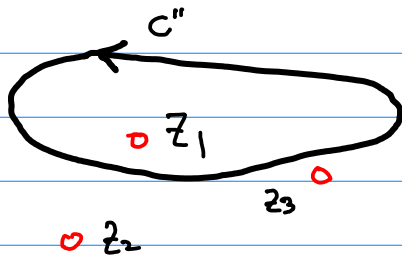

$$\int_{C''} f(z) dz = 2\pi i \operatorname{Res}(f(z), z_1)$$

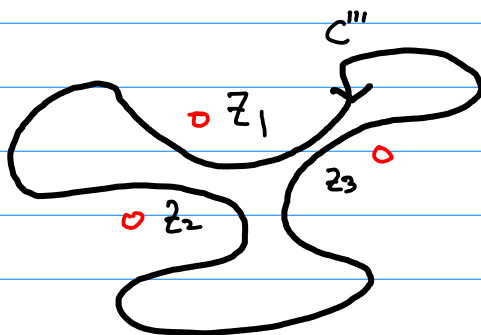

$$\int_{C'''} f(z) dz = 0$$

Different D , Different Laurent Series

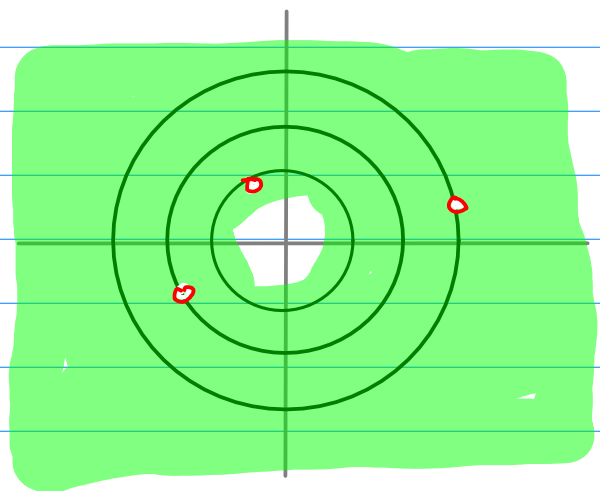
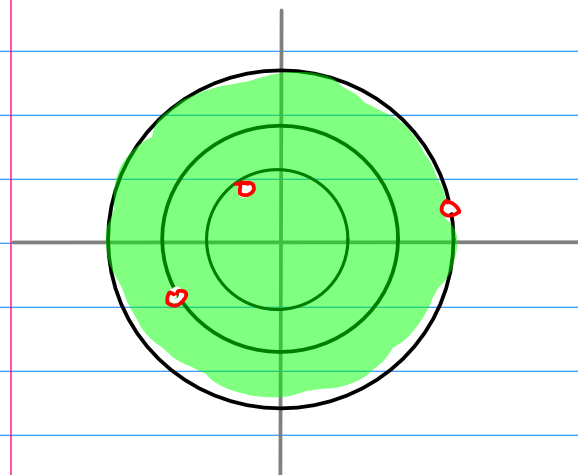
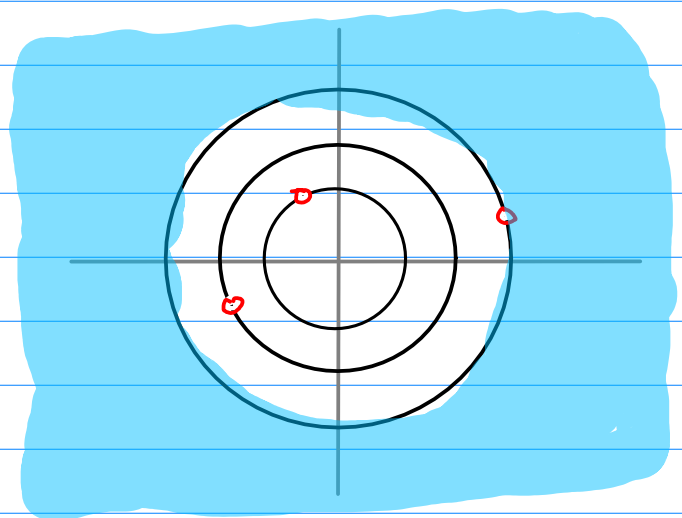
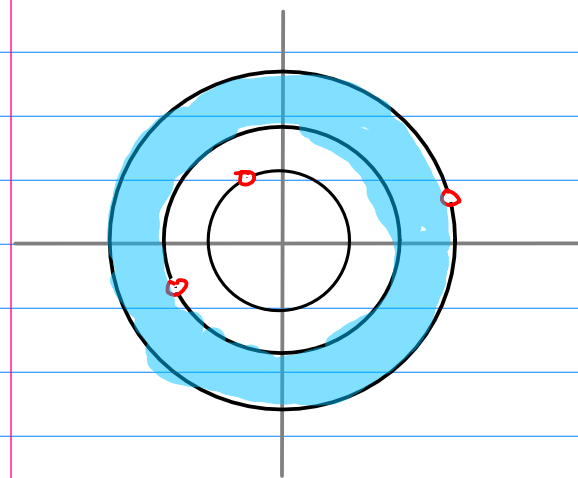
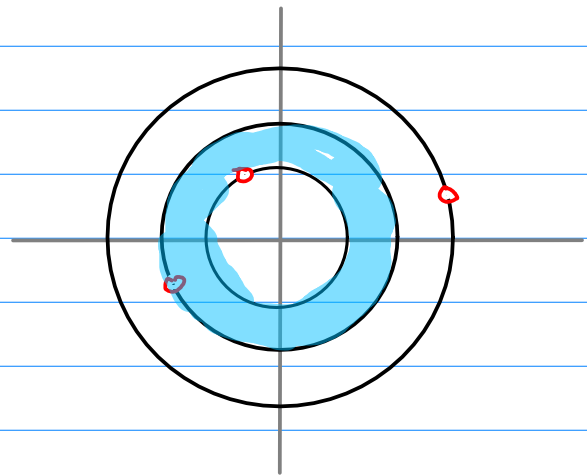
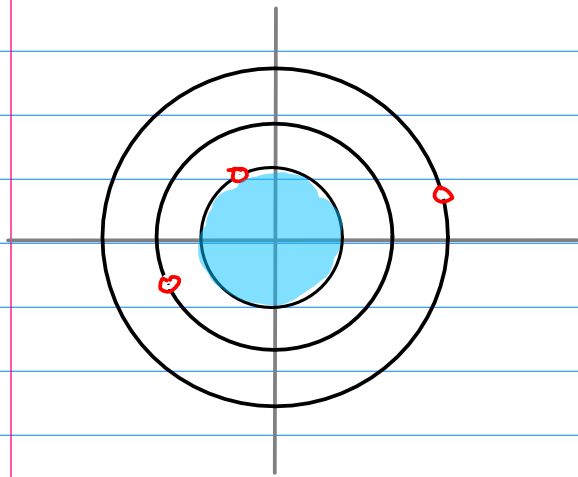

z -transform

$$f(z) = \sum_{n=n_1}^{\infty} a_n (z - z_m)^n$$

$$a_n = \frac{1}{2\pi i} \oint_C \frac{f(z')}{(z' - z_m)^{n+1}} dz'$$

$$= \sum_k \operatorname{Res} \left(\frac{f(z)}{(z - z_m)^{n+1}}, z_k \right)$$



C is in the same region of analyticity of $f(z)$
typically a circle centered on z_m

z_k within C : singularities of $\frac{f(z)}{(z - z_m)^{n+1}}$

$n_1 = n_{f,m}$ depends on $f(z)$, z_m

a_n depends on $f(z)$, z_m , region of analyticity

Whether $f(z)$ is singular at $z = z_m$ or not

or at other points between z and z_m

We can expand $f(z)$ about any point z_m

over powers of $(z - z_m)$.

$$f(z) = \sum_{n=-\infty}^{\infty} a_n^{(m)} (z - z_m)^n$$

$$a_n^{(m)} = \frac{1}{2\pi i} \oint_C \frac{f(z')}{(z' - z_m)^{n+1}} dz'$$

$$= \sum_k \operatorname{Res} \left(\frac{f(z)}{(z - z_m)^{n+1}}, z_k \right)$$

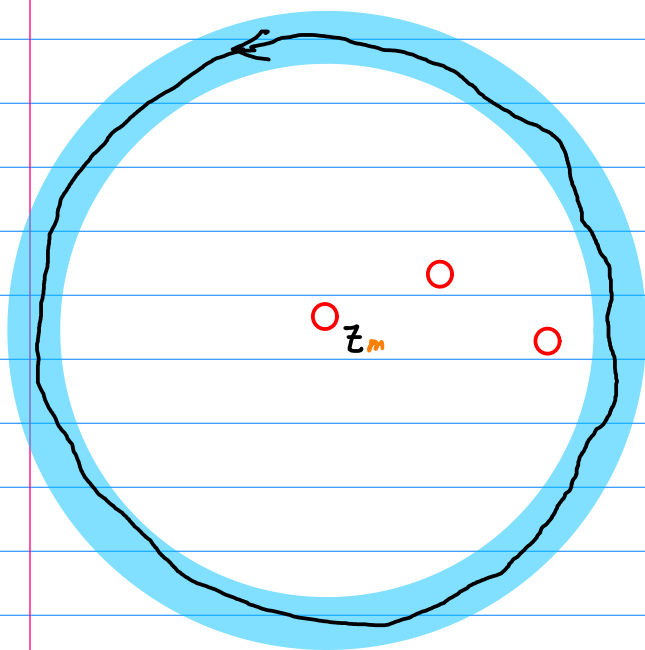
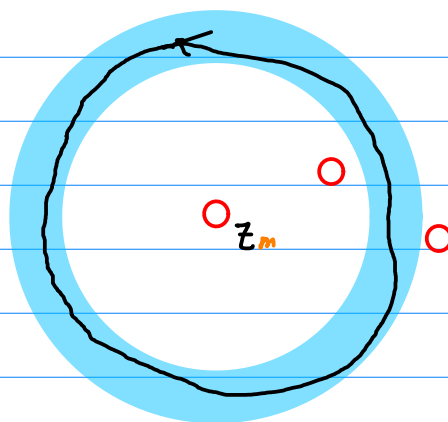
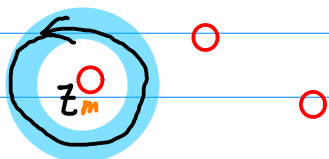

$$f(z) = \sum_{n=n_1}^{\infty} a_n^{\{m\}} (z - z_m)^n$$

$$a_n^{\{m\}} = \frac{1}{2\pi i} \oint_C \frac{f(z')}{(z' - z_m)^{n+1}} dz'$$

$$= \sum_k \operatorname{Res} \left(\frac{f(z)}{(z - z_m)^{n+1}}, z_k \right)$$

Analytic at z_m

$$n_1 \geq 0$$

$$\text{general } n_1, \quad z_m = 0$$

Taylor Series

MacLaurin Series

Singular at z_m

$$\text{general } n_1$$

$$\text{general } n_1, \quad z_m = 0$$

Laurent Series

z -Transform

$$f(z) = \sum_{n=-\infty}^{\infty} a_n^{(m)} (z - z_m)^n$$

$$a_n^{(m)} = \frac{1}{2\pi i} \oint_c \frac{f(z')}{(z' - z_m)^{n+1}} dz'$$

$$= \sum_k \operatorname{Res} \left(\frac{f(z)}{(z - z_m)^{n+1}}, z_k \right)$$

$$z_m = 0$$

$$a_{-n}^{(0)} = h(n)$$

$$n \rightarrow -n$$

$$H(z) = \sum_{n=-\infty}^{\infty} h(-n) z^n$$

$$h(n) = \frac{1}{2\pi i} \oint_c \frac{H(z')}{z'^{n+1}} dz'$$

$$= \sum_k \operatorname{Res} \left(\frac{H(z)}{z^{n+1}}, z_k \right)$$

$$H(z) = \sum_{n=-\infty}^{\infty} h(n) z^{-n}$$

$$h(n) = \frac{1}{2\pi i} \oint_c H(z') z'^{n-1} dz'$$

$$= \sum_k \operatorname{Res} (H(z) z^{n-1}, z_k)$$

C is in the same region of analyticity of $f(z)$
typically a circle centered on z_m

z_k within C : singularities of $\frac{f(z)}{(z-z_k)^{n+1}}$

C is in the same region of analyticity of $H(z)$
typically a circle centered on z_m

generally a circle centered on the origin
may enclose any or all singularities of $H(z)$
often the unit circle

z_k within C : singularities of $H(z)z^{n-1}$

$$H(z) = \sum_{n=-\infty}^{\infty} h(n) z^{-n} \quad z \in \text{R.O.C.}$$

$$h(n) = \frac{1}{2\pi i} \oint_C H(z') z'^{n-1} dz' \quad C \text{ in R.O.C.}$$

$$= \sum_k \text{Res}(H(z) z^{n-1}, z_k)$$

- ① a power series representation of a function $f(z)$ of a complex variable z
- ② a transform $H(z)$ of a sequence of 1

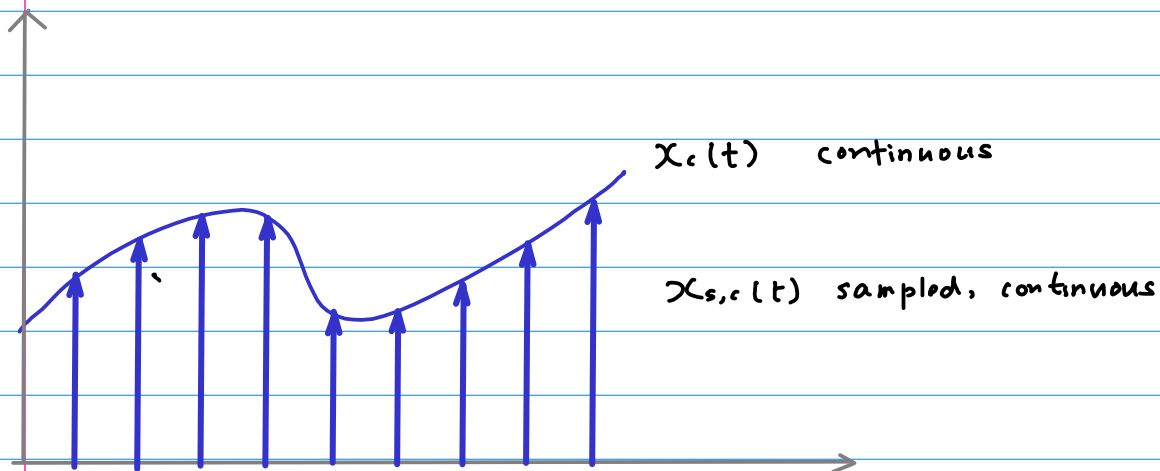

$$x_{s,c}(t) = \sum_{n=-\infty}^{+\infty} x(n) \delta_c(t - n\Delta t)$$

$$\begin{aligned} X_{s,c}(s) &= \mathcal{L}\{x_{s,c}(t)\} = \int_{-\infty}^{\infty} \left[\sum_{n=-\infty}^{+\infty} x(n) \delta_c(t - n\Delta t) \right] e^{-st} dt \\ &= \sum_{n=-\infty}^{+\infty} x(n) \int_{-\infty}^{\infty} \delta_c(t - n\Delta t) e^{-st} dt \\ &= \sum_{n=-\infty}^{+\infty} x(n) e^{-sn\Delta t} \quad e^{s\Delta t} \triangleq z \end{aligned}$$

$$X_{s,c}(s) = \sum_{n=-\infty}^{+\infty} x(n) z^{-n} \Big|_{z=e^{s\Delta t}}$$

$$X_{s,c}(s) = X(z) \Big|_{z=e^{s\Delta t}}$$

$$X_{s,c}(s) = \mathcal{L}\{x_{s,c}(t)\} = X(z) \Big|_{z=e^{s\Delta t}}$$

$x_{s,c}(t)$ an impulse train

whose coefficients are given by $x[n] = x_c(n\Delta t)$

z-transform : a special Laurent series

$$z_m = 0$$

$$a_{-n}^{\{0\}} = h(n)$$

$$n \rightarrow -n$$

$$f(z) = \sum_{n=-\infty}^{\infty} a_n^{\{m\}} (z - z_m)^n$$

$$a_n^{\{m\}} = \frac{1}{2\pi i} \oint_C \frac{f(z')}{(z' - z_m)^{n+1}} dz'$$

$$= \sum_k \operatorname{Res} \left(\frac{f(z)}{(z - z_m)^{n+1}}, z_k \right)$$

Time Reversal \leftarrow Laplace Transform

the transform functions

$$X(s) = \int \text{over negative powers } e^{-st} \quad \text{for } t > 0$$

$$X(z) = \int \text{over negative powers } z^{-n} \quad \text{for } n > 0$$

the time expansion functions

$$x(t) = \int \text{over negative powers } e^{-st} \quad \text{for } t > 0$$

$$x[n] = \int \text{over negative powers } z^{-n} \quad \text{for } n > 0$$

Time Reversal \leftarrow z^{-1} : unit delay, char eq (modes in z^k)

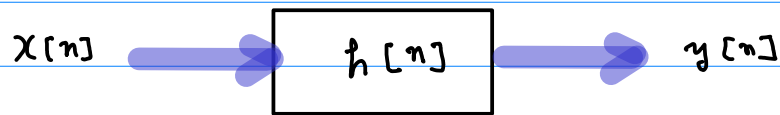

Stable system : $h[n]$ must be absolutely summable

$$|e^{j\omega n}| = 1$$

$$|z^n| \quad z = 1$$

$$\infty > M_h > \sum_{n=-\infty}^{\infty} |h[n]| \quad \text{absolutely summable}$$

$$= \sum_{n=-\infty}^{+\infty} |h[n] e^{-j\omega n}|$$

$$\geq \left| \sum_{n=-\infty}^{+\infty} h[n] e^{-j\omega n} \right|$$

$$= \left| H(z) \Big|_{z=e^{j\omega}} \right|$$

$$\infty > \left| H(z) \Big|_{z=e^{j\omega}} \right|$$

a stable system,

$H(z)$ must converge on the unit circle $|z|=1$

ROC (Region of Convergence) must include the unit circle

regardless of causality of $h[n]$

$$H(z) \Big|_{|z|=1} = H(e^{j\hat{\omega}}) \quad \text{DTFT of } h[n]$$

discrete all stable sequence must have convergent DTFTs

continuous all stable signal must have convergent CTFTs

$$C \leftarrow \text{unit circle} \quad z = e^{j\hat{\omega}}$$

ZT^{-1} $DTFT^{-1}$ identical formulas

$h[n]$ causal

$$H(z) = \sum_{n=-\infty}^{+\infty} h[n] z^{-n} = \sum_{n=0}^{+\infty} h[n] z^{-n} \quad n \in [0, \infty)$$

for finite values of n ,

each term must be finite as long as $z \neq 0$

For the sum to converge,

$h[n] z^{-n}$ must vanish as $n \rightarrow \infty$

$$|z| > r_h \quad z_h = r_h e^{j\theta}$$

z_h^n is the largest magnitude

geometrically increasing component

$n^m z^n$: the most general term

for impulse responses

$n \rightarrow \infty$ z^n dominant over n^m for finite m