

# BJT Characteristics (H.1)

20170109

Copyright (c) 2016 - 2017 Young W. Lim.

Permission is granted to copy, distribute and/or modify this document under the terms of the GNU Free Documentation License, Version 1.2 or any later version published by the Free Software Foundation; with no Invariant Sections, no Front-Cover Texts, and no Back-Cover Texts. A copy of the license is included in the section entitled "GNU Free Documentation License".

# References

Based

[1] Floyd, Electronic Devices 7th ed

[2] Cook,

[2] [en.wikipedia.org](http://en.wikipedia.org)



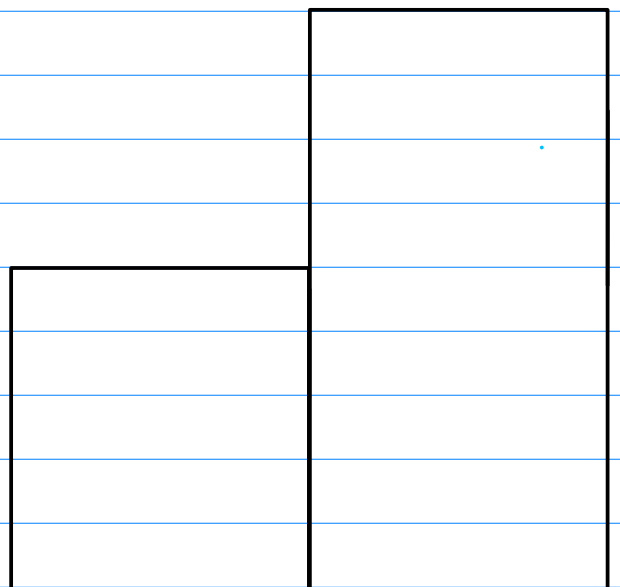
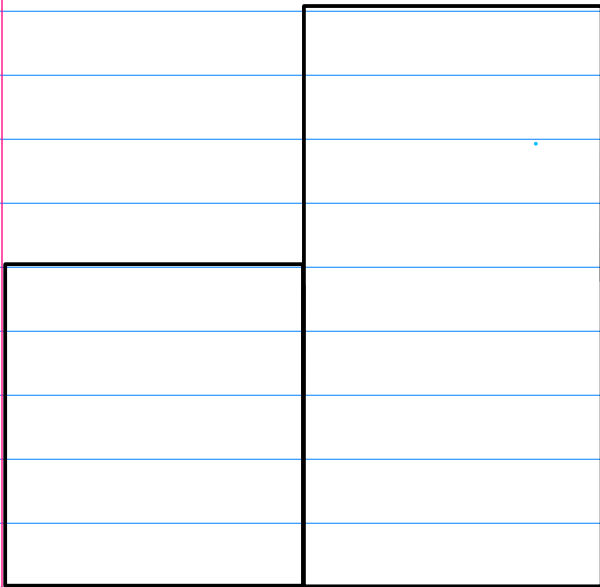
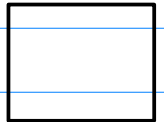
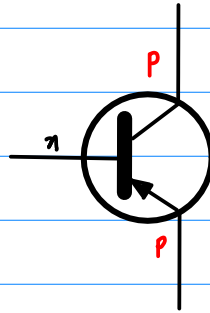
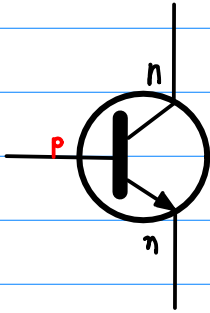

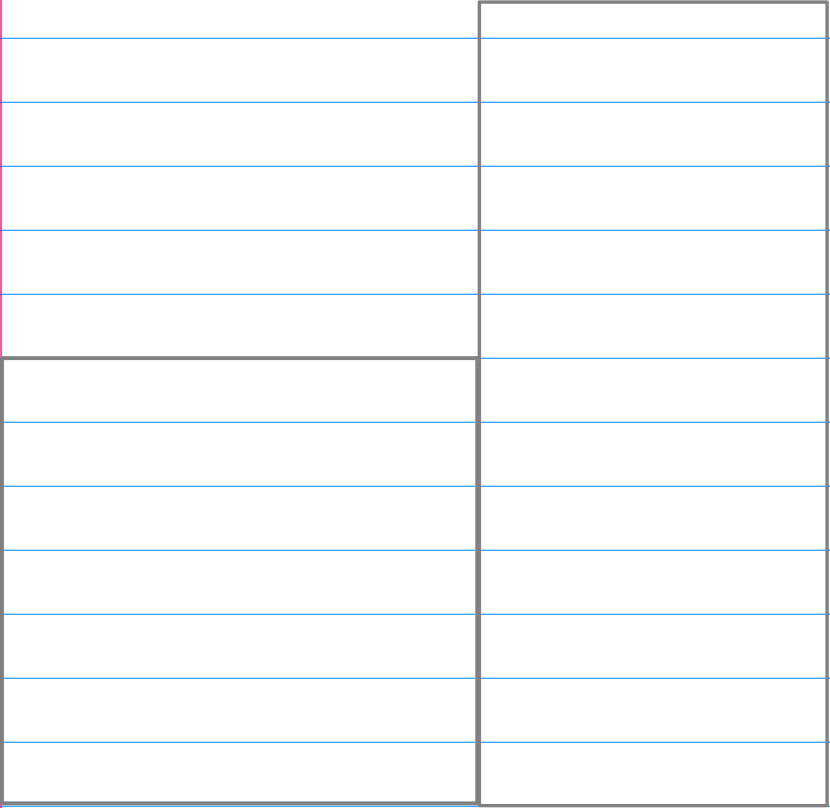

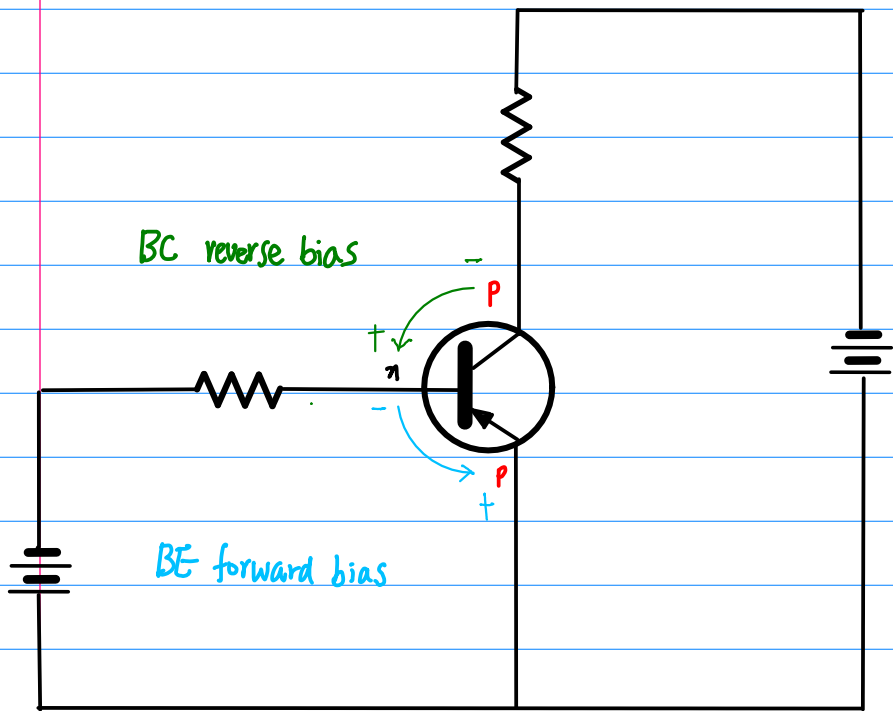
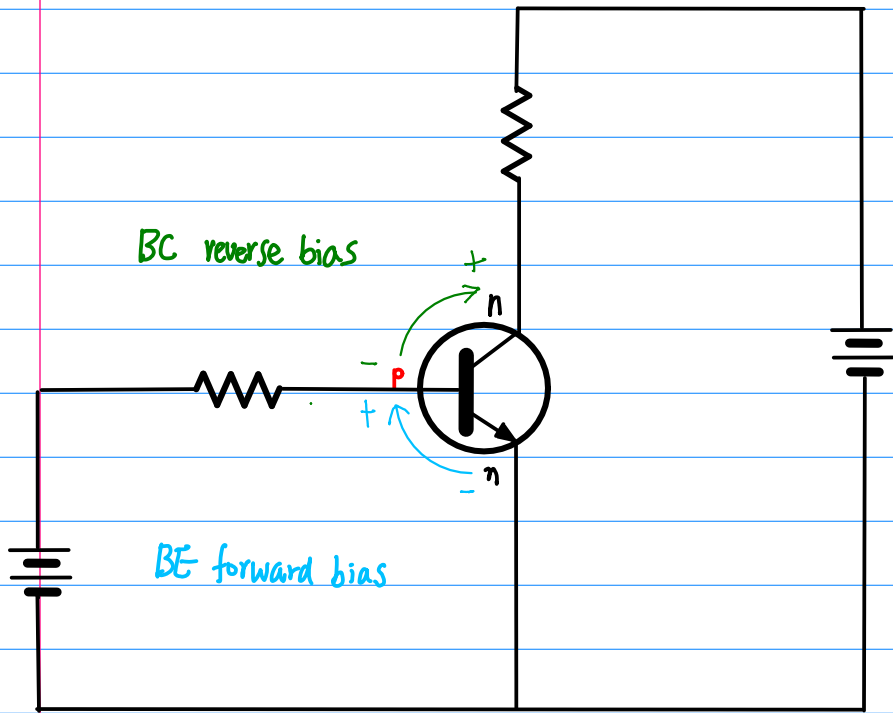

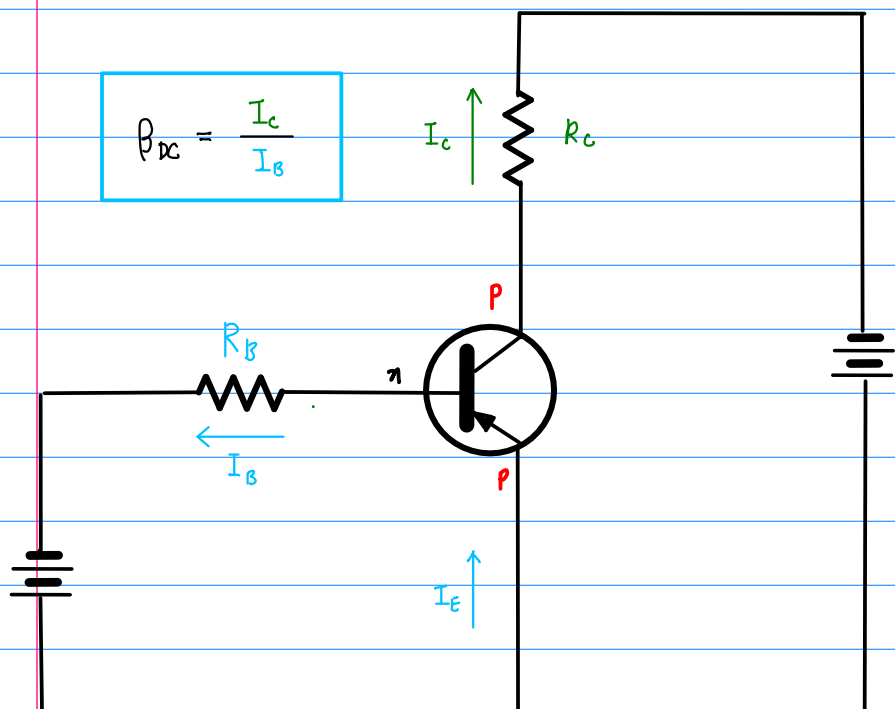
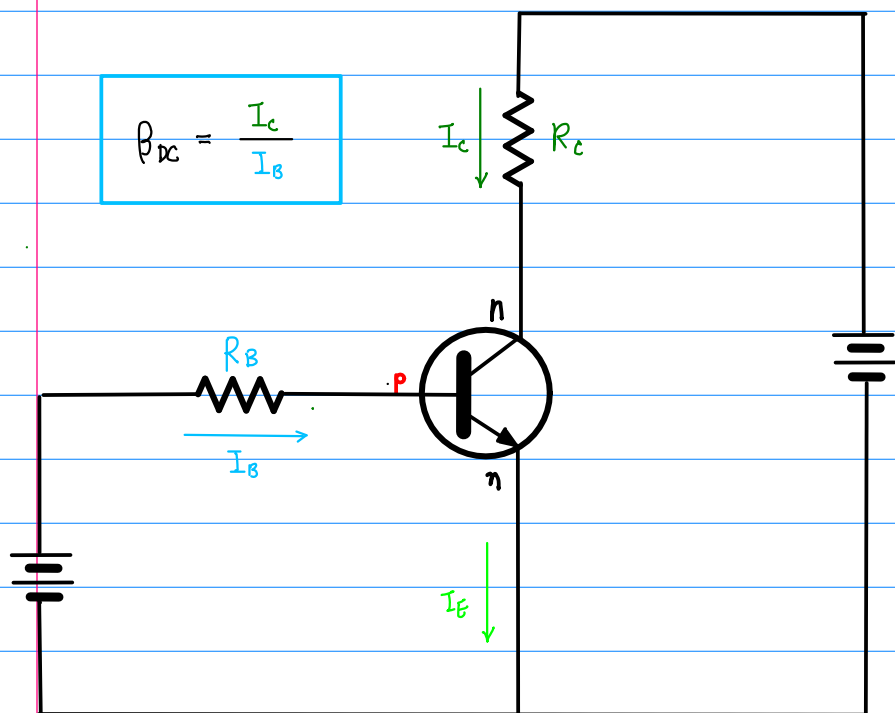

$$\beta_{DC} = \frac{I_c}{I_B}$$

20 ~ 200

$$h_{FE} = \beta_{DC}$$

$$\alpha_{DC} = \frac{I_c}{I_E}$$

0.95 ~ 0.99



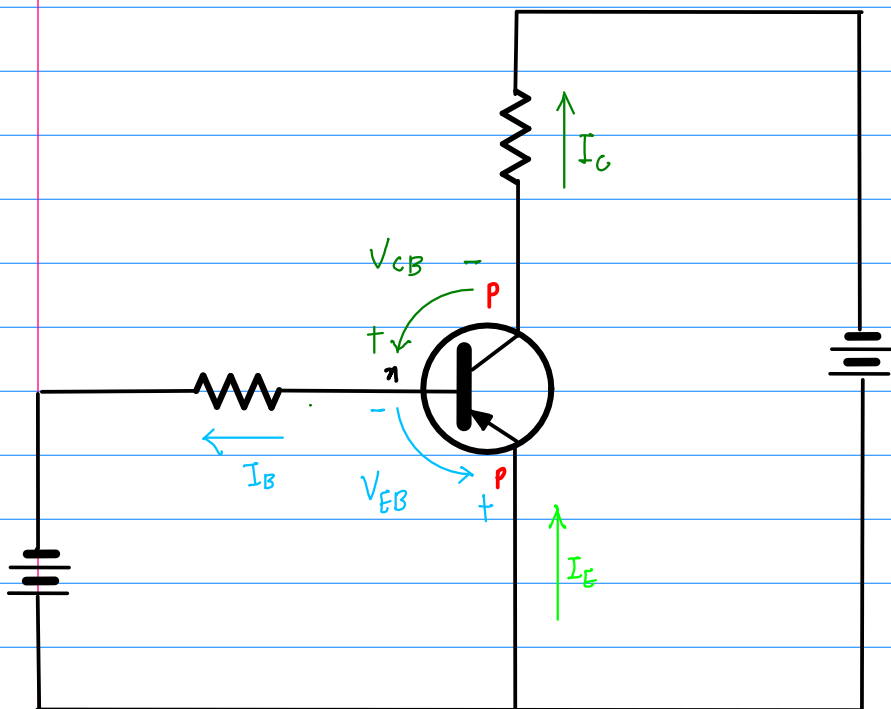
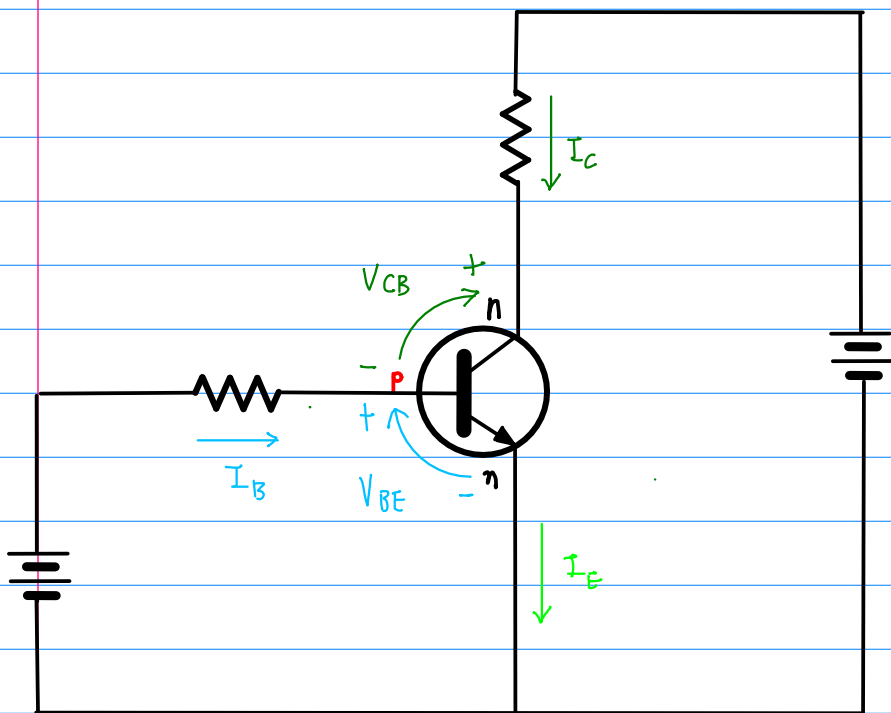

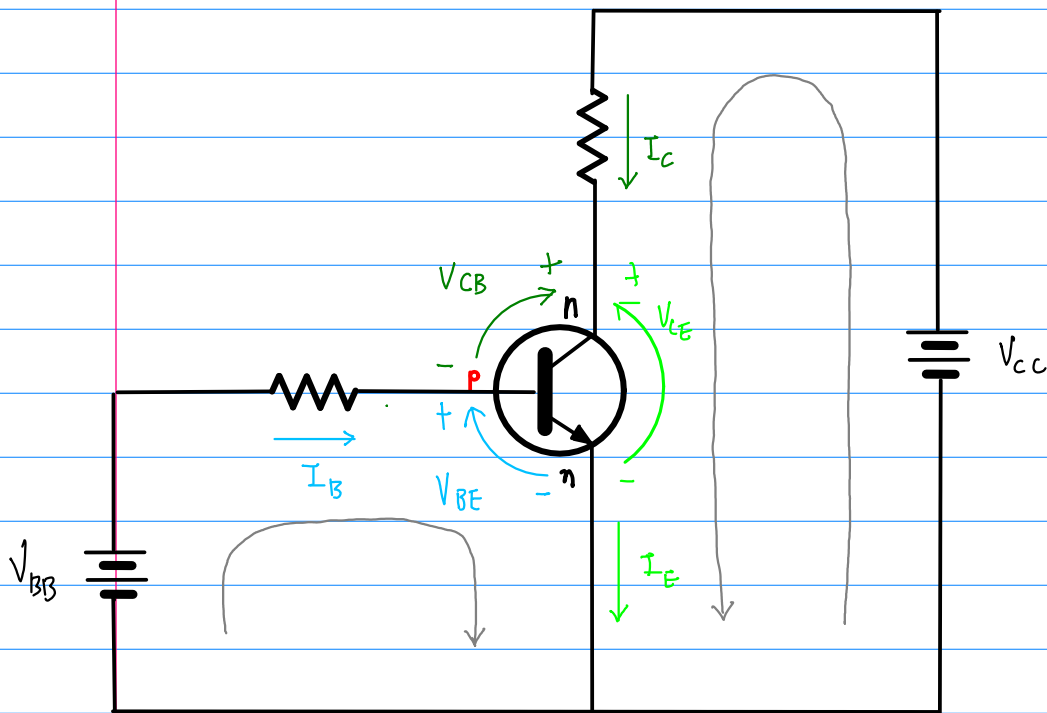

$$V_{BB} = I_B R_B + V_{BE}$$

$$V_{CC} = I_C R_C + V_{CE}$$

$$I_B = \frac{V_{BB} - V_{BE}}{R_B}$$

$$I_C = \frac{V_{CC} - V_{CE}}{R_C}$$

$$V_{CE} = V_{CC} - I_C R_C$$

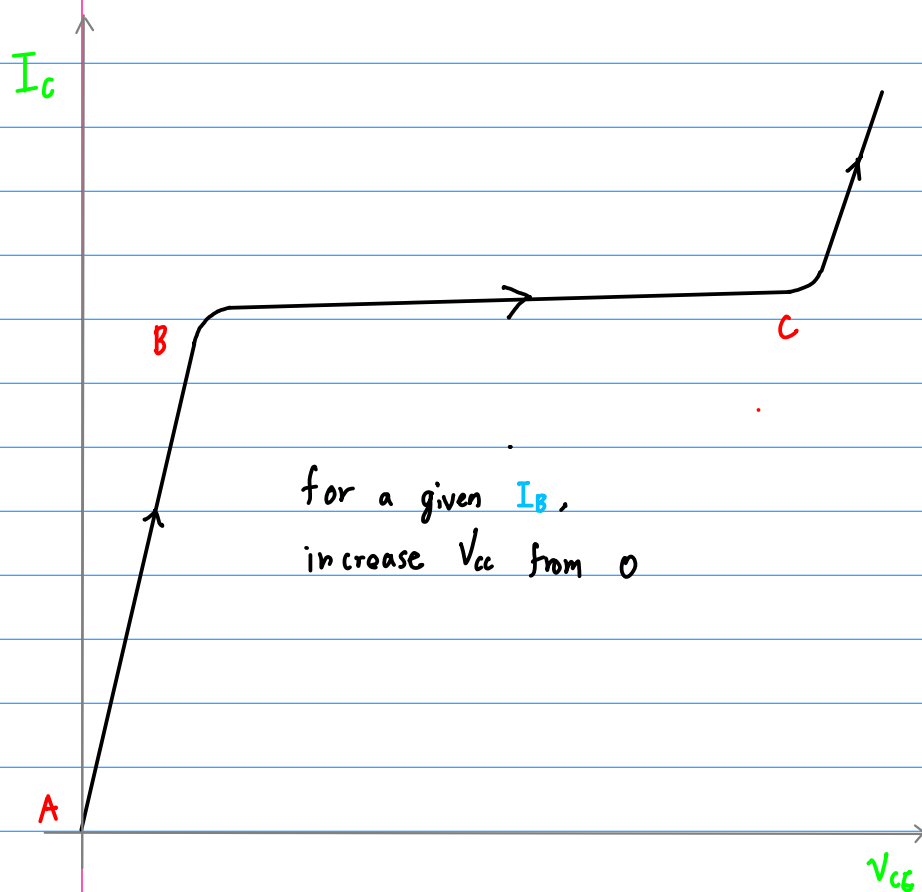
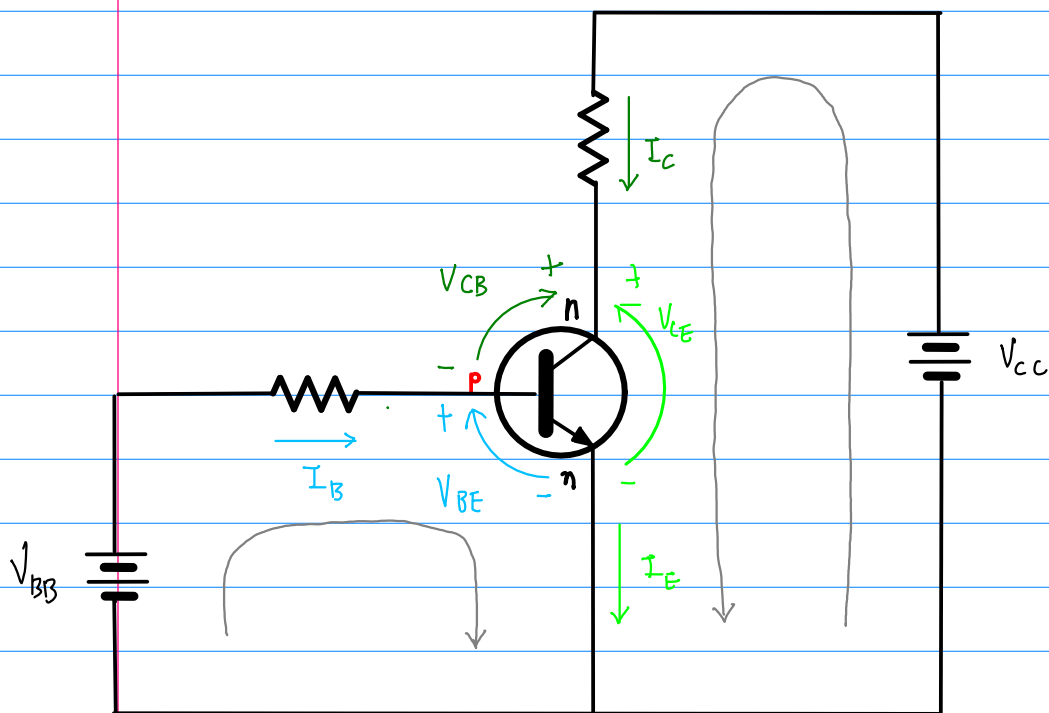

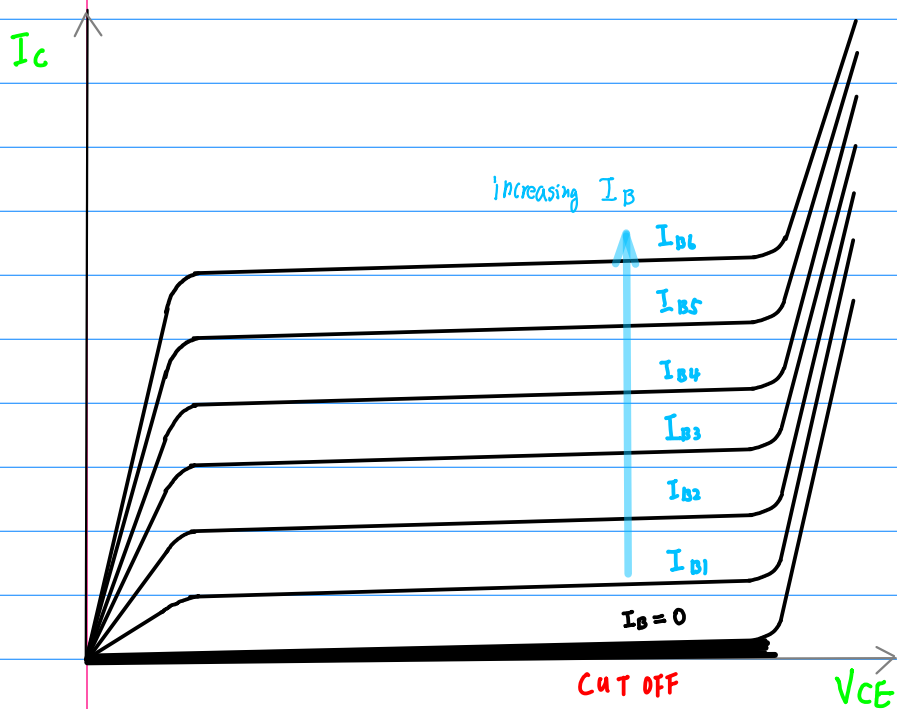
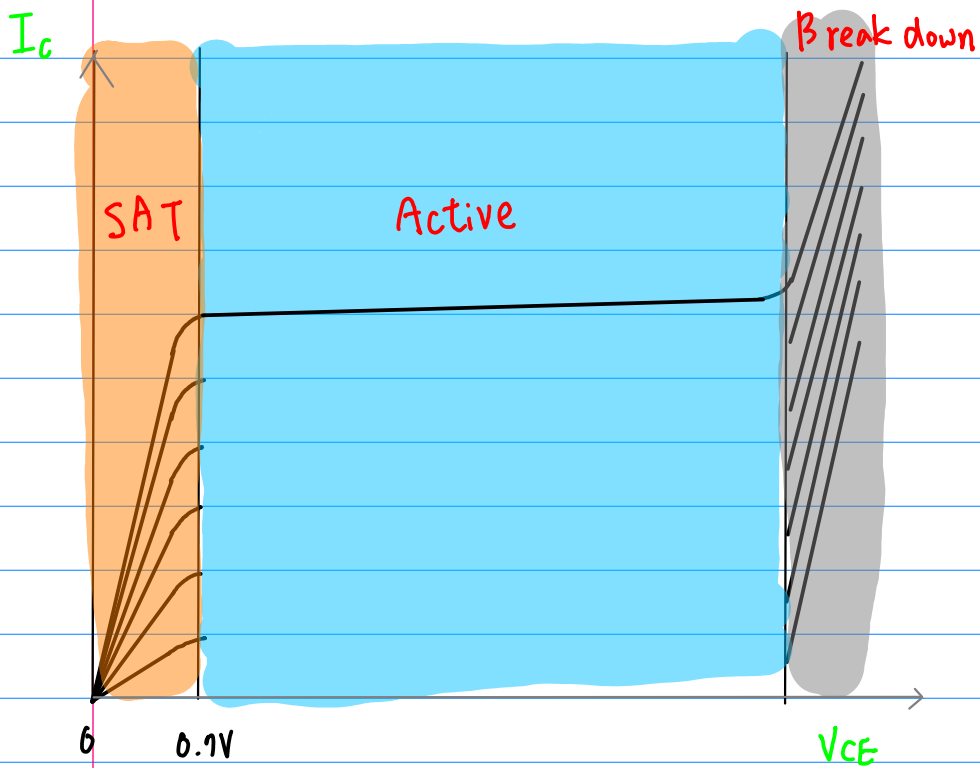

(A)

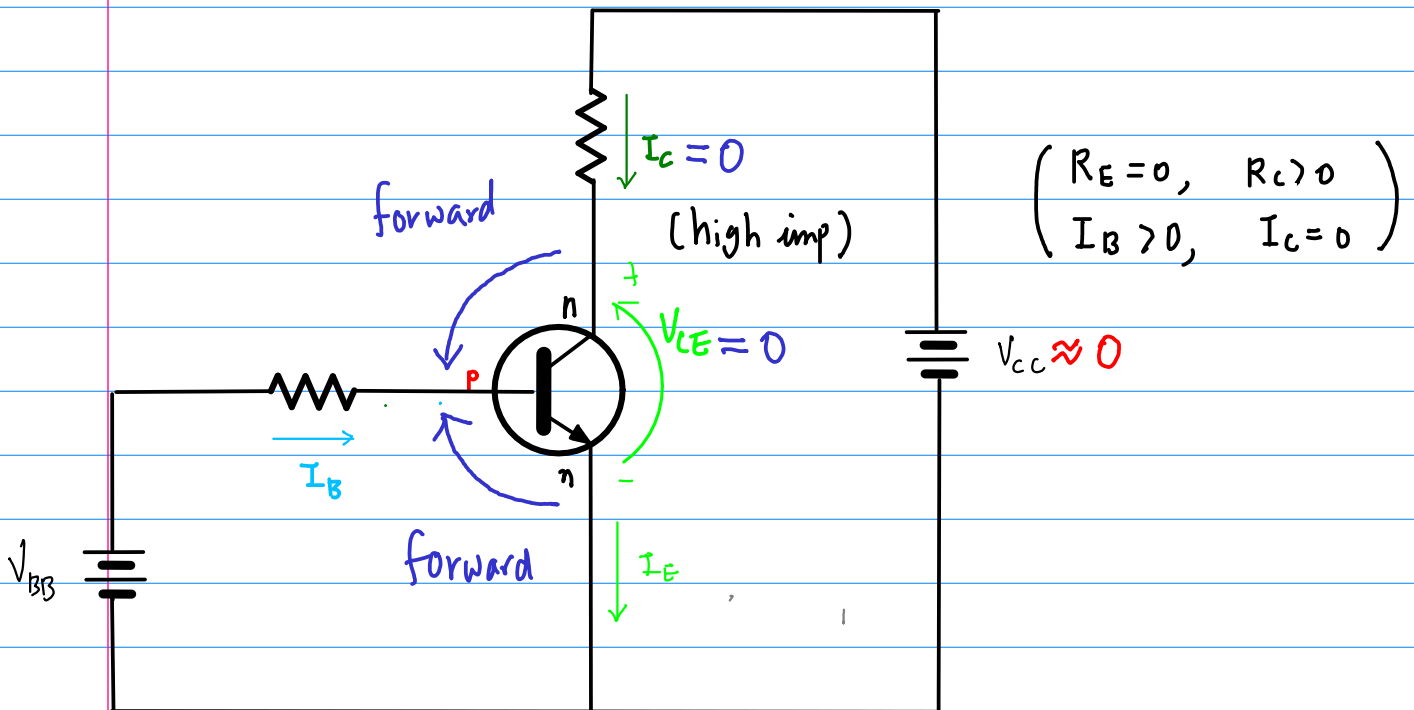
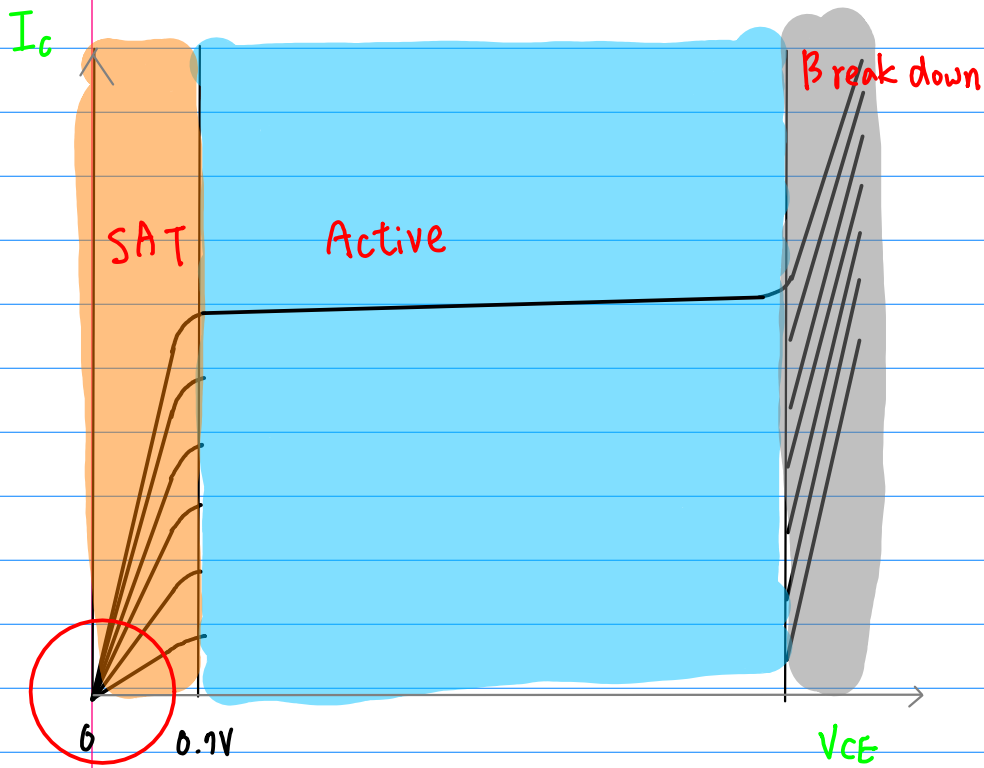

(A)

$V_{CC} \approx 0$

2 paths

B → E

B → C

$R_C \rightarrow I_C = 0$

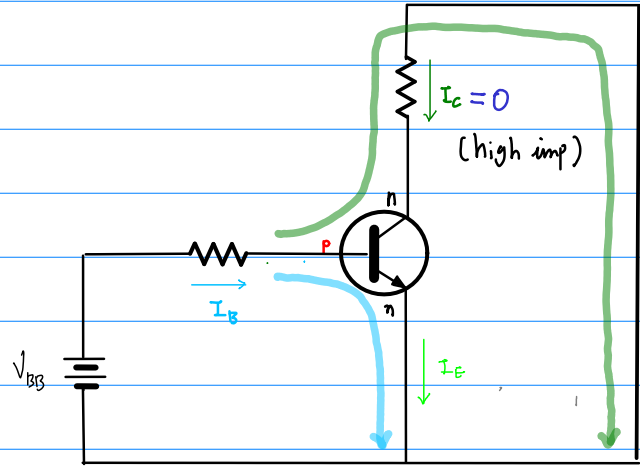

(A)-(B)

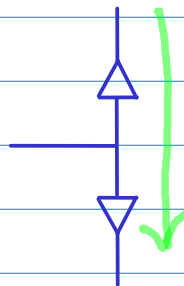
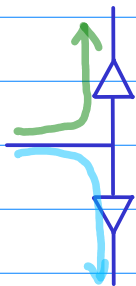
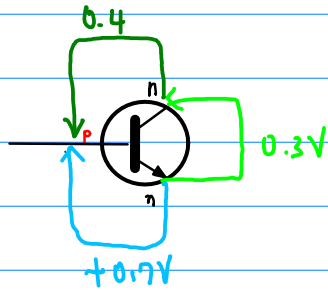
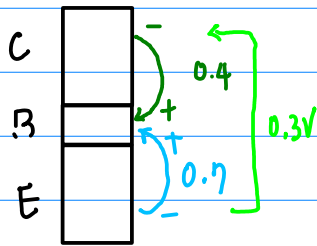
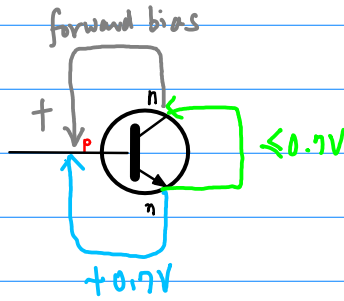
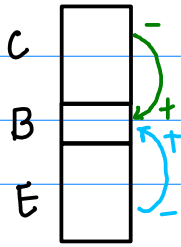

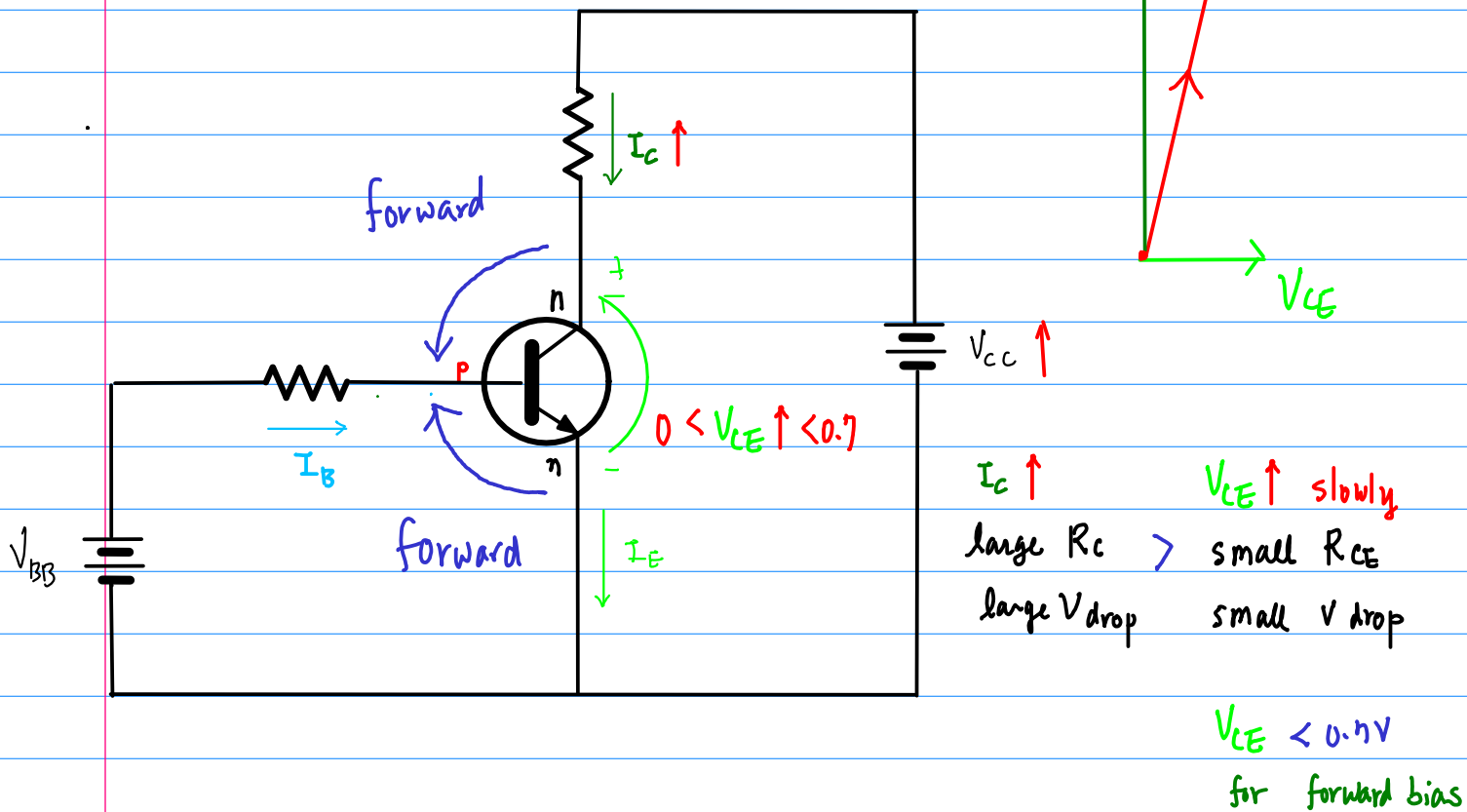
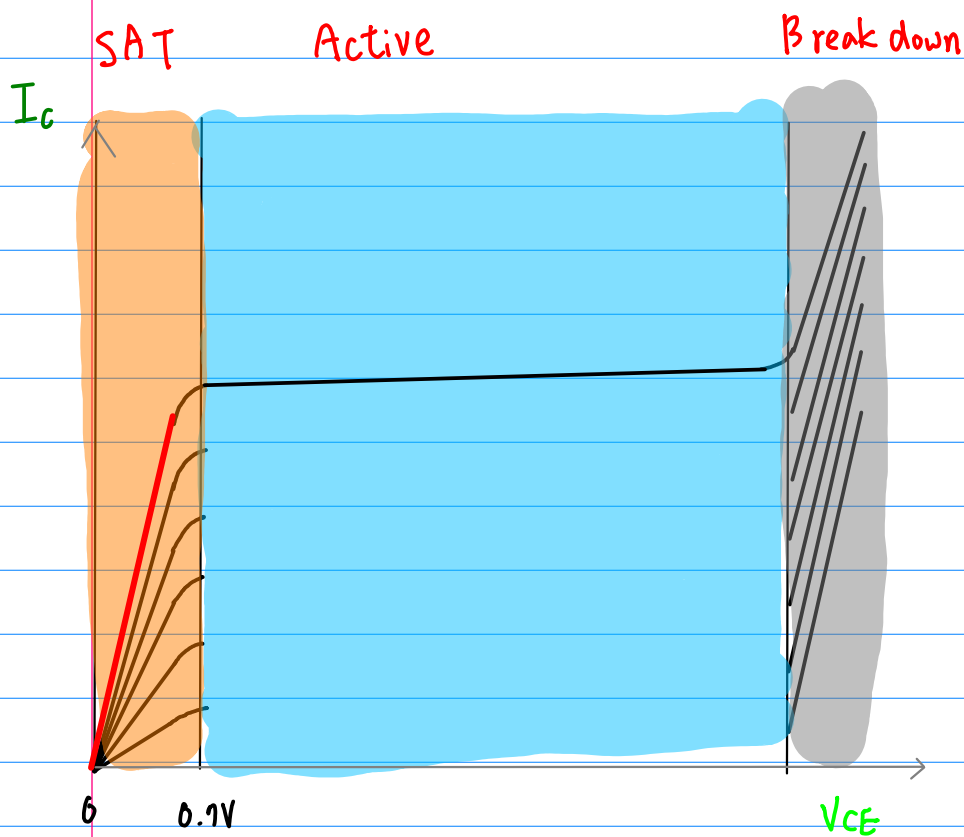

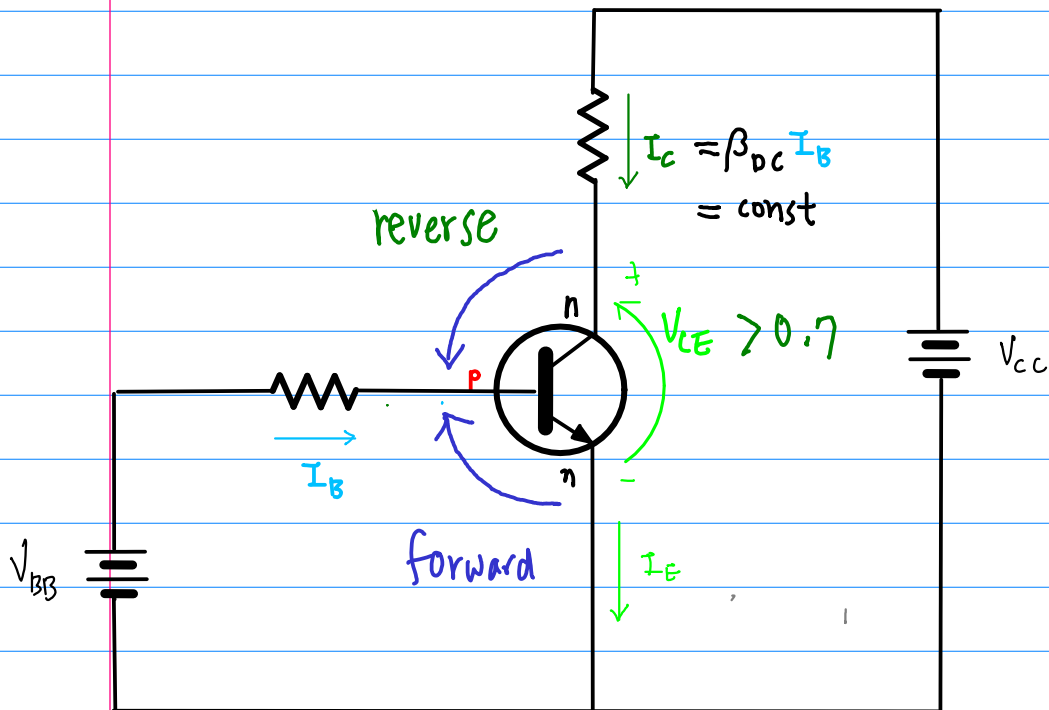
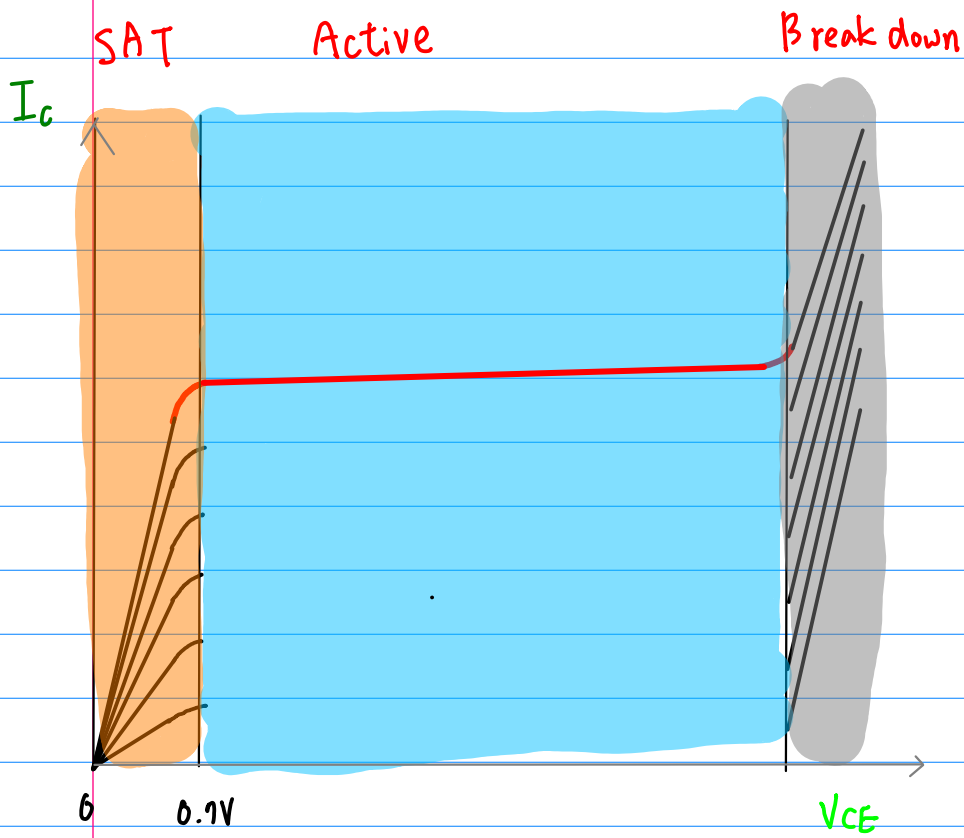

$$V_{CE} + V_{Rc} = V_{CC}$$



