

Laurent Series and z-Transform

- Geometric Series

Combinations B

20200630 Tue

Copyright (c) 2016 - 2020 Young W. Lim.

Permission is granted to copy, distribute and/or modify this document under the terms of the GNU Free Documentation License, Version 1.2 or any later version published by the Free Software Foundation; with no Invariant Sections, no Front-Cover Texts, and no Back-Cover Texts. A copy of the license is included in the section entitled "GNU Free Documentation License".

Making Shifted Sequences

Shifting Property (1) - Exponential Functions

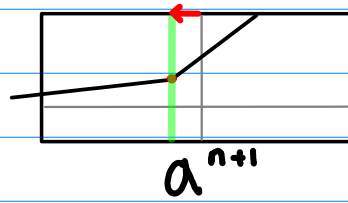
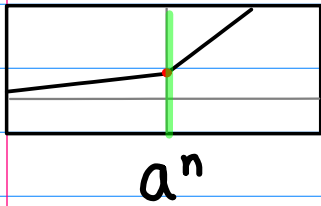

left shift

SHL.Exp

$n \rightarrow n+1$

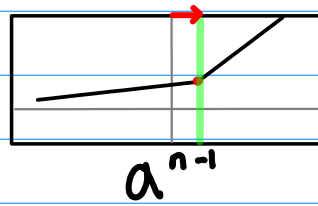
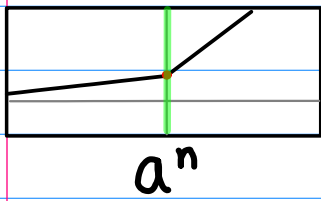

right shift

SHR.Exp

$n \rightarrow n-1$

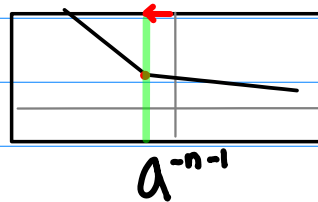
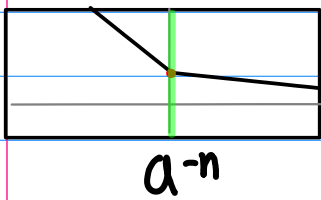

left shift

SHL.Exp

$n \rightarrow n+1$

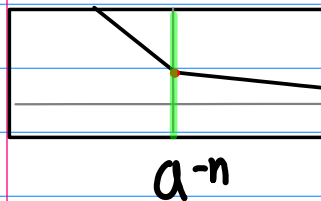

right shift

SHR.Exp

$n \rightarrow n-1$

$\boxed{*a}$

Left Shifted

SHL.Exp ... a^n

$a^n \longrightarrow a^{n+1}$

Right Shifted

SHR.Exp ... a^{-n}

$a^{-n} \longrightarrow a^{-n+1}$

$\boxed{/a}$

Right Shifted

SHR.Exp ... a^n

$a^n \longrightarrow a^{n-1}$

Left Shifted

SHL.Exp ... a^{-n}

$a^{-n} \longrightarrow a^{-n-1}$

Shifting Property (2) - Ranges

SHL.Rng

$n \rightarrow n+1$

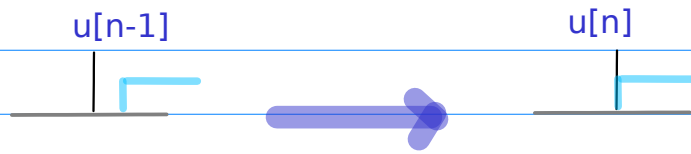

SHR.Rng

$n \rightarrow n-1$



SHL.Rng

$n \rightarrow n+1$



SHR.Rng

$n \rightarrow n-1$

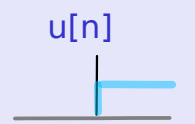
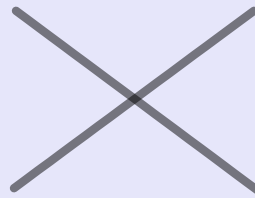
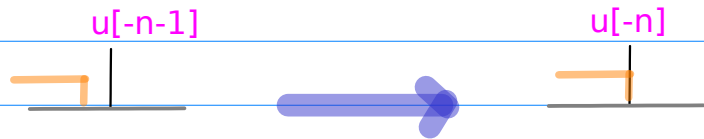

SHL.Rng
 $n \rightarrow n+1$

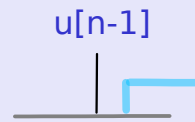
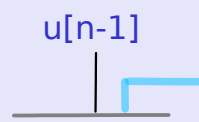

SHR.Rng
 $n \rightarrow n-1$

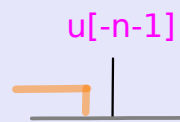
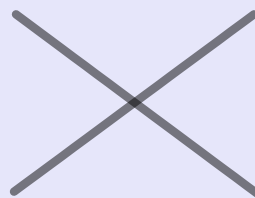
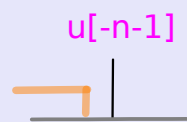

SHL.Rng
 $n \rightarrow n+1$

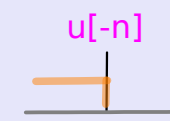
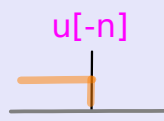

SHR.Rng
 $n \rightarrow n-1$

Shifting Property (3) - Layout Orders

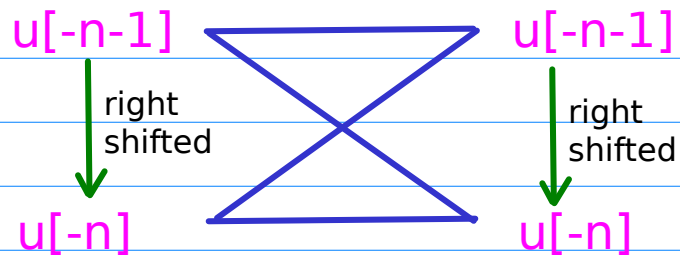
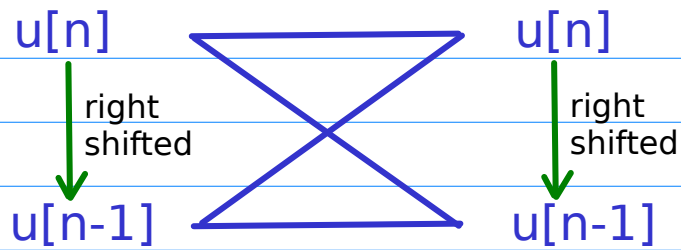
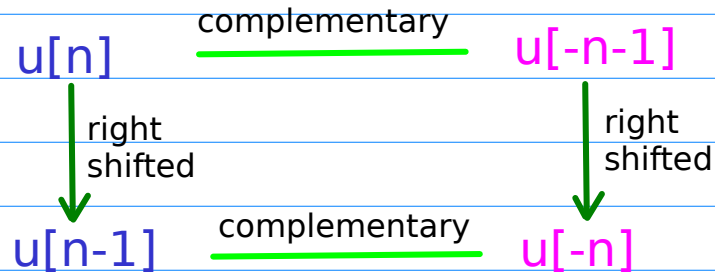

Shifting Property (4) - Complementary Ranges

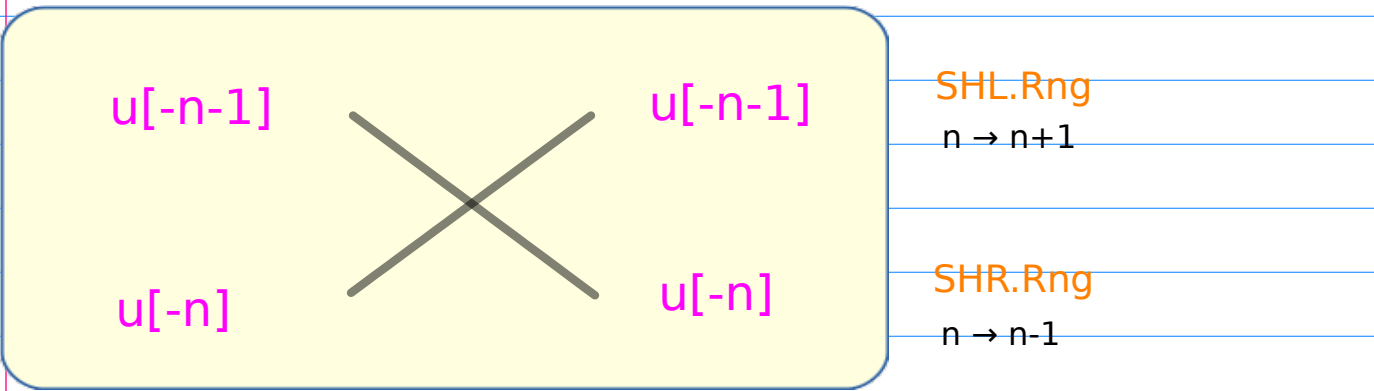
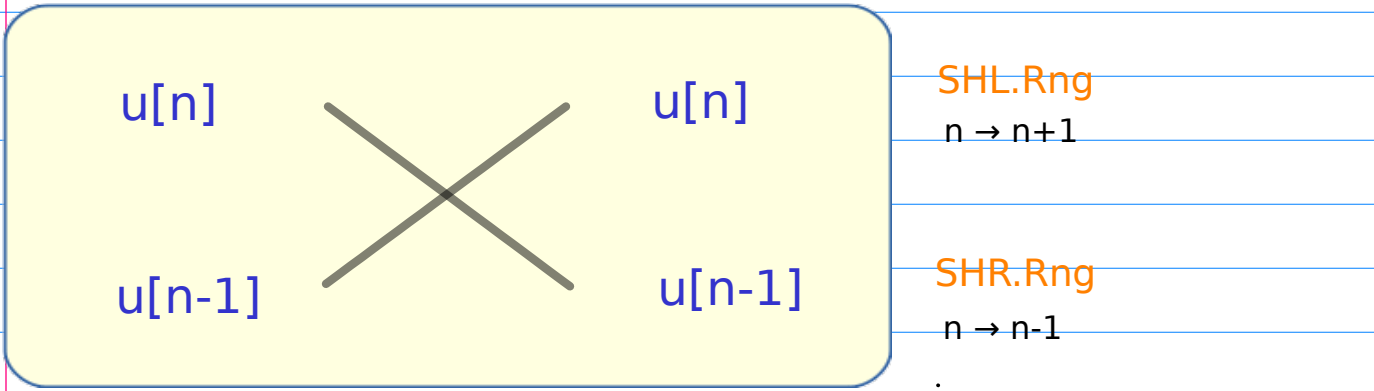
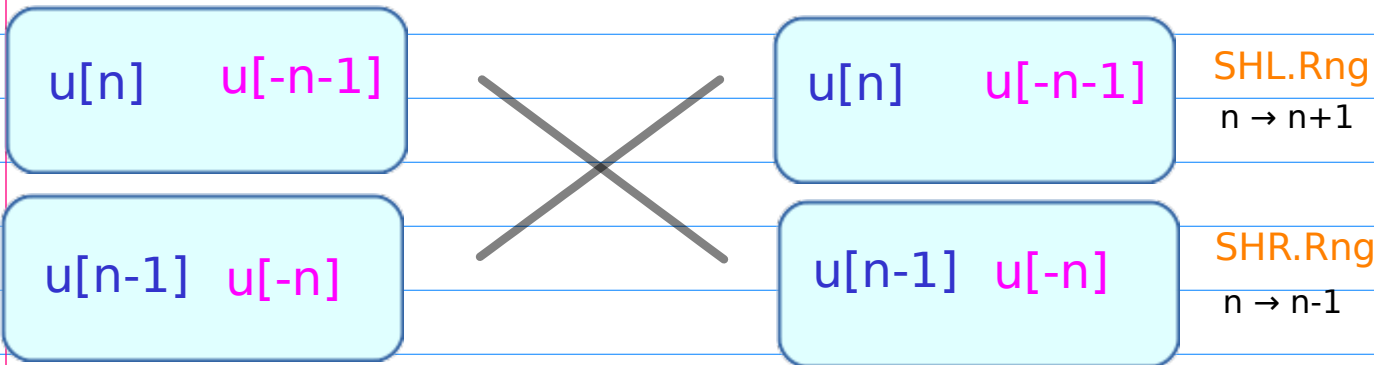
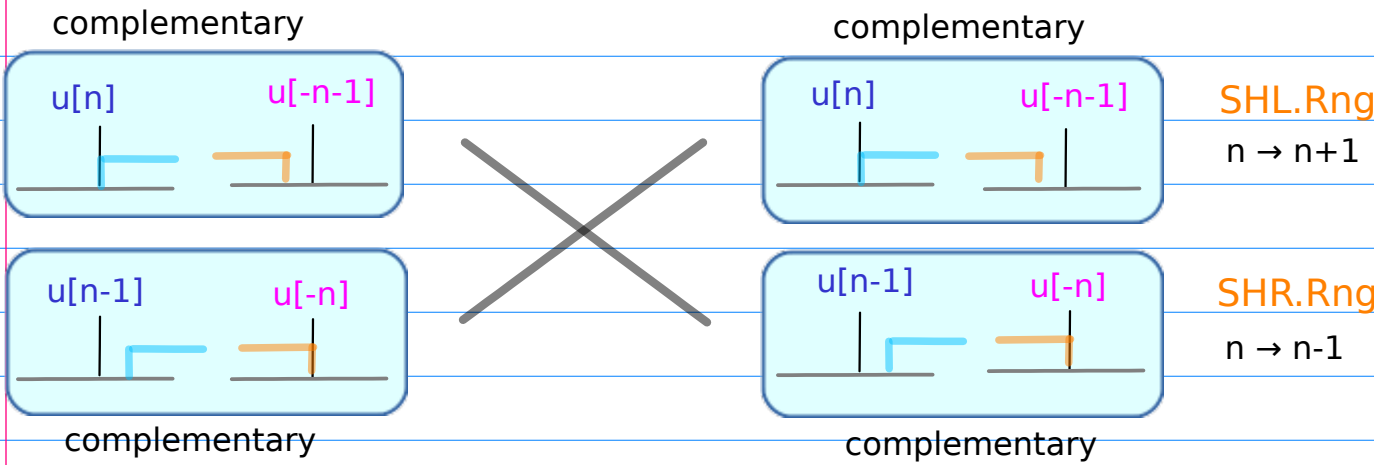

Shifting Property (5) - Multiplication Factors

⊗ *z	Right Shifted Range <i>and</i>	$u[n] \rightarrow u[n-1]$ $u[-n-1] \rightarrow u[-n]$	SHR.Rng
	Right Shifted Exponent	$a^n \rightarrow a^{n-1}$ $a^{-n} \rightarrow a^{-n+1}$	SHR.Exp

/z	Left Shifted Range <i>and</i>	$u[n-1] \rightarrow u[n]$ $u[-n] \rightarrow u[-n-1]$	SHL.Rng
	Left Shifted Exponent	$a^n \rightarrow a^{n+1}$ $a^{-n} \rightarrow a^{-n-1}$	SHL.Exp

*a	Left Shifted Exponent <i>or</i>	$a^n \longrightarrow a^{n+1}$	SHL.Exp
	Right Shifted Exponent	$a^{-n} \longrightarrow a^{-n+1}$	SHR.Exp

/a	Right Shifted Exponent <i>or</i>	$a^n \longrightarrow a^{n-1}$	SHR.Exp
	Left Shifted Exponent	$a^{-n} \longrightarrow a^{-n-1}$	SHL.Exp

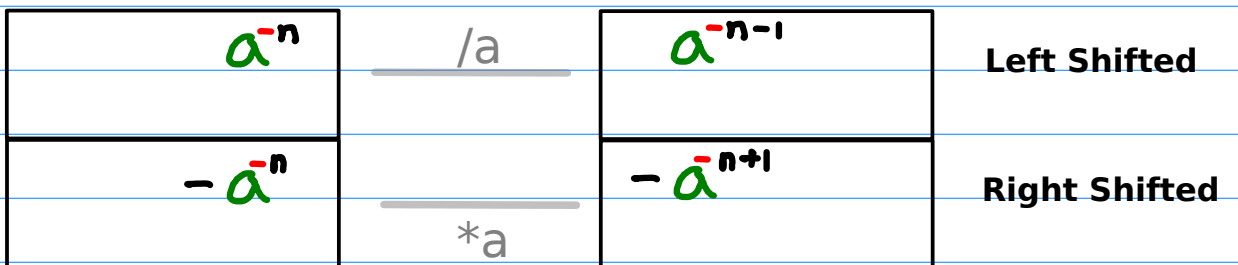
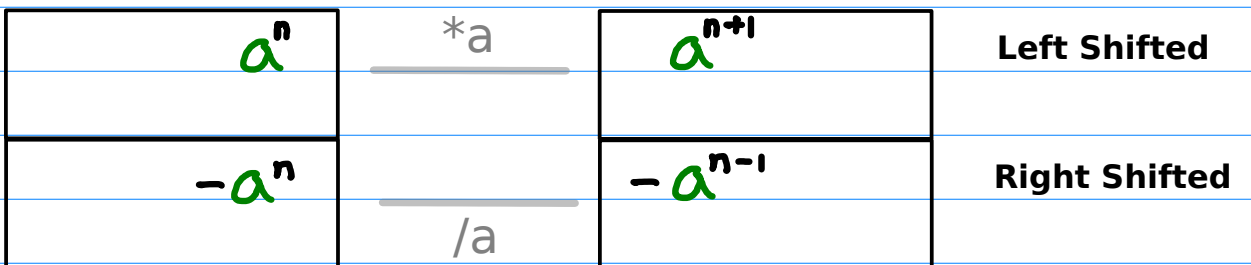
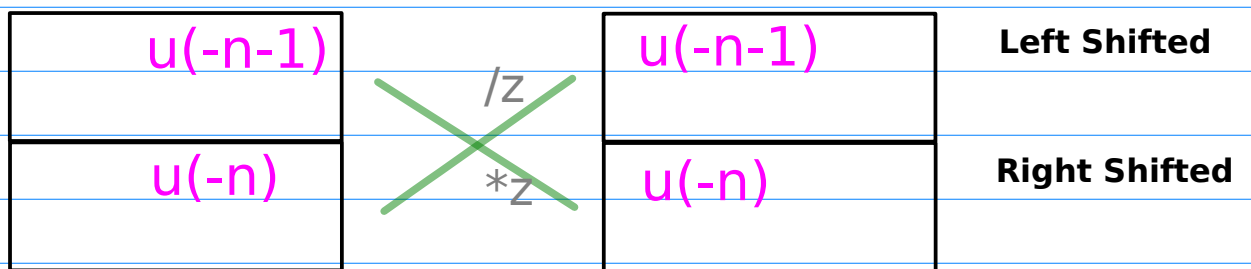
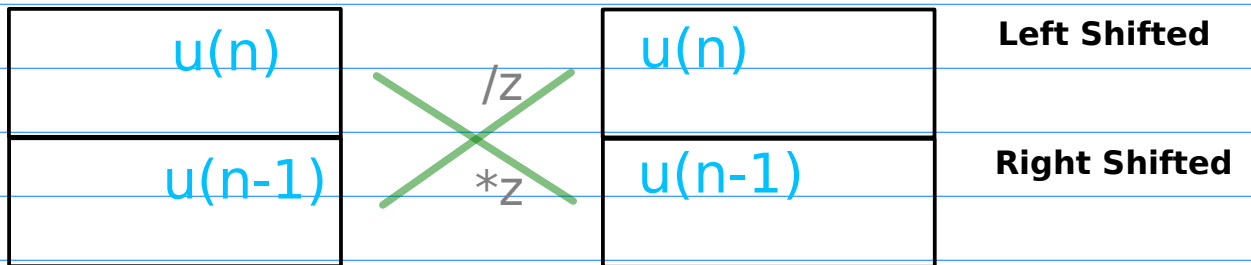

Determining {Left, Right} Shift of a pair of Causal Sequences

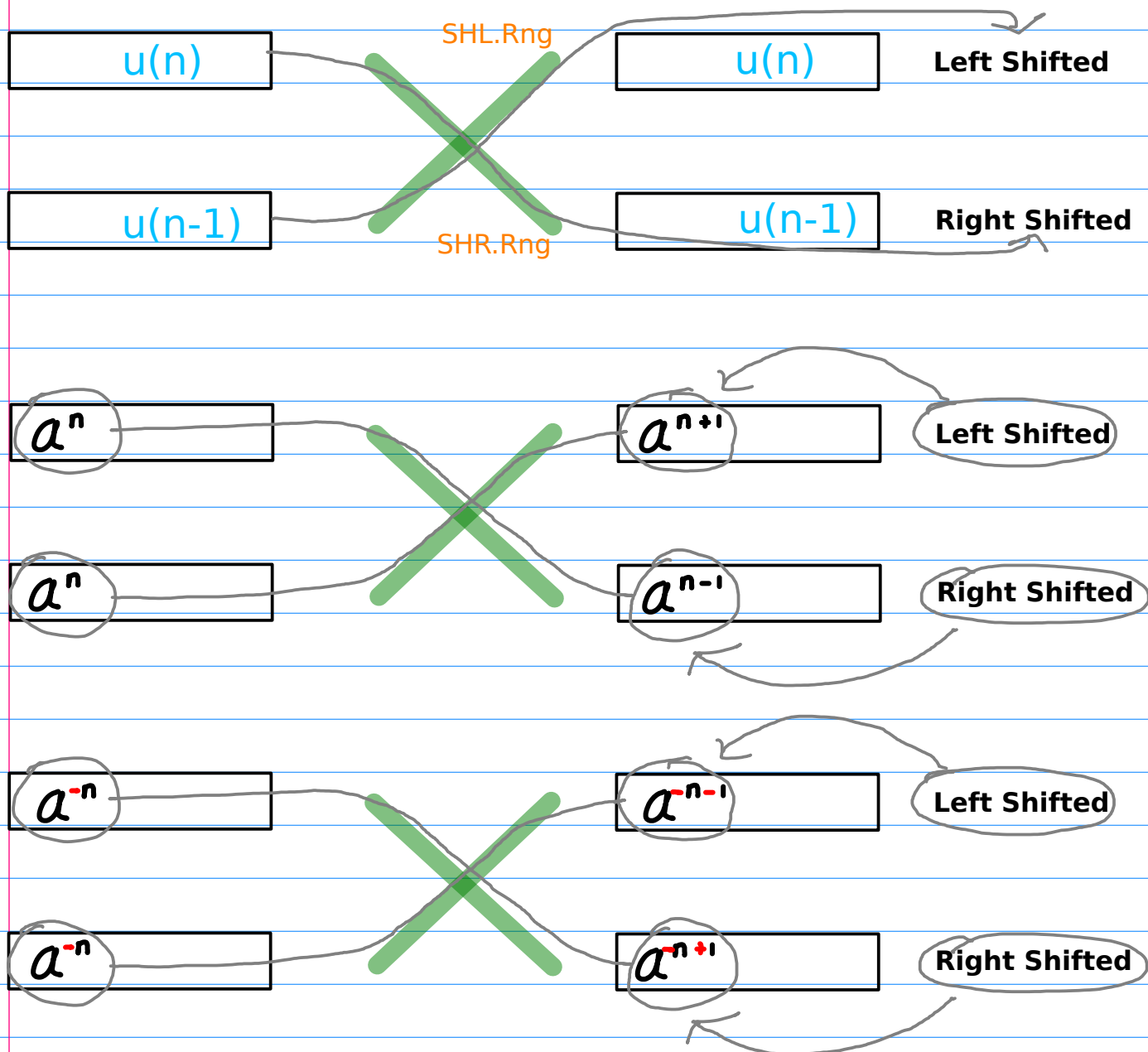

Determining {Left, Right} Shift of a pair of Anti-Causal Sequences

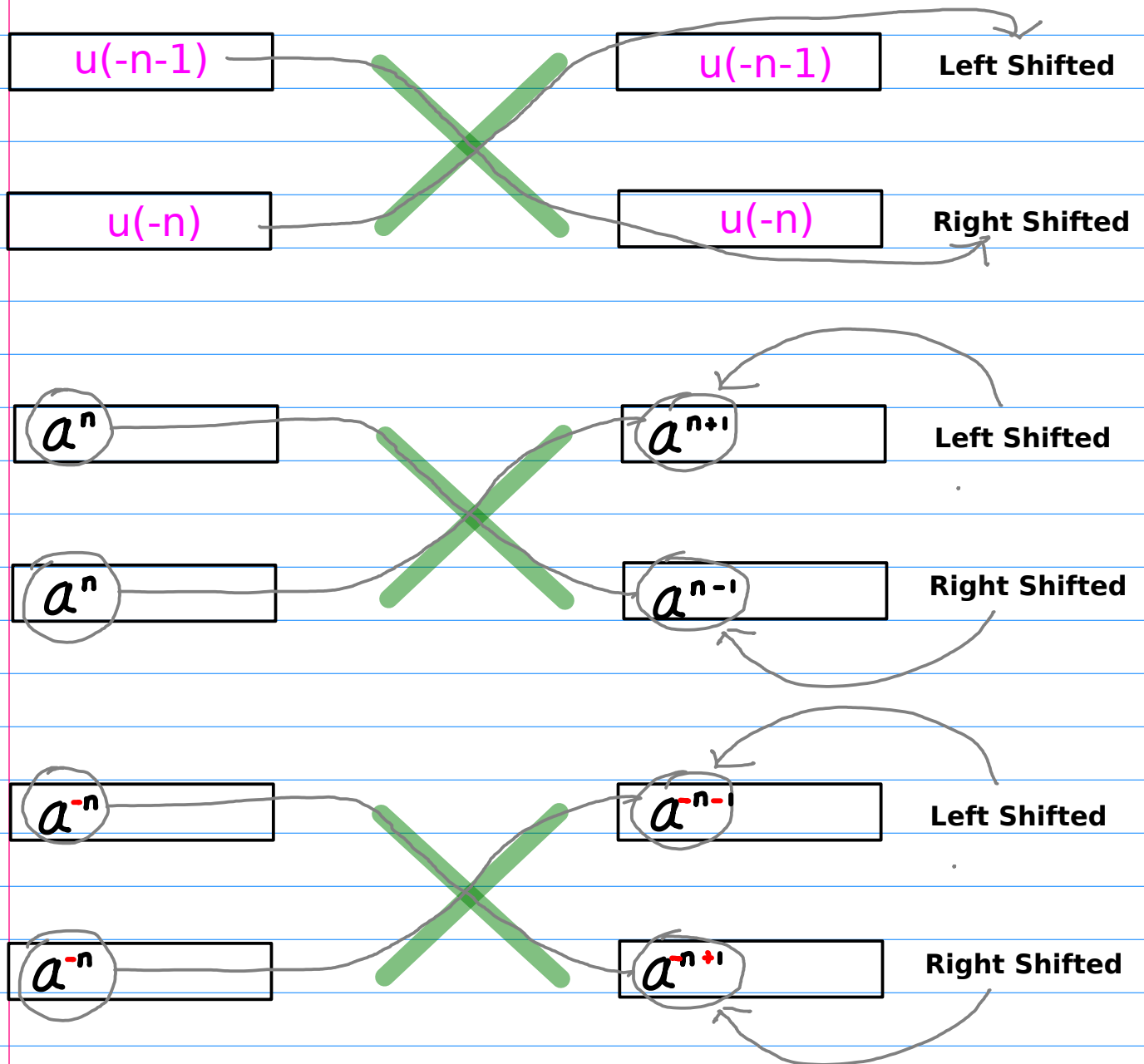

a^n

$a^n u(n)$

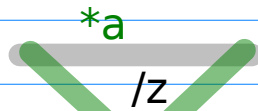

$a^{n+1} u(n)$

Left Shifted

$a^n u(n-1)$

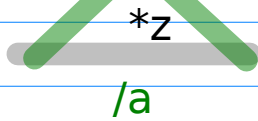

$a^{n-1} u(n-1)$

Right Shifted

$a^n u(-n-1)$

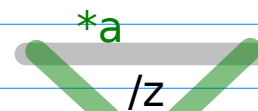

$a^{n+1} u(-n-1)$

Left Shifted

$a^n u(-n)$

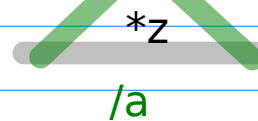

$a^{n-1} u(-n)$

Right Shifted

a^{-n}

$a^{-n} u(n)$

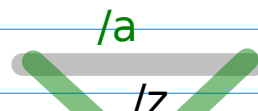

$a^{-n-1} u(n)$

Left Shifted

$a^{-n} u(n-1)$

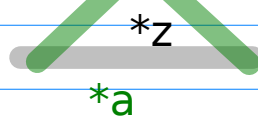

$a^{-n+1} u(n-1)$

Right Shifted

$a^{-n} u(-n-1)$

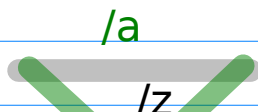

$a^{-n-1} u(-n-1)$

Left Shifted

$a^{-n} u(-n)$

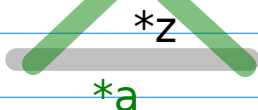

$a^{-n+1} u(-n)$

Right Shifted

Shifting Combinations (1) Multiplication Factors

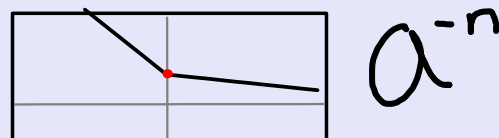
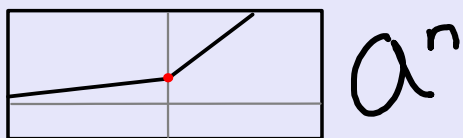

Causal Sequences
Anti-Causal Sequences

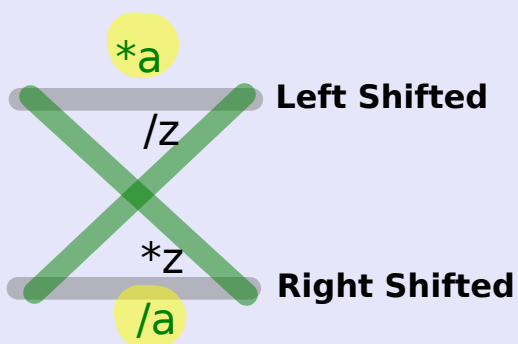

Causal Sequences
Anti-Causal Sequences

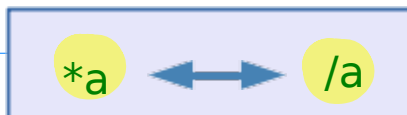
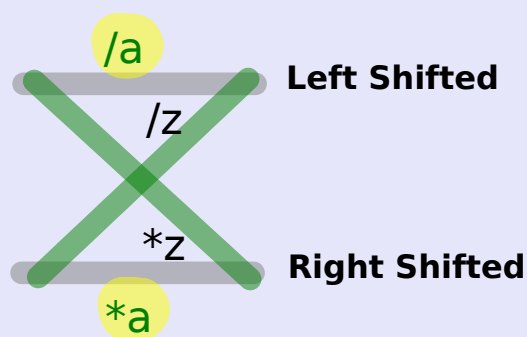

Shifting Combinations (2) - Sequences

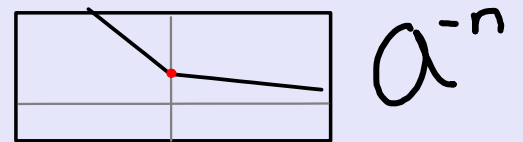
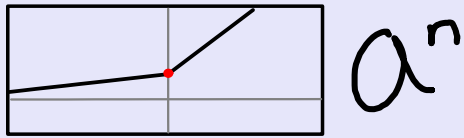

Causal Sequences

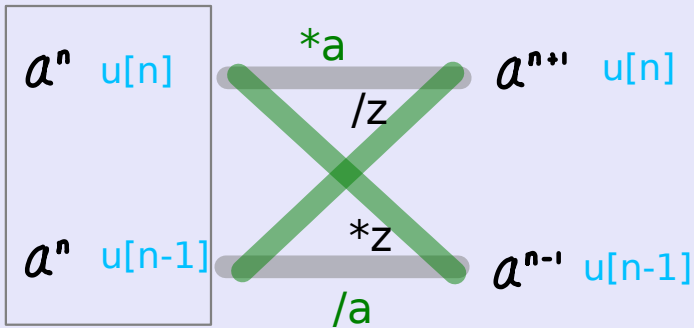

Causal Sequences

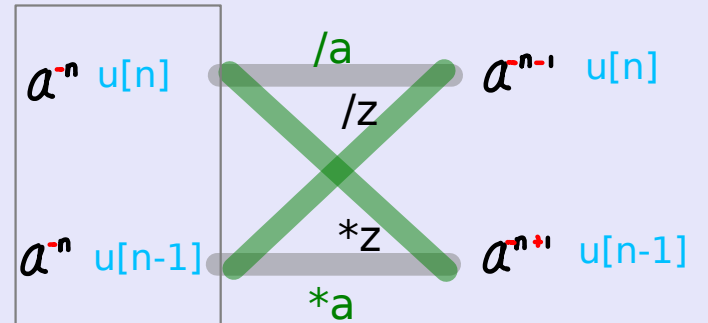

Anti-Causal Sequences

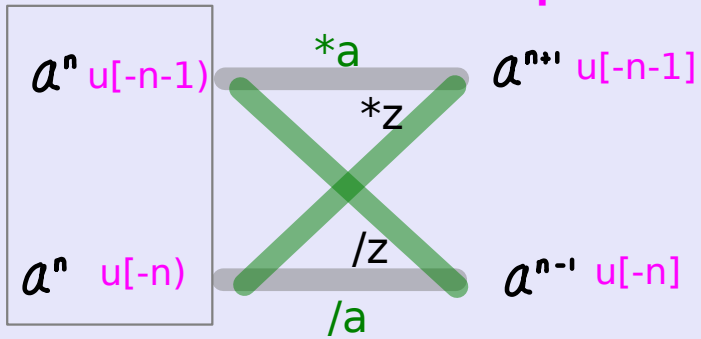

Anti-Causal Sequences

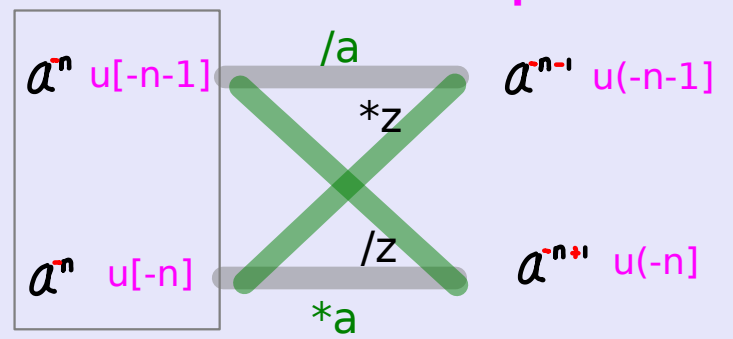

Shifting Combinations (3) - Geometric Series

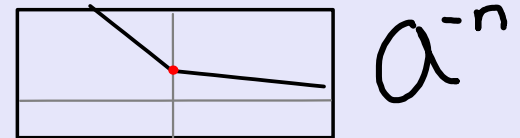
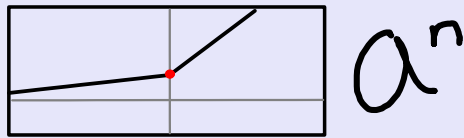

Causal Sequences

$\frac{1}{1-az}$	$\begin{matrix} *a \\ /z \end{matrix}$	$\frac{a}{1-az}$
$\frac{az}{1-az}$	$\begin{matrix} *z \\ /a \end{matrix}$	$\frac{z}{1-az}$

Causal Sequences

$\frac{1}{1-a^{-1}z}$	$\begin{matrix} /a \\ /z \end{matrix}$	$\frac{a^{-1}}{1-a^{-1}z}$
$\frac{a^{-1}z}{1-a^{-1}z}$	$\begin{matrix} *z \\ *a \end{matrix}$	$\frac{z}{1-a^{-1}z}$

Anti-Causal Sequences

$\frac{a^{-1}z^{-1}}{1-a^{-1}z^{-1}}$	$\begin{matrix} *a \\ *z \end{matrix}$	$\frac{z^{-1}}{1-a^{-1}z^{-1}}$
$\frac{1}{1-a^{-1}z^{-1}}$	$\begin{matrix} /z \\ /a \end{matrix}$	$\frac{a^{-1}}{1-a^{-1}z^{-1}}$

Anti-Causal Sequences

$\frac{az^{-1}}{1-az^{-1}}$	$\begin{matrix} /a \\ *z \end{matrix}$	$\frac{z^{-1}}{1-az^{-1}}$
$\frac{1}{1-az^{-1}}$	$\begin{matrix} /z \\ *a \end{matrix}$	$\frac{a}{1-az^{-1}}$

Shifting Combinations (4) - Numerator

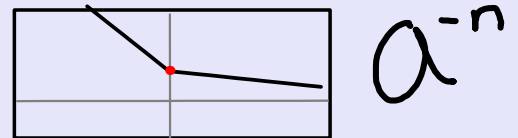
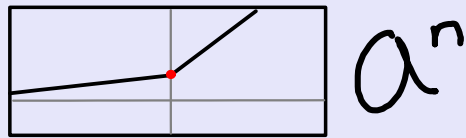

Causal Sequences

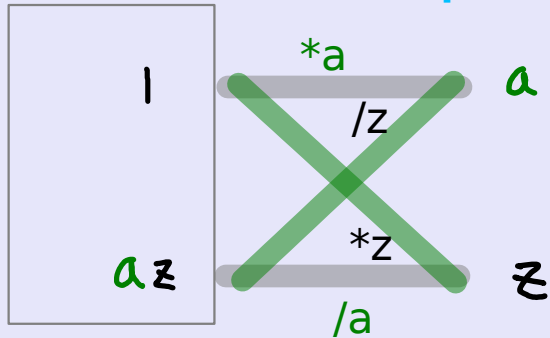

Causal Sequences

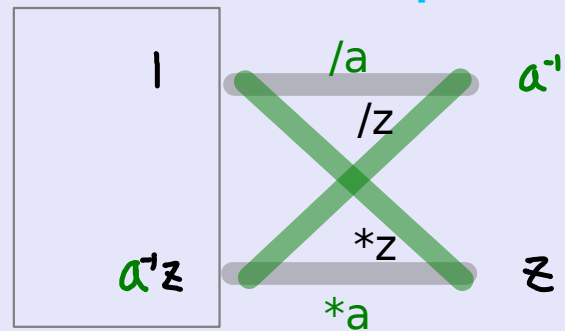

Anti-Causal Sequences

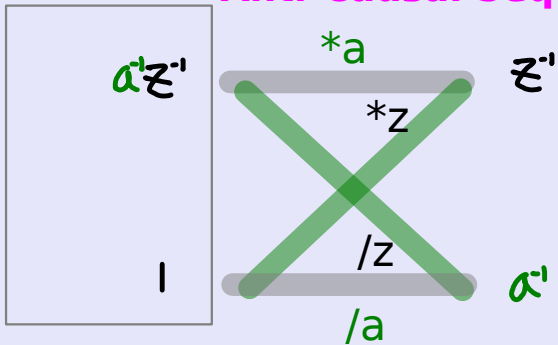

Anti-Causal Sequences

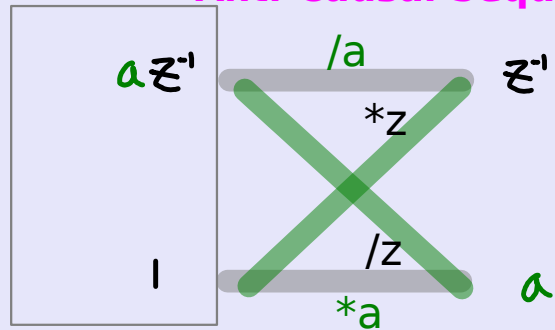

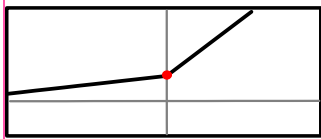

a^n

Geometric Series and Sequences

Causal Sequences

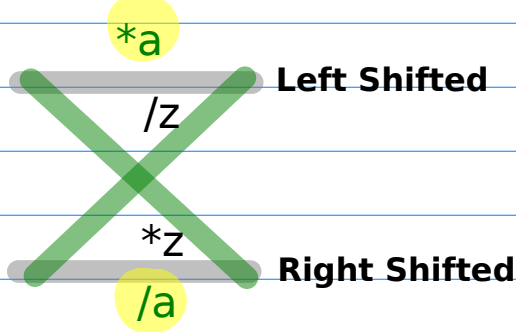

Anti-Causal Sequences

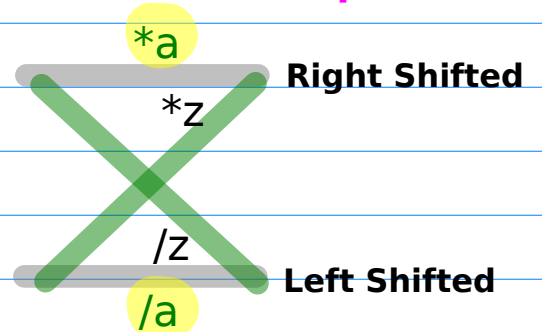

Causal Sequences

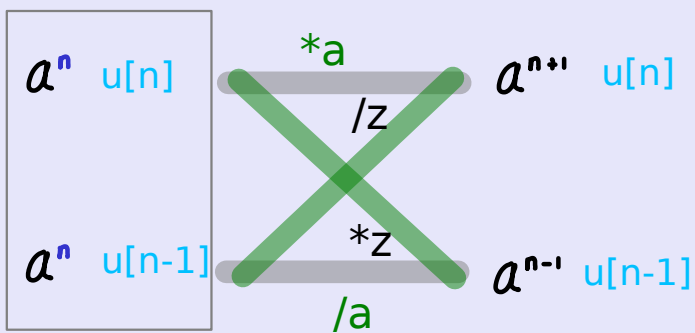

Anti-Causal Sequences

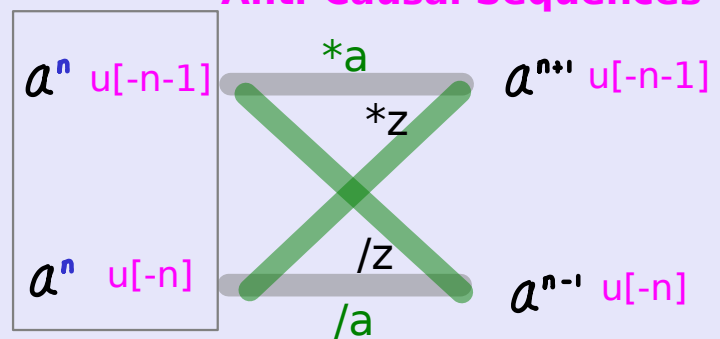

Causal Sequences

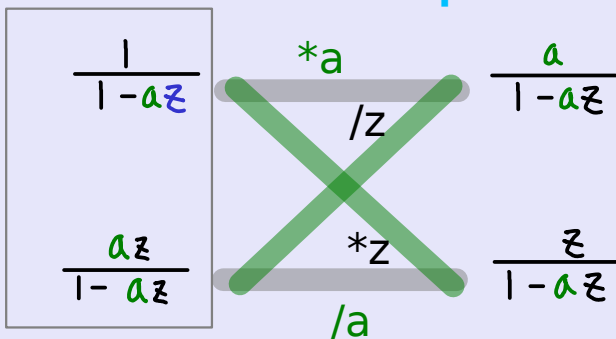

Anti-Causal Sequences

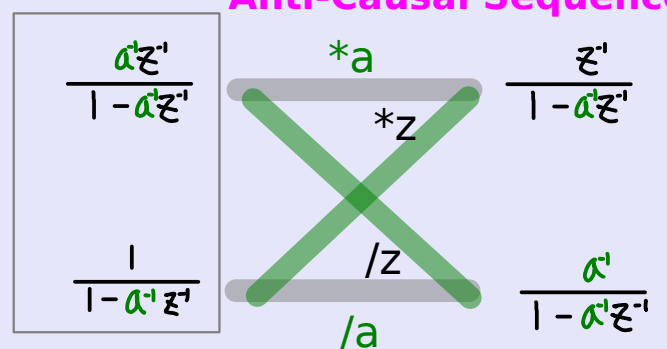

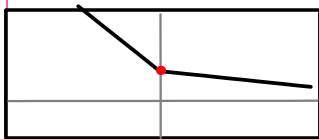

$$a^{-n}$$

Geometric Series and Sequences

Causal Sequences

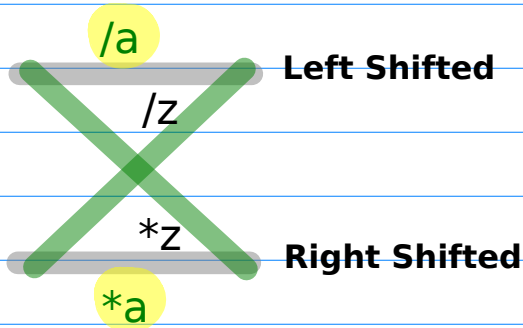

Anti-Causal Sequences

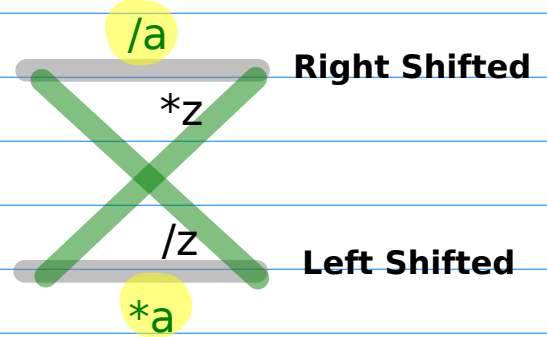

Causal Sequences

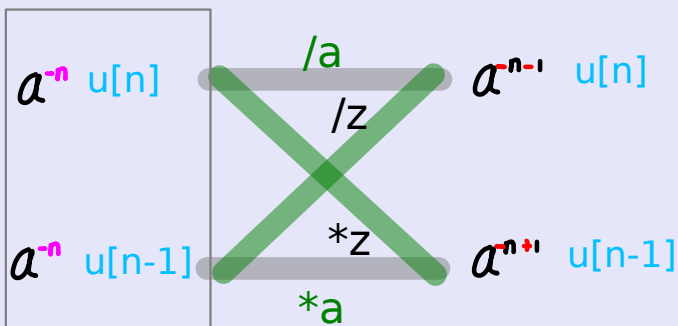

Anti-Causal Sequences

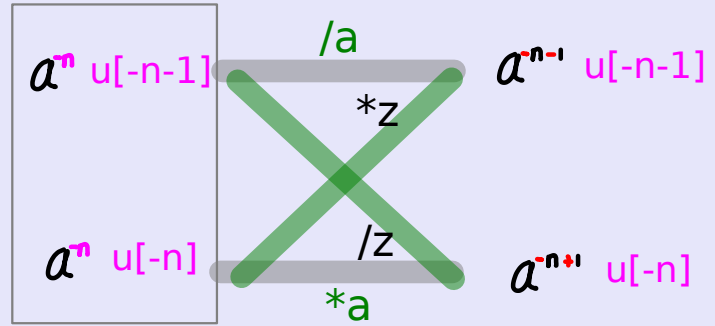

Causal Sequences

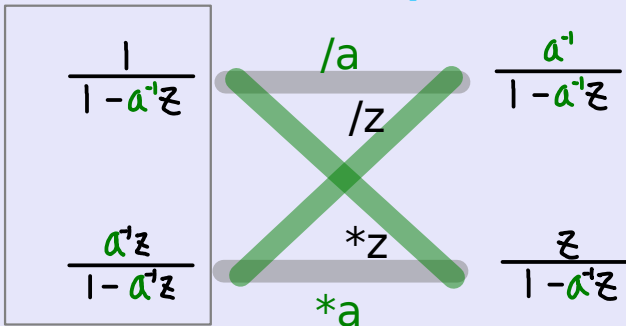

Anti-Causal Sequences

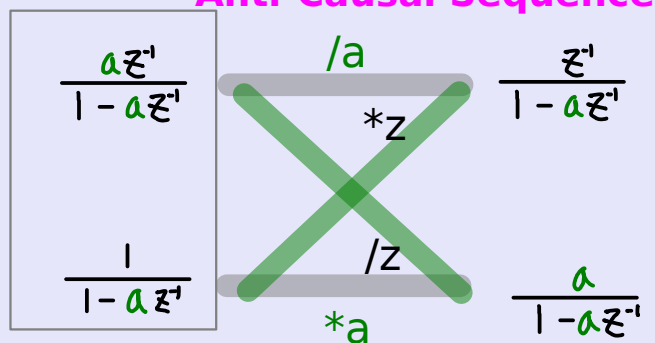

a^n

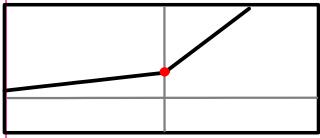

*a
/a

Shifting a sequence

$$\frac{1}{1-az} \quad |z| < a^{-1}$$

$a^n u(n)$

$$\frac{a}{1-az} \quad |z| < a^{-1}$$

$a^{n+1} u(n)$

$$\frac{az}{1-az} \quad |z| < a^{-1}$$

$a^n u(n-1)$

$$\frac{z}{1-az} \quad |z| < a^{-1}$$

$a^{n-1} u(n-1)$

$$\frac{a^{-1}z^{-1}}{1-a^{-1}z^{-1}} \quad |z| > a^{-1}$$

$a^n u(-n-1)$

$$\frac{z^{-1}}{1-a^{-1}z^{-1}} \quad |z| > a^{-1}$$

$a^{n+1} u(-n-1)$

$$\frac{1}{1-a^{-1}z^{-1}} \quad |z| > a^{-1}$$

$a^n u(-n)$

$$\frac{a^{-1}}{1-a^{-1}z^{-1}} \quad |z| > a^{-1}$$

$a^{n-1} u(-n)$

*a

/z

*z

/a

/a

/z

*z

*a

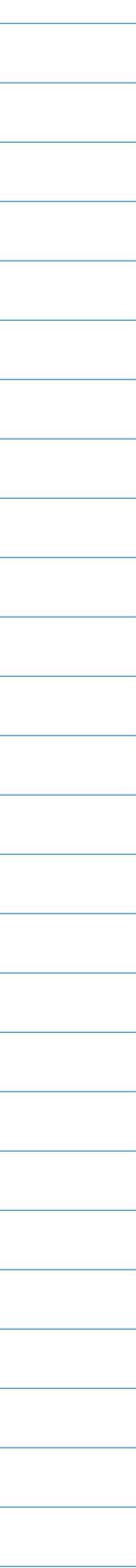

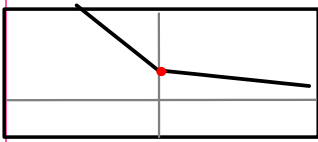
a^{-n} 

/a

*a

Shifting a sequence

$$\frac{1}{1-a^1 z} \quad |z| < a$$

$$a^{-n} u(n)$$

/a

/z

$$\frac{a^1}{1-a^1 z} \quad |z| < a$$

$$a^{-n-1} u(n)$$

*z

$$\frac{a^1 z}{1-a^1 z} \quad |z| < a$$

$$a^{-n} u(n-1)$$

*a

$$\frac{z}{1-a^1 z} \quad |z| < a$$

$$a^{-n+1} u(n-1)$$

$$\frac{a z^{-1}}{1-a z^{-1}} \quad |z| > a$$

$$a^{-n} u(-n-1)$$

*a

/z

$$\frac{z^{-1}}{1-a z^{-1}} \quad |z| > a$$

$$a^{-n-1} u(-n-1)$$

*z

$$\frac{1}{1-a z^{-1}} \quad |z| > a$$

$$a^{-n} u(-n)$$

/a

$$\frac{a}{1-a z^{-1}} \quad |z| > a$$

$$a^{-n+1} u(-n)$$

$$a z$$

$$\frac{1}{1 - a z} \quad |z| < a^{-1}$$

$$\frac{a z}{1 - a z} \quad |z| < a^{-1}$$

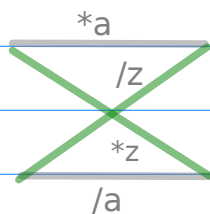

$$\frac{a}{1 - a z} \quad |z| < a^{-1}$$

$$\frac{z}{1 - a z} \quad |z| < a^{-1}$$

Left Shifted

Right Shifted

$$a^{-1} z^{-1}$$

$$\frac{a^{-1} z^{-1}}{1 - a^{-1} z^{-1}} \quad |z| > a^{-1}$$

$$\frac{1}{1 - a^{-1} z^{-1}} \quad |z| > a^{-1}$$

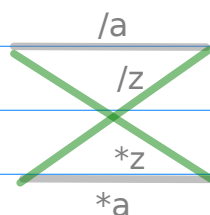

$$\frac{z^{-1}}{1 - a^{-1} z^{-1}} \quad |z| > a^{-1}$$

$$\frac{a^{-1}}{1 - a^{-1} z^{-1}} \quad |z| > a^{-1}$$

Left Shifted

Right Shifted

$$a^{-1} z$$

$$\frac{1}{1 - a^{-1} z} \quad |z| < a$$

$$\frac{a^{-1} z}{1 - a^{-1} z} \quad |z| < a$$

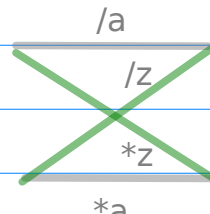

$$\frac{a^{-1}}{1 - a^{-1} z} \quad |z| < a$$

$$\frac{z}{1 - a^{-1} z} \quad |z| < a$$

Left Shifted

Right Shifted

$$a z^{-1}$$

$$\frac{a z^{-1}}{1 - a z^{-1}} \quad |z| > a$$

$$\frac{1}{1 - a z^{-1}} \quad |z| > a$$

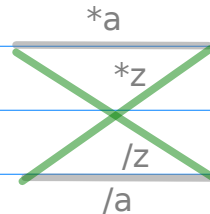

$$\frac{z^{-1}}{1 - a z^{-1}} \quad |z| > a$$

$$\frac{a}{1 - a z^{-1}} \quad |z| > a$$

Left Shifted

Right Shifted

$a z$

1
 $a z$

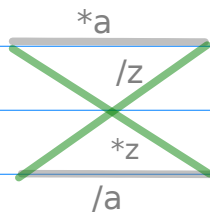

a
 z

Left Shifted

Right Shifted

$a^{-1} z^{-1}$

$a^{-1} z^{-1}$
 1

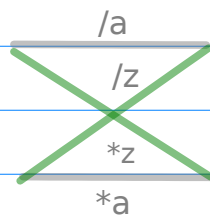

z^{-1}
 a^{-1}

Left Shifted

Right Shifted

$a^{-1} z$

1
 $a^{-1} z$

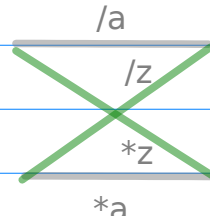

a^{-1}
 z

Left Shifted

Right Shifted

$a z^{-1}$

$a z^{-1}$
 1

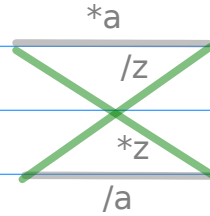

z^{-1}
 a

Left Shifted

Right Shifted

$$a z$$

$a^n u(n)$
$-a^n u(n-1)$

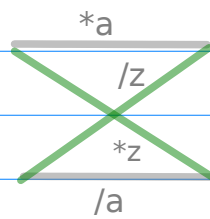

$a^{n+1} u(n)$
$-a^{n+1} u(n-1)$

Left Shifted

Right Shifted

$$a^{-1} z^{-1}$$

$-a^n u(-n-1)$
$a^n u(-n)$

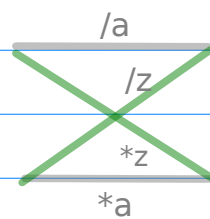

$-a^{n+1} u(-n-1)$
$a^{n+1} u(-n)$

Left Shifted

Right Shifted

$$a^{-1} z$$

$(\frac{1}{a})^n u(n)$
$-(\frac{1}{a})^n u(n-1)$

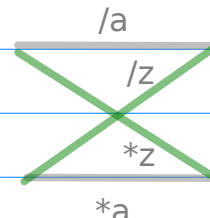

$(\frac{1}{a})^{n+1} u(n)$
$-(\frac{1}{a})^{n+1} u(n-1)$

Left Shifted

Right Shifted

$$a z^{-1}$$

$-(\frac{1}{a})^n u(-n-1)$
$(\frac{1}{a})^n u(-n)$

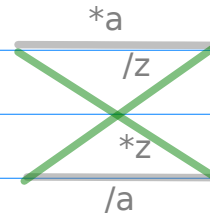

$-(\frac{1}{a})^{n+1} u(-n-1)$
$(\frac{1}{a})^{n+1} u(-n)$

Left Shifted

Right Shifted

a^n

Shifted Sequences

 $u(n)$ $u(-n-1)$
 $u(n-1)$ $u(-n)$

Causal

Anti-causal

ID.Rng

$$a^n \cdot u(n) \rightarrow a^{n+1} \cdot u(n)$$

$$\ll (\textcircled{0}, a^1, a^2, \dots) \quad (a^1, a^2, a^3, \dots)$$

1 shift out

$$a^n \cdot u(-n-1) \rightarrow a^{n+1} \cdot u(-n-1)$$

$$(\dots, a^3, a^2, a^1) \quad (\dots, a^2, a^1, \textcircled{0}) \ll$$

1 shift in

SHL.Rng

$$a^n \cdot u(n-1) \rightarrow a^{n+1} \cdot u(n)$$

$$\ll (\textcircled{0}, a^1, a^2, \dots) \quad (a^1, a^2, a^3, \dots)$$

$$a^n \cdot u(-n) \rightarrow a^{n+1} \cdot u(-n-1)$$

$$(\dots, a^2, a^1, a^0) \quad (\dots, a^1, a^0, \textcircled{0}) \ll$$

SHR.Rng

$$a^n \cdot u(n) \rightarrow a^{n-1} \cdot u(n-1)$$

$$(a^0, a^1, a^2, \dots) \gg (\textcircled{0}, a^0, a^1, \dots)$$

$$a^n \cdot u(-n-1) \rightarrow a^{n-1} \cdot u(-n)$$

$$(\dots, a^3, a^2, \textcircled{0}) \gg (\dots, a^3, a^2, a^1)$$

ID.Rng

$$a^n \cdot u(n-1) \rightarrow a^{n-1} \cdot u(n-1)$$

$$(a^1, a^2, a^3, \dots) \gg (\textcircled{a^0}, a^1, a^2, \dots)$$

1 shift in

$$a^n \cdot u(-n) \rightarrow a^{n-1} \cdot u(-n)$$

$$(\dots, a^3, a^2, \textcircled{a^1}) \gg (\dots, a^3, a^2, a^1)$$

1 shift out

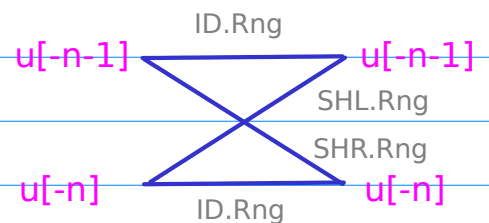
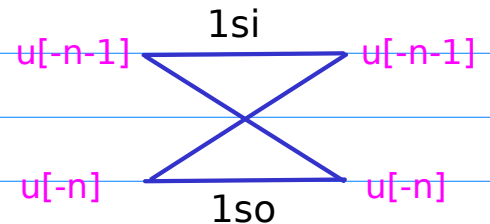
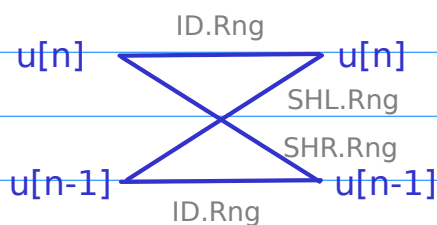
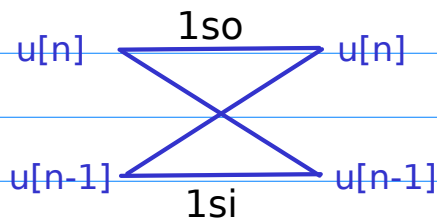
 a^n 

a^{-n}

Shifted Sequences

 $u(n)$ $u(-n-1)$
 $u(n-1)$ $u(-n)$

Causal

Anti-causal

ID.Rng

$$a^{-n} \cdot u(n) \longrightarrow a^{-n-1} \cdot u(n)$$

$$\ll (\textcircled{0}, a^1, a^2, \dots) \quad (a^1, a^2, a^3, \dots)$$

1 shift out

$$a^{-n} \cdot u(-n-1) \longrightarrow a^{-n-1} \cdot u(-n-1)$$

$$(\dots, a^3, a^2, a^1) \quad (\dots, a^2, a^1, \textcircled{0}) \ll$$

1 shift in

SHL.Rng

$$a^{-n} \cdot u(n-1) \longrightarrow a^{-n-1} \cdot u(n)$$

$$\ll (\textcircled{0}, a^1, a^2, \dots) \quad (a^1, a^2, a^3, \dots)$$

$$a^{-n} \cdot u(-n) \longrightarrow a^{-n-1} \cdot u(-n-1)$$

$$(\dots, a^2, a^1, a^0) \quad (\dots, a^1, a^0, \textcircled{0}) \ll$$

SHR.Rng

$$a^{-n} \cdot u(n) \longrightarrow a^{-n+1} \cdot u(n-1)$$

$$(a^0, a^1, a^2, \dots) \gg (\textcircled{0}, a^0, a^1, \dots)$$

$$a^{-n} \cdot u(-n-1) \longrightarrow a^{-n+1} \cdot u(-n)$$

$$(\dots, a^2, a^1, \textcircled{0}) \gg (\dots, a^3, a^2, a^1)$$

ID.Rng

$$a^{-n} \cdot u(n-1) \longrightarrow a^{-n+1} \cdot u(n-1)$$

$$(a^1, a^2, a^3, \dots) \gg (\textcircled{0}, a^1, a^2, \dots)$$

1 shift in

$$a^{-n} \cdot u(-n) \longrightarrow a^{-n+1} \cdot u(-n)$$

$$(\dots, a^2, a^1, \textcircled{0}) \gg (\dots, a^3, a^2, a^1)$$

1 shift out

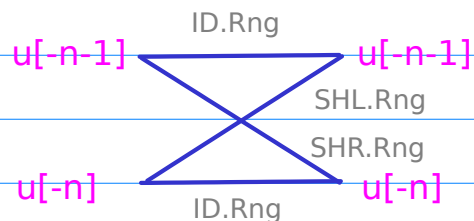
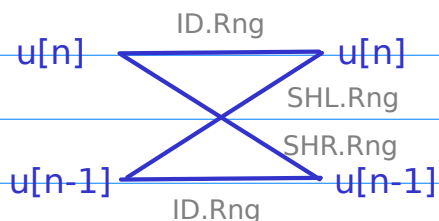
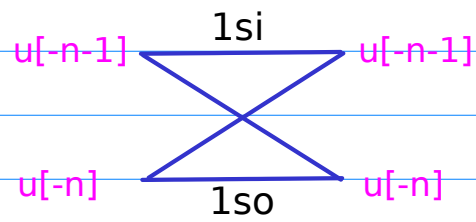
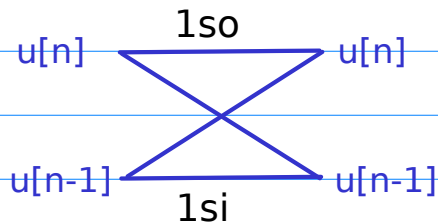
 a^{-n} 

Left Shifting Sequences a^n

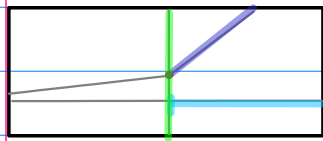

$$a^n u[n]$$

SHL.Exp

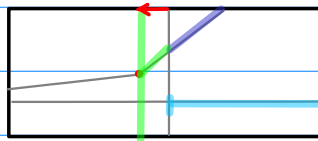

$$a^{n+1} u[n]$$

||

$$a^n u[n-1]$$

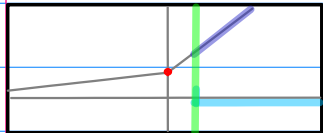

SHL.Exp

SHL.Rng

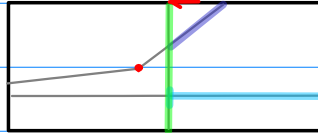

$$a^{n+1} u[n]$$

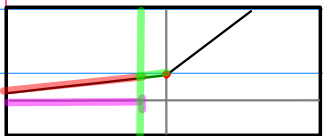
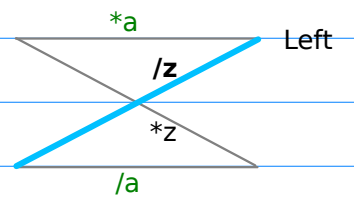
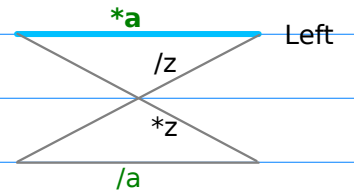

$$a^n u[-n-1]$$

SHL.Exp

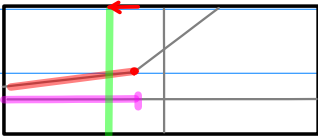

$$a^{n+1} u[-n-1]$$

||

$$a^n u[-n]$$

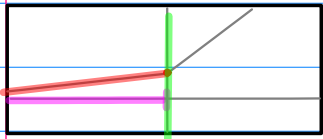

SHL.Exp

SHL.Rng

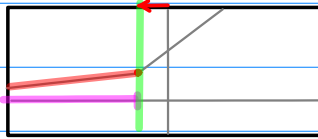

$$a^{n+1}$$

$$u[-n-1]$$

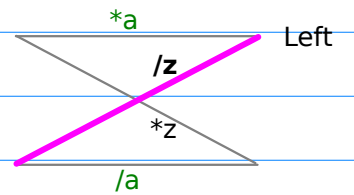
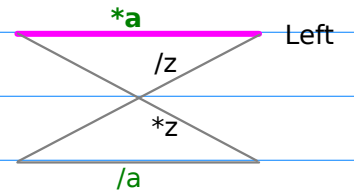

Right Shifting Sequences a^n

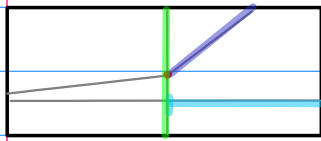

SHR.Exp

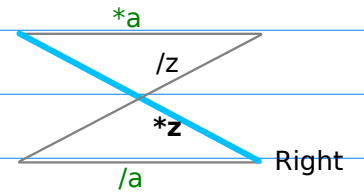
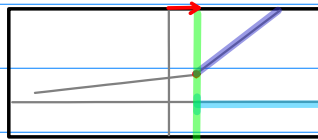

$$a^n u[n]$$

$$a^{n-1} u[n-1]$$

||

$$a^n u[n-1]$$

$$a^{n-1} u[n-1]$$

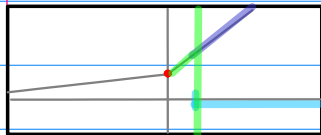

SHR.Exp

SHR.Rng

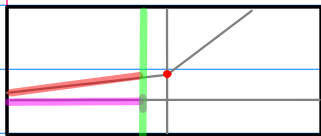
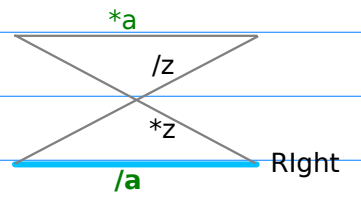
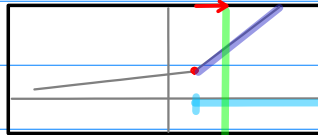

SHR.Exp

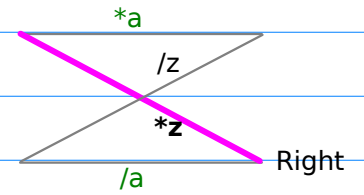
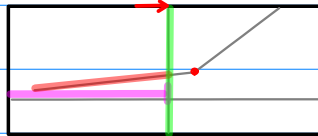

$$a^n u[-n-1]$$

$$a^{n-1} u[-n]$$

||

$$a^n u[-n]$$

$$a^{n-1} u[-n]$$

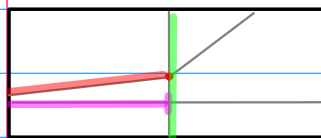

SHR.Exp

SHR.Rng

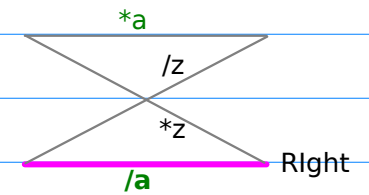
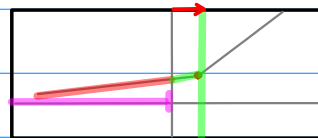

Left Shifting Sequences a^{-n}

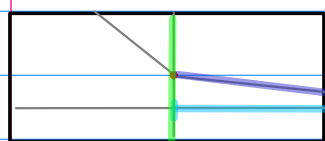

$$a^{-n} u[n]$$

SHL.Exp

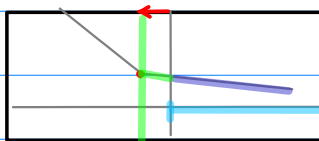

$$a^{-n-1} u[n]$$

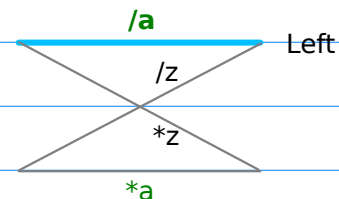

||

$$a^{-n} u[n-1]$$

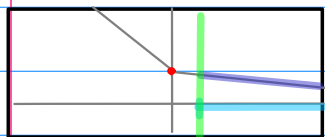

SHL.Exp

SHL.Rng

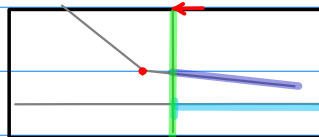

$$a^{-n-1} u[n]$$

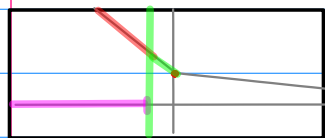
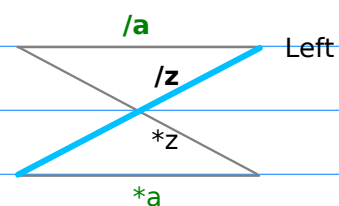

$$a^{-n} u[-n-1]$$

SHL.Exp

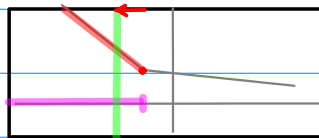

$$a^{-n-1} u[-n-1]$$

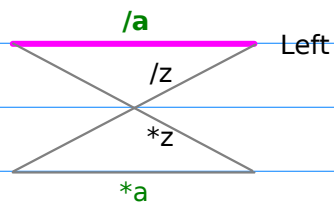

||

$$a^{-n} u[-n]$$

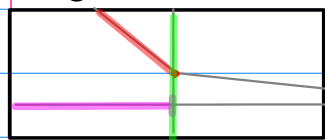

SHL.Exp

SHL.Rng

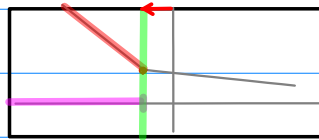

$$a^{-n-1} u[-n-1]$$

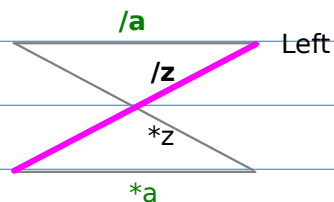

Right Shifting Sequences a^{-n}

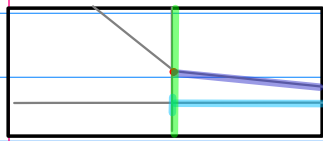

$$a^{-n} u[n]$$

SHR.Exp

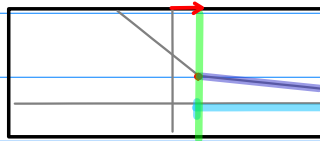

$$a^{-(n+1)} u[n-1]$$

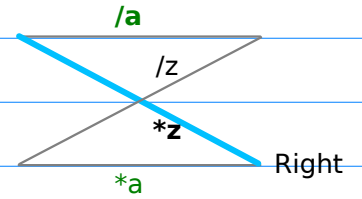

||

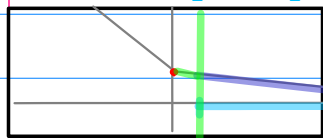

$$a^{-n} u[n-1]$$

SHR.Exp

SHR.Rng

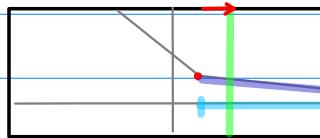

$$a^{-(n+1)} u[n-1]$$

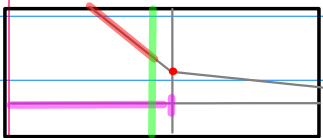
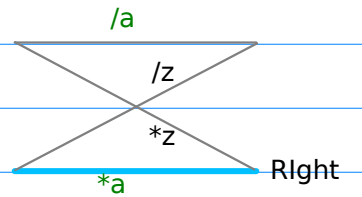

$$a^{-n} u[-n-1]$$

SHR.Exp

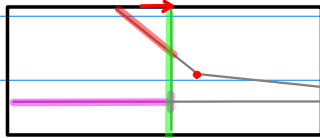

$$a^{-(n+1)} u[-n]$$

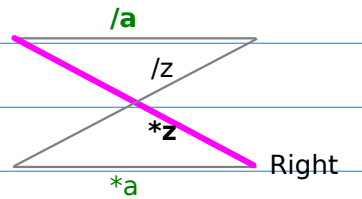

||

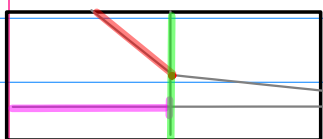

$$a^{-n} u[-n]$$

SHR.Exp

SHR.Rng

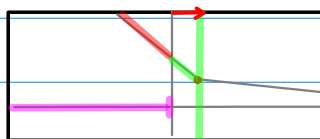

$$a^{-(n+1)} u[-n]$$

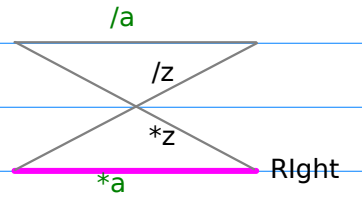

Left Shifting Sequences

$$\begin{matrix} 0 & 1 & 2 \\ \textcircled{a^0} & a^1 & a^2, \dots \end{matrix} \quad a^n u[n]$$

 the same range

$$\begin{matrix} 0 & 1 & 2 \\ a^1 & a^2 & a^3, \dots \end{matrix} \quad a^{n+1} u[n]$$
 one shifted-out

$$\begin{matrix} 0 & 1 & 2 \\ \textcircled{0} & a^1 & a^2, \dots \end{matrix} \quad a^n u[n-1]$$

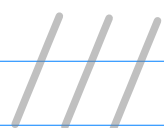
 left shifted range

$$\begin{matrix} 0 & 1 & 2 \\ a^1 & a^2 & a^3, \dots \end{matrix} \quad a^{n+1} u[n]$$
 zero shifted-out

$$\begin{matrix} -3 & -2 & -1 \\ \dots & a^{-3} & a^{-2}, a^{-1} \end{matrix} \quad a^n u[-n-1]$$

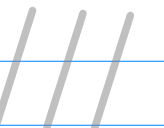
 the same range

$$\begin{matrix} -3 & -2 & -1 \\ \dots & a^{-3} & a^{-2}, \textcircled{a^{-1}} \end{matrix} \quad a^{n+1} u[-n-1]$$
 one shifted-in

$$\begin{matrix} -2 & -1 & 0 \\ \dots & a^{-2} & a^{-1}, a^0 \end{matrix} \quad a^n u[-n]$$

 left shifted range

$$\begin{matrix} -2 & -1 & 0 \\ \dots & a^{-2} & a^{-1}, \textcircled{0} \end{matrix} \quad a^{n+1} u[-n-1]$$
 zero shifted-in

SHL.Exp ... a^n

SHL.Rng, SHL.Exp ... a^n

SHL.Exp ... a^{-n}

SHL.Rng, SHL.Exp ... a^{-n}

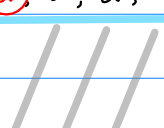
$$\begin{matrix} 0 & 1 & 2 \\ \textcircled{a^0} & a^1 & a^2, \dots \end{matrix} \quad a^{-n} u[n]$$

 the same range

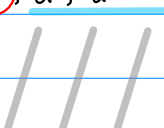
$$\begin{matrix} 0 & 1 & 2 \\ a^1 & a^2 & a^3, \dots \end{matrix} \quad a^{-n-1} u[n]$$
 one shifted-out

$$\begin{matrix} 0 & 1 & 2 \\ \textcircled{0} & a^1 & a^2, \dots \end{matrix} \quad a^{-n} u[n-1]$$

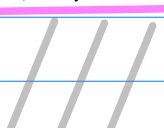
 left shifted range

$$\begin{matrix} 0 & 1 & 2 \\ a^1 & a^2 & a^3, \dots \end{matrix} \quad a^{-n-1} u[n]$$
 zero shifted-out

$$\begin{matrix} -3 & -2 & -1 \\ \dots & a^{-3} & a^{-2}, a^{-1} \end{matrix} \quad a^{-n} u[-n-1]$$

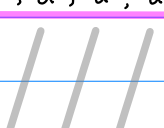
 the same range

$$\begin{matrix} -3 & -2 & -1 \\ \dots & a^{-3} & a^{-2}, \textcircled{a^{-1}} \end{matrix} \quad a^{-n-1} u[-n-1]$$
 one shifted-in

$$\begin{matrix} -2 & -1 & 0 \\ \dots & a^{-2} & a^{-1}, a^0 \end{matrix} \quad a^{-n} u[-n]$$

 left shifted range

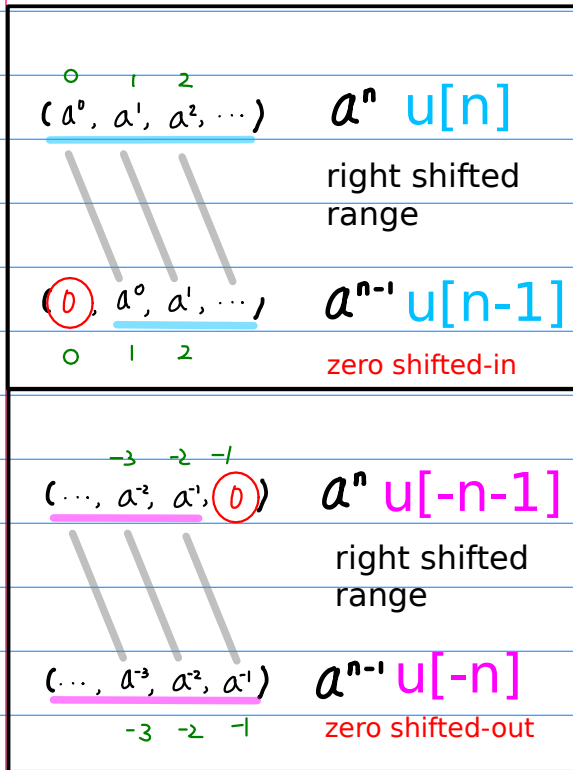
$$\begin{matrix} -2 & -1 & 0 \\ \dots & a^{-2} & a^{-1}, \textcircled{0} \end{matrix} \quad a^{-n-1} u[-n-1]$$
 zero shifted-in

Right Shifting Sequences

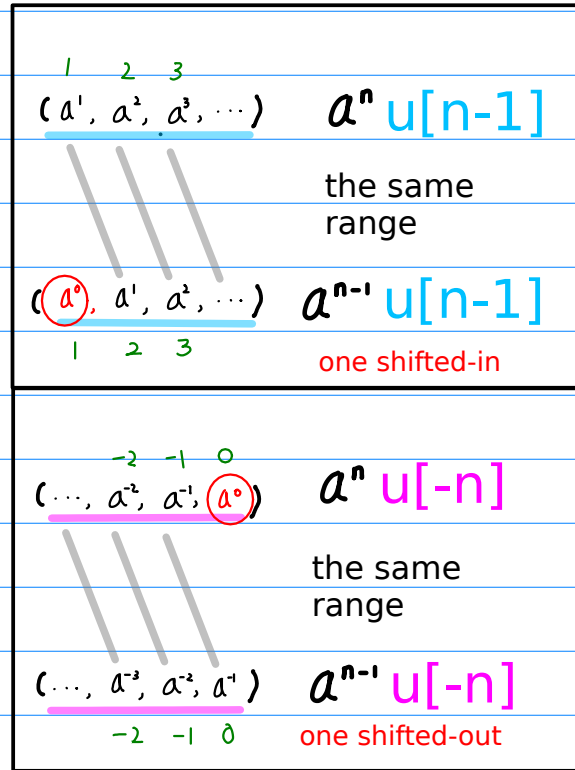

SHR.Exp ... a^n



SHR.Rng, SHR.Exp ... a^n

SHR.Exp ... a^{-n}

SHR.Rng, SHR.Exp ... a^{-n}

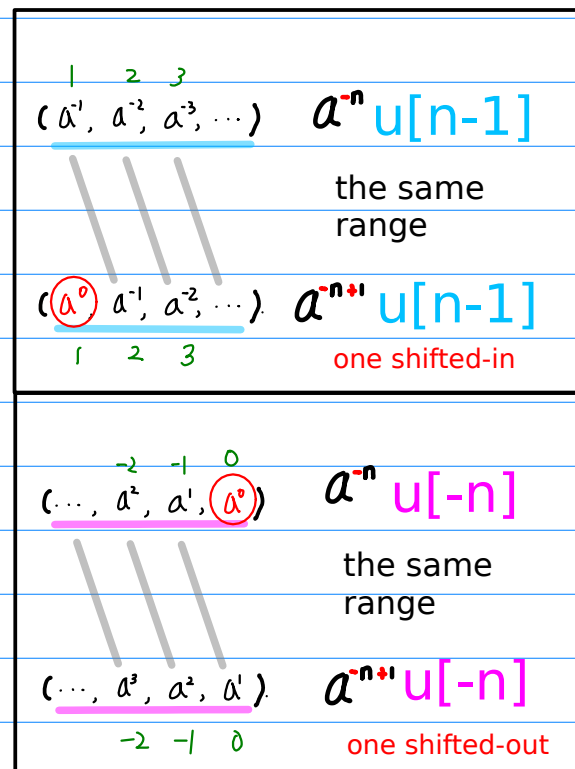
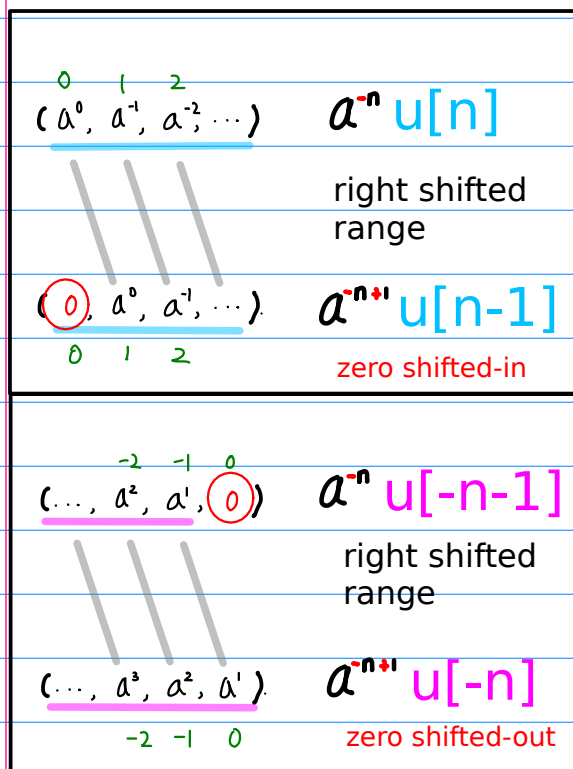

Original Sequence



Shifted Sequence

$\ll (\textcircled{0}, a^1, a^2, \dots)$

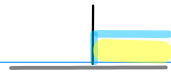

ID.Rng



(a^1, a^2, a^3, \dots)

(\dots, a^3, a^2, a^1)

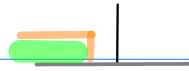

ID.Rng

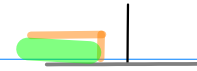

$(\dots, a^2, a^1, \textcircled{0}) \ll$

$\ll (\textcircled{0}, a^1, a^2, \dots)$

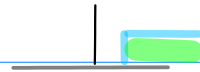

SHL.Rng

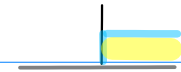

(a^1, a^2, a^3, \dots)

(\dots, a^2, a^1, a^0)

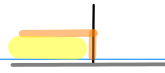

SHL.Rng

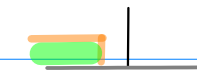

$(\dots, a^1, a^0, \textcircled{0}) \ll$

(a^1, a^2, a^3, \dots)

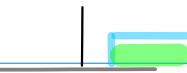

ID.Rng

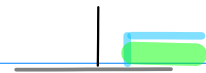

$\gg (\textcircled{0}, a^1, a^2, \dots)$

$(\dots, a^2, a^1, \textcircled{0}) \gg$

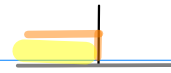

ID.Rng

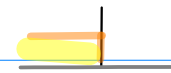

(\dots, a^3, a^2, a^1)

(a^0, a^1, a^2, \dots)



SHR.Rng

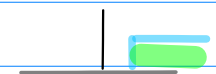

$\gg (\textcircled{0}, a^0, a^1, \dots)$

$(\dots, a^3, a^2, \textcircled{0}) \gg$



SHR.Rng



(\dots, a^3, a^2, a^1)

Original Sequence



Shifted Sequence

$\ll (\textcircled{a^0}, a^1, a^2, \dots)$

(\dots, a^3, a^2, a^1)

- * no shift
- * non-zero shift in
- * a new value introduced

(a^1, a^2, a^3, \dots)

$(\dots, a^2, a^1, \textcircled{a^0}) \ll$

$\ll (\textcircled{0}, a^1, a^2, \dots)$

(\dots, a^2, a^1, a^0)

- * left shift
- * zero shift in
- * the same set of values

(a^1, a^2, a^3, \dots)

$(\dots, a^1, a^0, \textcircled{0}) \ll$

(a^1, a^2, a^3, \dots)

$(\dots, a^2, a^1, \textcircled{a^0}) \gg$

- * no shift
- * non-zero shift in
- * a new value introduced

$\gg (\textcircled{a^0}, a^1, a^2, \dots)$

(\dots, a^3, a^2, a^1)

(a^0, a^1, a^2, \dots)

$(\dots, a^2, a^1, \textcircled{0}) \gg$

- * right shift
- * zero shift in
- * the same set of values

$\gg (\textcircled{0}, a^0, a^1, \dots)$

(\dots, a^3, a^2, a^1)

1-A	Left Shift	Causal	$u(n)$	$u(n)$	ID.Rng
1-B	Left Shift	Causal	$u(n-1)$	$u(n)$	SHL.Rng
1-C	Left Shift	Anti-Causal	$u(-n-1)$	$u(-n-1)$	ID.Rng
1-D	Left Shift	Anti-Causal	$u(-n)$	$u(-n-1)$	SHL.Rng
2-A	Right Shift	Causal	$u(n-1)$	$u(n-1)$	ID.Rng
2-B	Right Shift	Causal	$u(n)$	$u(n-1)$	SHR.Rng
2-C	Right Shift	Anti-Causal	$u(-n)$	$u(-n)$	ID.Rng
2-D	Right Shift	Anti-Causal	$u(-n-1)$	$u(-n)$	SHR.Rng

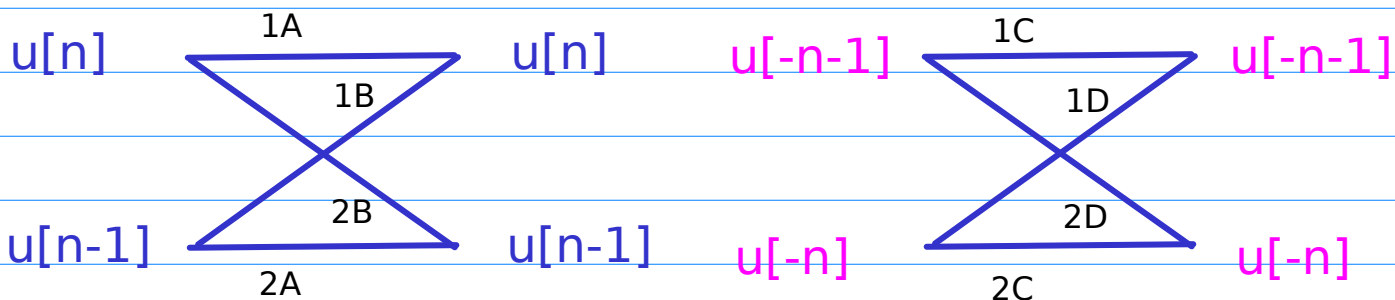

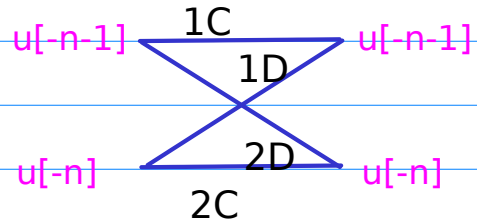
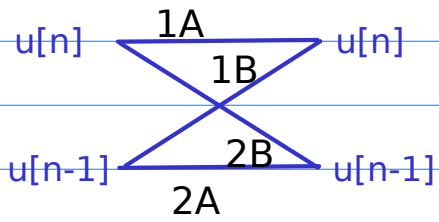

a^n

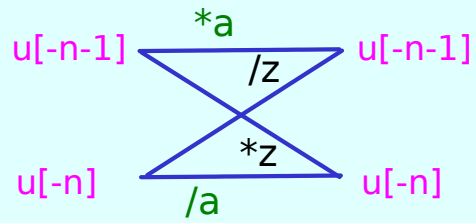
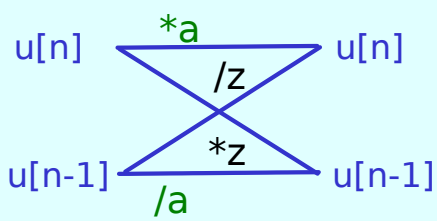

a^{-n}

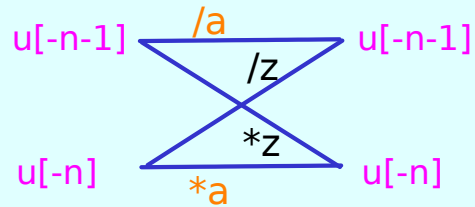
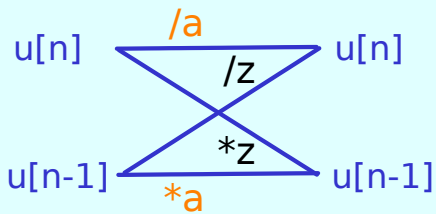

a^n

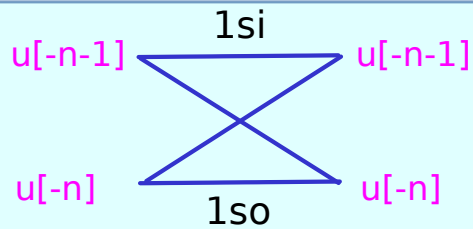
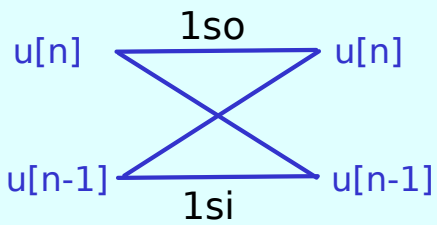

a^{-n}

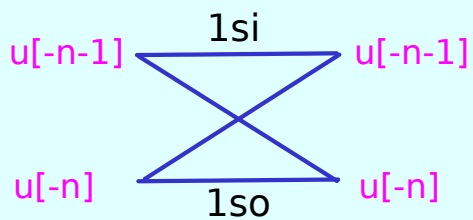
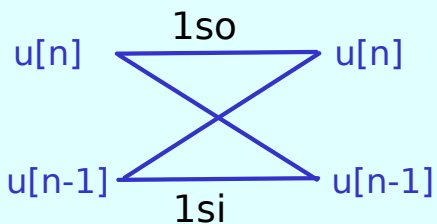

I-A Left Shifted Sequence (a, a^{-1})

Causal

$$a^n \cdot u(n) \rightarrow a^{n+1} \cdot u(n) \quad \text{ID.Rng}$$

$$a^{-n} \cdot u(n) \rightarrow a^{-n-1} \cdot u(n) \quad \text{ID.Rng}$$

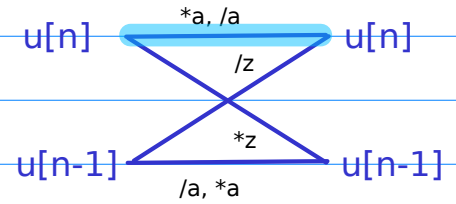

1 shifted out

$*a$

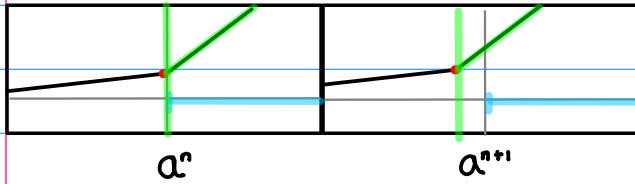

$$\frac{1}{1-az} \quad |z| < a^{-1}$$

$$\frac{a}{1-az} \quad |z| < a^{-1}$$

$/a$

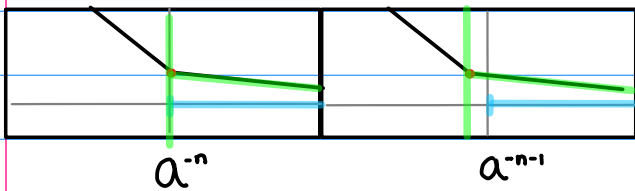

$$\frac{1}{1-a^{-1}z} \quad |z| < a$$

$$\frac{a^{-1}}{1-a^{-1}z} \quad |z| < a$$

$$\frac{1}{1-az} = a^0 z^0 + a^1 z^1 + a^2 z^2 + \dots \Rightarrow \begin{matrix} 0 & 1 & 2 \\ (a^0, a^1, a^2, \dots) & & \end{matrix} \quad u(n)$$

$$\frac{a}{1-az} = a^1 z^0 + a^2 z^1 + a^3 z^2 + \dots \Rightarrow \begin{matrix} & 0 & 1 & 2 \\ (a^1, a^2, a^3, \dots) & & & \end{matrix} \quad u(n)$$

$$\frac{1}{1-a^{-1}z} = a^0 z^0 + a^{-1} z^1 + a^{-2} z^2 + \dots \Rightarrow \begin{matrix} 0 & 1 & 2 \\ (a^0, a^{-1}, a^{-2}, \dots) & & \end{matrix} \quad u(n)$$

$$\frac{a^{-1}}{1-a^{-1}z} = a^{-1} z^0 + a^{-2} z^1 + a^{-3} z^2 + \dots \Rightarrow \begin{matrix} & 0 & 1 & 2 \\ (a^{-1}, a^{-2}, a^{-3}, \dots) & & & \end{matrix} \quad u(n)$$

I-B Left Shfted Sequence (z^{-1}, z^{-1}) Causal

$a^n \cdot u(n-1) \rightarrow a^{n+1} \cdot u(n)$ SHL.Rng

$a^{-n} \cdot u(n-1) \rightarrow a^{-n-1} \cdot u(n)$ SHL.Rng

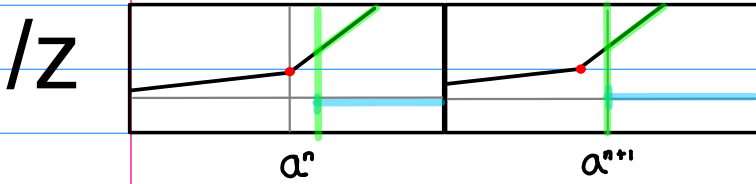
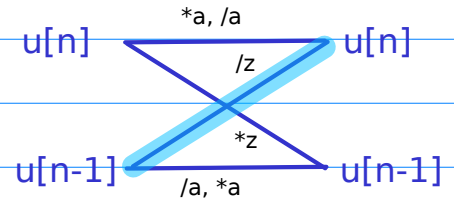

$\frac{az}{1-az}$
 $|z| < a^{-1}$

$\frac{a}{1-az}$
 $|z| < a^{-1}$

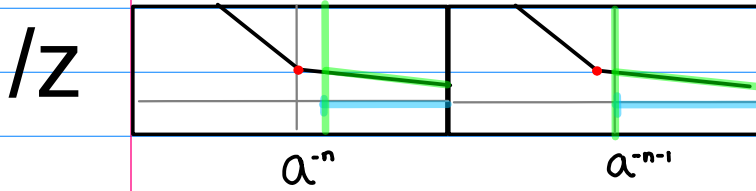

$\frac{a'z}{1-a'z}$
 $|z| < a$

$\frac{a'}{1-a'z}$
 $|z| < a$

$\frac{az}{1-az} = a^1 z^1 + a^2 z^2 + a^3 z^3 + \dots \Rightarrow (0, \overset{0}{a^1}, \overset{1}{a^2}, \dots)$ $u(n-1)$
 $|z| < a^{-1}$

$\frac{a}{1-az} = a^1 z^0 + a^2 z^1 + a^3 z^2 + \dots \Rightarrow (\overset{0}{a^1}, \overset{1}{a^2}, \overset{2}{a^3}, \dots)$ $u(n)$
 $|z| < a^{-1}$

$\frac{a'z}{1-a'z} = a^{-1} z^1 + a^{-2} z^2 + a^{-3} z^3 + \dots \Rightarrow (0, \overset{0}{a^{-1}}, \overset{1}{a^{-2}}, \dots)$ $u(n-1)$
 $|z| < a^{-1}$

$\frac{a'}{1-a'z} = a^{-1} z^0 + a^{-2} z^1 + a^{-3} z^2 + \dots \Rightarrow (\overset{0}{a^{-1}}, \overset{1}{a^{-2}}, \overset{2}{a^{-3}}, \dots)$ $u(n)$
 $|z| < a^{-1}$

I-C Left Shifted Sequence (a, a^{-1})

Anti-Causal

$$a^n \cdot u(-n-1) \rightarrow a^{n+1} \cdot u(-n-1) \quad \text{ID.Rng}$$

$$a^{-n} \cdot u(-n-1) \rightarrow a^{-n-1} \cdot u(-n-1) \quad \text{ID.Rng}$$

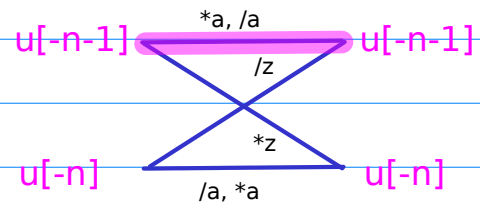

1 shifted in

*a

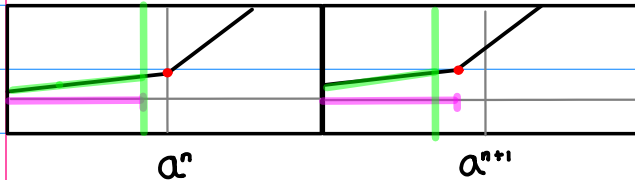

$$\frac{a^1 z^{-1}}{1 - a z^{-1}}$$

$$|z| > a^{-1}$$

$$\frac{z^{-1}}{1 - a z^{-1}}$$

$$|z| > a^{-1}$$

/a

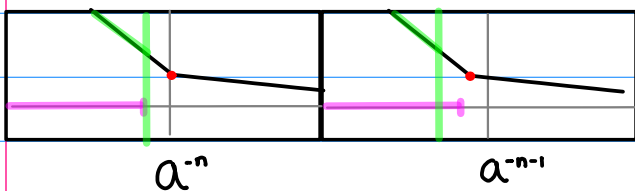

$$\frac{a z^{-1}}{1 - a z^{-1}}$$

$$|z| > a$$

$$\frac{z^{-1}}{1 - a z^{-1}}$$

$$|z| > a$$

$$\frac{a^1 z^{-1}}{1 - a z^{-1}} = \dots + a^3 z^{-3} + a^2 z^{-2} + a^1 z^{-1} \Rightarrow (\dots, \overset{-3}{a^3}, \overset{-2}{a^2}, \overset{-1}{a^1}) \quad u(-n-1)$$

$$|z| > a^{-1}$$

$$\frac{z^{-1}}{1 - a z^{-1}} = \dots + a^2 z^{-3} + a^1 z^{-2} + a^0 z^{-1} \Rightarrow (\dots, \overset{-3}{a^2}, \overset{-2}{a^1}, \overset{-1}{a^0}) \quad u(-n-1)$$

$$|z| > a^{-1}$$

$$\frac{a z^{-1}}{1 - a z^{-1}} = \dots + a^3 z^{-3} + a^2 z^{-2} + a^1 z^{-1} \Rightarrow (\dots, \overset{-3}{a^3}, \overset{-2}{a^2}, \overset{-1}{a^1}) \quad u(-n-1)$$

$$|z| > a$$

$$\frac{z^{-1}}{1 - a z^{-1}} = \dots + a^2 z^{-3} + a^1 z^{-2} + a^0 z^{-1} \Rightarrow (\dots, \overset{-3}{a^2}, \overset{-2}{a^1}, \overset{-1}{a^0}) \quad u(-n-1)$$

$$|z| > a$$

I-D Left Shifted Sequence (z^{-1}, z^{-1})

Anti-Causal

$$a^n \cdot u(-n) \rightarrow a^{n+1} \cdot u(-n-1) \text{ SHL.Rng}$$

$$a^{-n} \cdot u(-n) \rightarrow a^{-n-1} \cdot u(-n-1) \text{ SHL.Rng}$$

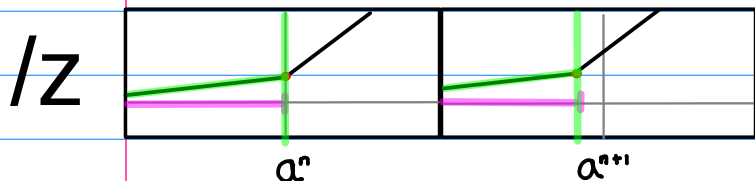
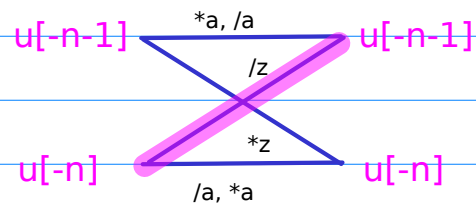

$$\frac{1}{1-a^2 z^2}$$

$|z| > a^1$

$$\frac{z^{-1}}{1-a^2 z^{-1}}$$

$|z| > a^1$

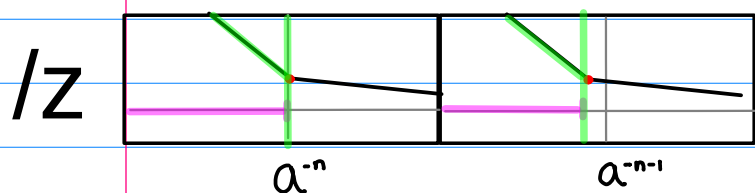

$$\frac{1}{1-a^2 z^{-1}}$$

$|z| > a^1$

$$\frac{z^{-1}}{1-a^2 z^{-1}}$$

$|z| > a^1$

$$\frac{1}{1-a^2 z^2} = \dots + a^2 z^2 + a^1 z^1 + a^0 z^0 \Rightarrow (\dots, a^2, a^1, a^0) \quad u(-n)$$

$|z| > a^1$

$$\frac{z^{-1}}{1-a^2 z^2} = \dots + a^2 z^3 + a^1 z^2 + a^0 z^1 \Rightarrow (\dots, a^1, a^0, 0) \quad u(-n-1)$$

$|z| > a^1$

$$\frac{1}{1-a^2 z^{-1}} = \dots + a^2 z^{-2} + a^1 z^{-1} + a^0 z^0 \Rightarrow (\dots, a^2, a^1, a^0) \quad u(-n)$$

$|z| > a^1$

$$\frac{z^{-1}}{1-a^2 z^{-1}} = \dots + a^2 z^{-3} + a^1 z^{-2} + a^0 z^{-1} \Rightarrow (\dots, a^1, a^0, 0) \quad u(-n-1)$$

$|z| > a^1$

2-A Right Shifted Sequence (a^{-1}, a)

Causal

$$a^n \cdot u(n-1) \rightarrow a^{n-1} \cdot u(n-1) \quad \text{ID.Rng}$$

$$a^{-n} \cdot u(n-1) \rightarrow a^{-n+1} \cdot u(n-1) \quad \text{ID.Rng}$$

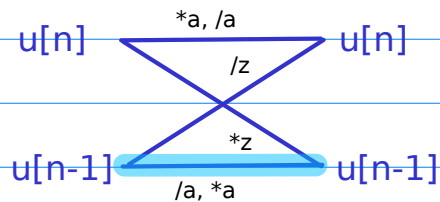

1 shifted in

$1/a$

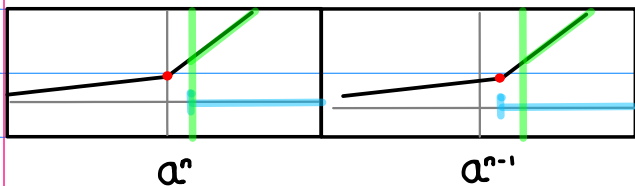

$$\frac{az}{1-az}$$

$$|z| < a^{-1}$$

$$\frac{z}{1-az}$$

$$|z| < a^{-1}$$

$*a$

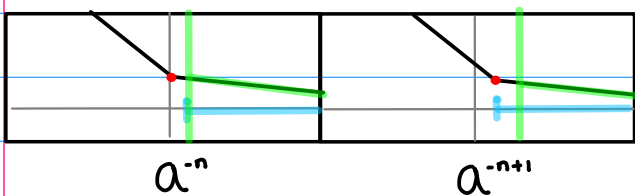

$$\frac{a^1 z}{1-a^1 z}$$

$$|z| < a$$

$$\frac{z}{1-a^1 z}$$

$$|z| < a$$

$$\frac{az}{1-az} = a^1 z^1 + a^2 z^2 + a^3 z^3 + \dots \Rightarrow (a^1, a^2, a^3, \dots) \quad u(n-1)$$

$$|z| < a^{-1}$$

$$\frac{z}{1-az} = a^0 z^1 + a^1 z^2 + a^2 z^3 + \dots \Rightarrow (a^0, a^1, a^2, \dots) \quad u(n-1)$$

$$|z| < a^{-1}$$

$$\frac{a^1 z}{1-a^1 z} = a^1 z^1 + a^2 z^2 + a^3 z^3 + \dots \Rightarrow (a^1, a^2, a^3, \dots) \quad u(n-1)$$

$$|z| < a^{-1}$$

$$\frac{z}{1-a^1 z} = a^0 z^1 + a^1 z^2 + a^2 z^3 + \dots \Rightarrow (a^0, a^1, a^2, \dots) \quad u(n-1)$$

$$|z| < a^{-1}$$

2-β Right Shfted Sequence (z, z)

Causal

$$a^n \cdot u(n) \rightarrow a^{n-1} \cdot u(n-1) \text{ SHR.Rng}$$

$$a^{-n} \cdot u(n) \rightarrow a^{-n+1} \cdot u(n-1) \text{ SHR.Rng}$$

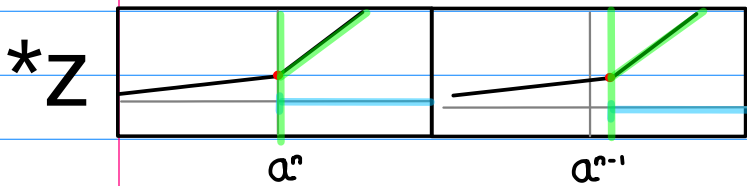
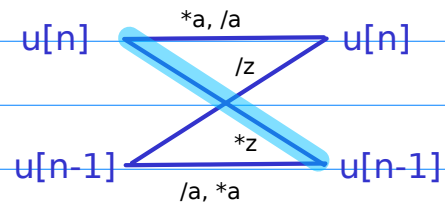

$$\frac{1}{1-az}$$

$|z| < a^{-1}$

$$\frac{z}{1-az}$$

$|z| < a^{-1}$

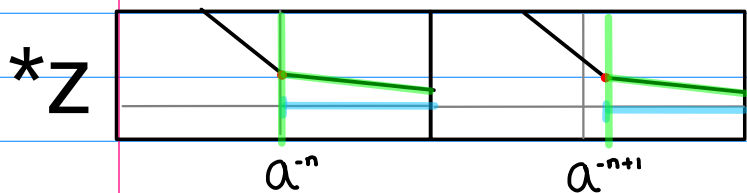

$$\frac{1}{1-a^{-1}z}$$

$|z| < a$

$$\frac{z}{1-a^{-1}z}$$

$|z| < a$

$$\frac{1}{1-az} = a^0 z^0 + a^1 z^1 + a^2 z^2 + \dots \Rightarrow (a^0, a^1, a^2, \dots) \quad u(n)$$

$$\frac{z}{1-az} = a^0 z^1 + a^1 z^2 + a^2 z^3 + \dots \Rightarrow (0, a^0, a^1, \dots) \quad u(n-1)$$

$$\frac{1}{1-a^{-1}z} = a^0 z^0 + a^{-1} z^1 + a^{-2} z^2 + \dots \Rightarrow (a^0, a^{-1}, a^{-2}, \dots) \quad u(n)$$

$$\frac{z}{1-a^{-1}z} = a^0 z^1 + a^{-1} z^2 + a^{-2} z^3 + \dots \Rightarrow (0, a^0, a^{-1}, \dots) \quad u(n-1)$$

2-c Right Shifted Sequence (a^1, a)

Anti-Causal

$$a^n \cdot u(-n) \rightarrow a^{n-1} \cdot u(-n) \quad \text{ID.Rng}$$

$$a^{-n} \cdot u(-n) \rightarrow a^{-n+1} \cdot u(-n) \quad \text{ID.Rng}$$

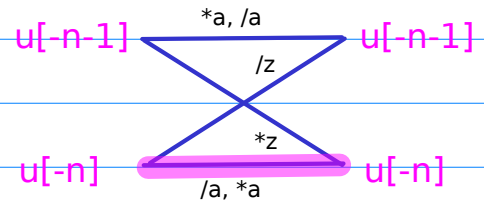

1 shifted out

/a

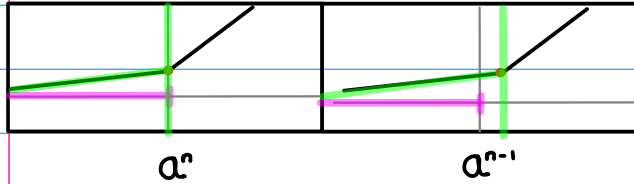

$$\frac{1}{1-a^1 z^{-1}}$$

$$|z| > a^1$$

$$\frac{a^1}{1-a^1 z^{-1}}$$

$$|z| > a^1$$

*a

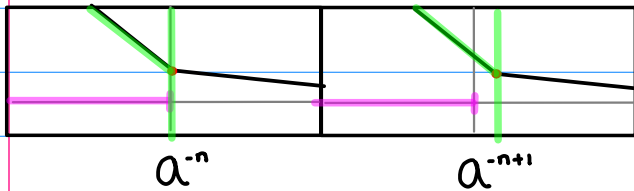

$$\frac{1}{1-a z^{-1}}$$

$$|z| > a$$

$$\frac{a}{1-a z^{-1}}$$

$$|z| > a$$

$$\frac{1}{1-a^1 z^{-1}} = \dots + a^{-2} z^{-2} + a^{-1} z^{-1} + a^0 z^0 \Rightarrow (\dots, a^{-2}, a^{-1}, a^0) \quad u(-n)$$

$$|z| > a^1$$

$$\frac{a^1}{1-a^1 z^{-1}} = \dots + a^{-2} z^{-2} + a^{-1} z^{-1} + a^0 z^0 \Rightarrow (\dots, a^{-2}, a^{-1}, a^0) \quad u(-n)$$

$$|z| > a^1$$

$$\frac{1}{1-a z^{-1}} = \dots + a^{-2} z^{-2} + a^{-1} z^{-1} + a^0 z^0 \Rightarrow (\dots, a^{-2}, a^{-1}, a^0) \quad u(-n)$$

$$|z| > a$$

$$\frac{a}{1-a z^{-1}} = \dots + a^{-2} z^{-2} + a^{-1} z^{-1} + a^0 z^0 \Rightarrow (\dots, a^{-2}, a^{-1}, a^0) \quad u(-n)$$

$$|z| > a$$

2-D Right Shifted Sequence (z, z)

Anti-Causal

$$a^n \cdot u(-n-1) \rightarrow a^{n-1} \cdot u(-n) \quad \text{SHR.Rng}$$

$$a^{-n} \cdot u(-n-1) \rightarrow a^{-n+1} \cdot u(-n) \quad \text{SHR.Rng}$$

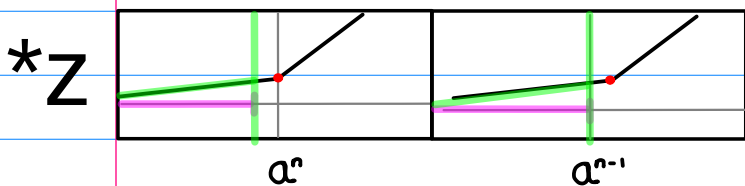
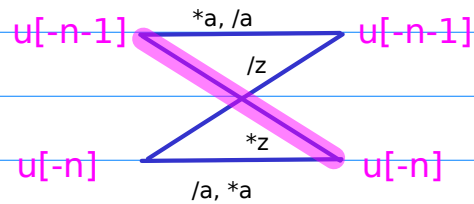

$$\frac{a^1 z^{-1}}{1 - a^1 z^{-1}} \quad |z| > a^{-1}$$

$$\frac{a^1}{1 - a^1 z^{-1}} \quad |z| > a^{-1}$$

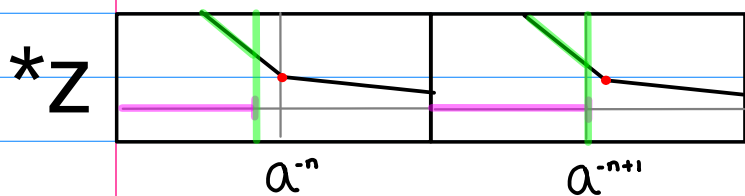

$$\frac{a z^{-1}}{1 - a z^{-1}} \quad |z| > a$$

$$\frac{a}{1 - a z^{-1}} \quad |z| > a$$

$$\frac{a^1 z^{-1}}{1 - a^1 z^{-1}} = \dots + a^3 z^{-3} + a^2 z^{-2} + a^1 z^{-1} \Rightarrow (\dots, a^3, a^2, a^1, 0) \quad u(-n-1)$$

$$\frac{a^1}{1 - a^1 z^{-1}} = \dots + a^3 z^{-3} + a^2 z^{-2} + a^1 z^{-1} \Rightarrow (\dots, a^3, a^2, a^1) \quad u(-n)$$

$$\frac{a z^{-1}}{1 - a z^{-1}} = \dots + a^3 z^{-3} + a^2 z^{-2} + a^1 z^{-1} \Rightarrow (\dots, a^3, a^2, a^1, 0) \quad u(-n-1)$$

$$\frac{a}{1 - a z^{-1}} = \dots + a^3 z^{-3} + a^2 z^{-2} + a^1 z^{-1} \Rightarrow (\dots, a^3, a^2, a^1) \quad u(-n)$$

Listing Order A

ID.Rng
SHL.Rng
SHR.Rng
ID.Rng

	Original Sequence	Shifted Sequence	Original Sequence	Shifted Sequence
ID.Rng	$a^n \cdot u(n)$	$a^{n+1} \cdot u(n)$	$a^n \cdot u(-n-1)$	$a^{n+1} \cdot u(-n-1)$
SHL.Rng	$a^n \cdot u(n-1)$	$a^{n+1} \cdot u(n)$	$a^n \cdot u(-n)$	$a^{n+1} \cdot u(-n-1)$
SHR.Rng	$a^n \cdot u(n)$	$a^{n-1} \cdot u(n-1)$	$a^n \cdot u(-n-1)$	$a^{n-1} \cdot u(-n)$
ID.Rng	$a^n \cdot u(n-1)$	$a^{n-1} \cdot u(n-1)$	$a^n \cdot u(-n)$	$a^{n-1} \cdot u(-n)$
ID.Rng	$a^{-n} \cdot u(n)$	$a^{-n-1} \cdot u(n)$	$a^{-n} \cdot u(-n-1)$	$a^{-n-1} \cdot u(-n-1)$
SHL.Rng	$a^{-n} \cdot u(n-1)$	$a^{-n-1} \cdot u(n)$	$a^{-n} \cdot u(-n)$	$a^{-n-1} \cdot u(-n-1)$
SHR.Rng	$a^{-n} \cdot u(n)$	$a^{-n+1} \cdot u(n-1)$	$a^{-n} \cdot u(-n-1)$	$a^{-n+1} \cdot u(-n)$
ID.Rng	$a^{-n} \cdot u(n-1)$	$a^{-n+1} \cdot u(n-1)$	$a^{-n} \cdot u(-n)$	$a^{-n+1} \cdot u(-n)$

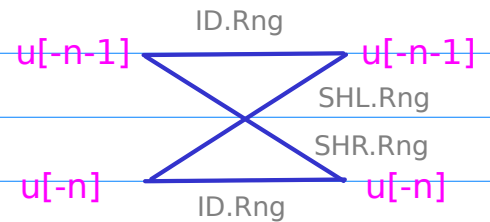
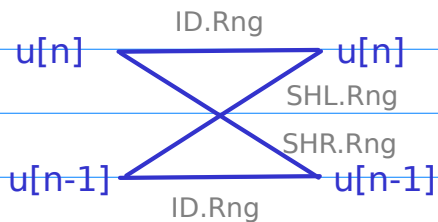

Listing Order B

ID.Rng
ID.Rng
SHL.Rng
SHR.Rng

Original Sequence

Shifted Sequence

Original Sequence

Shifted Sequence

ID.Rng

$$a^n \cdot u(n) \xrightarrow{\text{SHL}} a^{n+1} \cdot u(n)$$

$$a^n \cdot u(-n-1) \xrightarrow{\text{SHL}} a^{n+1} \cdot u(-n-1)$$

ID.Rng

$$a^n \cdot u(n-1) \xrightarrow{\text{SHR}} a^{n-1} \cdot u(n-1)$$

$$a^n \cdot u(-n) \xrightarrow{\text{SHR}} a^{n-1} \cdot u(-n)$$

SHL.Rng

$$a^n \cdot u(n-1) \xrightarrow{\text{SHL}} a^{n+1} \cdot u(n)$$

$$a^n \cdot u(-n) \xrightarrow{\text{SHL}} a^{n+1} \cdot u(-n-1)$$

SHR.Rng

$$a^n \cdot u(n) \xrightarrow{\text{SHR}} a^{n-1} \cdot u(n-1)$$

$$a^n \cdot u(-n-1) \xrightarrow{\text{SHR}} a^{n-1} \cdot u(-n)$$

ID.Rng

$$a^{-n} \cdot u(n) \xrightarrow{\text{SHL}} a^{-n-1} \cdot u(n)$$

$$a^{-n} \cdot u(-n-1) \xrightarrow{\text{SHL}} a^{-n-1} \cdot u(-n-1)$$

ID.Rng

$$a^{-n} \cdot u(n-1) \xrightarrow{\text{SHR}} a^{-n+1} \cdot u(n-1)$$

$$a^{-n} \cdot u(-n) \xrightarrow{\text{SHR}} a^{-n+1} \cdot u(-n)$$

SHL.Rng

$$a^{-n} \cdot u(n-1) \xrightarrow{\text{SHL}} a^{-n-1} \cdot u(n)$$

$$a^{-n} \cdot u(-n) \xrightarrow{\text{SHL}} a^{-n-1} \cdot u(-n-1)$$

SHR.Rng

$$a^{-n} \cdot u(n) \xrightarrow{\text{SHR}} a^{-n+1} \cdot u(n-1)$$

$$a^{-n} \cdot u(-n-1) \xrightarrow{\text{SHR}} a^{-n+1} \cdot u(-n)$$

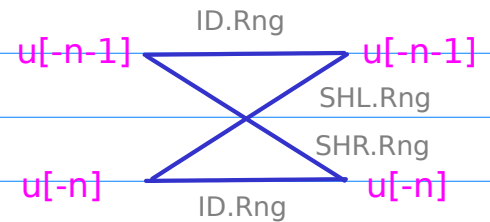
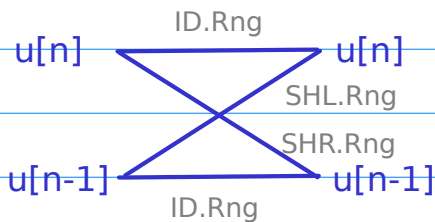

Making Shifted Sequences

making left shifted sequences

causal

the same set of slots

left shifted set of samples

anti-causal

the same set of slots

left shifted set of samples

causal

left shifted set of slots

the same set of samples

anti-causal

left shifted set of slots

the same set of samples

making right shifted sequences

causal

the same set of slots

right shifted set of samples

anti-causal

the same set of slots

right shifted set of samples

causal

right shifted set of slots

the same set of samples

anti-causal

right shifted set of slots

the same set of samples

Making Shifted Sequences

making left shifted sequences

the same set of slots

left shifted set of samples

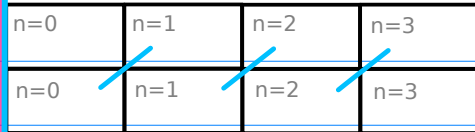

the same set of slots

left shifted set of samples

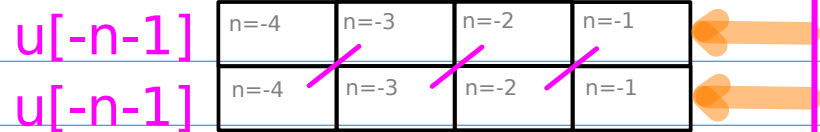

left shifted set of slots

the same set of samples

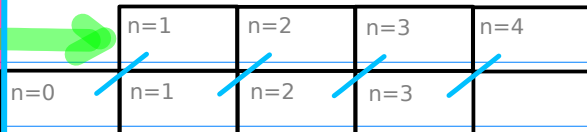

left shifted set of slots

the same set of samples

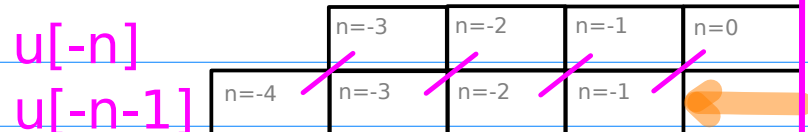

making right shifted sequences

the same set of slots

right shifted set of samples

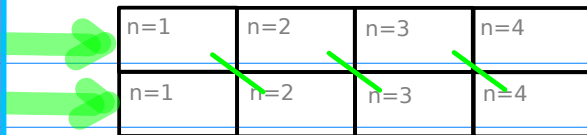

the same set of slots

right shifted set of samples

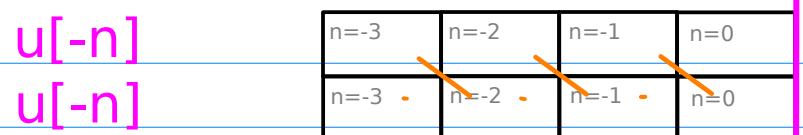

right shifted set of slots

the same set of samples

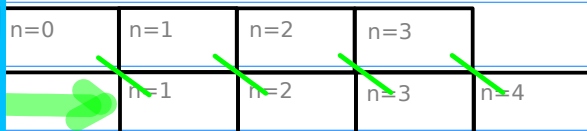

right shifted set of slots

the same set of samples

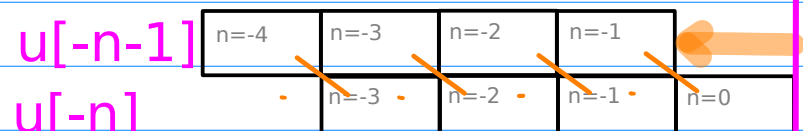

Making Shifted Sequences

making left shifted sequences

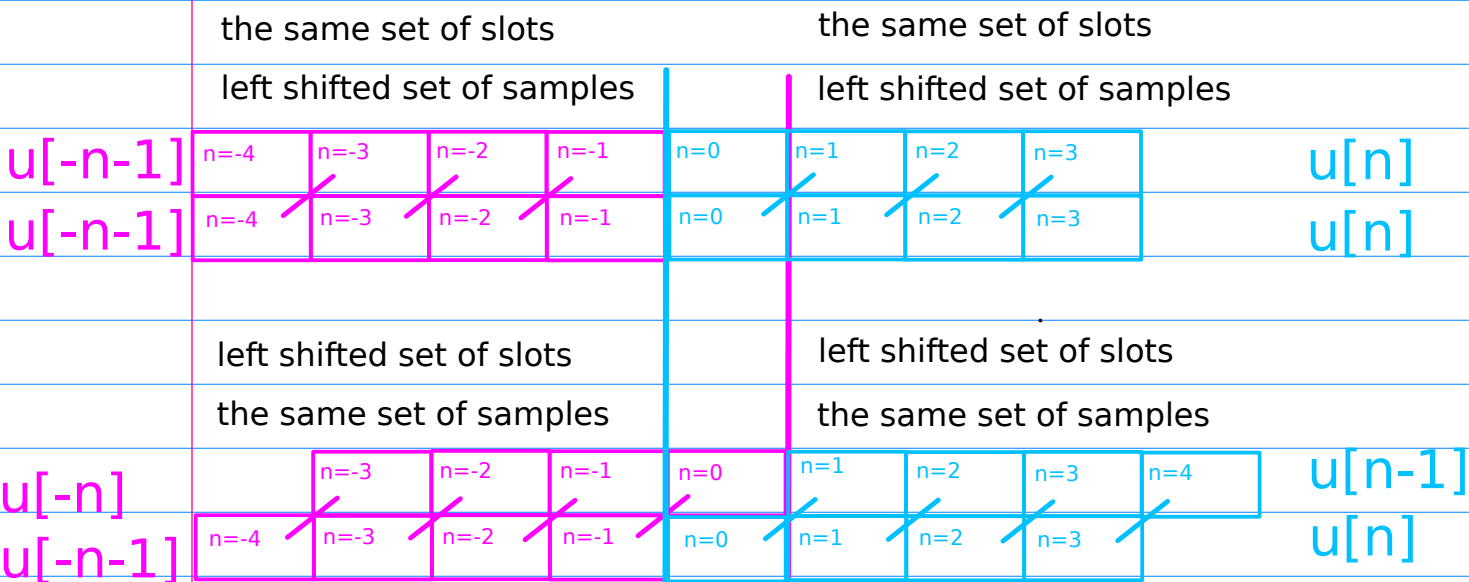

making right shifted sequences

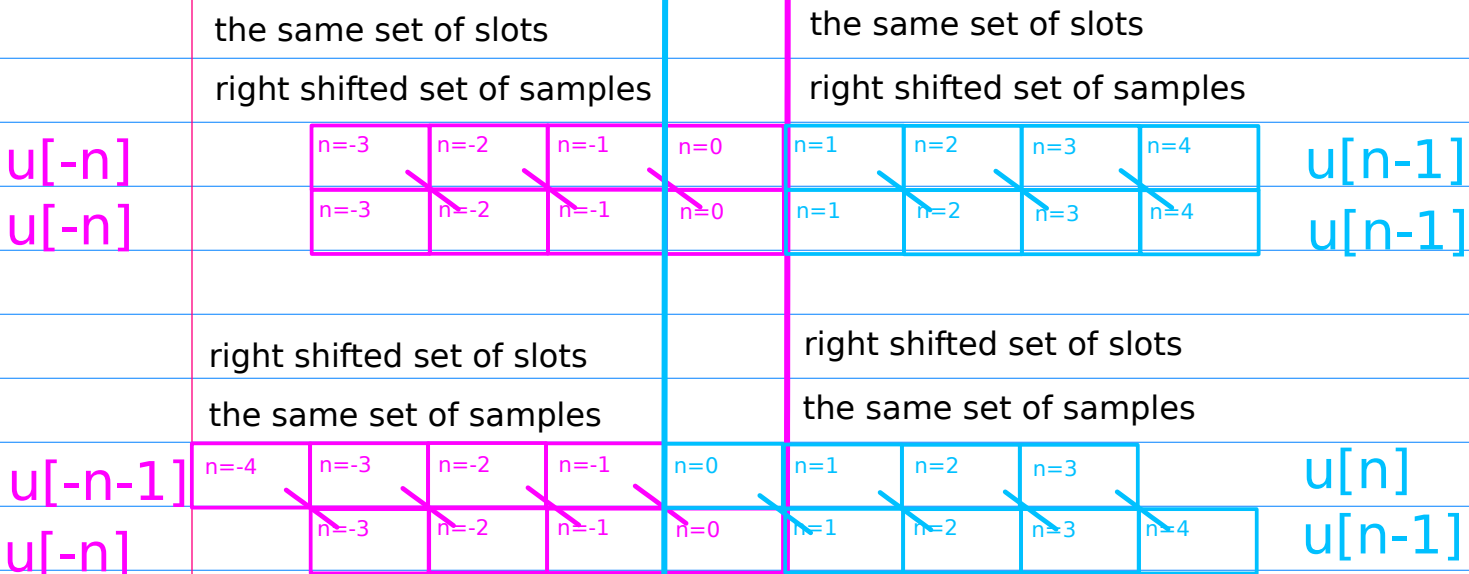

Complementary Ranges

Two Types of Left-Shifted Causal Sequences

the same fixed slots

$u[n]$	n=0	n=1	n=2	n=3
$u[n]$	n=0	n=1	n=2	n=3

left-shift samples

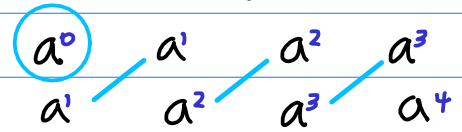

a^n	a^0	a^1	a^2	a^3
a^{n+1}	a^1	a^2	a^3	a^4

left-shifted sequence (I)



the same set of slots

left shifted set of samples

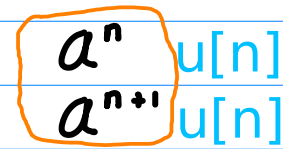

SHL.Exp

right-shift pre-slot

$u[n-1]$	n=1	n=2	n=3	n=4
$u[n]$	n=0	n=1	n=2	n=3

fixed samples

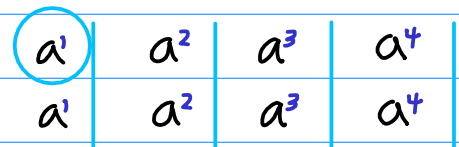

a^n	a^1	a^2	a^3	a^4
a^{n+1}	a^1	a^2	a^3	a^4

left-shifted sequence (II)



left shifted set of slots

the same set of samples

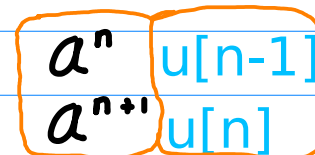

SHL.Rng & SHL.Exp

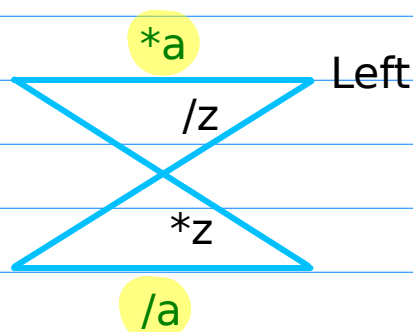

Two Types of Left-Shifted Anti-Causal Sequences

left shift both slots

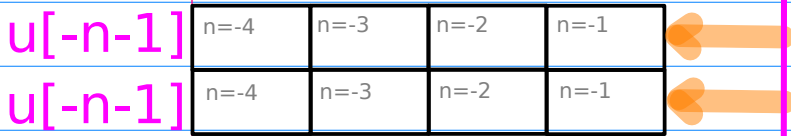

left-shift samples

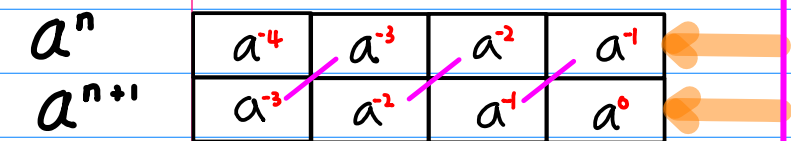
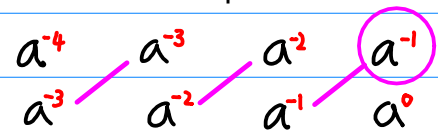

left-shifted sequence (I)

$*a$

the same set of slots

left shifted set of samples

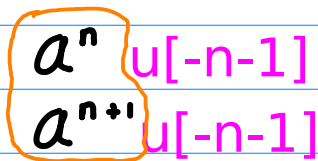

SHL.Exp

left-shift post-slot

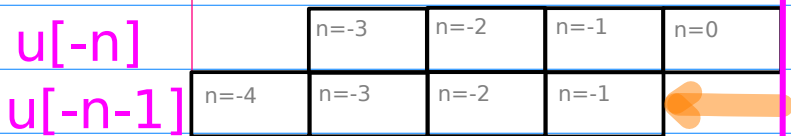

fixed samples

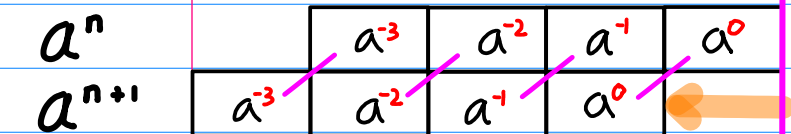
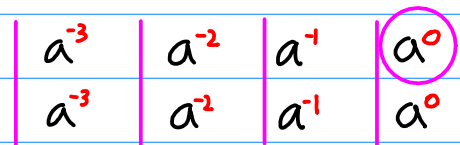

left-shifted sequence (II)

$/z$

left shifted set of slots

the same set of samples

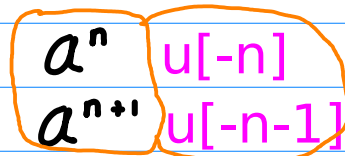

SHL.Rng & SHL.Exp

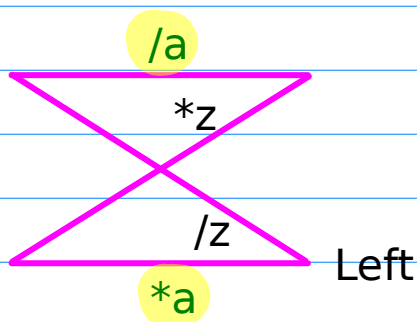

Two Types of Right-Shifted Causal Sequences

right shift both slots

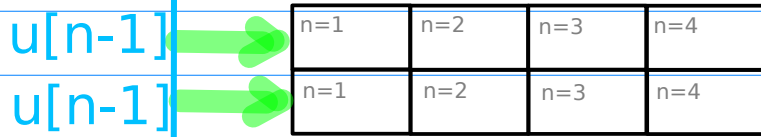

right shift post-samples

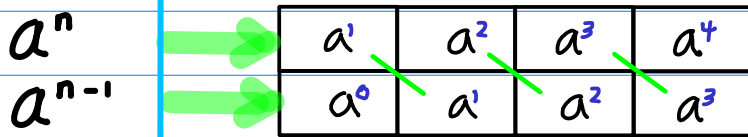
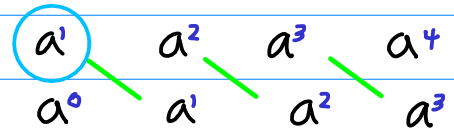

right-shifted sequence (I)

$/a$

the same set of slots
right shifted set of samples

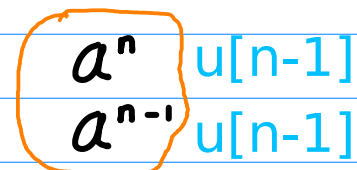

SHR.Rng

right shift post-slot

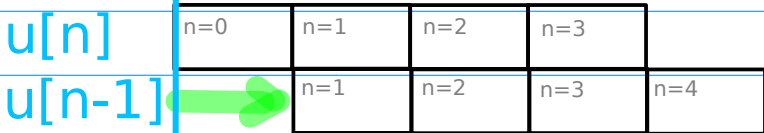

fixed samples

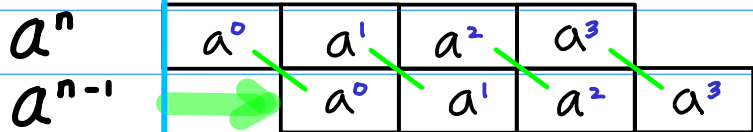
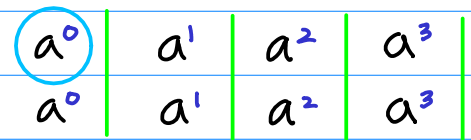

right-shifted sequence (II)

$*z$

right shifted set of slots
the same set of samples

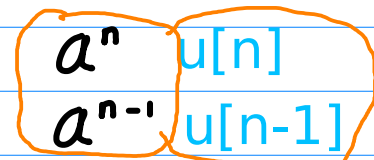

SHR.Rng & SHR.Exp

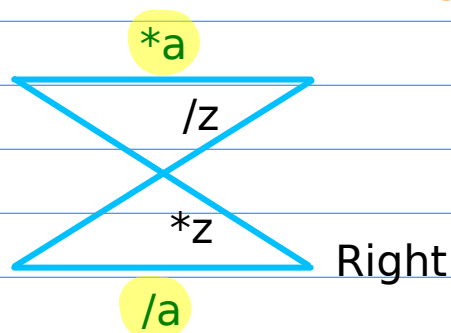

Two Types of Right-Shifted Anti-Causal Sequences

$u[-n]$
 $u[-n]$

the same fixed slots

$n=-3$	$n=-2$	$n=-1$	$n=0$
$n=-3$	$n=-2$	$n=-1$	$n=0$

right shift post-samples

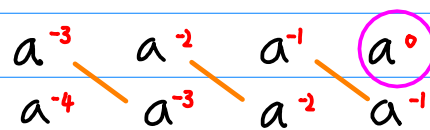

a^n
 a^{n-1}

a^{-3}	a^{-2}	a^{-1}	a^0
a^{-4}	a^{-3}	a^{-2}	a^{-1}

right-shifted sequence (I)

$/a$

the same set of slots

right shifted set of samples

$a^n u[-n]$
 $a^{n-1} u[-n]$
SHR.Rng

$u[-n-1]$
 $u[-n]$

left shift pre-slot

$n=-4$	$n=-3$	$n=-2$	$n=-1$	
	$n=-3$	$n=-2$	$n=-1$	$n=0$

fixed samples

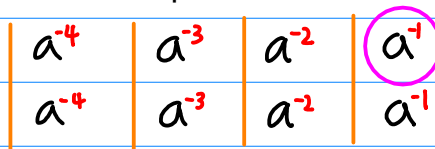

a^n
 a^{n-1}

a^{-4}	a^{-3}	a^{-2}	a^{-1}
	a^{-4}	a^{-3}	a^{-2}

right-shifted sequence (II)

$*z$

right shifted set of slots

the same set of samples

$a^n u[-n-1]$
 $a^{n-1} u[-n]$
SHR.Rng & SHR.Exp

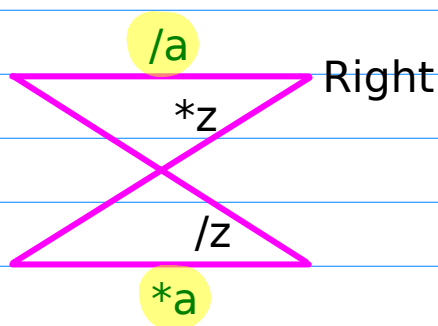

a^n

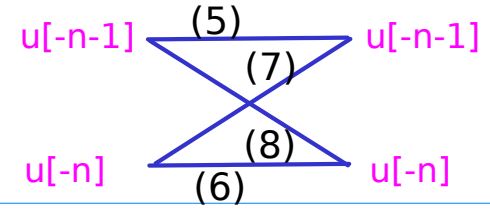
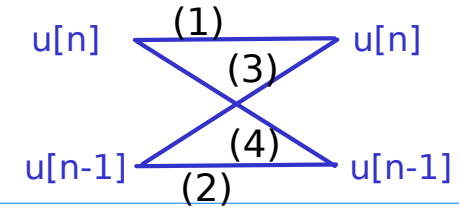
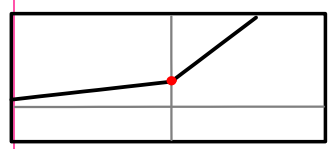

(1)	$\frac{1}{1-az} \quad z < a^{-1}$	$\frac{a}{1-az} \quad z < a^{-1}$	$a^n u(n)$ (a^0, a^1, a^2, \dots)	$a^{n+1} u(n)$ (a^1, a^2, a^3, \dots)
(2)	$-\frac{az}{1-az} \quad z < a^{-1}$	$-\frac{z}{1-az} \quad z < a^{-1}$	$-a^n u(n-1)$ $-(a^1, a^2, a^3, \dots)$	$-a^{n+1} u(n-1)$ $-(a^0, a^1, a^2, \dots)$
(3)	$-\frac{az}{1-az} \quad z < a^{-1}$	$-\frac{a}{1-az} \quad z < a^{-1}$	$-a^n u(n-1)$ $-(a^1, a^2, a^3, \dots)$	$-a^{n+1} u(n)$ $-(a^1, a^2, a^3, \dots)$
(4)	$\frac{1}{1-az} \quad z < a^{-1}$	$\frac{z}{1-az} \quad z < a^{-1}$	$a^n u(n)$ (a^0, a^1, a^2, \dots)	$a^{n+1} u(n-1)$ (a^0, a^1, a^2, \dots)
(5)	$-\frac{a^{-1}z^{-1}}{1-a^{-1}z^{-1}} \quad z > a^{-1}$	$-\frac{z^{-1}}{1-a^{-1}z^{-1}} \quad z > a^{-1}$	$-a^n u(-n-1)$ $-(\dots, \frac{1}{a^2}, \frac{1}{a^3}, \frac{1}{a^4})$	$-a^{n+1} u(-n-1)$ $-(\dots, \frac{1}{a^3}, \frac{1}{a^4}, \frac{1}{a^5})$
(6)	$\frac{1}{1-a^{-1}z^{-1}} \quad z > a^{-1}$	$\frac{a^{-1}}{1-a^{-1}z^{-1}} \quad z > a^{-1}$	$a^n u(-n)$ $(\dots, \frac{1}{a^2}, \frac{1}{a^3}, \frac{1}{a^4})$	$a^{n+1} u(-n)$ $(\dots, \frac{1}{a^3}, \frac{1}{a^4}, \frac{1}{a^5})$
(7)	$\frac{1}{1-a^{-1}z^{-1}} \quad z > a^{-1}$	$\frac{z^{-1}}{1-a^{-1}z^{-1}} \quad z > a^{-1}$	$a^n u(-n)$ $(\dots, \frac{1}{a^2}, \frac{1}{a^3}, \frac{1}{a^4})$	$a^{n+1} u(-n-1)$ $(\dots, \frac{1}{a^3}, \frac{1}{a^4}, \frac{1}{a^5})$
(8)	$-\frac{a^{-1}z^{-1}}{1-a^{-1}z^{-1}} \quad z > a^{-1}$	$-\frac{a^{-1}}{1-a^{-1}z^{-1}} \quad z > a^{-1}$	$-a^n u(-n-1)$ $-(\dots, \frac{1}{a^2}, \frac{1}{a^3}, \frac{1}{a^4})$	$-a^{n+1} u(-n)$ $-(\dots, \frac{1}{a^3}, \frac{1}{a^4}, \frac{1}{a^5})$

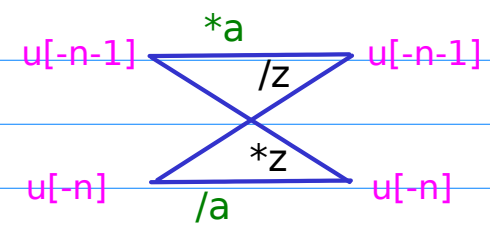
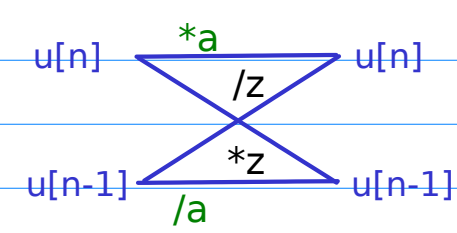

a^{-n}

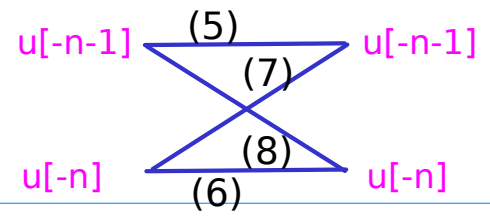
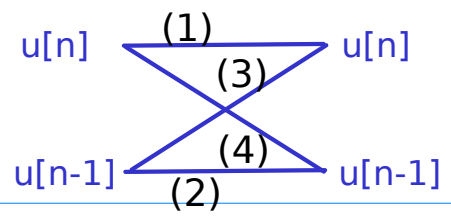
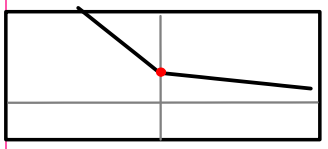

(1)	$\frac{1}{1-a^1z} \quad z < a$	$\frac{a^1}{1-a^1z} \quad z < a$	$(\frac{1}{a})^n u(n)$ $(\frac{1}{a^0}, \frac{1}{a^1}, \frac{1}{a^2}, \dots)$	$(\frac{1}{a})^{n+1} u(n)$ $(\frac{1}{a^1}, \frac{1}{a^2}, \frac{1}{a^3}, \dots)$
(2)	$-\frac{a^1z}{1-a^1z} \quad z < a$	$-\frac{z}{1-a^1z} \quad z < a$	$-(\frac{1}{a})^n u(n-1)$ $-(\frac{1}{a^1}, \frac{1}{a^2}, \frac{1}{a^3}, \dots)$	$-(\frac{1}{a})^{n+1} u(n-1)$ $-(\frac{1}{a^0}, \frac{1}{a^1}, \frac{1}{a^2}, \dots)$
(3)	$-\frac{a^1z}{1-a^1z} \quad z < a$	$-\frac{a^1}{1-a^1z} \quad z < a$	$-(\frac{1}{a})^n u(n-1)$ $-(\frac{1}{a^1}, \frac{1}{a^2}, \frac{1}{a^3}, \dots)$	$-(\frac{1}{a})^{n+1} u(n)$ $-(\frac{1}{a^1}, \frac{1}{a^2}, \frac{1}{a^3}, \dots)$
(4)	$\frac{1}{1-a^1z} \quad z < a$	$\frac{z}{1-a^1z} \quad z < a$	$(\frac{1}{a})^n u(n)$ $(\frac{1}{a^0}, \frac{1}{a^1}, \frac{1}{a^2}, \dots)$	$(\frac{1}{a})^{n-1} u(n-1)$ $(\frac{1}{a^0}, \frac{1}{a^1}, \frac{1}{a^2}, \dots)$
(5)	$-\frac{az^{-1}}{1-az^{-1}} \quad z > a$	$-\frac{z^{-1}}{1-az^{-1}} \quad z > a$	$-(\frac{1}{a})^n u(-n-1)$ $-(\dots, a^3, a^2, a^1)$	$-(\frac{1}{a})^{n+1} u(-n-1)$ $-(\dots, a^2, a^1, a^0)$
(6)	$\frac{1}{1-az^{-1}} \quad z > a$	$\frac{a}{1-az^{-1}} \quad z > a$	$(\frac{1}{a})^n u(-n)$ (\dots, a^2, a^1, a^0)	$(\frac{1}{a})^{n-1} u(-n)$ $(\dots, a^1, a^0, a^{-1})$
(7)	$\frac{1}{1-az^{-1}} \quad z > a$	$\frac{z^{-1}}{1-az^{-1}} \quad z > a$	$(\frac{1}{a})^n u(-n)$ (\dots, a^2, a^1, a^0)	$(\frac{1}{a})^{n+1} u(-n-1)$ (\dots, a^2, a^1, a^0)
(8)	$-\frac{az^{-1}}{1-az^{-1}} \quad z > a$	$-\frac{a}{1-az^{-1}} \quad z > a$	$-(\frac{1}{a})^n u(-n-1)$ $-(\dots, a^3, a^2, a^1)$	$-(\frac{1}{a})^{n-1} u(-n)$ $-(\dots, a^3, a^2, a^1)$

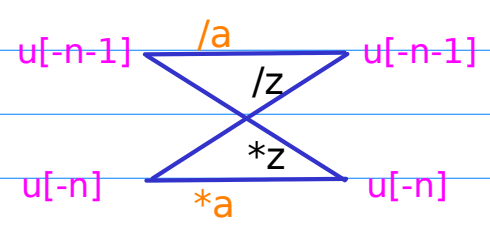
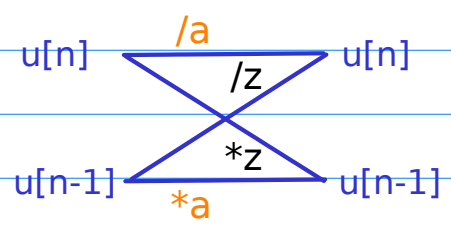

a^n

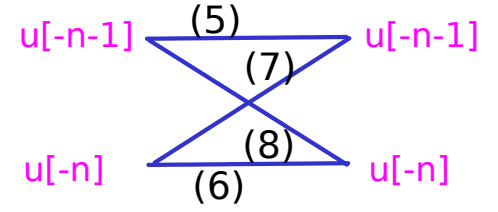
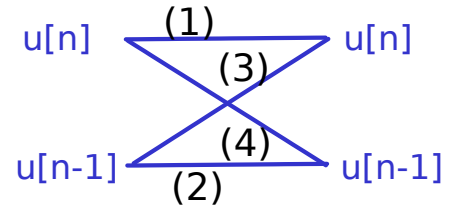
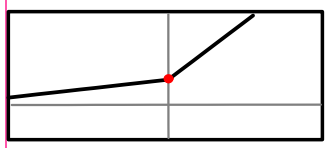

scale(a)

ID.Rng

(1)	$\frac{1}{1-az} \quad z < a^{-1}$	$\frac{a}{1-az} \quad z < a^{-1}$
(5)	$-\frac{a^nz^{-1}}{1-a^nz^{-1}} \quad z > a^{-1}$	$-\frac{z^{-1}}{1-a^nz^{-1}} \quad z > a^{-1}$

$a^n u(n)$ (a^0, a^1, a^2, \dots)	$a^{n+1} u(n)$ (a^1, a^2, a^3, \dots)
$-a^n u(-n-1)$ $-(\dots, \frac{1}{a^2}, \frac{1}{a^3}, \frac{1}{a^4})$	$-a^{n+1} u(-n-1)$ $-(\dots, \frac{1}{a^2}, \frac{1}{a^3}, \frac{1}{a^4})$

scale(1/a)

ID.Rng

(2)	$-\frac{az}{1-az} \quad z < a^{-1}$	$-\frac{z}{1-az} \quad z < a^{-1}$
(6)	$\frac{1}{1-a^nz^{-1}} \quad z > a^{-1}$	$\frac{a^{-1}}{1-a^nz^{-1}} \quad z > a^{-1}$

$-a^n u(n-1)$ $-(a^1, a^2, a^3, \dots)$	$-a^{n-1} u(n-1)$ $-(a^0, a^1, a^2, \dots)$
$a^n u(-n)$ $(\dots, \frac{1}{a^2}, \frac{1}{a^1}, \frac{1}{a^0})$	$a^{n-1} u(-n)$ $(\dots, \frac{1}{a^2}, \frac{1}{a^1}, \frac{1}{a^0})$

scale(1/z)

SHL.Rng

(3)	$-\frac{az}{1-az} \quad z < a^{-1}$	$-\frac{a}{1-az} \quad z < a^{-1}$
(7)	$\frac{1}{1-a^nz^{-1}} \quad z > a^{-1}$	$\frac{z^{-1}}{1-a^nz^{-1}} \quad z > a^{-1}$

$-a^n u(n-1)$ $-(a^1, a^2, a^3, \dots)$	$-a^{n+1} u(n)$ $-(a^1, a^2, a^3, \dots)$
$a^n u(-n)$ $(\dots, \frac{1}{a^2}, \frac{1}{a^1}, \frac{1}{a^0})$	$a^{n+1} u(-n-1)$ $(\dots, \frac{1}{a^2}, \frac{1}{a^1}, \frac{1}{a^0})$

scale(z)

SHR.Rng

(4)	$\frac{1}{1-az} \quad z < a^{-1}$	$\frac{z}{1-az} \quad z < a^{-1}$
(8)	$-\frac{a^nz^{-1}}{1-a^nz^{-1}} \quad z > a^{-1}$	$-\frac{a^{-1}}{1-a^nz^{-1}} \quad z > a^{-1}$

$a^n u(n)$ (a^0, a^1, a^2, \dots)	$a^{n-1} u(n-1)$ (a^0, a^1, a^2, \dots)
$-a^n u(-n-1)$ $-(\dots, \frac{1}{a^2}, \frac{1}{a^3}, \frac{1}{a^4})$	$-a^{n-1} u(-n)$ $-(\dots, \frac{1}{a^2}, \frac{1}{a^3}, \frac{1}{a^4})$

Original Series

Scaled Series

Original Sequence

Shifted Sequence

a^{-n}

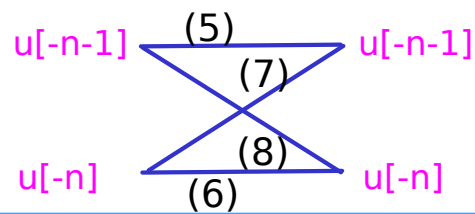
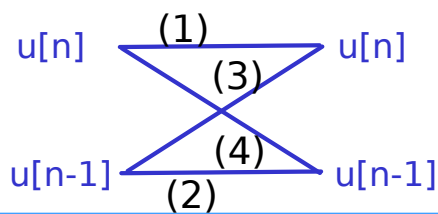
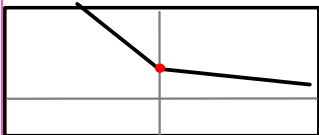

scale(1/a)

ID.Rng

(1)	$\frac{1}{1-a^{-1}z} \quad z < a$	$\frac{a^{-1}}{1-a^{-1}z} \quad z < a$
-----	-------------------------------------	--

$(\frac{1}{a})^n u(n)$ $(\frac{1}{a^0}, \frac{1}{a^1}, \frac{1}{a^2}, \dots)$	$(\frac{1}{a})^{n+1} u(n)$ $(\frac{1}{a^1}, \frac{1}{a^2}, \frac{1}{a^3}, \dots)$
--	--

(5)	$-\frac{az^{-1}}{1-az^{-1}} \quad z > a$	$-\frac{z^{-1}}{1-az^{-1}} \quad z > a$
-----	--	---

$-(\frac{1}{a})^n u(-n-1)$ $-(\dots, a^3, a^2, a^1)$	$-(\frac{1}{a})^{n+1} u(-n-1)$ $-(\dots, a^2, a^1, a^0)$
---	---

scale(a)

ID.Rng

(2)	$-\frac{a^1z}{1-a^1z} \quad z < a$	$-\frac{z}{1-a^1z} \quad z < a$
-----	--------------------------------------	-----------------------------------

$-(\frac{1}{a})^n u(n-1)$ $-(\frac{1}{a^1}, \frac{1}{a^2}, \frac{1}{a^3}, \dots)$	$-(\frac{1}{a})^{n-1} u(n-1)$ $-(\frac{1}{a^0}, \frac{1}{a^1}, \frac{1}{a^2}, \dots)$
--	--

(6)	$\frac{1}{1-a^1z^{-1}} \quad z > a$	$\frac{a}{1-a^1z^{-1}} \quad z > a$
-----	---------------------------------------	---------------------------------------

$(\frac{1}{a})^n u(-n)$ (\dots, a^2, a^1, a^0)	$(\frac{1}{a})^{n-1} u(-n)$ (\dots, a^3, a^2, a^1)
---	---

scale(1/z)

SHL.Rng

(3)	$-\frac{a^1z}{1-a^1z} \quad z < a$	$-\frac{a^1}{1-a^1z} \quad z < a$
-----	--------------------------------------	-------------------------------------

$-(\frac{1}{a})^n u(n-1)$ $-(\frac{1}{a^1}, \frac{1}{a^2}, \frac{1}{a^3}, \dots)$	$-(\frac{1}{a})^{n+1} u(n)$ $-(\frac{1}{a^1}, \frac{1}{a^2}, \frac{1}{a^3}, \dots)$
--	--

(7)	$\frac{1}{1-a^1z^{-1}} \quad z > a$	$\frac{z^{-1}}{1-a^1z^{-1}} \quad z > a$
-----	---------------------------------------	--

$(\frac{1}{a})^n u(-n)$ (\dots, a^2, a^1, a^0)	$(\frac{1}{a})^{n+1} u(-n-1)$ $(\dots, a^3, a^2, a^1, a^0)$
---	--

scale(z)

SHR.Rng

(4)	$\frac{1}{1-a^1z} \quad z < a$	$\frac{z}{1-a^1z} \quad z < a$
-----	----------------------------------	----------------------------------

$(\frac{1}{a})^n u(n)$ $(\frac{1}{a^0}, \frac{1}{a^1}, \frac{1}{a^2}, \dots)$	$(\frac{1}{a})^{n-1} u(n-1)$ $(\frac{1}{a^0}, \frac{1}{a^1}, \frac{1}{a^2}, \dots)$
--	--

(8)	$-\frac{az^{-1}}{1-az^{-1}} \quad z > a$	$-\frac{a}{1-az^{-1}} \quad z > a$
-----	--	--------------------------------------

$-(\frac{1}{a})^n u(-n-1)$ $-(\dots, a^3, a^2, a^1)$	$-(\frac{1}{a})^{n-1} u(-n)$ $-(\dots, a^3, a^2, a^1)$
---	---

Original Series

Scaled Series

Original Sequence

Shifted Sequence



