

Laurent Series and z-Transform

- Geometric Series

Applications

(A)

20210125 Mon

Copyright (c) 2016 - 2021 Young W. Lim.

Permission is granted to copy, distribute and/or modify this document under the terms of the GNU Free Documentation License, Version 1.2 or any later version published by the Free Software Foundation; with no Invariant Sections, no Front-Cover Texts, and no Back-Cover Texts. A copy of the license is included in the section entitled "GNU Free Documentation License".

Unshifted Geometric Sequences

Causal

$$\frac{1}{1 - az} \rightarrow u(n)$$

Anti-causal

$$\frac{1}{1 - az^{-1}} \rightarrow u(-n)$$

Positive Exponent

$$az, az^{-1} \rightarrow a^n$$

Negative Exponent

$$a^{-1}z, az^{-1} \rightarrow a^{-n}$$

Positive Exponent

unshifted

$$\frac{1}{1 - az} \quad |z| < a^{-1} \quad a^n u(n)$$

complementary

$$\frac{az}{1 - az} \quad |z| < a^{-1} \quad a^n u(n-1)$$

unshifted

$$-\frac{az^{-1}}{1 - az^{-1}} \quad |z| > a^{-1} \quad a^n u(-n-1)$$

complementary

$$-\frac{1}{1 - az^{-1}} \quad |z| > a^{-1} \quad a^n u(-n)$$

Negative Exponent

unshifted

$$\frac{1}{1 - a^{-1}z} \quad |z| < a \quad a^{-n} u(n)$$

complementary

$$\frac{a^{-1}z}{1 - a^{-1}z} \quad |z| < a \quad a^{-n} u(n-1)$$

unshifted

$$-\frac{az^{-1}}{1 - az^{-1}} \quad |z| > a \quad a^{-n} u(-n-1)$$

complementary

$$-\frac{1}{1 - az^{-1}} \quad |z| > a \quad a^{-n} u(-n)$$

Numbering the basic elements - (1) CR

unshifted geometric sequences

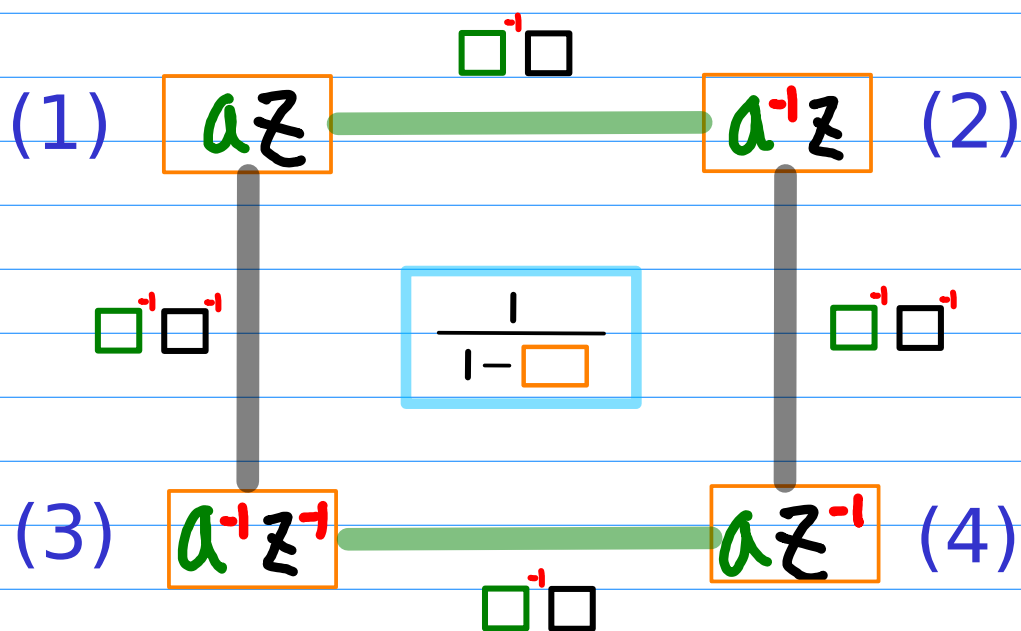

complementary geometric sequences

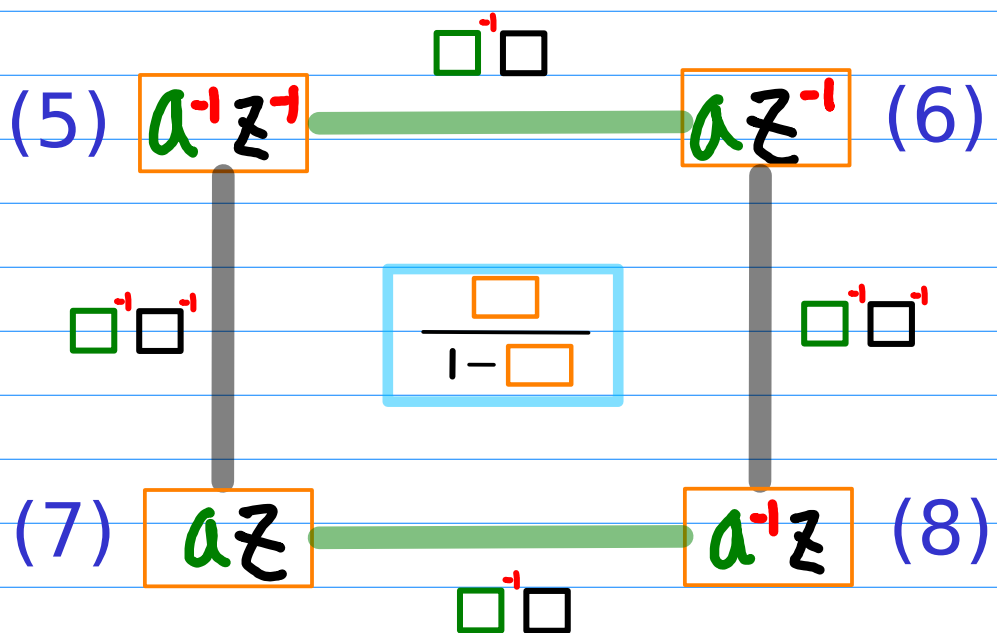

Numbering the basic elements - (2) Power

unshifted geometric sequences

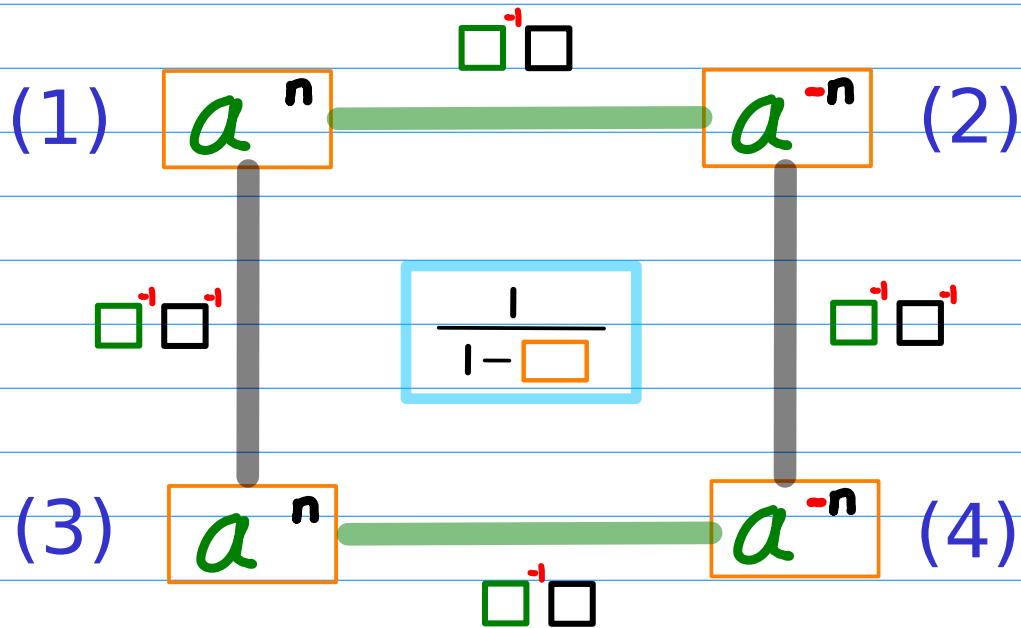

complementary geometric sequences

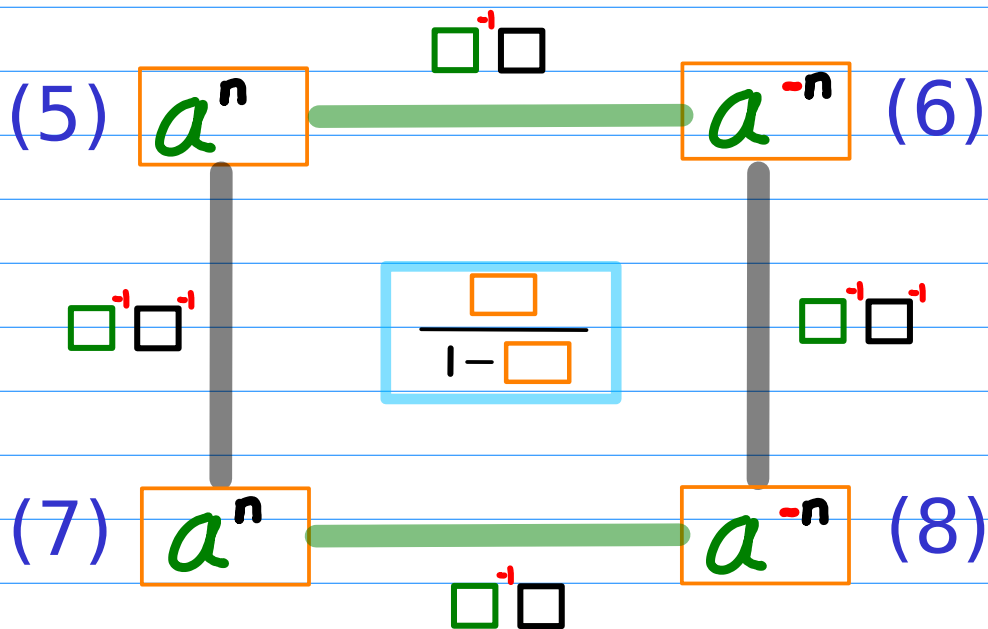

Numbering the basic elements - (3) Range

unshifted geometric sequences

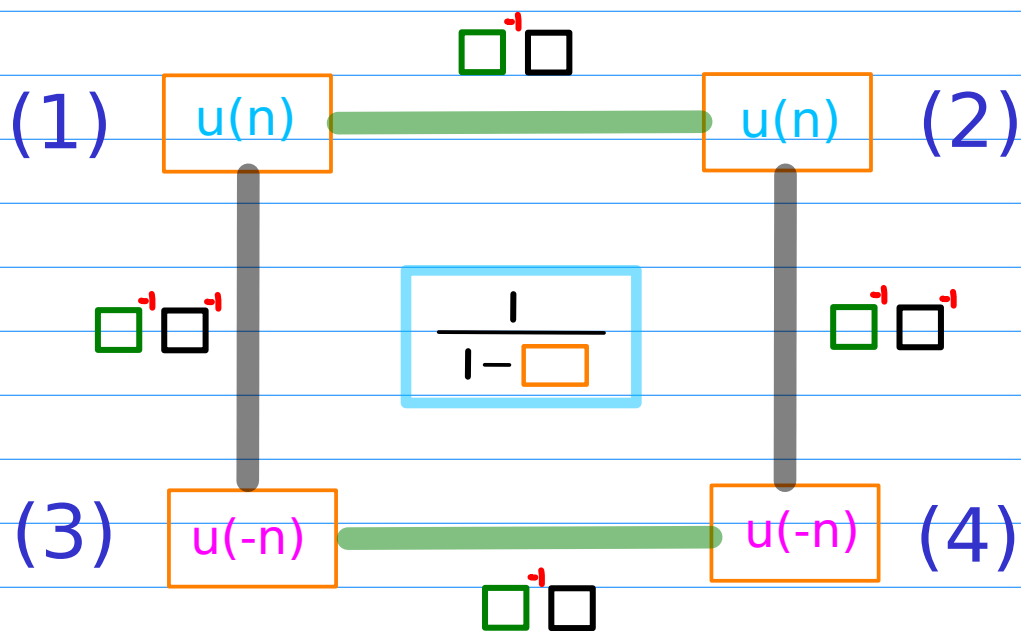

complementary geometric sequences

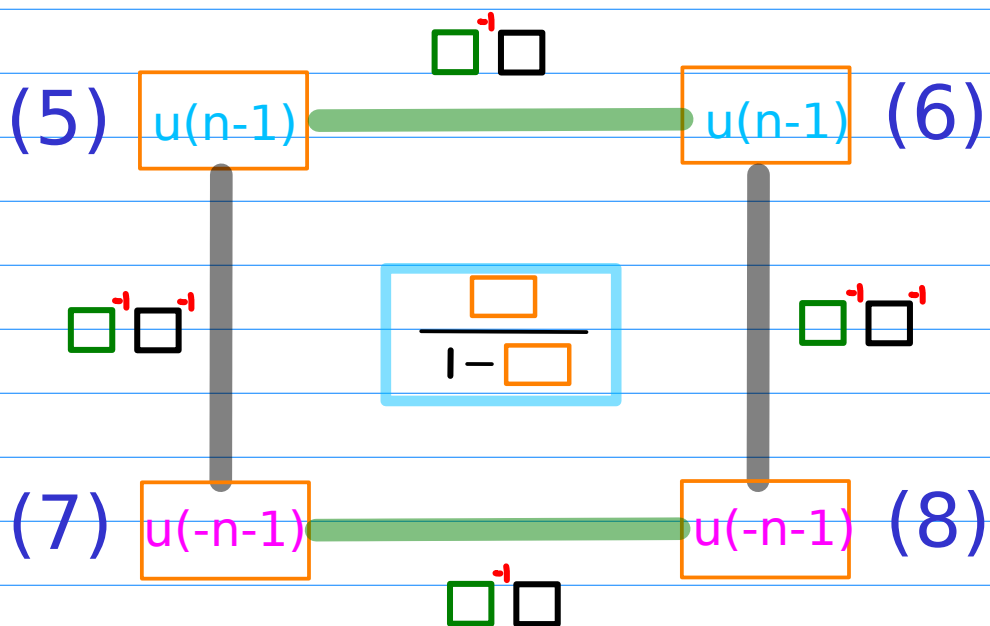

Inverse Relations

inverse power $\square^{\prime} \square$

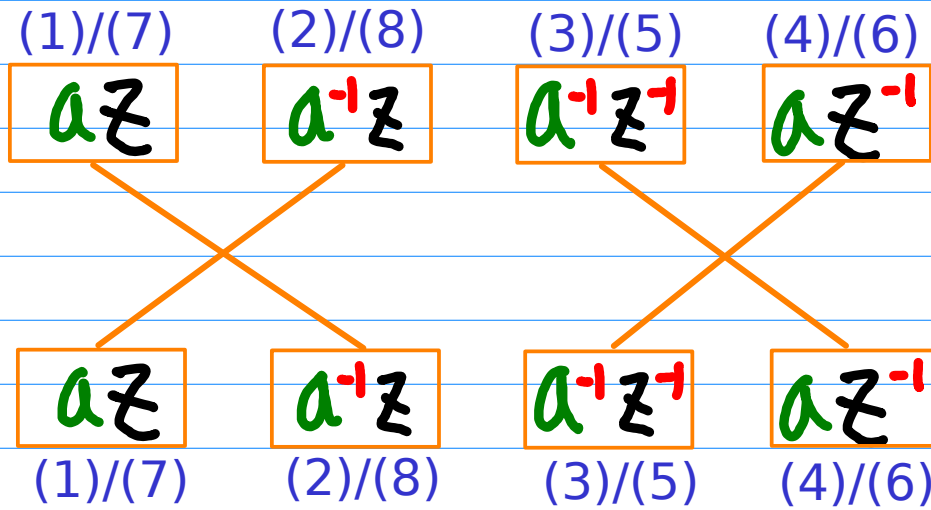

complementary $\square^{\prime} \square^{\prime}$

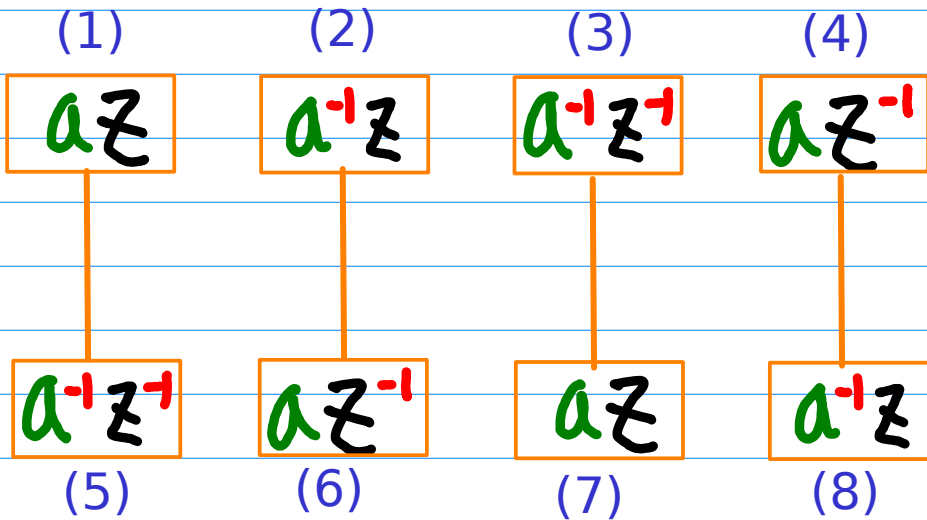

Geometric Series Form Combinations with a unit start term unshifted

(1) $a^n u(n)$

$$+ \frac{1}{1 - az}$$

(2) $a^{-n} u(n)$

$$+ \frac{1}{1 - a^{-1}z}$$

(3) $-a^n u(-n)$

$$- \frac{1}{1 - a^{-1}z^{-1}}$$

(4) $-a^{-n} u(-n)$

$$- \frac{1}{1 - az^{-1}}$$

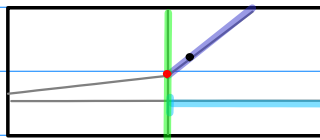

$a^n u(n)$

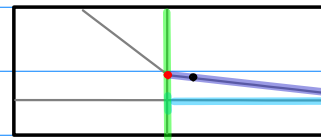

$a^{-n} u(n)$

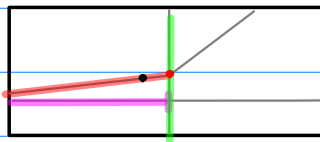

$a^n u(-n)$

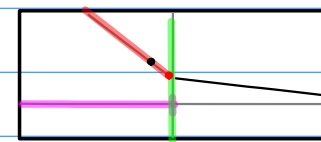

$a^{-n} u(-n)$

Geometric Series Form Combinations with a common-ratio start term **unshifted, complementary**

(5) $\frac{a^{-1}z^{-1}}{1 - a^{-1}z^{-1}} - a^n u(-n-1)$

(6) $\frac{az^{-1}}{1 - az^{-1}} - a^{-n} u(-n-1)$

(7) $\frac{az}{1 - az} + a^n u(n-1)$

(8) $\frac{a^{-1}z}{1 - a^{-1}z} + a^{-n} u(n-1)$

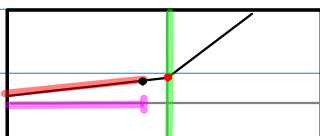

$a^n u(-n-1)$

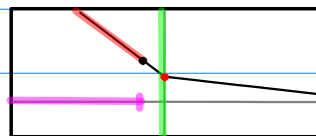

$a^{-n} u(-n-1)$

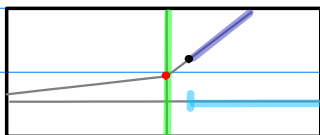

$a^n u(n-1)$

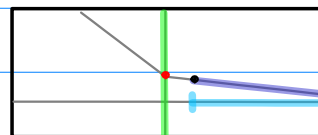

$a^{-n} u(n-1)$

Complementary Relations

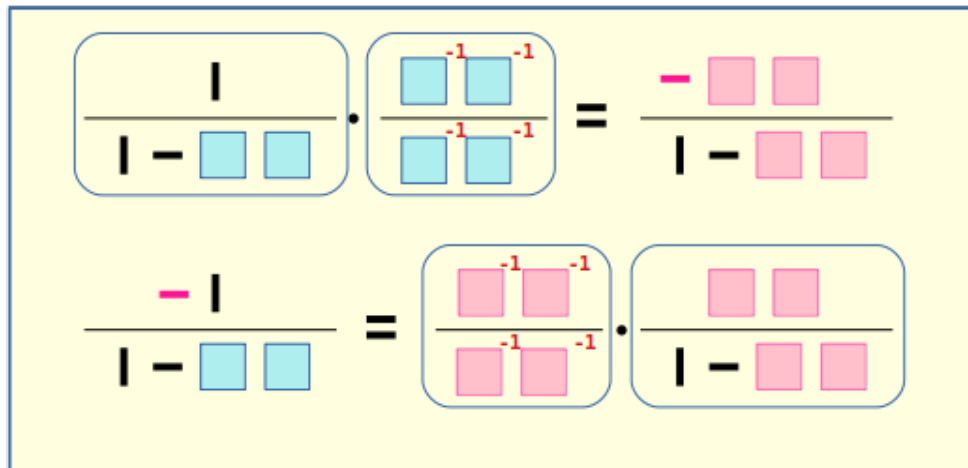
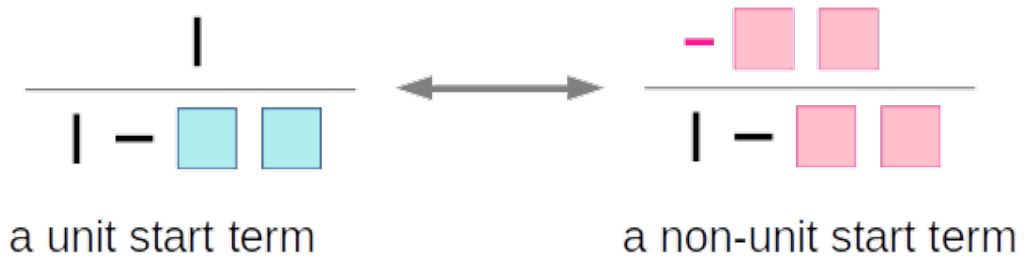
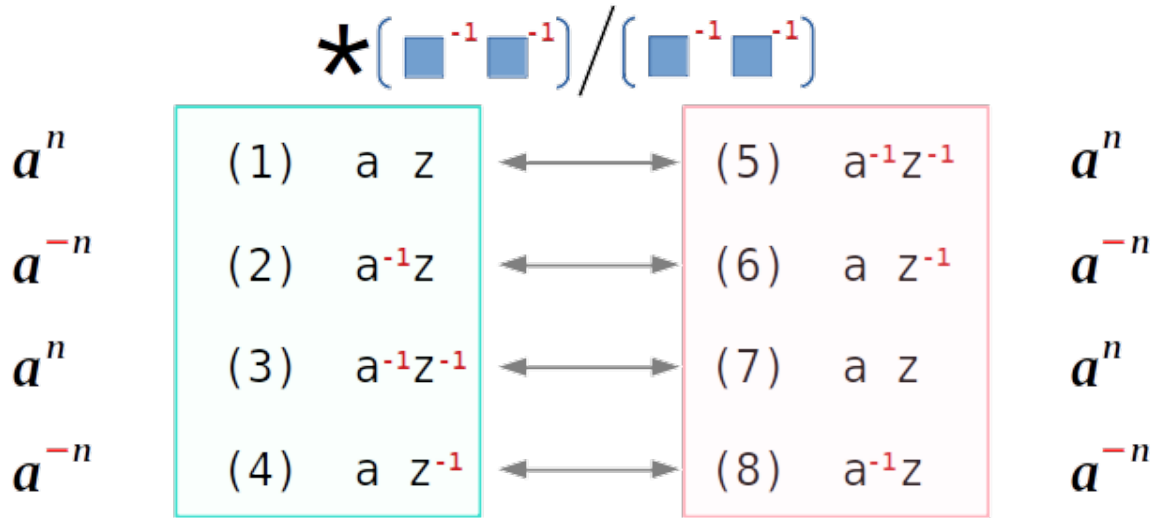

$$\star \left(\begin{array}{|c|} \hline \square^{-1} \square^{-1} \\ \hline \end{array} \right) / \left(\begin{array}{|c|} \hline \square^{-1} \square^{-1} \\ \hline \end{array} \right)$$

$$(1) \quad a^{+1} z^{+1} \quad a^{+n} \cdot u(n)$$

$$(2) \quad a^{-1} z^{+1} \quad a^{-n} \cdot u(n)$$

$$(3) \quad a^{-1} z^{-1} \quad a^{+n} \cdot u(-n)$$

$$(4) \quad a^{+1} z^{-1} \quad a^{-n} \cdot u(-n)$$

$$(5) \quad a^{-1} z^{-1} \quad a^{+n} \cdot u(-n-1)$$

$$(6) \quad a^{+1} z^{-1} \quad a^{-n} \cdot u(-n-1)$$

$$(7) \quad a^{+1} z^{+1} \quad a^{+n} \cdot u(n-1)$$

$$(8) \quad a^{-1} z^{+1} \quad a^{-n} \cdot u(n-1)$$



a unit start term

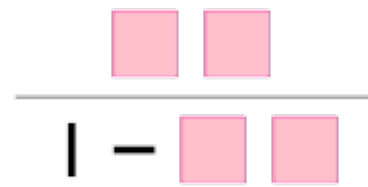

a non-unit start term

Positive Exponent	Negative Exponent
(1)	(2)
(3)	(4)
(5)	(6)
(7)	(8)

$u(n)$	(1)	(2)	Causal
$u(-n)$	(3)	(4)	Anti-Causal
$u(-n-1)$	(5)	(6)	Anti-Causal
$u(n-1)$	(7)	(8)	Causal

ranges include the origin	(1)	(2)	$u(n)$
	(3)	(4)	$u(-n)$
ranges exclude the origin	(5)	(6)	$u(-n-1)$
	(7)	(8)	$u(n-1)$

Complement Type I

$u(n)$	(1)	(2)	Causal
$u(-n)$	(3)	(4)	Anti-Causal
$u(-n-1)$	(5)	(6)	Anti-Causal
$u(n-1)$	(7)	(8)	Causal

Complement Type II

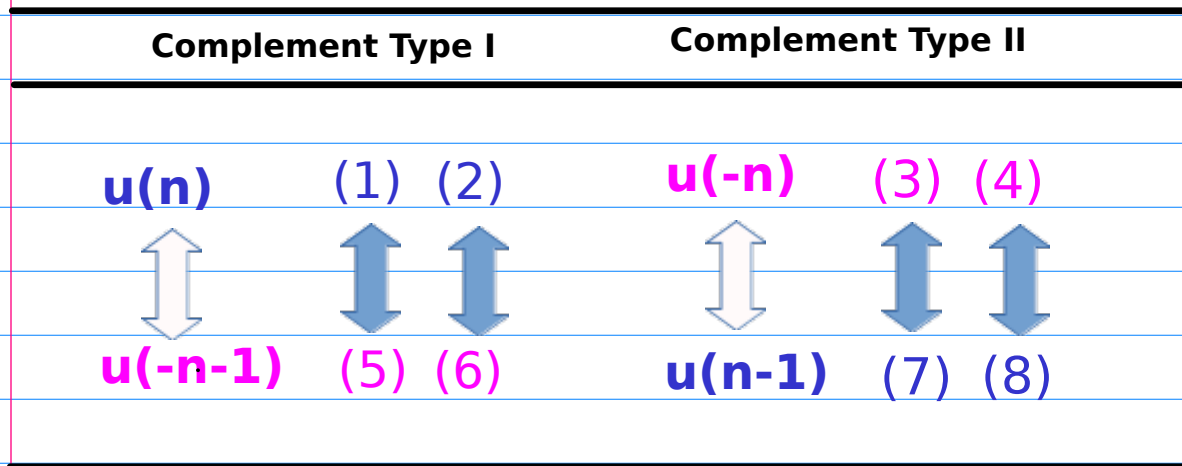

Complement Type I

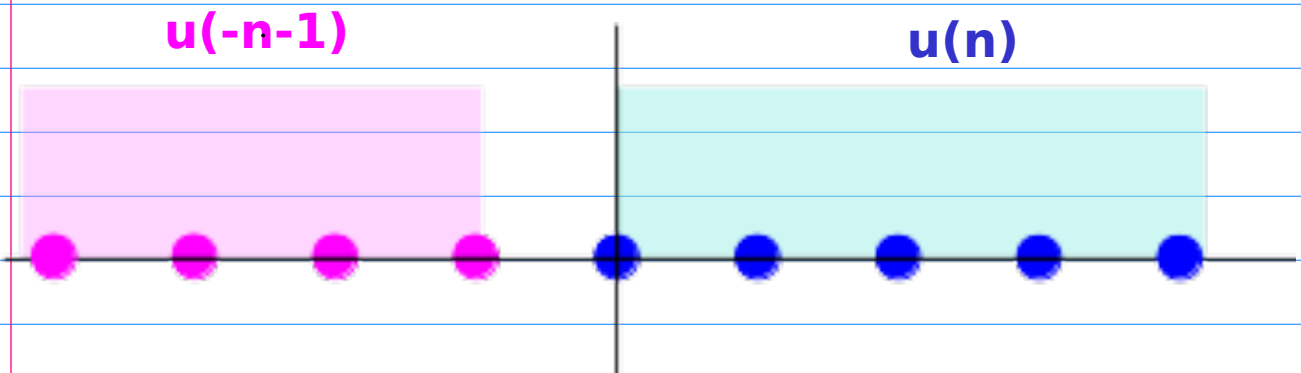

Complement Type II

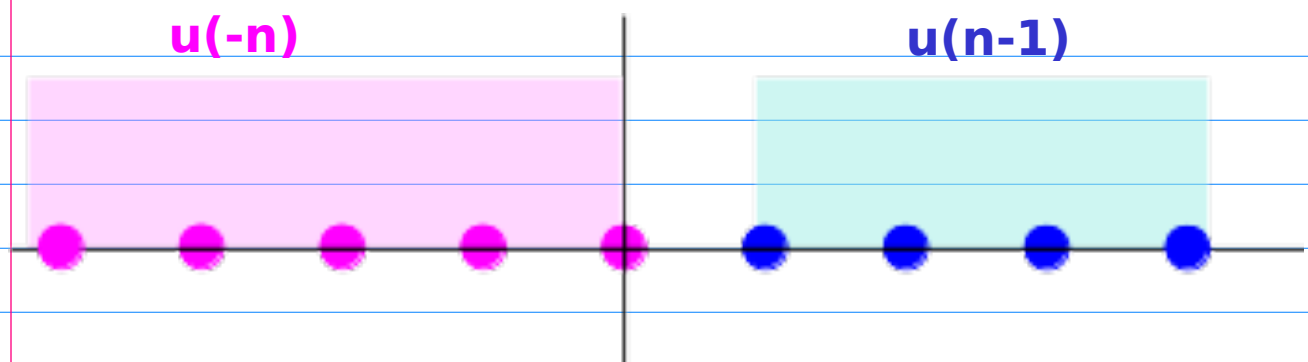

Causal	$u(n)$	(1)	(2)	butterfly pair ordering
	$u(n-1)$	(7)	(8)	
Anti-Causal	$u(-n-1)$	(5)	(6)	
	$u(-n)$	(3)	(4)	

Complement Type I	$u(n)$	(1)	(2)	complementary pair ordering
	$u(-n-1)$	(5)	(6)	
Complement Type II	$u(-n)$	(3)	(4)	
	$u(n-1)$	(7)	(8)	

		Positive Exponent	Negative Exponent	
Complement Type I	$u(n)$	(1)	(2)	complementary pair ordering
	$u(-n-1)$	(5)	(6)	
Complement Type II	$u(-n)$	(3)	(4)	
	$u(n-1)$	(7)	(8)	

Shifted Geometric Sequences

Exponent Shifting

$$* a$$

$$a^{n+1} \leftarrow a^n$$

Left Shift

$$a^{-n+1} \leftarrow a^{-n}$$

Right Shift

$$* a^{-1}$$

$$a^{n-1} \leftarrow a^n$$

Right Shift

$$a^{-n-1} \leftarrow a^{-n}$$

Left Shift

Exponent & Range Shifting

$$* z$$

$$n \leftarrow n-1$$

Right Shift

$$* z^{-1}$$

$$n \leftarrow n+1$$

Left Shift

Positive Exponent

Left Shifted

$$\frac{a}{1-az} \quad |z| < a^{-1} \quad a^{n+1} u(n)$$

Right Shifted

$$\frac{z}{1-az} \quad |z| < a^{-1} \quad a^{n-1} u(n-1)$$

Left Shifted

$$- \frac{z^{-1}}{1-az^{-1}} \quad |z| > a^{-1} \quad a^{n+1} u(-n-1)$$

Right Shifted

$$- \frac{a^{-1}}{1-az^{-1}} \quad |z| > a^{-1} \quad a^{n-1} u(-n)$$

Negative Exponent

$$\frac{a^{-1}}{1-a^{-1}z} \quad |z| < a \quad a^{-n-1} u(n)$$

$$\frac{z}{1-a^{-1}z} \quad |z| < a \quad a^{-n+1} u(n-1)$$

$$- \frac{z^{-1}}{1-az^{-1}} \quad |z| > a \quad a^{-n-1} u(-n-1)$$

$$- \frac{a}{1-az^{-1}} \quad |z| > a \quad a^{-n+1} u(-n)$$

multiplying a or a^{-1}

multiplying z or z^{-1}

Exponent Shifting

$$* a$$

$$a^{n+1} \leftarrow a^n$$

Left Shift

$$a^{-n+1} \leftarrow a^{-n}$$

Right Shift

$$* a^{-1}$$

$$a^{n-1} \leftarrow a^n$$

Right Shift

$$a^{-n-1} \leftarrow a^{-n}$$

Left Shift

Exponent & Range Shifting

$$* z$$

$$n \leftarrow n-1$$

Right Shift

$$* z^{-1}$$

$$n \leftarrow n+1$$

Left Shift

Combinations of Shifted Geometric Series (1)

Positive Exponent

/z $n \leftarrow n+1$

*z $n \leftarrow n-1$

(1) $\frac{1}{1-az} \quad |z| < a^{-1}$ $\xrightarrow{*a}$ $\frac{a}{1-az} \quad |z| < a^{-1}$ **Left Shifted**
 $a^n u(n)$ $\xrightarrow{/z}$ $a^{n+1} u(n)$

(7) $\frac{az}{1-az} \quad |z| < a^{-1}$ $\xrightarrow{/a}$ $\frac{z}{1-az} \quad |z| < a^{-1}$ **Right Shifted**
 $a^n u(n-1)$ $\xrightarrow{*z}$ $a^{n-1} u(n-1)$

(5) $-\frac{a^{-1}z^{-1}}{1-a^{-1}z^{-1}} \quad |z| > a^{-1}$ $\xrightarrow{*a}$ $-\frac{z^{-1}}{1-a^{-1}z^{-1}} \quad |z| > a^{-1}$ **Left Shifted**
 $a^n u(-n-1)$ $\xrightarrow{/z}$ $a^{n+1} u(-n-1)$

(3) $-\frac{1}{1-a^{-1}z^{-1}} \quad |z| > a^{-1}$ $\xrightarrow{/a}$ $-\frac{a^{-1}}{1-a^{-1}z^{-1}} \quad |z| > a^{-1}$ **Right Shifted**
 $a^n u(-n)$ $\xrightarrow{*z}$ $a^{n-1} u(-n)$

Causal	$u(n)$	(1)	(2)
	$u(n-1)$	(7)	(8)
Anti-Causal	$u(-n-1)$	(5)	(6)
	$u(-n)$	(3)	(4)

Combinations of Shifted Geometric Series (2)

Negative Exponent

/z $n \leftarrow n+1$

*z $n \leftarrow n-1$

(2) $\frac{1}{1-a^1z} \quad |z| < a$ $\xrightarrow{/a}$ $\frac{a^{-1}}{1-a^1z} \quad |z| < a$ **Left Shifted**
 $a^{-n} u(n)$ $\xrightarrow{/z}$ $a^{-n-1} u(n)$

(8) $\frac{a^1z}{1-a^1z} \quad |z| < a$ $\xrightarrow{*a}$ $\frac{z}{1-a^1z} \quad |z| < a$ **Right Shifted**
 $a^{-n} u(n-1)$ $\xrightarrow{*z}$ $a^{-n+1} u(n-1)$

(6) $-\frac{a^1z^{-1}}{1-a^1z^{-1}} \quad |z| > a$ $\xrightarrow{/a}$ $-\frac{z^{-1}}{1-a^1z^{-1}} \quad |z| > a$ **Left Shifted**
 $a^{-n} u(-n-1)$ $\xrightarrow{/z}$ $a^{-n-1} u(-n-1)$

(4) $-\frac{1}{1-a^1z^{-1}} \quad |z| > a$ $\xrightarrow{*a}$ $-\frac{a}{1-a^1z^{-1}} \quad |z| > a$ **Right Shifted**
 $a^{-n} u(-n)$ $\xrightarrow{*z}$ $a^{-n+1} u(-n)$

Causal	$u(n)$	(1)	(2)
	$u(n-1)$	(7)	(8)
Anti-Causal	$u(-n-1)$	(5)	(6)
	$u(-n)$	(3)	(4)

Graphs of Shifted Geometric Series (1)

butterfly pair ordering

Positive Exponent

$/z \quad n \leftarrow n+1$

$*z \quad n \leftarrow n-1$

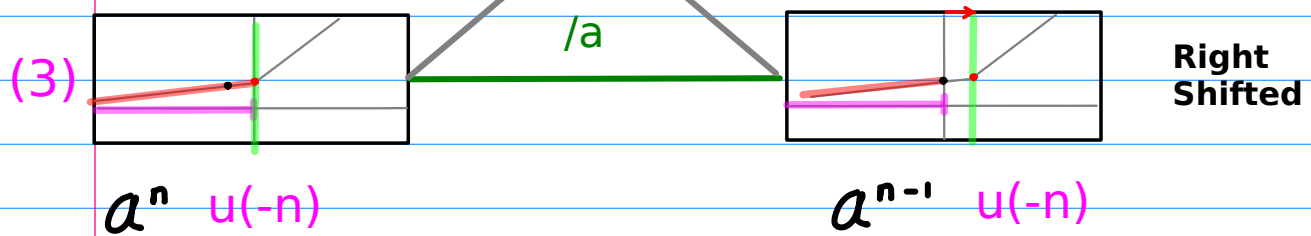
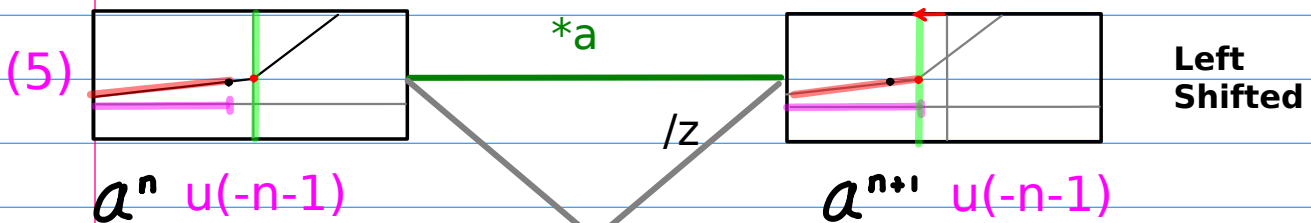
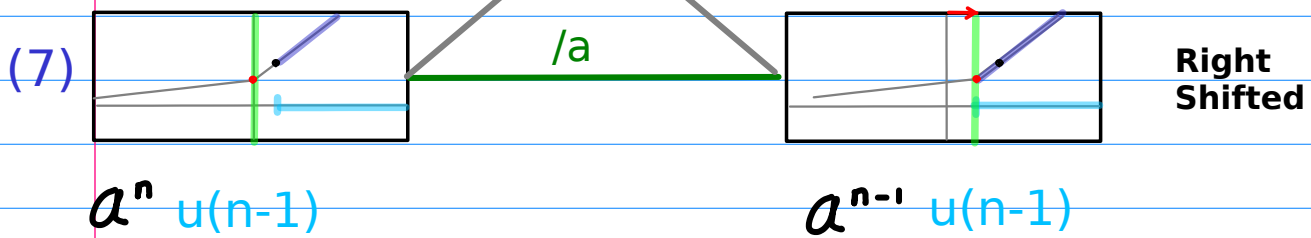
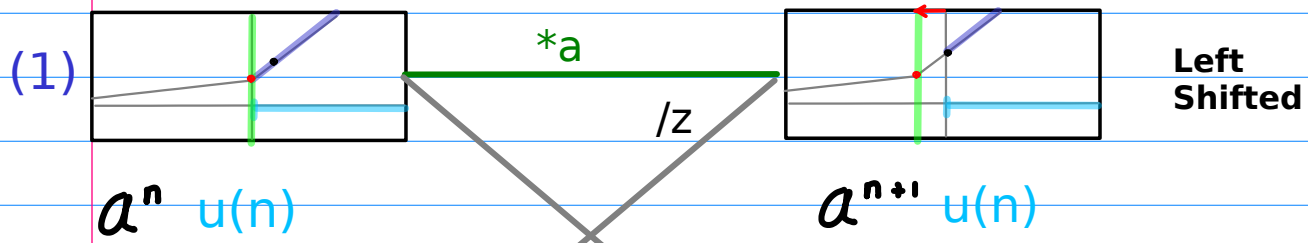

Causal	$u(n)$	(1)	(2)
	$u(n-1)$	(7)	(8)
Anti-Causal	$u(-n-1)$	(5)	(6)
	$u(-n)$	(3)	(4)

Graphs of Shifted Geometric Series (2)

butterfly pair ordering

Negative Exponent

$/z \quad n \leftarrow n+1$

$*z \quad n \leftarrow n-1$

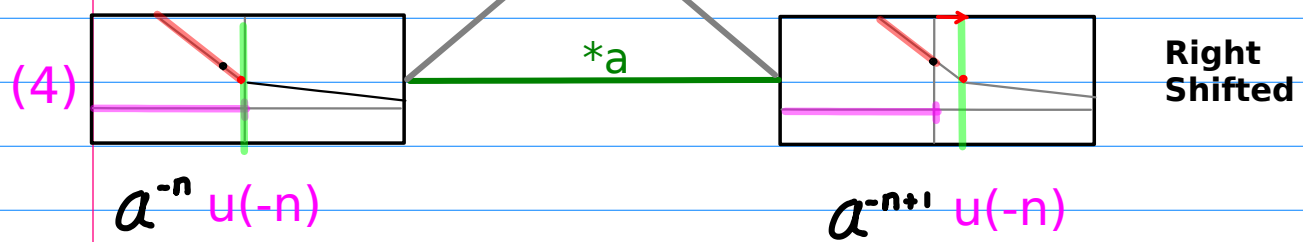
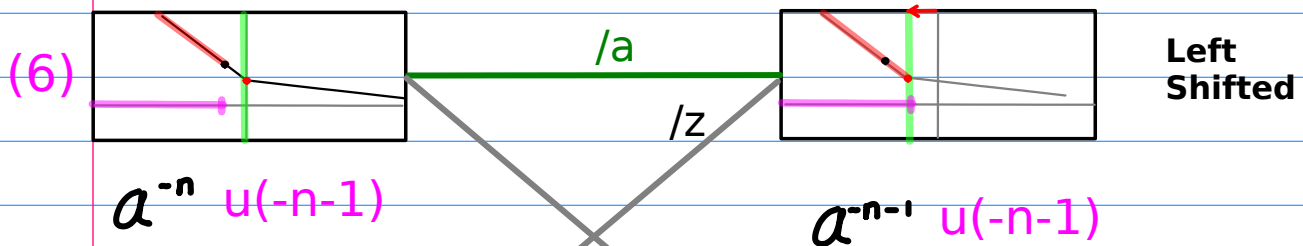
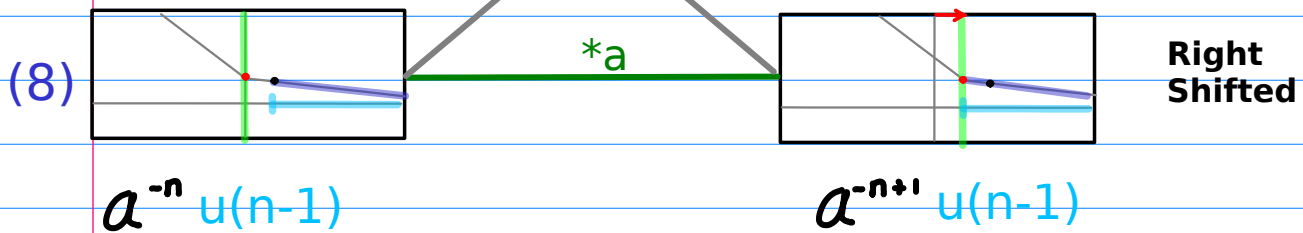
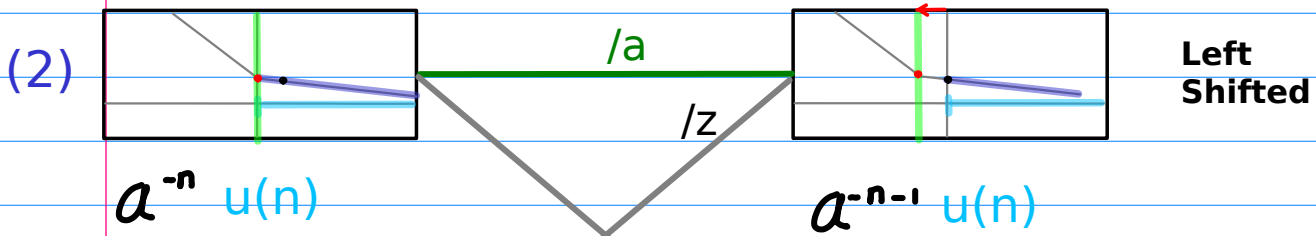

Causal	$u(n)$	(1)	(2)
	$u(n-1)$	(7)	(8)
Anti-Causal	$u(-n-1)$	(5)	(6)
	$u(-n)$	(3)	(4)

Shifting Geometric Series by $*a$ or $/a$

$$\star \left(\boxed{}^{-1} \boxed{}^{-1} \right) / \left(\boxed{}^{-1} \boxed{}^{-1} \right)$$

<p>(1) $a^{+1} z^{+1}$ $a^{+n} \cdot u(n)$ $\boxed{* a}$ $\boxed{a^{+n+1} \cdot u(n)}$</p> <p>(2) $a^{-1} z^{+1}$ $a^{-n} \cdot u(n)$ $\boxed{/ a}$ $\boxed{a^{-n-1} \cdot u(n)}$</p>	<p>(5) $a^{-1} z^{-1}$ $a^{+n} \cdot u(-n-1)$ $\boxed{* a}$ $\boxed{a^{+n+1} \cdot u(-n-1)}$</p> <p>(6) $a^{+1} z^{-1}$ $a^{-n} \cdot u(-n-1)$ $\boxed{/ a}$ $\boxed{a^{-n-1} \cdot u(-n-1)}$</p>
<p>(3) $a^{-1} z^{-1}$ $a^{+n} \cdot u(-n)$ $\boxed{/ a}$ $\boxed{a^{+n-1} \cdot u(-n)}$</p> <p>(4) $a^{+1} z^{-1}$ $a^{-n} \cdot u(-n)$ $\boxed{* a}$ $\boxed{a^{-n+1} \cdot u(-n)}$</p>	<p>(7) $a^{+1} z^{+1}$ $a^{+n} \cdot u(n-1)$ $\boxed{/ a}$ $\boxed{a^{+n-1} \cdot u(n-1)}$</p> <p>(8) $a^{-1} z^{+1}$ $a^{-n} \cdot u(n-1)$ $\boxed{* a}$ $\boxed{a^{-n+1} \cdot u(n-1)}$</p>

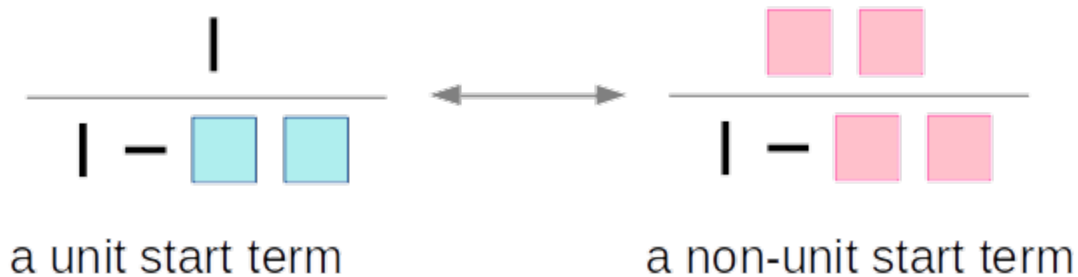

Shifting Geometric Series by $*z$ or $/z$

$$* \left(\square^{-1} \square^{-1} \right) / \left(\square^{-1} \square^{-1} \right)$$

<p>(1) $a^{+1} z^{+1}$ $a^{+n} \cdot u(n)$ $* z$ $a^{+n-1} \cdot u(n-1)$</p>	<p>(5) $a^{-1} z^{-1}$ $a^{+n} \cdot u(-n-1)$ $* z$ $a^{+n-1} \cdot u(-n)$</p>
<p>(2) $a^{-1} z^{+1}$ $a^{-n} \cdot u(n)$ $* z$ $a^{-n+1} \cdot u(n-1)$</p>	<p>(6) $a^{+1} z^{-1}$ $a^{-n} \cdot u(-n-1)$ $* z$ $a^{-n+1} \cdot u(-n)$</p>
<p>(3) $a^{-1} z^{-1}$ $a^{+n} \cdot u(-n)$ $/ z$ $a^{+n+1} \cdot u(-n-1)$</p>	<p>(7) $a^{+1} z^{+1}$ $a^{+n} \cdot u(n-1)$ $/ z$ $a^{+n+1} \cdot u(n)$</p>
<p>(4) $a^{+1} z^{-1}$ $a^{-n} \cdot u(-n)$ $/ z$ $a^{-n-1} \cdot u(-n-1)$</p>	<p>(8) $a^{-1} z^{+1}$ $a^{-n} \cdot u(n-1)$ $/ z$ $a^{-n-1} \cdot u(n)$</p>

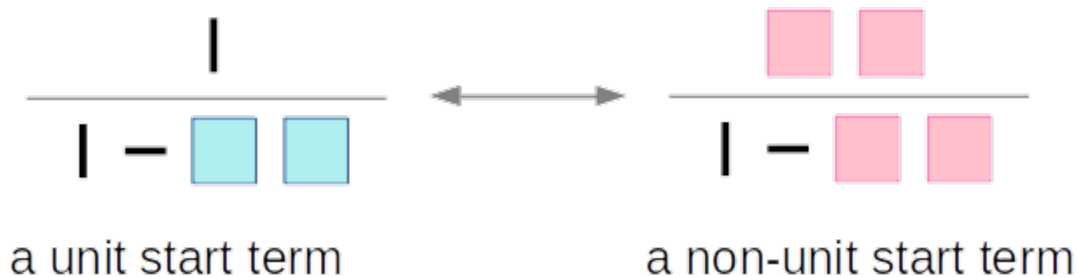

$u(n)$	(1)	(2)
$u(-n)$	(3)	(4)
$u(-n-1)$	(5)	(6)
$u(n-1)$	(7)	(8)

row
major
ordering

(1) $a^{+1} z^{+1}$ $* a$	$a^{+n} \cdot u(n)$ $a^{+n+1} \cdot u(n)$	(2) $a^{-1} z^{+1}$ $/ a$	$a^{-n} \cdot u(n)$ $a^{-n-1} \cdot u(n)$
(3) $a^{-1} z^{-1}$ $/ a$	$a^{+n} \cdot u(-n)$ $a^{+n-1} \cdot u(-n)$	(4) $a^{+1} z^{-1}$ $* a$	$a^{-n} \cdot u(-n)$ $a^{-n+1} \cdot u(-n)$
(5) $a^{-1} z^{-1}$ $* a$	$a^{+n} \cdot u(-n-1)$ $a^{+n+1} \cdot u(-n-1)$	(6) $a^{+1} z^{-1}$ $/ a$	$a^{-n} \cdot u(-n-1)$ $a^{-n-1} \cdot u(-n-1)$
(7) $a^{+1} z^{+1}$ $/ a$	$a^{+n} \cdot u(n-1)$ $a^{+n-1} \cdot u(n-1)$	(8) $a^{-1} z^{+1}$ $* a$	$a^{-n} \cdot u(n-1)$ $a^{-n+1} \cdot u(n-1)$

(1) $a^{+1} z^{+1}$ $* z$	$a^{+n} \cdot u(n)$ $a^{+n-1} \cdot u(n-1)$	(2) $a^{-1} z^{+1}$ $* z$	$a^{-n} \cdot u(n)$ $a^{-n+1} \cdot u(n-1)$
(3) $a^{-1} z^{-1}$ $/ z$	$a^{+n} \cdot u(-n)$ $a^{+n+1} \cdot u(-n-1)$	(4) $a^{+1} z^{-1}$ $/ z$	$a^{-n} \cdot u(-n)$ $a^{-n-1} \cdot u(-n-1)$
(5) $a^{-1} z^{-1}$ $* z$	$a^{+n} \cdot u(-n-1)$ $a^{+n-1} \cdot u(-n)$	(6) $a^{+1} z^{-1}$ $* z$	$a^{-n} \cdot u(-n-1)$ $a^{-n+1} \cdot u(-n)$
(7) $a^{+1} z^{+1}$ $/ z$	$a^{+n} \cdot u(n-1)$ $a^{+n+1} \cdot u(n)$	(8) $a^{-1} z^{+1}$ $/ z$	$a^{-n} \cdot u(n-1)$ $a^{-n-1} \cdot u(n)$

Causal	$u(n)$	(1)	(2)
	$u(n-1)$	(7)	(8)
Anti-Causal	$u(-n-1)$	(5)	(6)
	$u(-n)$	(3)	(4)

butterfly pair ordering

(1) $a^{+1} z^{+1}$	$a^{+n} \cdot u(n)$	(2) $a^{-1} z^{+1}$	$a^{-n} \cdot u(n)$
$* a$	$a^{+n+1} \cdot u(n)$	$/ a$	$a^{-n-1} \cdot u(n)$
(7) $a^{+1} z^{+1}$	$a^{+n} \cdot u(n-1)$	(8) $a^{-1} z^{+1}$	$a^{-n} \cdot u(n-1)$
$/ a$	$a^{+n-1} \cdot u(n-1)$	$* a$	$a^{-n+1} \cdot u(n-1)$
(5) $a^{-1} z^{-1}$	$a^{+n} \cdot u(-n-1)$	(6) $a^{+1} z^{-1}$	$a^{-n} \cdot u(-n-1)$
$* a$	$a^{+n+1} \cdot u(-n-1)$	$/ a$	$a^{-n-1} \cdot u(-n-1)$
(3) $a^{-1} z^{-1}$	$a^{+n} \cdot u(-n)$	(4) $a^{+1} z^{-1}$	$a^{-n} \cdot u(-n)$
$/ a$	$a^{+n-1} \cdot u(-n)$	$* a$	$a^{-n+1} \cdot u(-n)$

(1) $a^{+1} z^{+1}$	$a^{+n} \cdot u(n)$	(2) $a^{-1} z^{+1}$	$a^{-n} \cdot u(n)$
$* z$	$a^{+n-1} \cdot u(n-1)$	$* z$	$a^{-n+1} \cdot u(n-1)$
(7) $a^{+1} z^{+1}$	$a^{+n} \cdot u(n-1)$	(8) $a^{-1} z^{+1}$	$a^{-n} \cdot u(n-1)$
$/ z$	$a^{+n+1} \cdot u(n)$	$/ z$	$a^{-n-1} \cdot u(n)$
(5) $a^{-1} z^{-1}$	$a^{+n} \cdot u(-n-1)$	(6) $a^{+1} z^{-1}$	$a^{-n} \cdot u(-n-1)$
$* z$	$a^{+n-1} \cdot u(-n)$	$* z$	$a^{-n+1} \cdot u(-n)$
(3) $a^{-1} z^{-1}$	$a^{+n} \cdot u(-n)$	(4) $a^{+1} z^{-1}$	$a^{-n} \cdot u(-n)$
$/ z$	$a^{+n+1} \cdot u(-n-1)$	$/ z$	$a^{-n-1} \cdot u(-n-1)$

Complement Type I	$u(n)$	(1)	(2)	complementary pair ordering
	$u(-n-1)$	(5)	(6)	
Complement Type II	$u(-n)$	(3)	(4)	
	$u(n-1)$	(7)	(8)	

(1) $a^{+1} z^{+1}$	$a^{+n} \cdot u(n)$	(2) $a^{-1} z^{+1}$	$a^{-n} \cdot u(n)$
$* a$	$a^{+n+1} \cdot u(n)$	$/ a$	$a^{-n-1} \cdot u(n)$
(5) $a^{-1} z^{-1}$	$a^{+n} \cdot u(-n-1)$	(6) $a^{+1} z^{-1}$	$a^{-n} \cdot u(-n-1)$
$* a$	$a^{+n+1} \cdot u(-n-1)$	$/ a$	$a^{-n-1} \cdot u(-n-1)$
(3) $a^{-1} z^{-1}$	$a^{+n} \cdot u(-n)$	(4) $a^{+1} z^{-1}$	$a^{-n} \cdot u(-n)$
$/ a$	$a^{+n-1} \cdot u(-n)$	$* a$	$a^{-n+1} \cdot u(-n)$
(7) $a^{+1} z^{+1}$	$a^{+n} \cdot u(n-1)$	(8) $a^{-1} z^{+1}$	$a^{-n} \cdot u(n-1)$
$/ a$	$a^{+n-1} \cdot u(n-1)$	$* a$	$a^{-n+1} \cdot u(n-1)$

(1) $a^{+1} z^{+1}$	$a^{+n} \cdot u(n)$	(2) $a^{-1} z^{+1}$	$a^{-n} \cdot u(n)$
$* z$	$a^{+n-1} \cdot u(n-1)$	$* z$	$a^{-n+1} \cdot u(n-1)$
(5) $a^{-1} z^{-1}$	$a^{+n} \cdot u(-n-1)$	(6) $a^{+1} z^{-1}$	$a^{-n} \cdot u(-n-1)$
$* z$	$a^{+n-1} \cdot u(-n)$	$* z$	$a^{-n+1} \cdot u(-n)$
(3) $a^{-1} z^{-1}$	$a^{+n} \cdot u(-n)$	(4) $a^{+1} z^{-1}$	$a^{-n} \cdot u(-n)$
$/ z$	$a^{+n+1} \cdot u(-n-1)$	$/ z$	$a^{-n-1} \cdot u(-n-1)$
(7) $a^{+1} z^{+1}$	$a^{+n} \cdot u(n-1)$	(8) $a^{-1} z^{+1}$	$a^{-n} \cdot u(n-1)$
$/ z$	$a^{+n+1} \cdot u(n)$	$/ z$	$a^{-n-1} \cdot u(n)$

Shifted Geometric Series (1)

by multiplying a or a^{-1}

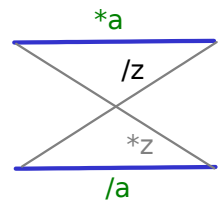

Positive Exponent

(1) ← $\frac{1}{1-az} \quad |z| < a^{-1} \quad a^n u(n) \times a \quad \frac{a}{1-az} \quad |z| < a^{-1} \quad a^{n+1} u(n)$

(7) → $\frac{az}{1-az} \quad |z| < a^{-1} \quad a^n u(n-1) \times a^{-1} \quad \frac{z}{1-az} \quad |z| < a^{-1} \quad a^{n-1} u(n-1)$

(5) ← $-\frac{a^{-1}z^{-1}}{1-a^{-1}z^{-1}} \quad |z| > a^{-1} \quad a^n u(-n-1) \times a \quad -\frac{z^{-1}}{1-a^{-1}z^{-1}} \quad |z| > a^{-1} \quad a^{n+1} u(-n-1)$

(3) → $-\frac{1}{1-a^{-1}z^{-1}} \quad |z| > a^{-1} \quad a^n u(-n) \times a^{-1} \quad -\frac{a^{-1}}{1-a^{-1}z^{-1}} \quad |z| > a^{-1} \quad a^{n-1} u(-n)$

Negative Exponent

(2) ← $\frac{1}{1-a^{-1}z} \quad |z| < a \quad a^{-n} u(n) \times a^{-1} \quad \frac{a^{-1}}{1-a^{-1}z} \quad |z| < a \quad a^{-n-1} u(n)$

(8) → $\frac{a^{-1}z}{1-a^{-1}z} \quad |z| < a \quad a^{-n} u(n-1) \times a \quad \frac{z}{1-a^{-1}z} \quad |z| < a \quad a^{-n+1} u(n-1)$

(6) ← $-\frac{az^{-1}}{1-a^{-1}z^{-1}} \quad |z| > a \quad a^{-n} u(-n-1) \times a^{-1} \quad -\frac{z^{-1}}{1-a^{-1}z^{-1}} \quad |z| > a \quad a^{-n-1} u(-n-1)$

(4) → $-\frac{1}{1-a^{-1}z^{-1}} \quad |z| > a \quad a^{-n} u(-n) \times a \quad -\frac{a}{1-a^{-1}z^{-1}} \quad |z| > a \quad a^{-n+1} u(-n)$

Shifted Geometric Series (2)

by multiplying z or z^{-1}

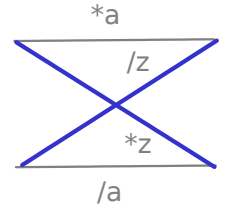

Positive Exponent

$$\begin{array}{l} (1) \\ \leftarrow \end{array} \quad \frac{az}{1-az} \quad |z| < a^{-1} \quad \begin{array}{l} n \leftarrow n+1 \\ a^n u(n-1) z^{-1} \end{array} \quad \frac{a}{1-az} \quad |z| < a^{-1} \quad a^{n+1} u(n)$$

$$\begin{array}{l} (7) \\ \Rightarrow \end{array} \quad \frac{1}{1-az} \quad |z| < a^{-1} \quad \begin{array}{l} n \leftarrow n-1 \\ a^n u(n) \times z \end{array} \quad \frac{z}{1-az} \quad |z| < a^{-1} \quad a^{n-1} u(n-1)$$

$$\begin{array}{l} (5) \\ \leftarrow \end{array} \quad -\frac{1}{1-a^{-1}z^{-1}} \quad |z| > a^{-1} \quad \begin{array}{l} n \leftarrow n+1 \\ a^n u(-n) \times z^{-1} \end{array} \quad -\frac{z^{-1}}{1-a^{-1}z^{-1}} \quad |z| > a^{-1} \quad a^{n+1} u(-n-1)$$

$$\begin{array}{l} (3) \\ \Rightarrow \end{array} \quad -\frac{a^{-1}z^{-1}}{1-a^{-1}z^{-1}} \quad |z| > a^{-1} \quad \begin{array}{l} n \leftarrow n-1 \\ a^n u(-n-1) \times z \end{array} \quad -\frac{a^{-1}}{1-a^{-1}z^{-1}} \quad |z| > a^{-1} \quad a^{n-1} u(-n)$$

Negative Exponent

$$\begin{array}{l} (2) \\ \leftarrow \end{array} \quad \frac{a^{-1}z}{1-a^{-1}z} \quad |z| < a \quad \begin{array}{l} n \leftarrow n+1 \\ a^{-n} u(n-1) \times z^{-1} \end{array} \quad \frac{a^{-1}}{1-a^{-1}z} \quad |z| < a \quad a^{-n-1} u(n)$$

$$\begin{array}{l} (8) \\ \Rightarrow \end{array} \quad \frac{1}{1-a^{-1}z} \quad |z| < a \quad \begin{array}{l} n \leftarrow n-1 \\ a^{-n} u(n) \times z \end{array} \quad \frac{z}{1-a^{-1}z} \quad |z| < a \quad a^{-n+1} u(n-1)$$

$$\begin{array}{l} (6) \\ \leftarrow \end{array} \quad -\frac{1}{1-a^{-1}z^{-1}} \quad |z| > a \quad \begin{array}{l} n \leftarrow n+1 \\ a^{-n} u(-n) \times z^{-1} \end{array} \quad -\frac{z^{-1}}{1-a^{-1}z^{-1}} \quad |z| > a \quad a^{-n-1} u(-n-1)$$

$$\begin{array}{l} (4) \\ \Rightarrow \end{array} \quad -\frac{a^{-1}z^{-1}}{1-a^{-1}z^{-1}} \quad |z| > a \quad \begin{array}{l} n \leftarrow n-1 \\ a^{-n} u(-n-1) \times z \end{array} \quad -\frac{a^{-1}}{1-a^{-1}z^{-1}} \quad |z| > a \quad a^{-n+1} u(-n)$$

Shifted Geometric Series (3)

by multiplying a or a^{-1} Assume $a > 1$

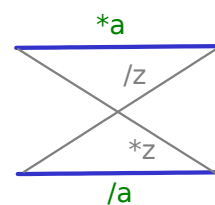

- (1) $a^n u(n)$ $*a \leftarrow$ $a^{n+1} u(n)$
- (2) $a^{-n} u(n)$ $/a \leftarrow$ $a^{-n-1} u(n)$
- (3) $a^n u(-n)$ $/a \rightarrow$ $a^{n-1} u(-n)$
- (4) $a^{-n} u(-n)$ $*a \rightarrow$ $a^{-n+1} u(-n)$
- (5) $a^n u(-n-1)$ $*a \leftarrow$ $a^{n+1} u(-n-1)$
- (6) $a^{-n} u(-n-1)$ $/a \leftarrow$ $a^{-n-1} u(-n-1)$
- (7) $a^n u(n-1)$ $/a \rightarrow$ $a^{n-1} u(n-1)$
- (8) $a^{-n} u(n-1)$ $*a \rightarrow$ $a^{-n+1} u(n-1)$

row major ordering

(1)	(2)	$*a$	$/a$	\leftarrow	\leftarrow
(3)	(4)	$/a$	$*a$	\rightarrow	\rightarrow
(5)	(6)	$*a$	$/a$	\leftarrow	\leftarrow
(7)	(8)	$/a$	$*a$	\rightarrow	\rightarrow

complementary pair ordering

(1)	(2)	$*a$	$/a$	\leftarrow	\leftarrow
(5)	(6)	$*a$	$/a$	\leftarrow	\leftarrow
(3)	(4)	$/a$	$*a$	\rightarrow	\rightarrow
(7)	(8)	$/a$	$*a$	\rightarrow	\rightarrow

butterfly pair ordering

(1)	(2)	$*a$	$/a$	\leftarrow	\leftarrow
(7)	(8)	$/a$	$*a$	\rightarrow	\rightarrow
(5)	(6)	$*a$	$/a$	\leftarrow	\leftarrow
(3)	(4)	$/a$	$*a$	\rightarrow	\rightarrow

Shifted Geometric Series (4)

by multiplying z or z^{-1} Assume $a > 1$

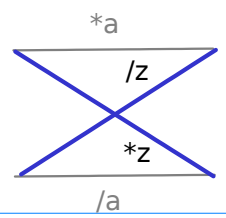

- (1) $a^n u(n)$ $*z \Rightarrow a^{n-1} u(n-1)$
- (2) $a^{-n} u(n)$ $*z \Rightarrow a^{-n+1} u(n-1)$
- (3) $a^n u(-n)$ $/z \Leftarrow a^{n+1} u(-n-1)$
- (4) $a^{-n} u(-n)$ $/z \Leftarrow a^{-n-1} u(-n-1)$
- (5) $a^n u(-n-1)$ $*z \Rightarrow a^{n-1} u(-n)$
- (6) $a^{-n} u(-n-1)$ $*z \Rightarrow a^{-n+1} u(-n)$
- (7) $a^n u(n-1)$ $/z \Leftarrow a^{n+1} u(n)$
- (8) $a^{-n} u(n-1)$ $/z \Leftarrow a^{-n-1} u(n)$

row major ordering



complementary pair ordering

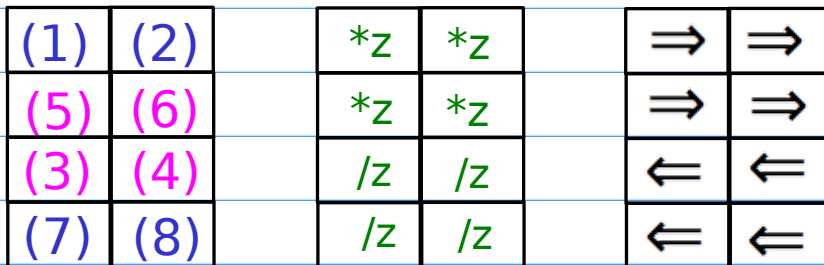

butterfly pair ordering

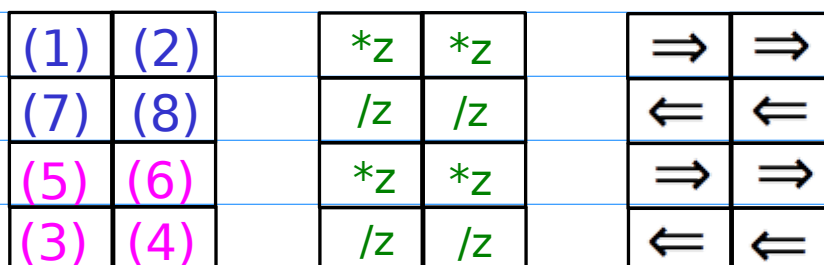

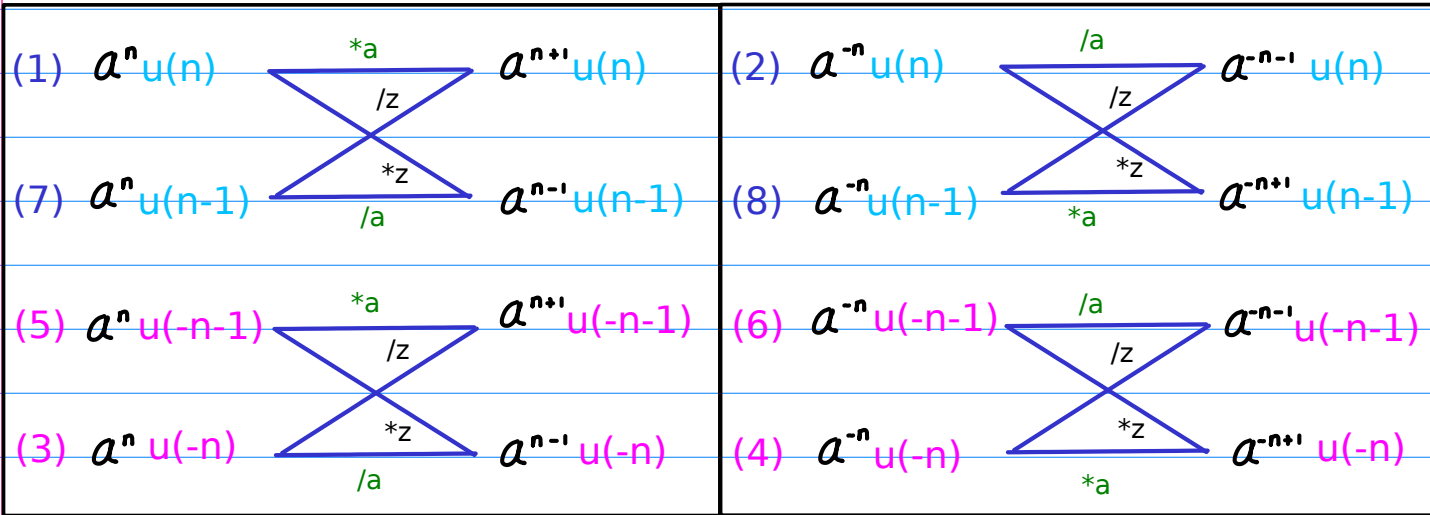

$$\leftarrow (1) *a = (7) /z \leftarrow$$

$$\leftarrow (2) /a = (8) /z \leftarrow$$

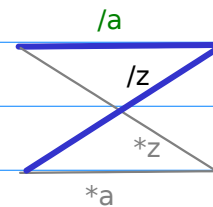
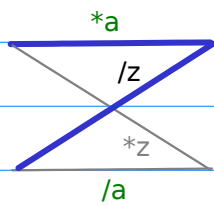

$$\Rightarrow (1) *z = (7) /a \rightarrow$$

$$\Rightarrow (2) *z = (8) *a \rightarrow$$

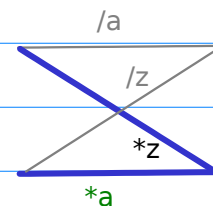
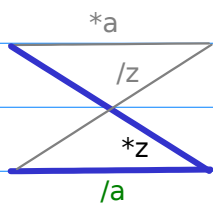

$$\leftarrow (5) *a = (3) /z \leftarrow$$

$$\leftarrow (6) /a = (4) /z \leftarrow$$

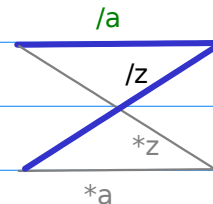
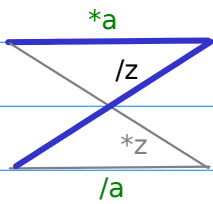

$$\Rightarrow (5) *z = (3) /a \rightarrow$$

$$\Rightarrow (6) *z = (4) *a \rightarrow$$

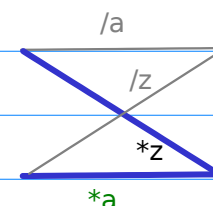
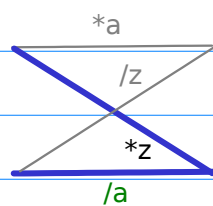

$\leftarrow (1) *a = (7) /z \rightleftarrows$
 $\Rightarrow (1) *z = (7) /a \rightarrow$
 $\rightleftarrows (3) /z = (5) *a \leftarrow$
 $\rightarrow (3) /a = (5) *z \Rightarrow$

$\leftarrow (2) /a = (8) /z \rightleftarrows$
 $\Rightarrow (2) *z = (8) *a \rightarrow$
 $\rightleftarrows (4) /z = (6) /a \leftarrow$
 $\rightarrow (4) *a = (6) *z \Rightarrow$

row major ordering

$\leftarrow (1) *a \quad *z \Rightarrow$
 $\rightarrow (3) /a \quad /z \rightleftarrows$
 $\leftarrow (5) *a \quad *z \Rightarrow$
 $\rightarrow (7) /a \quad /z \rightleftarrows$

$\leftarrow (2) /a \quad *z \Rightarrow$
 $\rightarrow (4) *a \quad /z \rightleftarrows$
 $\leftarrow (6) /a \quad *z \Rightarrow$
 $\rightarrow (8) *a \quad /z \rightleftarrows$

complementary pair ordering

$\leftarrow (1) *a \quad *z \Rightarrow$
 $\leftarrow (5) *a \quad *z \Rightarrow$
 $\rightarrow (3) /a \quad /z \rightleftarrows$
 $\rightarrow (7) /a \quad /z \rightleftarrows$

$\leftarrow (2) /a \quad *z \Rightarrow$
 $\leftarrow (6) /a \quad *z \Rightarrow$
 $\rightarrow (4) *a \quad /z \rightleftarrows$
 $\rightarrow (8) *a \quad /z \rightleftarrows$

butterfly pair ordering

$\leftarrow (1) *a \quad *z \Rightarrow$
 $\rightarrow (7) /a \quad /z \rightleftarrows$
 $\leftarrow (5) *a \quad *z \Rightarrow$
 $\rightarrow (3) /a \quad /z \rightleftarrows$

$\leftarrow (2) /a \quad *z \Rightarrow$
 $\rightarrow (8) *a \quad /z \rightleftarrows$
 $\leftarrow (6) /a \quad *z \Rightarrow$
 $\rightarrow (4) *a \quad /z \rightleftarrows$

Assume $a > 1$

- (1) $a^n u(n)$ $*a \leftarrow a^{n+1} u(n)$
 (7) $a^n u(n-1)$ $/a \rightarrow a^{n-1} u(n-1)$
 (5) $a^n u(-n-1)$ $*a \leftarrow a^{n+1} u(-n-1)$
 (3) $a^n u(-n)$ $/a \rightarrow a^{n-1} u(-n)$
 (2) $a^{-n} u(n)$ $/a \leftarrow a^{-n-1} u(n)$
 (8) $a^{-n} u(n-1)$ $*a \rightarrow a^{-n+1} u(n-1)$
 (6) $a^{-n} u(-n-1)$ $/a \leftarrow a^{-n-1} u(-n-1)$
 (4) $a^{-n} u(-n)$ $*a \rightarrow a^{-n+1} u(-n)$

$2^n u(n)$	$2^{n+1} u(n)$
$2^n u(n-1)$	$2^{n-1} u(n-1)$
$2^n u(-n-1)$	$2^{n+1} u(-n-1)$
$2^n u(-n)$	$2^{n-1} u(-n)$

$(\frac{1}{2})^{-n} u(n)$	$(\frac{1}{2})^{-n-1} u(n)$
$(\frac{1}{2})^{-n} u(n-1)$	$(\frac{1}{2})^{-n+1} u(n-1)$
$(\frac{1}{2})^{-n} u(-n-1)$	$(\frac{1}{2})^{-n-1} u(-n-1)$
$(\frac{1}{2})^{-n} u(-n)$	$(\frac{1}{2})^{-n+1} u(-n)$

$(\frac{1}{2})^n u(n)$	$(\frac{1}{2})^{n+1} u(n)$
$(\frac{1}{2})^n u(n-1)$	$(\frac{1}{2})^{n-1} u(n-1)$
$(\frac{1}{2})^n u(-n-1)$	$(\frac{1}{2})^{n+1} u(-n-1)$
$(\frac{1}{2})^n u(-n)$	$(\frac{1}{2})^{n-1} u(-n)$

$2^{-n} u(n)$	$2^{-n-1} u(n)$
$2^{-n} u(n-1)$	$2^{-n+1} u(n-1)$
$2^{-n} u(-n-1)$	$2^{-n-1} u(-n-1)$
$2^{-n} u(-n)$	$2^{-n+1} u(-n)$

Complement Type I	$u(n)$	(1)	(2)
	$u(-n-1)$	(5)	(6)
Complement Type II	$u(-n)$	(3)	(4)
	$u(n-1)$	(7)	(8)

$$\begin{array}{l} (1) \quad a z \quad \mathbf{a}^n \\ (5) \quad a^{-1} z^{-1} \quad \mathbf{a}^n \end{array}$$

$$\begin{array}{l} (2) \quad a^{-1} z \quad \mathbf{a}^{-n} \\ (6) \quad a z^{-1} \quad \mathbf{a}^{-n} \end{array}$$

$$\begin{array}{l} (3) \quad a^{-1} z^{-1} \quad \mathbf{a}^n \\ (7) \quad a z \quad \mathbf{a}^n \end{array}$$

$$\begin{array}{l} (4) \quad a z^{-1} \quad \mathbf{a}^{-n} \\ (8) \quad a^{-1} z \quad \mathbf{a}^{-n} \end{array}$$

$$\begin{array}{l} (1) \quad a z \quad \mathbf{*a} \\ (5) \quad a^{-1} z^{-1} \quad \mathbf{*a} \end{array}$$

$$\begin{array}{l} (2) \quad a^{-1} z \quad \mathbf{/a} \\ (6) \quad a z^{-1} \quad \mathbf{/a} \end{array}$$

$$\begin{array}{l} (3) \quad a^{-1} z^{-1} \quad \mathbf{/a} \\ (7) \quad a z \quad \mathbf{/a} \end{array}$$

$$\begin{array}{l} (4) \quad a z^{-1} \quad \mathbf{*a} \\ (8) \quad a^{-1} z \quad \mathbf{*a} \end{array}$$

$$\begin{array}{l} (1) \quad a z \quad \mathbf{*z} \\ (5) \quad a^{-1} z^{-1} \quad \mathbf{*z} \end{array}$$

$$\begin{array}{l} (2) \quad a^{-1} z \quad \mathbf{*z} \\ (6) \quad a z^{-1} \quad \mathbf{*z} \end{array}$$

$$\begin{array}{l} (3) \quad a^{-1} z^{-1} \quad \mathbf{/z} \\ (7) \quad a z \quad \mathbf{/z} \end{array}$$

$$\begin{array}{l} (4) \quad a z^{-1} \quad \mathbf{/z} \\ (8) \quad a^{-1} z \quad \mathbf{/z} \end{array}$$

Geometric Series Combinations

(1)

unit
non-unit

$\frac{1}{1-az}$ $ z < a^{-1}$	$a^n u(n)$
$-\frac{a^{-1}z^{-1}}{1-a^{-1}z^{-1}}$ $ z > a^{-1}$	$-a^n u(-n-1)$

(2)

$\frac{1}{1-a^{-1}z}$ $ z < a$	$(\frac{1}{a})^n u(n)$
$-\frac{az^{-1}}{1-az^{-1}}$ $ z > a$	$-(\frac{1}{a})^n u(-n-1)$

(5)

(3)

unit
non-unit

$-\frac{1}{1-a^{-1}z^{-1}}$ $ z > a^{-1}$	$-a^n u(-n)$
$\frac{az}{1-az}$ $ z < a^{-1}$	$a^n u(n-1)$

(6)

(4)

$-\frac{1}{1-az^{-1}}$ $ z > a$	$-(\frac{1}{a})^n u(-n)$
$\frac{a^{-1}z}{1-a^{-1}z}$ $ z < a$	$(\frac{1}{a})^n u(n-1)$

(7)

(8)

		Positive Exponent	Negative Exponent
Complement Type I	$u(n)$	(1)	(2)
	$u(-n-1)$	(5)	(6)
Complement Type II	$u(-n)$	(3)	(4)
	$u(n-1)$	(7)	(8)

Shifted Combinations (I) by scaling $*a$ / a

(1) $*a$

$\frac{a}{1-az}$ $ z < a^{-1}$	$a^{n+1} u(n)$
$-\frac{z^{-1}}{1-a^{-1}z^{-1}}$ $ z > a^{-1}$	$-a^{n+1} u(-n-1)$

(2) / a

$\frac{a^{-1}}{1-a^{-1}z}$ $ z < a$	$(\frac{1}{a})^{n+1} u(n)$
$-\frac{z^{-1}}{1-az^{-1}}$ $ z > a$	$-(\frac{1}{a})^{n+1} u(-n-1)$

(5) $*a$

(3) / a

$-\frac{a^{-1}}{1-a^{-1}z^{-1}}$ $ z > a^{-1}$	$-a^{n-1} u(-n)$
$\frac{z}{1-az}$ $ z < a^{-1}$	$a^{n-1} u(n-1)$

(6) / a

(4) $*a$

$-\frac{a}{1-az^{-1}}$ $ z > a$	$-(\frac{1}{a})^{n-1} u(-n)$
$\frac{z}{1-a^{-1}z}$ $ z < a$	$(\frac{1}{a})^{n-1} u(n-1)$

(7) / a

(8) $*a$

	Positive Exponent	Negative Exponent		
Complement Type I	(1) $u(n)$	(2) $u(n)$	$*a$ $u(n)$	/ a $u(n)$
	(5) $u(-n-1)$	(6) $u(-n-1)$	$*a$ $u(-n-1)$	/ a $u(-n-1)$
Complement Type II	(3) $u(-n)$	(4) $u(-n)$	/ a $u(-n)$	$*a$ $u(-n)$
	(7) $u(n-1)$	(8) $u(n-1)$	/ a $u(n-1)$	$*a$ $u(n-1)$

Shifted Combinations (II) by scaling $*z$ $/z$

(1) $*z$

$\frac{z}{1-az}$ $ z < a^{-1}$	$a^{n-1} u(n-1)$
$-\frac{a}{1-a^{-1}z^{-1}}$ $ z > a^{-1}$	$-a^{n-1} u(-n)$

(2) $*z$

$\frac{z}{1-a^{-1}z}$ $ z < a$	$(\frac{1}{a})^{n-1} u(n-1)$
$-\frac{a}{1-az^{-1}}$ $ z > a$	$-(\frac{1}{a})^{n-1} u(-n)$

(5) $*z$

(3) $/z$

$-\frac{z^{-1}}{1-a^{-1}z^{-1}}$ $ z > a^{-1}$	$-a^{n+1} u(-n-1)$
$\frac{a}{1-az}$ $ z < a^{-1}$	$a^{n+1} u(n)$

(6) $*z$

(4) $/z$

$-\frac{z^{-1}}{1-az^{-1}}$ $ z > a$	$-(\frac{1}{a})^{n+1} u(-n-1)$
$\frac{a^{-1}}{1-a^{-1}z}$ $ z < a$	$(\frac{1}{a})^{n+1} u(n)$

(7) $/z$

(8) $/z$

	Positive Exponent	Negative Exponent		
Complement Type I	(1) $u(n)$	(2) $u(n)$	$*z$ $u(n-1)$	$*z$ $u(n-1)$
	(5) $u(-n-1)$	(6) $u(-n-1)$	$*z$ $u(-n)$	$*z$ $u(-n)$
Complement Type II	(3) $u(-n)$	(4) $u(-n)$	$/z$ $u(-n-1)$	$/z$ $u(-n-1)$
	(7) $u(n-1)$	(8) $u(n-1)$	$/z$ $u(n)$	$/z$ $u(n)$

a^n

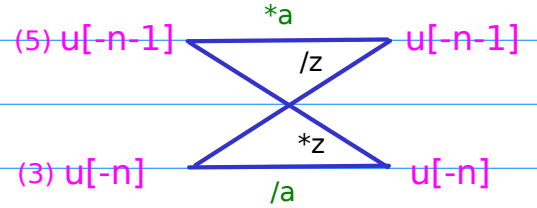
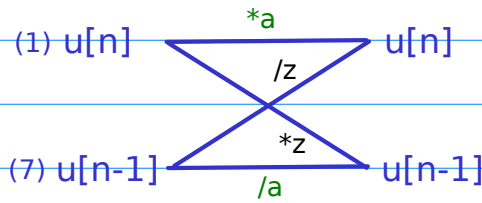
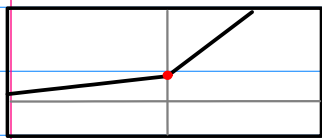

a^{-n}

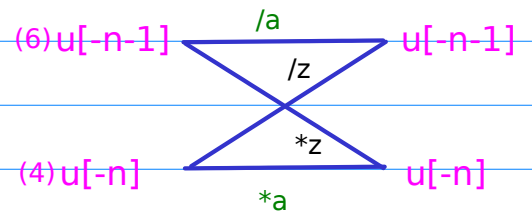
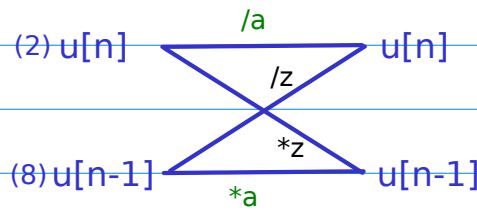
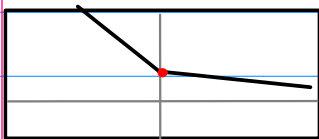

Causal	$u(n)$	(1)	(2)
	$u(n-1)$	(7)	(8)
Anti-Causal	$u(-n-1)$	(5)	(6)
	$u(-n)$	(3)	(4)

Positive Exponent	Negative Exponent
(1)	(2)
(3)	(4)
(5)	(6)
(7)	(8)

$$(1) a^n u(n) \begin{array}{c} *a \\ /z \\ *z \\ /a \end{array} a^{n+1} u(n)$$

$$(7) a^n u(n-1) \begin{array}{c} *z \\ /a \end{array} a^{n-1} u(n-1)$$

$$(5) a^n u(-n-1) \begin{array}{c} *a \\ /z \\ *z \\ /a \end{array} a^{n+1} u(-n-1)$$

$$(3) a^n u(-n) \begin{array}{c} *z \\ /a \end{array} a^{n-1} u(-n)$$

$$(2) a^{-n} u(n) \begin{array}{c} /a \\ /z \\ *z \\ *a \end{array} a^{-n-1} u(n)$$

$$(8) a^{-n} u(n-1) \begin{array}{c} *z \\ /a \end{array} a^{-n+1} u(n-1)$$

$$(6) a^{-n} u(-n-1) \begin{array}{c} /a \\ /z \\ *z \\ *a \end{array} a^{-n-1} u(-n-1)$$

$$(4) a^{-n} u(-n) \begin{array}{c} *z \\ /a \end{array} a^{-n+1} u(-n)$$

a^n

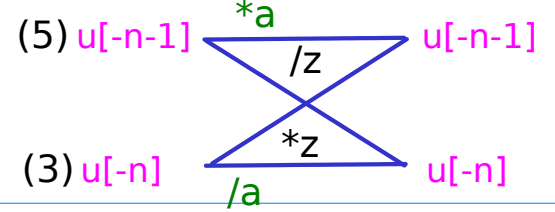
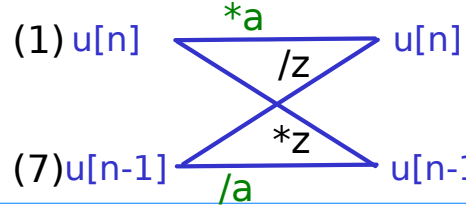
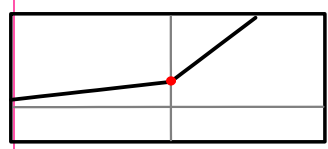

(1) $*a$

$\frac{1}{1-az} \quad z < a^{-1}$	$\frac{a}{1-az} \quad z < a^{-1}$
$\frac{az}{1-az} \quad z < a^{-1}$	$\frac{z}{1-az} \quad z < a^{-1}$

(7) $/a$

(1) $*a$

$a^n u(n)$ (a^0, a^1, a^2, \dots)	$a^{n+1} u(n)$ (a^1, a^2, a^3, \dots)
$a^n u(n-1)$ (a^1, a^2, a^3, \dots)	$a^{n-1} u(n-1)$ (a^0, a^1, a^2, \dots)

(7) $/a$

(1) $*z$

$\frac{1}{1-az} \quad z < a^{-1}$	$\frac{z}{1-az} \quad z < a^{-1}$
$\frac{az}{1-az} \quad z < a^{-1}$	$\frac{a}{1-az} \quad z < a^{-1}$

(7) $/z$

(1) $*z$

$a^n u(n)$ (a^0, a^1, a^2, \dots)	$a^{n-1} u(n-1)$ (a^0, a^1, a^2, \dots)
$a^n u(n-1)$ (a^1, a^2, a^3, \dots)	$a^{n+1} u(n)$ (a^1, a^2, a^3, \dots)

(7) $/z$

(5) $*a$

$-\frac{a'z^{-1}}{1-a'z^{-1}} \quad z > a^{-1}$	$-\frac{z^{-1}}{1-a'z^{-1}} \quad z > a^{-1}$
$-\frac{1}{1-a'z^{-1}} \quad z > a^{-1}$	$-\frac{a'}{1-a'z^{-1}} \quad z > a^{-1}$

(3) $/a$

(5) $*a$

$-a^n u(-n-1)$ $-(\dots, \frac{1}{a^2}, \frac{1}{a^2}, \frac{1}{a^1})$	$-a^{n+1} u(-n-1)$ $-(\dots, \frac{1}{a^2}, \frac{1}{a^1}, \frac{1}{a^0})$
$-a^n u(-n)$ $-(\dots, \frac{1}{a^2}, \frac{1}{a^1}, \frac{1}{a^0})$	$-a^{n-1} u(-n)$ $-(\dots, \frac{1}{a^2}, \frac{1}{a^2}, \frac{1}{a^1})$

(3) $/a$

(5) $*z$

$-\frac{a'z^{-1}}{1-a'z^{-1}} \quad z > a^{-1}$	$-\frac{a'}{1-a'z^{-1}} \quad z > a^{-1}$
$-\frac{1}{1-a'z^{-1}} \quad z > a^{-1}$	$-\frac{z^{-1}}{1-a'z^{-1}} \quad z > a^{-1}$

(3) $/z$

(5) $*z$

$-a^n u(-n-1)$ $-(\dots, \frac{1}{a^2}, \frac{1}{a^2}, \frac{1}{a^1})$	$-a^{n-1} u(-n)$ $-(\dots, \frac{1}{a^2}, \frac{1}{a^2}, \frac{1}{a^1})$
$-a^n u(-n)$ $-(\dots, \frac{1}{a^2}, \frac{1}{a^1}, \frac{1}{a^0})$	$-a^{n+1} u(-n-1)$ $-(\dots, \frac{1}{a^2}, \frac{1}{a^1}, \frac{1}{a^0})$

(3) $/z$

a^{-n}

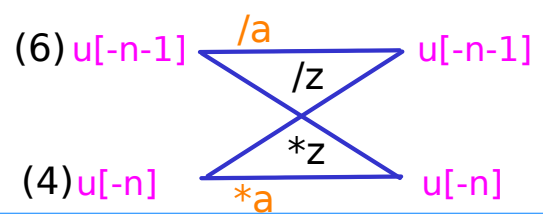
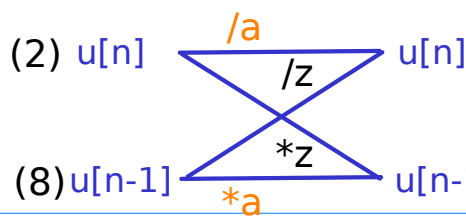
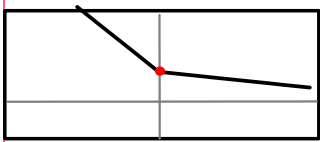

(2) $/a$

$\frac{1}{1-a^{-1}z} \quad z < a$	$\frac{a^{-1}}{1-a^{-1}z} \quad z < a$
$\frac{a^{-1}z}{1-a^{-1}z} \quad z < a$	$\frac{z}{1-a^{-1}z} \quad z < a$

(2) $/a$

$(\frac{1}{a})^n u(n)$ $(\frac{1}{a^0}, \frac{1}{a^1}, \frac{1}{a^2}, \dots)$	$(\frac{1}{a})^{n+1} u(n)$ $(\frac{1}{a^1}, \frac{1}{a^2}, \frac{1}{a^3}, \dots)$
$(\frac{1}{a})^n u(n-1)$ $(\frac{1}{a^1}, \frac{1}{a^2}, \frac{1}{a^3}, \dots)$	$(\frac{1}{a})^{n-1} u(n-1)$ $(\frac{1}{a^0}, \frac{1}{a^1}, \frac{1}{a^2}, \dots)$

(8) $*a$

(8) $*a$

(2) $*z$

$\frac{1}{1-a^{-1}z} \quad z < a$	$\frac{z}{1-a^{-1}z} \quad z < a$
$\frac{a^{-1}z}{1-a^{-1}z} \quad z < a$	$\frac{a^{-1}}{1-a^{-1}z} \quad z < a$

(2) $*z$

$(\frac{1}{a})^n u(n)$ $(\frac{1}{a^0}, \frac{1}{a^1}, \frac{1}{a^2}, \dots)$	$(\frac{1}{a})^{n-1} u(n-1)$ $(\frac{1}{a^2}, \frac{1}{a^1}, \frac{1}{a^3}, \dots)$
$(\frac{1}{a})^n u(n-1)$ $(\frac{1}{a^1}, \frac{1}{a^2}, \frac{1}{a^3}, \dots)$	$(\frac{1}{a})^{n+1} u(n)$ $(\frac{1}{a^1}, \frac{1}{a^2}, \frac{1}{a^3}, \dots)$

(8) $/z$

(8) $/z$

(6) $/a$

$-\frac{az^{-1}}{1-az^{-1}} \quad z > a$	$-\frac{z^{-1}}{1-az^{-1}} \quad z > a$
$-\frac{1}{1-az^{-1}} \quad z > a$	$-\frac{a}{1-az^{-1}} \quad z > a$

(6) $/a$

$-(\frac{1}{a})^n u(-n-1)$ $-(\dots, a^3, a^2, a^1)$	$-(\frac{1}{a})^{n+1} u(-n-1)$ $-(\dots, a^2, a^1, a^0)$
$-(\frac{1}{a})^n u(-n)$ $-(\dots, a^2, a^1, a^0)$	$-(\frac{1}{a})^{n-1} u(-n)$ $-(\dots, a^1, a^0, a^{-1})$

(4) $*a$

(4) $*a$

(6) $*z$

$-\frac{az^{-1}}{1-az^{-1}} \quad z > a$	$-\frac{a}{1-az^{-1}} \quad z > a$
$-\frac{1}{1-az^{-1}} \quad z > a$	$-\frac{z^{-1}}{1-az^{-1}} \quad z > a$

(6) $*z$

$-(\frac{1}{a})^n u(-n-1)$ $-(\dots, a^3, a^2, a^1)$	$-(\frac{1}{a})^{n-1} u(-n)$ $-(\dots, a^3, a^2, a^1)$
$-(\frac{1}{a})^n u(-n)$ $-(\dots, a^2, a^1, a^0)$	$-(\frac{1}{a})^{n+1} u(-n-1)$ $-(\dots, a^2, a^1, a^0)$

(4) $/z$

(4) $/z$

Scale by **a**

1. Geometric Series

(1)

***a**

(2)

/a

	$\frac{1}{1-az} \quad z < a^{-1}$	$\frac{a}{1-az} \quad z < a^{-1}$	$\frac{1}{1-a^{-1}z} \quad z < a$	$\frac{a^{-1}}{1-a^{-1}z} \quad z < a$
Comp.ROC	$-\frac{a^{-1}z^{-1}}{1-a^{-1}z^{-1}} \quad z > a^{-1}$	$-\frac{z^{-1}}{1-a^{-1}z^{-1}} \quad z > a^{-1}$	$-\frac{az^{-1}}{1-az^{-1}} \quad z > a$	$-\frac{z^{-1}}{1-az^{-1}} \quad z > a$

(5)

***a**

(6)

/a

(3)

/a

(4)

***a**

	$-\frac{1}{1-a^{-1}z^{-1}} \quad z > a^{-1}$	$-\frac{a^{-1}}{1-a^{-1}z^{-1}} \quad z > a^{-1}$	$-\frac{1}{1-az^{-1}} \quad z > a$	$-\frac{a}{1-az^{-1}} \quad z > a$
Comp.ROC	$\frac{az}{1-az} \quad z < a^{-1}$	$\frac{z}{1-az} \quad z < a^{-1}$	$\frac{a^{-1}z}{1-a^{-1}z} \quad z < a$	$\frac{z}{1-a^{-1}z} \quad z < a$

(7)

/a

(8)

***a**

(1)	$a^n u(n)$	$\begin{array}{c} \xrightarrow{*a} \\ /z \\ \xrightarrow{*z} \end{array}$	$a^{n+1} u(n)$	(2)	$a^{-n} u(n)$	$\begin{array}{c} \xrightarrow{/a} \\ /z \\ \xrightarrow{*z} \end{array}$	$a^{-n-1} u(n)$
(7)	$a^n u(n-1)$	$\begin{array}{c} \xrightarrow{*z} \\ /a \end{array}$	$a^{n-1} u(n-1)$	(8)	$a^{-n} u(n-1)$	$\begin{array}{c} \xrightarrow{*a} \\ /z \end{array}$	$a^{-n+1} u(n-1)$
(5)	$a^n u(-n-1)$	$\begin{array}{c} \xrightarrow{*a} \\ /z \\ \xrightarrow{*z} \end{array}$	$a^{n+1} u(-n-1)$	(6)	$a^{-n} u(-n-1)$	$\begin{array}{c} \xrightarrow{/a} \\ /z \\ \xrightarrow{*z} \end{array}$	$a^{-n-1} u(-n-1)$
(3)	$a^n u(-n)$	$\begin{array}{c} \xrightarrow{*z} \\ /a \end{array}$	$a^{n-1} u(-n)$	(4)	$a^{-n} u(-n)$	$\begin{array}{c} \xrightarrow{*a} \\ /z \end{array}$	$a^{-n+1} u(-n)$

Scale by **a**

2. Sequences

(1)

***a**

$a^n u(n)$
$- a^n u(-n-1)$

$a^{n+1} u(n)$
$- a^{n+1} u(-n-1)$

(2)

/a

$(\frac{1}{a})^n u(n)$
$-(\frac{1}{a})^n u(-n-1)$

$(\frac{1}{a})^{n+1} u(n)$
$-(\frac{1}{a})^{n+1} u(-n-1)$

Comp.ROC

(5)

***a**

$- a^n u(-n)$
$a^n u(n-1)$

$- a^{n-1} u(-n)$
$a^{n-1} u(n-1)$

(6)

/a

$-(\frac{1}{a})^n u(-n)$
$(\frac{1}{a})^n u(n-1)$

$-(\frac{1}{a})^{n-1} u(-n)$
$(\frac{1}{a})^{n-1} u(n-1)$

Comp.ROC

(3)

/a

(4)

***a**

(7)

/a

(8)

***a**

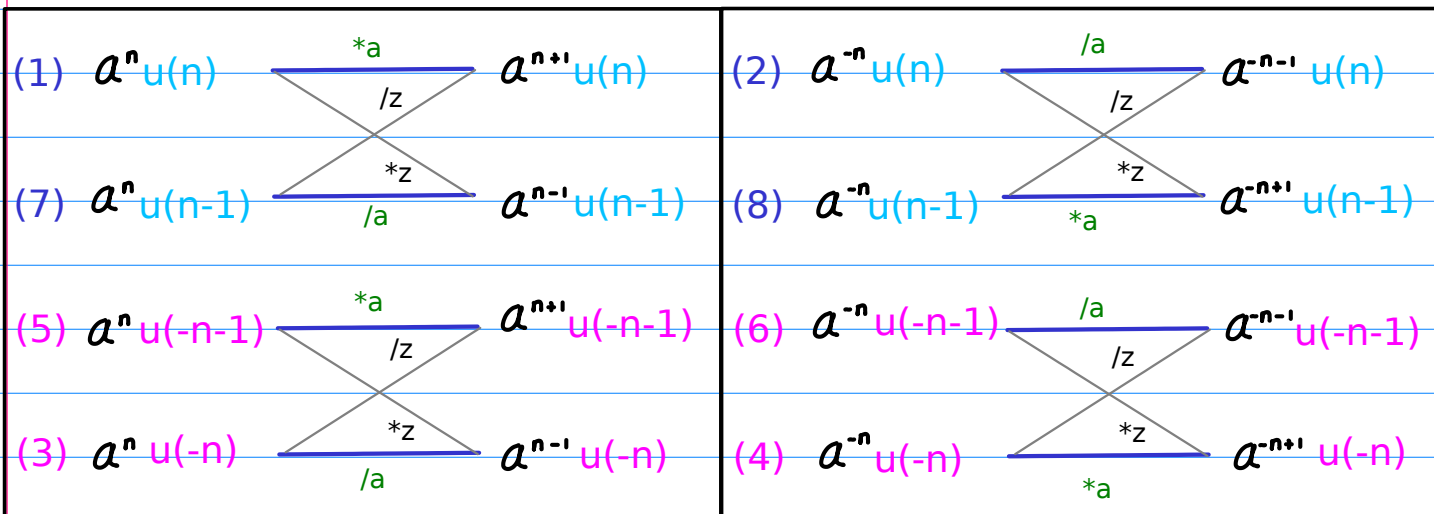

Scale by **a**

3. Sequence values

(1)

***a**

(a^0, a^1, a^2, \dots)	(a^1, a^2, a^3, \dots)
$-(\dots, \frac{1}{a^2}, \frac{1}{a^3}, \frac{1}{a^4})$	$-(\dots, \frac{1}{a^2}, \frac{1}{a^3}, \frac{1}{a^4})$

(2)

/a

$(\frac{1}{a^0}, \frac{1}{a^1}, \frac{1}{a^2}, \dots)$	$(\frac{1}{a^1}, \frac{1}{a^2}, \frac{1}{a^3}, \dots)$
$-(\dots, a^3, a^2, a^1)$	$-(\dots, a^2, a^1, a^0)$

Comp.ROC

(5)

***a**

$-(\dots, \frac{1}{a^2}, \frac{1}{a^3}, \frac{1}{a^4})$	$-(\dots, \frac{1}{a^3}, \frac{1}{a^4}, \frac{1}{a^5})$
(a^1, a^2, a^3, \dots)	(a^0, a^1, a^2, \dots)

(6)

/a

$-(\dots, a^2, a^1, a^0)$	$-(\dots, a^3, a^2, a^1)$
$(\frac{1}{a^1}, \frac{1}{a^2}, \frac{1}{a^3}, \dots)$	$(\frac{1}{a^0}, \frac{1}{a^1}, \frac{1}{a^2}, \dots)$

Comp.ROC

(3)

/a

(7)

/a

(4)

***a**

(8)

***a**

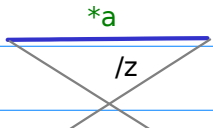
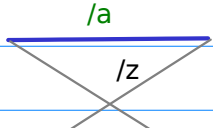
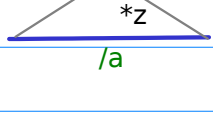
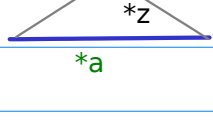
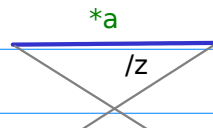
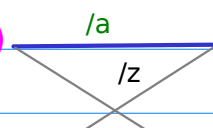
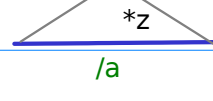
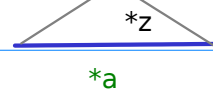
(1) $a^n u(n)$		$a^{n+1} u(n)$	(2) $a^{-n} u(n)$		$a^{-n-1} u(n)$
(7) $a^n u(n-1)$		$a^{n-1} u(n-1)$	(8) $a^{-n} u(n-1)$		$a^{-n+1} u(n-1)$
(5) $a^n u(-n-1)$		$a^{n+1} u(-n-1)$	(6) $a^{-n} u(-n-1)$		$a^{-n-1} u(-n-1)$
(3) $a^n u(-n)$		$a^{n-1} u(-n)$	(4) $a^{-n} u(-n)$		$a^{-n+1} u(-n)$

Scale by **a**

4. Graphs

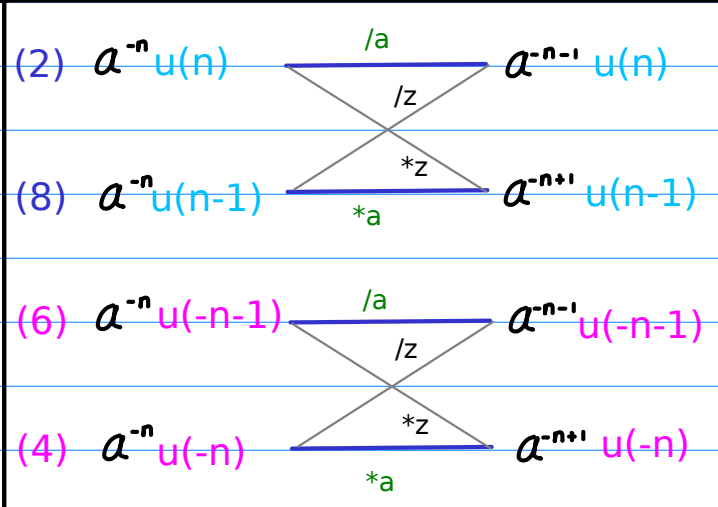
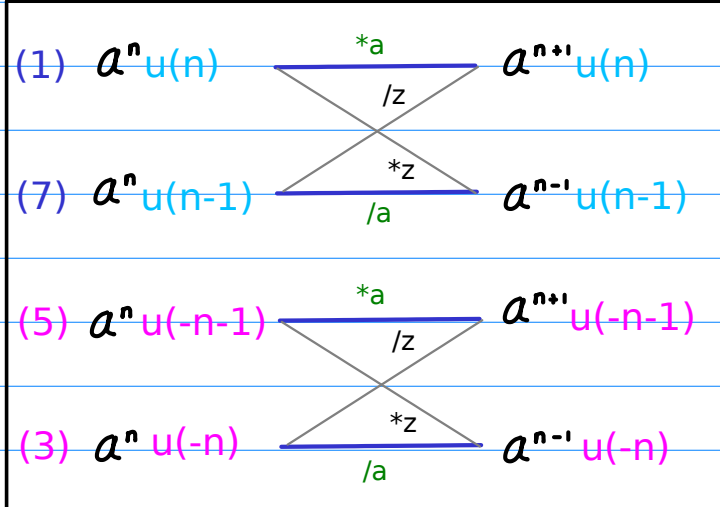
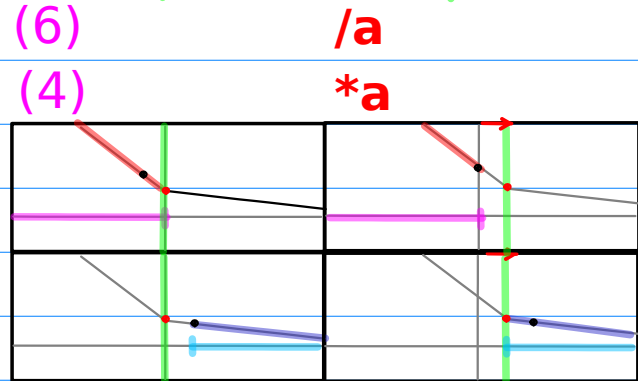
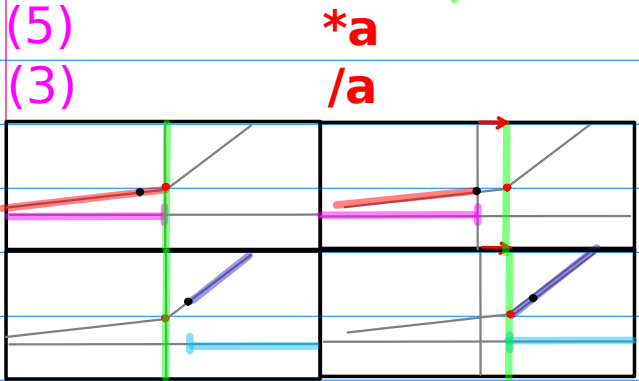
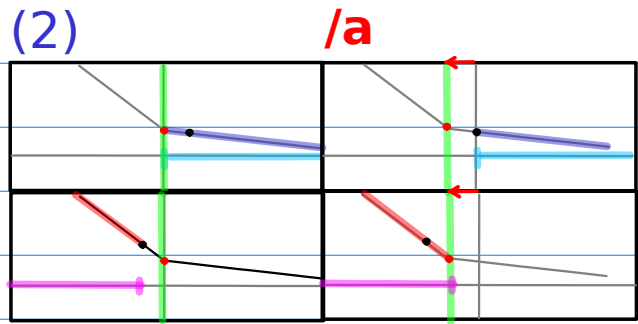
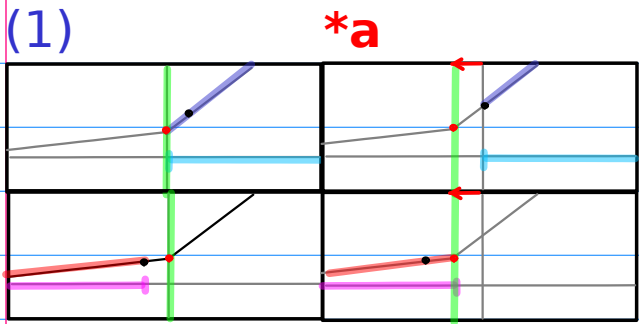

Scale by **a**

5. Graphs - signs

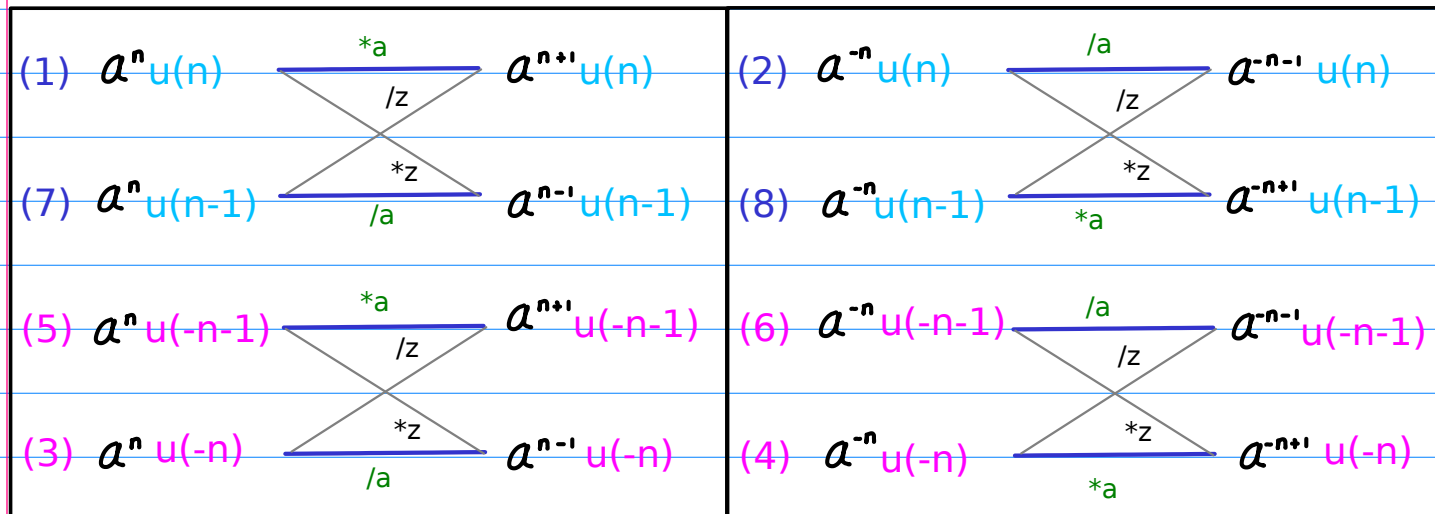
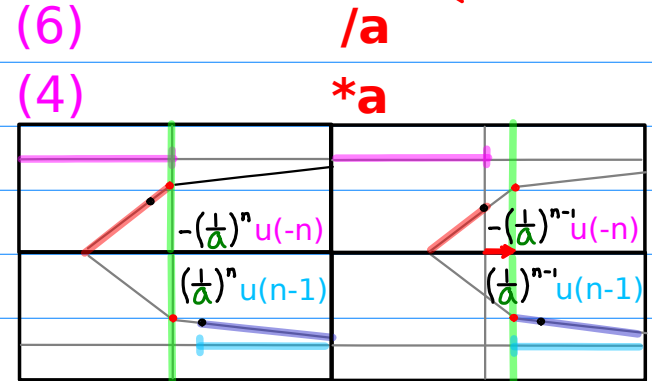
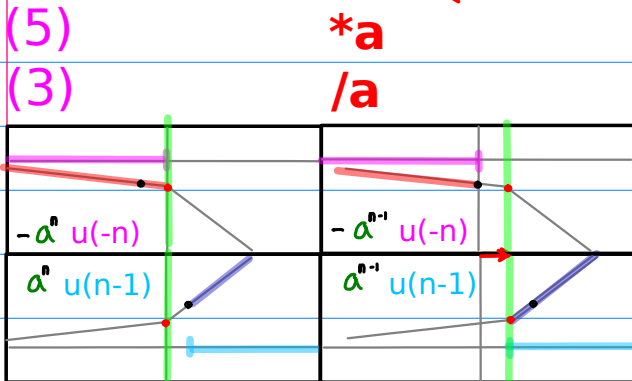
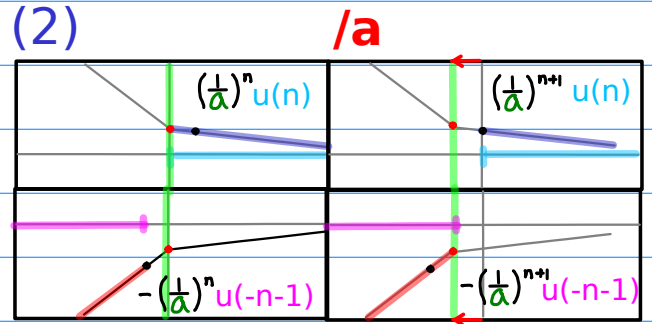
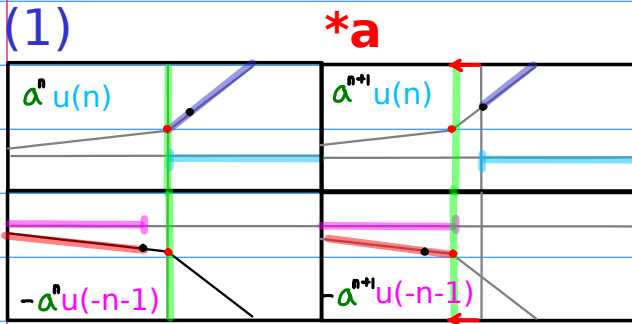

Scale by **a**

6. Graphs - Exponents

(1) ***a** ← SHL.Exp

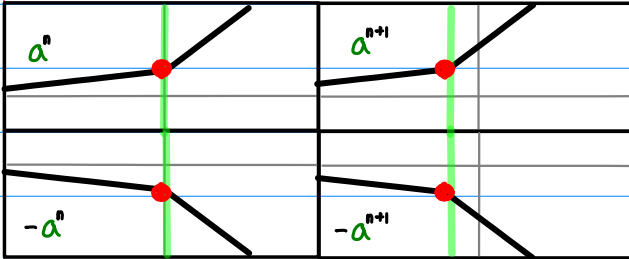

(2) **/a** ← SHL.Exp

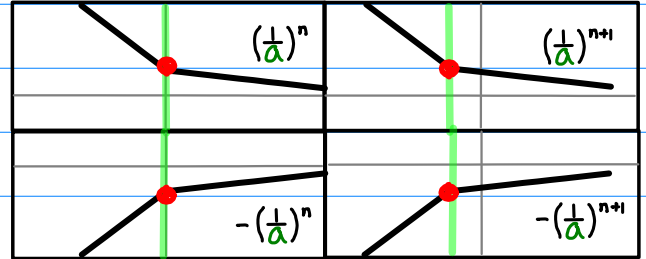

(5) ***a** ← SHL.Exp

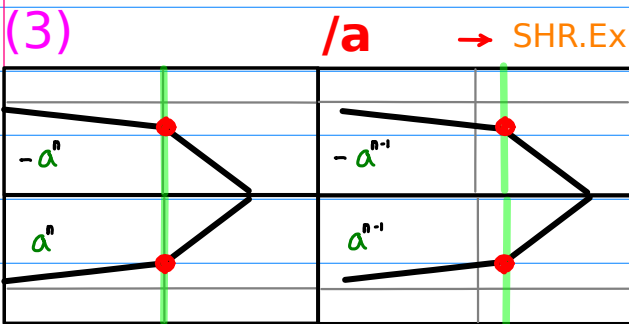

(6) **/a** ← SHL.Exp

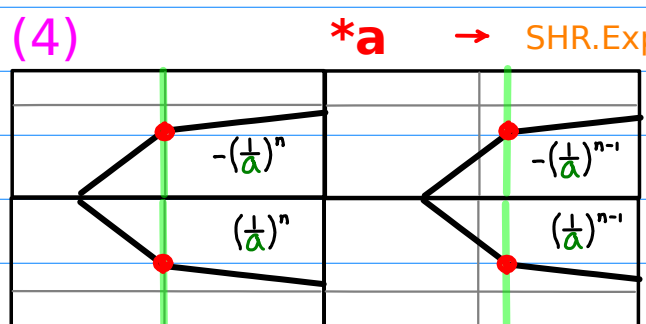

(3) **/a** → SHR.Exp

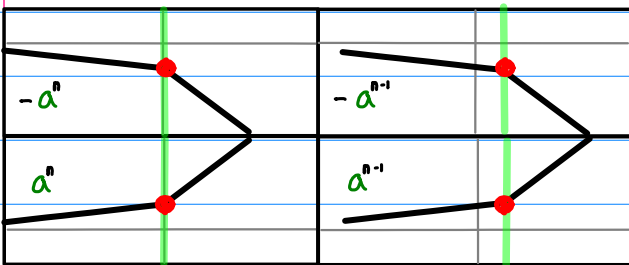

(4) ***a** → SHR.Exp

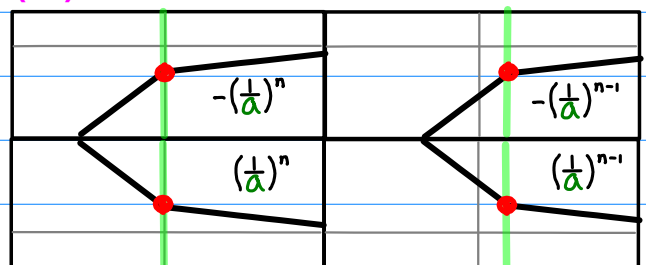

(7) **/a** → SHR.Exp

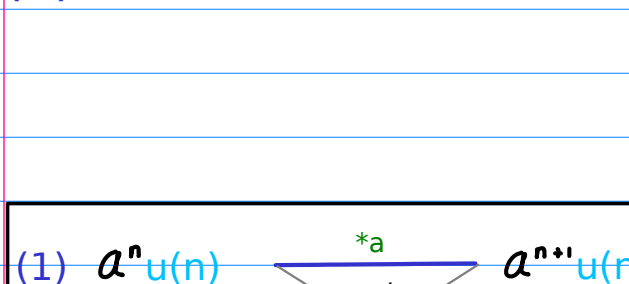

(8) ***a** → SHR.Exp

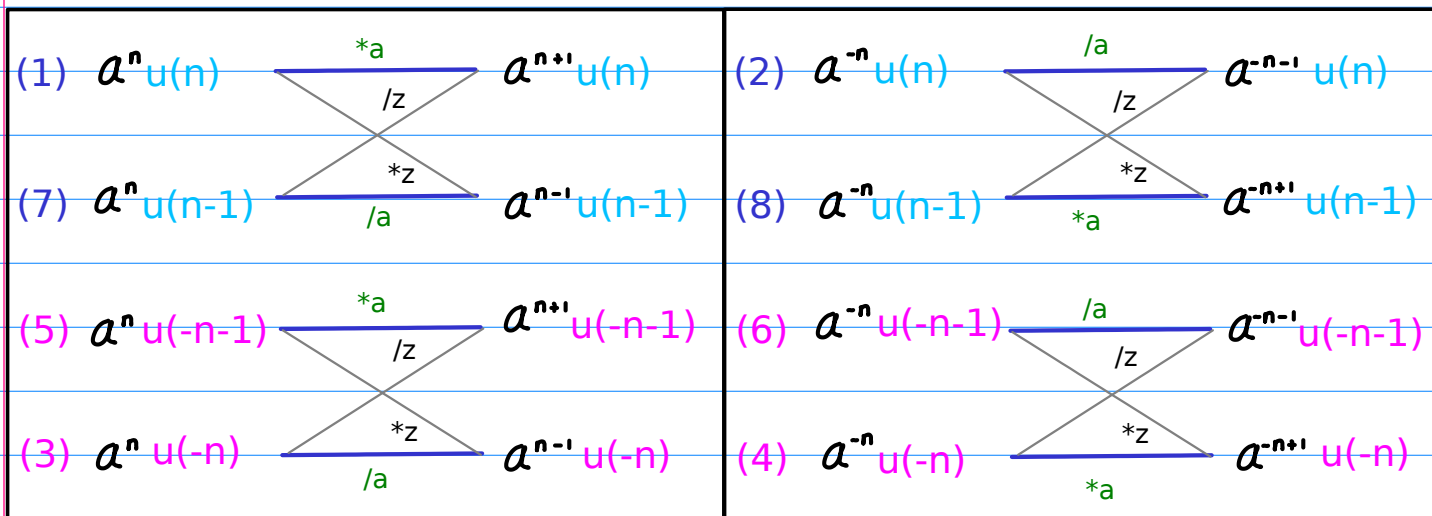
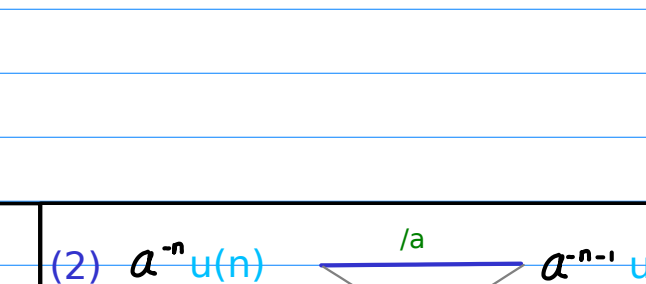

Scale by **a**

7. Graphs - Ranges

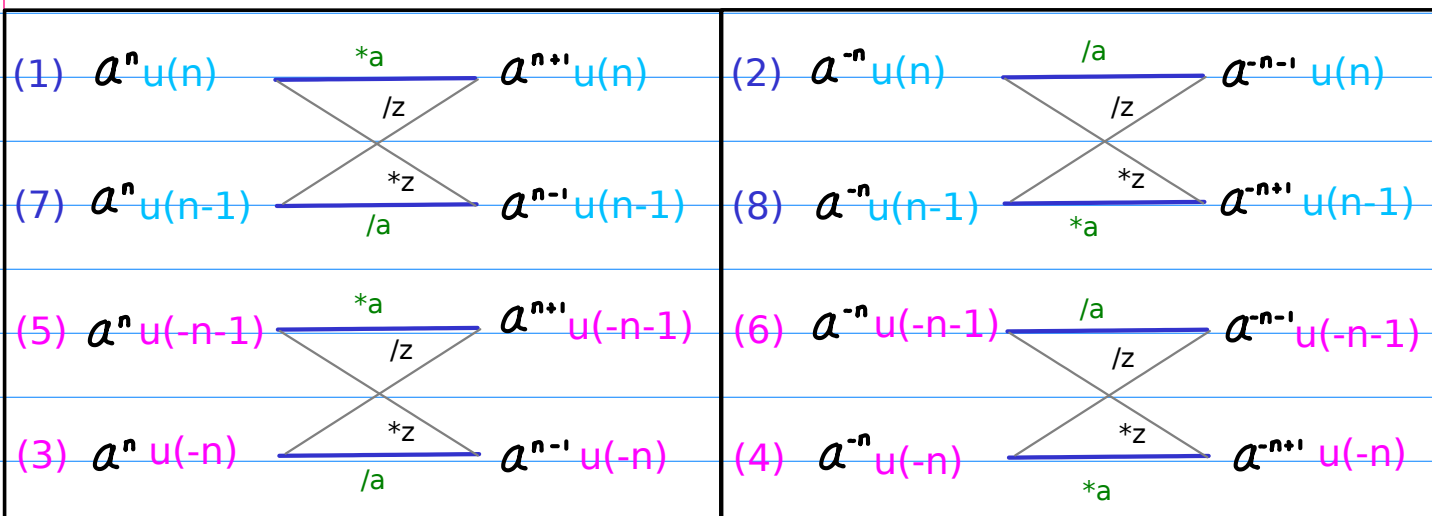
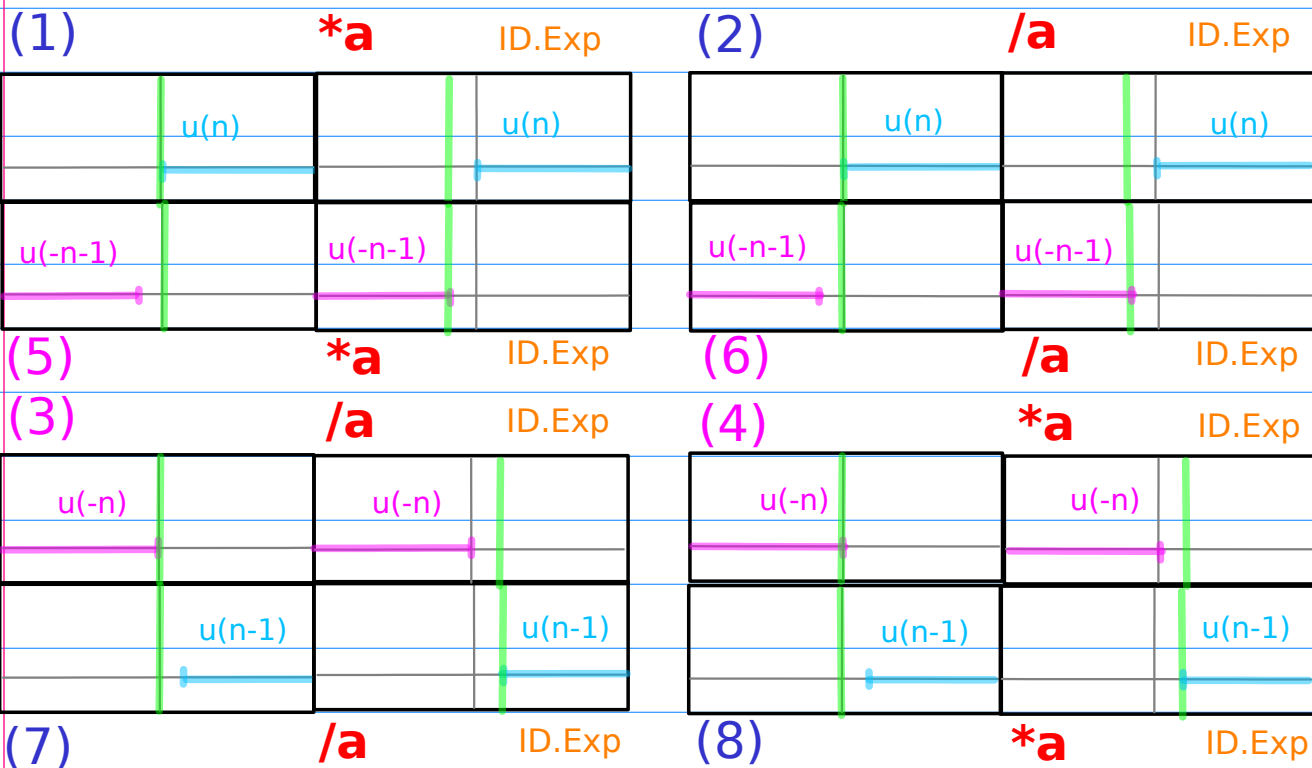

Scale by z

1. Geometric Series

(1)

$*z$

$\frac{1}{1-az}$ $ z < a^{-1}$	$\frac{z}{1-az}$ $ z < a^{-1}$
$-\frac{a^{-1}z^{-1}}{1-a^{-1}z^{-1}}$ $ z > a^{-1}$	$-\frac{a^{-1}}{1-a^{-1}z^{-1}}$ $ z > a^{-1}$

(2)

$*z$

$\frac{1}{1-a^{-1}z}$ $ z < a$	$\frac{z}{1-a^{-1}z}$ $ z < a$
$-\frac{a^{-1}z^{-1}}{1-a^{-1}z^{-1}}$ $ z > a$	$-\frac{a^{-1}}{1-a^{-1}z^{-1}}$ $ z > a$

(5)

$*z$

$-\frac{1}{1-a^{-1}z^{-1}}$ $ z > a^{-1}$	$-\frac{z^{-1}}{1-a^{-1}z^{-1}}$ $ z > a^{-1}$
$\frac{az}{1-az}$ $ z < a^{-1}$	$\frac{a}{1-az}$ $ z < a^{-1}$

(6)

$*z$

$-\frac{1}{1-az^{-1}}$ $ z > a$	$-\frac{z^{-1}}{1-az^{-1}}$ $ z > a$
$\frac{a^{-1}z}{1-a^{-1}z}$ $ z < a$	$\frac{a^{-1}}{1-a^{-1}z}$ $ z < a$

(3)

$/z$

(7)

$/z$

(4)

$/z$

(8)

$/z$

(1) $a^n u(n)$	$*a$	$a^{n+1} u(n)$
(7) $a^n u(n-1)$	$/z$	$a^{n-1} u(n-1)$
(5) $a^n u(-n-1)$	$*z$	$a^{n+1} u(-n-1)$
(3) $a^n u(-n)$	$/a$	$a^{n-1} u(-n)$

(2) $a^{-n} u(n)$	$/a$	$a^{-n-1} u(n)$
(8) $a^{-n} u(n-1)$	$/z$	$a^{-n-1} u(n-1)$
(6) $a^{-n} u(-n-1)$	$*z$	$a^{-n+1} u(-n-1)$
(4) $a^{-n} u(-n)$	$*a$	$a^{-n+1} u(-n)$

Scale by z

2. Sequences

(1)

$*z$

$a^n u(n)$	$a^{n-1} u(n-1)$
$-a^n u(-n-1)$	$-a^{n-1} u(-n)$

(2)

$*z$

$(\frac{1}{a})^n u(n)$	$(\frac{1}{a})^{n-1} u(n-1)$
$-(\frac{1}{a})^n u(-n-1)$	$-(\frac{1}{a})^{n-1} u(-n)$

Comp.ROC

(5)

$*z$

$-a^n u(-n)$	$-a^{n+1} u(-n-1)$
$a^n u(n-1)$	$a^{n+1} u(n)$

(6)

$*z$

$-(\frac{1}{a})^n u(-n)$	$-(\frac{1}{a})^{n+1} u(-n-1)$
$(\frac{1}{a})^n u(n-1)$	$(\frac{1}{a})^{n+1} u(n)$

Comp.ROC

(3)

$/z$

(7)

$/z$

(4)

$/z$

(8)

$/z$

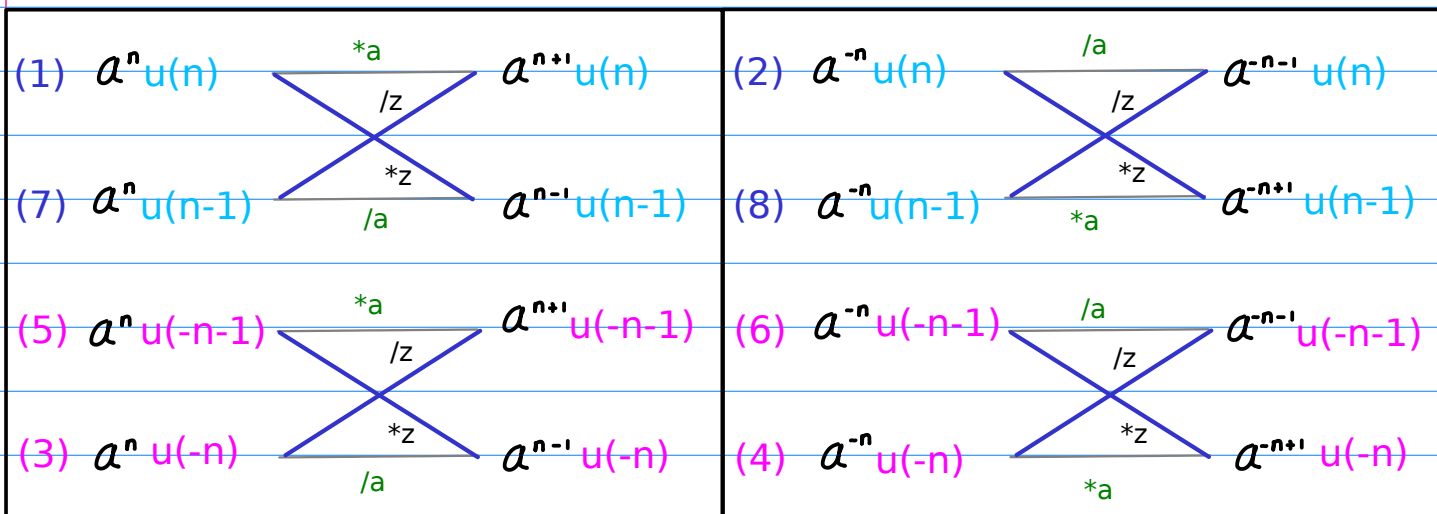

Scale by z

3. Sequence values

(1)

$*z$

(a^0, a^1, a^2, \dots)	(a^0, a^1, a^2, \dots)
$-(\dots, \frac{1}{a^2}, \frac{1}{a^2}, \frac{1}{a^1})$	$-(\dots, \frac{1}{a^2}, \frac{1}{a^2}, \frac{1}{a^1})$

(2)

$*z$

$(\frac{1}{a^0}, \frac{1}{a^1}, \frac{1}{a^2}, \dots)$	$(\frac{1}{a^1}, \frac{1}{a^2}, \frac{1}{a^3}, \dots)$
$-(\dots, a^3, a^2, a^1)$	$-(\dots, a^3, a^2, a^1)$

Comp.ROC

(5)

$*z$

$-(\dots, \frac{1}{a^2}, \frac{1}{a^1}, \frac{1}{a^0})$	$-(\dots, \frac{1}{a^2}, \frac{1}{a^1}, \frac{1}{a^0})$
(a^1, a^2, a^3, \dots)	(a^1, a^2, a^3, \dots)

(6)

$*z$

$-(\dots, a^2, a^1, a^0)$	$-(\dots, a^2, a^1, a^0)$
$(\frac{1}{a^1}, \frac{1}{a^2}, \frac{1}{a^3}, \dots)$	$(\frac{1}{a^1}, \frac{1}{a^2}, \frac{1}{a^3}, \dots)$

Comp.ROC

(3)

$/z$

(7)

$/z$

(4)

$/z$

(8)

$/z$

(1) $a^n u(n)$	$*a$	$a^{n+1} u(n)$	(2) $a^{-n} u(n)$	$/a$	$a^{-n-1} u(n)$
(7) $a^n u(n-1)$	$/z$	$a^{n-1} u(n-1)$	(8) $a^{-n} u(n-1)$	$/z$	$a^{-n+1} u(n-1)$
(5) $a^n u(-n-1)$	$*z$	$a^{n+1} u(-n-1)$	(6) $a^{-n} u(-n-1)$	$*a$	$a^{-n-1} u(-n-1)$
(3) $a^n u(-n)$	$/a$	$a^{n-1} u(-n)$	(4) $a^{-n} u(-n)$	$/z$	$a^{-n+1} u(-n)$

Scale by z

4. Graphs

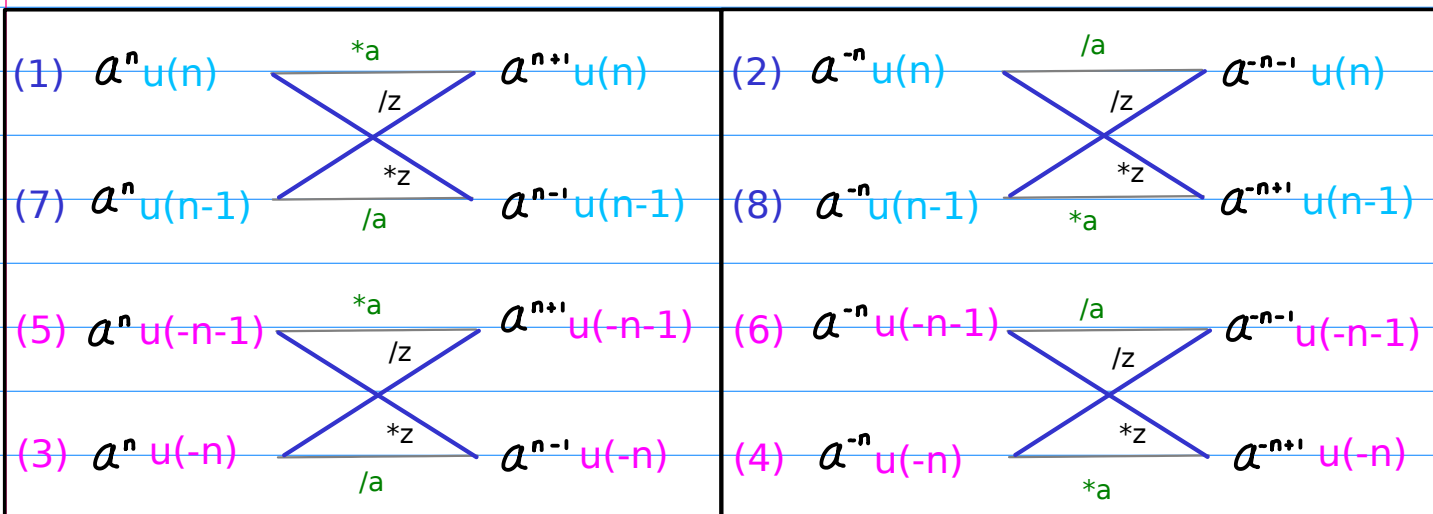
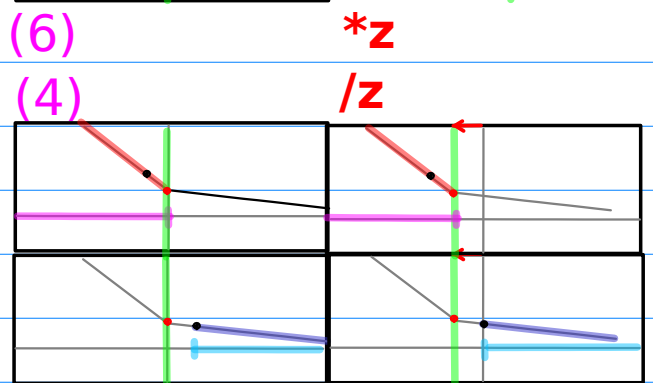
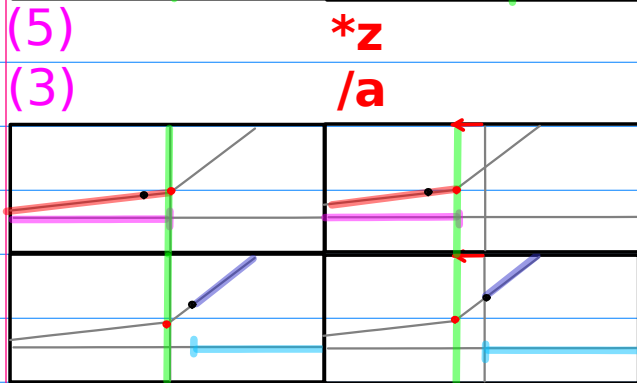
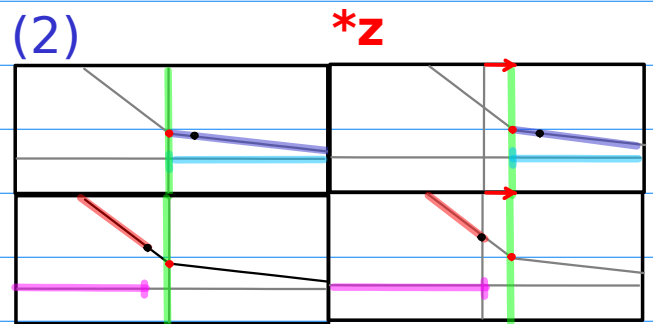
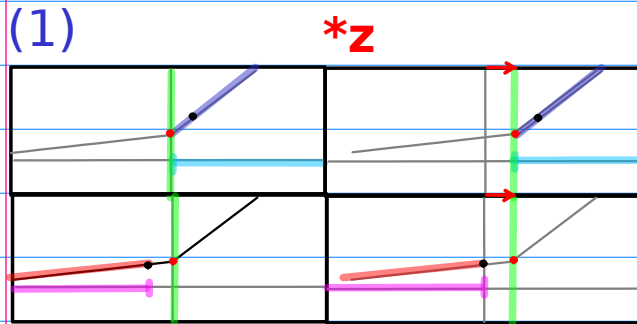

Scale by z

5. Graphs - signs

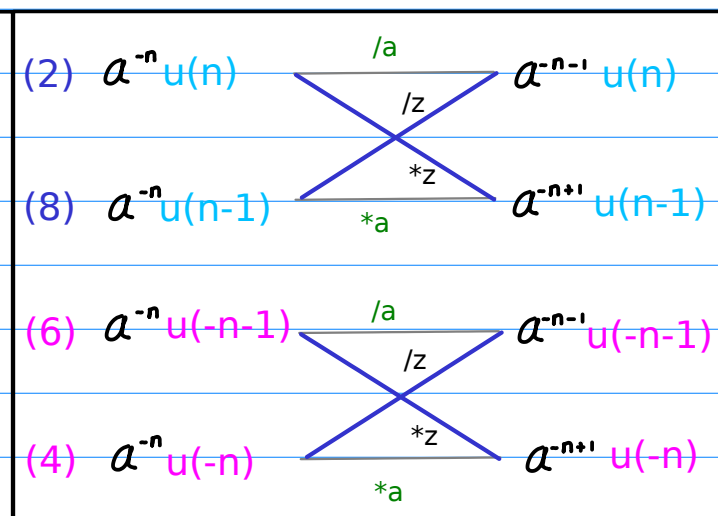
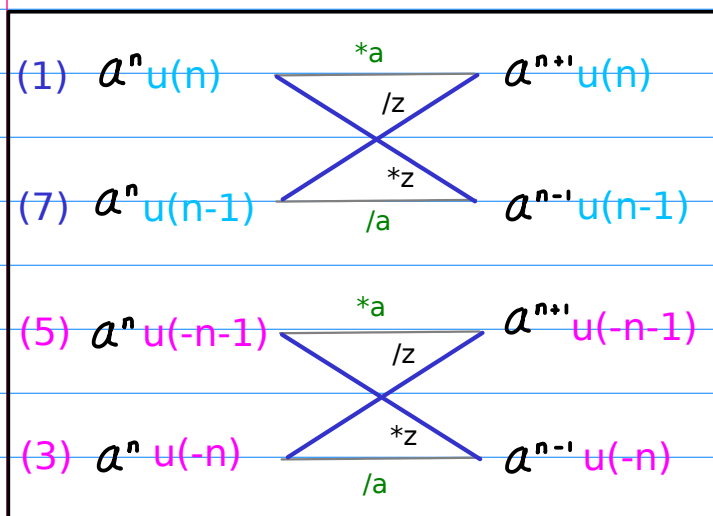
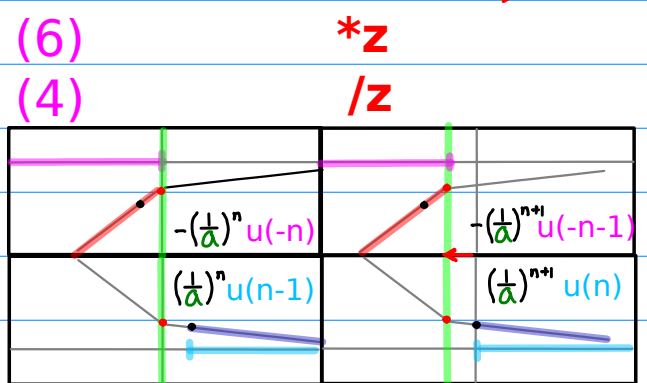
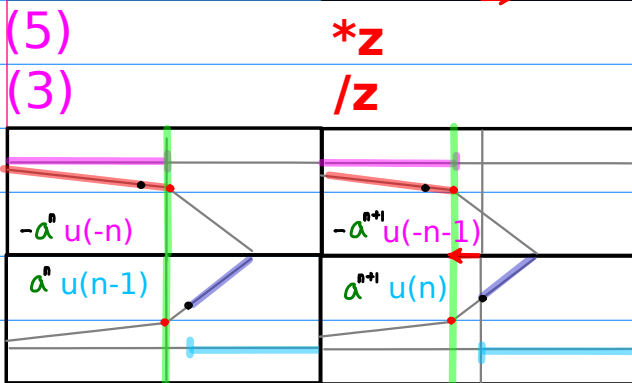
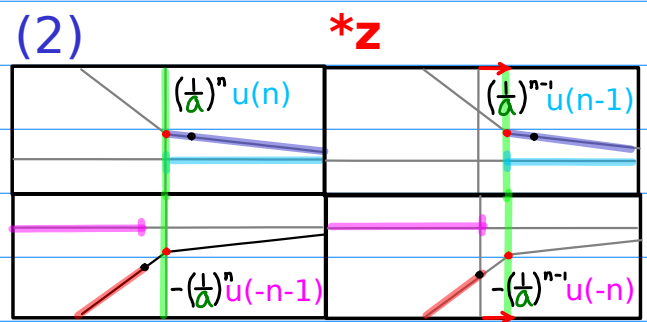
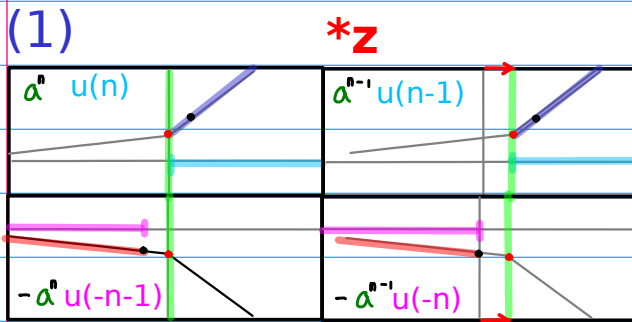

Scale by z

6. Graphs - Exponents

(1) $*z$ \rightarrow SHR.Exp (2) $*z$ \rightarrow SHR.Exp

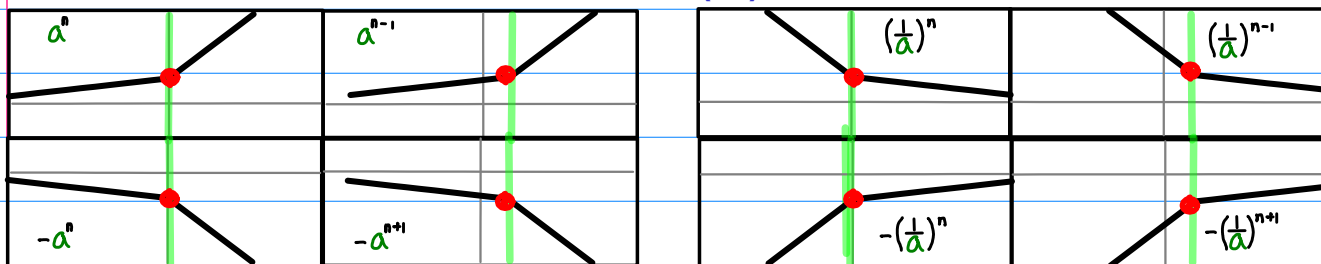

(5) $*z$ \rightarrow SHR.Exp (6) $*z$ \rightarrow SHR.Exp

(3) $/z$ \leftarrow SHL.Exp (4) $/z$ \leftarrow SHL.Exp

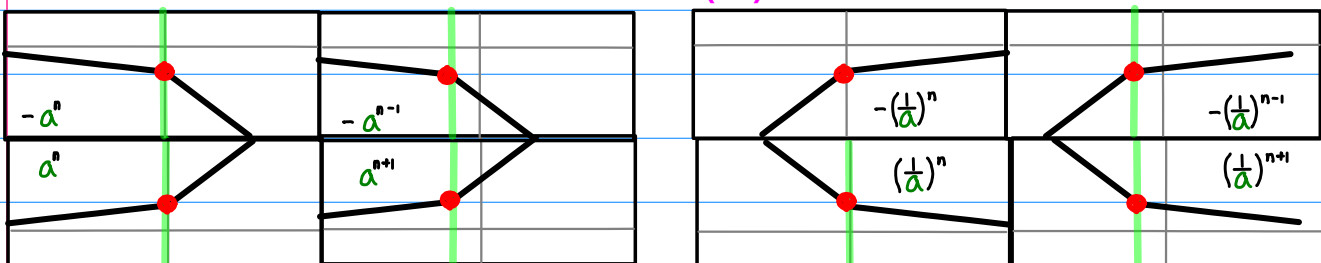

(7) $/z$ \leftarrow SHL.Exp (8) $/z$ \leftarrow SHL.Exp

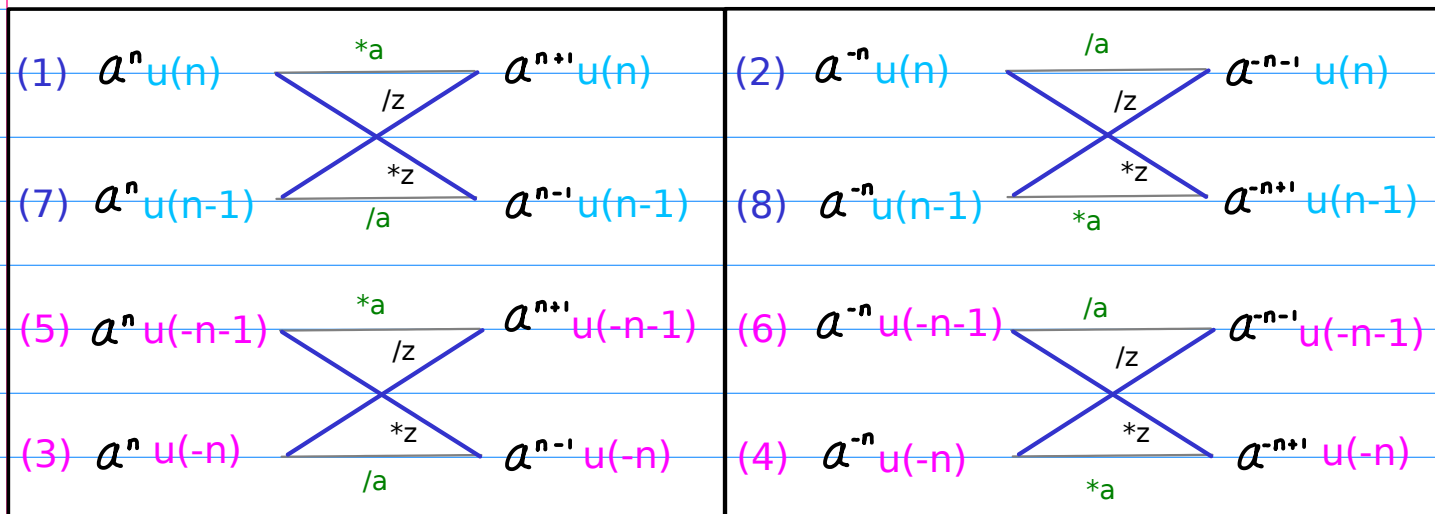

Scale by z

7. Graphs - Ranges

