

# Laurent Series and z-Transform

## - Geometric Series

## Permutations B

20240423 Tue

Copyright (c) 2024 - 2016 Young W. Lim.

Permission is granted to copy, distribute and/or modify this document under the terms of the GNU Free Documentation License, Version 1.2 or any later version published by the Free Software Foundation; with no Invariant Sections, no Front-Cover Texts, and no Back-Cover Texts. A copy of the license is included in the section entitled "GNU Free Documentation License".

## Unshifted Sequence

(1)  $a^n u(n)$

(2)  $a^{-n} u(n)$

(3)  $a^n u(-n)$

(4)  $a^{-n} u(-n)$

(5)  $a^n u(-n-1)$

(6)  $a^{-n} u(-n-1)$

(7)  $a^n u(n-1)$

(8)  $a^{-n} u(n-1)$

## Shifted Sequence

$a^{n+i} u(n)$  (1')

$a^{-n-i} u(n)$  (2')

$a^{n-i} u(-n)$  (3')

$a^{-n+i} u(-n)$  (4')

$a^{n+i} u(-n-1)$  (5')

$a^{-n-i} u(-n-1)$  (6')

$a^{n-i} u(n-1)$  (7')

$a^{-n+i} u(n-1)$  (8')

**Inter-permutations over unshifted sequence and shifted sequence**

**Intra-permutations over unshifted sequence**

**Intra-permutations over shifted sequence**

# Inter-permutation

(x)  $\dashrightarrow$  (x')  
 (1)~(8)  $\dashrightarrow$  (1')~(8')

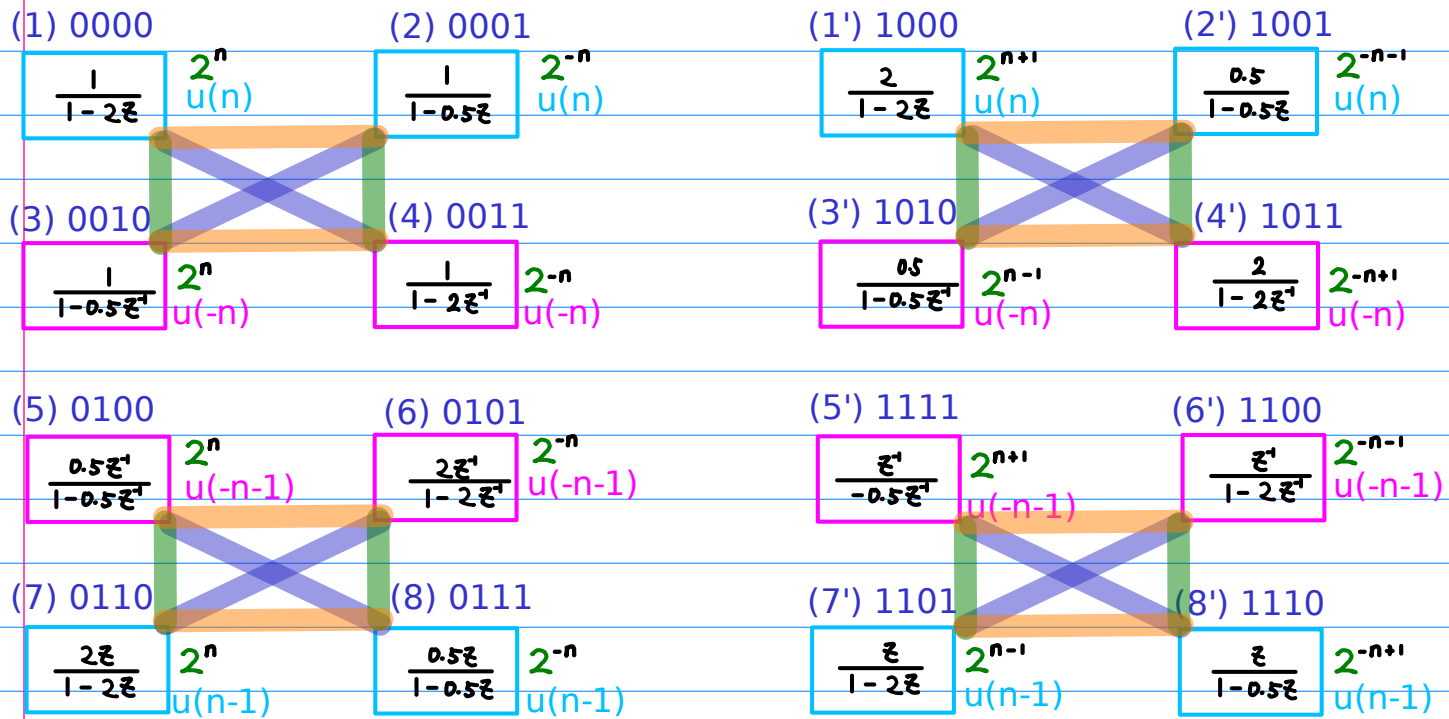

(1)	0 0 0 0	$\rightarrow$	1 0 0 0	(1')	$n \rightarrow n+1$	<b>shl(n)</b>
(2)	0 0 0 1	$\rightarrow$	1 0 0 1	(2')	$n \rightarrow n+1$	<b>shl(n)</b>
(3)	0 0 1 0	$\rightarrow$	1 0 1 0	(3')	$n \rightarrow n-1$	<b>shr(n)</b>
(4)	0 0 1 1	$\rightarrow$	1 0 1 1	(4')	$n \rightarrow n-1$	<b>shr(n)</b>
(5)	0 1 0 0	$\rightarrow$	1 1 0 0	(5')	$n \rightarrow n+1$	<b>shl(n)</b>
(6)	0 1 0 1	$\rightarrow$	1 1 0 1	(6')	$n \rightarrow n+1$	<b>shl(n)</b>
(7)	0 1 1 0	$\rightarrow$	1 1 1 0	(7')	$n \rightarrow n-1$	<b>shr(n)</b>
(8)	0 1 1 1	$\rightarrow$	1 1 1 1	(7')	$n \rightarrow n-1$	<b>shr(n)</b>

$$\text{shl}(n) = n + 1$$

$$\text{shr}(n) = n - 1$$

(1) -- (1')  
(5) -- (5')

$2^n$

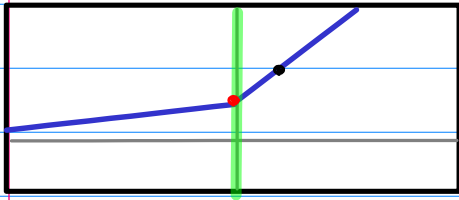

shift left  
 $n \leftarrow n+1$

$2^{n+1}$

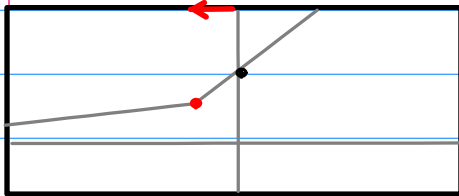

(2) -- (2')  
(6) -- (6')

$2^{-n}$

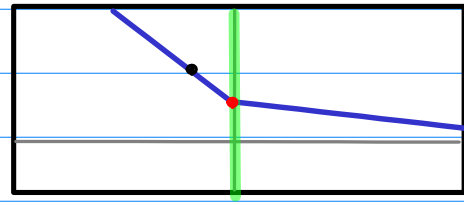

shift left  
 $n \leftarrow n+1$

$2^{-(n+1)}$

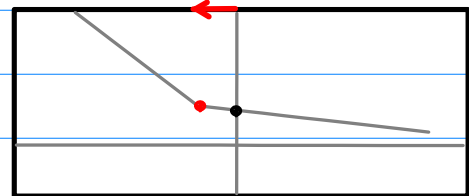

(3) -- (3')  
(7) -- (7')

$2^n$

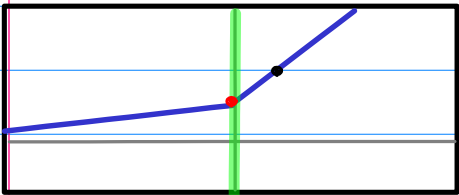

shift right  
 $n \leftarrow n-1$

$2^{n-1}$

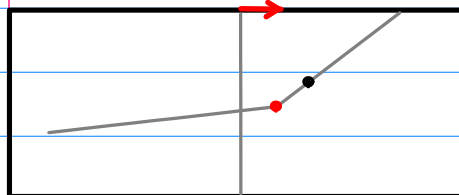

(4) -- (4')  
(8) -- (8')

$2^{-n}$

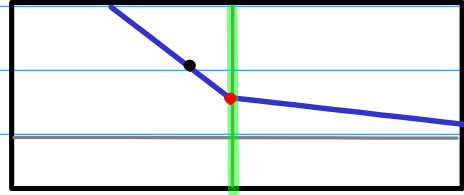

shift right  
 $n \leftarrow n-1$

$2^{-(n-1)}$

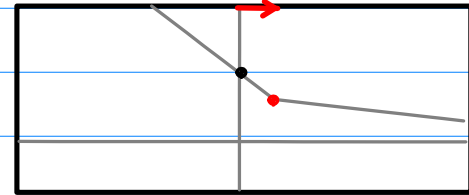

(1) - (1')  
(7) - (7')  
(5) - (5')  
(3) - (3')

(2) - (2')  
(8) - (8')  
(6) - (6')  
(4) - (4')

(1) - (1')  
(2) - (2')  
(3) - (3')  
(4) - (4')

(5) - (5')  
(6) - (6')  
(7) - (7')  
(8) - (8')

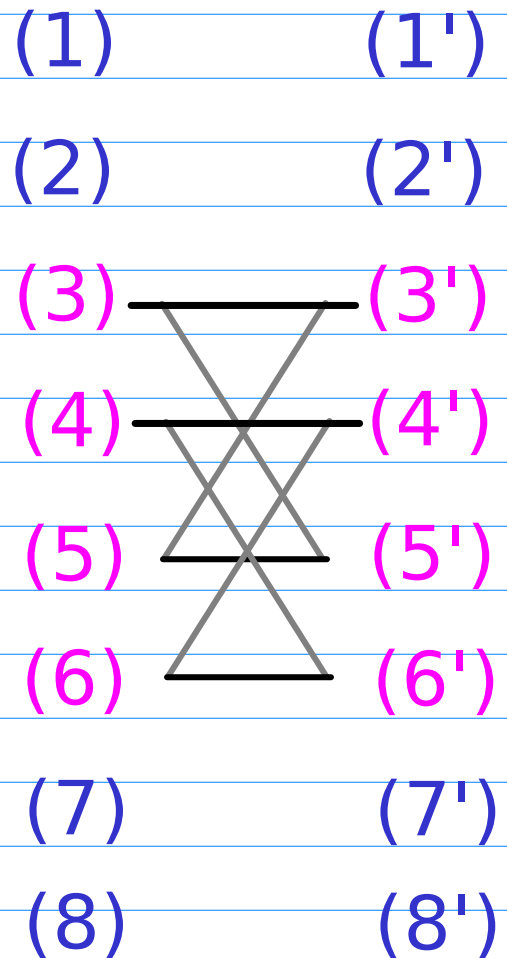
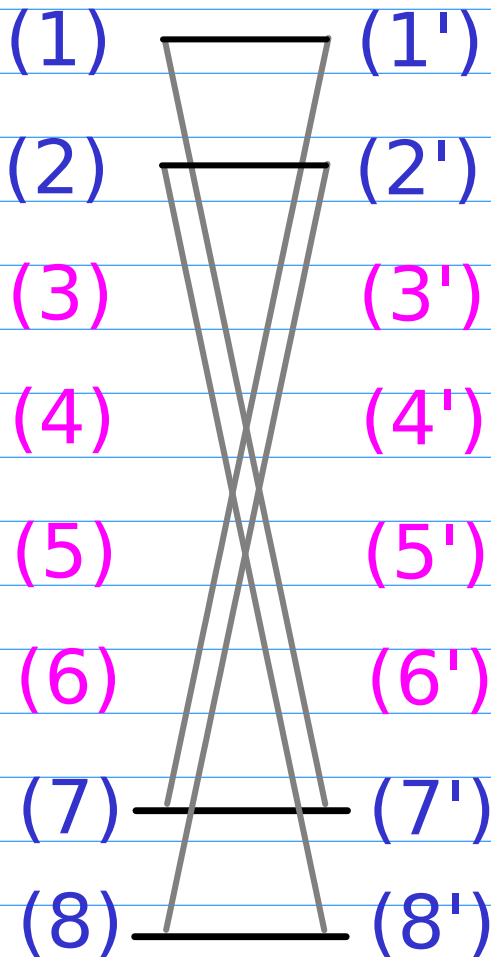
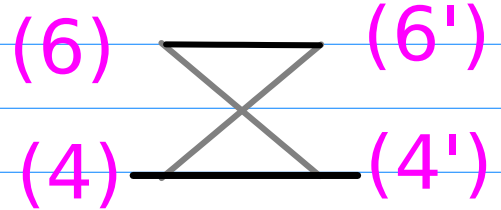
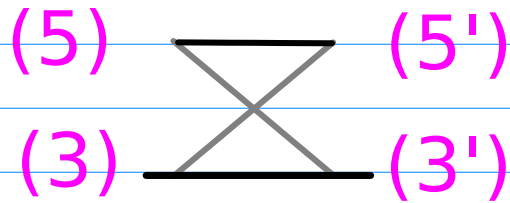
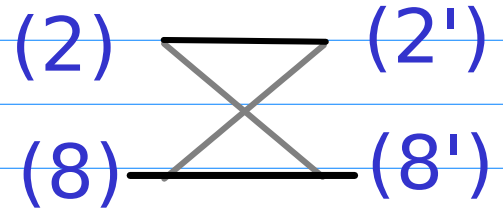
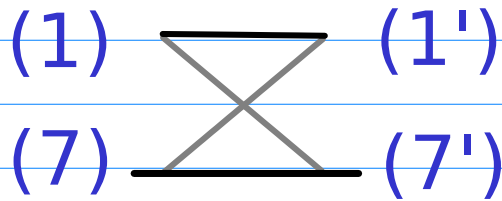

# Butterfly Relations

(\*) unit starting

(1)  $*a \leftarrow (SL, id)$  (1') **SL**

$/z \leftarrow (SL, SL)$

$*z \Rightarrow (SR, SR)$

(7)  $/a \rightarrow (SR, id)$  (7') **SR**

$/a \rightarrow (SR, id)$

C.R. starting

(\*) unit starting

(2)  $/a \leftarrow (SL, id)$  (2') **SL**

$/z \leftarrow (SL, SL)$

C.R. starting  $*z \Rightarrow (SR, SR)$

(8)  $*a \rightarrow (SR, id)$  (8') **SR**

$*a \rightarrow (SR, id)$

(\*) C.R. starting

(5)  $*a \leftarrow (SL, id)$  (5') **SL**

$/z \leftarrow (SL, SL)$

$*z \Rightarrow (SR, SR)$

(3)  $/a \rightarrow (SR, id)$  (3') **SR**

$/a \rightarrow (SR, id)$

unit starting

(\*) C.R. starting

(6)  $/a \leftarrow (SL, id)$  (6') **SL**

$/z \leftarrow (SL, SL)$

unit starting  $*z \Rightarrow (SR, SR)$

(4)  $*a \rightarrow (SR, id)$  (4') **SR**

$*a \rightarrow (SR, id)$

unit starting

**(Exp Shift, Range Shift)**

# Decomposition of Exp and Rng Shifts

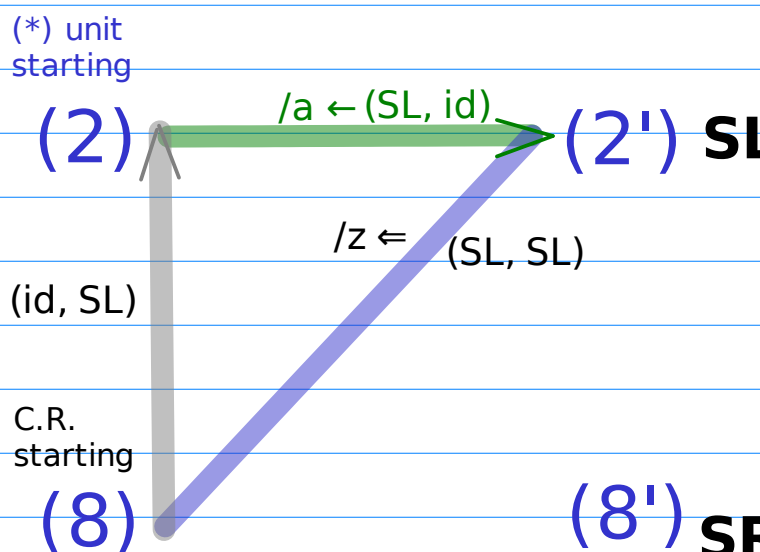
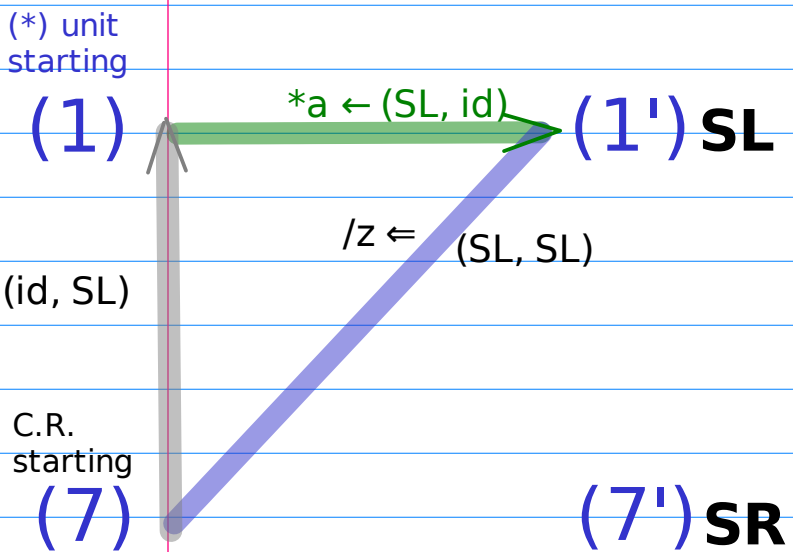
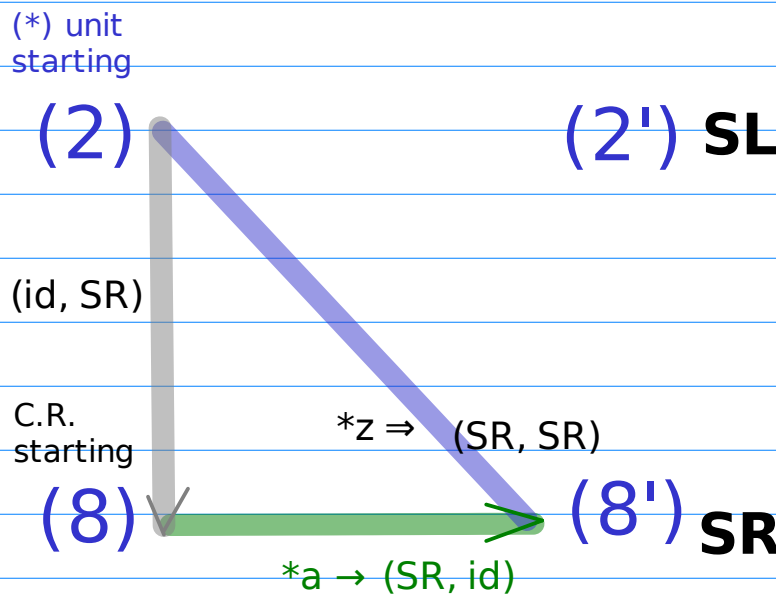
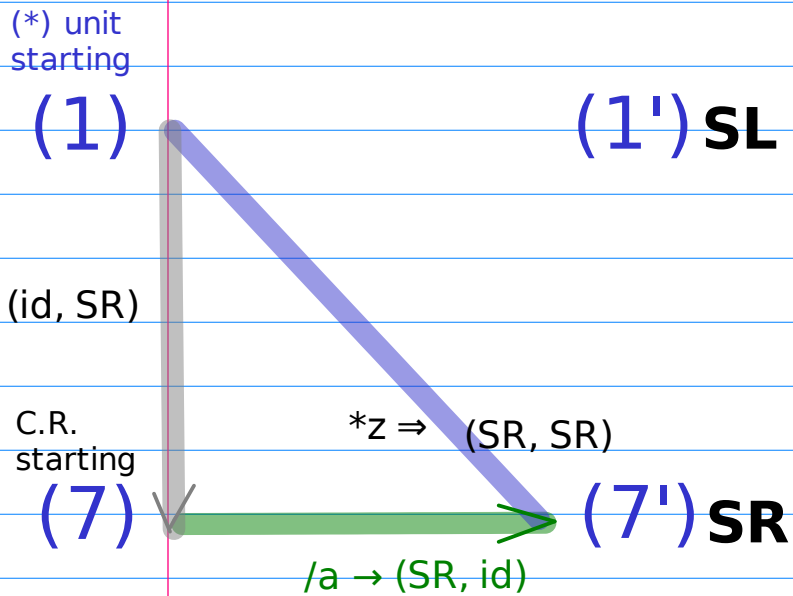

$$(id, SR) + (SR, id) = (SR, SR)$$

$$(id, SL) + (SL, id) = (SR, SL)$$

$$(id, SR) + (SR, id) = (SR, SR)$$

$$(id, SL) + (SL, id) = (SR, SL)$$



# Decomposition of Exp and Rng Shifts

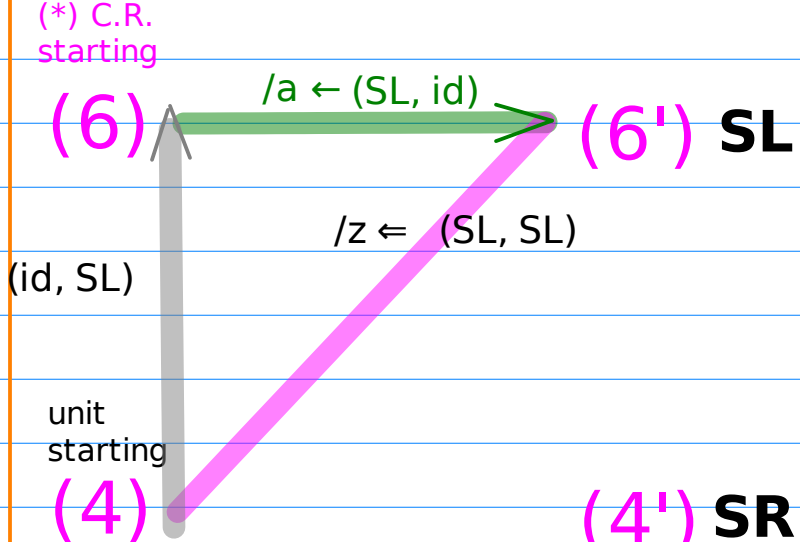
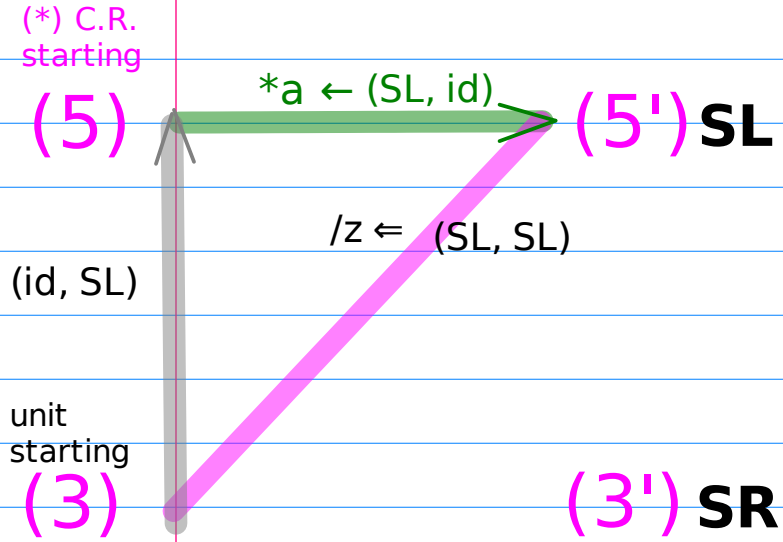
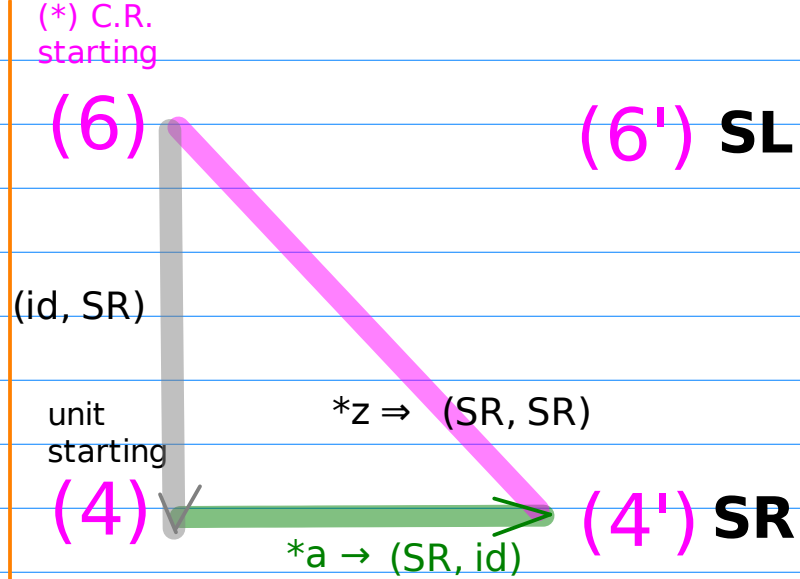
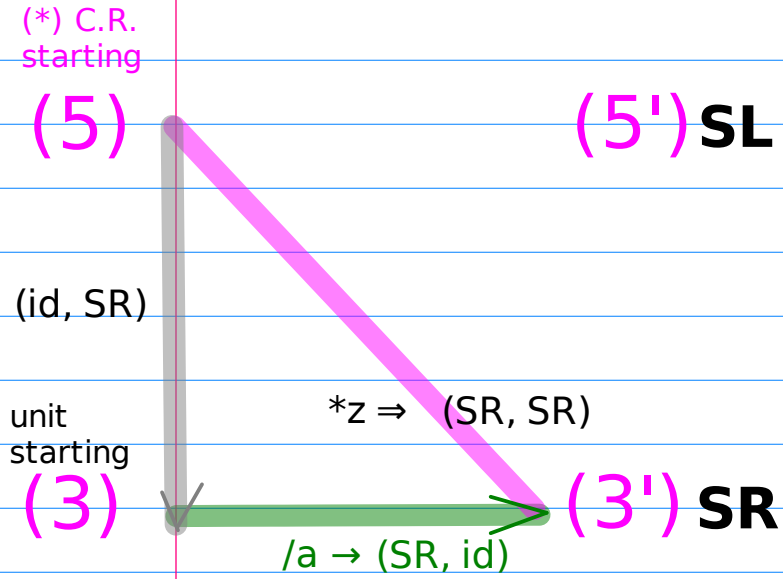

$$(id, SR) + (SR, id) = (SR, SR)$$

$$(id, SL) + (SL, id) = (SR, SL)$$

$$(id, SR) + (SR, id) = (SR, SR)$$

$$(id, SL) + (SL, id) = (SR, SL)$$

## Exponent Shifts

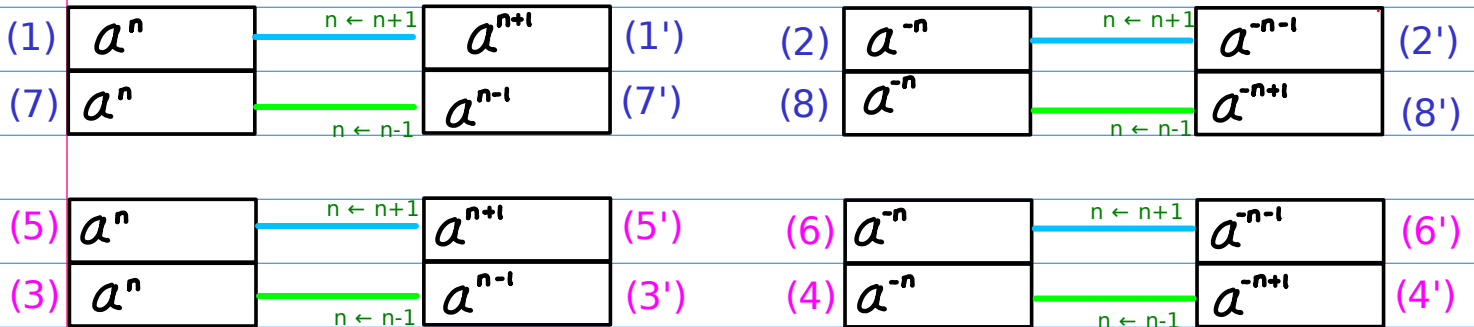

## Range Shifts

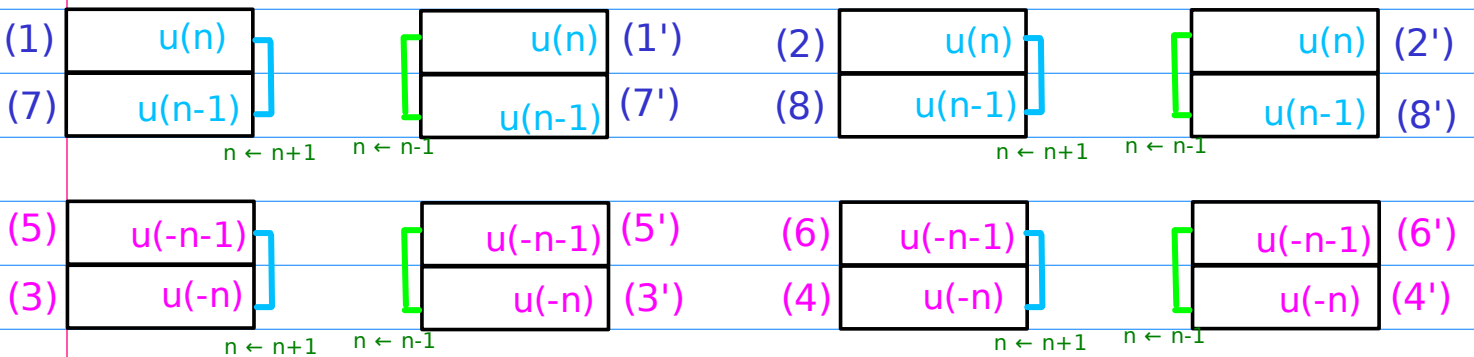

## Exponent & Range Permutations

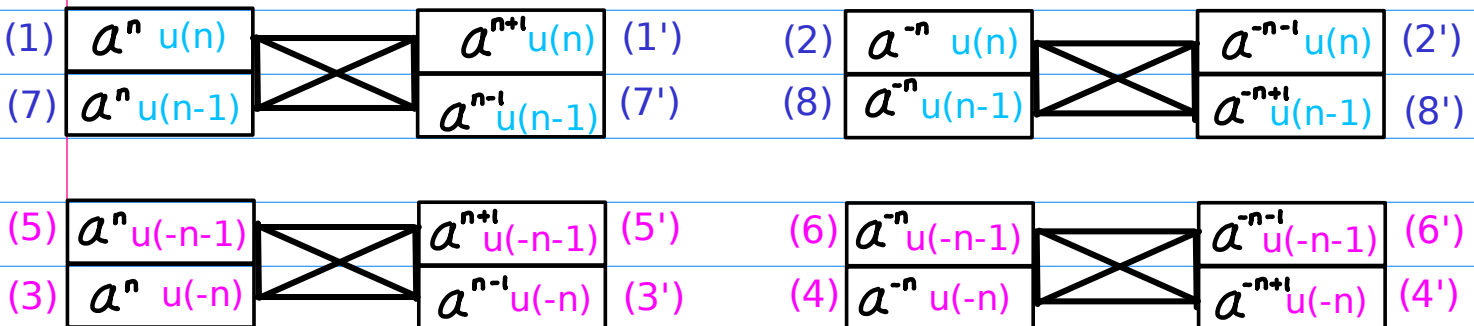

# Exponent Permutations

$$\begin{array}{l} (1) \\ (7) \end{array} \begin{array}{|c|} \hline a^n u(n) \\ \hline a^n u(n-1) \\ \hline \end{array} \begin{array}{|c|} \hline \diagdown \quad \diagup \\ \hline \diagup \quad \diagdown \\ \hline \end{array} \begin{array}{|c|} \hline a^{n+1} u(n) \\ \hline a^{n-1} u(n-1) \\ \hline \end{array} \begin{array}{l} (1') \\ (7') \end{array}$$

$$\begin{array}{l} (2) \\ (8) \end{array} \begin{array}{|c|} \hline a^{-n} u(n) \\ \hline a^{-n} u(n-1) \\ \hline \end{array} \begin{array}{|c|} \hline \diagdown \quad \diagup \\ \hline \diagup \quad \diagdown \\ \hline \end{array} \begin{array}{|c|} \hline a^{-n-1} u(n) \\ \hline a^{-n+1} u(n-1) \\ \hline \end{array} \begin{array}{l} (2') \\ (8') \end{array}$$

$$\begin{array}{l} (5) \\ (3) \end{array} \begin{array}{|c|} \hline a^n u(-n-1) \\ \hline a^n u(-n) \\ \hline \end{array} \begin{array}{|c|} \hline \diagdown \quad \diagup \\ \hline \diagup \quad \diagdown \\ \hline \end{array} \begin{array}{|c|} \hline a^{n+1} u(-n-1) \\ \hline a^{n-1} u(-n) \\ \hline \end{array} \begin{array}{l} (5') \\ (3') \end{array}$$

$$\begin{array}{l} (6) \\ (4) \end{array} \begin{array}{|c|} \hline a^{-n} u(-n-1) \\ \hline a^{-n} u(-n) \\ \hline \end{array} \begin{array}{|c|} \hline \diagdown \quad \diagup \\ \hline \diagup \quad \diagdown \\ \hline \end{array} \begin{array}{|c|} \hline a^{-n-1} u(-n-1) \\ \hline a^{-n+1} u(-n) \\ \hline \end{array} \begin{array}{l} (6') \\ (4') \end{array}$$

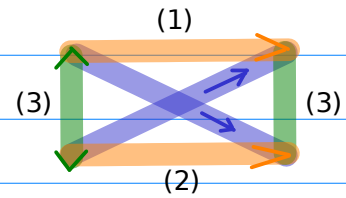
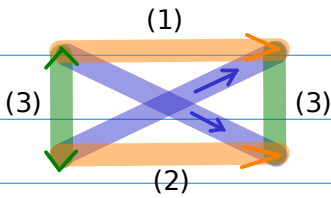

**(1) shift left exponent**

**(2) shift right exponent**

**(3) shift right/left range**

**(1) shift left exponent**

**(2) shift right exponent**

**(3) shift right/left range**

(SR, id) shift right exponent

(id, SR) shift right range

(SR, SR)

(SR, id) shift right exponent

(id, SR) shift right range

(SR, SR)

(SL, id) shift left exponent

(id, SL) shift left range

(SL, SL)

(SL, id) shift left exponent

(id, SL) shift left range

(SL, SL)

$$\begin{aligned} (id, SR) + (SR, id) &= (SR, SR) \\ (id, SL) + (SL, id) &= (SR, SL) \end{aligned}$$

$$\begin{aligned} (id, SR) + (SR, id) &= (SR, SR) \\ (id, SL) + (SL, id) &= (SR, SL) \end{aligned}$$

Unshifted Sequence

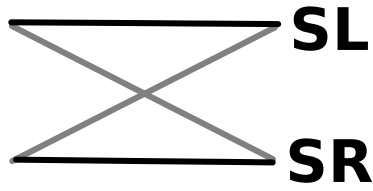

Shifted Sequence

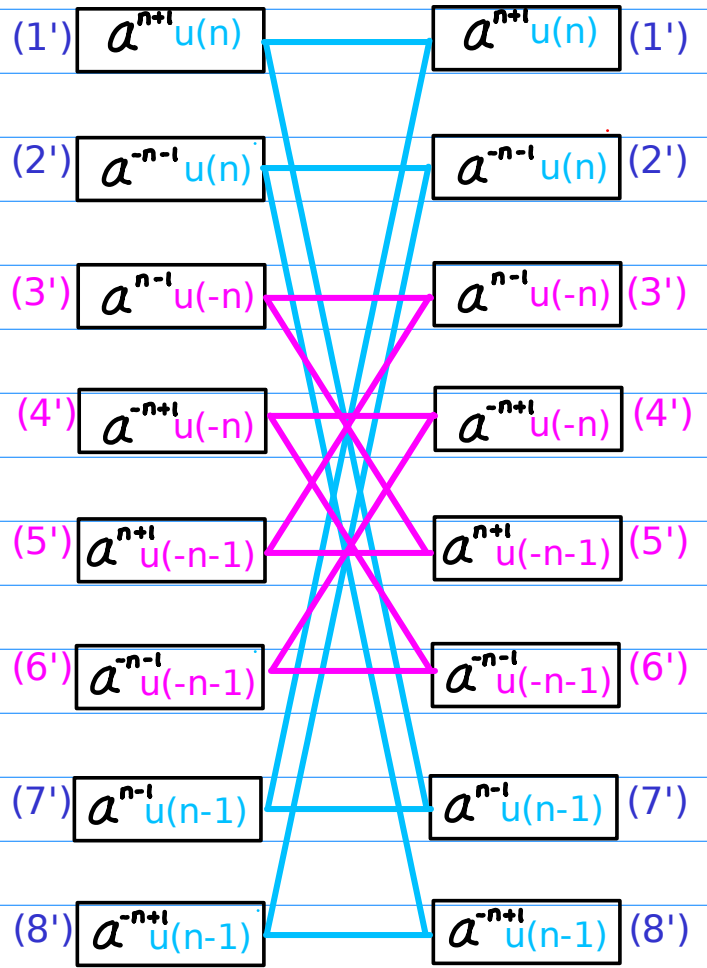
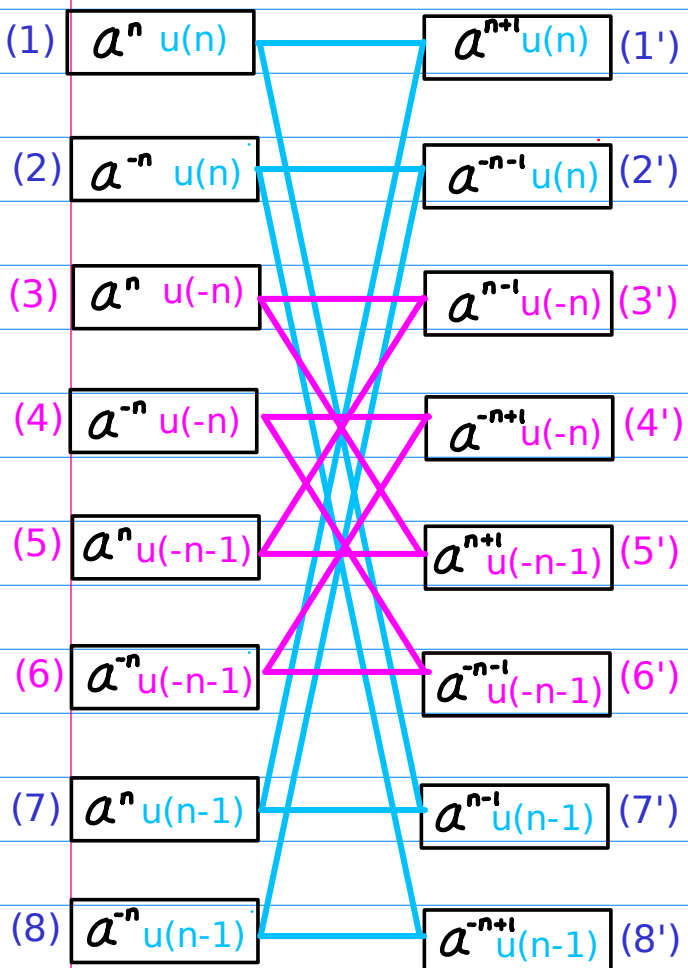
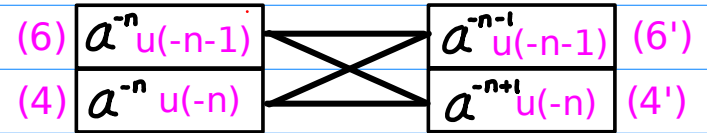
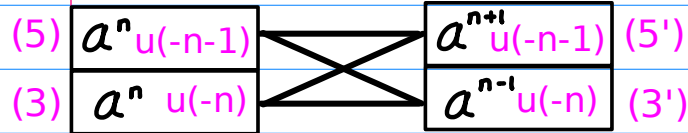
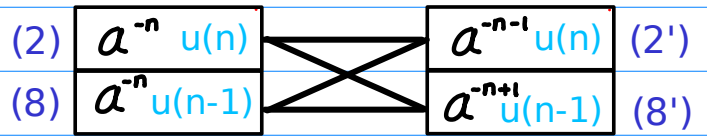
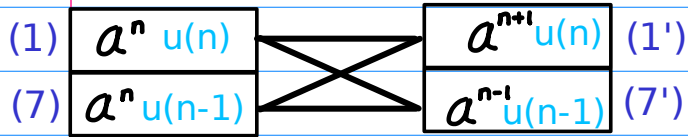



# Intra-Permutations over (1) ~ (8)

(1) $a^n u(n)$	$a^{n+i} u(n)$ (1')
(2) $a^{-n} u(n)$	$a^{-n-i} u(n)$ (2')
(3) $a^n u(-n)$	$a^{-i} u(-n)$ (3')
(4) $a^{-n} u(-n)$	$a^{-n+i} u(-n)$ (4')
(5) $a^n u(-n-1)$	$a^{n+i} u(-n-1)$ (5')
(6) $a^{-n} u(-n-1)$	$a^{-n-i} u(-n-1)$ (6')
(7) $a^n u(n-1)$	$a^{-i} u(n-1)$ (7')
(8) $a^{-n} u(n-1)$	$a^{-n+i} u(n-1)$ (8')

## A. Flipping

Base Inverting

Range Flipping

## B. Range Shifting = Range Flipping + Range Complementing

Range Flipping

Range Complementing

## C. Complementary Inverting

Base Inverting

Range Complementing

$a^n$  $\times$  $R(n)$ 

$a^n$	$a^{-n}$	$\times$	$u(n)$	$u(-n-1)$
		$\times$	$u(n-1)$	$u(-n)$

(1)	$a^n$	$u(n)$	$a^{-n}$	$u(n)$	(1)
-----	-------	--------	----------	--------	-----

(7)	$a^n$	$u(n-1)$	$a^{-n}$	$u(n-1)$	(7)
-----	-------	----------	----------	----------	-----

(5)	$a^n$	$u(-n-1)$	$a^{-n}$	$u(-n-1)$	(5)
-----	-------	-----------	----------	-----------	-----

(3)	$a^n$	$u(-n)$	$a^{-n}$	$u(-n)$	(3)
-----	-------	---------	----------	---------	-----

(1)	$a^n$	$u(n)$	$a^{-n}$	$u(n)$	(2)
-----	-------	--------	----------	--------	-----

(3)	$a^n$	$u(-n)$	$a^{-n}$	$u(-n)$	(4)
-----	-------	---------	----------	---------	-----

(5)	$a^n$	$u(-n-1)$	$a^{-n}$	$u(-n-1)$	(6)
-----	-------	-----------	----------	-----------	-----

(7)	$a^n$	$u(n-1)$	$a^{-n}$	$u(n-1)$	(8)
-----	-------	----------	----------	----------	-----

# Intra-Permutations over (1') ~ (8')

(1)  $a^n u(n)$

(2)  $a^{-n} u(n)$

(3)  $a^n u(-n)$

(4)  $a^{-n} u(-n)$

(5)  $a^n u(-n-1)$

(6)  $a^{-n} u(-n-1)$

(7)  $a^n u(n-1)$

(8)  $a^{-n} u(n-1)$

$a^{n+i} u(n)$  (1')

$a^{-n-i} u(n)$  (2')

$a^{n-i} u(-n)$  (3')

$a^{-n+i} u(-n)$  (4')

$a^{n+i} u(-n-1)$  (5')

$a^{-n-i} u(-n-1)$  (6')

$a^{n-i} u(n-1)$  (7')

$a^{-n+i} u(n-1)$  (8')

## D. Flipping2

Base Inverting

Shifted Range Flipping = Exponent Shifting2 + Range Flipping

## E. Shifting2 = Exponent Shifting2 + Range Shifting

Shifted Range Flipping = Exponent Shifting2 + Range Flipping

Range Complementing

## F. Complementary Inverting

Base Inverting

Range Complementing



$a^n$  $\times$  $R(n)$ 

$a^{n+1}$	$a^{-n-1}$
$a^{n-1}$	$a^{-n+1}$

 $\times$ 

$u(n)$	$u(-n-1)$
$u(n-1)$	$u(-n)$

(1')	$a^{n+1} u(n)$	$a^{-n-1} u(n)$
(7')	$a^{n-1} u(n-1)$	$a^{-n+1} u(n-1)$
(5')	$a^{n+1} u(-n-1)$	$a^{-n-1} u(-n-1)$
(3')	$a^{n-1} u(-n)$	$a^{-n+1} u(-n)$

(2')	<del><math>a^{n-1} u(n)</math></del>	<del><math>a^{-n+1} u(n)</math></del>
(8')	<del><math>a^{n+1} u(n-1)</math></del>	<del><math>a^{-n-1} u(n-1)</math></del>
(6')	<del><math>a^{n-1} u(-n-1)</math></del>	<del><math>a^{-n+1} u(-n-1)</math></del>
(4')	<del><math>a^{n+1} u(-n)</math></del>	<del><math>a^{-n-1} u(-n)</math></del>

(1')	$a^{n+1} u(n)$	$a^{-n-1} u(n)$
(3')	$a^{n-1} u(-n)$	$a^{-n+1} u(-n)$
(5')	$a^{n+1} u(-n-1)$	$a^{-n-1} u(-n-1)$
(7')	$a^{n-1} u(n-1)$	$a^{-n+1} u(n-1)$

(2')	<del><math>a^{n-1} u(n)</math></del>	<del><math>a^{-n+1} u(n)</math></del>
(4')	<del><math>a^{n+1} u(-n)</math></del>	<del><math>a^{-n-1} u(-n)</math></del>
(6')	<del><math>a^{n-1} u(-n-1)</math></del>	<del><math>a^{-n+1} u(-n-1)</math></del>
(8')	<del><math>a^{n+1} u(n-1)</math></del>	<del><math>a^{-n-1} u(n-1)</math></del>

$$a^n \times R(n)$$

$$\begin{bmatrix} a^{n+1} & a^{-n-1} \\ a^{n-1} & a^{-n+1} \end{bmatrix} \times \begin{bmatrix} u(n) & u(-n-1) \\ u(n-1) & u(-n) \end{bmatrix}$$

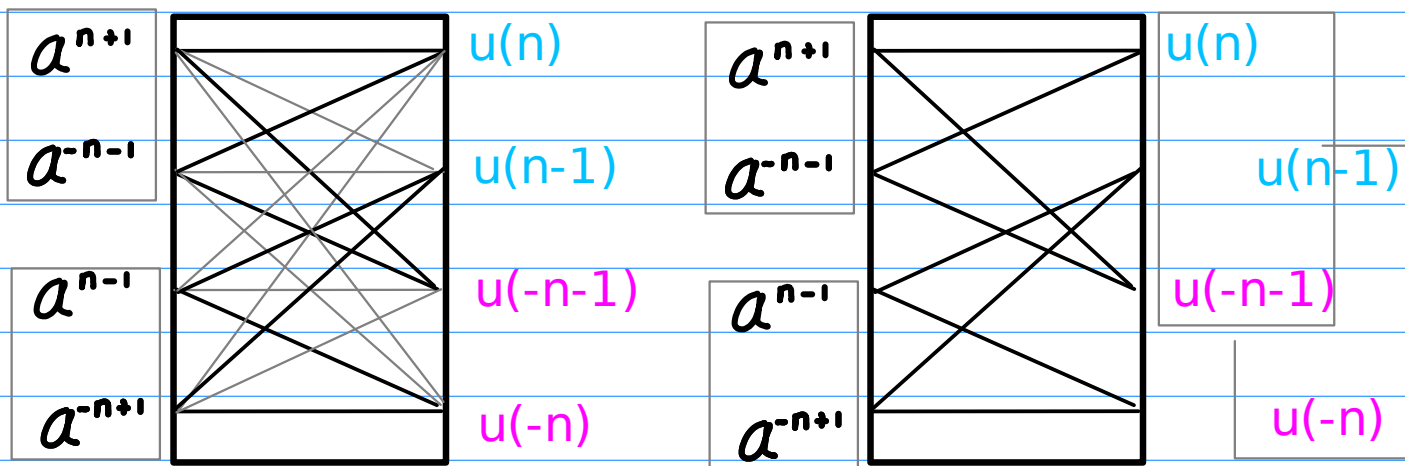

$$\begin{aligned} n &\leftarrow n+2 \text{ or} \\ n &\leftarrow n-2 \end{aligned}$$

<p>(1') <math>a^{n+1}</math> <math>u(n)</math> <math>a^{-n-1}</math> <math>u(n)</math></p> <p>(3') <math>a^{n-1}</math> <math>u(-n)</math> <math>a^{-n+1}</math> <math>u(-n)</math></p> <p>(5') <math>a^{n+1}</math> <math>u(-n-1)</math> <math>a^{-n-1}</math> <math>u(-n-1)</math></p> <p>(7') <math>a^{n-1}</math> <math>u(n-1)</math> <math>a^{-n+1}</math> <math>u(n-1)</math></p>	<p>(2') <math>a^{n-1}</math> <math>u(n)</math> <math>a^{-n+1}</math> <math>u(n)</math></p> <p>(4') <math>a^{n+1}</math> <math>u(-n)</math> <math>a^{-n-1}</math> <math>u(-n)</math></p> <p>(6') <math>a^{n-1}</math> <math>u(-n-1)</math> <math>a^{-n+1}</math> <math>u(-n-1)</math></p> <p>(8') <math>a^{n+1}</math> <math>u(n-1)</math> <math>a^{-n-1}</math> <math>u(n-1)</math></p>
---	---

## permutation over (1) ~ (8)

### A. Flipping

Base Inverting  
Range Flipping

### B. Range Shifting = Range Flipping + Range Complementing

Range Flipping  
Range Complementing

### C. Complementary Inverting

Base Inverting  
Range Complementing

## permutation over (1') ~ (8')

### D. Flipping<sub>2</sub>

Base Inverting  
Shifted Range Flipping = Exponent Shifting<sub>2</sub> + Range Flipping

### E. Shifting<sub>2</sub> = Exponent Shifting<sub>2</sub> + Range Shifting

Shifted Range Flipping = Exponent Shifting<sub>2</sub> + Range Flipping  
Range Complementing

### F. Complementary Inverting

Base Inverting  
Range Complementing

**Range Shifting = Range Flipping + Range Complementing**

**Shifted Range Flipping = Exponent Shifting<sub>2</sub> + Range Flipping**

**Shifting<sub>2</sub> = Shifted Range Flipping + Range Complementing**

**= Exponent Shifting<sub>2</sub> + Range (Flipping+Complementing)**

**= Exponent Shifting<sub>2</sub> + Range Shifting**

## permutation over (1) ~ (8)

<b>A. Flipping</b>	(1) - (4)	(5) - (8)
<b>Base Inverting</b>	(2) - (3)	(6) - (7)
<b>Range Flipping</b>	(3) - (2)	(7) - (6)
	(4) - (1)	(8) - (5)
<b>B. Range Shifting</b>	(1) - (7)	(5) - (3)
<b>Range Flipping</b>	(2) - (8)	(6) - (4)
<b>Range Complementing</b>	(3) - (5)	(7) - (1)
	(4) - (6)	(8) - (2)
<b>C. Complementary Inverting</b>	(1) - (6)	(5) - (2)
<b>Base Inverting</b>	(6) - (1)	(6) - (1)
<b>Range Complementing</b>	(2) - (5)	(7) - (4)
	(5) - (2)	(8) - (3)

## permutation over (1') ~ (8')

<b>D. Flipping2</b>	(1') - (4')	(5') - (8')
<b>Base Inverting</b>	(2') - (3')	(6') - (7')
<b>Shifted Range Flipping</b>	(3') - (2')	(7') - (6')
	(4') - (1')	(8') - (5')
<b>E. Shifting2</b>	(1') - (7')	(5') - (3')
<b>Shifted Range Flipping</b>	(2') - (8')	(6') - (4')
<b>Range Complementing</b>	(3') - (5')	(7') - (1')
	(4') - (6')	(8') - (2')
<b>F. Complementary Inverting</b>	(1') - (6')	(5') - (2')
<b>Base Inverting</b>	(6') - (1')	(6') - (1')
<b>Range Complementing</b>	(2') - (5')	(7') - (4')
	(5') - (2')	(8') - (3')



## permutation over (1) ~ (8)

	A	B	C
Base Inverting	X		X
Range Flipping	X	X	
Range Complementing		X	X

## permutation over (1') ~ (8')

	D	E	F
Base Inverting	X		X
Shifted Range Flipping	X	X	
Range Complementing		X	X

**Range Shifting = Range Flipping + Range Complementing**  
**Shifted Range Flipping = Exponent Shifting2 + Range Flipping**

**Shifting2 = Shifted Range Flipping + Range Complementing**  
**= Exponent Shifting2 + Range (Flipping+Complementing)**  
**= Exponent Shifting2 + Range Shifting**



**Over (1) ~ (8)**

**Base Inverting**

$$a^n \longleftrightarrow a^{-n}$$

**Range Flipping**

$$R(n) \longleftrightarrow R(-n)$$

**Range Complementing**

$$R(n) \longleftrightarrow \overline{R(n)}$$

**Over (1') ~ (8')**

**Base Inverting**

$$a^n \longleftrightarrow a^{-n}$$

**Shifted Range Flipping**

$$a^n R(n) \longleftrightarrow a^{sh2(n)} R(-n)$$

**Range Complementing**

$$R(n) \longleftrightarrow \overline{R(n)}$$



**A.I Flipping**  
**Base Inverting**  
**Range Flipping**

$$a^n \longleftrightarrow a^{-n}$$

$$R(n) \longleftrightarrow R(-n)$$

$$a^n R(n) \longleftrightarrow a^{-n} R(-n)$$

**D.I Flipping2**  
**Base Inverting**  
**Shifted Range Flipping**

$$a^n \longleftrightarrow a^{-n}$$

$$a^n R(n) \longleftrightarrow a^{sh2(n)} R(-n)$$

$$a^n R(n) \longleftrightarrow a^{-sh2(n)} R(-n)$$

**B.I Range Shifting**  
**Range Flipping**  
**Range Complementing**

$$R(n) \longleftrightarrow R(-n)$$

$$R(n) \longleftrightarrow \overline{R(n)}$$

$$R(n) \longleftrightarrow \overline{R(-n)}$$

**E.I Shifting2**  
**Shifted Range Flipping**  
**Range Complementing**

$$a^n R(n) \longleftrightarrow a^{sh2(n)} R(-n)$$

$$R(n) \longleftrightarrow \overline{R(n)}$$

$$a^n R(n) \longleftrightarrow a^{sh2(n)} \overline{R(-n)}$$

**C.I Complementary Inverting**  
**Base Inverting**  
**Range Complementing**

$$a^n \longleftrightarrow a^{-n}$$

$$R(n) \longleftrightarrow \overline{R(n)}$$

$$a^n R(n) \longleftrightarrow a^{-n} \overline{R(n)}$$

**F.I Complementary Inverting**  
**Base Inverting**  
**Range Complementing**

$$a^n \longleftrightarrow a^{-n}$$

$$R(n) \longleftrightarrow \overline{R(n)}$$

$$a^n R(n) \longleftrightarrow a^{-n} \overline{R(n)}$$

**A.I Flipping**  
**Base Inverting**  
**Range Flipping**

**D.I Flipping2**  
**Base Inverting**  
**Shifted Range Flipping**

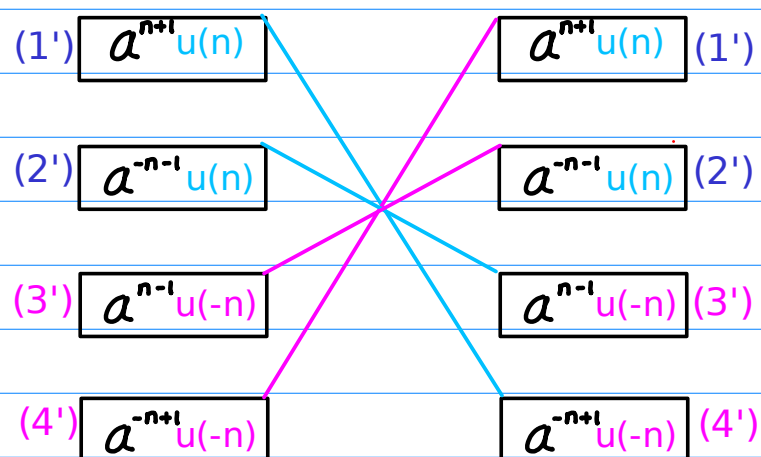
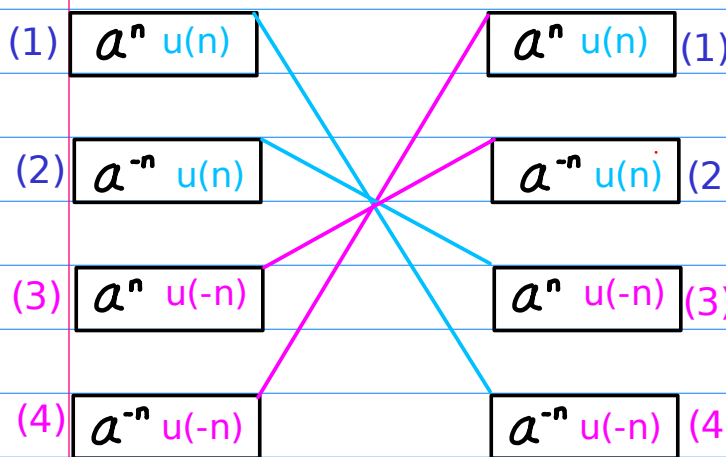
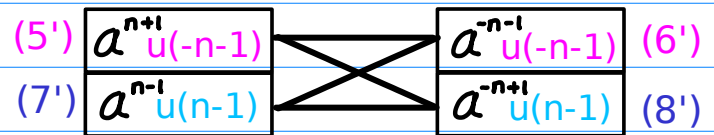
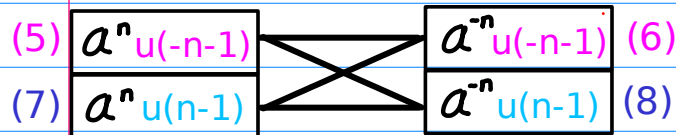
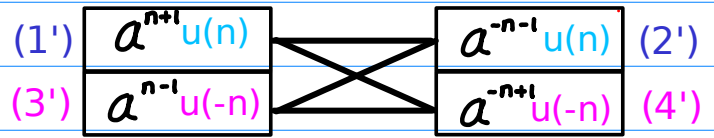
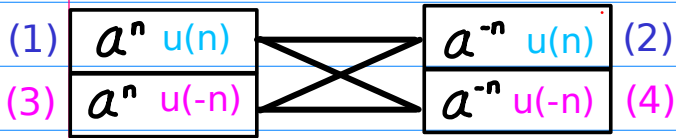

(1) - (4)  
 (2) - (3)  
 (3) - (2)  
 (4) - (1)

(5) - (8)  
 (6) - (7)  
 (7) - (6)  
 (8) - (5)

(1') - (4')  
 (2') - (3')  
 (3') - (2')  
 (4') - (1')

(5') - (8')  
 (6') - (7')  
 (7') - (6')  
 (8') - (5')

**B.I Range Shifting  
Range Flipping  
Range Complementing**

**E.I Shifting2  
Shifted Range Flipping  
Range Complementing**

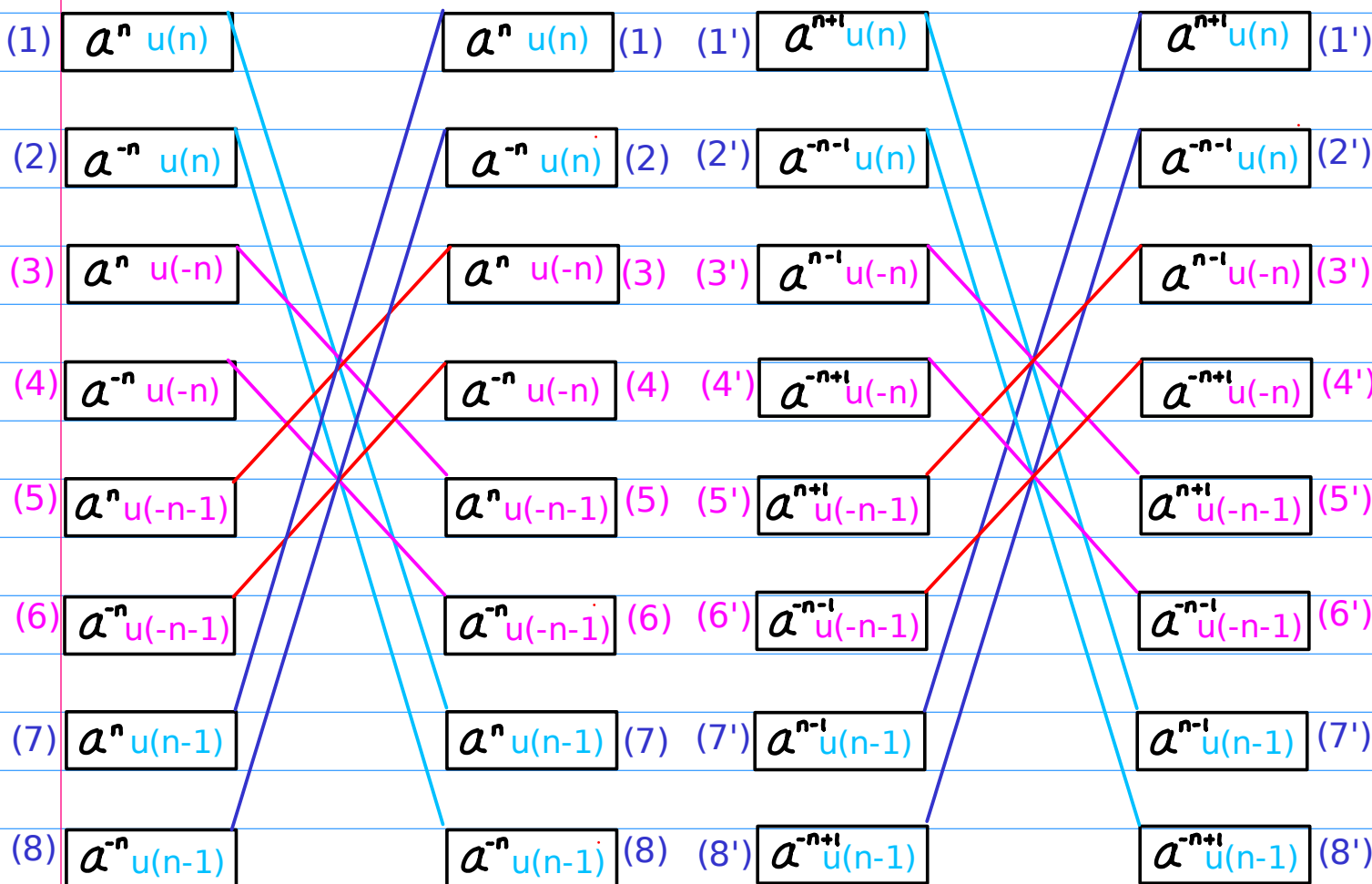
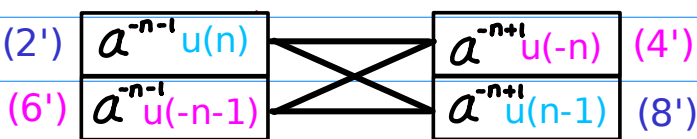
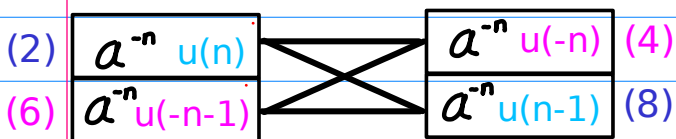
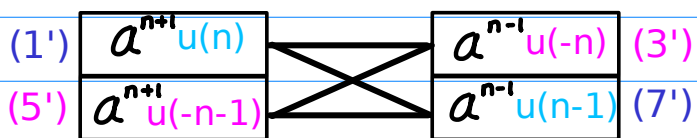
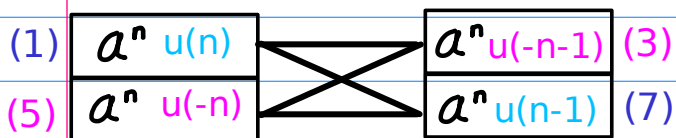

(1) - (7)      (5) - (3)  
 (2) - (8)      (6) - (4)  
 (3) - (5)      (7) - (1)  
 (4) - (6)      (8) - (2)

(1') - (7')      (5') - (3')  
 (2') - (8')      (6') - (4')  
 (3') - (5')      (7') - (1')  
 (4') - (6')      (8') - (2')

### C.I Complementary Inverting Base Inverting Range Complementing

### F.I Complementary Inverting Base Inverting Range Complementing

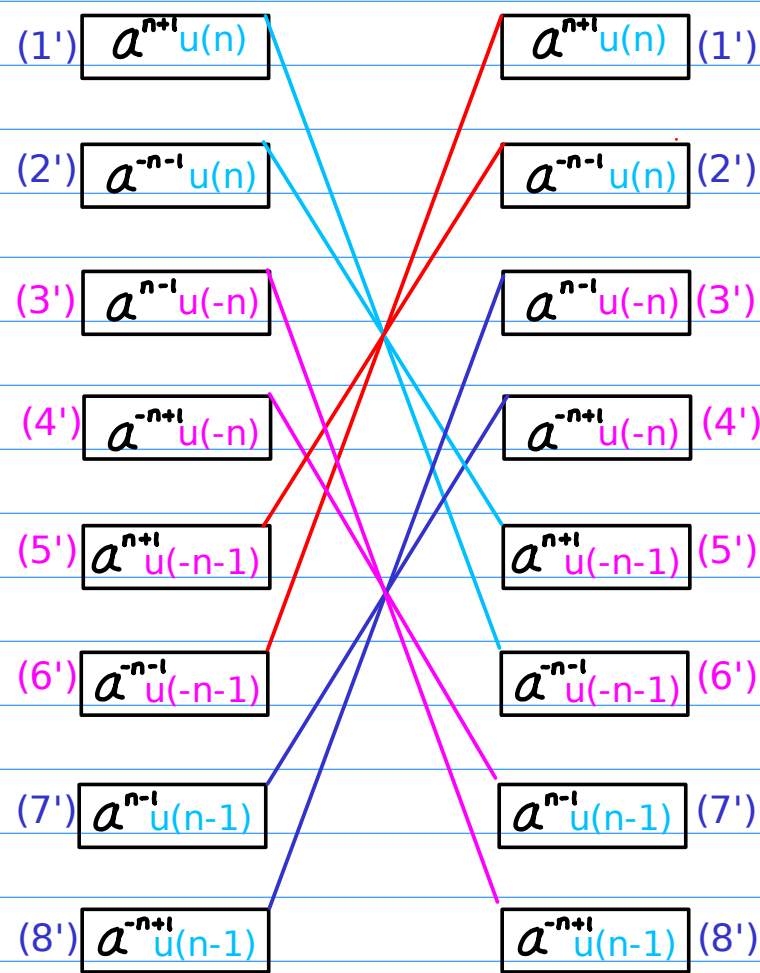
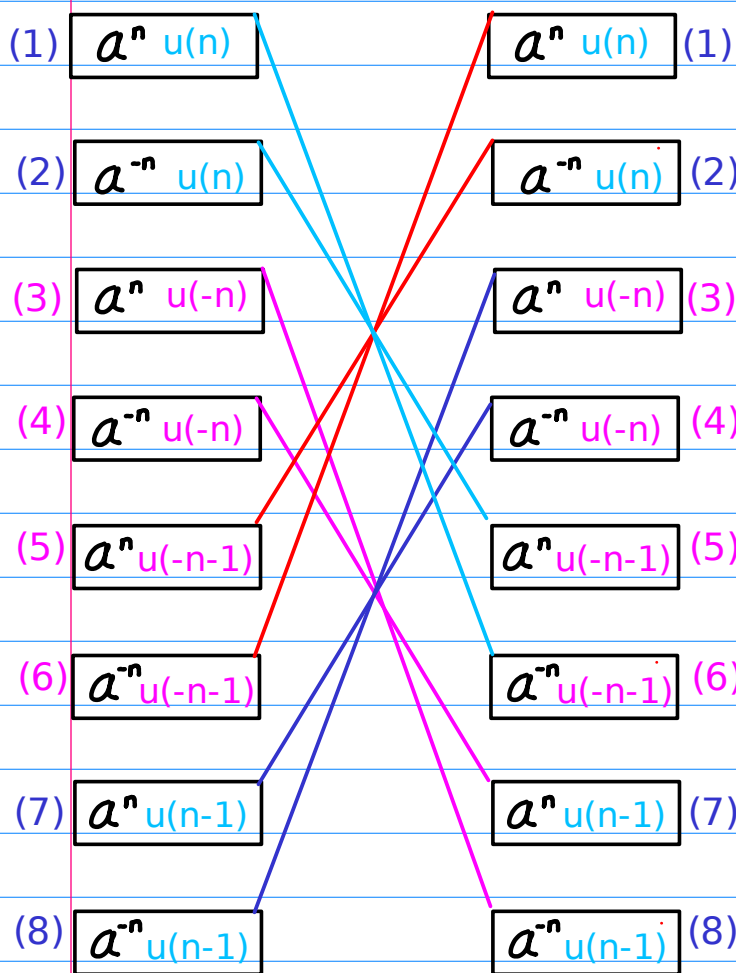
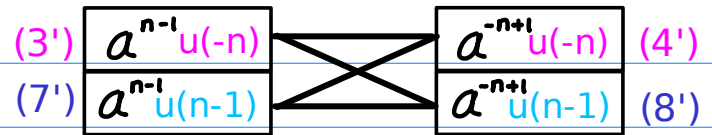
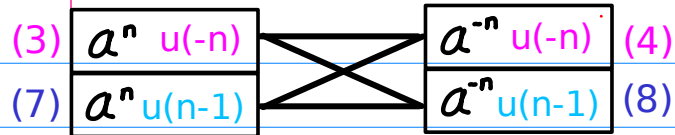
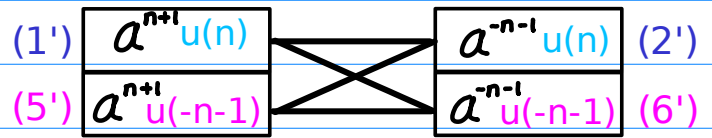
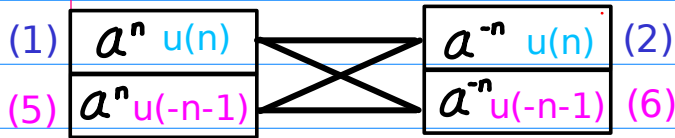

- (1) - (6)
- (6) - (1)
- (2) - (5)
- (5) - (2)
- (5) - (2)
- (8) - (3)

- (1') - (6')
- (6') - (1')
- (2') - (5')
- (5') - (2')
- (5') - (2')
- (8') - (3')



## A.I Flipping

- (1) Base Inverting
- (2) Range Flipping

$$\begin{array}{|c|} \hline (1) \ a^n u(n) \\ \hline (3) \ a^n u(-n) \\ \hline \end{array} \begin{array}{c} \diagdown \quad \diagup \\ \diagup \quad \diagdown \end{array} \begin{array}{|c|} \hline a^{-n} u(n) \ (2) \\ \hline a^{-n} u(-n) \ (4) \\ \hline \end{array}$$

$$\begin{array}{|c|} \hline (5) \ a^n u(-n-1) \\ \hline (7) \ a^n u(n-1) \\ \hline \end{array} \begin{array}{c} \diagdown \quad \diagup \\ \diagup \quad \diagdown \end{array} \begin{array}{|c|} \hline a^{-n} u(-n-1) \ (6) \\ \hline a^{-n} u(n-1) \ (8) \\ \hline \end{array}$$

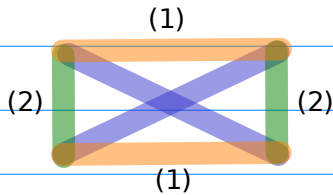

## D.I Flipping2

- (1) Base Inverting
- (2) Shifted Range Flipping

$$\begin{array}{|c|} \hline (1') \ a^{n+1} u(n) \\ \hline (3') \ a^{n-1} u(-n) \\ \hline \end{array} \begin{array}{c} \diagdown \quad \diagup \\ \diagup \quad \diagdown \end{array} \begin{array}{|c|} \hline a^{-n-1} u(n) \ (2') \\ \hline a^{-n+1} u(-n) \ (4') \\ \hline \end{array}$$

$$\begin{array}{|c|} \hline (5') \ a^{n+1} u(-n-1) \\ \hline (7') \ a^{n-1} u(n-1) \\ \hline \end{array} \begin{array}{c} \diagdown \quad \diagup \\ \diagup \quad \diagdown \end{array} \begin{array}{|c|} \hline a^{-n-1} u(-n-1) \ (6') \\ \hline a^{-n+1} u(n-1) \ (8') \\ \hline \end{array}$$

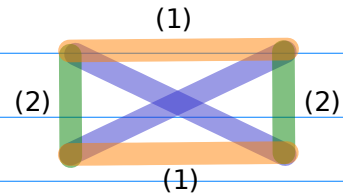

$$\begin{array}{ccc} a^n & \xleftrightarrow{(1)} & a^{-n} \\ R(n) & \xleftrightarrow{(2)} & R(-n) \\ a^n R(n) & \longleftrightarrow & a^{-n} R(-n) \end{array}$$

$$\begin{array}{ccc} a^n & \xleftrightarrow{(1)} & a^{-n} \\ a^n R(n) & \xleftrightarrow{(2)} & a^{sh2(n)} R(-n) \\ a^n R(n) & \longleftrightarrow & a^{-sh2(n)} R(-n) \end{array}$$

$b^n$	$b^{-n}$
$a^n$	$a^{-n}$
$a^{-n}$	$a^n$

$b^n$	$b^{-n}$
$a^{(n+1)}$	$a^{-(n+1)}$
$a^{-(n+1)}$	$a^{(n+1)}$
$a^{(n-1)}$	$a^{-(n-1)}$
$a^{-(n-1)}$	$a^{(n-1)}$

$R(n)$	$R(-n)$
$u(n)$	$u(-n)$
$u(n-1)$	$u(-n-1)$
$u(-n)$	$u(n)$
$u(-n-1)$	$u(n-1)$

$R(n)$	$R(-n)$
$u(n)$	$u(-n)$
$u(n-1)$	$u(-n-1)$
$u(-n)$	$u(n)$
$u(-n-1)$	$u(n-1)$

**B.I Range Shifting**  
**(1) Range Complementing**  
**(2) Range Flipping**

**E.I Shifting2**  
**(1) Shifted Range Flipping**  
**(2) Range Complementing**

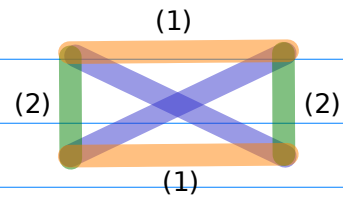
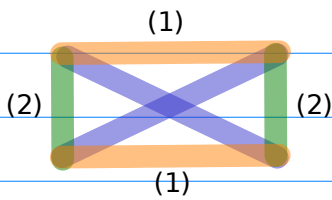
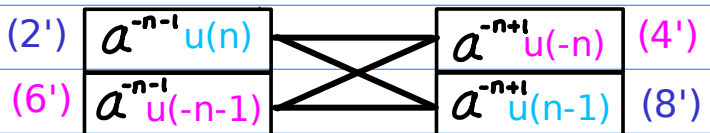
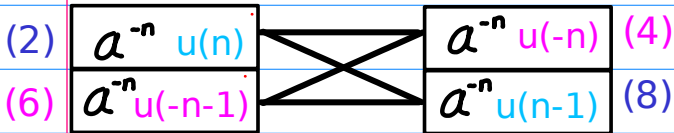
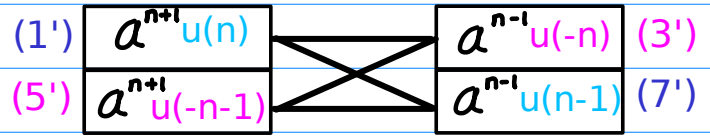
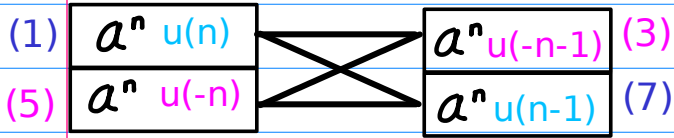

$$R(n) \xleftrightarrow{(1)} R(-n)$$

$$R(n) \xleftrightarrow{(2)} \overline{R(n)}$$

$$R(n) \longleftrightarrow \overline{R(-n)}$$

$$a^n R(n) \xleftrightarrow{(1)} a^{sh2(n)} \overline{R(-n)}$$

$$R(n) \xleftrightarrow{(2)} \overline{R(n)}$$

$$a^n R(n) \longleftrightarrow a^{sh2(n)} \overline{R(-n)}$$

$b^n$	$b^{-n}$
$a^{(n+1)}$	$a^{(n-1)}$
$a^{-(n+1)}$	$a^{-(n-1)}$
$a^{(n-1)}$	$a^{(n+1)}$
$a^{-(n-1)}$	$a^{-(n+1)}$

$R(n)$	$\overline{R(-n)}$
$u(n)$	$u(n-1)$
$u(n-1)$	$u(n)$
$u(-n)$	$u(-n-1)$
$u(-n-1)$	$u(-n)$

$R(n)$	$\overline{R(-n)}$
$u(n)$	$u(n-1)$
$u(n-1)$	$u(n)$
$u(-n)$	$u(-n-1)$
$u(-n-1)$	$u(-n)$

## C.I Complementary Inverting

(1) Base Inverting  
(2) Range Complementing

## F.I Complementary Inverting

(1) Base Inverting  
(2) Range Complementing

$$\begin{array}{|c|} \hline (1) \quad a^n u(n) \\ \hline (5) \quad a^n u(-n-1) \\ \hline \end{array} \begin{array}{c} \diagdown \quad \diagup \\ \diagup \quad \diagdown \end{array} \begin{array}{|c|} \hline a^{-n} u(n) \quad (2) \\ \hline a^{-n} u(-n-1) \quad (6) \\ \hline \end{array}$$

$$\begin{array}{|c|} \hline (1') \quad a^{n+1} u(n) \\ \hline (5') \quad a^{n+1} u(-n-1) \\ \hline \end{array} \begin{array}{c} \diagdown \quad \diagup \\ \diagup \quad \diagdown \end{array} \begin{array}{|c|} \hline a^{-n-1} u(n) \quad (2') \\ \hline a^{-n-1} u(-n-1) \quad (6') \\ \hline \end{array}$$

$$\begin{array}{|c|} \hline (3) \quad a^n u(-n) \\ \hline (7) \quad a^n u(n-1) \\ \hline \end{array} \begin{array}{c} \diagdown \quad \diagup \\ \diagup \quad \diagdown \end{array} \begin{array}{|c|} \hline a^{-n} u(-n) \quad (4) \\ \hline a^{-n} u(n-1) \quad (8) \\ \hline \end{array}$$

$$\begin{array}{|c|} \hline (3') \quad a^{-n-1} u(-n) \\ \hline (7') \quad a^{-n-1} u(n-1) \\ \hline \end{array} \begin{array}{c} \diagdown \quad \diagup \\ \diagup \quad \diagdown \end{array} \begin{array}{|c|} \hline a^{-n+1} u(-n) \quad (4') \\ \hline a^{-n+1} u(n-1) \quad (8') \\ \hline \end{array}$$

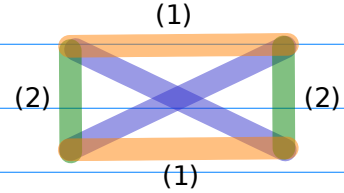
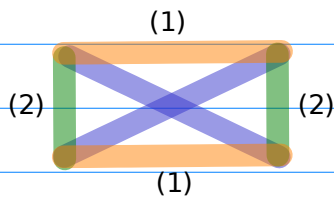

$$\begin{array}{ccc} a^n & \xleftrightarrow{(1)} & a^{-n} \\ R(n) & \xleftrightarrow{(2)} & \overline{R(n)} \\ a^n R(n) & \longleftrightarrow & a^{-n} \overline{R(n)} \end{array}$$

$$\begin{array}{ccc} a^n & \xleftrightarrow{(1)} & a^{-n} \\ R(n) & \xleftrightarrow{(2)} & \overline{R(n)} \\ a^n R(n) & \longleftrightarrow & a^{-n} \overline{R(n)} \end{array}$$

$b^n$	$b^{-n}$
$a^n$	$a^{-n}$
$a^{-n}$	$a^n$

$b^n$	$b^{-n}$
$a^{(n+1)}$	$a^{-(n+1)}$
$a^{-(n+1)}$	$a^{(n+1)}$
$a^{(n-1)}$	$a^{-(n-1)}$
$a^{-(n-1)}$	$a^{(n-1)}$

$R(n)$	$\overline{R(n)}$
$u(n)$	$u(-n-1)$
$u(n-1)$	$u(-n)$
$u(-n)$	$u(n)$
$u(-n-1)$	$u(n-1)$

$R(n)$	$\overline{R(n)}$
$u(n)$	$u(-n-1)$
$u(n-1)$	$u(-n)$
$u(-n)$	$u(n)$
$u(-n-1)$	$u(n-1)$



## A.I Flipping

- (1) Base Inverting
- (2) Range Flipping

$$\begin{array}{ccc}
 a^n & \xleftrightarrow{(1)} & a^{-n} \\
 R(n) & \xleftrightarrow{(2)} & R(-n) \\
 a^n R(n) & \longleftrightarrow & a^{-n} R(-n)
 \end{array}$$

## D.I Flipping2

- (1) Base Inverting
- (2) Shifted Range Flipping

$$\begin{array}{ccc}
 a^n & \xleftrightarrow{(1)} & a^{-n} \\
 a^n R(n) & \xleftrightarrow{(2)} & a^{sh2(n)} R(-n) \\
 a^n R(n) & \longleftrightarrow & a^{-sh2(n)} R(-n)
 \end{array}$$

$$\begin{array}{ccc}
 a^n R(n) & \xrightarrow{(1)} & a^{-n} R(n) \\
 & \xrightarrow{(2)} & a^{-n} R(-n)
 \end{array}$$

$$\begin{array}{ccc}
 a^n R(n) & \xrightarrow{(1)} & a^{-n} R(n) \\
 & \xrightarrow{(2)} & a^{-sh2(n)} R(-n)
 \end{array}$$

$$\begin{array}{ccc}
 a^n R(n) & \xrightarrow{(2)} & a^n R(-n) \\
 & \xrightarrow{(1)} & a^{-n} R(-n)
 \end{array}$$

$$\begin{array}{ccc}
 a^n R(n) & \xrightarrow{(2)} & a^{sh2(n)} R(-n) \\
 & \xrightarrow{(1)} & a^{-sh2(n)} R(-n)
 \end{array}$$

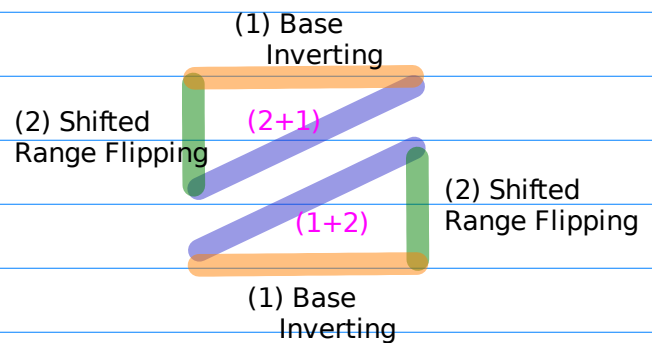
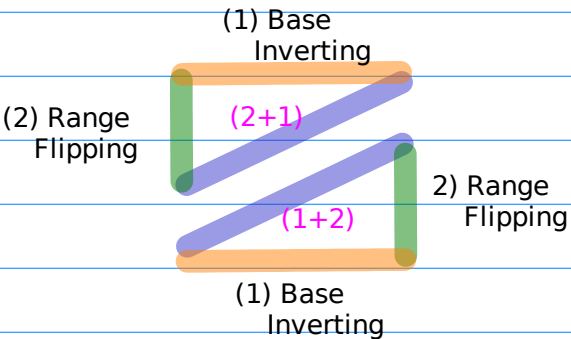
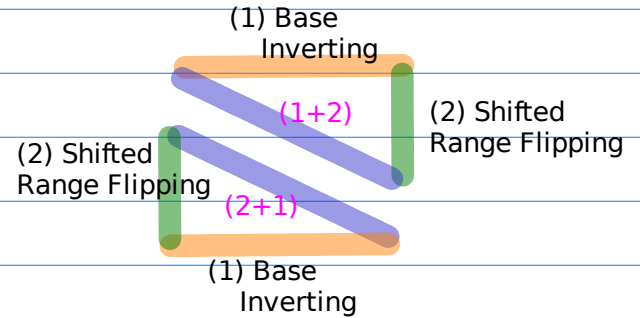
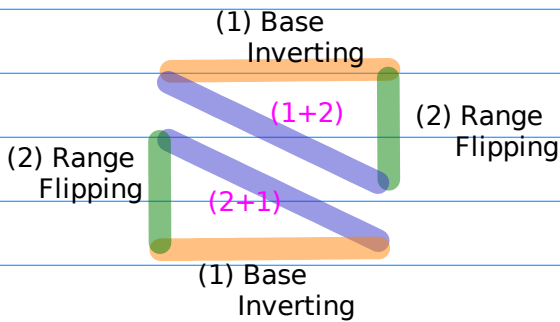

**B.I Range Shifting**  
**(1) Range Complementing**  
**(2) Range Flipping**

**E.I Shifting2**  
**(1) Shifted Range Flipping**  
**(2) Range Complementing**

$$R(n) \xleftrightarrow{(1)} R(-n)$$

$$R(n) \xleftrightarrow{(2)} \overline{R(n)}$$

$$R(n) \longleftrightarrow \overline{R(-n)}$$

$$a^n R(n) \xleftrightarrow{(1)} a^{sh2(n)} R(-n)$$

$$R(n) \xleftrightarrow{(2)} \overline{R(n)}$$

$$a^n R(n) \longleftrightarrow a^{sh2(n)} \overline{R(-n)}$$

$$a^n R(n) \xrightarrow{(1)} a^{-n} R(n)$$

$$\xrightarrow{(2)} a^{-n} \overline{R(n)}$$

$$a^n R(n) \xrightarrow{(1)} a^{-n} R(n)$$

$$\xrightarrow{(2)} a^{-sh2(n)} R(-n)$$

$$a^n rng(n) \xrightarrow{(2)} a^n \overline{R(n)}$$

$$\xrightarrow{(1)} a^{-n} \overline{R(n)}$$

$$a^n R(n) \xrightarrow{(2)} a^{sh2(n)} R(-n)$$

$$\xrightarrow{(1)} a^{-sh2(n)} R(-n)$$

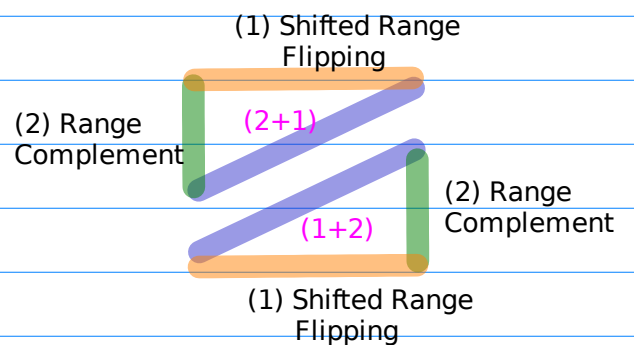
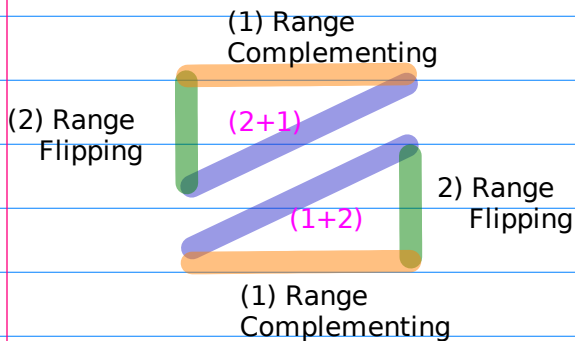
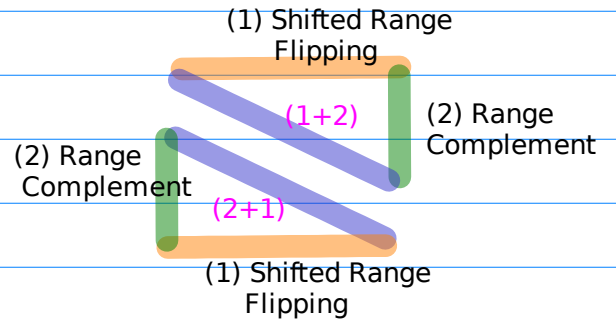
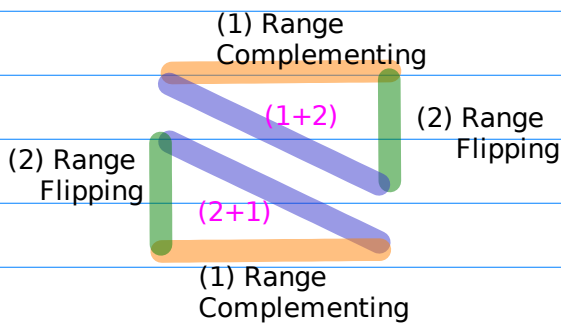

## C.I Complementary Inverting

(1) Base Inverting  
(2) Range Complementing

## F.I Complementary Inverting

(1) Base Inverting  
(2) Range Complementing

$$\begin{array}{ccc}
 a^n & \xleftrightarrow{(1)} & a^{-n} \\
 R(n) & \xleftrightarrow{(2)} & \overline{R(n)} \\
 a^n R(n) & \longleftrightarrow & a^{-n} \overline{R(n)}
 \end{array}$$

$$\begin{array}{ccc}
 a^n & \xleftrightarrow{(1)} & a^{-n} \\
 R(n) & \xleftrightarrow{(2)} & \overline{R(n)} \\
 a^n R(n) & \longleftrightarrow & a^{-n} \overline{R(n)}
 \end{array}$$

$$\begin{array}{ccc}
 a^n R(n) & \xrightarrow{(1)} & a^{-n} R(n) \\
 & \xrightarrow{(2)} & a^{-n} \overline{R(n)}
 \end{array}$$

$$\begin{array}{ccc}
 a^n R(n) & \xrightarrow{(1)} & a^{-n} R(n) \\
 & \xrightarrow{(2)} & a^{-n} \overline{R(n)}
 \end{array}$$

$$\begin{array}{ccc}
 a^n R(n) & \xrightarrow{(2)} & a^n \overline{R(n)} \\
 & \xrightarrow{(1)} & a^{-n} \overline{R(n)}
 \end{array}$$

$$\begin{array}{ccc}
 a^n R(n) & \xrightarrow{(2)} & a^n \overline{R(n)} \\
 & \xrightarrow{(1)} & a^{-n} \overline{R(n)}
 \end{array}$$

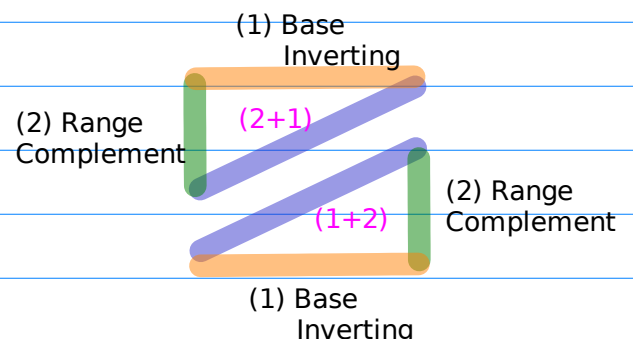
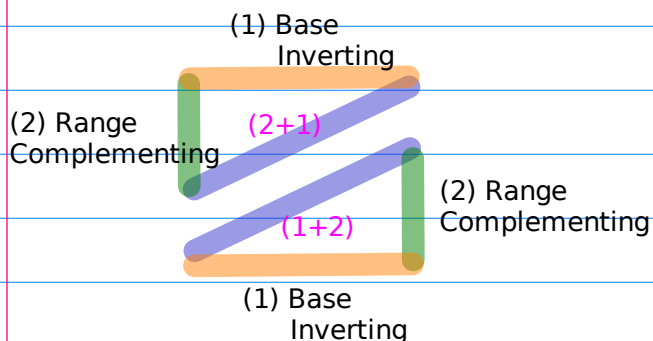
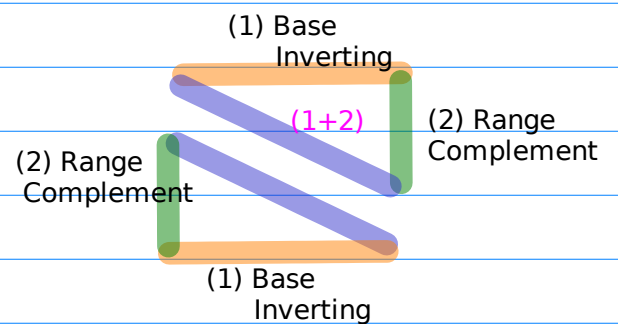
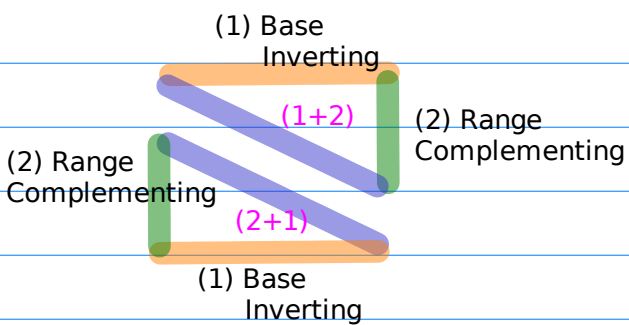





## A.I Flipping Base Inverting Range Flipping

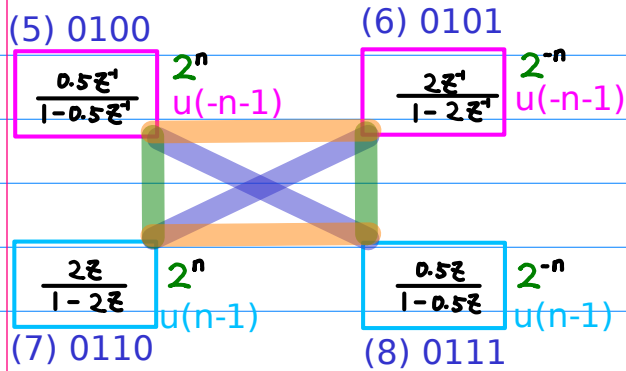
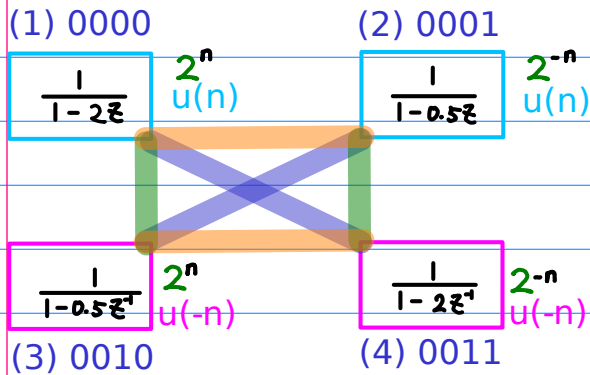

## D.I Flipping2 Base Inverting Shifted Range Flipping

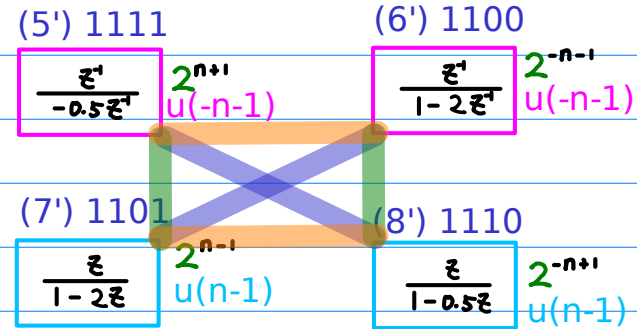
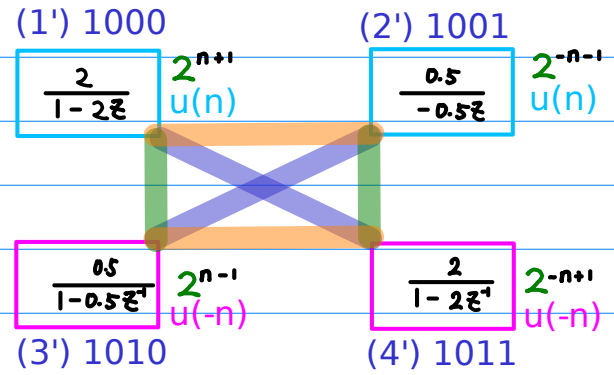

Shifted Range Flipping  
= Exponent Shifting2  
+ Range Flipping

$$a^n \longleftrightarrow a^{-n}$$

$$R(n) \longleftrightarrow R(-n)$$

$$a^n R(n) \longleftrightarrow a^{-n} R(-n)$$

$$a^n \longleftrightarrow a^{-n}$$

$$a^n R(n) \longleftrightarrow a^{sh2(n)} R(-n)$$

$$a^n R(n) \longleftrightarrow a^{-sh2(n)} R(-n)$$

## B.I Range Shifting Range Flipping Range Complementing

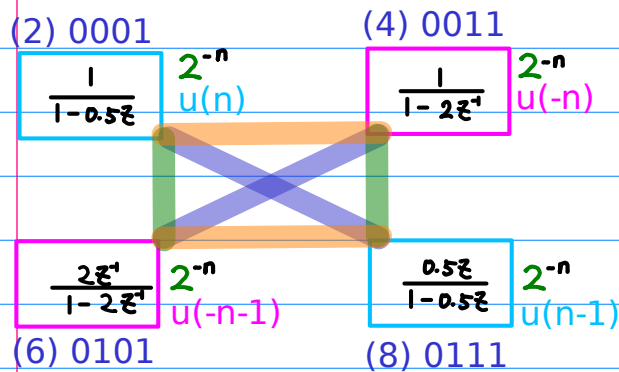
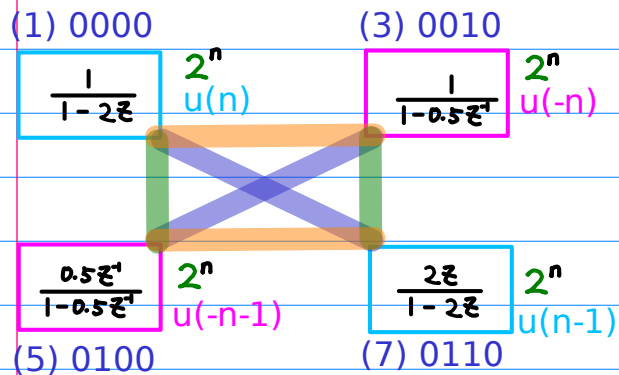

Range Shifting  
= Range Flipping  
+ Range Complementing

$$R(n) \longleftrightarrow R(-n)$$

$$R(n) \longleftrightarrow \overline{R(n)}$$

$$R(n) \longleftrightarrow \overline{R(-n)}$$

## E.I Shifting2 Shifted Range Flipping Range Complementing

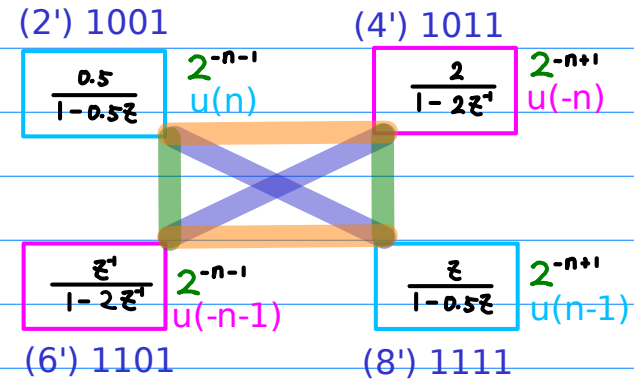
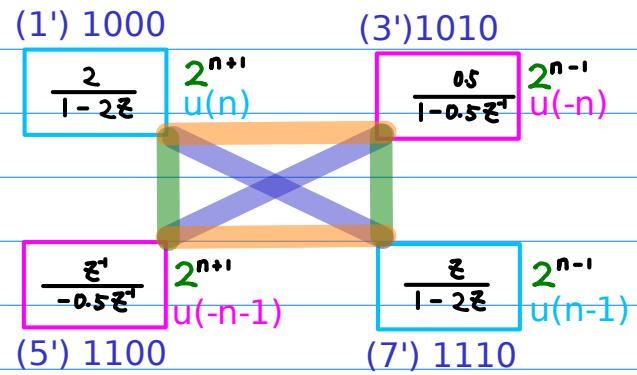

Shifted Range Flipping  
= Exponent Shifting2  
+ Range Flipping

$$a^n R(n) \longleftrightarrow a^{sh2(n)} R(-n)$$

$$R(n) \longleftrightarrow \overline{R(n)}$$

$$a^n R(n) \longleftrightarrow a^{sh2(n)} \overline{R(-n)}$$

### C.I Complementary Inverting Base Inverting Range Complementing

### F.I Complementary Inverting Base Inverting Range Complementing

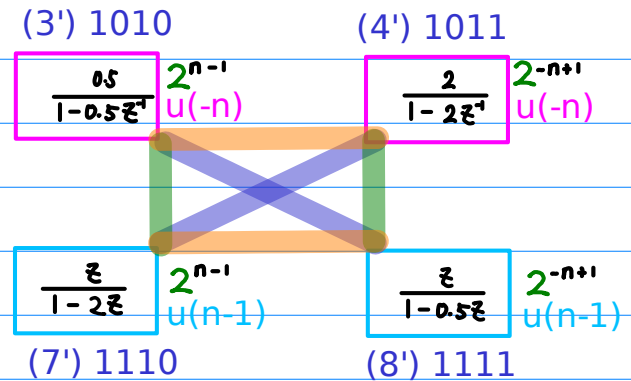
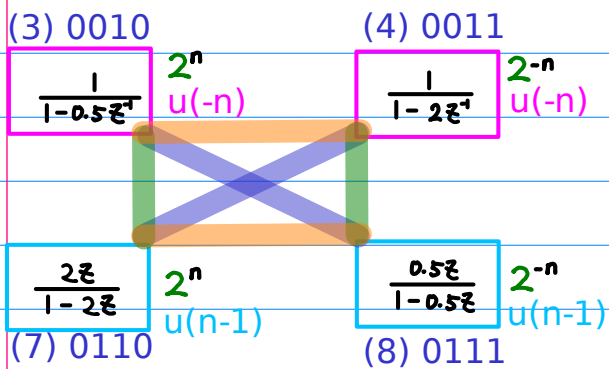
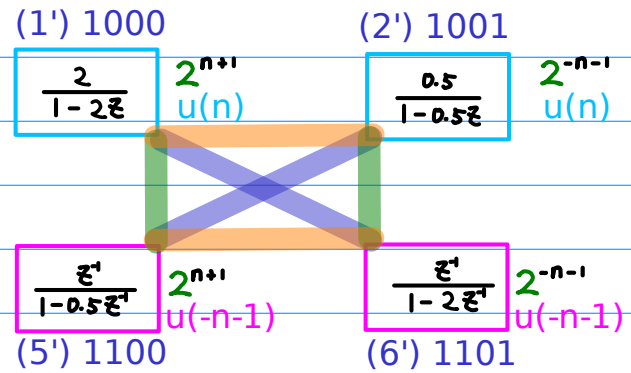
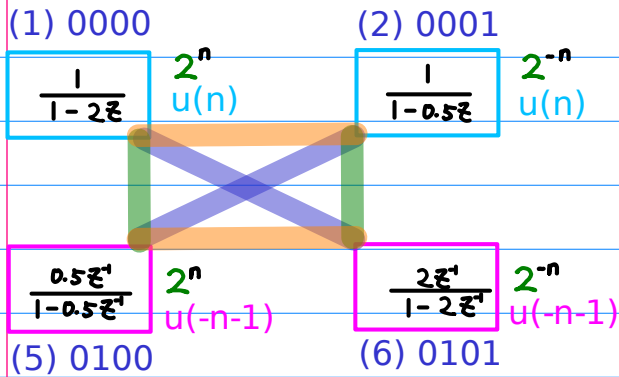

$$a^n \longleftrightarrow a^{-n}$$

$$R(n) \longleftrightarrow \overline{R(n)}$$

$$a^n \longleftrightarrow a^{-n}$$

$$R(n) \longleftrightarrow \overline{R(n)}$$

$$a^n R(n) \longleftrightarrow a^{-n} \overline{R(n)}$$

$$a^n R(n) \longleftrightarrow a^{-n} \overline{R(n)}$$



## A.II Flipping Base Inverting Range Flipping

(1) 0000

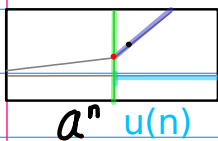

(4) 0011

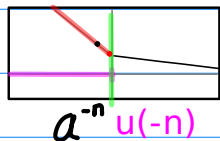

(3) 0010

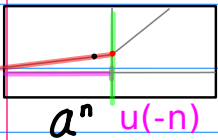

(2) 0001

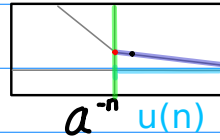

(5) 0100

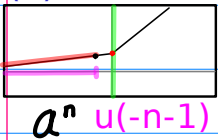

(8) 0111

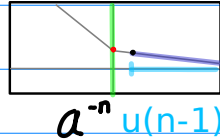

(7) 0110

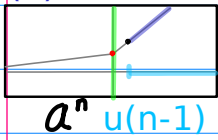

(6) 0101

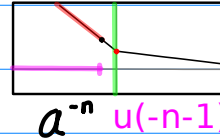

## D.II Flipping2 Base Inverting Shifted Range Flipping

(1') 1000

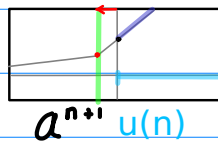

(4') 1011

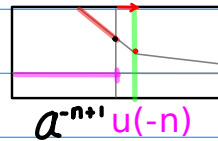

(3') 1010

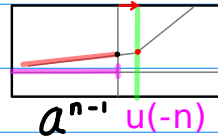

(2') 1001

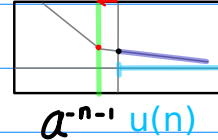

(5') 1100

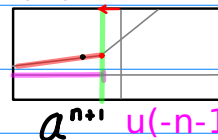

(8') 1111

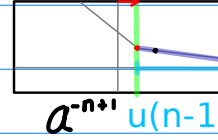

(7') 1110

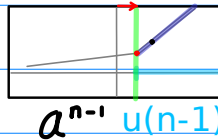

(6') 1101

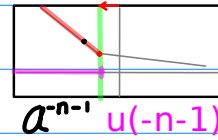

Shifted Range Flipping  
= Exponent Shifting2  
+ Range Flipping

$$a^n R(n) \longleftrightarrow a^{-n} R(-n)$$

$$a^n R(n) \longleftrightarrow a^{-sh2(n)} R(-n)$$

$$a^n \longleftrightarrow a^{-n}$$

$$a^n \longleftrightarrow a^{-n}$$

$$R(n) \longleftrightarrow R(-n)$$

$$a^n R(n) \longleftrightarrow a^{sh2(n)} R(-n)$$

## B.II Range Shifting Range Flipping Range Complementing

## E.II Shifting2 Shifted Range Flipping Range Complementing

(1) 0000

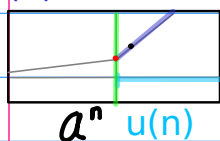

(7) 0110

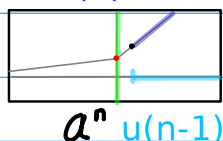

(1') 1000

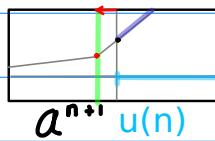

(7') 1110

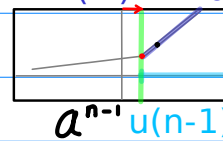

(5) 0100

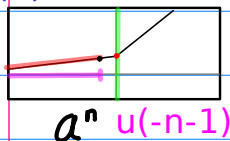

(3) 0010

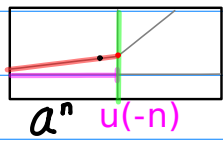

(5') 1100

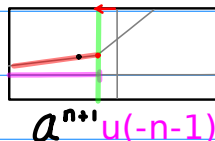

(3') 1010

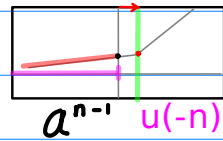

(2) 0001

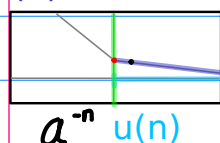

(8) 0111

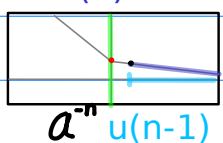

(2') 1001

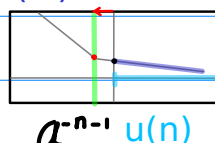

(8') 1111

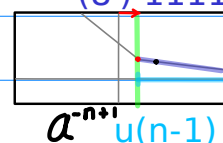

(6) 0101

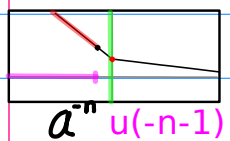

(4) 0011

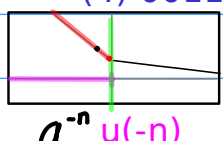

(6') 1101

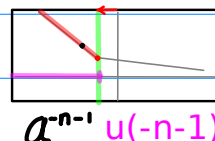

(4') 1011

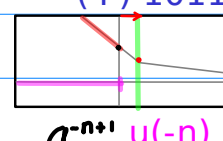

Range Shifting  
= Range Flipping  
+ Range Complementing

Shifted Range Flipping  
= Exponent Shifting2  
+ Range Flipping

$$R(n) \longleftrightarrow \overline{R(-n)}$$

$$a^n R(n) \longleftrightarrow \overline{a^{sh2(n)} R(-n)}$$

$$R(n) \longleftrightarrow \overline{R(-n)}$$

$$a^n R(n) \longleftrightarrow \overline{a^{sh2(n)} R(-n)}$$

$$R(n) \longleftrightarrow \overline{R(n)}$$

$$R(n) \longleftrightarrow \overline{R(n)}$$

## C.II Complementary Inverting Base Inverting Range Complementing

## F.II Complementary Inverting Base Inverting Range Complementing

(1) 0000

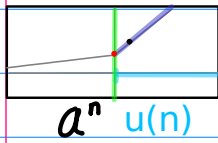

$a^{-n} u(-n-1)$

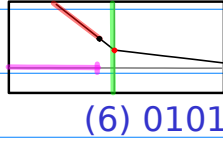

(6) 0101

(1') 1000

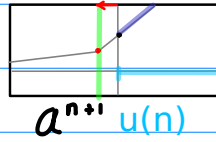

$a^{n+1} u(n)$

$a^{-n-1} u(-n-1)$

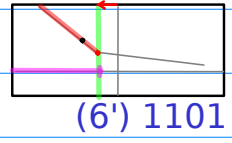

(6') 1101

(5) 0100

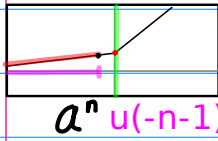

$a^n u(-n-1)$

(2) 0001

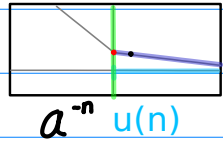

$a^{-n} u(n)$

(5') 1100

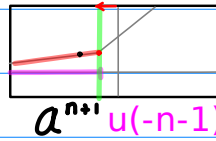

$a^{n+1} u(-n-1)$

(2') 1001

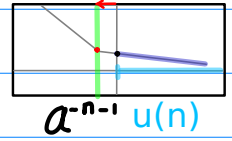

$a^{-n-1} u(n)$

(3) 0010

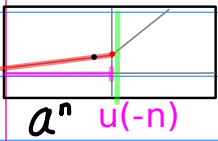

$a^n u(-n)$

(8) 0111

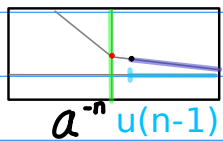

$a^{-n} u(n-1)$

(3') 1010

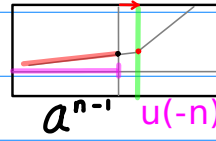

$a^{n-1} u(-n)$

(8') 1111

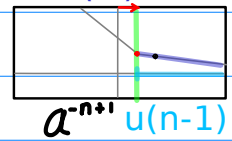

$a^{-n+1} u(n-1)$

(7) 0110

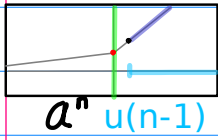

$a^n u(n-1)$

(4) 0011

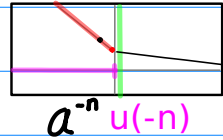

$a^{-n} u(-n)$

(7') 1110

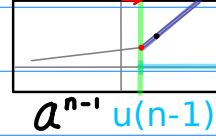

$a^{n-1} u(n-1)$

(4') 1011

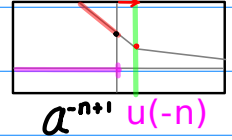

$a^{-n+1} u(-n)$

$$a^n R(n) \longleftrightarrow a^{-n} \overline{R(n)}$$

$$a^n R(n) \longleftrightarrow a^{-n} \overline{R(n)}$$

$$a^n \longleftrightarrow a^{-n}$$

$$R(n) \longleftrightarrow \overline{R(n)}$$

$$a^n \longleftrightarrow a^{-n}$$

$$R(n) \longleftrightarrow \overline{R(n)}$$





# Base Inverting

$$2^{n+1} \longleftrightarrow 2^{-(n+1)}$$

$$2^n \cdot 2^{+1} \longleftrightarrow 2^{-n} \cdot 2^{-1}$$

$$2^{n-1} \longleftrightarrow 2^{-(n-1)}$$

$$2^n \cdot 2^{-1} \longleftrightarrow 2^{-n} \cdot 2^{+1}$$

as a scaling

$2^{n+1}$

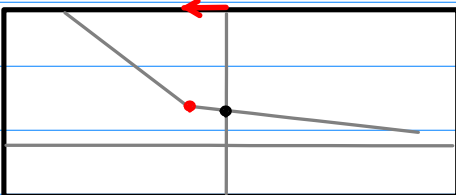
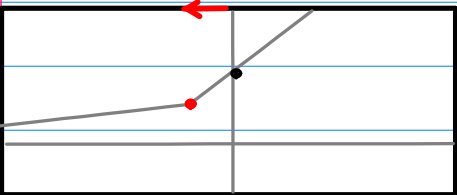

$2^{-(n+1)}$

$2^{n-1}$

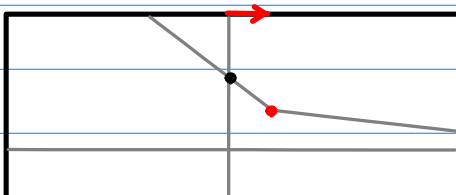
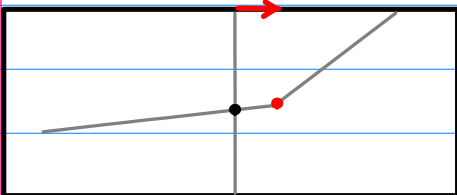

$2^{-(n-1)}$

# Exponent Shifting2

$$2^{n+1} \longleftrightarrow 2^{n-1}$$

$$2^{-(n+1)} \longleftrightarrow 2^{-(n-1)}$$

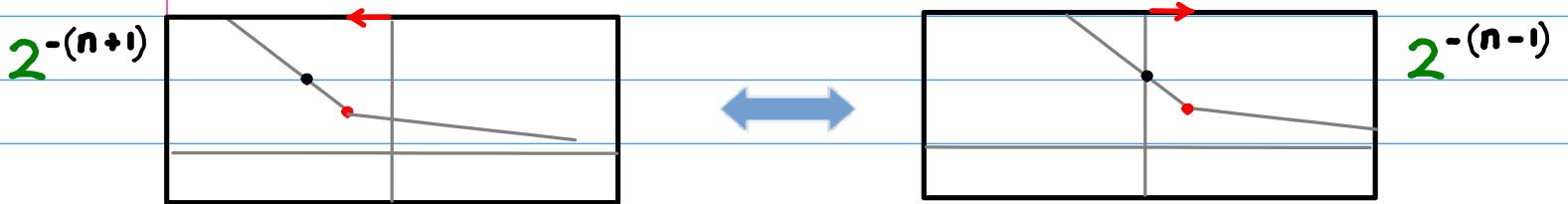
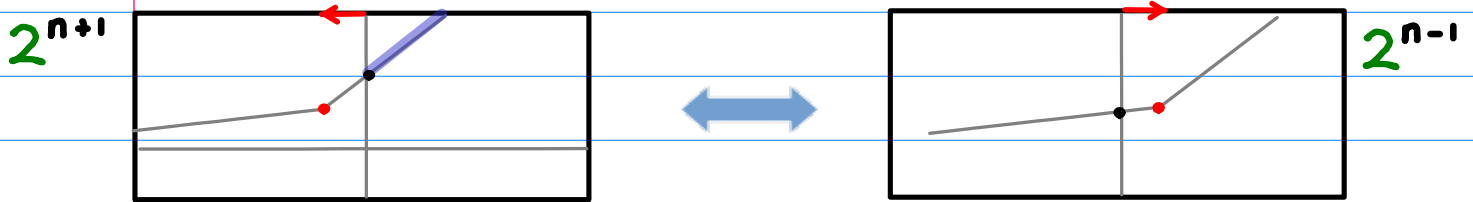

# Exponent Flipping2

$2^{n+1}$

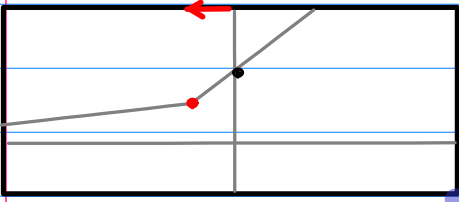

base  
inverting



$2^{-(n+1)}$

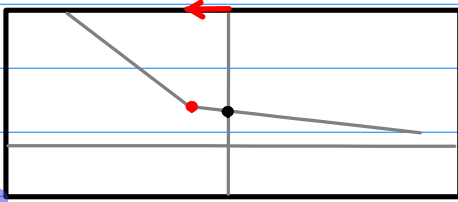

$n \leftarrow n + 2$   
exponent  
shifting2  
 $n \leftarrow n - 2$



exponent  
flipping

exponent  
flipping

$n \leftarrow n - 2$   
exponent  
shifting2  
 $n \leftarrow n + 2$



$2^{n-1}$

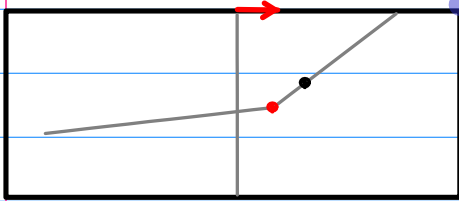

base  
inverting

$2^{-(n-1)}$

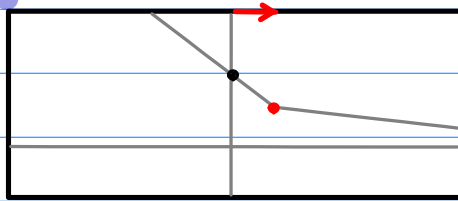



## A.2a Flipping

- Base Inverting
- Range Flipping

$$a^n R(n) \longleftrightarrow a^{-n} R(-n)$$

### 1) Base Inverting

$$a^n \longleftrightarrow a^{-n}$$

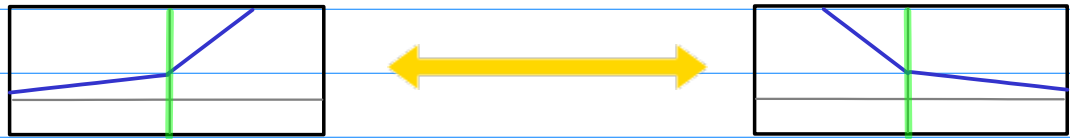

### 2) Range Flipping

$$R(n) \longleftrightarrow R(-n)$$

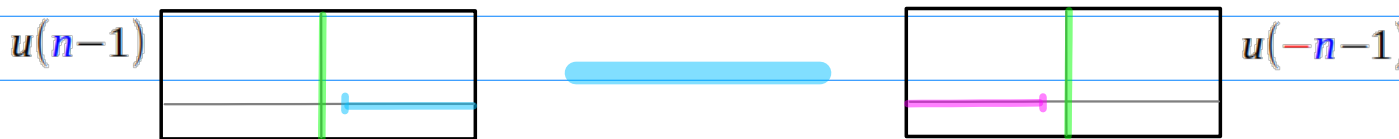
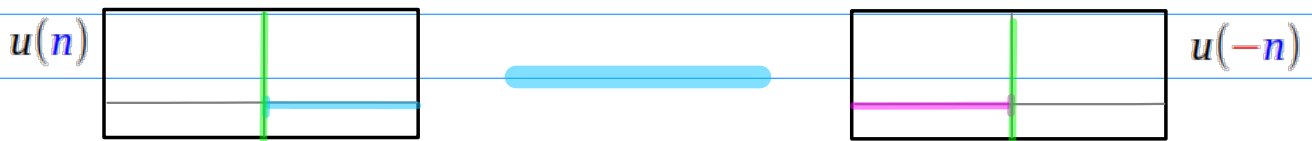

### 3) Flipping

$$a^n R(n) \longleftrightarrow a^{-n} R(-n)$$

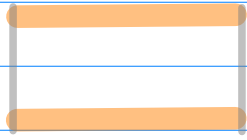

## 1) Base Inverting

 $a^n$  $a^{-n}$ 

$$\boxed{0} \boxed{b_2} \boxed{b_1} \boxed{b_0} \longrightarrow \boxed{0} \boxed{b_2} \boxed{b_1} \boxed{\bar{b}_0}$$

## 2) Range Flipping

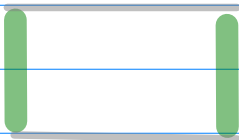

$$\boxed{0} \boxed{b_2} \boxed{b_1} \boxed{b_0} \longrightarrow \boxed{0} \boxed{b_2} \boxed{\bar{b}_1} \boxed{b_0}$$

## 3) Flipping

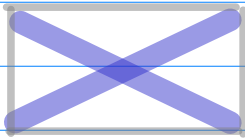

$$\boxed{0} \boxed{b_2} \boxed{b_1} \boxed{b_0} \longrightarrow \boxed{0} \boxed{b_2} \boxed{\bar{b}_1} \boxed{\bar{b}_0}$$

# Range Shifting over (1) ~ (8)

$$R(n) \longleftrightarrow \overline{R(-n)}$$

## (1) Range Flipping

$$R(n) \longleftrightarrow R(-n)$$

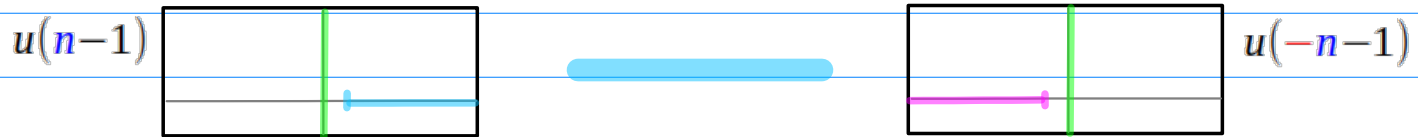
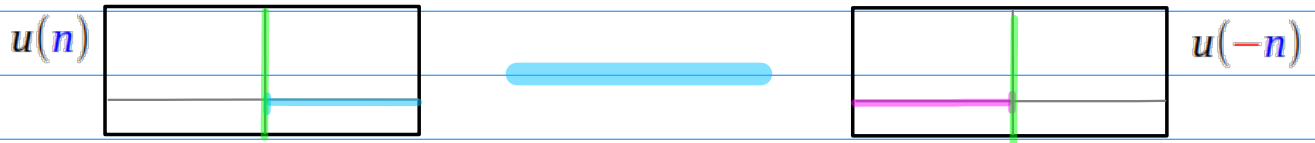

## (2) Range Complementing

$$R(n) \longleftrightarrow \overline{R(n)}$$



## (1+2) Range Shifting

$$R(n) \longleftrightarrow \overline{R(-n)}$$

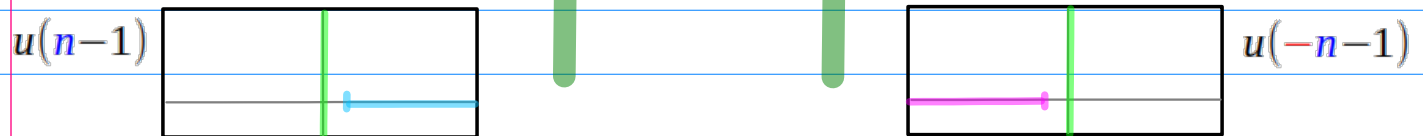
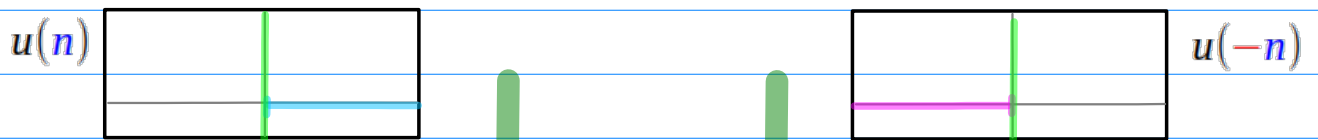

# Range Shifting = Range Flipping + Range Complementing

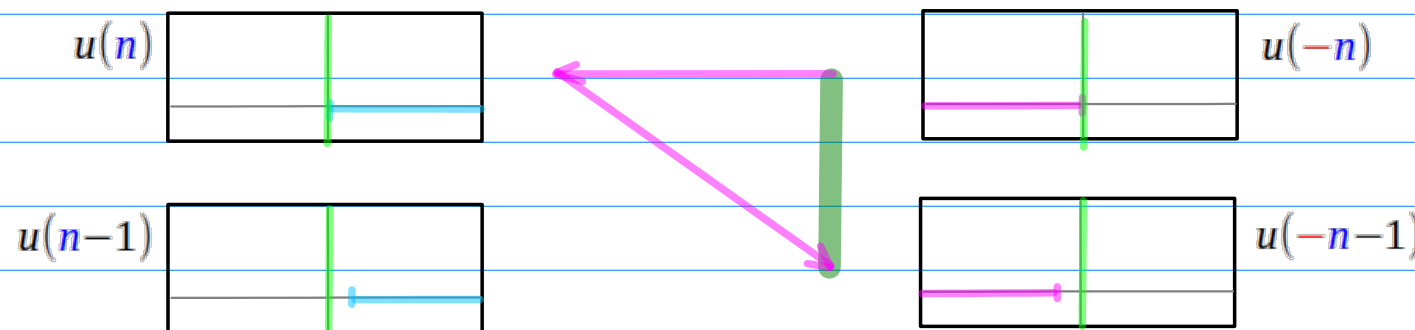
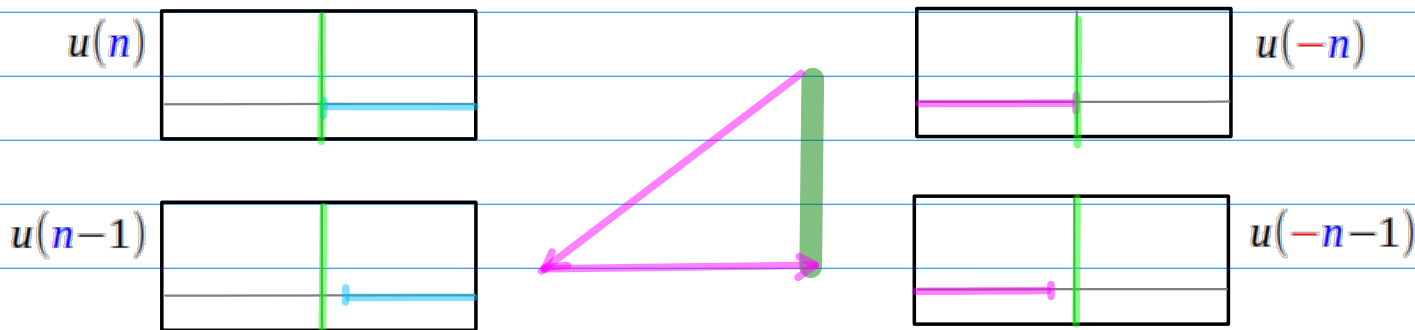
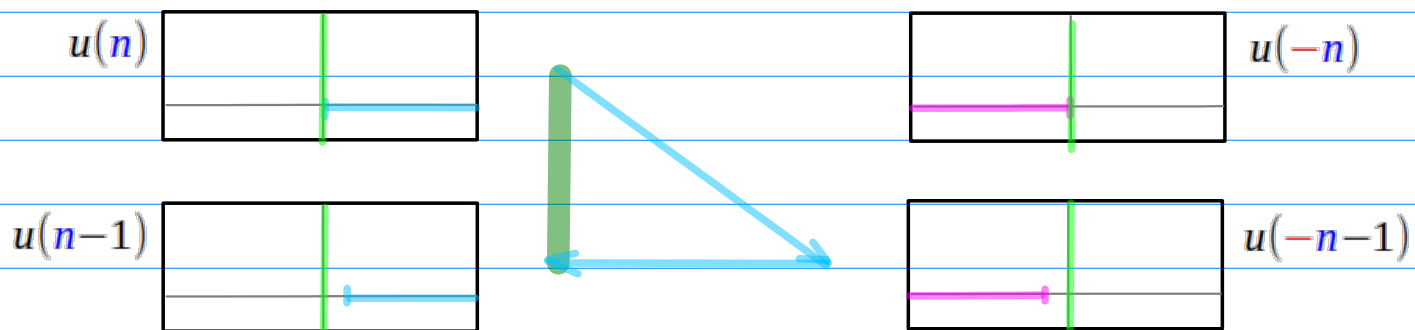
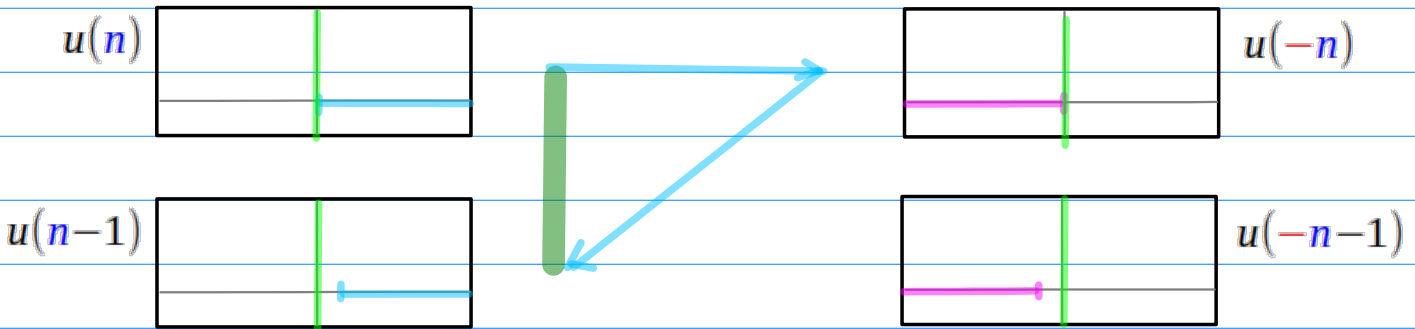

# Range Shifting, Range Flipping, Range Complementing

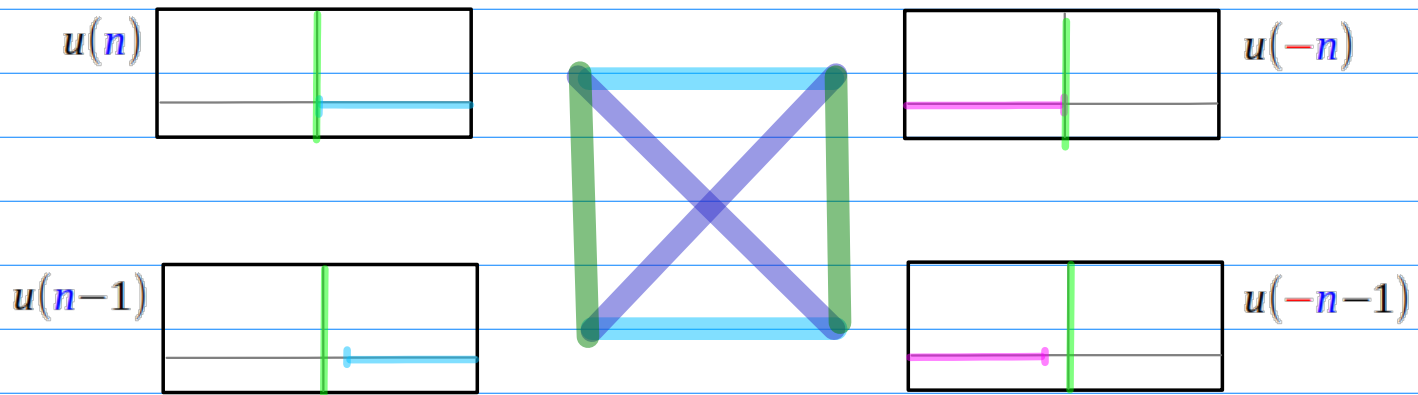

**1) Range Flipping**

$$R(n) \longleftrightarrow R(-n)$$

**2) Range Complementing**

$$R(n) \longleftrightarrow \overline{R(n)}$$

**3) Range Shifting**

$$R(n) \longleftrightarrow \overline{R(-n)}$$

**B.2b Range Shifting  
Range Flipping  
Range Complementing**

$$R(n) \longleftrightarrow \overline{R(-n)}$$

**1) Range Flipping**

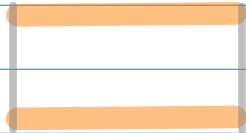

**2) Range Complementing**

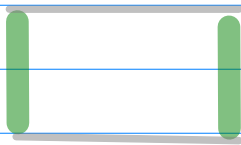

**3) Range Shifting**

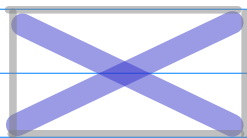

$R(n)$		$SHR(n)$
$u(n)$	$n \leftarrow n-1$ shr	$u(n-1)$
$u(n-1)$	$n \leftarrow n+1$ shl	$u(n)$
$u(-n)$	$n \leftarrow n+1$ shl	$u(-n-1)$
$u(-n-1)$	$n \leftarrow n-1$ shr	$u(-n)$

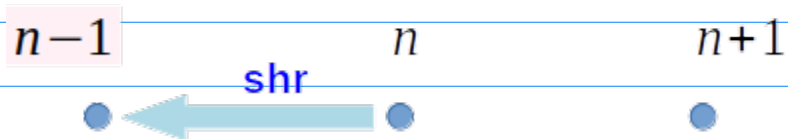
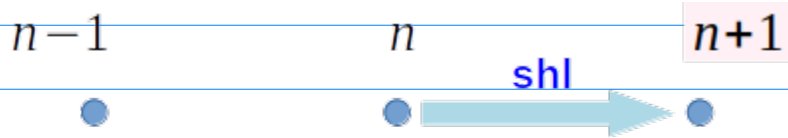

# Complementary Inverting over (1) ~ (8)

$$a^n R(n)$$



$$a^{-n} \overline{R(n)}$$

## (1) Base Inverting

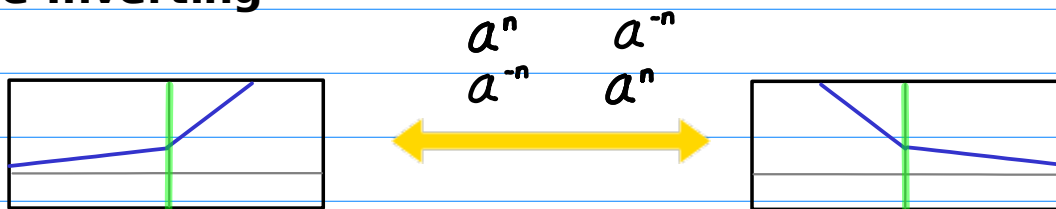

## (2) Range Complementing

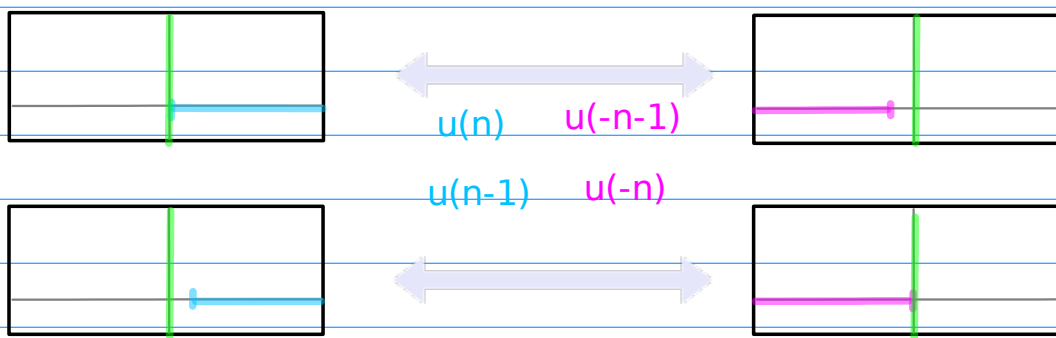

## (1+2) Complementary Inverting

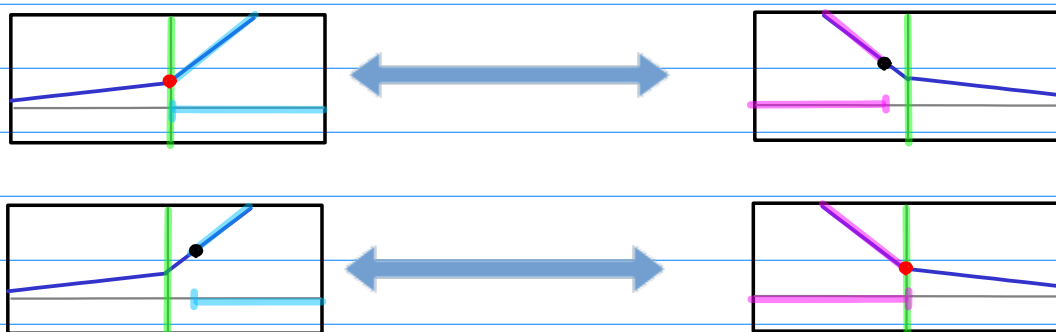



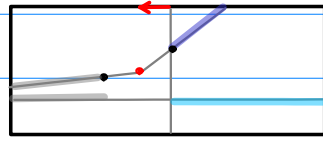

$$a^{n+1}$$

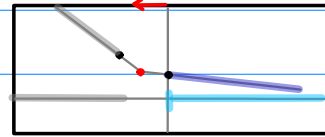

$$a^{-n-1}$$

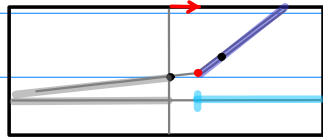

$$a^{n-1}$$

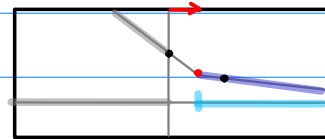

$$a^{-n+1}$$

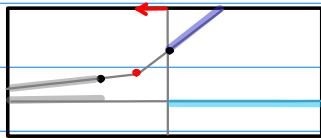

$$a^{n+1} u(n)$$

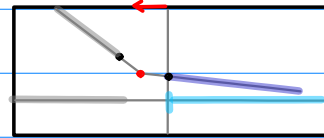

$$a^{-n-1} u(n)$$

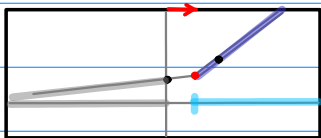

$$a^{n-1} u(n-1)$$

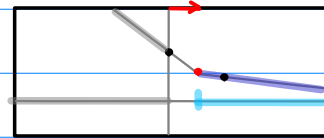

$$a^{-n+1} u(n-1)$$

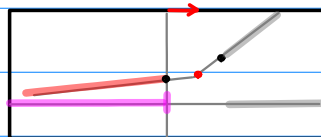

$$a^{n-1} u(-n)$$

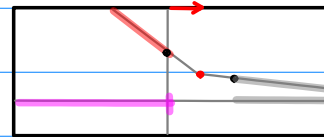

$$a^{-n+1} u(-n)$$

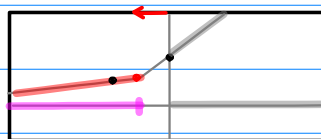

$$a^{n+1} u(-n-1)$$

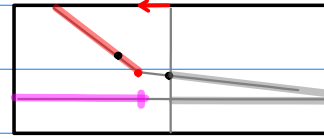

$$a^{-n-1} u(-n-1)$$

**C.2b Complementary Inverting  
Exponent Flipping  
Range Complementing**

$$a^n R(n) \quad \longleftrightarrow \quad a^{-n} \overline{R(n)}$$

**1) Base Inverting**

$$a^n$$

$$a^{-n}$$

**2) Range Complementing**

**3) Complementary Flipping**

# Shifted Range Flipping

$$a^n R(n) \longleftrightarrow a^{sh2(n)} R(-n)$$

## Exponent Shifting2

$$a^n \longleftrightarrow a^{sh2(n)}$$

## + Base Inverting

$$a^n \longleftrightarrow a^{-sh2(n)}$$

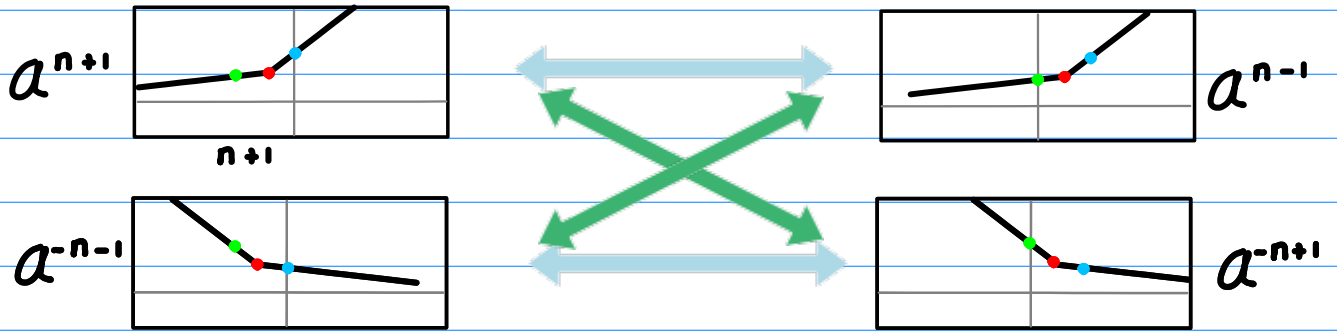

## Range Flipping

$$R(n) \longleftrightarrow R(-n)$$

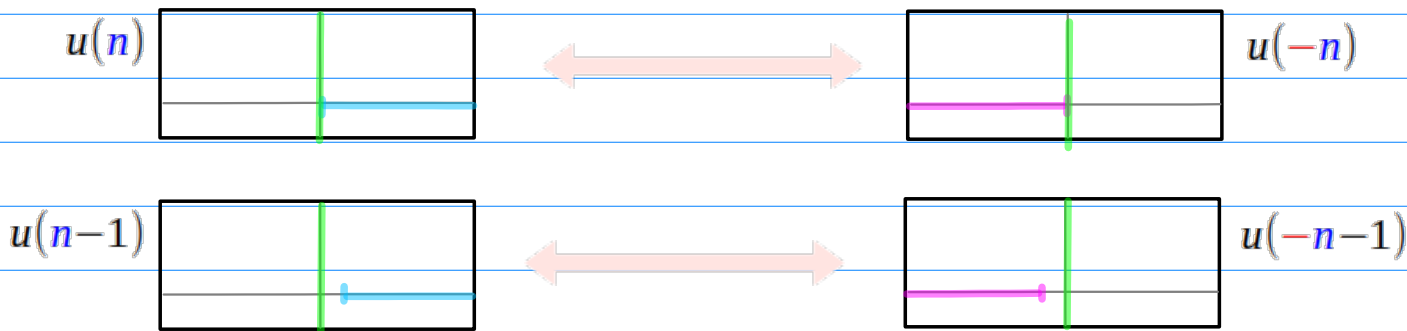



# Shifted Range Flipping

## Flipping2

$$a^n R(n) \longleftrightarrow a^{sh2(n)} R(-n)$$

$$a^n R(n) \longleftrightarrow a^{-sh2(n)} R(-n)$$

Flipping2 = Base Inverting + Shifted Range Flipping  
 = Base Inverting + Exponent Shifting2 + Range Flipping

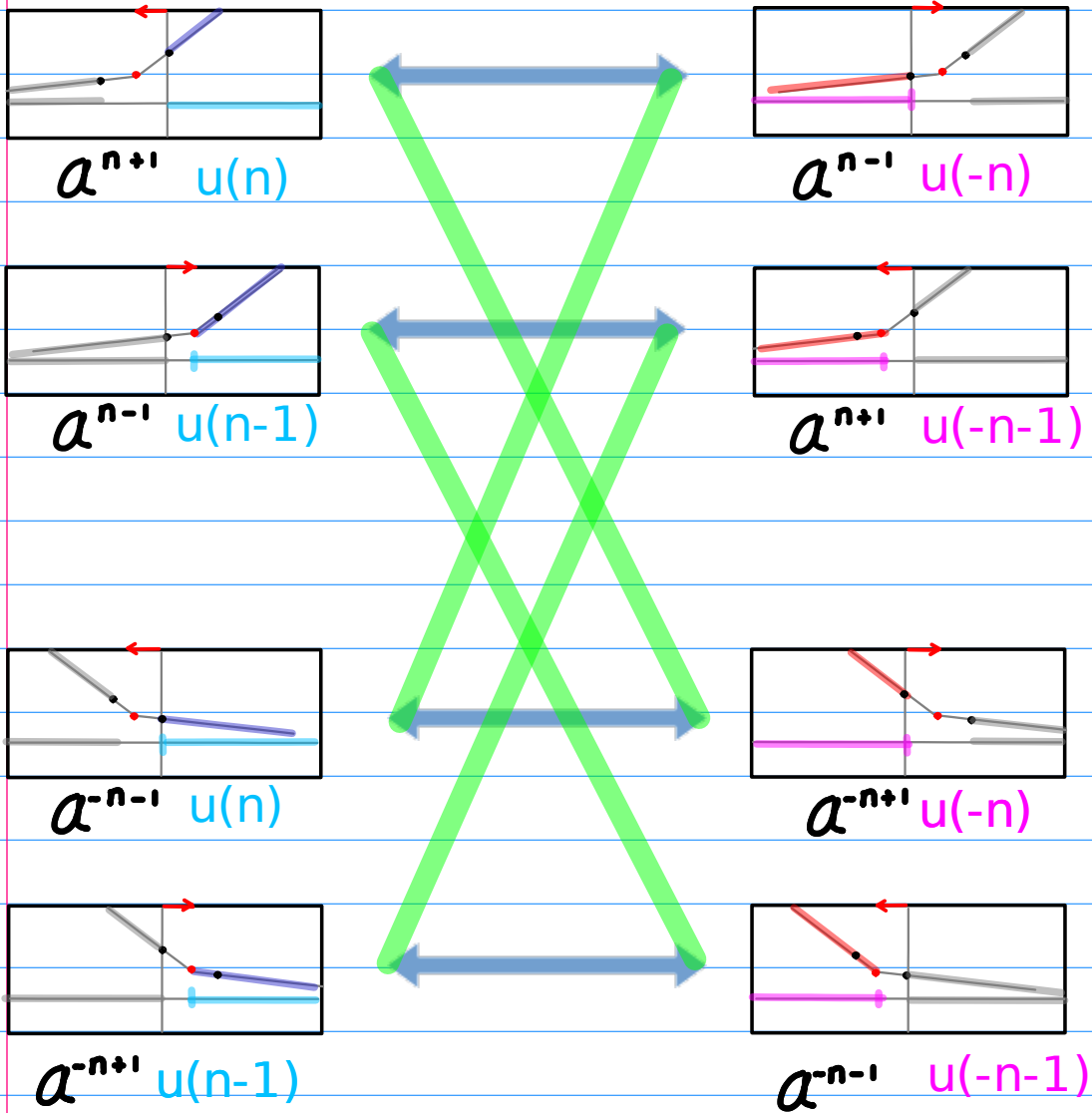

# Shifted Range Flipping

$$a^n R(n) \longleftrightarrow a^{sh2(n)} R(-n)$$

## Shifting2

$$a^n R(n) \longleftrightarrow a^{sh2(n)} \overline{R(-n)}$$

**shifting2 = Shifted Range Flipping + Range Complementing**  
 = Exponent Shifting2 + Range (Flipping + Complementing)  
 = Exponent Shifting2 + Range Shifting

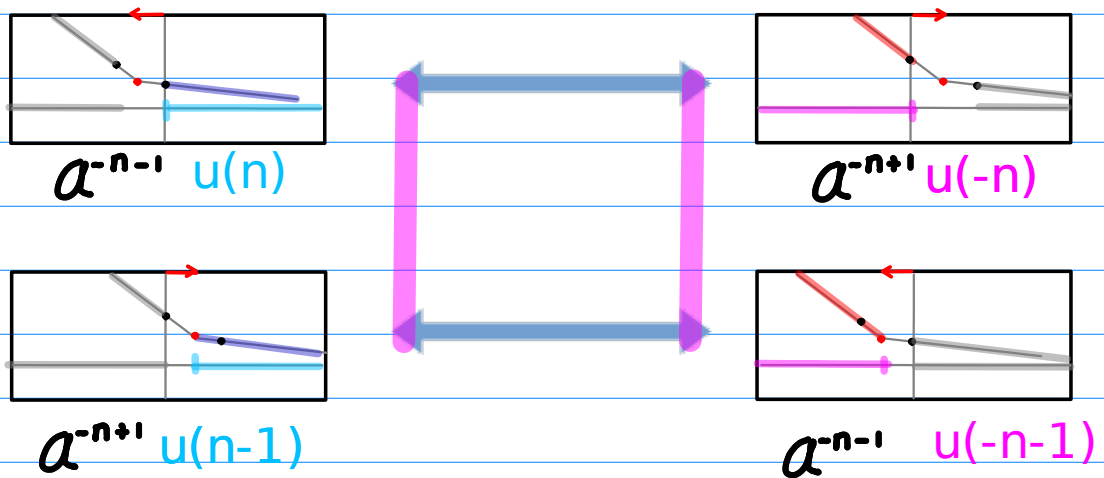
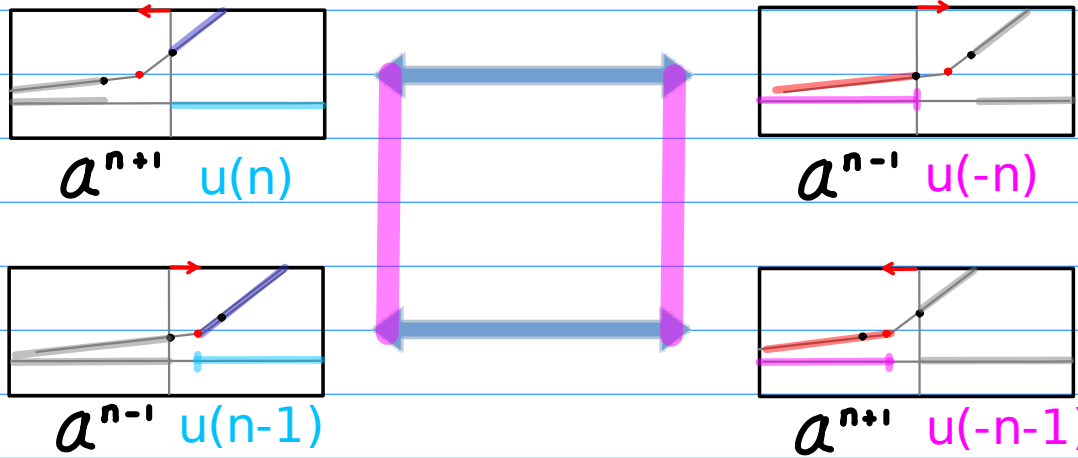

# Shifted Range Flipping

## Complementary Inverting

$$a^n R(n) \longleftrightarrow a^{sh2(n)} R(-n)$$

$$a^n R(n) \longleftrightarrow a^{-n} \overline{R(n)}$$

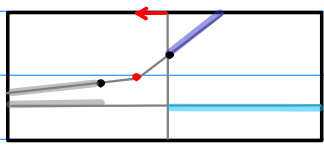

$$a^{n+1} u(n]$$

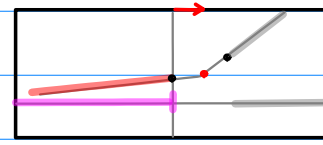

$$a^{n-1} u(-n]$$

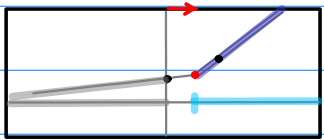

$$a^{n-1} u(n-1]$$

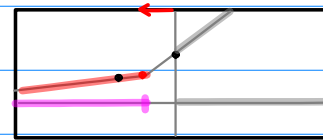

$$a^{n+1} u(-n-1]$$

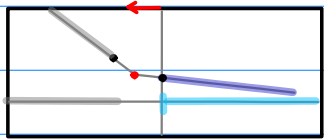

$$a^{-n-1} u(n]$$

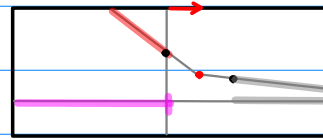

$$a^{-n+1} u(-n]$$

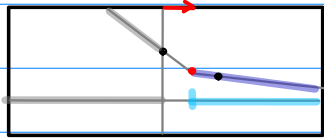

$$a^{-n+1} u(n-1]$$

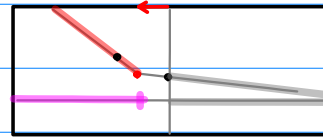

$$a^{-n-1} u(-n-1]$$

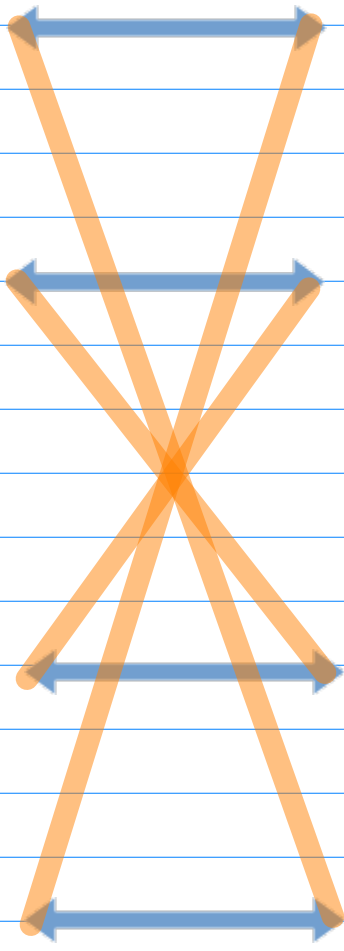

## D. Flipping2

$$a^n R(n) \longleftrightarrow a^{-sh2(n)} R(-n)$$

$$a^n \longleftrightarrow a^{-n}$$

$$a^n R(n) \longleftrightarrow a^{sh2(n)} R(-n)$$

$n$		$sh2(n)$
$n+1$	$n \leftarrow n-2$	$n-1$
$n-1$	$n \leftarrow n+1$	$n+1$
$-(n+1)$	$n \leftarrow n+1$	$-(n-1)$
$-(n-1)$	$n \leftarrow n-1$	$-(n+1)$

$R(n)$	$R(-n)$
$u(n)$	$u(-n)$
$u(n-1)$	$u(-n-1)$
$u(-n)$	$u(n)$
$u(-n-1)$	$u(n-1)$



## E. Shifting2

$$a^n R(n) \longleftrightarrow a^{\text{sh}2(n)} \overline{R(-n)}$$

$$a^n R(n) \longleftrightarrow a^{\text{sh}2(n)} R(-n)$$

$$R(n) \longleftrightarrow R(n)$$

## F. Complementary Inverting

$$a^n R(n) \longleftrightarrow a^{-n} \overline{R(n)}$$

$$\begin{array}{ccc} a^n & \longleftrightarrow & a^{-n} \\ R(n) & \longleftrightarrow & \overline{R(n)} \end{array}$$

<u><math>R(n)</math></u>	<u><math>\overline{R(n)}</math></u>
<u><math>u(n)</math></u>	<u><math>u(-n-1)</math></u>
$u(n-1)$	$u(-n)$
$u(-n)$	$u(n)$
<u><math>u(-n-1)</math></u>	<u><math>u(n-1)</math></u>

# A.1 Flipping Base Inverting Range Flipping

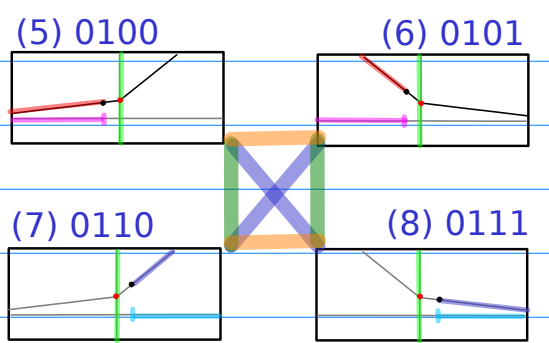
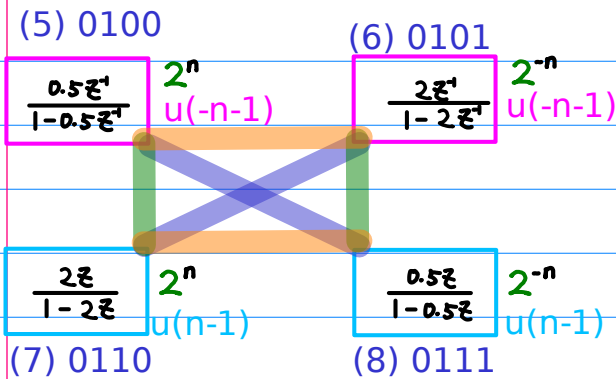
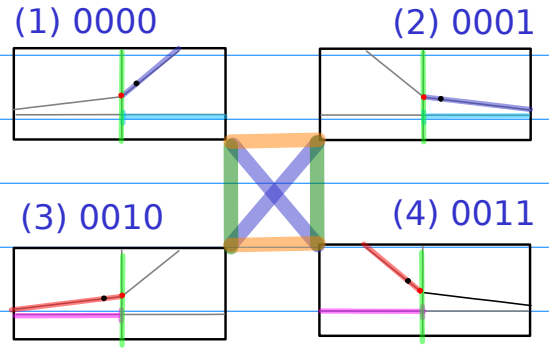
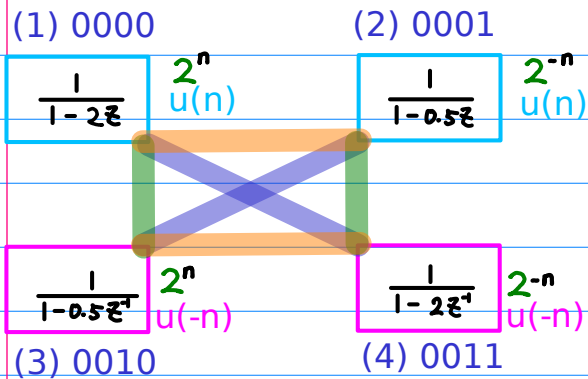

## Base Inverting

$$0 \ b_2 \ b_1 \ b_0 \longrightarrow 0 \ b_2 \ b_1 \ b_0$$

$$(1) \ 0 \ 0 \ 0 \ 0 \quad 0 \ 0 \ 0 \ 1 \quad (2)$$

## Range Flipping

$$0 \ b_2 \ b_1 \ b_0 \longrightarrow 0 \ b_2 \ \bar{b}_1 \ b_0$$

$$(3) \ 0 \ 0 \ 1 \ 0 \quad 0 \ 0 \ 1 \ 1 \quad (4)$$

## Flipping

$$0 \ b_2 \ b_1 \ b_0 \longrightarrow 0 \ b_2 \ \bar{b}_1 \ \bar{b}_0$$

$$(5) \ 0 \ 1 \ 0 \ 0 \quad 0 \ 1 \ 0 \ 1 \quad (6)$$

$$(7) \ 0 \ 1 \ 1 \ 0 \quad 0 \ 1 \ 1 \ 1 \quad (8)$$

$$a^n \longleftrightarrow a^{-n}$$

$$R(n) \longleftrightarrow R(-n)$$

$$a^n R(n) \longleftrightarrow a^{-n} R(-n)$$

# B.1 Range Shifting = Range Flipping + Range Complementing

## Range Flipping

## Range Complementing

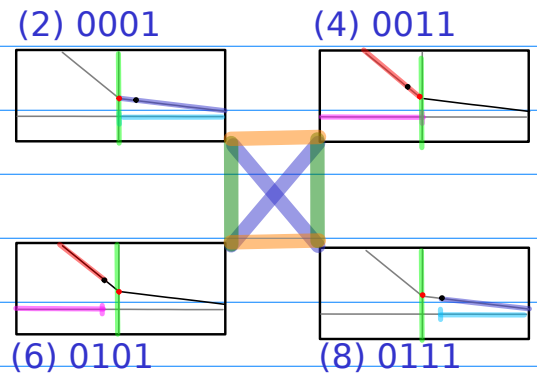
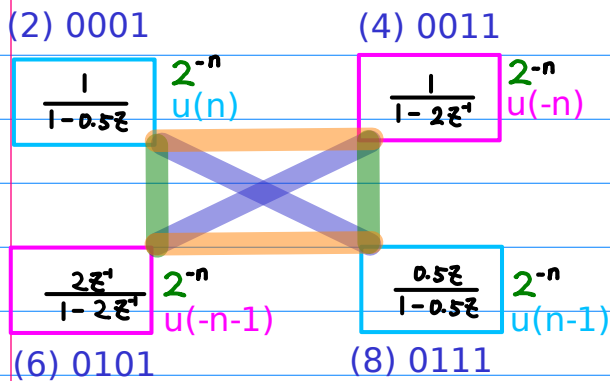
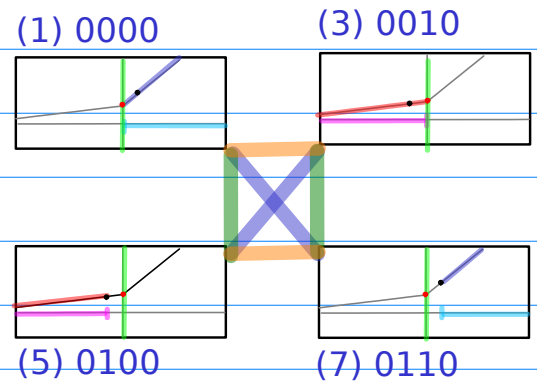
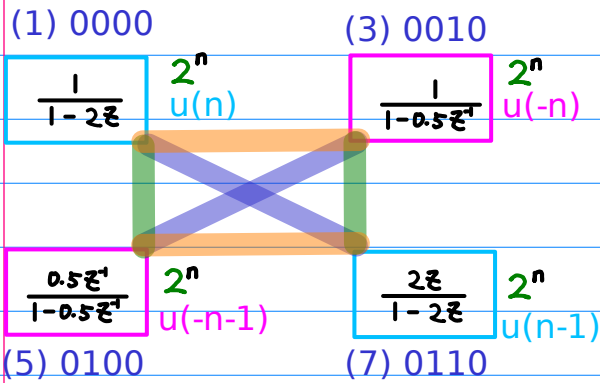

## Range Flipping

$$0 \ b_2 \ b_1 \ b_0 \longrightarrow 0 \ b_2 \ \bar{b}_1 \ b_0$$

## Range Complementing

$$0 \ b_2 \ b_1 \ b_0 \longrightarrow 0 \ \bar{b}_2 \ b_1 \ b_0$$

## Range Shifting

$$0 \ b_2 \ b_1 \ b_0 \longrightarrow 0 \ \bar{b}_2 \ \bar{b}_1 \ b_0$$

$$R(n) \longleftrightarrow R(-n)$$

$$R(n) \longleftrightarrow \overline{R(n)}$$

$$R(n) \longleftrightarrow \overline{R(-n)}$$

$$(1) \ 0 \ 0 \ 0 \ 0 \quad 0 \ 0 \ 1 \ 0 \ (3)$$

$$(5) \ 0 \ 1 \ 0 \ 0 \quad 0 \ 1 \ 1 \ 0 \ (7)$$

$$(2) \ 0 \ 0 \ 0 \ 1 \quad 0 \ 0 \ 1 \ 1 \ (4)$$

$$(6) \ 0 \ 1 \ 0 \ 1 \quad 0 \ 1 \ 1 \ 1 \ (8)$$

# C.1 Complementary Inverting Base Inverting Range Complementing

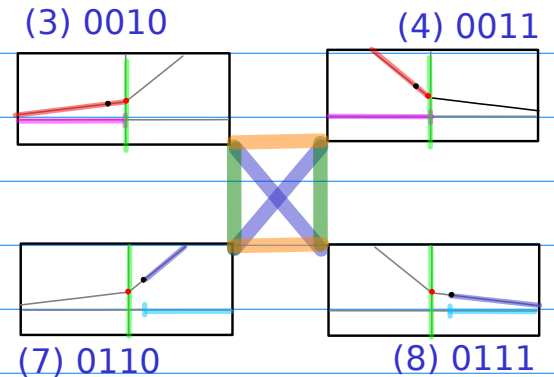
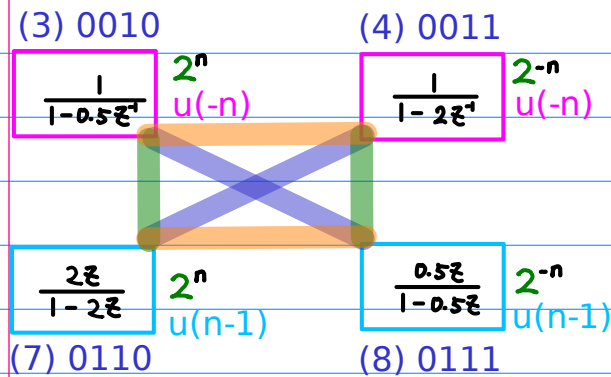
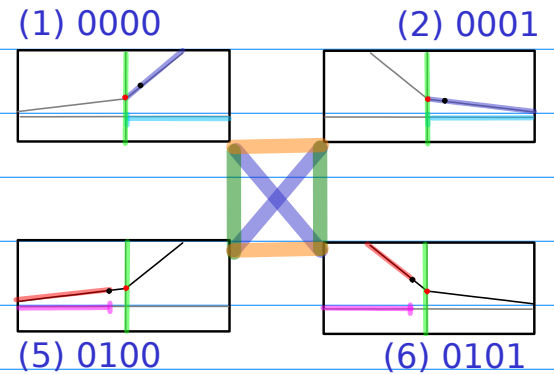
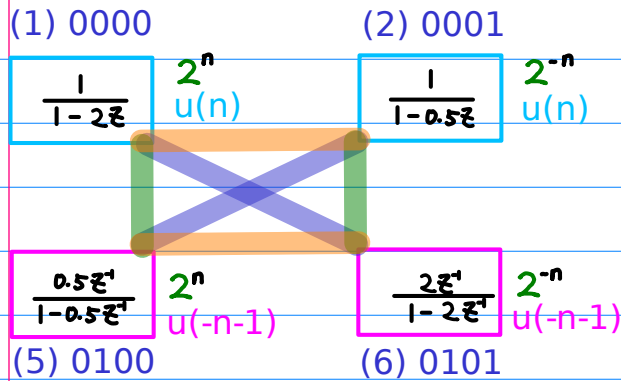

## Base Inverting

$$0 \ b_2 \ b_1 \ b_0 \longrightarrow 0 \ b_2 \ b_1 \ \bar{b}_0$$

$$(1) 0 \ 0 \ 0 \ 0 \qquad 0 \ 0 \ 0 \ 1 \ (2)$$

## Range Complementing

$$0 \ b_2 \ b_1 \ b_0 \longrightarrow 0 \ \bar{b}_2 \ b_1 \ b_0$$

$$(5) 0 \ 1 \ 0 \ 0 \qquad 0 \ 1 \ 0 \ 1 \ (6)$$

## Complementary Flipping

$$0 \ b_2 \ b_1 \ b_0 \longrightarrow 0 \ \bar{b}_2 \ b_1 \ \bar{b}_0$$

$$(3) 0 \ 0 \ 1 \ 0 \qquad 0 \ 0 \ 1 \ 1 \ (4)$$

$$(7) 0 \ 1 \ 1 \ 0 \qquad 0 \ 1 \ 1 \ 1 \ (8)$$

$$a^n \longleftrightarrow a^{-n}$$

$$R(n) \longleftrightarrow \overline{R(n)}$$

$$a^n R(n) \longleftrightarrow a^{-n} \overline{R(n)}$$

## D.1 Flipping2

### Base Inverting

Shifted Range Flipping = Exponent Shifting2 + Range Flipping

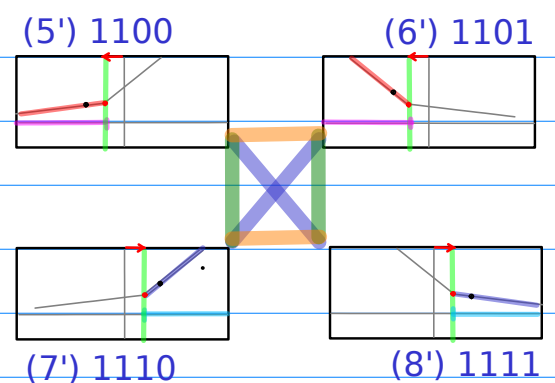
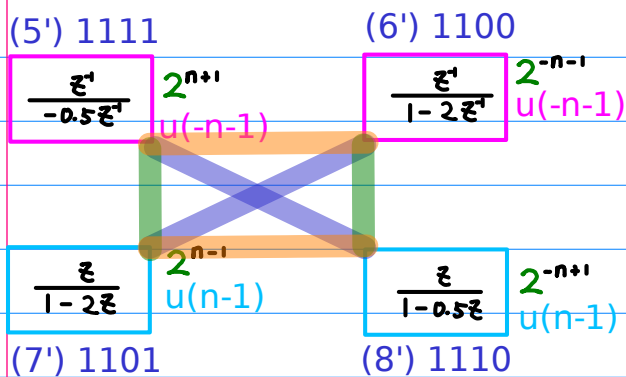
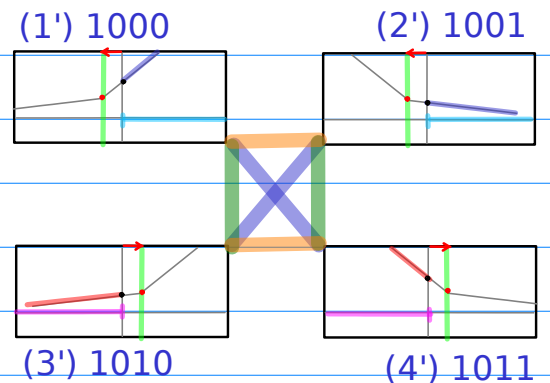
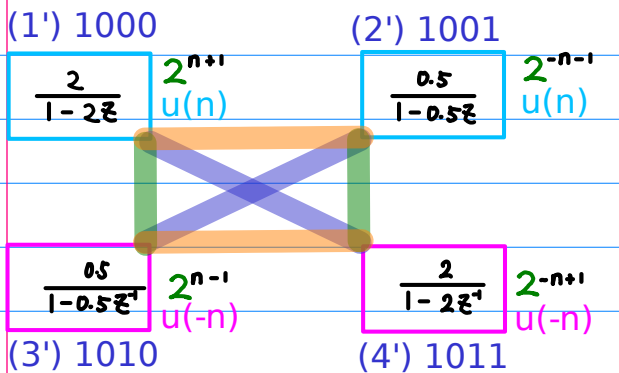

### Base Inverting



(1) 1 0 0 0  $\quad$  1 0 0 1 (2)

### Shifted Range Flipping



(3) 1 0 1 0  $\quad$  1 0 1 1 (4)

### Flipping2



(5) 1 1 0 0  $\quad$  1 1 0 1 (6)

(7) 1 1 1 0  $\quad$  1 1 1 1 (8)

$a^n \longleftrightarrow a^{-n}$

$a^n R(n) \longleftrightarrow a^{sh2(n)} R(-n)$

$a^n R(n) \longleftrightarrow a^{-sh2(n)} R(-n)$

# E.1 Shifting2 = Exponent Shifting2 + Range Complementing

## Shifted Range Flipping = Exponent Shifting2 + Range Flipping

### Range Complementing

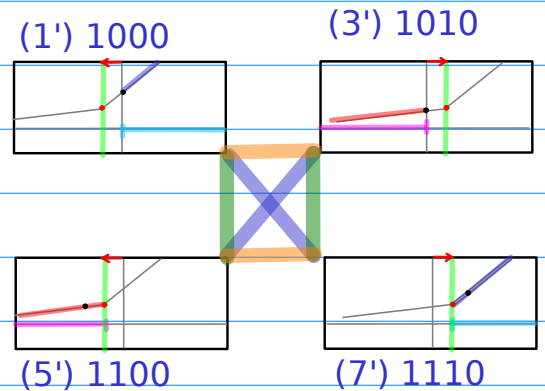
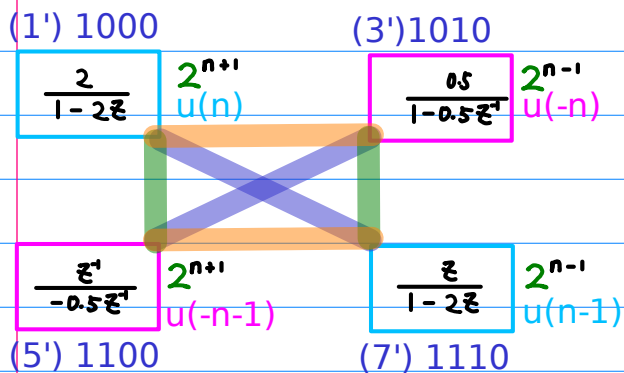

### Shifted Range Flipping



### Range Complementing



### Shifting2



$$a^n R(n) \longleftrightarrow a^{sh2(n)} R(-n)$$

$$R(n) \longleftrightarrow R(n)$$

$$a^n R(n) \longleftrightarrow a^{sh2(n)} \overline{R(-n)}$$

(1) 1 0 0 0      1 0 1 0 (3)

(5) 1 1 0 0      1 1 1 0 (7)

(2) 1 0 0 1      1 0 1 1 (4)

(6) 1 1 0 1      1 1 1 1 (8)

# F.1 Complementary Inverting Base Inverting Range Complementing

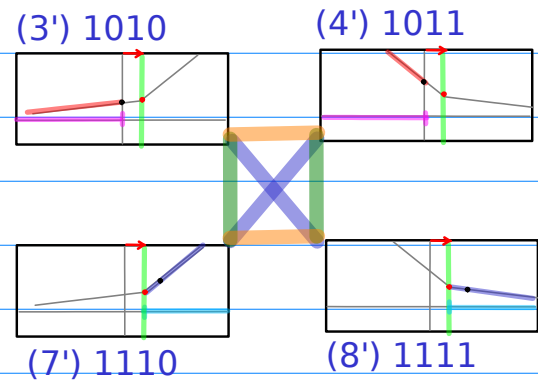
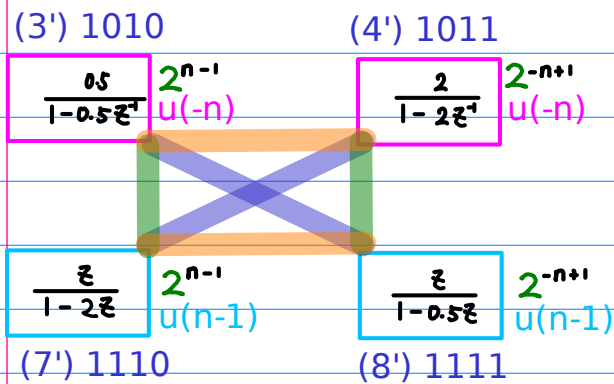
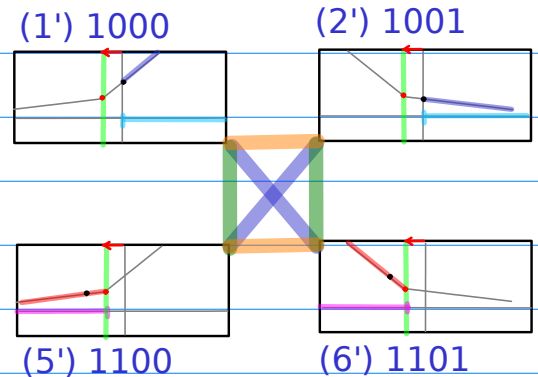
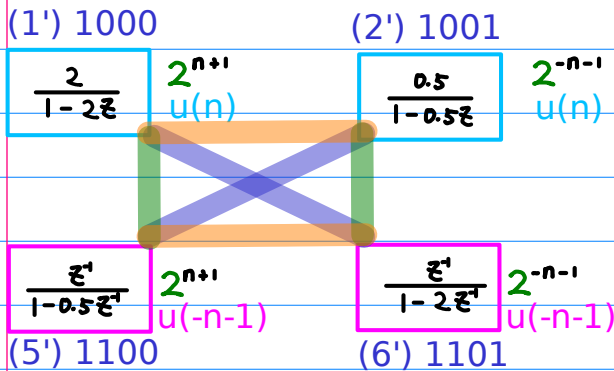

## Base Inverting

$$1 \ b_2 \ b_1 \ b_0 \longrightarrow 1 \ b_2 \ b_1 \ \overline{b_0}$$

$$(1) \ 1 \ 0 \ 0 \ 0 \qquad 1 \ 0 \ 0 \ 1 \ (2)$$

## Range Complementing

$$1 \ b_2 \ b_1 \ b_0 \longrightarrow 1 \ \overline{b_2} \ b_1 \ b_0$$

$$(5) \ 1 \ 1 \ 0 \ 0 \qquad 1 \ 1 \ 0 \ 1 \ (6)$$

## Complementary Inverting

$$1 \ b_2 \ b_1 \ b_0 \longrightarrow 1 \ \overline{b_2} \ b_1 \ \overline{b_0}$$

$$(3) \ 1 \ 0 \ 1 \ 0 \qquad 1 \ 0 \ 1 \ 1 \ (4)$$

$$(7) \ 1 \ 1 \ 1 \ 0 \qquad 1 \ 1 \ 1 \ 1 \ (8)$$

$$a^n \longleftrightarrow a^{-n}$$

$$R(n) \longleftrightarrow \overline{R(n)}$$

$$a^n R(n) \longleftrightarrow a^{-n} \overline{R(n)}$$





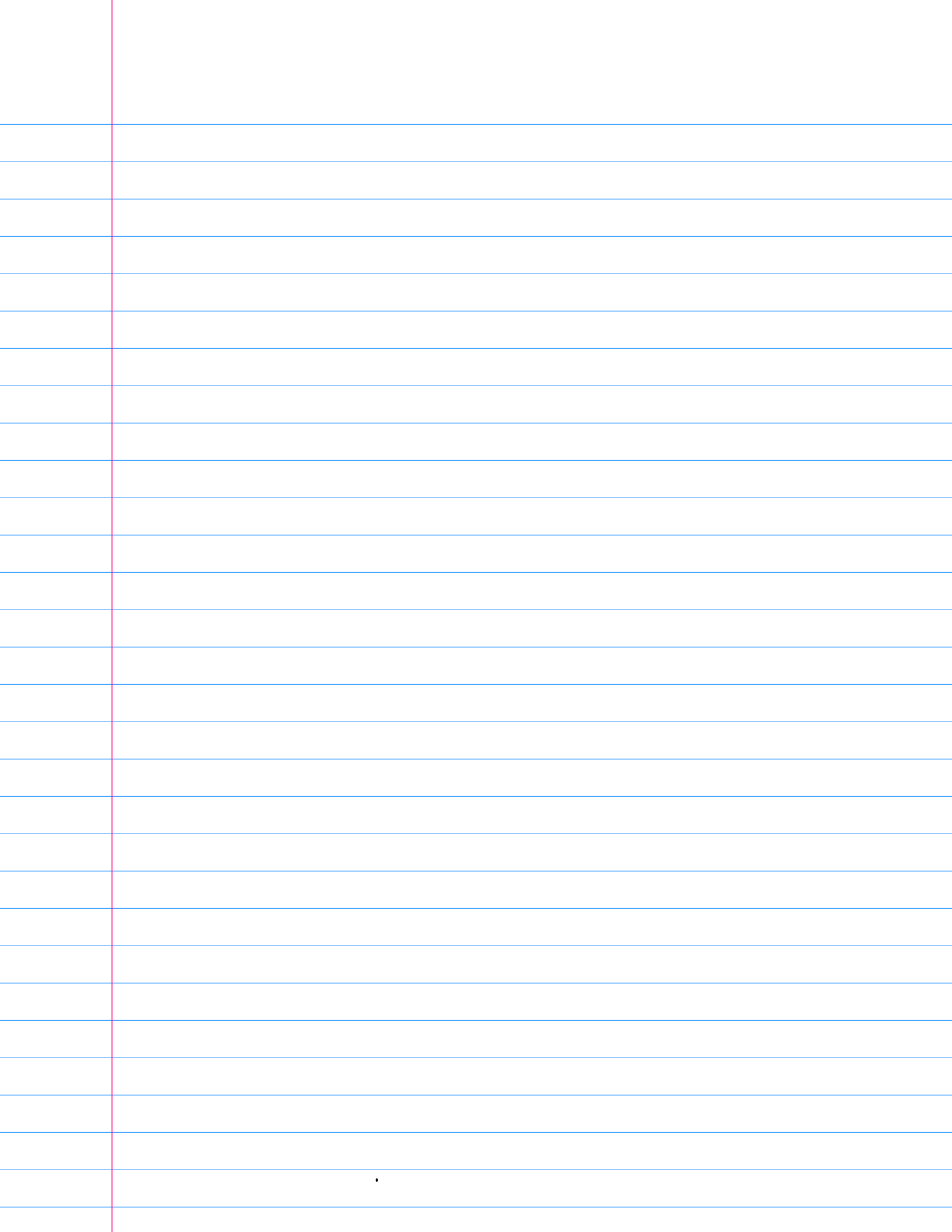

## A.2b Flipping Base Inverting Range Flipping

$$a^n R(n) \longleftrightarrow a^{-n} R(-n)$$

### 1) Base Inverting

$$\boxed{0} \boxed{b_2} \boxed{b_1} \boxed{b_0} \longrightarrow \boxed{0} \boxed{b_2} \boxed{b_1} \boxed{\bar{b}_0}$$

### 2) Range Flipping

$$\boxed{0} \boxed{b_2} \boxed{b_1} \boxed{b_0} \longrightarrow \boxed{0} \boxed{b_2} \boxed{\bar{b}_1} \boxed{b_0}$$

### 3) Flipping

$$\boxed{0} \boxed{b_2} \boxed{b_1} \boxed{b_0} \longrightarrow \boxed{0} \boxed{b_2} \boxed{\bar{b}_1} \boxed{\bar{b}_0}$$

**B.2a Range Shifting**  
**Range Flipping**  
**Range Complementing**

$$R(n) \longleftrightarrow \overline{R(-n)}$$

**1) Range Flipping**

$$R(n) \longleftrightarrow R(-n)$$

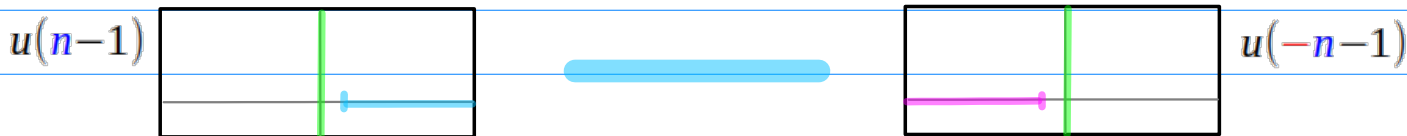
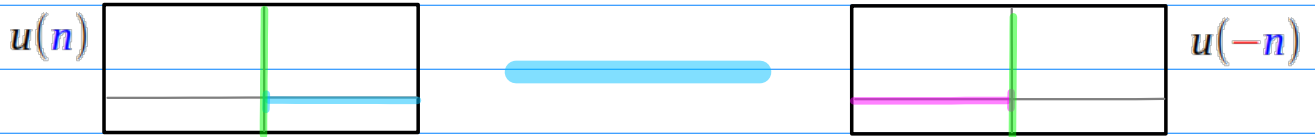

**2) Range Complementing**

$$R(n) \longleftrightarrow \overline{R(n)}$$



**3) Range Shifting**

$$R(n) \longleftrightarrow \overline{R(-n)}$$

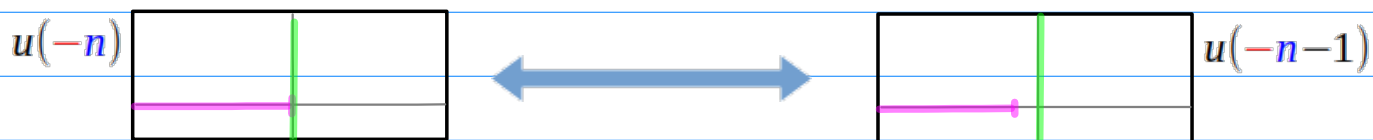
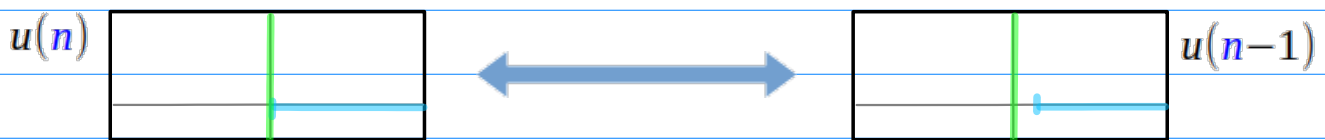

## B.2b Range Shifting Range Flipping Range Complementing

$$R(n) \longleftrightarrow \overline{R(-n)}$$

### 1) Range Flipping

$$\boxed{0} \boxed{b_2} \boxed{b_1} \boxed{b_0} \longrightarrow \boxed{0} \boxed{b_2} \boxed{\bar{b}_1} \boxed{b_0}$$

### 2) Range Complementing

$$\boxed{0} \boxed{b_2} \boxed{b_1} \boxed{b_0} \longrightarrow \boxed{0} \boxed{\bar{b}_2} \boxed{b_1} \boxed{b_0}$$

### 3) Range Shifting

$$\boxed{0} \boxed{b_2} \boxed{b_1} \boxed{b_0} \longrightarrow \boxed{0} \boxed{\bar{b}_2} \boxed{\bar{b}_1} \boxed{b_0}$$



## C.2a Complementary Inverting Base Inverting Range Complementing

$$a^n R(n) \longleftrightarrow a^{-n} \overline{R(n)}$$

### 1) Base Inverting

$$0 \ b_2 \ b_1 \ b_0 \longrightarrow 0 \ b_2 \ b_1 \ \overline{b_0}$$

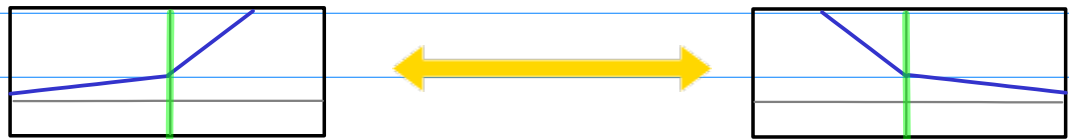

### 2) Range Complementing

$$0 \ b_2 \ b_1 \ b_0 \longrightarrow 0 \ \overline{b_2} \ b_1 \ b_0$$

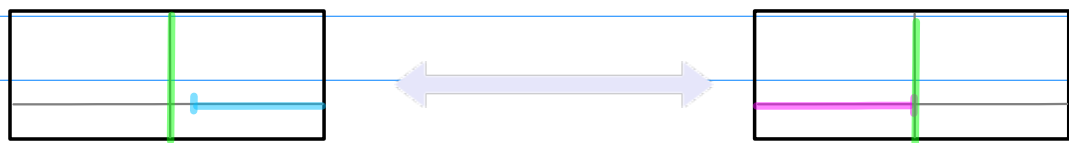
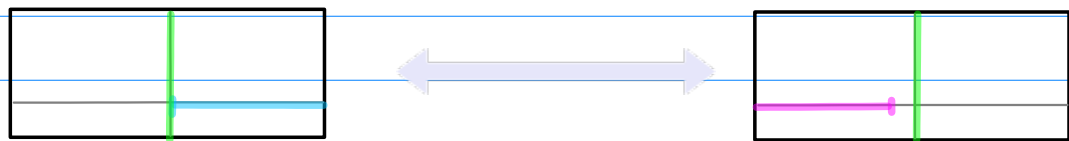

### 3) Complementary Flipping

$$0 \ b_2 \ b_1 \ b_0 \longrightarrow 0 \ \overline{b_2} \ b_1 \ \overline{b_0}$$

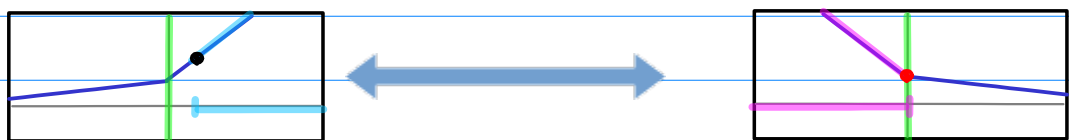
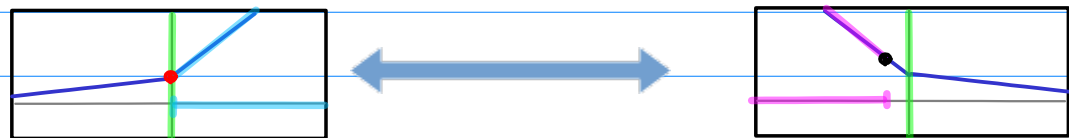

**D.2a Flipping2**  
**Base Inverting**  
**Shifted Range Flipping**

$$a^n \longleftrightarrow a^{-n}$$

$$a^n R(n) \longleftrightarrow a^{sh(n)} R(-n)$$

**1) Base Inverting**

$$a^n \longleftrightarrow a^{-n}$$

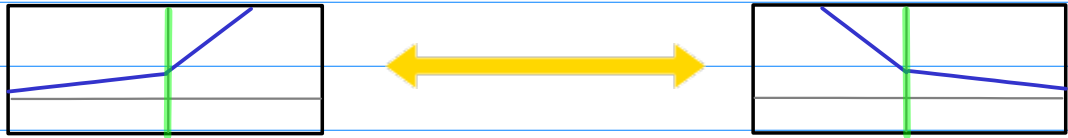

**2) Shifted Range Flipping**

$$a^n R(n) \longleftrightarrow a^{-sh2(n)} R(-n)$$

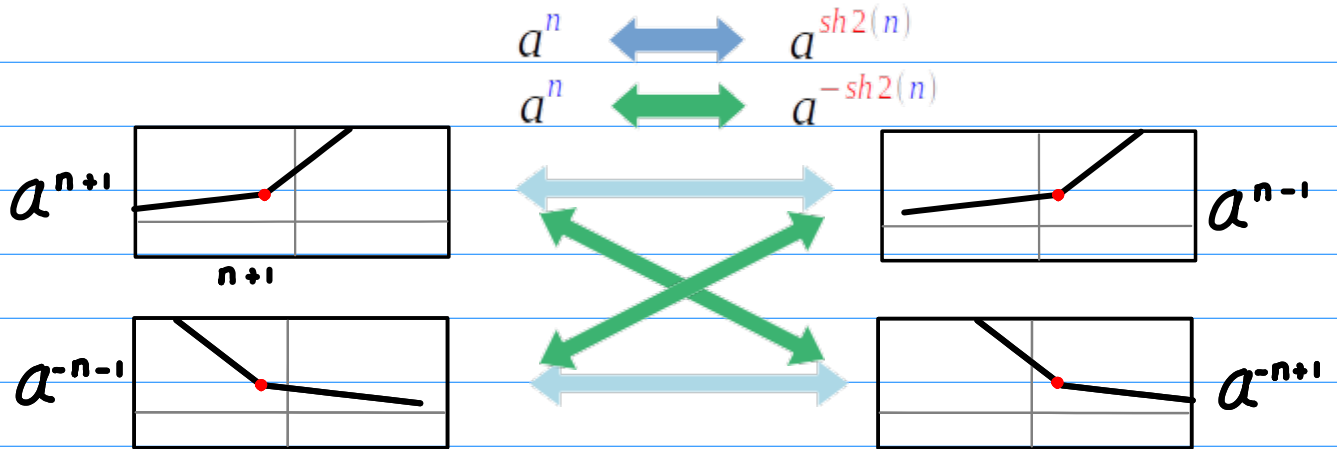

$$R(n) \longleftrightarrow R(-n)$$

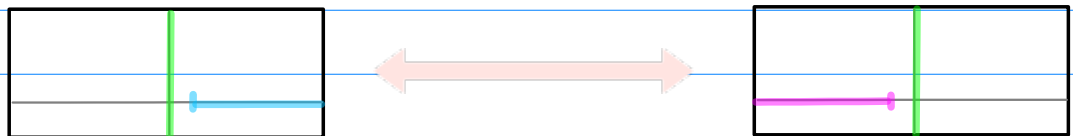
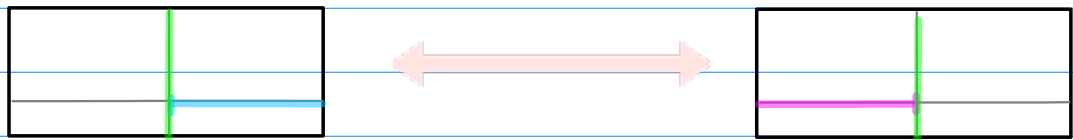



2) Shifted Range Flipping  $a^n R(n) \leftrightarrow a^{sh2(n)} R(-n)$

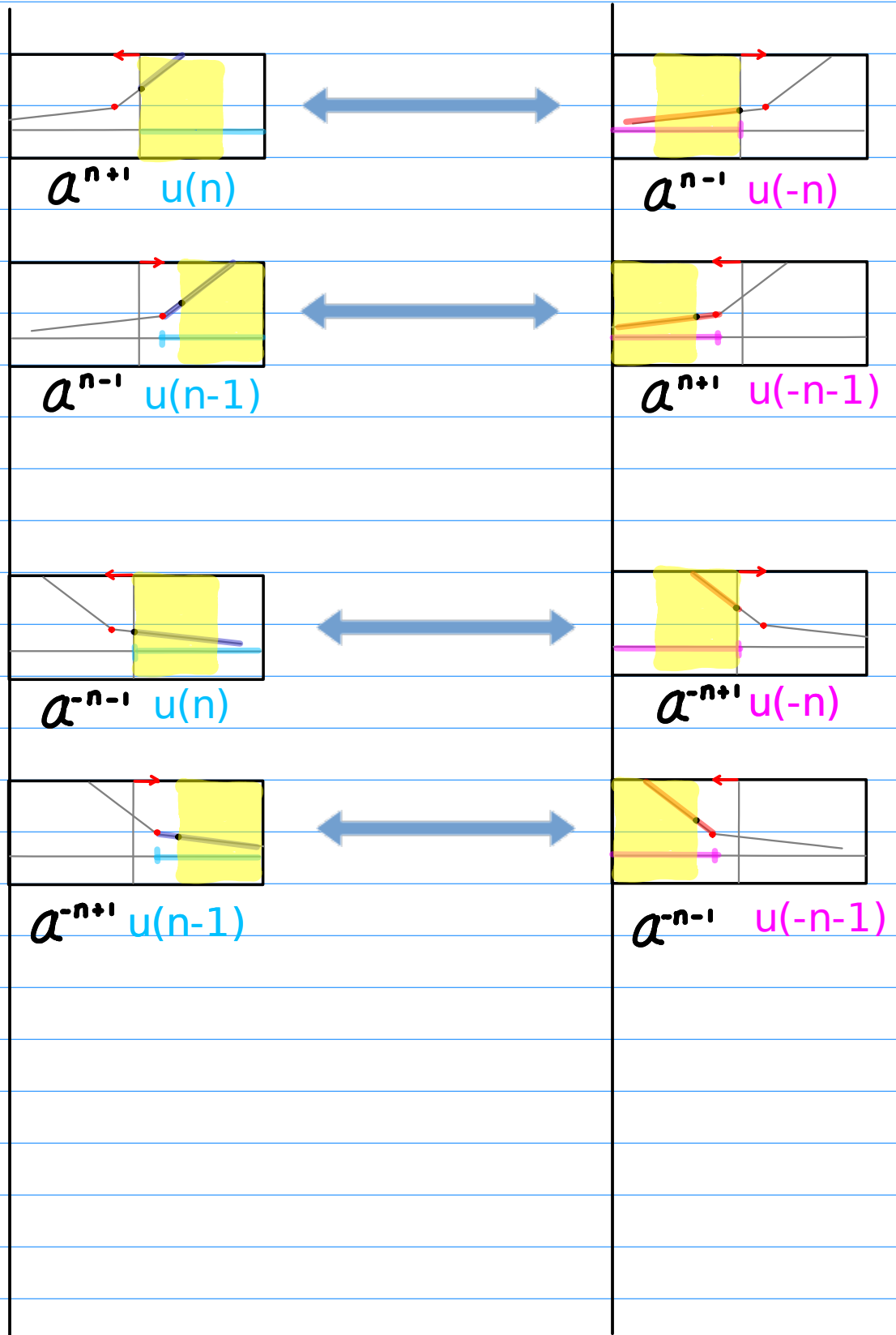

### 3) Flipping2

$$a^n R(n) \xleftrightarrow{a^{sh(n)}} a^{-sh2(n)} R(-n)$$

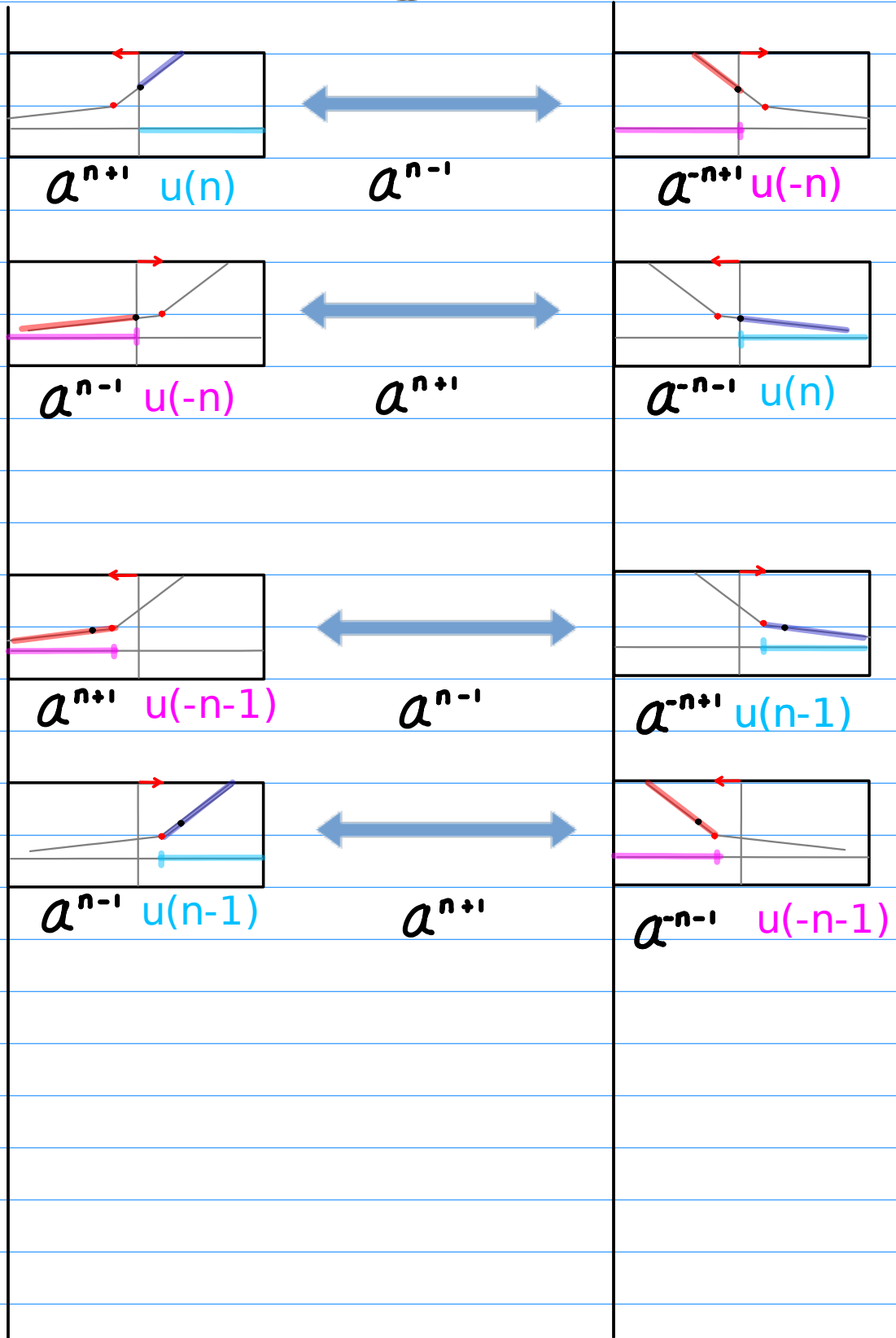



## D. Flipping2

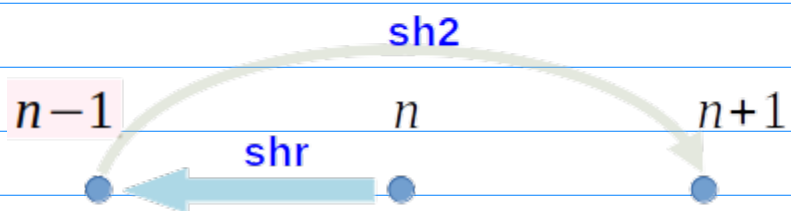
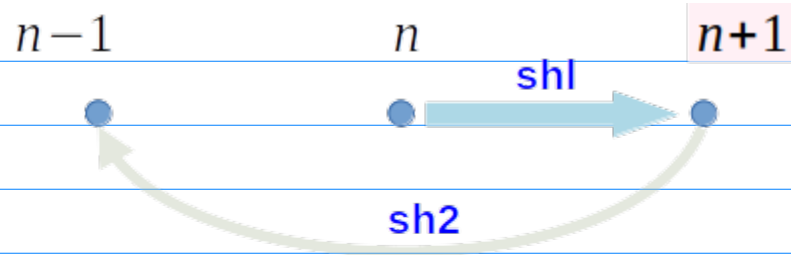

## D. Flipping2

Base Inverting

Shifted Range Flipping = Exponent Shifting2 + Range Flipping

(1') 1000

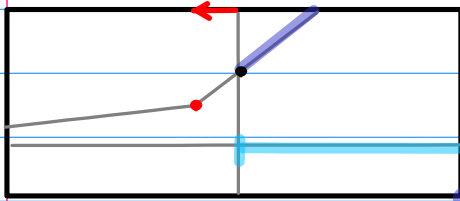

$2^{n+1}$   
 $u(n)$

(2') 1001

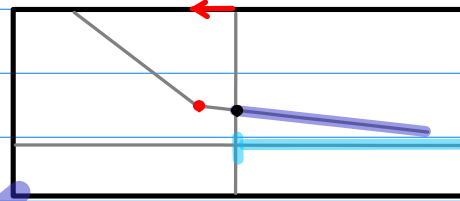

$2^{-n-1}$   
 $u(n)$

(3') 1010

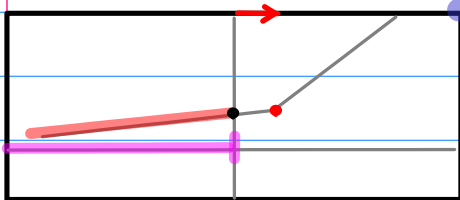

$2^{n-1}$   
 $u(-n)$

(4') 1011

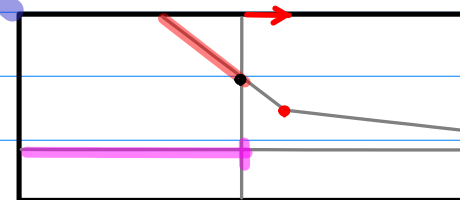

$2^{-n+1}$   
 $u(-n)$

(5') 1111

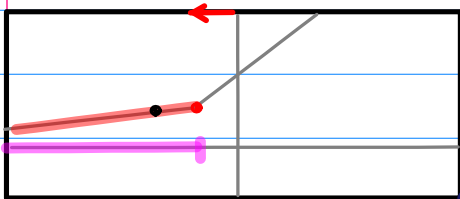

$2^{n+1}$   
 $u(-n-1)$

(6') 1100

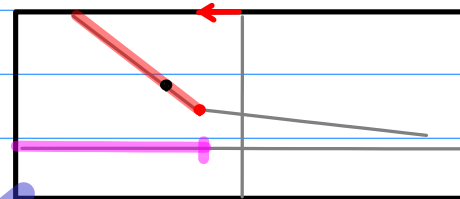

$2^{-n-1}$   
 $u(-n-1)$

(7') 1101

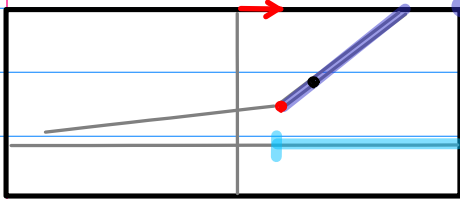

$2^{n-1}$   
 $u(n-1)$

(8') 1110

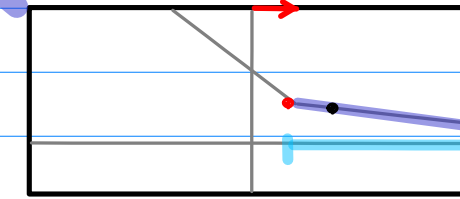

$2^{-n+1}$   
 $u(n-1)$

## D. Flipping2

Base Inverting

Shifted Range Flipping = Exponent Shifting2 + Range Flipping

### 1) Exponent Flipping = (Base Inverting, Exponent Shifting)

$$2^{n+1} \longleftrightarrow 2^{-(n-1)}$$

$$2^{n-1} \longleftrightarrow 2^{-(n+1)}$$

### 2) Range Flipping

$$u(n) \longleftrightarrow u(-n)$$

$$u(n-1) \longleftrightarrow u(-n-1)$$

### 3) Exponent Flipping + Range Flipping

$$\begin{array}{|c|} \hline 2^{n+1} \\ \hline u(n) \\ \hline \end{array} \longleftrightarrow \begin{array}{|c|} \hline 2^{-(n-1)} \\ \hline u(-n) \\ \hline \end{array} \quad \begin{array}{|c|} \hline 2^{n+1} \\ \hline u(-n-1) \\ \hline \end{array} \longleftrightarrow \begin{array}{|c|} \hline 2^{-(n-1)} \\ \hline u(n-1) \\ \hline \end{array}$$

$$\begin{array}{|c|} \hline 2^{n-1} \\ \hline u(-n) \\ \hline \end{array} \longleftrightarrow \begin{array}{|c|} \hline 2^{-(n+1)} \\ \hline u(n) \\ \hline \end{array} \quad \begin{array}{|c|} \hline 2^{n-1} \\ \hline u(n-1) \\ \hline \end{array} \longleftrightarrow \begin{array}{|c|} \hline 2^{-(n+1)} \\ \hline u(-n-1) \\ \hline \end{array}$$

**E. Shifting2 = Exponent Shifting2 + Range Shifting**  
**Shifted Range Flipping = Exponent Shifting2 + Range Flipping**  
**Range Complementing**

(1') 1000

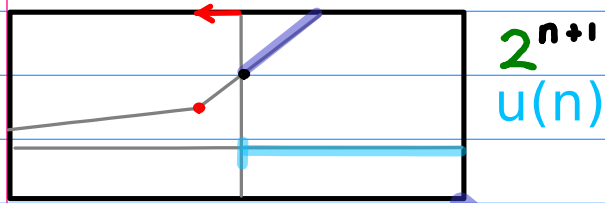

(3') 1010

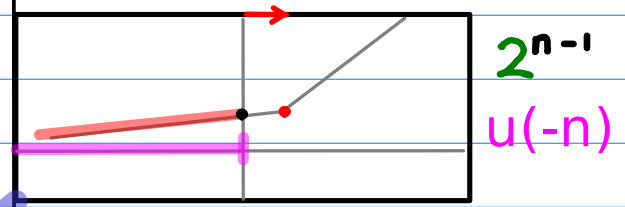

(5') 1111

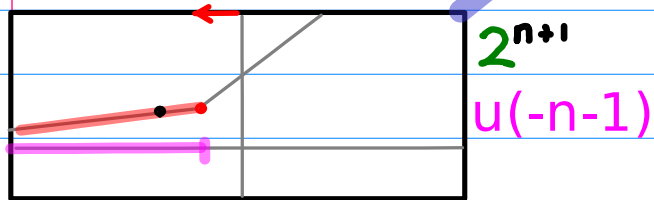

(7') 1101

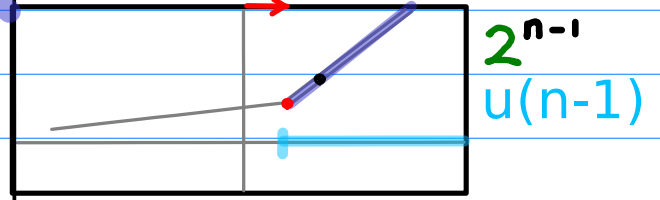

(2') 1001

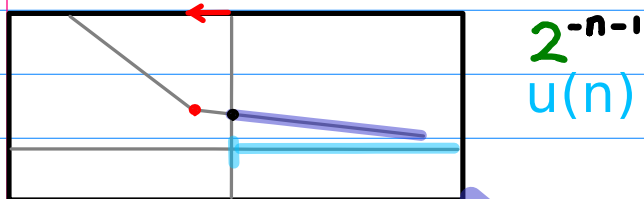

(4') 1011

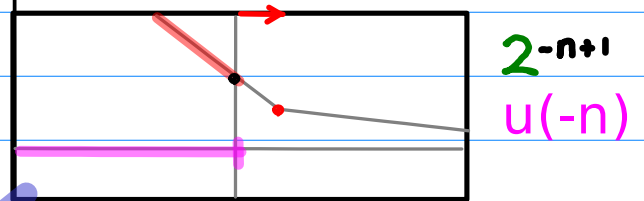

(6') 1100

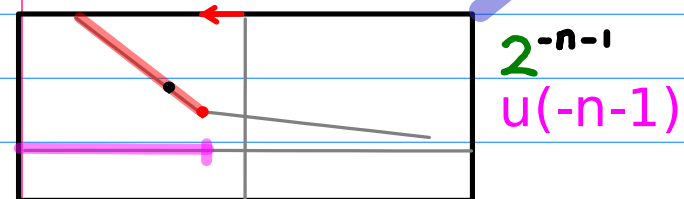

(8') 1110

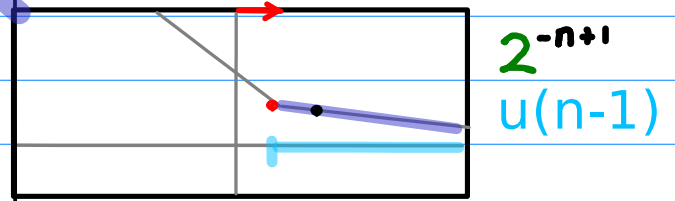

E. Shifting2 = Exponent Shifting2 + Range Shifting  
Shifted Range Flipping = Exponent Shifting2 + Range Flipping  
Range Complementing

### 1) Exponent Shifting = (Exponent Shifting, ID)

$$2^{n+1} \longleftrightarrow 2^{n-1}$$

$$2^{-(n+1)} \longleftrightarrow 2^{-(n-1)}$$

### 2) Range Shifting

$$u(n) \longleftrightarrow u(n-1)$$

$$u(-n-1) \longleftrightarrow u(-n)$$

### 3) Shifting

$$\begin{array}{c} 2^{n+1} \\ u(n) \end{array}$$



$$\begin{array}{c} 2^{n-1} \\ u(n-1) \end{array}$$

$$\begin{array}{c} 2^{-(n+1)} \\ u(n) \end{array}$$



$$\begin{array}{c} 2^{-(n-1)} \\ u(n-1) \end{array}$$

$$\begin{array}{c} 2^{n-1} \\ u(-n) \end{array}$$



$$\begin{array}{c} 2^{n+1} \\ u(-n-1) \end{array}$$

$$\begin{array}{c} 2^{-(n-1)} \\ u(-n) \end{array}$$



$$\begin{array}{c} 2^{-(n+1)} \\ u(-n-1) \end{array}$$



# F. Complementary Inverting Base Inverting Range Complementing

(1') 1000

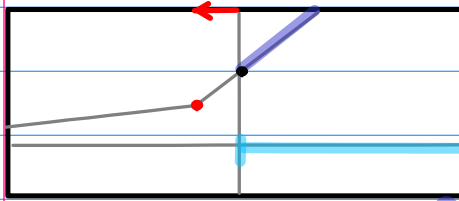

$$2^{n+1} u(n)$$

(2') 1001

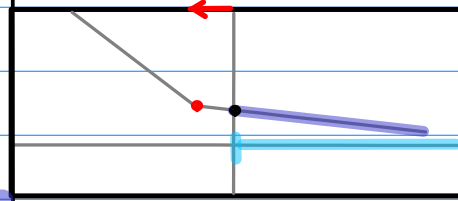

$$2^{-n-1} u(n)$$

(5') 1111

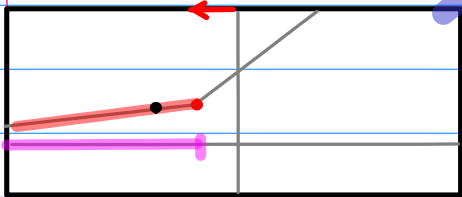

$$2^{n+1} u(-n-1)$$

(6') 1100

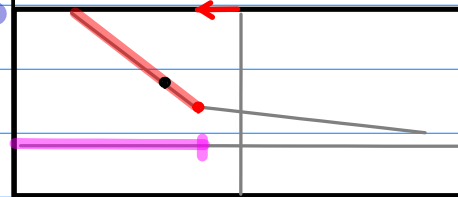

$$2^{-n-1} u(-n-1)$$

(3') 1010

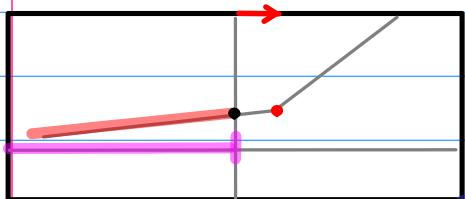

$$2^{n-1} u(-n)$$

(4') 1011

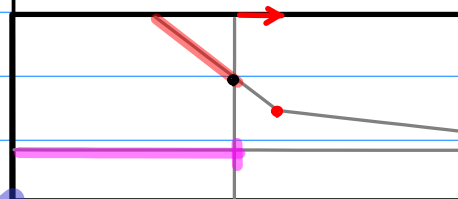

$$2^{-n+1} u(-n)$$

(7') 1101

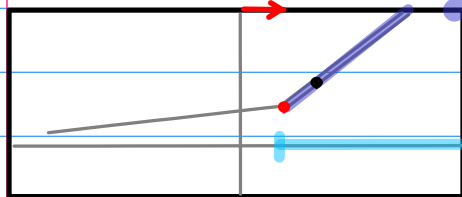

$$2^{n-1} u(n-1)$$

(8') 1110

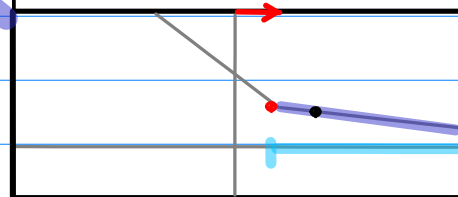

$$2^{-n+1} u(n-1)$$

## F. Complementary Inverting Base Inverting Range Complementing

### 1) Base Inverting = (Base Inverting, ID)

$$2^{n+1} \longleftrightarrow 2^{-(n+1)}$$

$$2^{n-1} \longleftrightarrow 2^{-(n-1)}$$

### 2) Range Complementing

$$u(n) \longleftrightarrow u(-n-1)$$

$$u(n-1) \longleftrightarrow u(-n)$$

### 3) Complementary Inverting

$$\begin{array}{|c|} \hline 2^{n+1} \\ \hline u(n) \\ \hline \end{array} \longleftrightarrow \begin{array}{|c|} \hline 2^{-(n+1)} \\ \hline u(-n-1) \\ \hline \end{array} \quad \begin{array}{|c|} \hline 2^{n-1} \\ \hline u(-n) \\ \hline \end{array} \longleftrightarrow \begin{array}{|c|} \hline 2^{-(n-1)} \\ \hline u(n-1) \\ \hline \end{array}$$

$$\begin{array}{|c|} \hline 2^{-(n+1)} \\ \hline u(n) \\ \hline \end{array} \longleftrightarrow \begin{array}{|c|} \hline 2^{n+1} \\ \hline u(-n-1) \\ \hline \end{array} \quad \begin{array}{|c|} \hline 2^{-(n-1)} \\ \hline u(-n) \\ \hline \end{array} \longleftrightarrow \begin{array}{|c|} \hline 2^{n-1} \\ \hline u(n-1) \\ \hline \end{array}$$



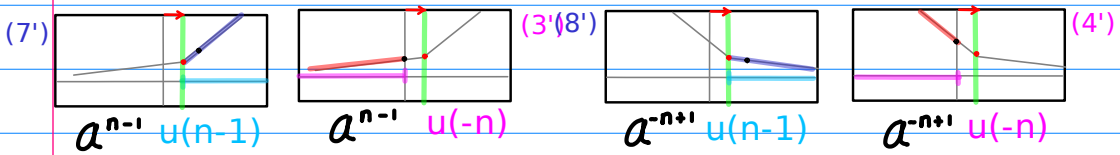
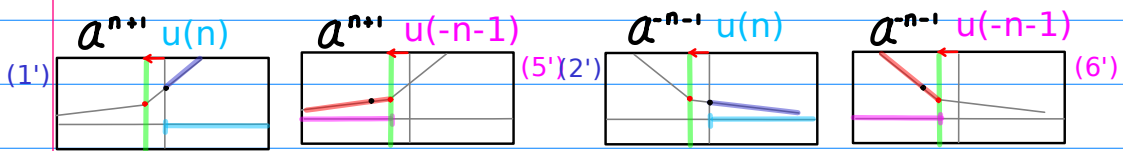
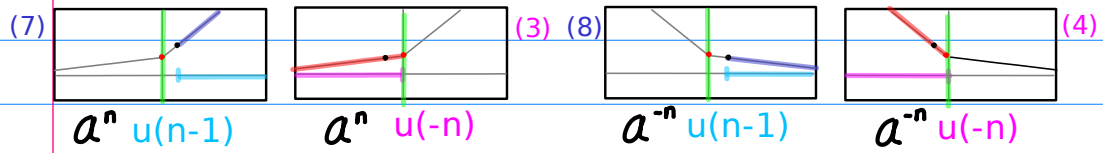
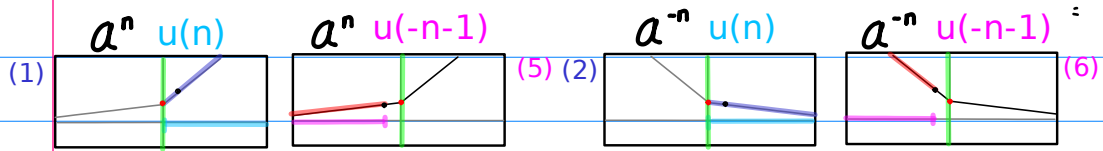

(1) 0000

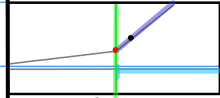

$$a^n u(n)$$

$$a^n u(-n-1)$$

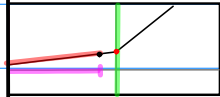

(5) 0100

(2) 0001

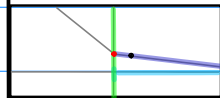

$$a^{-n} u(n)$$

$$a^{-n} u(-n-1)$$

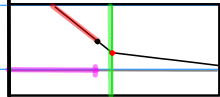

(6) 0101

(3) 0010

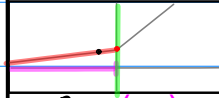

$$a^n u(-n)$$

$$a^n u(n-1)$$

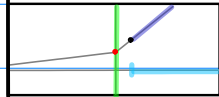

(7) 0110

(4) 0011

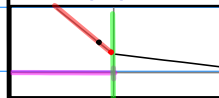

$$a^{-n} u(-n)$$

$$a^{-n} u(n-1)$$

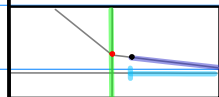

(8) 0111

(1') 1000

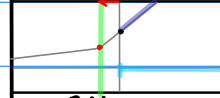

$$a^{n+1} u(n)$$

$$a^{n+1} u(-n-1)$$

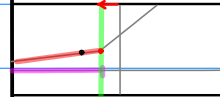

(5') 1100

(2') 1001

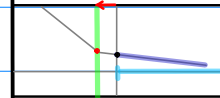

$$a^{-n-1} u(n)$$

$$a^{-n-1} u(-n-1)$$

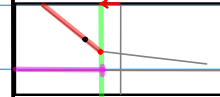

(6') 1101

(3') 1010

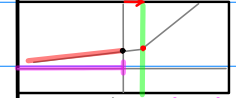

$$a^{n-1} u(-n)$$

$$a^{n-1} u(n-1)$$

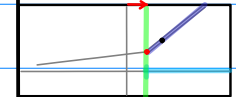

(7') 1110

(4') 1011

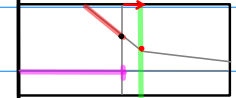

$$a^{-n+1} u(-n)$$

$$a^{-n+1} u(n-1)$$

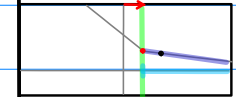

(8') 1111



