

Applications of Array Pointers (1A)

Copyright (c) 2010 - 2021 Young W. Lim.

Permission is granted to copy, distribute and/or modify this document under the terms of the GNU Free Documentation License, Version 1.2 or any later version published by the Free Software Foundation; with no Invariant Sections, no Front-Cover Texts, and no Back-Cover Texts. A copy of the license is included in the section entitled "GNU Free Documentation License".

Please send corrections (or suggestions) to youngwlim@hotmail.com.
This document was produced by using LibreOffice.

Virtual Array Pointers in Multi-dimensional Arrays

Pointers to various data types

int *p; **int i, j, k;**



double *q; **double a, b, c;**

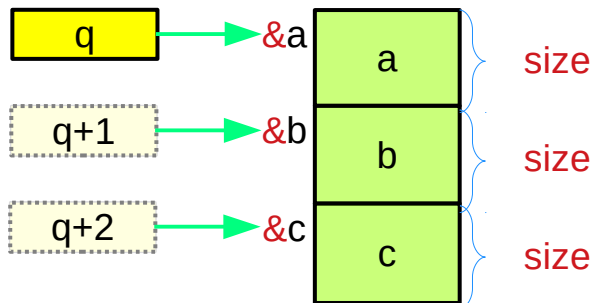

T *p; **T X, Y, Z;**

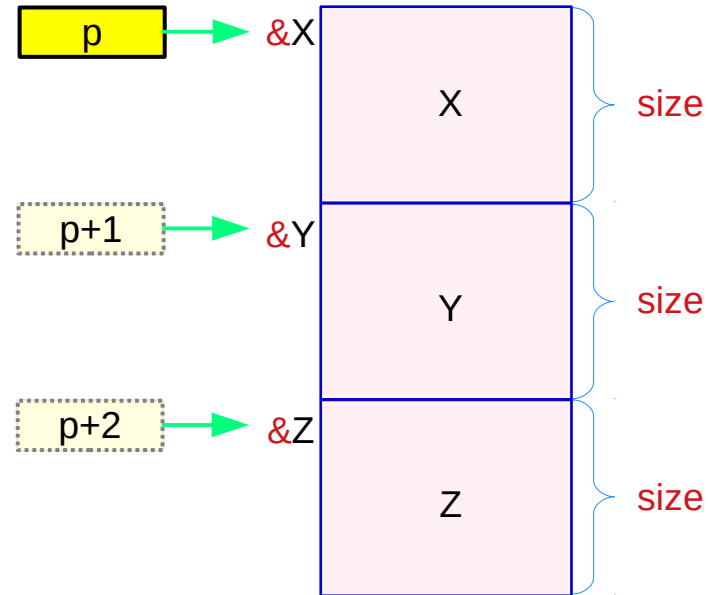

pointer

abstract data

Pointers to primitive data

int *p;

int i, j, k;

sizeof(int) = 4 bytes

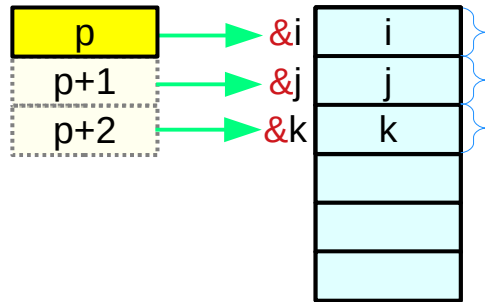

size
size
size

$\text{size} = \text{sizeof}(i) = \text{sizeof}(*p)$
 $\text{size} = \text{sizeof}(j) = \text{sizeof}(*(p+1))$
 $\text{size} = \text{sizeof}(k) = \text{sizeof}(*(p+2))$

$\neq \text{sizeof}(p)$
 $\neq \text{sizeof}(p+1)$
 $\neq \text{sizeof}(p+2)$

pointer size
4 or 8 bytes

double *q;

double a, b, c;

sizeof(double) = 8 bytes

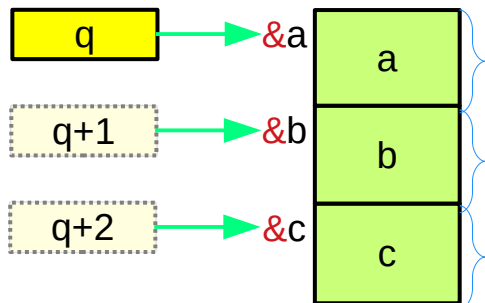

size
size
size

$\text{size} = \text{sizeof}(a) = \text{sizeof}(*q)$
 $\text{size} = \text{sizeof}(b) = \text{sizeof}(*(q+1))$
 $\text{size} = \text{sizeof}(c) = \text{sizeof}(*(q+2))$

$\neq \text{sizeof}(q)$
 $\neq \text{sizeof}(q+1)$
 $\neq \text{sizeof}(q+2)$

pointer size
4 or 8 bytes

Pointers to abstract data

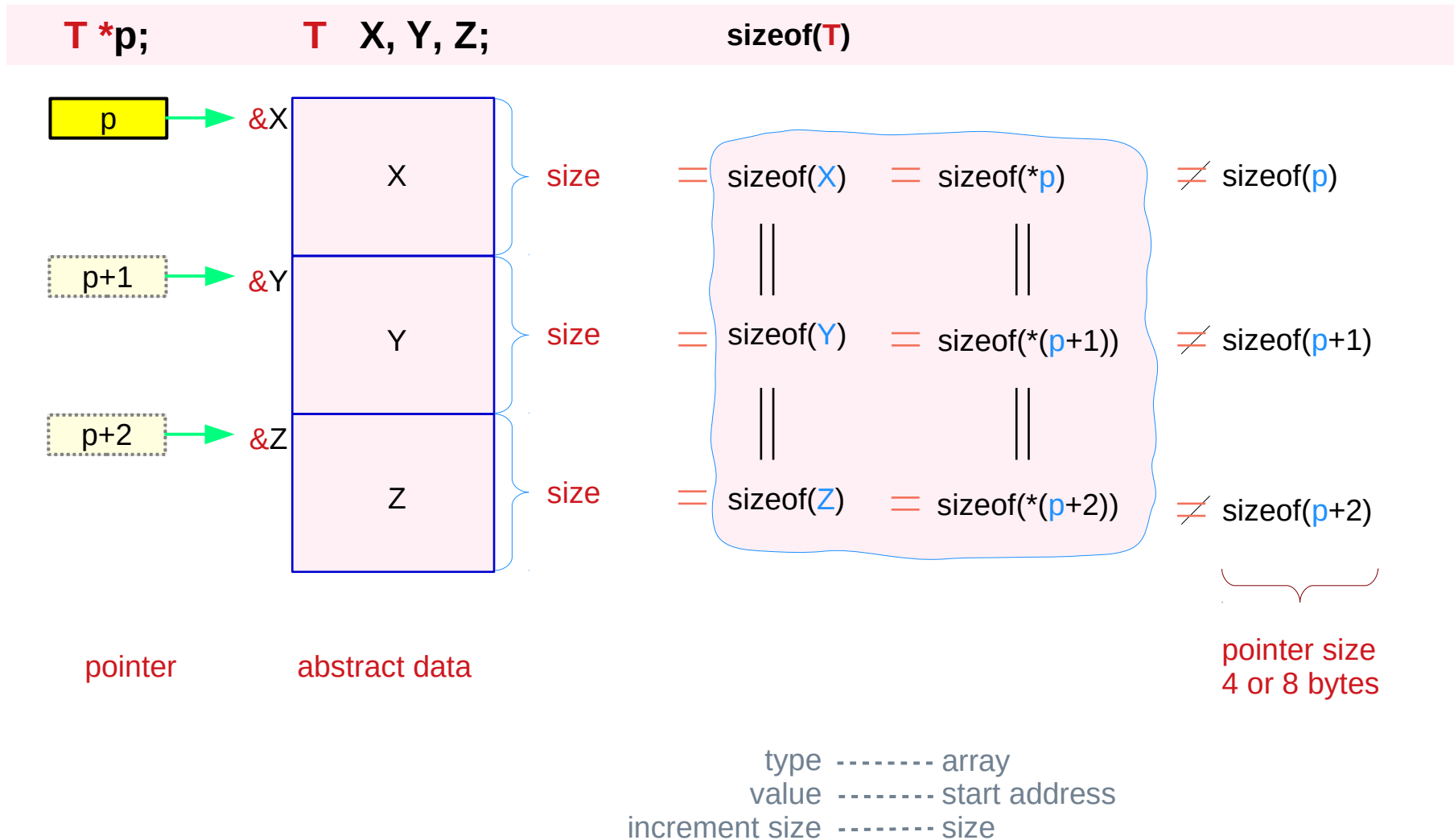

Virtual pointers in an array of integers

```
int p[3];
```

p is an abstract data (array)

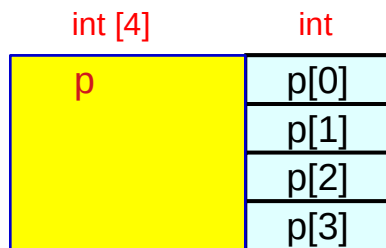

- p** is the name of an array
- p** has the size of the whole array
- p** has an array type (abstract data)

p can also be viewed as a pointer

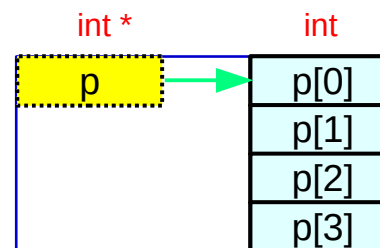

- p** also has pointer characteristics
- p** has the value of the starting address
- p** is a virtual pointer

Virtual pointers in an array of abstract data

Abstract data array p

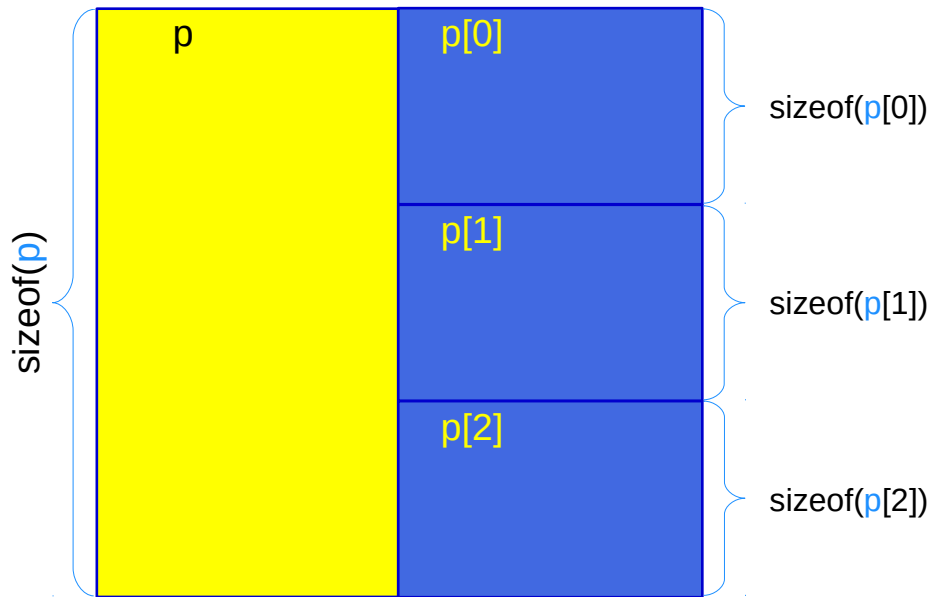

- p** has an array type (abstract data element)
- p** is the name of an array
- p** has the size of the whole array

Virtual pointer p

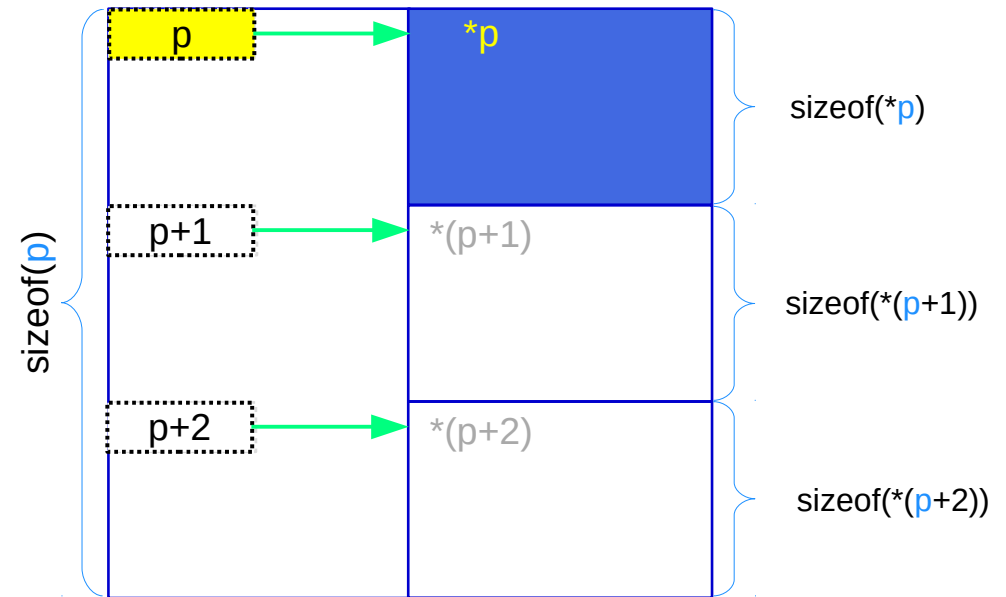

- p** also has a pointer type
- p** has the value of the starting address
- p** is a virtual array pointer

Virtual pointer to abstract data

virtual pointer p abstract data *p

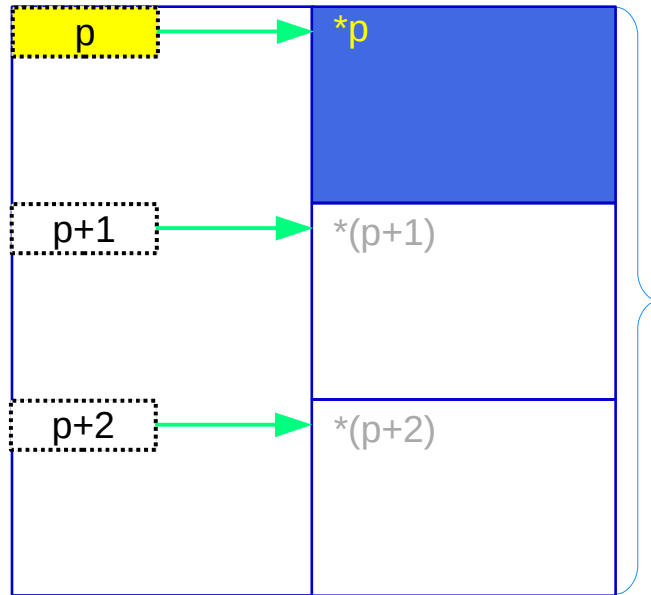

whole array size

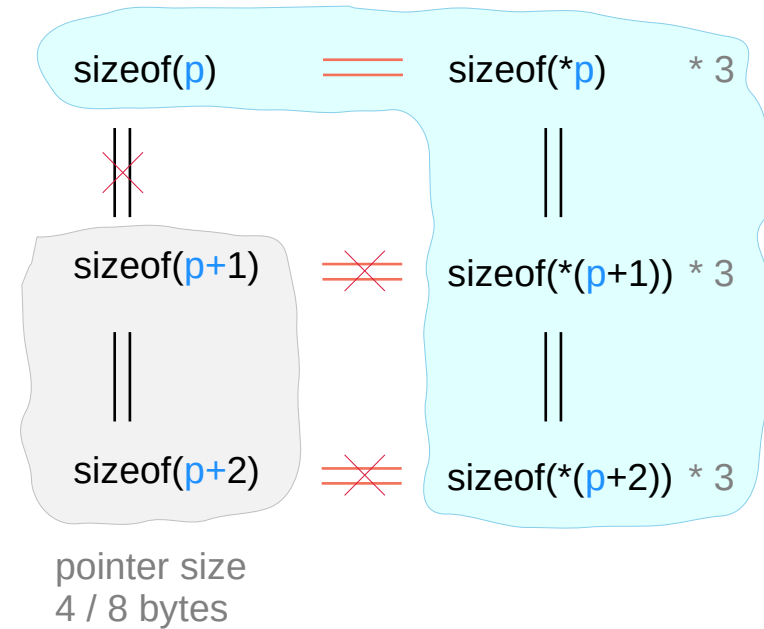

Virtual array pointers in a multi-dimensional array

Abstract data (array) $p[i]$

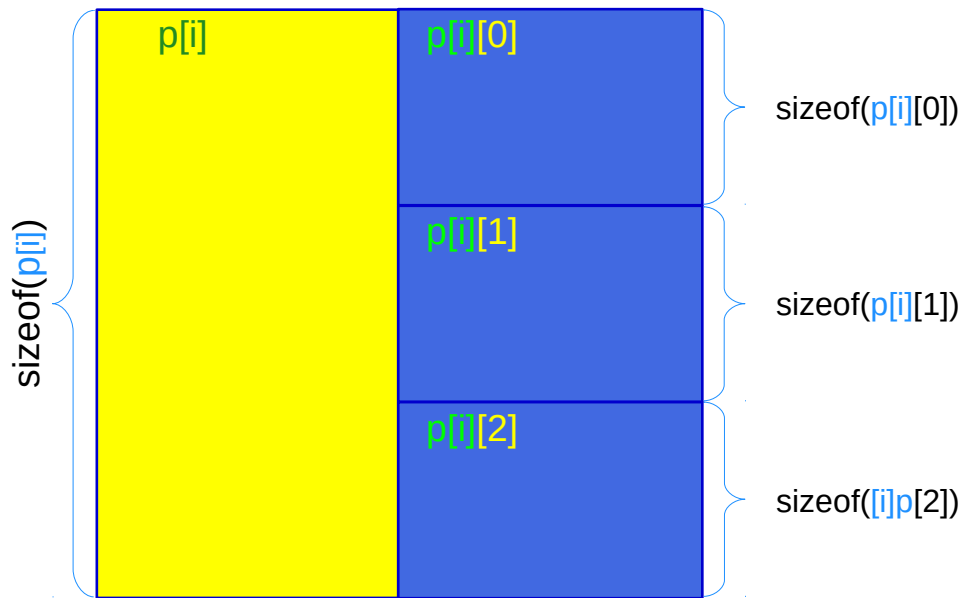

$p[i]$ has an array type (abstract data)
 $p[i]$ is the name of an array
 $p[i]$ has the size of the whole array

Virtual array pointer $p[i]$

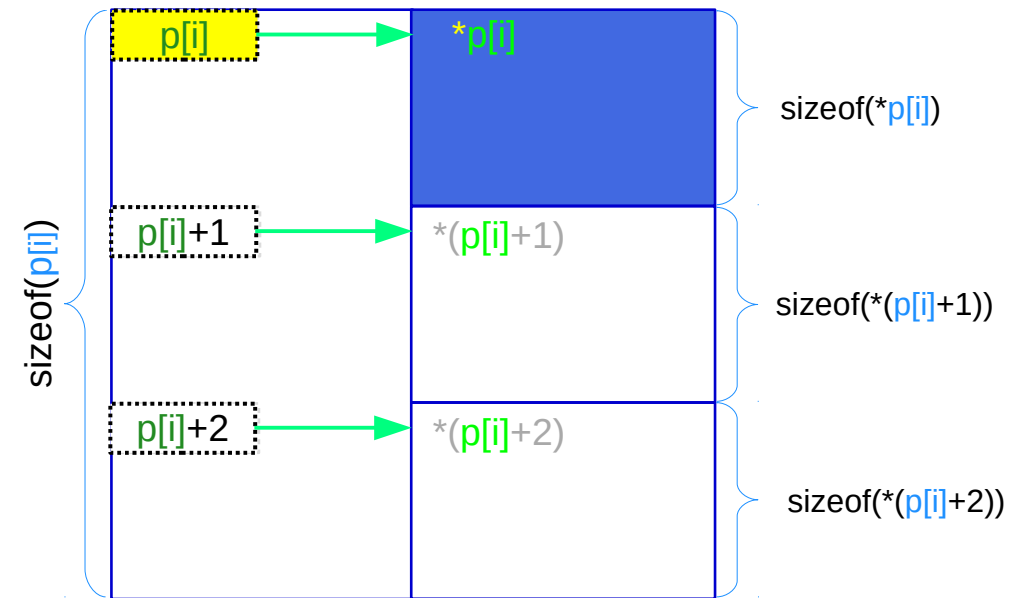

$p[i]$ also has an array pointer type
 $p[i]$ has the value of the starting address

$p[i]$ is a virtual array pointer

Virtual pointers to a sub array

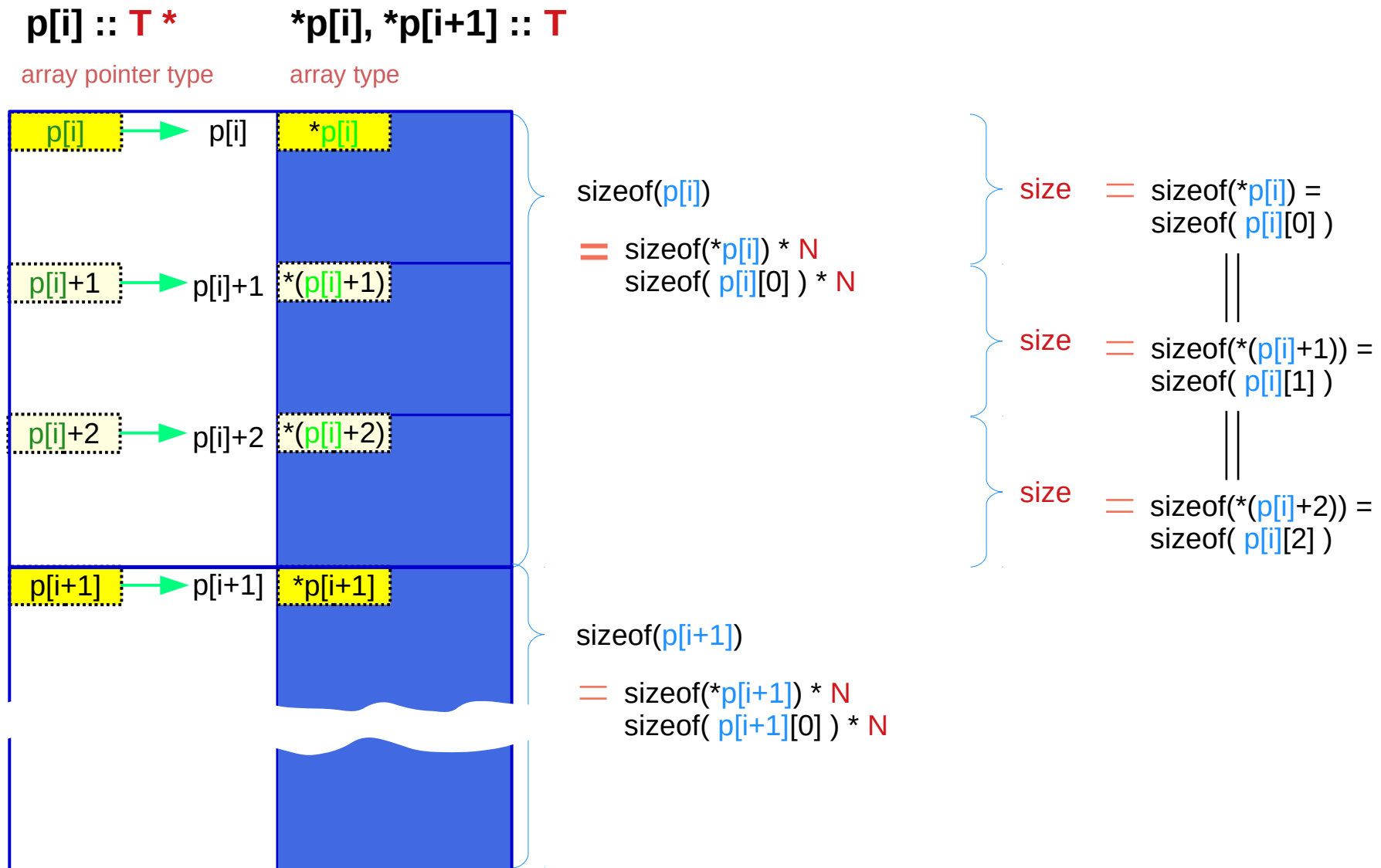

Array pointer types

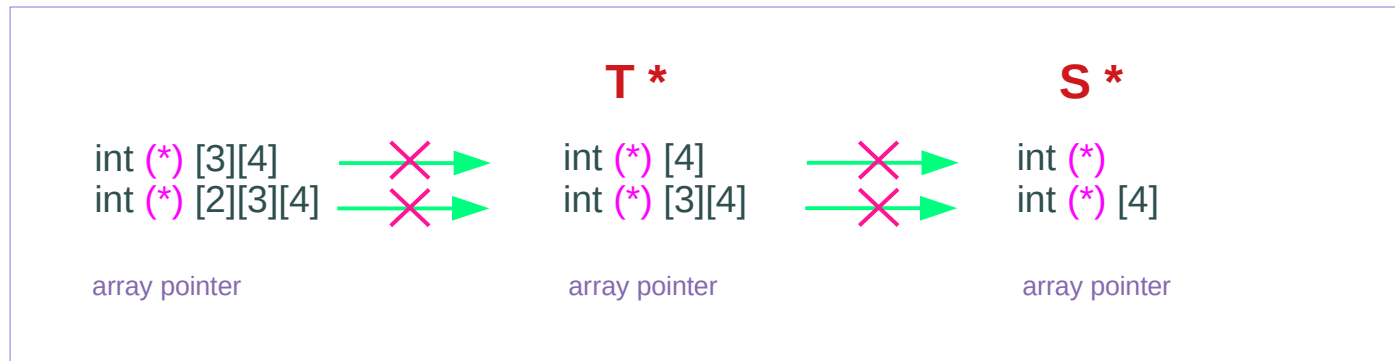
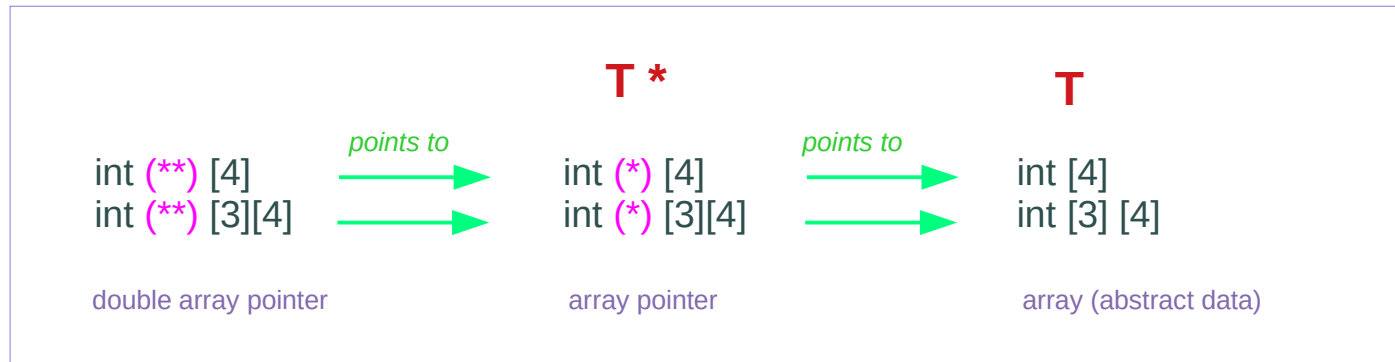

Array pointer types point to array types

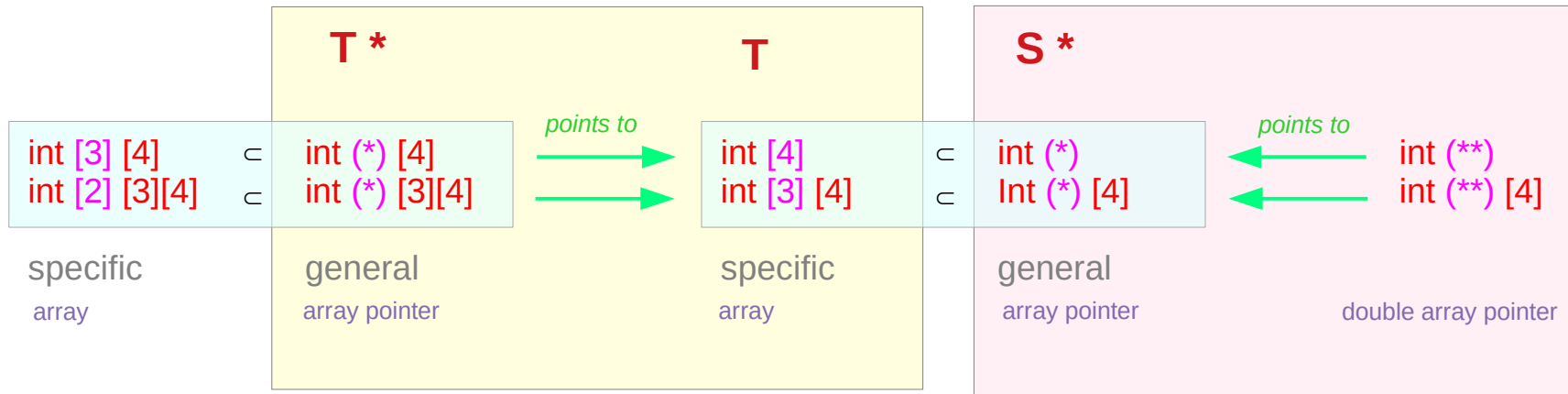

Virtual array pointers pointing to arrays

```
typedef int (*T1) [4];  
typedef int (*T1) [3][4];
```

int (*) [4]
int (*) [3][4]
general

```
typedef int T2[4];  
typedef int T2[3][4];
```

int [4]
int [3] [4]
specific

```
T1 a;  
T2 b;
```

T1 is a pointer type
T2 is an array type
T1 has one more dimension than T2

```
a = &b;  
*a = b;
```

a references **b**

b is the dereference of **a**

3-d array structure – pointer representation

```
int c[2][3][4];
```

```
*(***(c +i) +j) +k)
```

- Hierarchical
- Nested Structure
- Virtual Array Pointers to abstract data (subarrays)
- Contiguous and Linear Data Layout
- Row Major Order

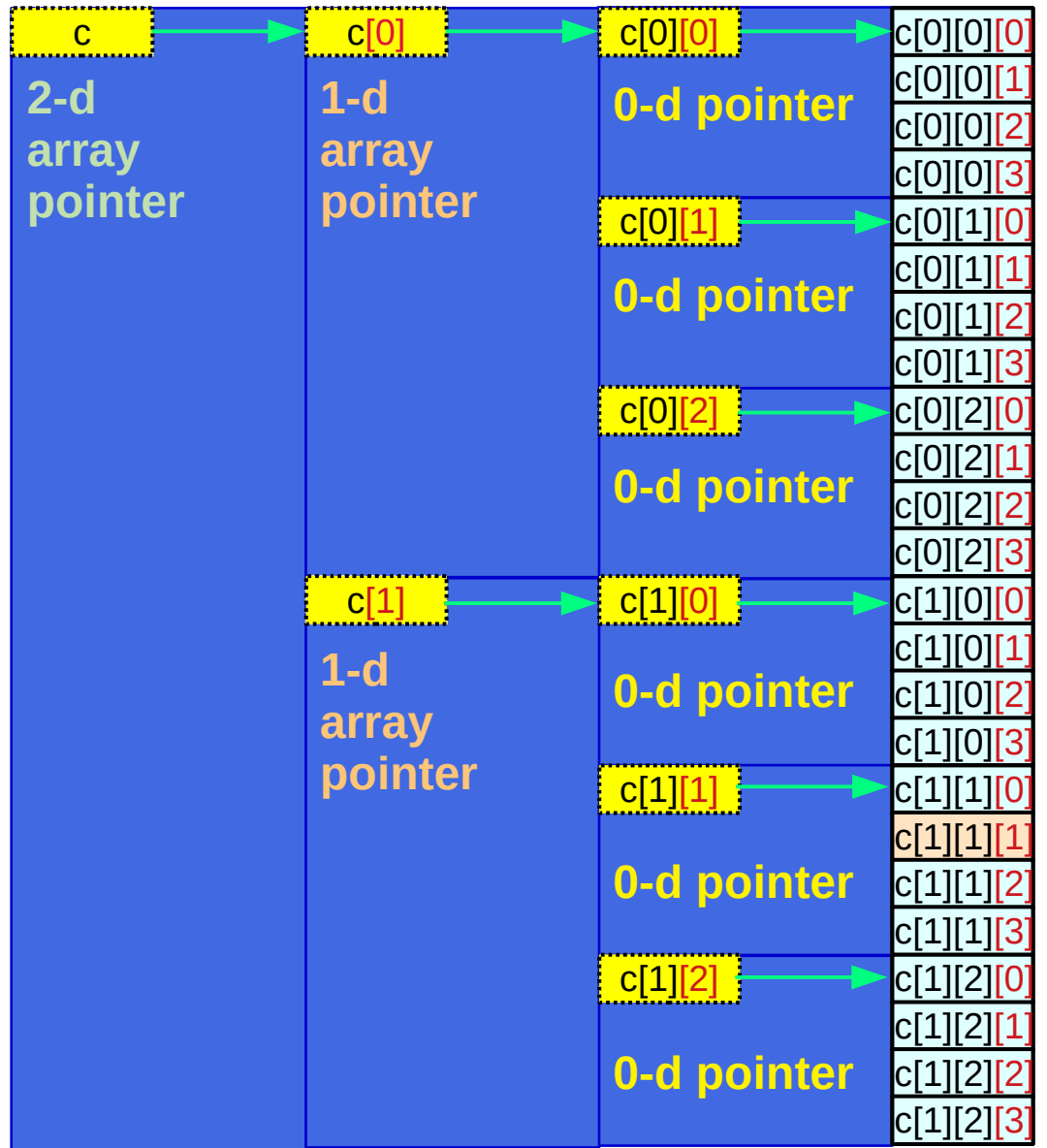

3-d array structure – abstract data representation

```
int c[2][3][4];
```

```
((c [i])[j])[k]
```

- Hierarchical
- Nested Structure
- Virtual Array Pointers to abstract data (subarrays)
- Contiguous and Linear Data Layout
- Row Major Order

c 3-d array name	c[0] 2-d array name	c[0][0] 1-d array name	c[0][0][0] c[0][0][1] c[0][0][2] c[0][0][3]
		c[0][1] 1-d array name	c[0][1][0] c[0][1][1] c[0][1][2] c[0][1][3]
		c[0][2] 1-d array name	c[0][2][0] c[0][2][1] c[0][2][2] c[0][2][3]
	c[1] 2-d array name	c[1][0] 1-d array name	c[1][0][0] c[1][0][1] c[1][0][2] c[1][0][3]
		c[1][1] 1-d array name	c[1][1][0] c[1][1][1] c[1][1][2] c[1][1][3]
		c[1][2] 1-d array name	c[1][2][0] c[1][2][1] c[1][2][2] c[1][2][3]

Array **a** and pointer **a**

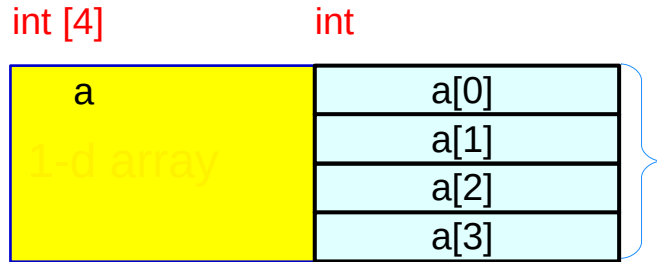

1-d array **a** specific array type

$\text{sizeof}(a)$

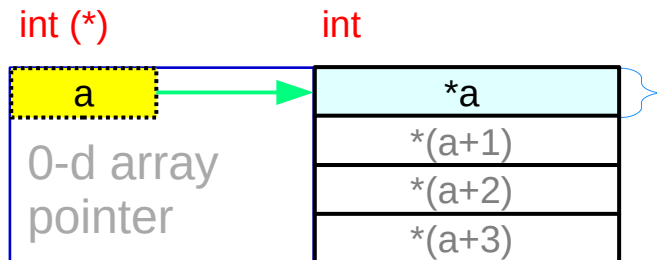

pointer **a** general pointer type

$\text{sizeof}(a) = \text{sizeof}(*a) * 4$

- a** is the name of a 1-d array
- a** also has a pointer type
- a** has the size of the array
- a** has the value of the starting address

a is a virtual array pointer

Array **b** and pointer **b**

2-d array **b** specific array type

`sizeof(b)`

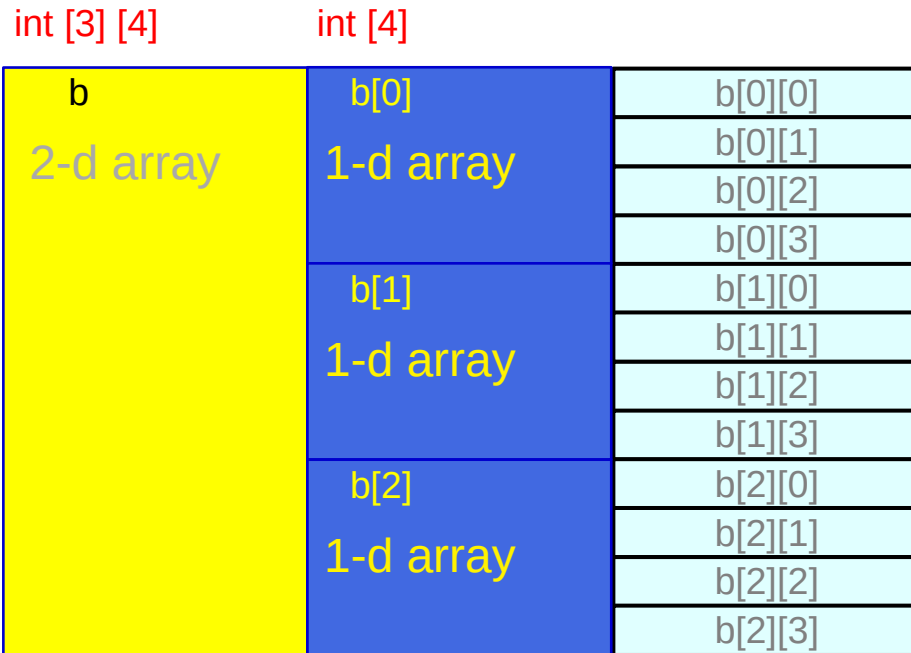

b is the name of a 2-d array
b has the size of the array

1-d array pointer **b** general pointer type

`sizeof(b) = sizeof(*b) * 3`

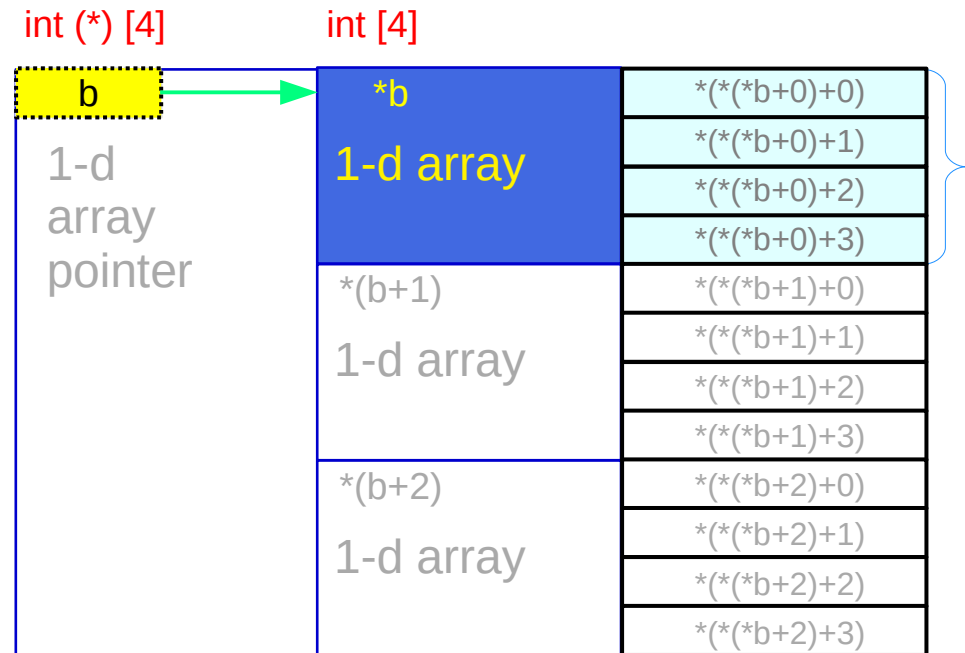

b also has a 1-d array pointer type
b has the value of the starting address

b is a virtual array pointer

Array c

3-d array c

specific array type

sizeof(c)

int [2][3][4]	int [3][4]	int [4]		
c 3-d array	c[0] 2-d array	c[0][0] 1-d array	c[0][0][0] c[0][0][1] c[0][0][2] c[0][0][3]	
		c[0][1] 1-d array	c[0][1][0] c[0][1][1] c[0][1][2] c[0][1][3]	
		c[0][2] 1-d array	c[0][2][0] c[0][2][1] c[0][2][2] c[0][2][3]	
		c[1] 2-d array	c[1][0] 1-d array	c[1][0][0] c[1][0][1] c[1][0][2] c[1][0][3]
			c[1][1] 1-d array	c[1][1][0] c[1][1][1] c[1][1][2] c[1][1][3]
			c[1][2] 1-d array	c[1][2][0] c[1][2][1] c[1][2][2] c[1][2][3]

c is the name of a 3-d array
c has the size of the array

Pointer c

2-d array pointer c

general pointer type

$\text{sizeof}(c) = \text{sizeof}(*c) * 2$

- c also has a 2-d array pointer type
- c has the value of the starting address
- c is a virtual array pointer

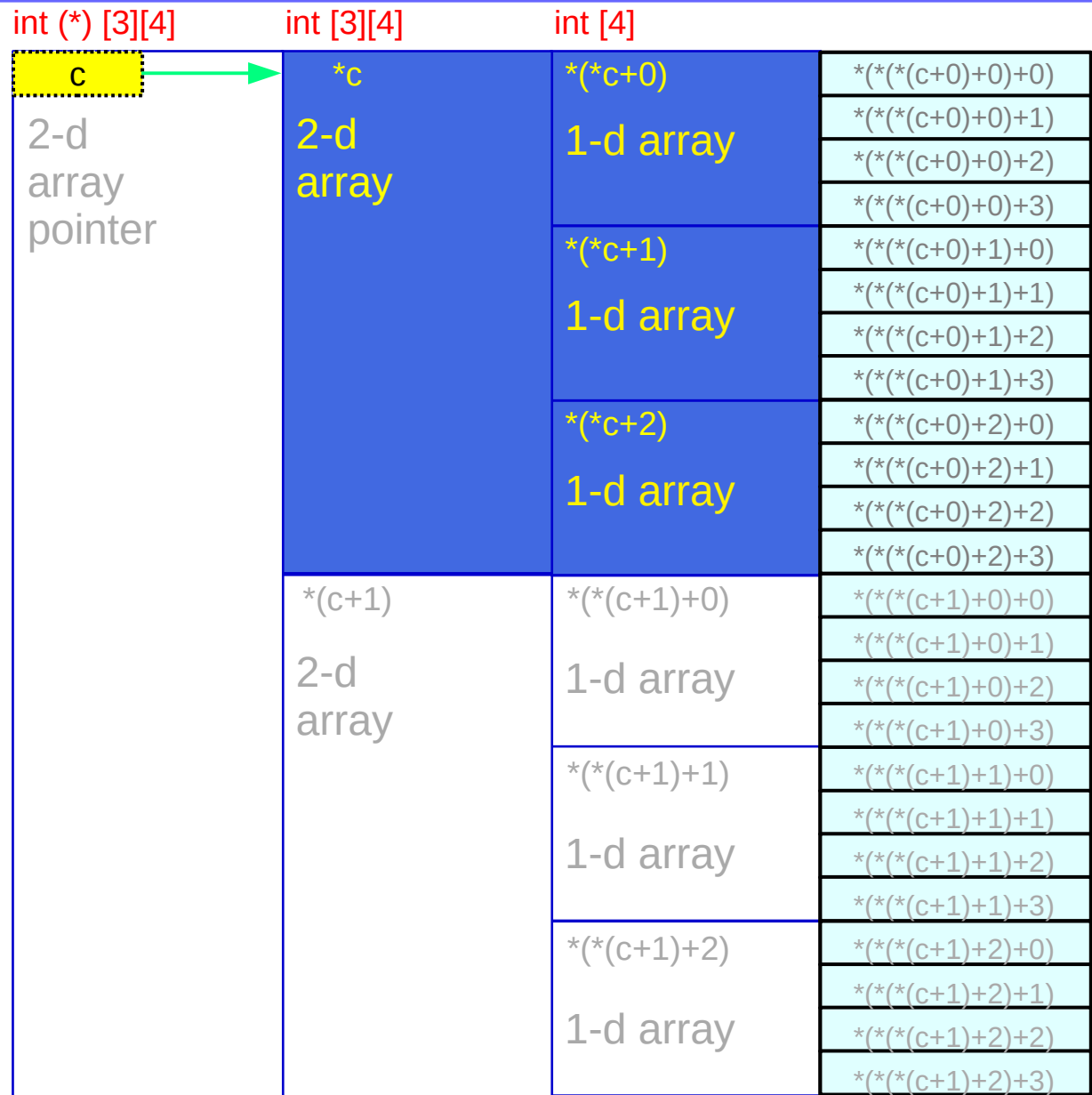

Types of virtual array pointers in a 3-d array

```
int c[2][3][4];
```

`c[i][j][k]`

`c[i][j]`
[k]

`c[i]`
[j] [k]

`c`
[i] [j] [k]

int

int [4]
[k]

int [3][4]
[j] [k]

int [2][3][4]
[i] [j] [k]

array type (name)

int

int (*)
[k]

int (*)[4]
[j] [k]

int (*)[3][4]
[i] [j] [k]

array pointer type

Sizes of virtual array pointers in a 3-d array

```
int c[2][3][4];
```

$\text{sizeof}(c[i][j][k]) = \text{sizeof}(\text{int})$

$\text{sizeof}(c[i][j])_{[k]} = \text{sizeof}(\text{int}) * 4_{[k]}$

$\text{sizeof}(c[i])_{[j] [k]} = \text{sizeof}(\text{int}) * 3 * 4_{[j] [k]}$

$\text{sizeof}(c)_{[i] [j] [k]} = \text{sizeof}(\text{int}) * 2 * 3 * 4_{[i] [j] [k]}$

Address values of virtual array pointers in a 3-d array

```
int c[2][3][4];
```

$c[i][j][k] = \&c[i][j][k]$

$c[i][j]+k = \&c[i][j][0] + k * \text{sizeof}(c[i][j][k])$ $\text{sizeof}(*c[i][j]) = \text{sizeof}(c[i][j][0]) = \text{sizeof}(\text{int})$

$c[i]+j = \&c[i][0][0] + j * \text{sizeof}(c[i][j])$ $\text{sizeof}(*c[i]) = \text{sizeof}(c[i][0]) = \text{sizeof}(\text{int}) * 4$
[k]

$c+i = \&c[0][0][0] + i * \text{sizeof}(c[i])$ $\text{sizeof}(*c) = \text{sizeof}(c[0]) = \text{sizeof}(\text{int}) * 3 * 4$
[j] [k]

Types in a multi-dimensional 3-d array

```
int c [2][3][4];
```

abstract data `int [2] [3][4]`

array pointer `int (*) [3][4]`

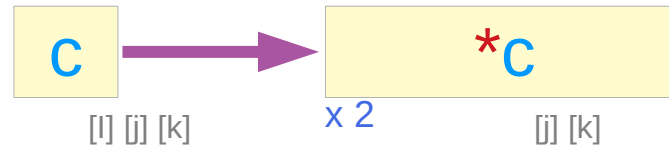

`int [3] [4]` abstract data

`int (*) [4]` array pointer

abstract data `int [3] [4]`

array pointer `int (*) [4]`

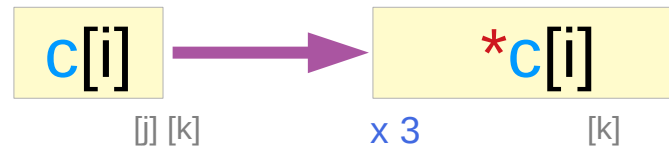

`int [4]` abstract data

`int (*)` array pointer

abstract data `int [4]`

array pointer `int (*)`

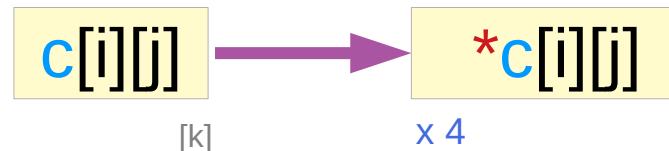

`int` primitive data

Virtual array pointers and abstract data

```
int c [2][3][4];
```

2-d array pointer `int (*) [3][4]`

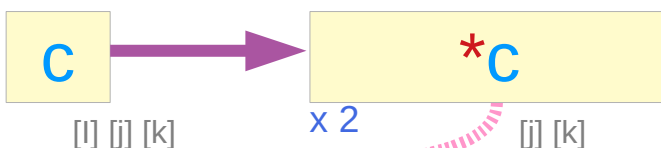

`int [3][4]` 2-d array

1-d array pointer `int (*) [4]`

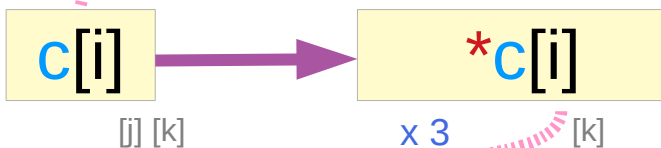

`int [4]` 1-d array

0-d array pointer `int (*)`

`int (*)`

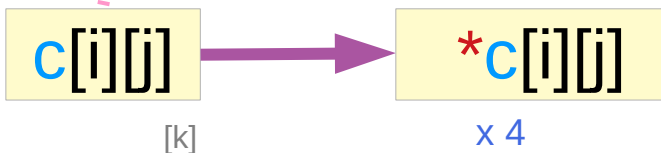

`int` 0-d array

all these pointers are virtual, and take no actual memory locations

exploiting the **contiguity** of allocated memory locations

Abstract data sizes

```
int c [2][3][4];
```

the size of a pointer type is fixed
Here, the sizes of virtual pointers are shown
i.e, the sizes of different abstract data types

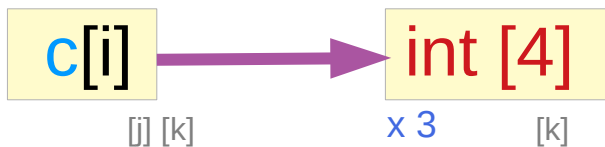
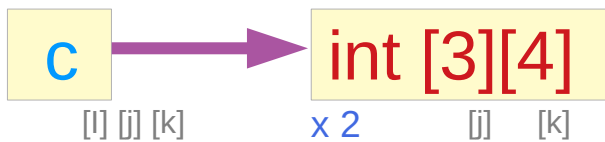

```
sizeof( c) = sizeof(int [2][3][4])
sizeof(*c) = sizeof(int [3][4])

sizeof( c[i]) = sizeof(int [3][4])
sizeof(*c[i]) = sizeof(int [4])

sizeof( c[i][j]) = sizeof(int [4])
sizeof(*c[i][j]) = sizeof(int)
```

all are sizes of arrays

`c`, `c[i]`, `c[i][j]` are virtual array pointers
and they are also abstract data (arrays)

when sizes are considered,
view them as abstract data (arrays)

Virtual array pointer sizes and abstract data sizes

```
int c [2][3][4];
```

$$\text{size of a virtual array pointer} = \text{size of the pointed abstract data type} * \text{the number of such types}$$

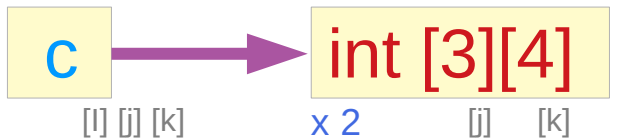

$$\text{sizeof}(c) = \text{sizeof}(*c) * 2$$

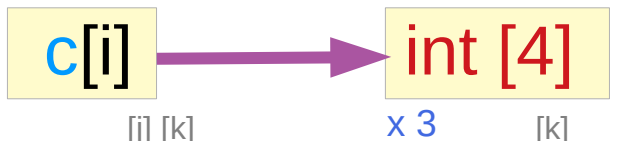

$$\text{sizeof}(c[i]) = \text{sizeof}(*c[i]) * 3$$



$$\text{sizeof}(c[i][j]) = \text{sizeof}(*c[i][j]) * 4$$

Sizes of array pointer types

```
int c [2][3][4];
```

`c` \rightarrow `int [3][4]`
[i] [j] [k] [j] [k]

`c[i]` \rightarrow `int [4]`
[j] [k] [k]

`c[i][j]` \rightarrow `int`
[k]

not real array pointers
virtual array pointers



`c` `int (*)[3][4]` = sizeof(c)
sizeof(int (*) [3][4]) = pointer size \neq sizeof(c)

`c[i]` `int (*) [4]` = sizeof(c[i])
sizeof(int (*) [4]) = pointer size \neq sizeof(c[i])

`c[i][j]` `int [4]` = sizeof(c[i][j])
sizeof(int [4]) = pointer size \neq sizeof(c[i][j])



4 bytes for 32-bit machines
8 bytes for 64-bit machines

Virtual array pointer increment size

```
int c [2][3][4];
```

c points to a **2-d** array
increment size: `sizeof(int[2][3][4])`

c[i] points to an **1-d** array
increment size: `sizeof(int[3][4])`

c[i][j] points to an integer
increment size: `sizeof(int[4])`

int (*) [3][4]

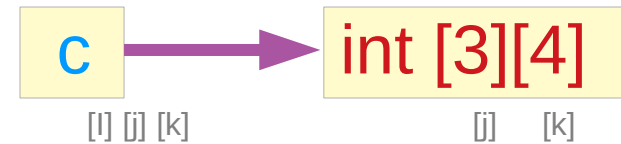

int (*) [4]

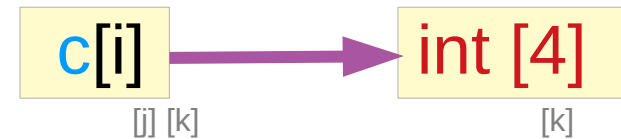

int (*)



Subarrays in a 3-d array

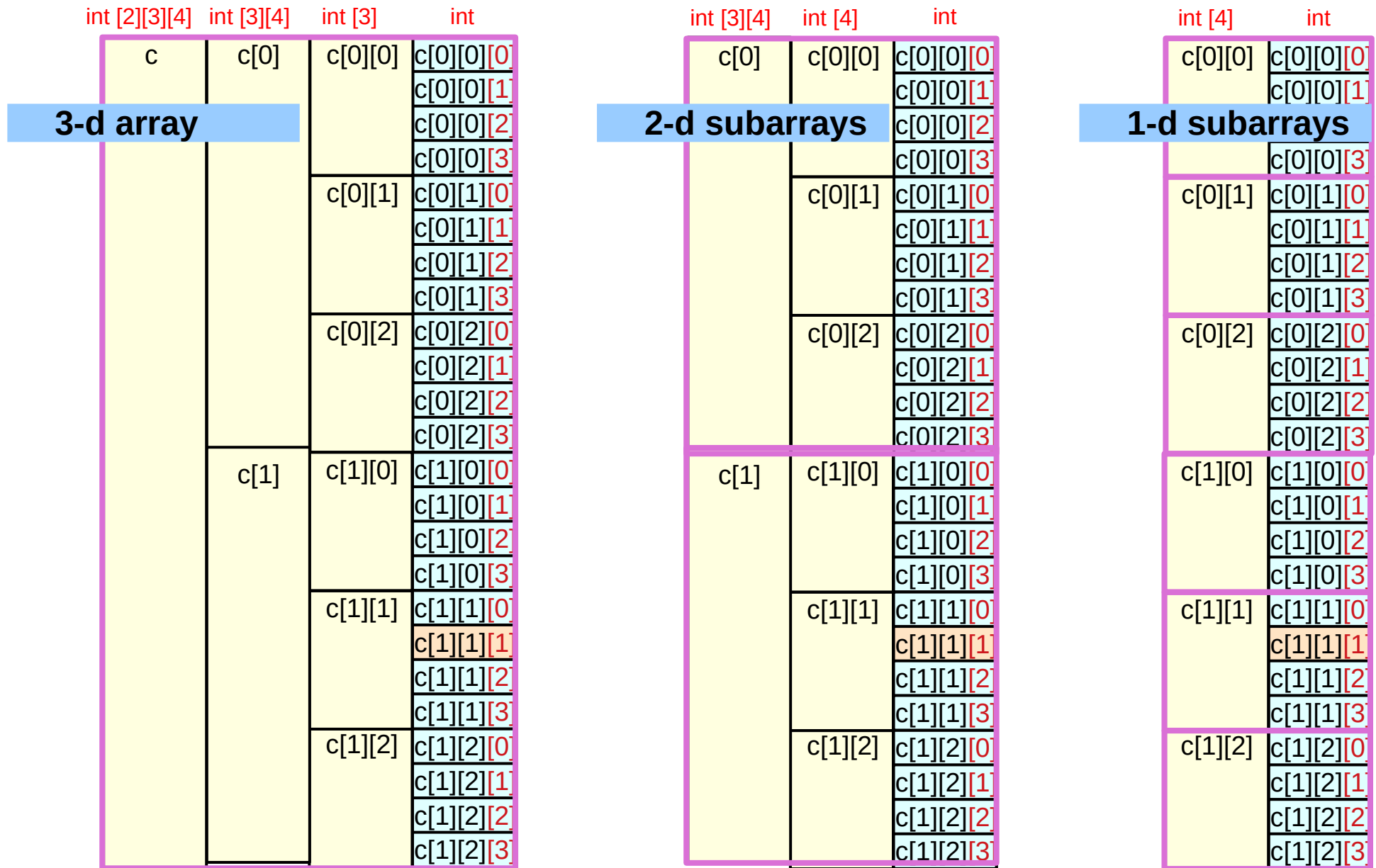

Virtual array pointer c, c[0], c[0][0] – types and sizes

Types – array pointers

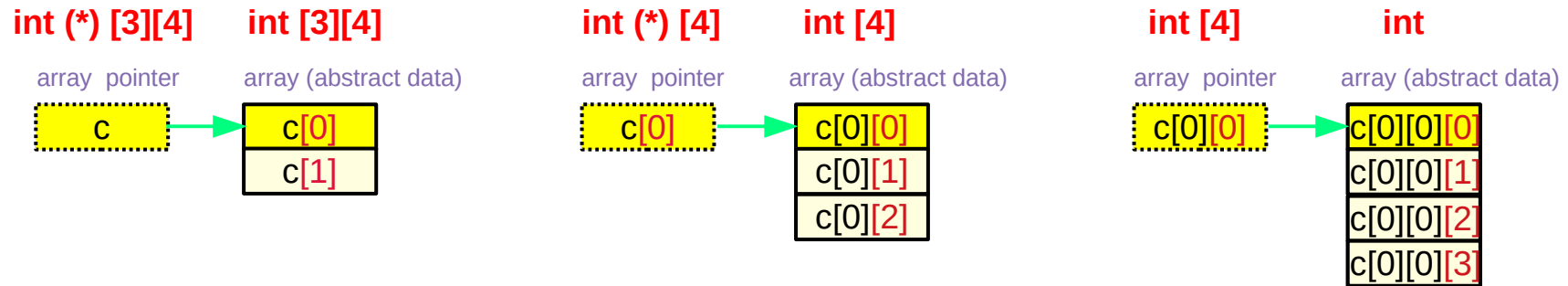

Sizes – abstract data

`sizeof(c)`
`sizeof(int [2][3][4])`
`sizeof(int) * 2 * 3 * 4`

`sizeof(int [2][3][4]) = 96`
`sizeof(int (*)[3][4]) = 4 / 8`

`sizeof(c[0])`
`sizeof(int [3][4])`
`sizeof(int) * 3 * 4`

`sizeof(int [3][4]) = 48`
`sizeof(int (*)[4]) = 4 / 8`

`sizeof(c[0][0])`
`sizeof(int [4])`
`sizeof(int) * 4`

`sizeof(int [4]) = 16`
`sizeof(int (*) = 4 / 8`

Pointers to subarrays in a 3-d array

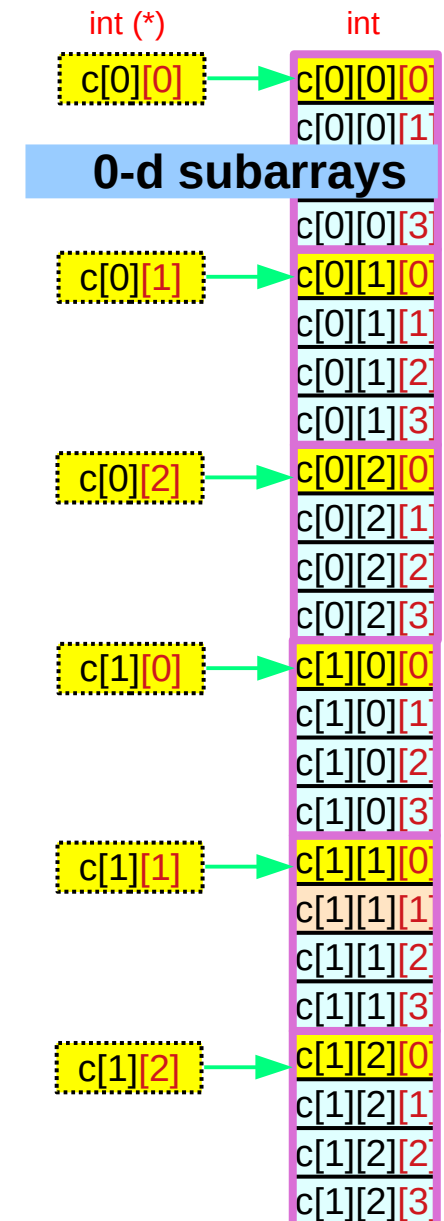
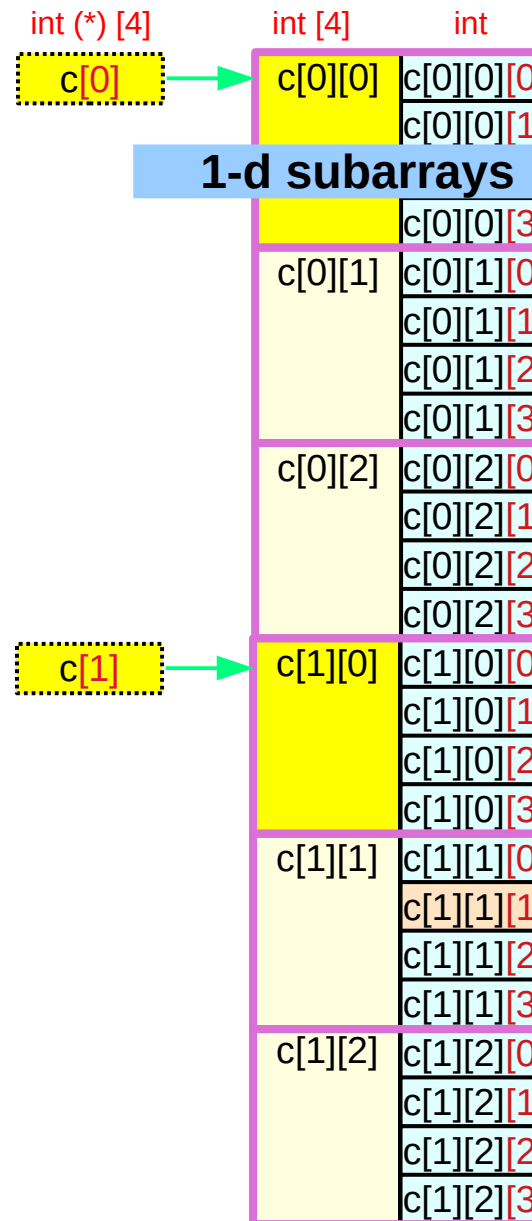
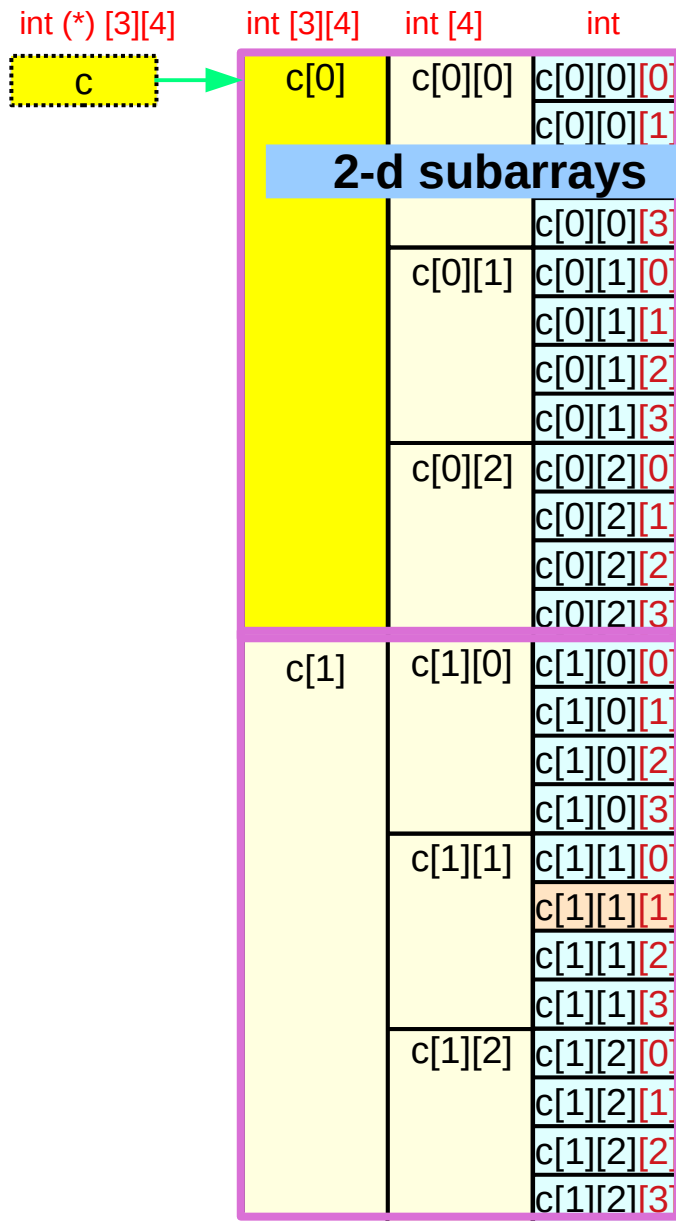

Abstract Data c , $c[i]$, $c[i][j]$ – start addresses and sizes

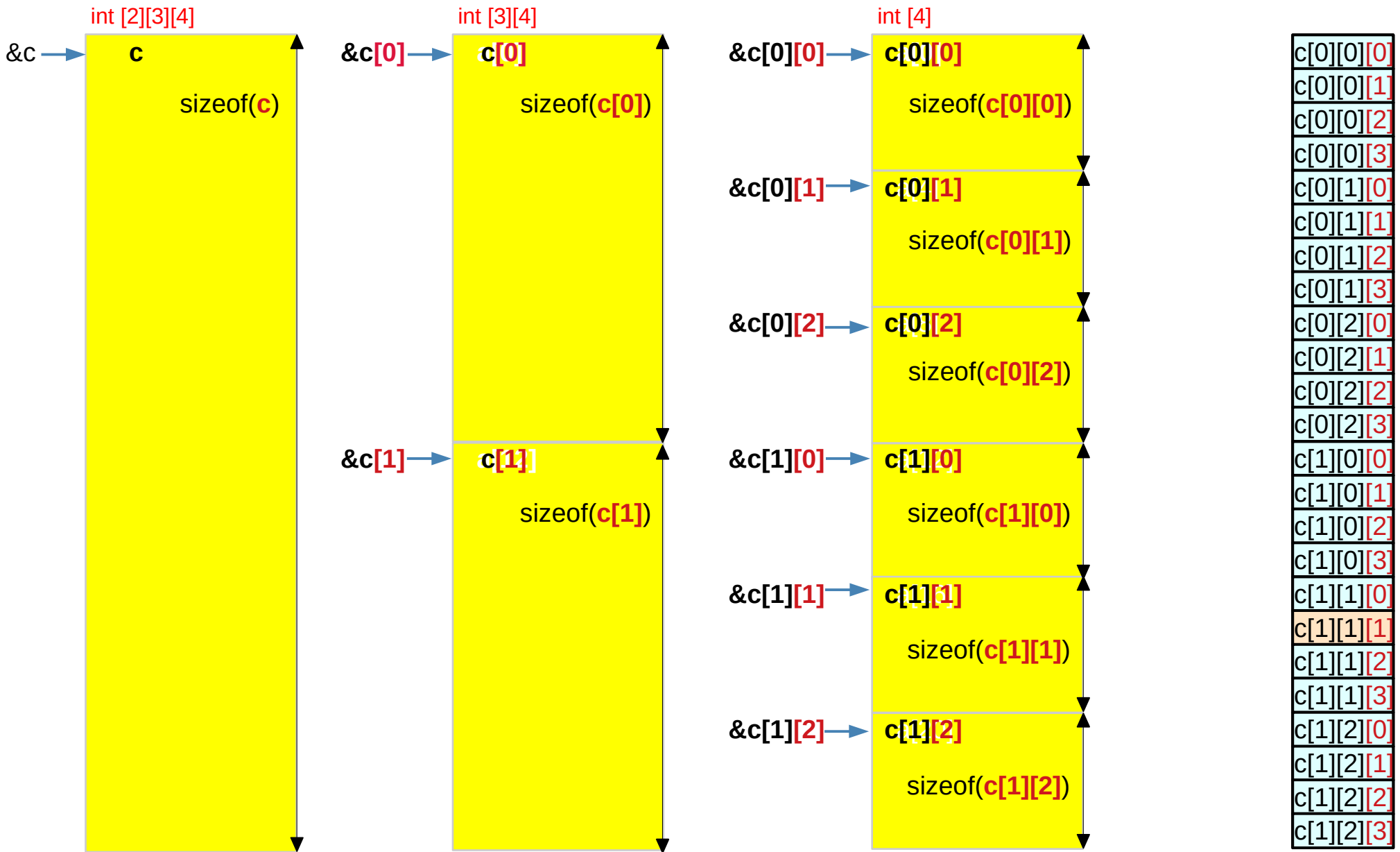

Virtual array pointers – types, sizes, and values

int c[2][3][4];	c[i][j]	c[i][j][0]	
type	int [4] int (*)	int int	<ul style="list-style-type: none"> abstract data type array pointer type
size	sizeof(c[i][j]) =	sizeof(c[i][j][0]) * 4	= sizeof(int) * 4
value (address)	c[i][j] =	&c[i][j][0]	
int c[2][3][4];	c[i]	c[i][0]	
type	int [3][4] int (*)[4]	int [4] int (*)	<ul style="list-style-type: none"> abstract data type array pointer type
size	sizeof(c[i]) =	sizeof(c[i][0]) * 3	= sizeof(int) * 4 * 3
value (address)	c[i] =	&c[i][0][0]	
int c[2][3][4];	c	c[0]	
type	int [2][3][4] int (*)[3][4]	int [3][4] int (*)[4]	<ul style="list-style-type: none"> abstract data type array pointer type
size	sizeof(c) =	sizeof(c[0]) * 2	= sizeof(int) * 4 * 3 * 2
value (address)	c =	&c[0][0][0]	

Virtual array pointer c, c[i], c[i][j] – values (addresses)

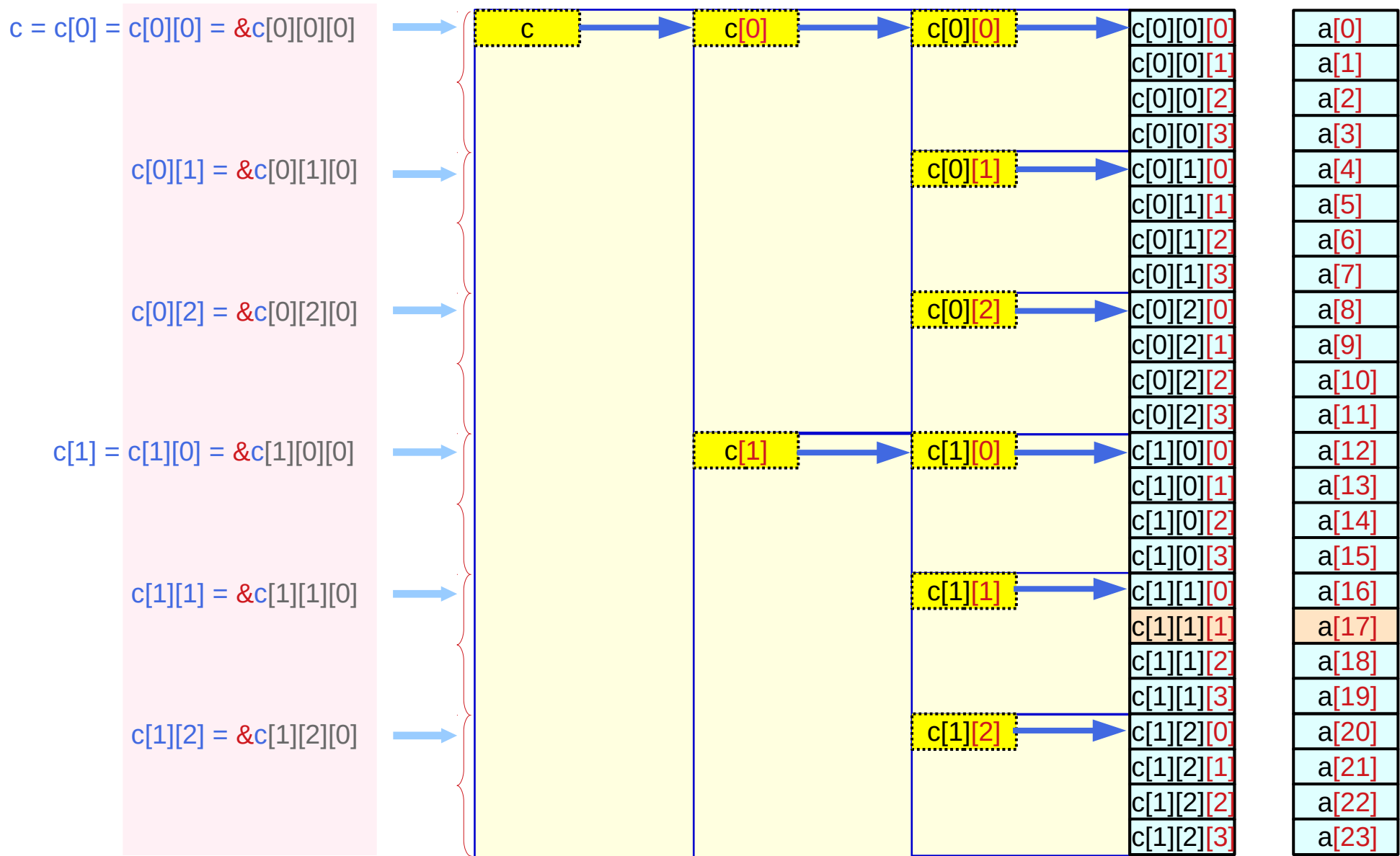

Virtual array pointer c , $c[i]$, $c[i][j]$ – vertical displacement

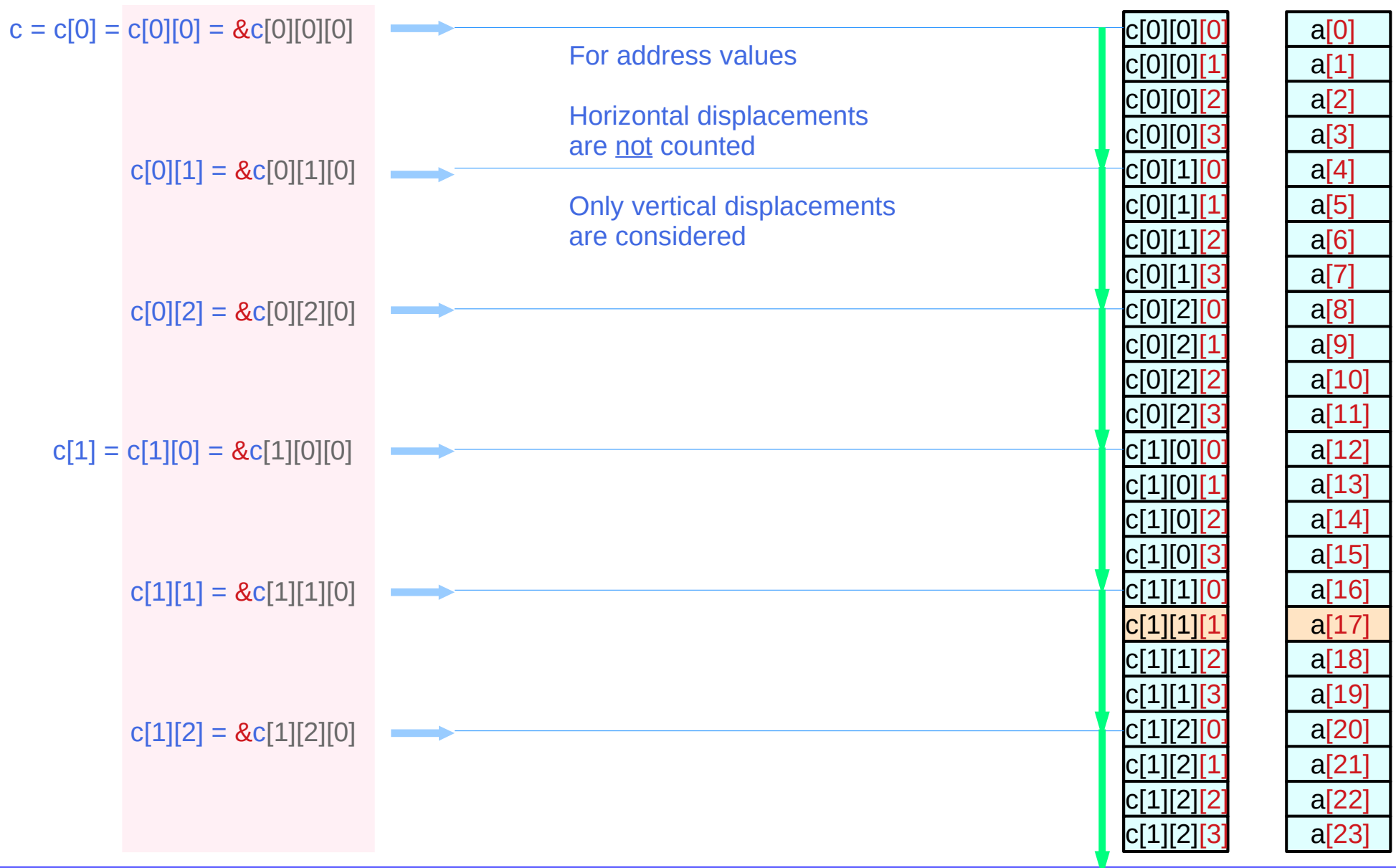

Virtual array pointer c, c[i], c[i][j] – values and types

$c = c[0] = c[0][0] = \&c[0][0][0]$ means

$c[0][1] = \&c[0][1][0]$ means

$c[0][2] = \&c[0][2][0]$ means

$c[1] = c[1][0] = \&c[1][0][0]$ means

$c[1][1] = \&c[1][1][0]$ means

$c[1][2] = \&c[1][2][0]$ means

$\text{value}(c) = \text{value}(c[0]) = \text{value}(c[0][0]) = \text{value}(\&c[0][0][0])$ $\text{type}(c) \neq \text{type}(c[0]) \neq \text{type}(c[0][0]) = \text{type}(\&c[0][0][0])$ $\text{int } (*) [3][4] \quad \text{int } (*) [4] \quad \text{int } * \quad \text{int } *$	$\text{value}(c[0][1]) = \text{value}(\&c[0][1][0])$ $\text{type}(c[0][1]) = \text{type}(\&c[0][1][0])$ $\text{int } * \quad \text{int } *$
$\text{value}(c[0][2]) = \text{value}(\&c[0][2][0])$ $\text{type}(c[0][2]) = \text{type}(\&c[0][2][0])$ $\text{int } * \quad \text{int } *$	$\text{value}(c[1]) = \text{value}(c[1][0]) = \text{value}(\&c[1][0][0])$ $\text{type}(c[1]) \neq \text{type}(c[1][0]) = \text{type}(\&c[1][0][0])$ $\text{int } (*) [4] \quad \text{int } * \quad \text{int } *$
$\text{value}(c[1][1]) = \text{value}(\&c[1][1][0])$ $\text{type}(c[1][1]) = \text{type}(\&c[1][1][0])$ $\text{int } * \quad \text{int } *$	$\text{value}(c[1][2]) = \text{value}(\&c[1][2][0])$ $\text{type}(c[1][2]) = \text{type}(\&c[1][2][0])$ $\text{int } * \quad \text{int } *$

Summary of virtual array pointers in a 3-d array

$$c[i] \equiv *(c + i)$$

int (*) [3][4] 2-d array pointer c
int [2] [3][4] 3-d array name c

address value $c + i$

$\&c[0][0][0] + i * \text{sizeof}(*c)$
 $\&c[0][0][0] + i * \text{sizeof}(c[0])$
 $\&c[0][0][0] + i * 4 * 3 * 4$

leading elements

$c[0][0][0]$

$$c[i][j] \equiv *(c[i] + j)$$

int (*) [4] 1-d array pointers $c[i]$
Int [3] [4] 2-d array names $c[i]$

address value $c[i] + j$

$\&c[i][0][0] + j * \text{sizeof}(*c[i])$
 $\&c[i][0][0] + j * \text{sizeof}(c[i][0])$
 $\&c[i][0][0] + j * 4 * 4$

leading elements

$c[0][0][0]$

$c[1][0][0]$

$$c[i][j][k] \equiv *(c[i][j] + k)$$

int (*) 0-d array pointers $c[i][j]$
int [4] 1-d array names $c[i][j]$

address value $c[i][j] + k$

$\&c[i][j][0] + k * \text{sizeof}(*c[i][j])$
 $\&c[i][j][0] + k * \text{sizeof}(c[i][j][0])$
 $\&c[i][j][0] + k * 4$

leading elements

$c[0][0][0]$

$c[0][1][0]$

$c[0][2][0]$

$c[1][0][0]$

$c[1][1][0]$

$c[1][2][0]$

Sub-array properties in multi-dimensional arrays

`int c [2][3][4];` → 3-d access `c [i][j][k]`

2-d array pointer	<code>c</code>	<code>int (*) [3][4]</code>
1-d array pointers	<code>c[i]</code>	<code>int (*) [4]</code>
0-d array pointers	<code>c[i][j]</code>	<code>int (*)</code>

Hierarchical sub-arrays in a 3-d array

```
int c [L][M][N];
```

```
c [i][j][k]
```

left-to-right associativity

Array Names and Types

Pointers to hierarchical sub-arrays

c	[i]	[j][k]
c[i]	[j]	[k]
c[i][j]	[k]	

c	3-d array names	int (*) [M][N]	2-d array pointer
c[i]	2-d array names	int (*) [N]	1-d array pointer
c[i][j]	1-d array names	int (*)	0-d array pointer

Associativity and Equivalence Relations

left-to-right associativity

$$((c[i])[j])[k]$$
$$\equiv$$

left-to-right associativity

$$*(*(*(c+i)+j)+k)$$
$$X[n]$$
$$\equiv$$
$$*(X+n)$$

given $c[i][j]$

$$c[i][j][k]$$
$$\equiv$$
$$*(c[i][j]+k)$$

for all k

given $c[i]$

$$c[i][j]$$
$$\equiv$$
$$*(c[i]+j)$$

for all j

given c

$$c[i]$$
$$\equiv$$
$$*(c+i)$$

for all i

Requirements for the expression $c[i][j][k]$

for a given $c[i][j]$, for all k

$$c[i][j][k] = *(c[i][j] + k)$$

for a given $c[i]$, for all j

$$c[i][j] = *(c[i] + j)$$

for a given c , for all i

$$c[i] = *(c + i)$$

3 contiguity requirements

for a given $c[i][j]$, contiguous $c[i][j][k]$'s

for a given $c[i]$, contiguous $c[i][j]$'s

for a given c , contiguous $c[i]$'s

for a given
subarray pointer

contiguous
subarrays

Equivalent requirements for the expression $c[i][j][k]$

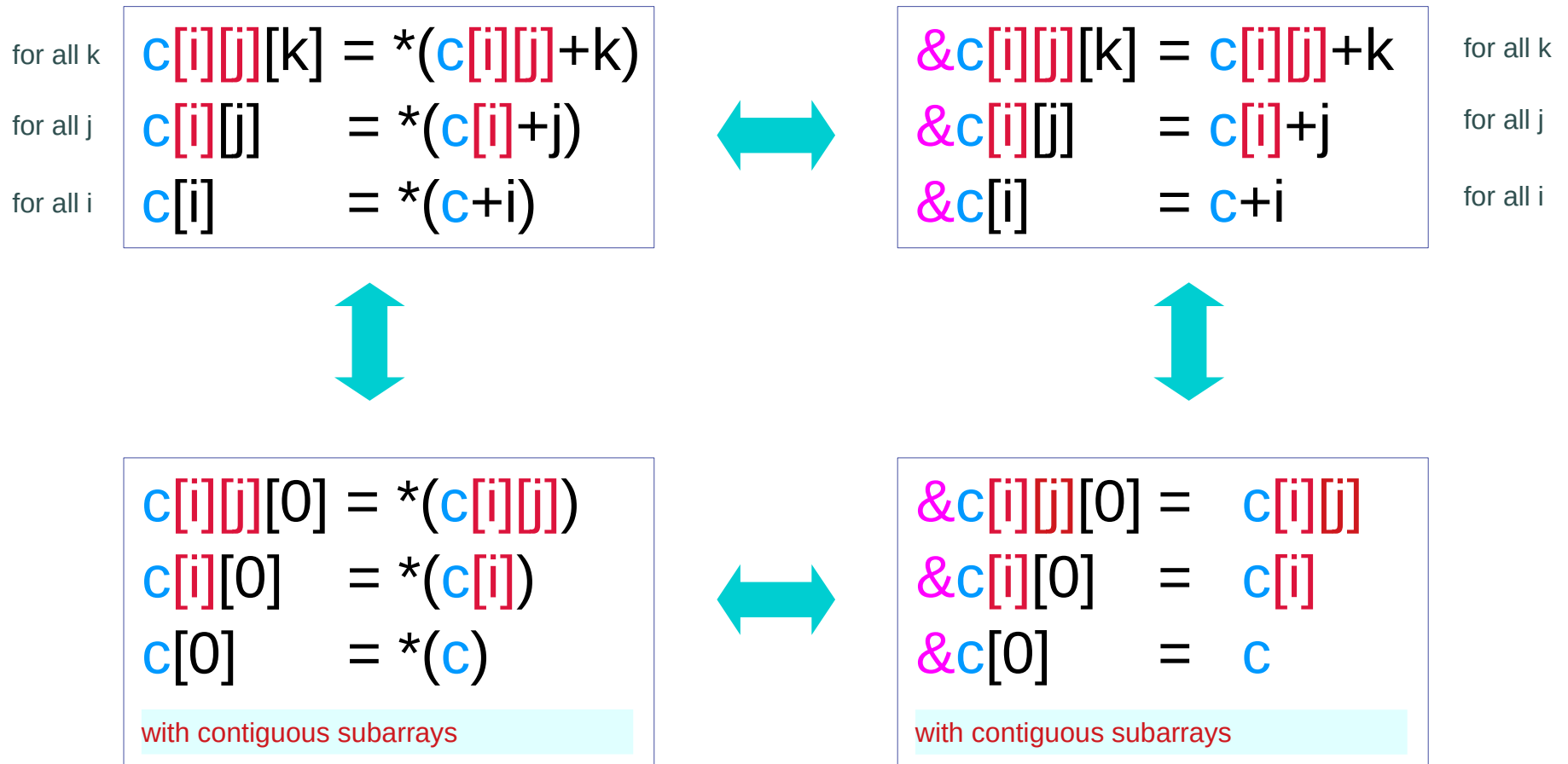

3-d access pattern $c[i][j][k]$

General requirements

```
c [i][j][k]
```



```
&c[i][j][k] = c[i][j]+k for all k  
&c[i][j]   = c[i]+j   for all j  
&c[i]     = c+i     for all i
```

Pointer array approach

```
int** c[2];  
int*  b[2*3];  
int   c[2*3*4];
```

```
c[i][j][k] :: int  
c[i][j]    :: int *  
c[i]       :: int **  
c          :: int ***
```

```
c[i] ← &b[i*3]  
b[j] ← &a[j*4]
```

with contiguous a, b, c

Explicit
Arrays of pointers with
Multiple Indirection

N-dim Array approach

```
int c[2][3][4];
```

```
c[i][j][k] :: int  
c[i][j]    :: int [4]  
c[i]       :: int [3][4]  
c          :: int [2][3][4]
```

```
c[i][j] ← &c[i][j][0]  
c[i]    ← &c[i][0][0]  
c       ← &c[0][0][0]
```

with contiguous c

Implicit
Nested
Virtual Array Pointers

3-d access pattern $c[i][j][k]$ – array pointer approach

General requirements

$c[i][j][k]$



$\&c[i][j][k] = c[i][j] + k$ for all k
 $\&c[i][j] = c[i] + j$ for all j
 $\&c[i] = c + i$ for all i



N-dim array approach

```
int c[2][3][4];
```

```
c[i][j][k] :: int  
c[i][j]    :: int [4]  
c[i]       :: int [3][4]  
c          :: int [2][3][4]
```

```
c[i][j] ← &c[i][j][0]  
c[i]    ← &c[i][0][0]  
c       ← &c[0][0][0]
```

with contiguous c

**Implicit
Nested
Virtual Array Pointers**

Virtual pointers to subarrays in a 3-d array

virtual 2-d array pointer

sizeof(**c**) =
sizeof(**c[0]**) * 2

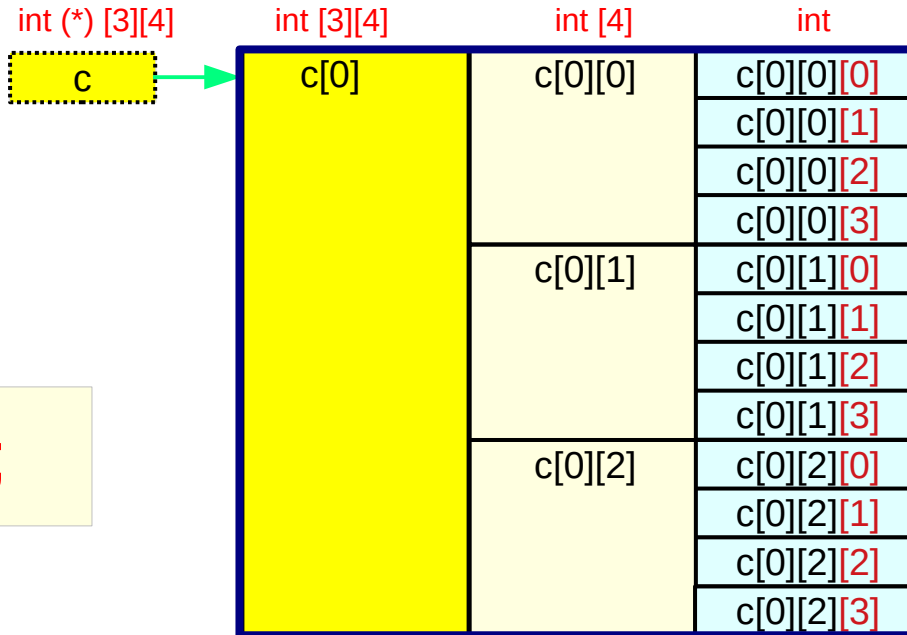

the first 2-d subarray

sizeof(**c[0]**) =
sizeof(int [3][4])

```
int c [2][3][4];
```

virtual 1-d array pointer

sizeof(**c[0]**) =
sizeof(**c[0][0]**) * 3

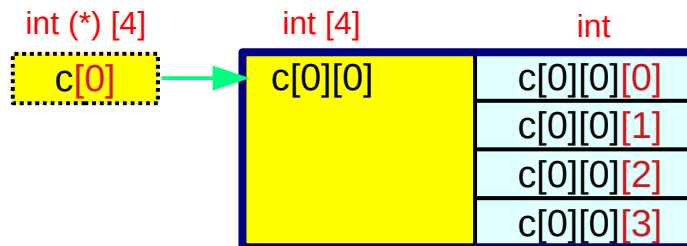

the first 1-d subarray

sizeof(**c[0][0]**) =
sizeof(int [4])

virtual 0-d array pointer

sizeof(**c[0][0]**) =
sizeof(**c[0][0][0]**) * 4

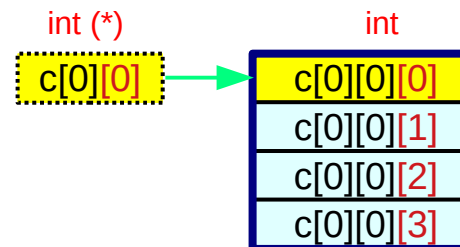

the first 0-d subarray

sizeof(**c[0][0][0]**) =
sizeof(int)

Virtual pointer values in a 3-d array

```
int c [2][3][4];
```



```
c [i][j][k];
```

virtual assignments

```
c ← &c[0][0][0]
c[i] ← &c[i][0][0]
c[i][j] ← &c[i][j][0]
```

row major ordering
contiguous linear layout

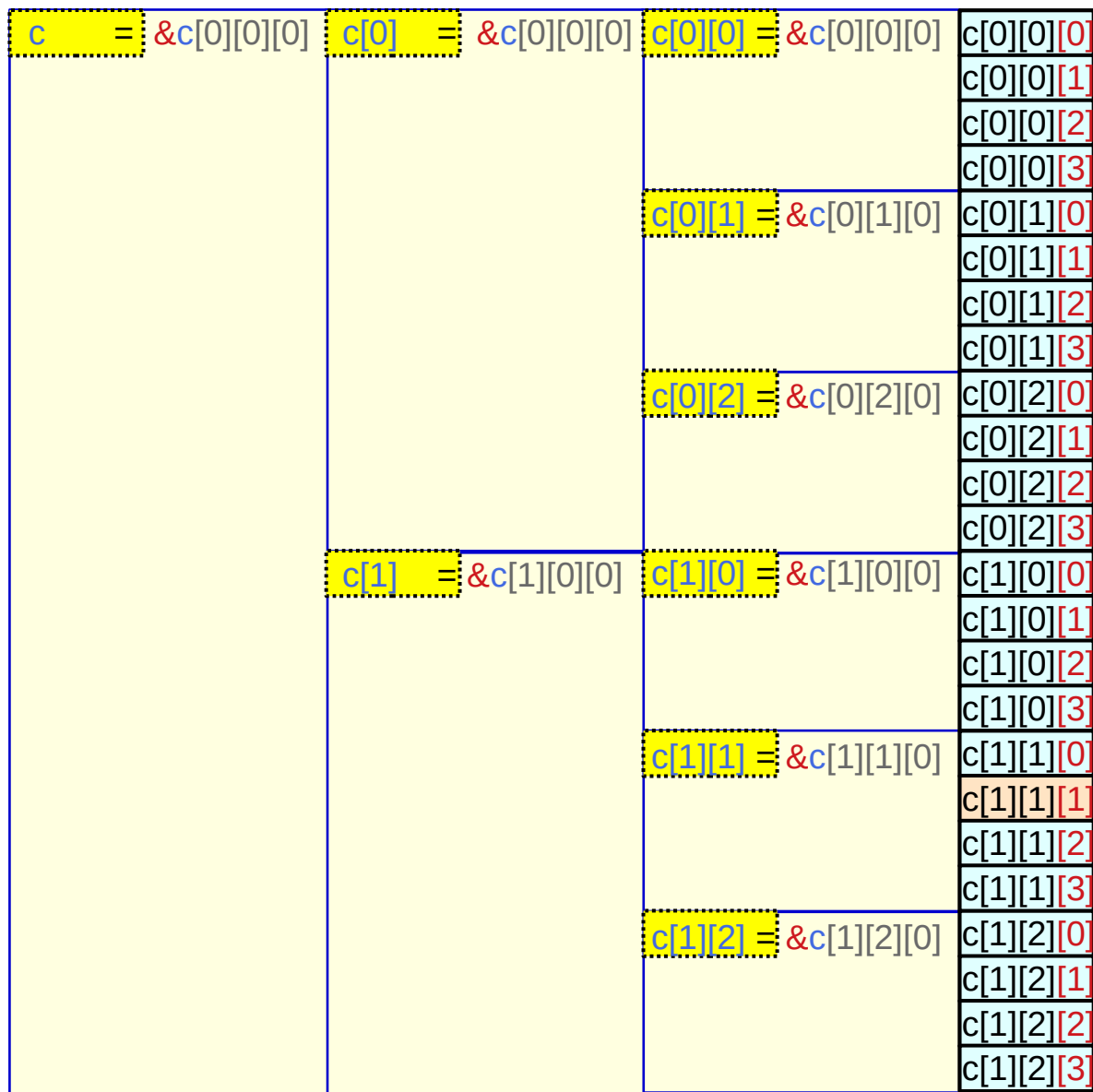

Virtual assignments

```
int c [2][3][4];
```



```
c [i][j][k];
```

virtual assignments

```
c ← &c[0][0][0]  
c[i] ← &c[i][0][0]  
c[i][j] ← &c[i][j][0]
```

row major ordering
contiguous linear layout

```
c ← (int (*)[3][4]) &c[0][0][0]  
c[i] ← (int (*)[4]) &c[i][0][0]  
c[i][j] ← (int *) &c[i][j][0]
```

type casts address values

if c, c[i], c[i][j] were real pointer variables,
type casts would be needed

Dual types of `c`, `c[i]`, `c[i][j]`

```
int c [2][3][4];
```

```
&c[i][j][0] = c[i][j]
&c[i][0]    = c[i]
&c[0]      = c
```

with contiguous subarrays

```
&c[i][j][k] = c[i][j]+k for all k
&c[i][j]    = c[i]+j   for all j
&c[i]       = c+i     for all i
```

```
c [i][j][k]
```

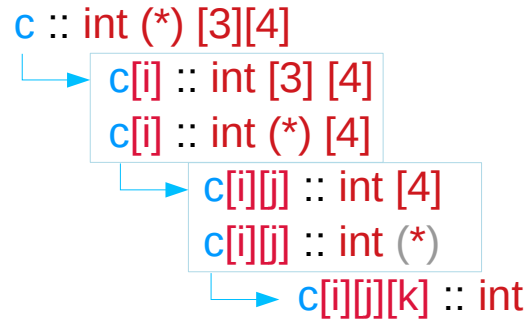

- 2-d array pointers
- 2-d arrays
- 1-d array pointers
- 1-d arrays
- 0-d array pointers
- 0-d arrays (integers)

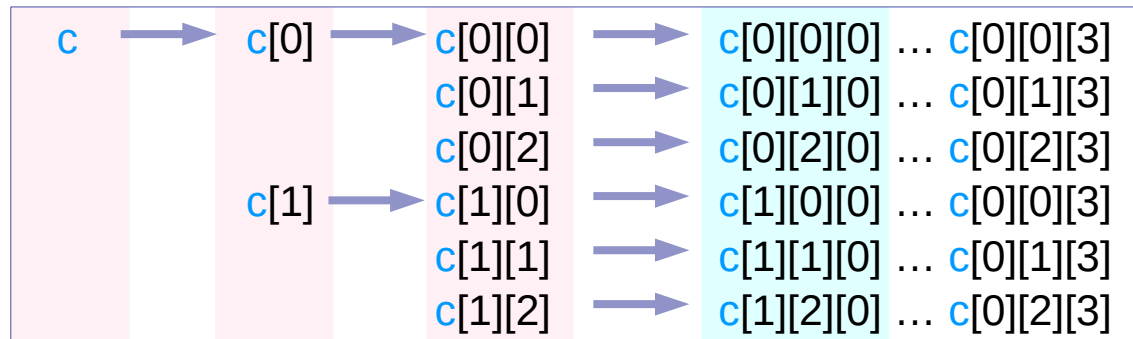

```

int [2] [3][4]  int [3] [4]      int [4]
int (*) [3][4] int (*) [4]      int (*)

```

```

pointers to    pointers to    1-d array
a 2-d array    a 1-d array    names
leading element
of 4-integer array

```

Values of c , $c[i]$, $c[i][j]$

```
int c [2][3][4];
```

```
&c[i][j][0] = c[i][j]  
&c[i][0] = c[i]  
&c[0] = c
```

with contiguous subarrays

```
&c[i][j][k] = c[i][j]+k for all k  
&c[i][j] = c[i]+j for all j  
&c[i] = c+i for all i
```

```
c [i][j][k]
```

virtual array pointers have address values in each row in the following figure have the same address value

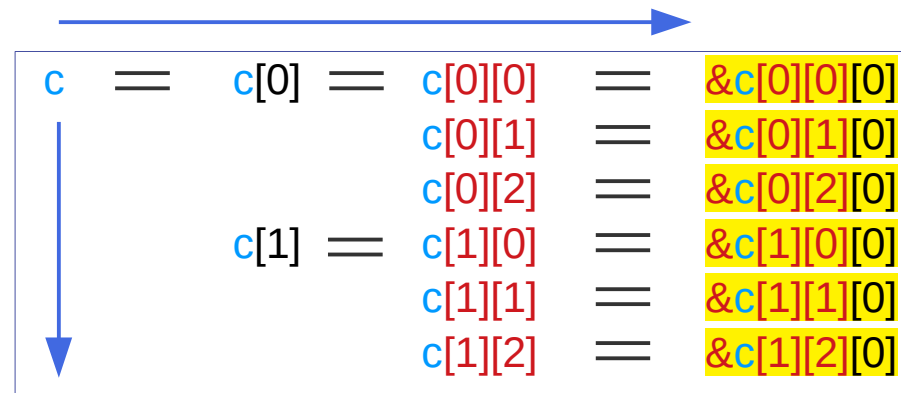

Horizontal displacements are not counted only **vertical displacements** are considered for address values

virtual assignments

```
c[i][j] = &c[i][j][0]  
c[i] = &c[i][0][0]  
c = &c[0][0][0]
```

Finding address values of c , $c[i]$, $c[i][j]$

```
int c [2][3][4];
```

```
&c[i][j][0] = c[i][j]
&c[i][0]    = c[i]
&c[0]       = c
```

with contiguous subarrays

```
&c[i][j][k] = c[i][j]+k for all k
&c[i][j]    = c[i]+j   for all j
&c[i]       = c+i      for all i
```

```
c [i][j][k]
```

virtual assignments

```
c[i][j] = &c[i][j][0]
c[i]    = &c[i][0][0]
c       = &c[0][0][0]
```

append $[0]$ to the right

c	$\xrightarrow{+[0]}$	$c[0]$	$\xrightarrow{+[0]}$	$c[0][0]$	$\xrightarrow{+[0]}$	$\&c[0][0][0]$
				$c[0][1]$	$\xrightarrow{+[0]}$	$\&c[0][1][0]$
				$c[0][2]$	$\xrightarrow{+[0]}$	$\&c[0][2][0]$
		$c[1]$	$\xrightarrow{+[0]}$	$c[1][0]$	$\xrightarrow{+[0]}$	$\&c[1][0][0]$
				$c[1][1]$	$\xrightarrow{+[0]}$	$\&c[1][1][0]$
				$c[1][2]$	$\xrightarrow{+[0]}$	$\&c[1][2][0]$

int (*) [3][4]

int (*) [4]

int [4]

int

$c[0][0][0]$:
leading
elements
of c

$c[i][0][0]$:
leading
elements
of $c[i]$

$c[i][j][0]$:
leading
elements
of $c[i][j]$

$\&c[0][0][0]$

$\&c[0][0][0]$

$\&c[1][0][0]$

$\&c[0][0][0]$
 $\&c[0][1][0]$
 $\&c[0][2][0]$
 $\&c[1][0][0]$
 $\&c[1][1][0]$
 $\&c[1][2][0]$

Finding sub-array names with the address $\&c[i][j][0]$

```
int c [2][3][4];
```

```
&c[i][j][0] = c[i][j]
&c[i][0]    = c[i]
&c[0]       = c
```

with contiguous subarrays

```
&c[i][j][k] = c[i][j]+k for all k
&c[i][j]    = c[i]+j   for all j
&c[i]       = c+i      for all i
```

```
c [i][j][k]
```

virtual assignments

```
c[i][j] = &c[i][j][0]
c[i]    = &c[i][0][0]
c       = &c[0][0][0]
```

delete [0] from the right

$\&c[0][0][0]$	$\underline{\underline{-[0]}}$	$c[0][0]$	$\underline{\underline{-[0]}}$	$c[0]$	$\underline{\underline{-[0]}}$	c
$\&c[0][1][0]$	$\underline{\underline{-[0]}}$	$c[0][1]$				
$\&c[0][2][0]$	$\underline{\underline{-[0]}}$	$c[0][2]$				
$\&c[1][0][0]$	$\underline{\underline{-[0]}}$	$c[1][0]$	$\underline{\underline{-[0]}}$	$c[1]$		
$\&c[1][1][0]$	$\underline{\underline{-[0]}}$	$c[1][1]$				
$\&c[1][2][0]$	$\underline{\underline{-[0]}}$	$c[1][2]$				

int int [4] int (*) [4] int (*) [3][4]

$c[0][0][0]$ is the leading element of $c[0][0]$, $c[0]$, c
 $c[0][1][0]$ is the leading element of $c[0][1]$
 $c[0][2][0]$ is the leading element of $c[0][2]$
 $c[1][0][0]$ is the leading element of $c[1][0]$, $c[1]$
 $c[1][1][0]$ is the leading element of $c[1][1]$
 $c[1][2][0]$ is the leading element of $c[1][2]$

multi-dimensional arrays

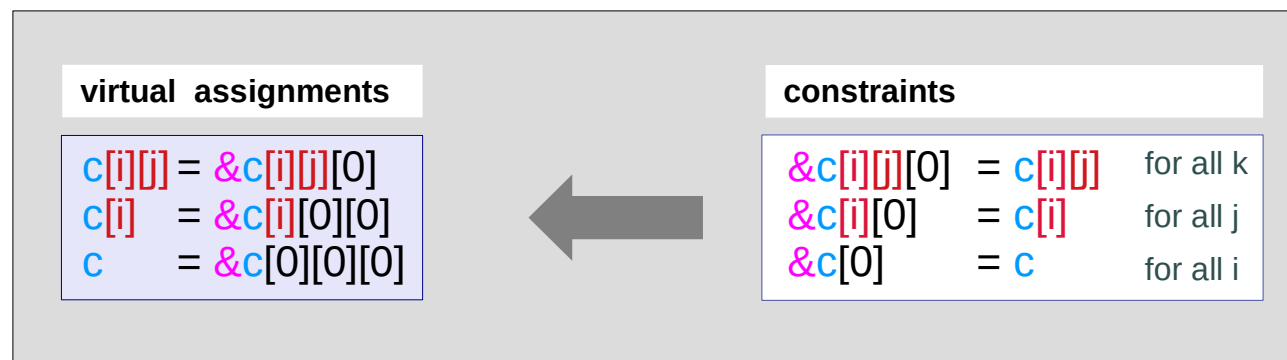
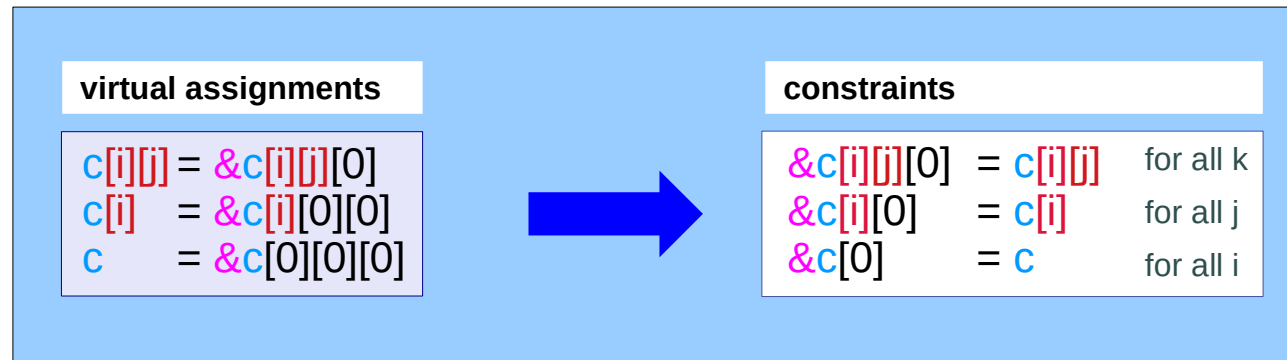

General requirements for `c[i][j][k]`

```
int c [2][3][4];
```

```
&c[i][j][0] = c[i][j]
&c[i][0]    = c[i]
&c[0]      = c
```

with contiguous subarrays

```
&c[i][j][k] = c[i][j]+k for all k
&c[i][j]    = c[i]+j   for all j
&c[i]       = c+i      for all i
```



virtual assignments

```
c[i][j] = &c[i][j][0]
c[i]    = &c[i][0][0]
c       = &c[0][0][0]
```

Virtual assignments

```
int (*)      c[i][j] = (int (*)) &c[i][j][0]
int (*) [4]  c[i]    = (int (*) [4]) &c[i][0][0]
int (*) [3][4] c      = (int (*) [3][4]) &c[0][0][0]
```

Pointer
Types

Sizes of abstract data types

```
int [4]      c[i][j] size = 4*4
int [3][4]   c[i]    size = 3*4*4
int [2][3][4] c      size = 2*3*4*4
```

Abstract Data
Types

Strides of array elements

```
c[i][j][0]  stride = 4*4
c[i][0][0]  stride = 3*4*4
c[0][0][0]  stride = 2*3*4*4
```

```

k=[0:3]      c[i][j][k] 4 integers
j=[0:2], k=[0:3] c[i][j][k] 3*4 integers
i=[0:1], j=[0:2], k=[0:3] c[i][j][k] 2*3*4 integers
    
```

General requirements for `c[i][j][k]`

```
int c [2][3][4];
```

```
&c[i][j][0] = c[i][j]
&c[i][0]    = c[i]
&c[0]      = c
```

with contiguous subarrays

```
&c[i][j][k] = c[i][j]+k for all k
&c[i][j]    = c[i]+j   for all j
&c[i]       = c+i     for all i
```



virtual assignments

```
c[i][j] = &c[i][j][0]
c[i]    = &c[i][0][0]
c       = &c[0][0][0]
```

Each
Each
Each

```
c[i][j]
c[i]
c
```

sub-array contains
sub-array contains
sub-array contains

4 integers
3*4 integers
2*3*4 integers

Abstract Data
Types

Each
Each
Each

```
c[i][j]+1
c[i]+1
c+1
```

points to `c[i][j][1]`
points to `c[i][1][0]`
points to `c[1][0][0]`

1 integer away
4 integers away
3*4 integers away

Pointer
Types

Each
Each
Each

```
c[i][j]+k
c[i]+j
c+i
```

points to `c[i][j][k]`
points to `c[i][j][0]`
points to `c[i][0][0]`

1*k integers away
4*j integers away
3*4*i integers away

Pointer
Types

multi-dimensional arrays

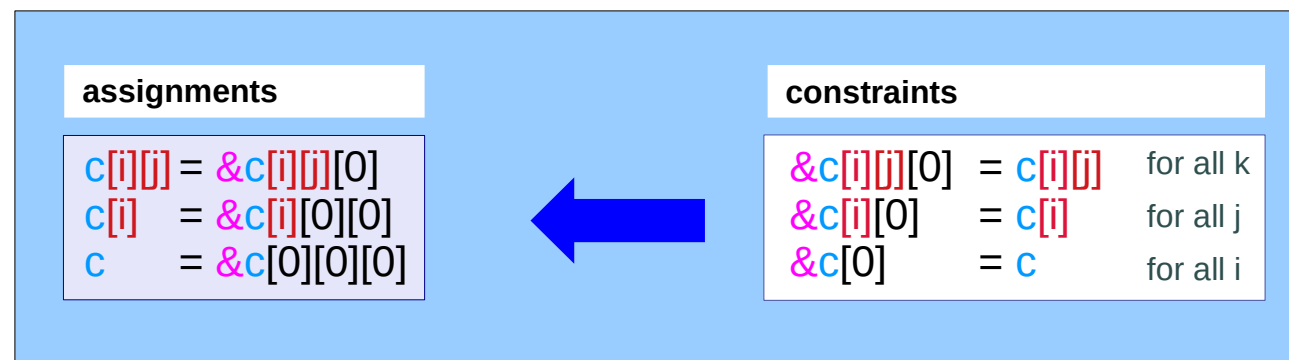
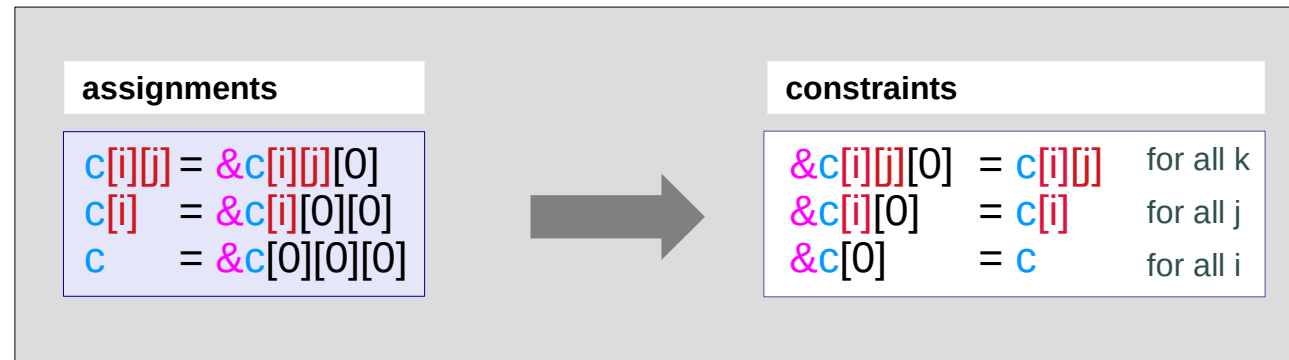

Contiguous subarrays

```
int c [2][3][4];
```

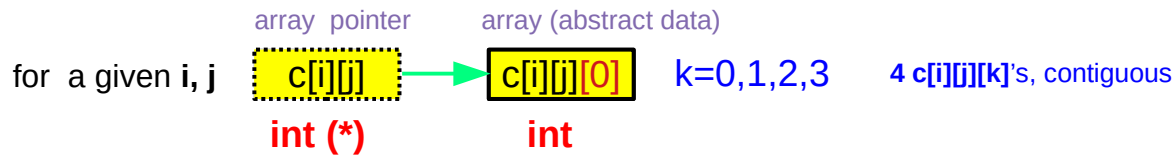
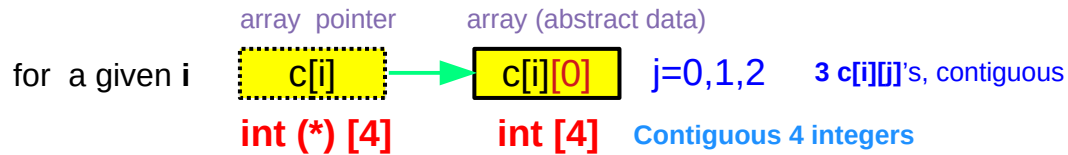
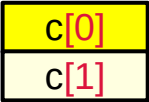
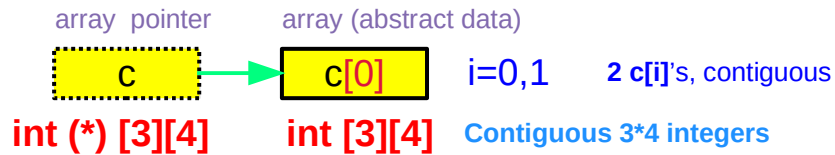

General requirements for `c[i][j][k]`

<code>&c[i][j][0]</code>	<code>=</code>	<code>c[i][j]</code>
<code>&c[i][0]</code>	<code>=</code>	<code>c[i]</code>
<code>&c[0]</code>	<code>=</code>	<code>c</code>

array pointer

<code>c[i][j]</code>	points to	<code>c[i][j][0]</code>
<code>c[i]</code>	points to	<code>c[i][0]</code>
<code>c</code>	points to	<code>c[0]</code>

array (abstract data)

address value

array (abstract data)

<code>c[i][j]</code>	starts at	<code>c[i][j][0]</code>
<code>c[i]</code>	starts at	<code>c[i][0]</code>
<code>c</code>	starts at	<code>c[0]</code>

array pointer

address value

Virtual array pointers in a multi-dimensional array

Abstract data (array) p[i]

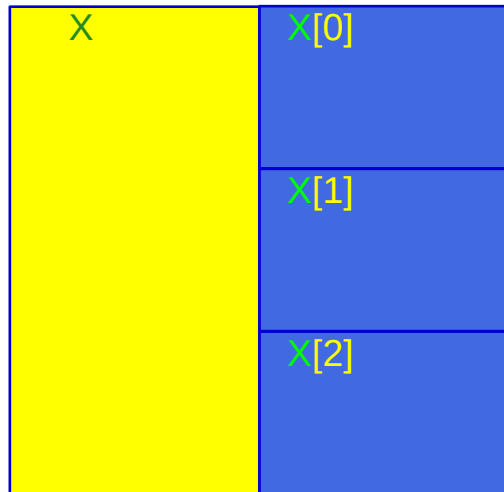

Virtual array pointer p[i]

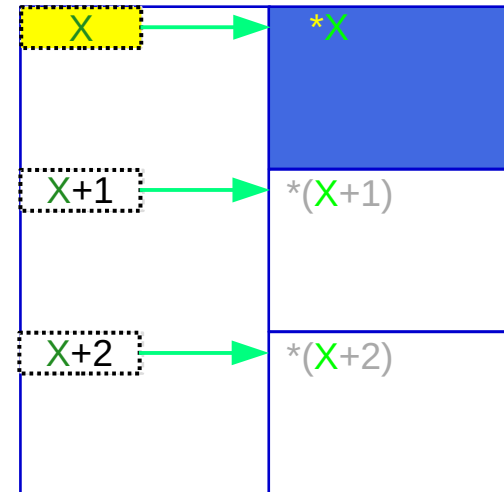

array (abstract data)

$c[i][j]$ starts at
 $c[i]$ starts at
 c starts at

array pointer

$c[i][j][0]$
 $c[i][0]$
 $c[0]$

address value

$\&c[i][j]$ = $c[i][j][0]$
 $\&c[i]$ = $c[i][0]$
 $\&c$ = $c[0]$

array pointer

$c[i][j]$ points to
 $c[i]$ points to
 c points to

array (abstract data)

$c[i][j][0]$
 $c[i][0]$
 $c[0]$

address value

$c[i][j]$ = $\&c[i][j][0]$
 $c[i]$ = $\&c[i][0]$
 c = $\&c[0]$

Pointer reference relationship

```
int c [2][3][4];
```

```
&c[i][j][0] = c[i][j]
&c[i][0]    = c[i]
&c[0]      = c
```

with contiguous subarrays

```
&c[i][j][k] = c[i][j]+k for all k
&c[i][j]    = c[i]+j   for all j
&c[i]       = c+i      for all i
```



virtual assignments

```
c[i][j] = &c[i][j][0]
c[i]    = &c[i][0][0]
c       = &c[0][0][0]
```

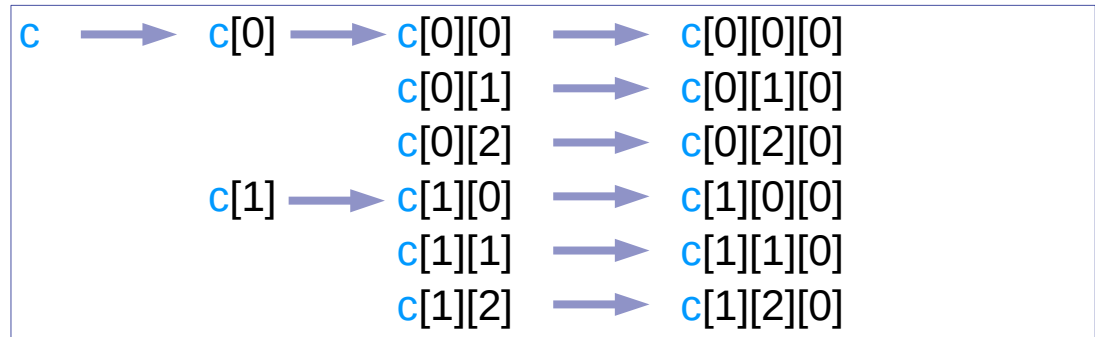

$c[i][j]$	=	$\&c[i][j][0]$
$c[0][0]$	\equiv	$\&c[0][0][0]$
$c[0][1]$	\equiv	$\&c[0][1][0]$
$c[0][2]$	\equiv	$\&c[0][2][0]$
$c[1][0]$	\equiv	$\&c[1][0][0]$
$c[1][1]$	\equiv	$\&c[1][1][0]$
$c[1][2]$	\equiv	$\&c[1][2][0]$

$c[i]$	=	$\&c[i][0]$
$c[0]$	\equiv	$\&c[0][0]$
$c[1]$	\equiv	$\&c[1][0]$

c	$=$	$\&c[0]$
c	\equiv	$\&c[0]$
	\equiv	$\&c[0][0]$
	\equiv	$\&c[0][0][0]$

General requirements for `c[i][j][k]`

```
int c [2][3][4];
```

```
&c[i][j][0] = c[i][j]
&c[i][0]    = c[i]
&c[0]      = c
```

with contiguous subarrays

```
&c[i][j][k] = c[i][j]+k for all k
&c[i][j]    = c[i]+j   for all j
&c[i]       = c+i     for all i
```



virtual assignments

```
c[i][j] = &c[i][j][0]
c[i]    = &c[i][0][0]
c       = &c[0][0][0]
```

`c[i][j]` virtual array pointer of the type `int (*)`
`c[i][j][0]` : leading element of a 4-integer array `int`

```
*(c[0][0]+0) = c[0][0][0]
*(c[0][1]+0) = c[0][1][0]
*(c[0][2]+0) = c[0][2][0]
*(c[1][0]+0) = c[1][0][0]
*(c[1][1]+0) = c[1][1][0]
*(c[1][2]+0) = c[1][2][0]
```

`c[0][0]` is the address of `c[0][0][0]`
`c[0][1]` is the address of `c[0][1][0]`
`c[0][2]` is the address of `c[0][2][0]`
`c[1][0]` is the address of `c[1][0][0]`
`c[1][1]` is the address of `c[1][1][0]`
`c[1][2]` is the address of `c[1][2][0]`

`c[i]` virtual array pointer of the type `int (*) [4]`
`c[i][j]` : a 4-element 1-d array name `int [4]`

```
*(c[0]+0) = c[0][0]
*(c[1]+0) = c[1][0]
```

`c[0]` is the address of `c[0][0]`
`c[1]` is the address of `c[1][0]`

c[0] = c[0][0] relation

```
int c [2][3][4];
```

```
&c[i][j][0] = c[i][j]
&c[i][0]    = c[i]
&c[0]      = c
```

with contiguous subarrays

```
&c[i][j][k] = c[i][j]+k for all k
&c[i][j]    = c[i]+j    for all j
&c[i]       = c+i      for all i
```



virtual assignments

```
c[i][j] = &c[i][j][0]
c[i]    = &c[i][0][0]
c       = &c[0][0][0]
```

```
c == c[0] == c[0][0] == &c[0][0][0]
```

```
value(c[0]) = &c[0][0][0]
```

```
value(c[0][0]) = &c[0][0][0]
```

```
type(c[0]) = int (*)[4]
```

```
type(c[0][0]) = int [4]
```

```
c[0] = c[0][0] means
value(c[0]) = value(c[0][0])
```

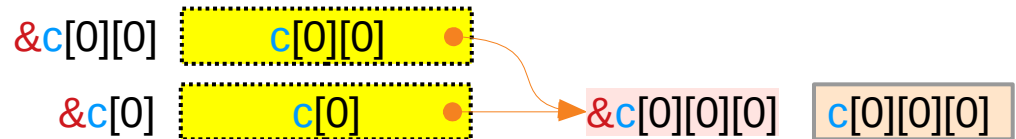

```
c[i][j] = &c[i][j][0]
c[i]    = &c[i][0][0]
c       = &c[0][0][0]
```

Addresses and Values of `c[0]` and `c[0][0]`

```
int c [2][3][4];
```

```
&c[i][j][0] = c[i][j]
&c[i][0]    = c[i]
&c[0]      = c
```

with contiguous subarrays

```
&c[i][j][k] = c[i][j] + k for all k
&c[i][j]    = c[i] + j   for all j
&c[i]       = c + i      for all i
```



virtual assignments

```
c[i][j] = &c[i][j][0]
c[i]    = &c[i][0][0]
c       = &c[0][0][0]
```

`c` → `c[0]` → `c[0][0]` = `&c[0][0][0]`

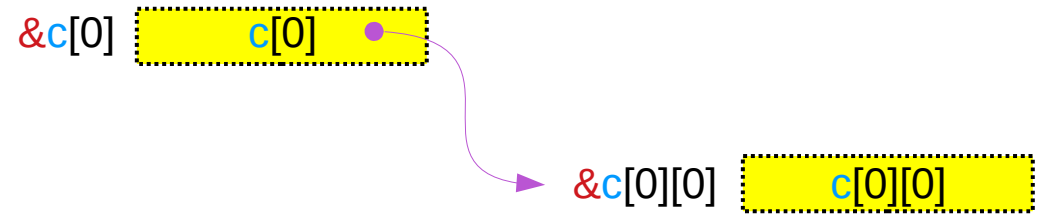

`c` = `c[0]` = `c[0][0]` = `&c[0][0][0]`

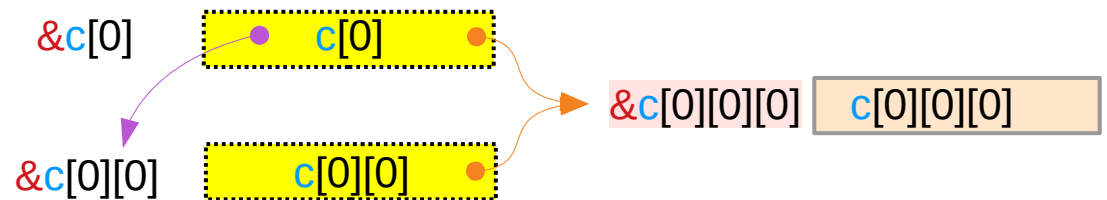

A virtual pointer's address and value are the same

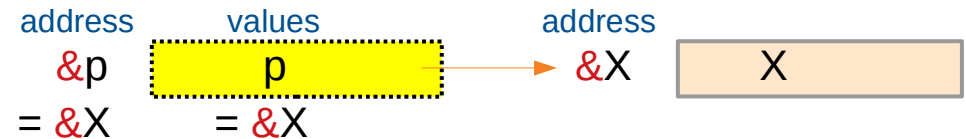

c[0] and c[0][0] point to the same c[i][0][0]

```
int c [2][3][4];
```

```
&c[i][j][0] = c[i][j]
&c[i][0]    = c[i]
&c[0]      = c
```

with contiguous subarrays

```
&c[i][j][k] = c[i][j]+k for all k
&c[i][j]    = c[i]+j   for all j
&c[i]       = c+i      for all i
```



virtual assignments

```
c[i][j] = &c[i][j][0]
c[i]    = &c[i][0][0]
c       = &c[0][0][0]
```

```
c = c[0] = c[0][0] = &c[0][0][0]
int(*)[3][4] int(*)[4] int(*) int
```

```
c[1] = c[1][0] = &c[1][0][0]
int(*)[4] int(*) int
```

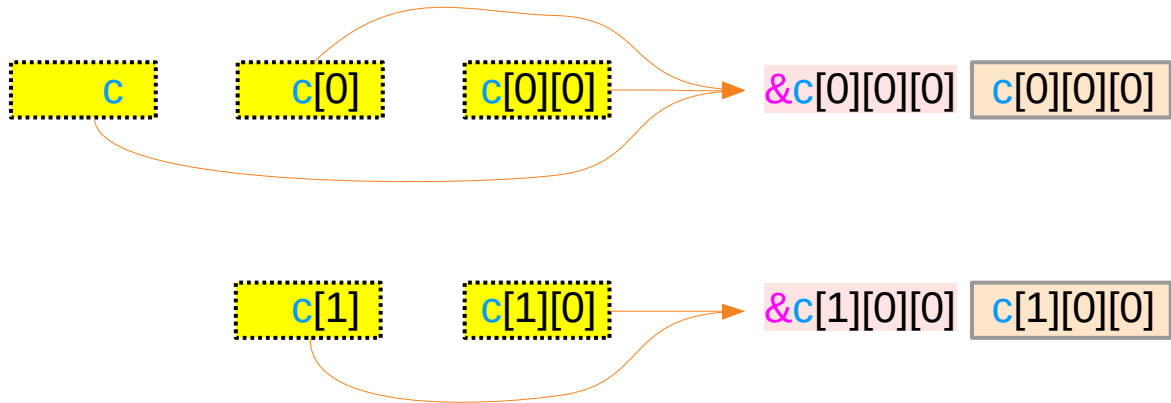

These virtual pointers have different types but the same value (address)

&c[i][0] and &c[i][0][0] – equivalence relations

```
int c [2][3][4];
```

```
&c[i][j][0] = c[i][j]
&c[i][0]    = c[i]
&c[0]       = c
```

with contiguous subarrays

```
&c[i][j][k] = c[i][j]+k for all k
&c[i][j]    = c[i]+j   for all j
&c[i]       = c+i      for all i
```



virtual assignments

```
c[i][j] = &c[i][j][0]
c[i]    = &c[i][0][0]
c       = &c[0][0][0]
```

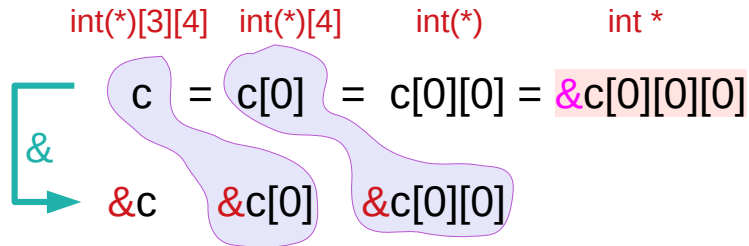

equivalences

```
c ≡ &c[0],
c[0] ≡ &c[0][0]
c[0][0] ≡ &c[0][0][0]
```

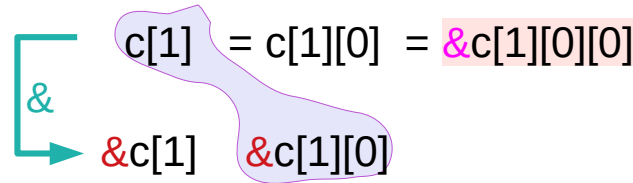

equivalences

```
c[1] ≡ &c[1][0]
c[1][0] ≡ &c[1][0][0]
```

Horizontal displacements are not counted
only vertical displacements are considered
for address values

equivalences

```
c ≡ &c[0],
c[i] ≡ &c[i][0]
c[i][0] ≡ &c[i][0][0]
```

$c[i] = \&c[i]$ and $c[i][0] = \&c[i][0]$

```
int c [2][3][4];
```

```
&c[i][j][0] = c[i][j]  
&c[i][0] = c[i]  
&c[0] = c
```

with contiguous subarrays

```
&c[i][j][k] = c[i][j]+k for all k  
&c[i][j] = c[i]+j for all j  
&c[i] = c+i for all i
```



virtual assignments

```
c[i][j] = &c[i][j][0]  
c[i] = &c[i][0][0]  
c = &c[0][0][0]
```

```
c = c[0] = c[0][0] = &c[0][0][0]  
|| || ||  
&c = &c[0] = &c[0][0]
```

```
c[1] = c[1][0] = &c[1][0][0]  
|| ||  
&c[1] = &c[1][0]
```

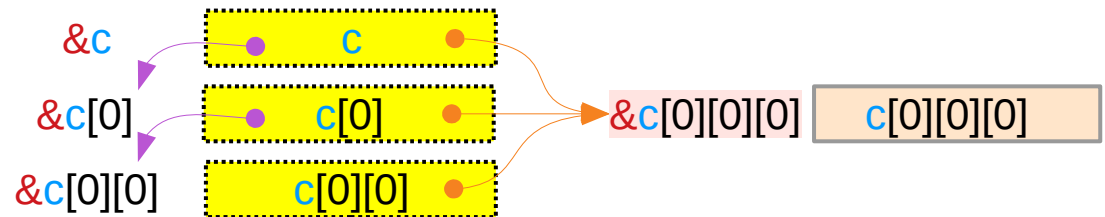

$c[i] = \&c[i]$ and $c[i][0] = \&c[i][0]$

```
int c [2][3][4];
```

```
&c[i][j][0] = c[i][j]  
&c[i][0] = c[i]  
&c[0] = c
```

with contiguous subarrays

```
&c[i][j][k] = c[i][j]+k for all k  
&c[i][j] = c[i]+j for all j  
&c[i] = c+i for all i
```



virtual assignments

```
c[i][j] = &c[i][j][0]  
c[i] = &c[i][0][0]  
c = &c[0][0][0]
```

A virtual pointer's address and value are the same

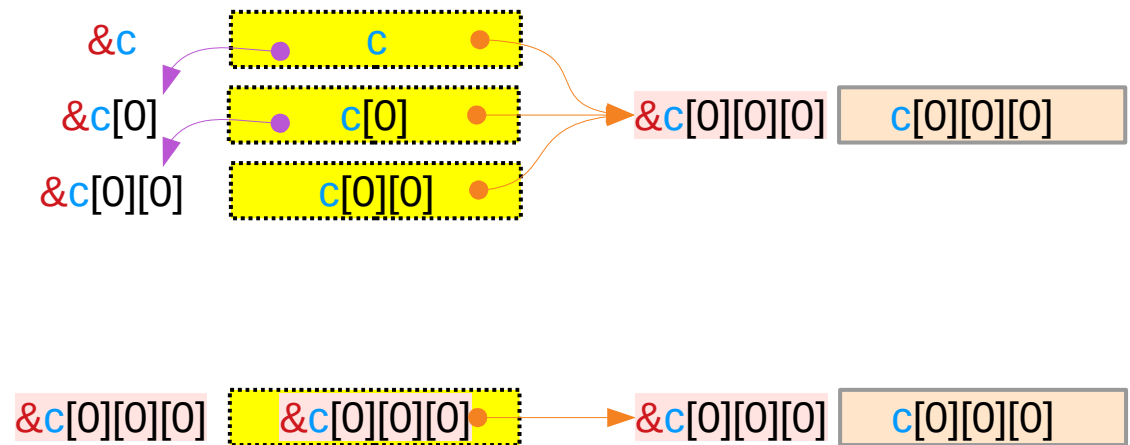
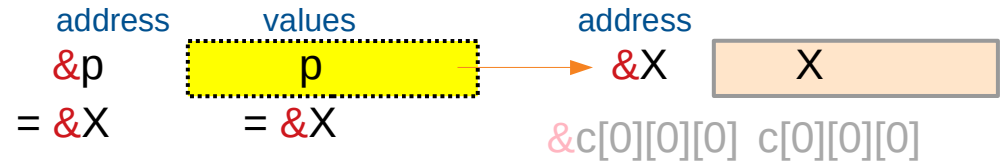

c[i]

Array Pointers to $c[i][0][0]$

$$\begin{aligned} &\&c[i][j][0] &= c[i][j] \\ &\&c[i][0] &= c[i] \\ &\&c[0] &= c \end{aligned}$$

with contiguous subarrays

$$\begin{aligned} &\&c[i][j][k] &= c[i][j] + k && \text{for all } k \\ &\&c[i][j] &= c[i] + j && \text{for all } j \\ &\&c[i] &= c + i && \text{for all } i \end{aligned}$$



assignments

$$\begin{aligned} c[i][j] &= \&c[i][j][0] \\ c[i] &= \&c[i][0][0] \\ c &= \&c[0][0][0] \end{aligned}$$

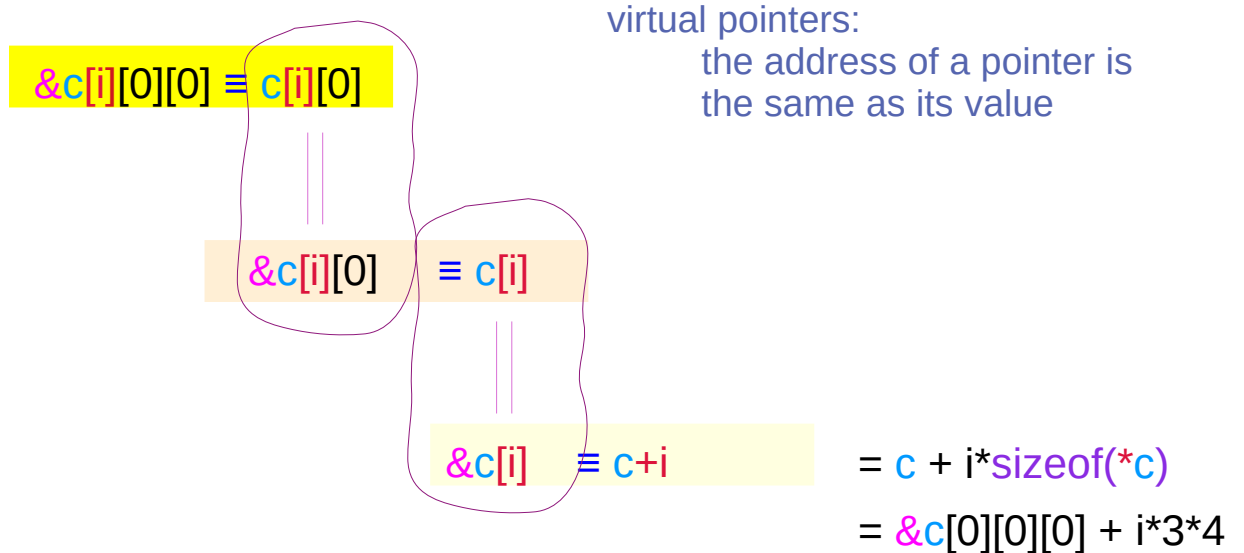

delete [0] from the right

$$\begin{array}{l} \&c[0][0][0] \quad \underline{\underline{-[0]}} \quad c[0][0] \quad \underline{\underline{-[0]}} \quad c[0] \quad \underline{\underline{-[0]}} \quad c \\ \&c[1][0][0] \quad \underline{\underline{-[0]}} \quad c[1][0] \quad \underline{\underline{-[0]}} \quad c[1] \end{array}$$

Array Pointers to $c[i][j][0]$

```
&c[i][j][0] = c[i][j]
&c[i][0]   = c[i]
&c[0]      = c
```

with contiguous subarrays

```
&c[i][j][k] = c[i][j]+k for all k
&c[i][j]   = c[i]+j   for all j
&c[i]      = c+i      for all i
```



assignments

```
c[i][j] = &c[i][j][0]
c[i]    = &c[i][0][0]
c       = &c[0][0][0]
```

$\&c[i][j][0] \equiv c[i][j]$

$\&c[i][j] \equiv c[i] + j$

$= c[i] + j * \text{sizeof}(*c[i])$
 $= c + i * \text{sizeof}(*c) + j * 4$
 $= \&c[0][0][0] + i * 3 * 4 + j * 4$

delete [0] from the right

$\&c[0][0][0]$	$\underline{\underline{-[0]}}$	$c[0][0]$	$\underline{\underline{-[0]}}$	$c[0]$	$\underline{\underline{-[0]}}$	c
$\&c[0][1][0]$	$\underline{\underline{-[0]}}$	$c[0][1]$				
$\&c[0][2][0]$	$\underline{\underline{-[0]}}$	$c[0][2]$				
$\&c[1][0][0]$	$\underline{\underline{-[0]}}$	$c[1][0]$	$\underline{\underline{-[0]}}$	$c[1]$		
$\&c[1][1][0]$	$\underline{\underline{-[0]}}$	$c[1][1]$				
$\&c[1][2][0]$	$\underline{\underline{-[0]}}$	$c[1][2]$				

Contiguity Constraints

c [i][j][k];

Virtual Array Pointers and Contiguity

Using array pointers

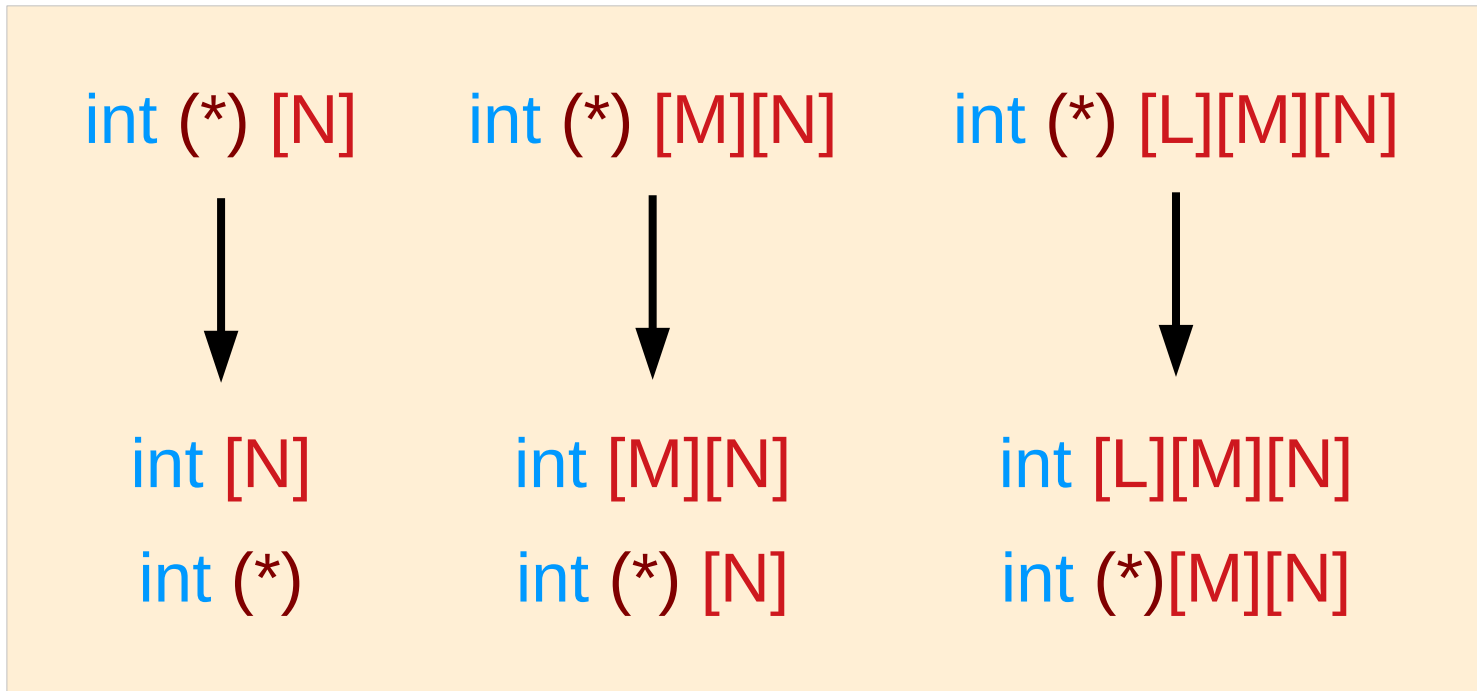

Array Pointer

Array Name

Array Pointer

Array pointer approach – contiguity constraints

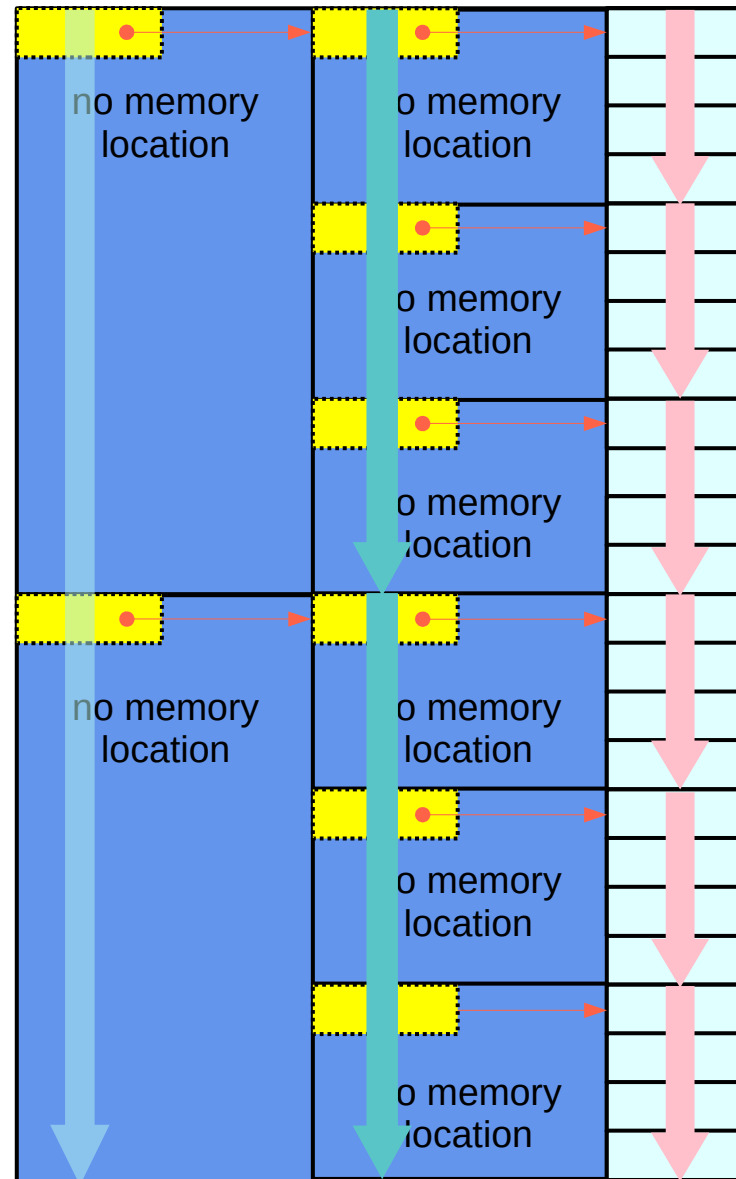

Array **Pointer** Approach
(**pointer to arrays**)

Equivalence and contiguity (1)

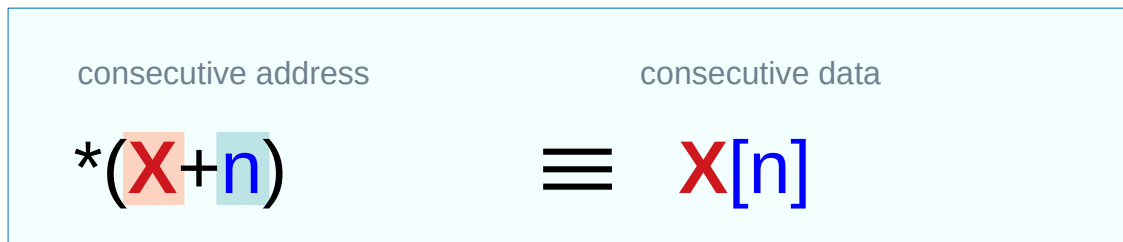

contiguous index : n

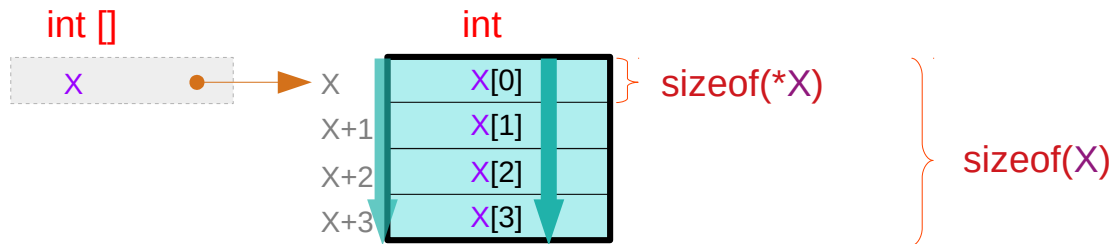

`int X[4];` contiguous `X[i]` for a given `X` : **primitive types**

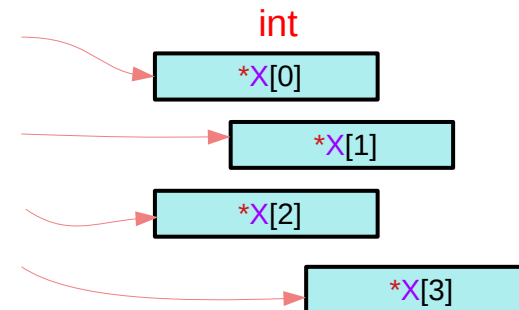
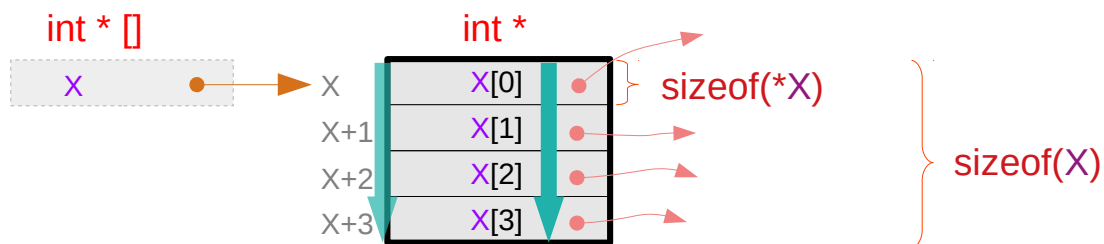

`int * X[4];` contiguous `X[i]` for a given `X` : **pointer types**

Equivalence and contiguity (2)

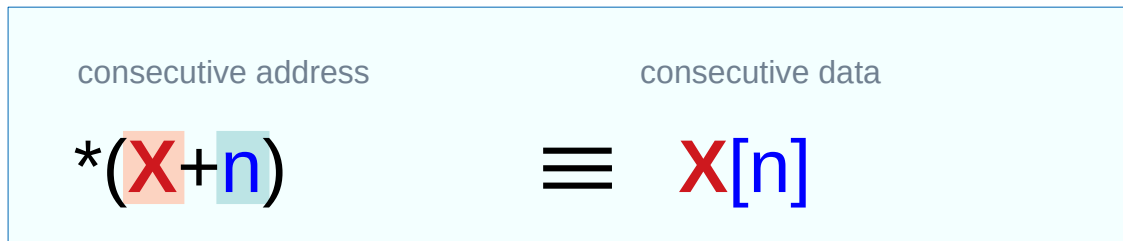

contiguous index : n

can be recursively applied

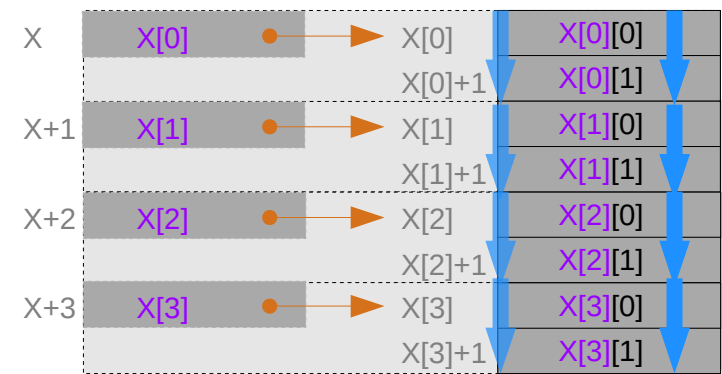
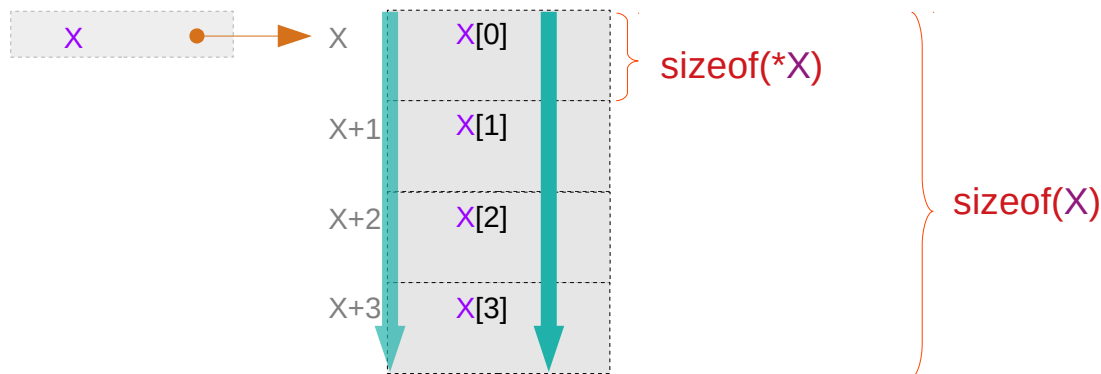

atype * X[4]; contiguous X[i] for a given X : abstract data types

Recursive applications of equivalences

By definition, contiguous memory locations are assumed

consecutive address

consecutive data

$$*(X+n) \equiv X[n]$$

contiguous index : n

$$*(p[m]+n) \iff p[m][n]$$

$$X = p[m] \quad \text{contiguous index : } n$$

$$(*(p+m))[n]; \iff p[m][n];$$

$$X = p \quad \text{contiguous index : } m$$

Equivalence for a given p[m] (1)

$$*(p[m]+n) \iff p[m][n]$$

for a given $p[m]$ contiguous index : n

int p[M][4]; contiguous p[m][n] for a given p[m] : **primitive types**

$m = 0, 1, \dots, M-1$

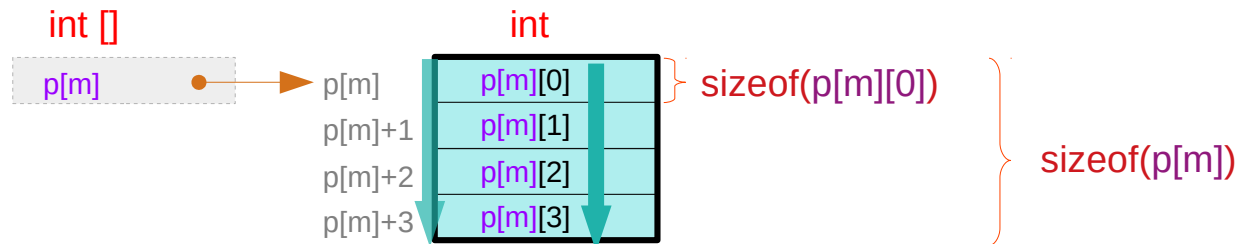

int * p[M][4]; contiguous p[m][n] for a given p[m] : **pointer types**

$m = 0, 1, \dots, M-1$

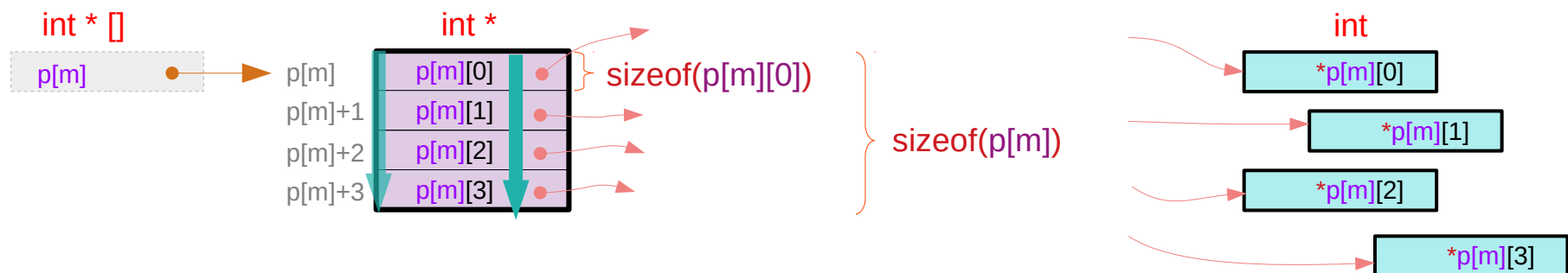

Equivalence for a given p[m] (2)

$$*(p[m]+n) \iff p[m][n]$$

for a given $p[m]$ contiguous index : n

`atype * p[M][4];` contiguous $p[m][n]$ for a given $p[m]$: **abstract data types** $m = 0, 1, \dots, M-1$

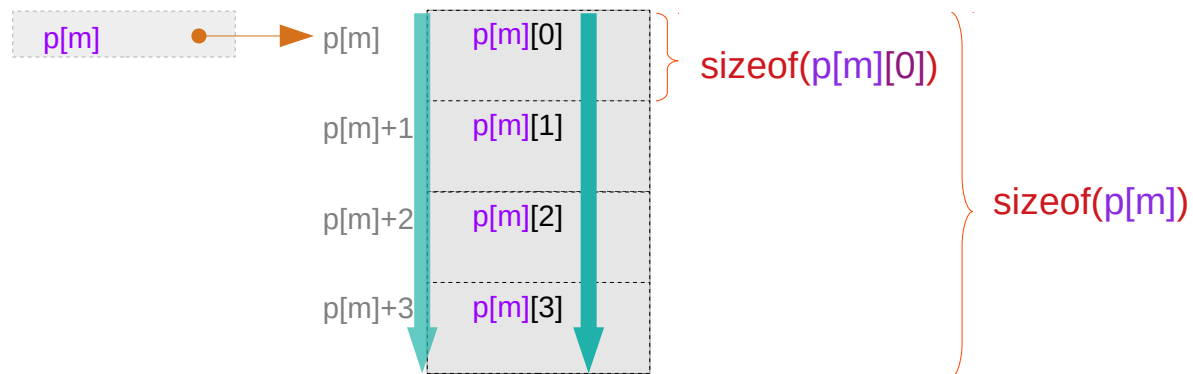

can be recursively applied

Equivalence for a given p[m][n]

$$*(p[m][n]+k) \iff p[m][n][k]$$

for a given `p[m][n]` contiguous index : `k`

`atype * p[M][4][2];` contiguous `p[m][n][k]` for a given `p[m][n]` : **abstract data types** `m = 0, 1, ..., M-1`

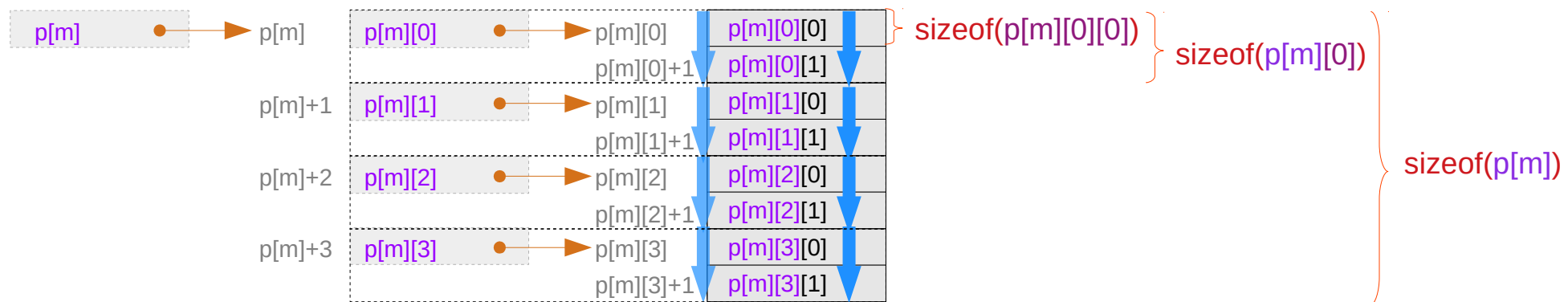

Contiguity constraints in multi-dimensional arrays

$$*(p[m]+n) \iff p[m][n]$$

for a given $p[m]$, thus for a given p and m ,
 $p[m][n]$'s must be contiguous for all n .
 $p[m][0], p[m][1], \dots, p[m][N-1]$

contiguous index : n

$$*(p+m) \iff p[m]$$

for a given p ,
 $p[m]$'s must be contiguous for all m .
 $p[0], p[1], \dots, p[M-1]$

contiguous index : m

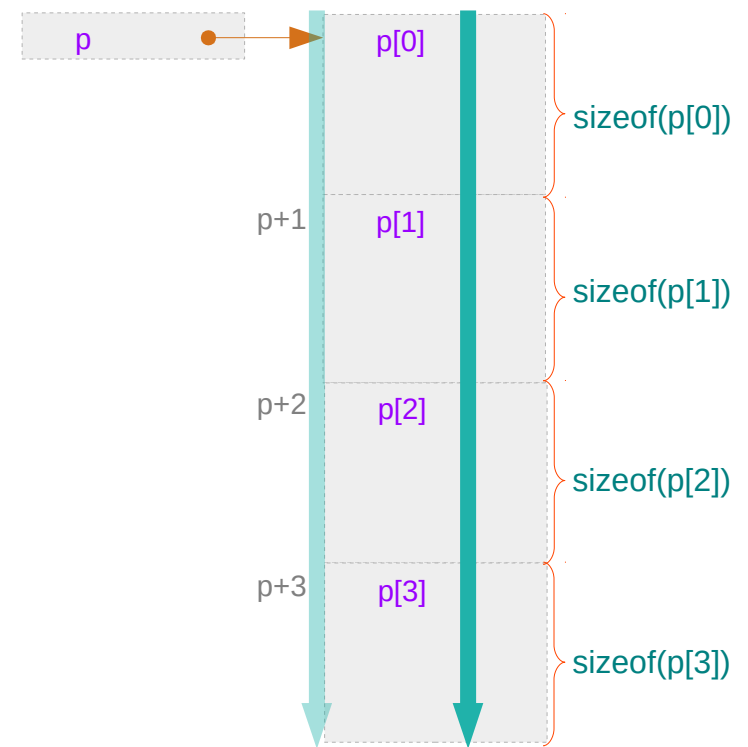
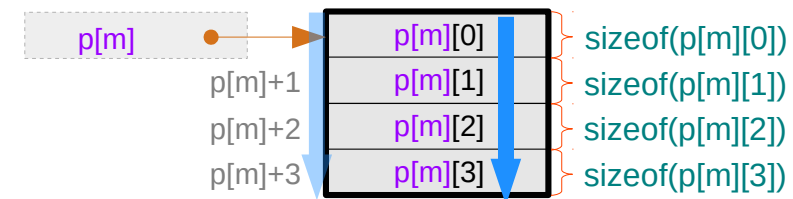

Contiguity constraints for p

$$*(p+m) \iff p[m]$$

for a given p contiguous index : m

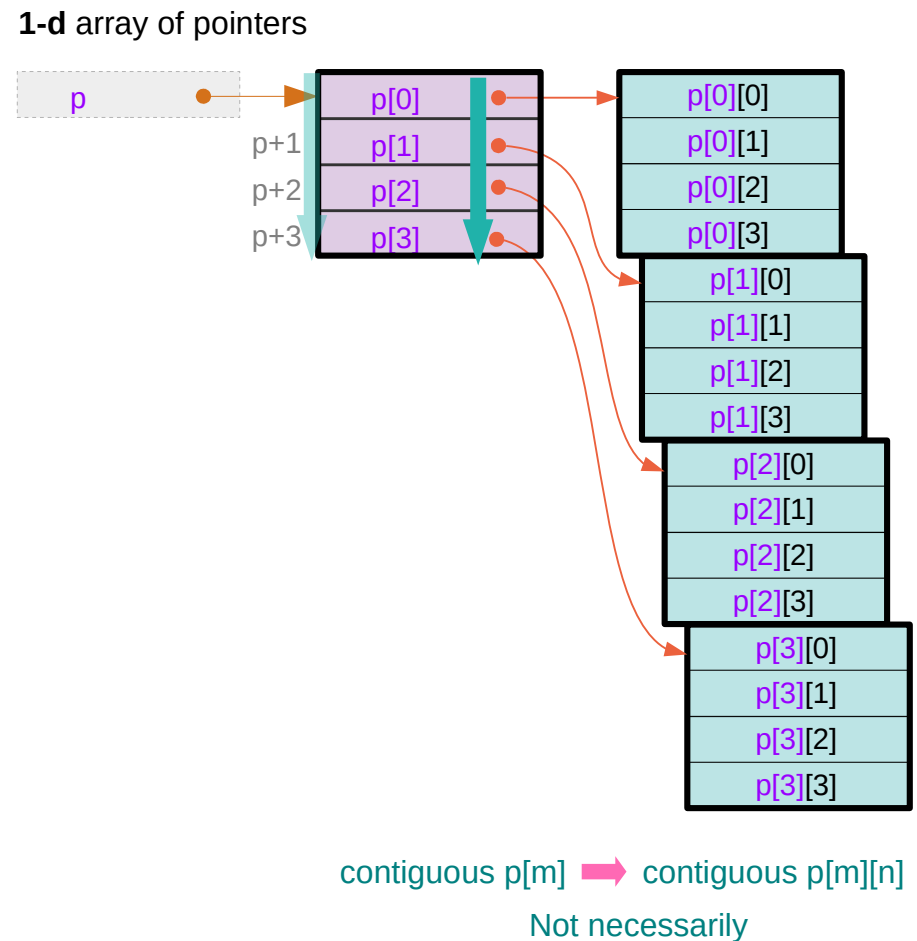
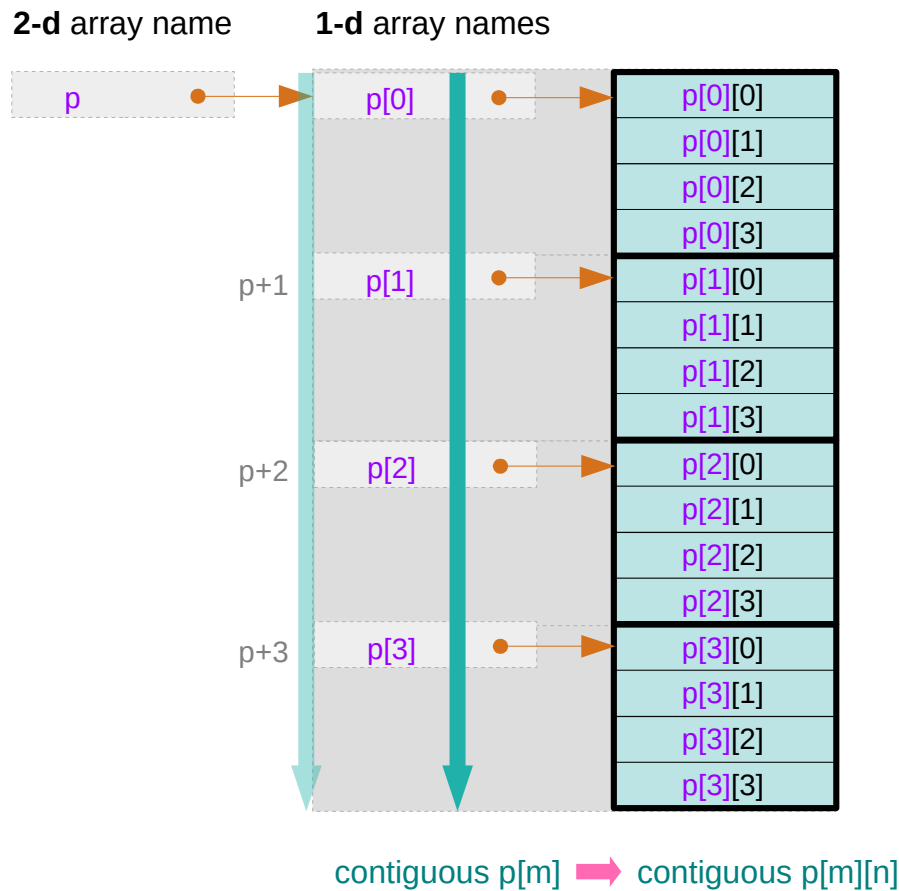

Contiguity constraints for p[m] – using array pointers

$$*(p[m]+n) \iff p[m][n]$$

for a given $p[m]$ contiguous index : n

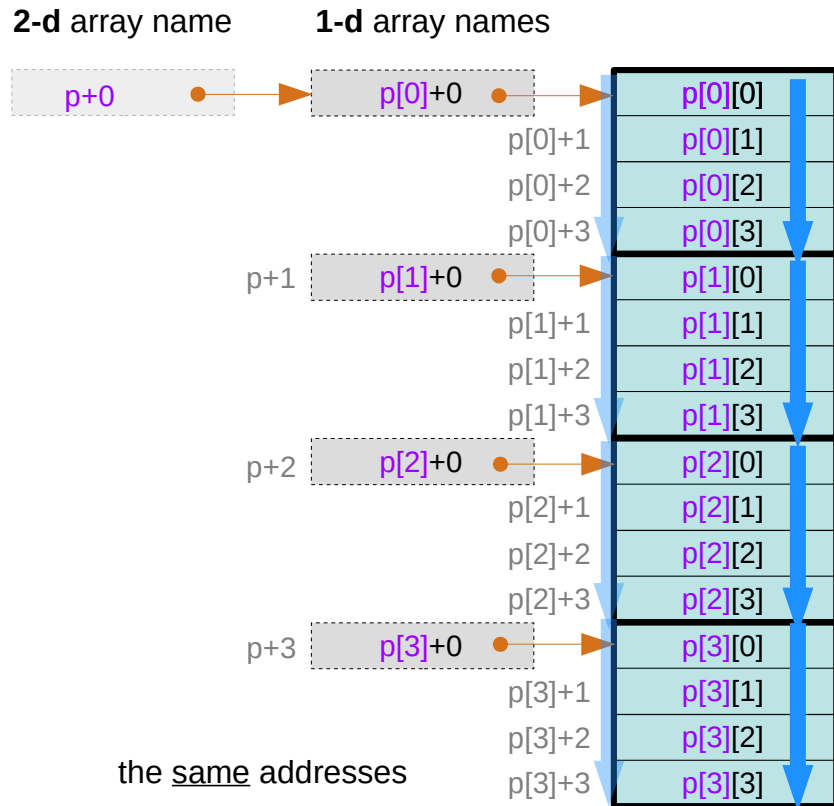

$$p[0][0] = *(p[0]+0) \xrightarrow{\text{addr}} \underbrace{\&p[0][0] = p[0]}_{\text{addr}} \xrightarrow{\text{addr}} p+0$$

$$p[1][0] = *(p[1]+0) \xrightarrow{\text{addr}} \underbrace{\&p[1][0] = p[1]}_{\text{addr}} \xrightarrow{\text{addr}} p+1$$

$$p[2][0] = *(p[2]+0) \xrightarrow{\text{addr}} \underbrace{\&p[2][0] = p[2]}_{\text{addr}} \xrightarrow{\text{addr}} p+2$$

$$p[3][0] = *(p[3]+0) \xrightarrow{\text{addr}} \underbrace{\&p[3][0] = p[3]}_{\text{addr}} \xrightarrow{\text{addr}} p+3$$

the same addresses

contiguous $p[m]$ \rightarrow contiguous $p[m][n]$

virtual array pointer \iff no real memory locations

Contiguity constraints for p[m] – using pointer arrays

$$*(p[m]+n) \iff p[m][n]$$

for a given $p[m]$ contiguous index : n

1-d array of pointers

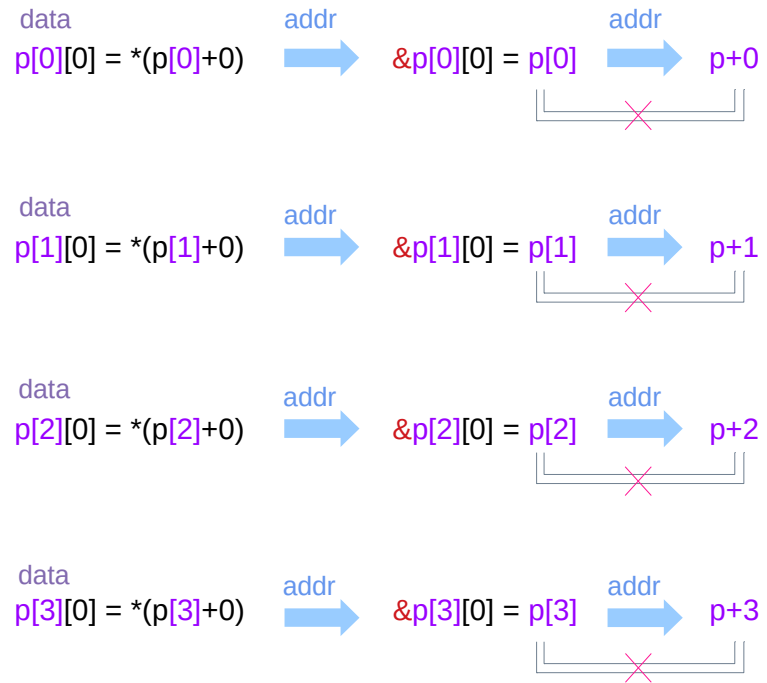
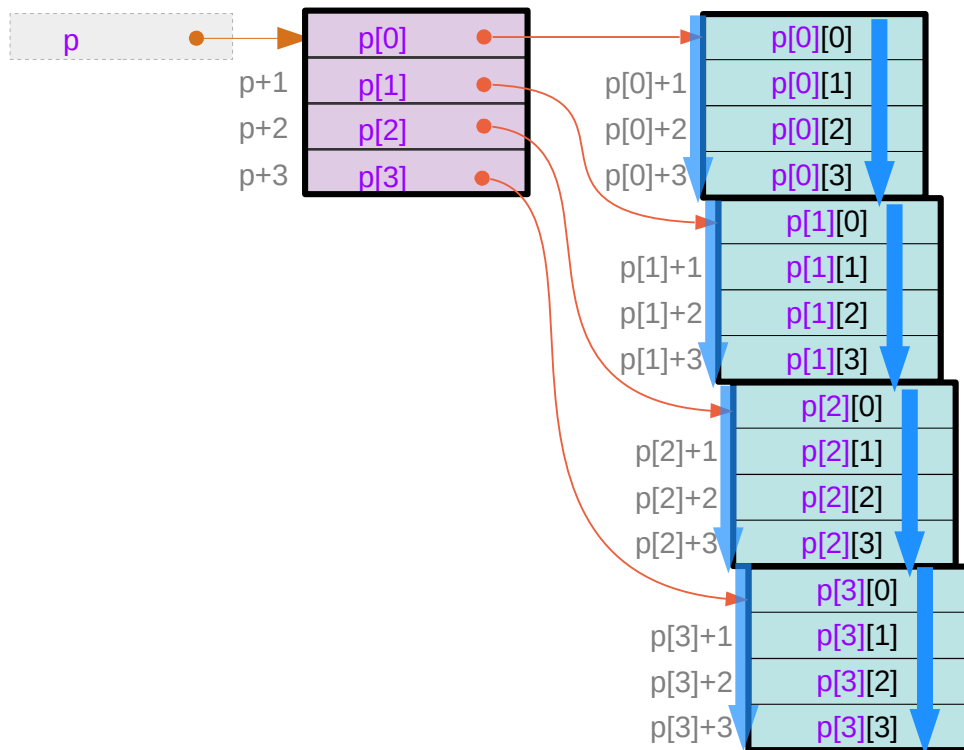

the different addresses

contiguous $p[m]$ \rightarrow contiguous $p[m][n]$
Not necessarily

Contiguity constraints for 2-d arrays

```
int a[M][N] ;
```

$*(a+m) \leftrightarrow a[m]$

$a[0], a[1], \dots, a[M-1]$
are contiguous

$*(a[m]+n) \leftrightarrow a[m][n]$

$a[m][0], a[m][1], \dots, a[m][N-1]$
are contiguous

```
int (*b)[N] ;
```

$*(b+m) \leftrightarrow b[m]$

$b[0], b[1], \dots, b[M-1]$
are contiguous

$*(b[m]+n) \leftrightarrow b[m][n]$

$b[m][0], b[m][1], \dots, b[m][N-1]$
are contiguous

```
int * c[M] ;
```

$*(c+m) \leftrightarrow c[m]$

$c[0], c[1], \dots, c[M-1]$
are contiguous

$*(c[m]+n) \leftrightarrow c[m][n]$

$c[m][0], c[m][1], \dots, c[m][N-1]$
are contiguous

a set of assignments of pointers
are necessary for this contiguity

Pointer Arrays vs Array Pointers

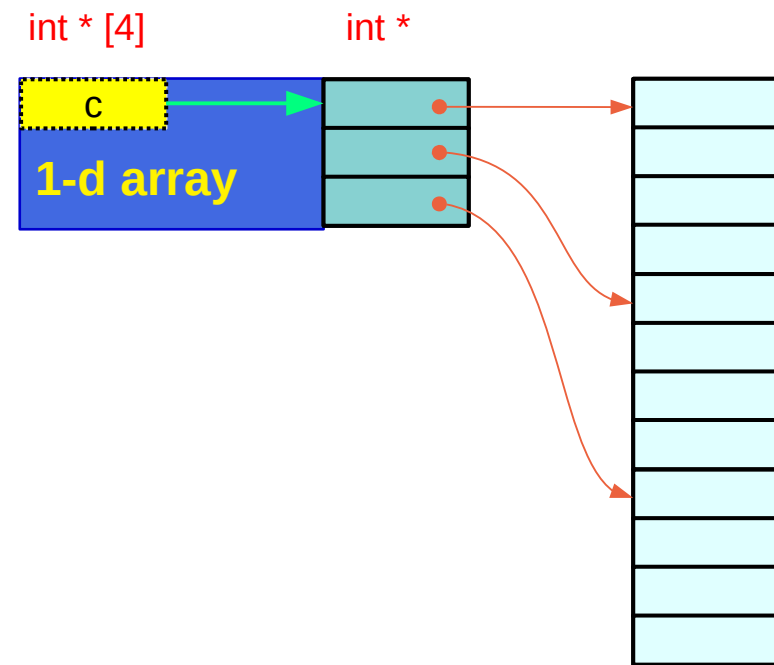
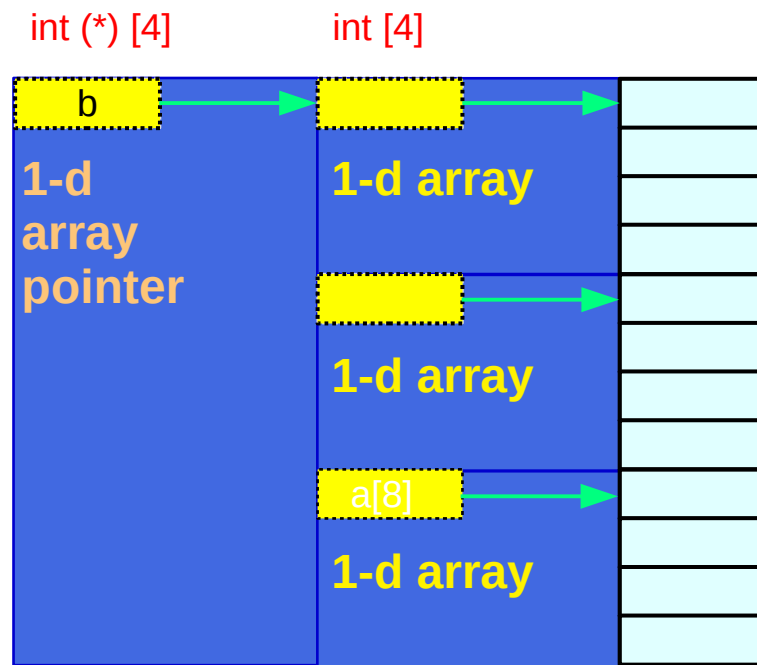

```
int (*b)[N] ;
```

```
int * c[M] ;
```

with proper assignments

```
*(b+m)      ↔  b[m]
*(b[m]+n)   ↔  b[m][n]
```

```
*(c+m)      ↔  c[m] or
*(c[m]+n)   ↔  c[m][n]
```

Pointer Arrays vs Array Pointers

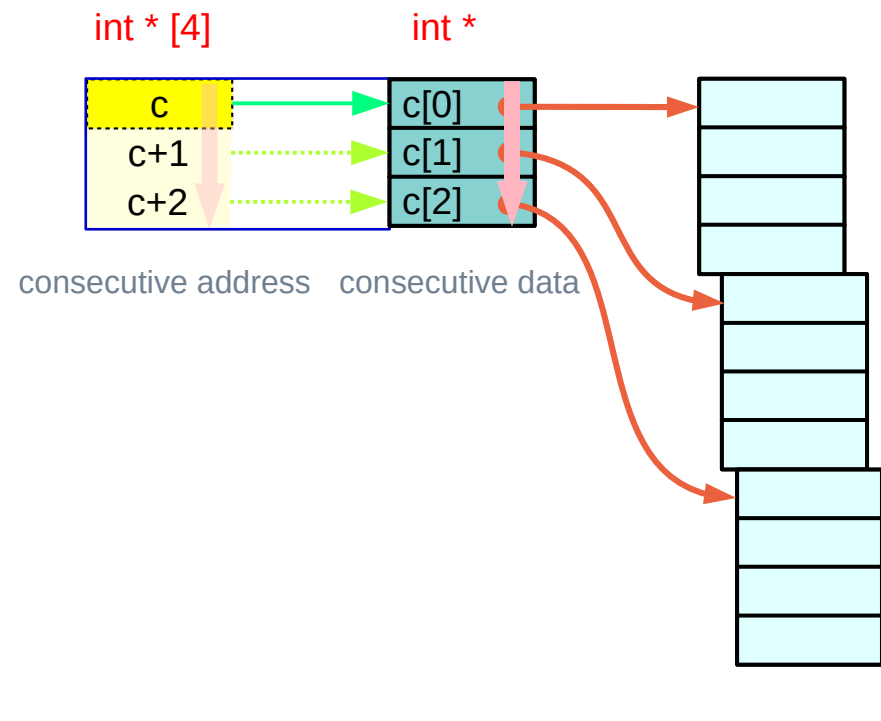
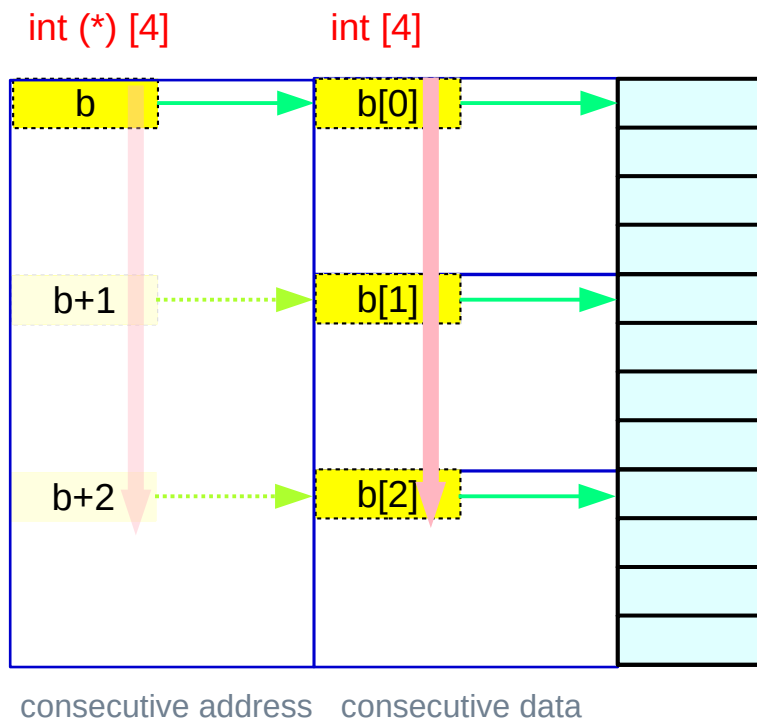

`int (*b)[N] ;`

`int * c[M] ;`

with proper assignments

`*(b+m)` \longleftrightarrow `b[m]`
`*(b[m]+n)` \longleftrightarrow `b[m][n]`

`*(c+m)` \longleftrightarrow `c[m]` or
`*(c[m]+n)` \longleftrightarrow `c[m][n]`

Pointer Arrays vs Array Pointers

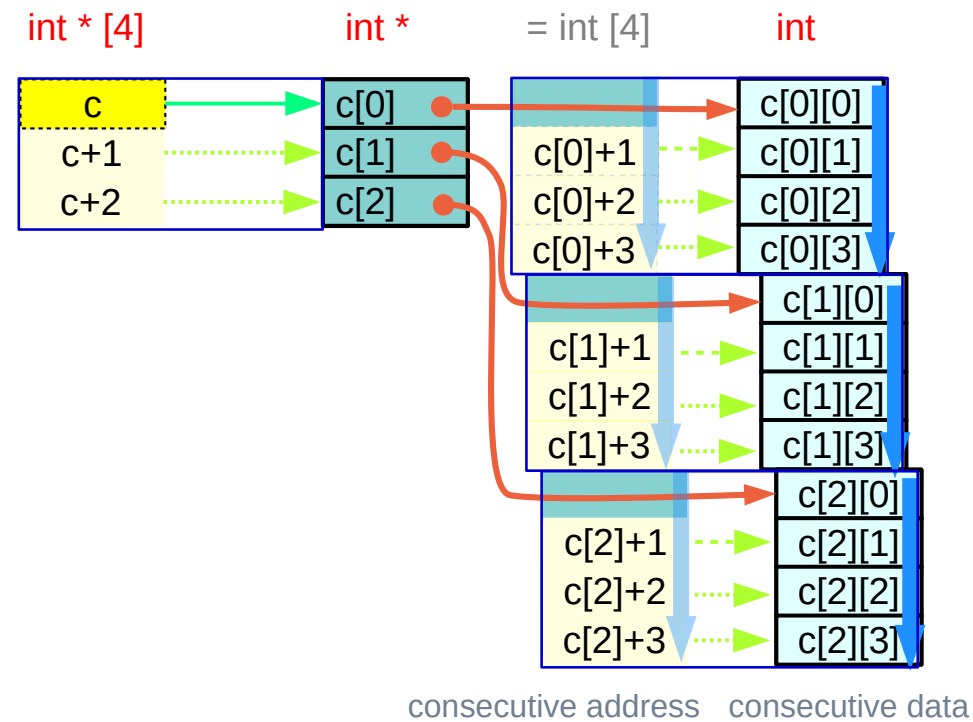
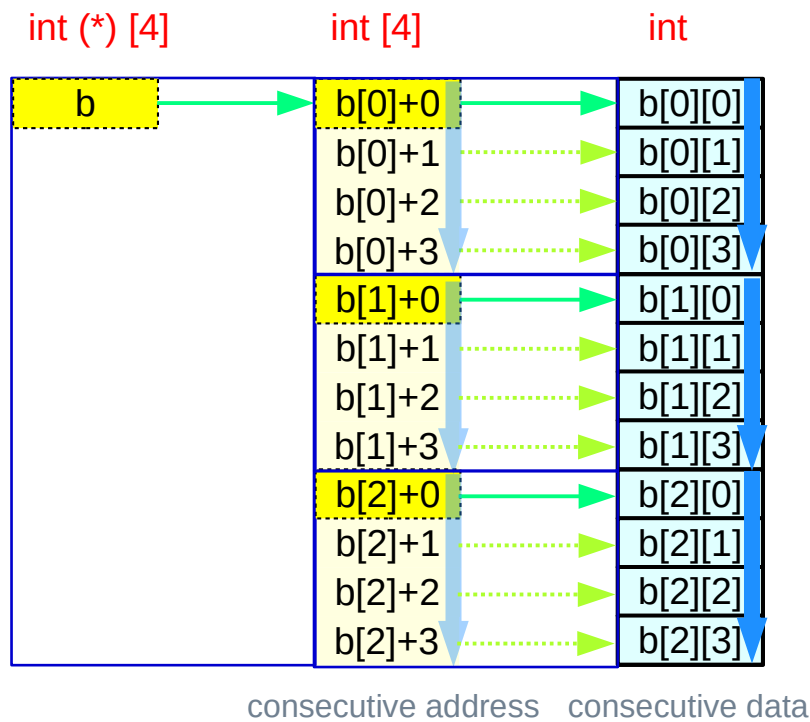

```
int (*b)[N] ;
```

```
int * c[M] ;      with proper assignments
```

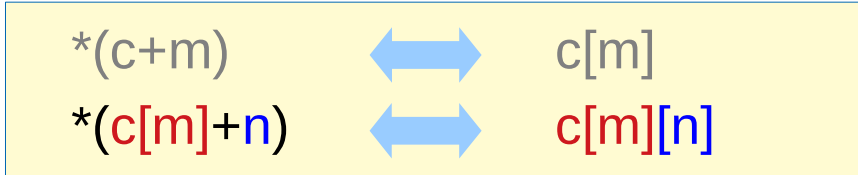
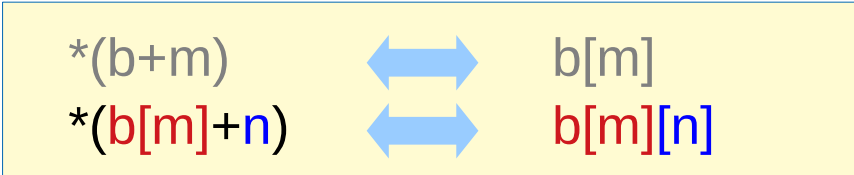

Three contiguity constraints for 3-d arrays

Pointer Array Approach (array of pointers)

$c[i][j][k]$ \rightarrow $*(c[i][j] + k)$
 $*(c[i][j] + k)$ \rightarrow $*(*(c[i] + j) + k)$
 $*(*(c[i] + j) + k)$ \rightarrow $*(***(c + i) + j) + k)$

contiguous **int** **int**
contiguous pointers to **int** **int ***
contiguous double pointers to **int** **int ****

the contiguity constraints are satisfied by allocating arrays of pointers

Array Pointer Approach (pointer to arrays)

$c[i][j][k]$ \rightarrow $*(c[i][j] + k)$
 $*(c[i][j] + k)$ \rightarrow $*(*(c[i] + j) + k)$
 $*(*(c[i] + j) + k)$ \rightarrow $*(***(c + i) + j) + k)$

contiguous **0-d** arrays **int** **int**
contiguous **1-d** arrays **int [4]** **int ***
contiguous **2-d** arrays **int [3][4]** **int (*) [4]**

The contiguity constraints are satisfied by row major ordered linear data layout

Contiguous array pointers $c[i][j][k] \equiv *(c[i][j] + k)$

```

c[0][0][0] = *(c[0][0] + 0)
c[0][0][1] = *(c[0][0] + 1)
c[0][0][2] = *(c[0][0] + 2)
c[0][0][3] = *(c[0][0] + 3)
c[0][1][0] = *(c[0][1] + 0)
c[0][1][1] = *(c[0][1] + 1)
c[0][1][2] = *(c[0][1] + 2)
c[0][1][3] = *(c[0][1] + 3)

```

• •
• •

contiguous 1-d
array elements

$c[i][j]$
int [4] 4 contiguous 0-d arrays
int * points to the 1st 0-d array
int 0-d array

$\text{sizeof}(c[i][j])$ [k]
 $\text{sizeof}(c[i][j][k]) * 4$
 $\text{sizeof}(\text{int}) * 4$

```
int c[2][3][4];
```

Address Value
 $c[i][j] + k$
 $\&c[i][j][0] + k * \text{sizeof}(*c[i][j])$
 $\&c[i][j][0] + k * \text{sizeof}(c[i][j][0])$
 $\&c[i][j][0] + k * 4$

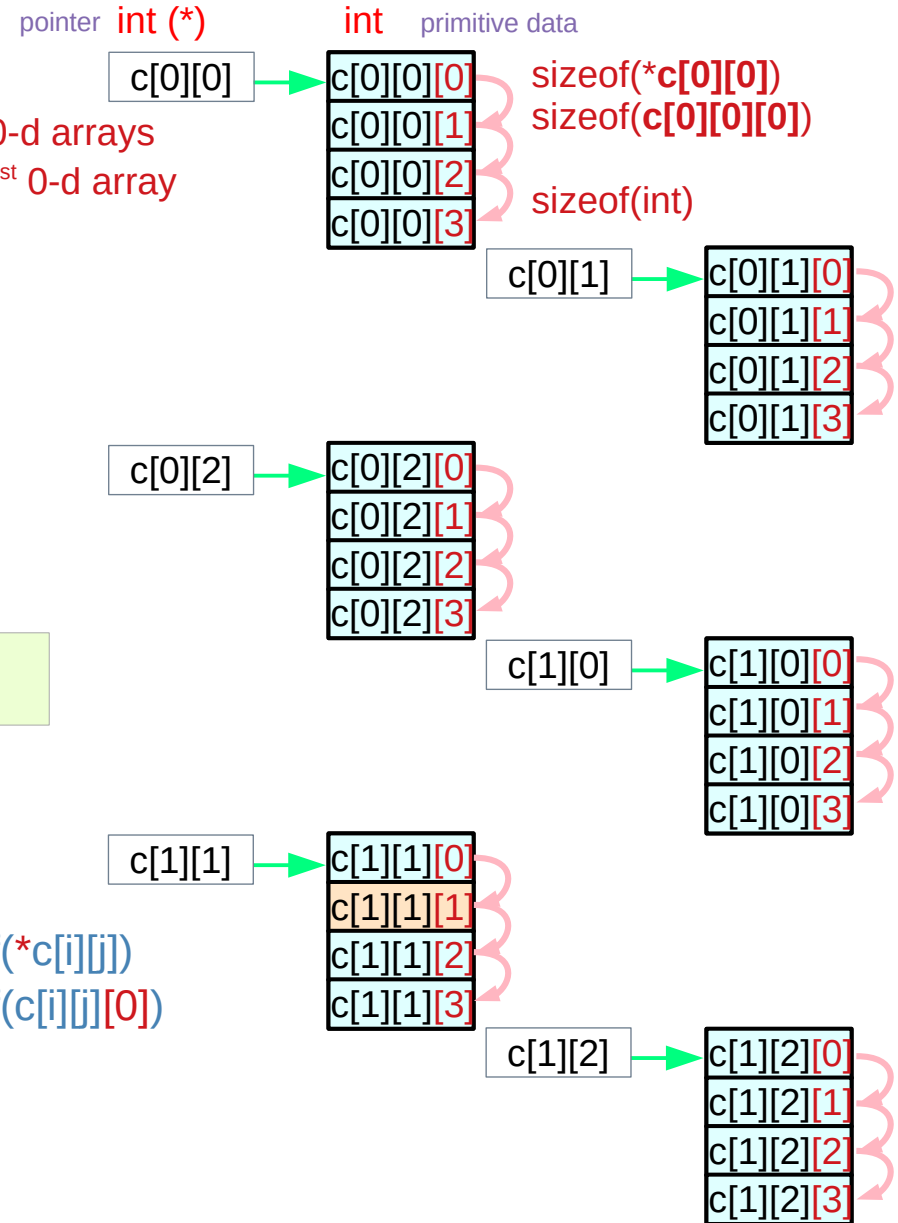

Contiguous array pointers $c[i][j] \equiv *(c[i] + j)$

```

c[0][0] = *(c[0] + 0)
c[0][1] = *(c[0] + 1)
c[0][2] = *(c[0] + 2)
c[1][0] = *(c[1] + 0)
c[1][1] = *(c[1] + 1)
c[1][2] = *(c[1] + 2)
    
```

c[i]
int [3][4] 3 contiguous 1-d arrays
int (*) [4] points to the 1st 1-d array
int [4] 1-d array

sizeof(c[i]) [j] [k]
 sizeof(c[i][j][k]) * 3 * 4
 sizeof(int) * 3 * 4

```
int c[2][3][4];
```

Address Value

$c[i] + j$

$\&c[i][0][0] + j * \text{sizeof}(*c[i])$

$\&c[i][0][0] + j * \text{sizeof}(c[i][0])$

$\&c[i][0][0] + j * 4 * 4$

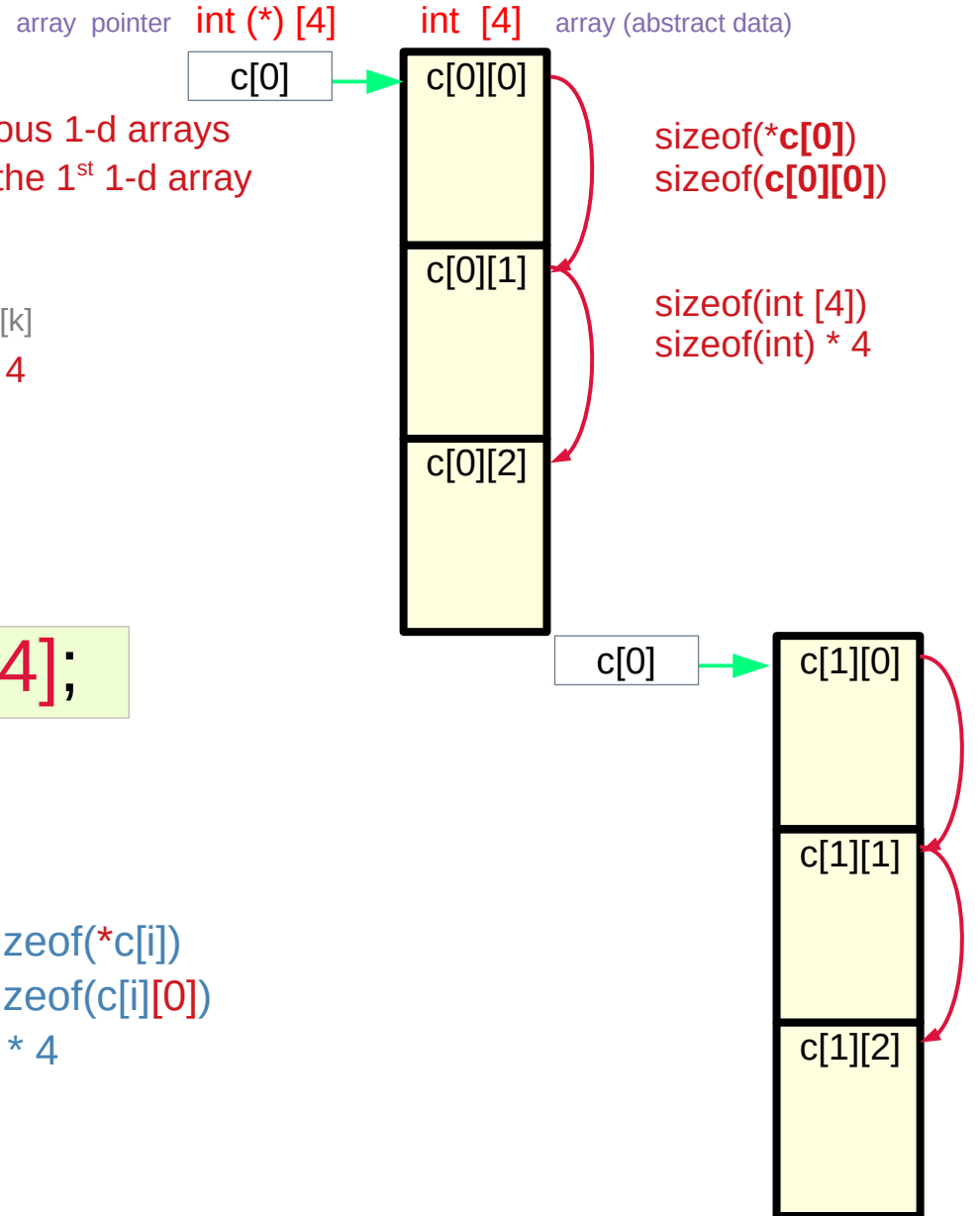

Contiguous array pointers $c[i] \equiv *(c + i)$

```
c[0] = *(c + 0)
c[1] = *(c + 1)
```

```
c
int [2][3][4]
int (*) [3][4]
int [3][4]
```

2 contiguous 2-d arrays
points to the 1st 2-d array
2-d array

```
sizeof(c)           [i] [j] [k]
sizeof(c[i][j][k]) * 2 * 3 * 4
sizeof(int) * 2 * 3 * 4
```

```
int c[2][3][4];
```

```
Address Value
c + i
&c[0][0][0] + i * sizeof(*c)
&c[0][0][0] + i * sizeof(c[0])
&c[0][0][0] + i * 4 * 3 * 4
```

array pointer $int (*) [3][4]$ $int [3][4]$ array (abstract data)

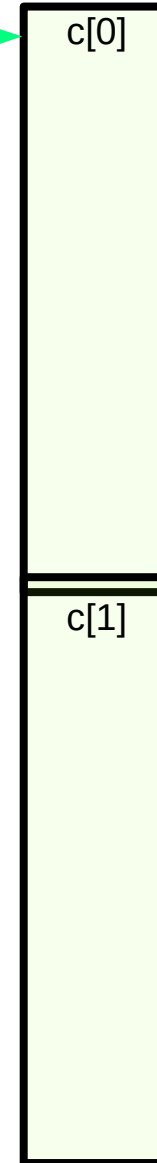

sizeof(*c)
sizeof(c[0])

sizeof(int [3][4])
sizeof(int) * 3 * 4

Contiguous linear layout

```
int c [L][M][N];
```

```
C [i][j][k];
```

L	M	N
i	j	k
$i * M * N$	$j * N$	k

Base Index = 0

Offset Index 1 (i=1)

Offset Index 2 (j=1)

Offset Index 3 (k=1)

$$(i * M * N + j * N + k)$$

$$((i * M + j) * N + k)$$

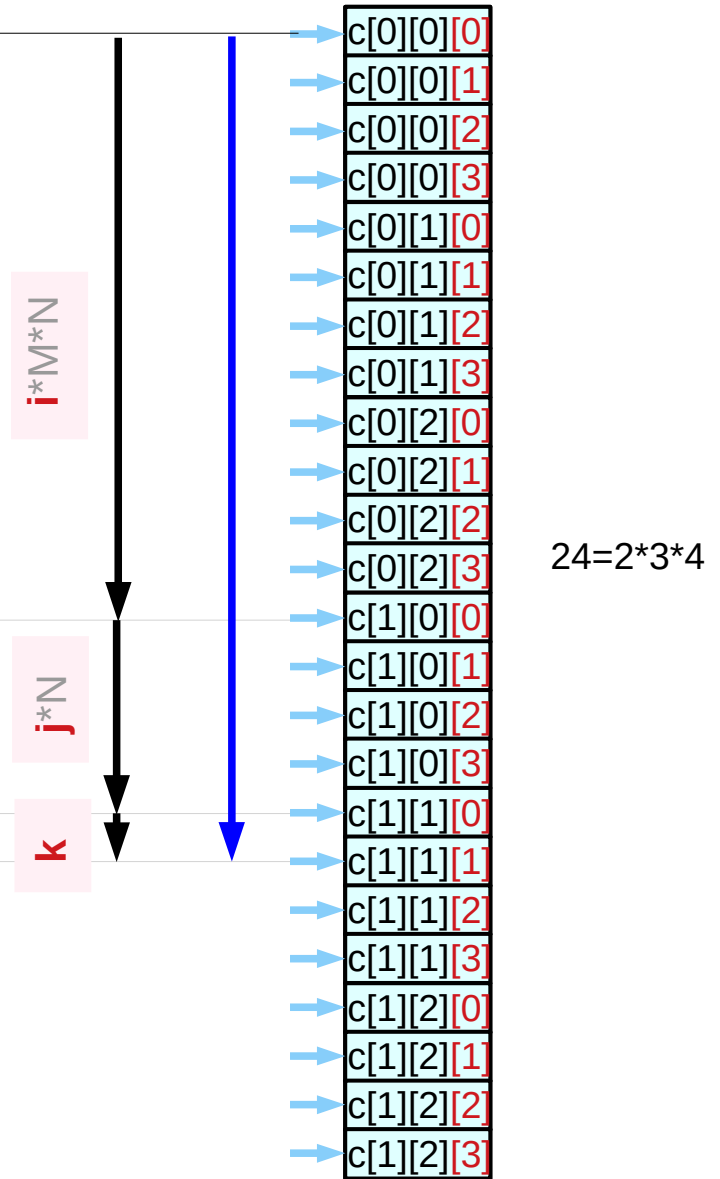

Base and Offset Addressing

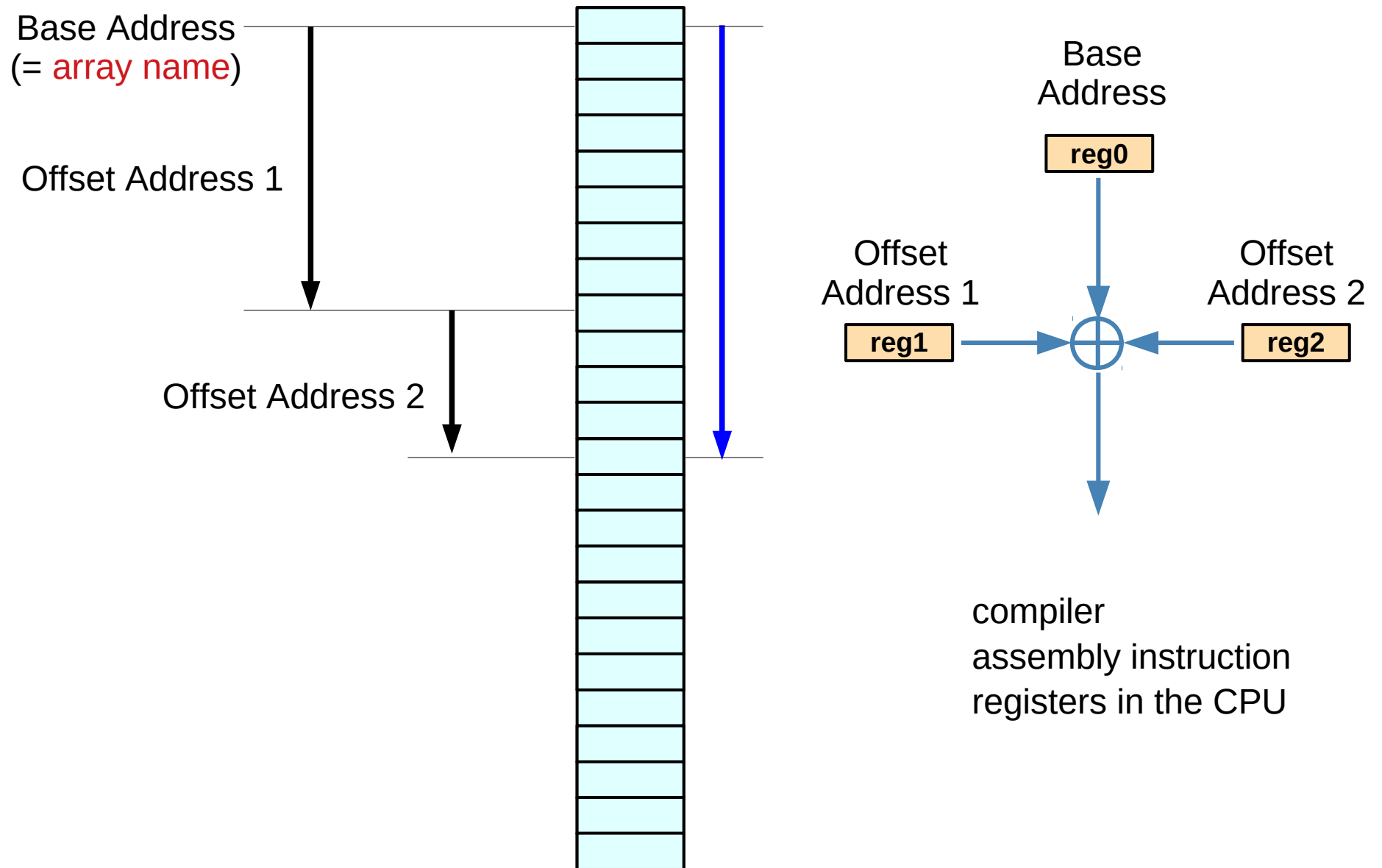

Array Pointer Approach

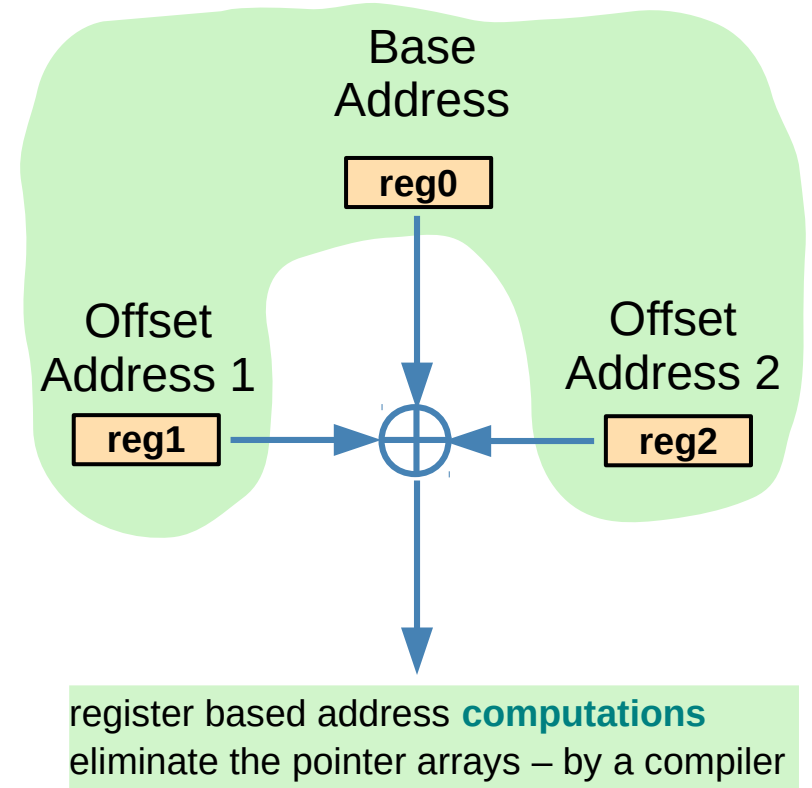
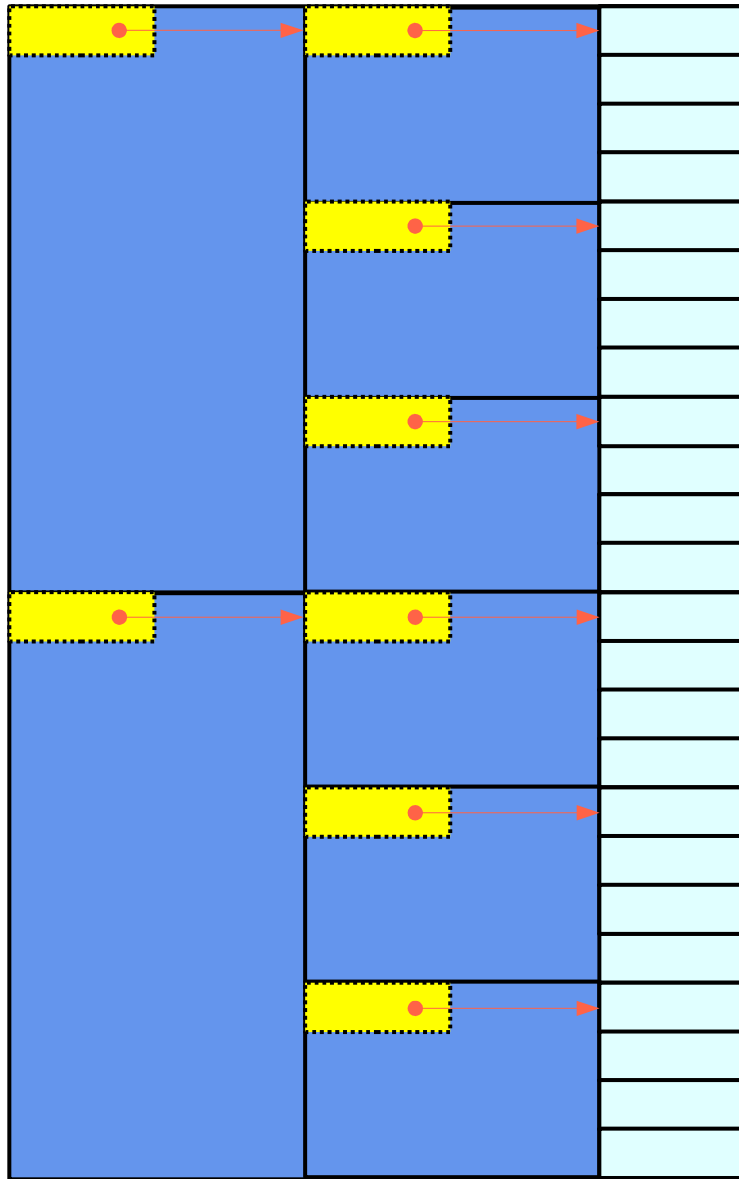

Array Pointer Approach
(pointer to arrays)

References

- [1] Essential C, Nick Parlante
- [2] Efficient C Programming, Mark A. Weiss
- [3] C A Reference Manual, Samuel P. Harbison & Guy L. Steele Jr.
- [4] C Language Express, I. K. Chun