

# Laurent Series and z-Transform

## - Geometric Series

## Combinations

A

20200630 Tue

Copyright (c) 2016 - 2020 Young W. Lim.

Permission is granted to copy, distribute and/or modify this document under the terms of the GNU Free Documentation License, Version 1.2 or any later version published by the Free Software Foundation; with no Invariant Sections, no Front-Cover Texts, and no Back-Cover Texts. A copy of the license is included in the section entitled "GNU Free Documentation License".

Combinations of a and z  
-- common ratio in a geometric series

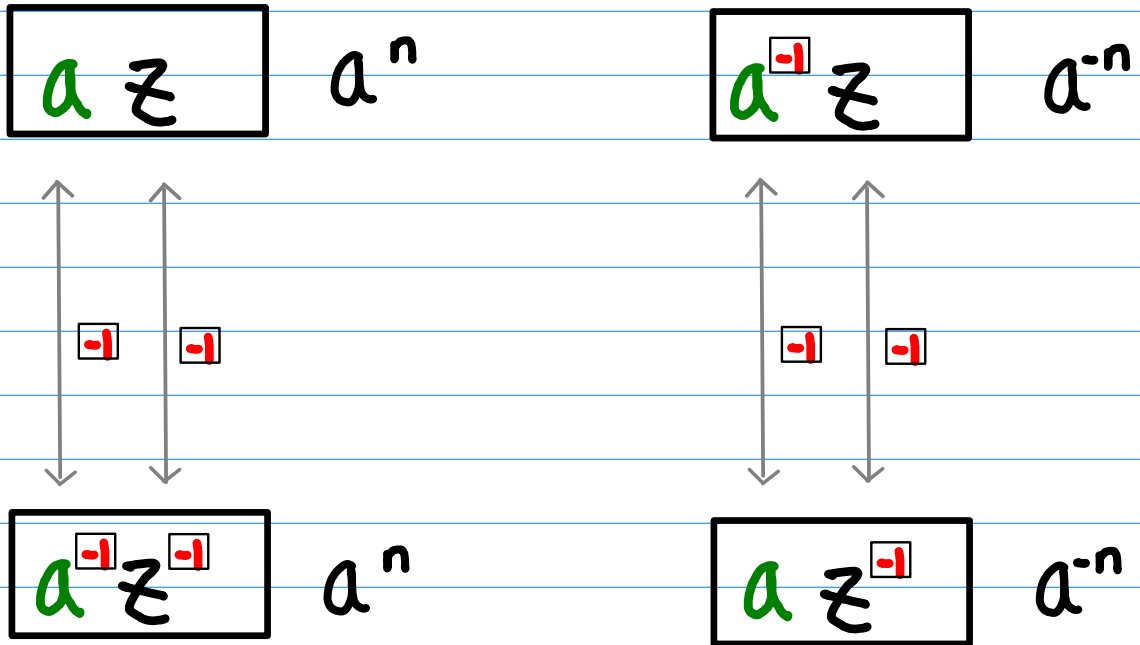

the same formula,  
different representations

# Geometric Series

common ratio

common ratio

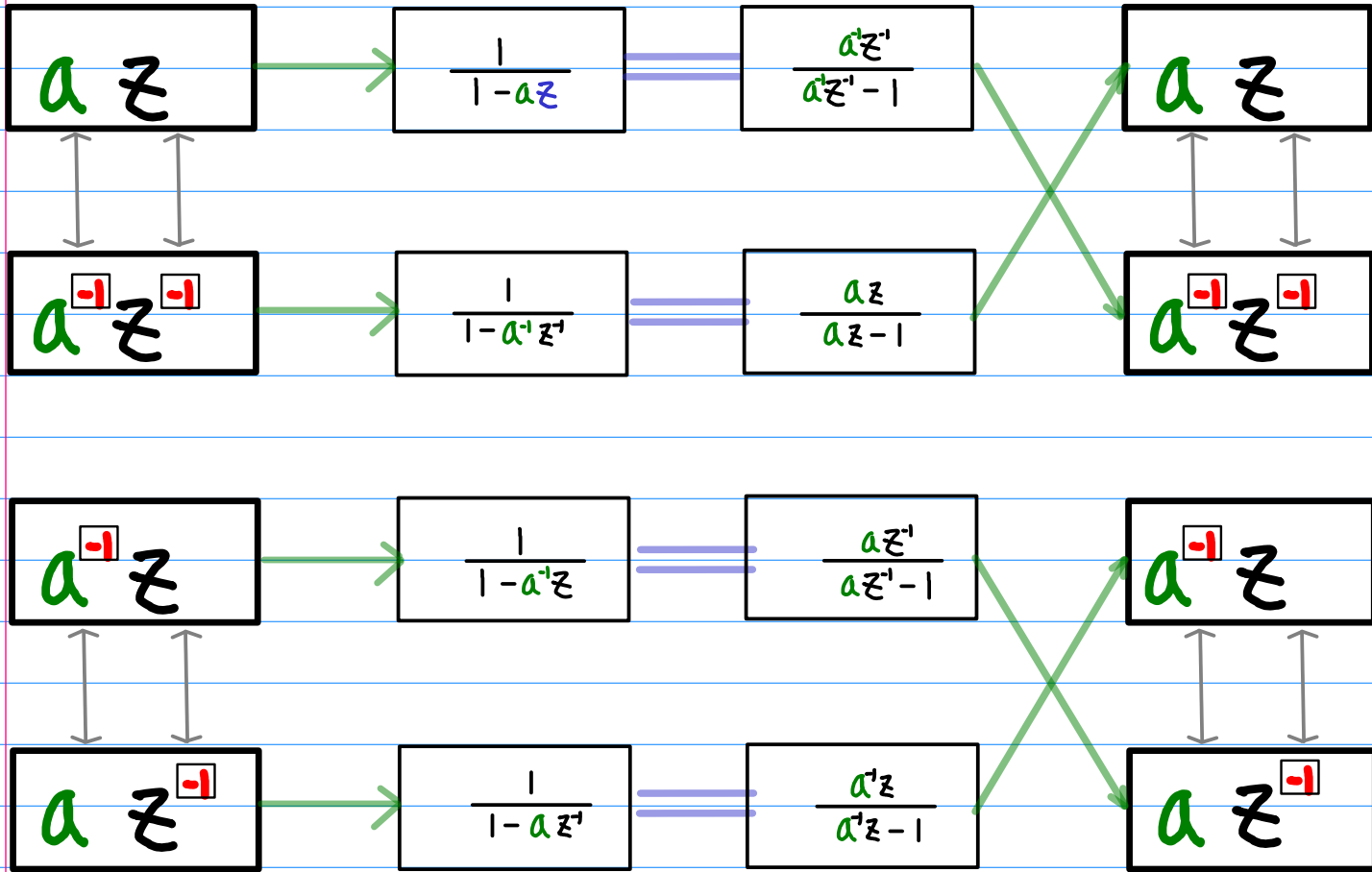

two equivalent representations  
of geometric series

# the same formula with different ROCs

# different Geometric Series

common ratio

complementary ranges

inversed common ratio

$$a z$$

causal  $u(n)$

$$\frac{1}{1 - a z} \quad |z| < a^{-1}$$

anti-causal  $u(-n-1)$

$$-\frac{a^2 z^2}{1 - a^2 z^2} \quad |z| > a^{-1}$$

$$a z^{-1}$$

$$a^0 z^0 + a^1 z^1 + a^2 z^2 + \dots$$

$$-(a^1 z^{-1} + a^2 z^{-2} + a^3 z^{-3} + \dots)$$

$$a z^{-1}$$

anti-causal  $u(-n)$

$$\frac{1}{1 - a^{-1} z^2} \quad |z| > a^{-1}$$

causal  $u(n-1)$

$$-\frac{a z}{1 - a z} \quad |z| < a^{-1}$$

$$a z$$

$$a^0 z^0 + a^1 z^1 + a^2 z^2 + \dots$$

$$-(a^1 z^1 + a^2 z^2 + a^3 z^3 + \dots)$$

$$a z^{-1}$$

causal  $u(n)$

$$\frac{1}{1 - a^{-1} z} \quad |z| < a$$

anti-causal  $u(-n-1)$

$$-\frac{a z^2}{1 - a z^2} \quad |z| > a$$

$$a z^{-1}$$

$$a^0 z^0 + a^1 z^1 + a^2 z^2 + \dots$$

$$-(a^1 z^1 + a^2 z^2 + a^3 z^3 + \dots)$$

$$a z^{-1}$$

anti-causal  $u(-n)$

$$\frac{1}{1 - a z^2} \quad |z| > a$$

causal  $u(n-1)$

$$-\frac{a^2 z}{1 - a^2 z} \quad |z| < a$$

$$a z^{-1}$$

$$a^0 z^0 + a^1 z^1 + a^2 z^2 + \dots$$

$$-(a^1 z^1 + a^2 z^2 + a^3 z^3 + \dots)$$

**Representation I**

**Representation II**

geometric series starting with a unit term

geometric series starting with a non-unit term

non-shifted range  $u(n), u(-n)$

shifted range  $u(n-1), u(-n-1)$

# the different formula with the same ROC

# different Geometric Series

common ratio

inversed common ratio

$$a z$$

causal  $u(n)$

$$\frac{1}{1 - a z} \quad |z| < a^{-1}$$

$$a^0 z^0 + a^1 z^1 + a^2 z^2 + \dots$$

left shifted  $u(-n-1)$

$$-\frac{a^1 z^{-1}}{1 - a^1 z^{-1}} \quad |z| > a^{-1}$$

$$-(a^1 z^{-1} + a^2 z^{-2} + a^3 z^{-3} + \dots)$$

$$a z^{-1}$$

$$a^{-1} z^{-1}$$

anti-causal  $u(-n)$

$$\frac{1}{1 - a^{-1} z^{-1}} \quad |z| > a^{-1}$$

$$a^0 z^0 + a^1 z^1 + a^2 z^2 + \dots$$

right shifted  $u(n-1)$

$$-\frac{a z}{1 - a z} \quad |z| < a^{-1}$$

$$-(a^1 z^1 + a^2 z^2 + a^3 z^3 + \dots)$$

$$a z$$

$$a^{-1} z^{-1}$$

causal  $u(n)$

$$\frac{1}{1 - a^{-1} z^{-1}} \quad |z| < a$$

$$a^0 z^0 + a^1 z^1 + a^2 z^2 + \dots$$

left shifted  $u(-n-1)$

$$-\frac{a z^{-1}}{1 - a z^{-1}} \quad |z| > a$$

$$-(a^1 z^{-1} + a^2 z^{-2} + a^3 z^{-3} + \dots)$$

$$a z^{-1}$$

$$a z^{-1}$$

anti-causal  $u(-n)$

$$\frac{1}{1 - a z^{-1}} \quad |z| > a$$

$$a^0 z^0 + a^1 z^1 + a^2 z^2 + \dots$$

right shifted  $u(n-1)$

$$-\frac{a^1 z}{1 - a^1 z} \quad |z| < a$$

$$-(a^1 z^1 + a^2 z^2 + a^3 z^3 + \dots)$$

$$a^{-1} z^{-1}$$

**Representation I**

geometric series starting with a unit term

non-shifted range  $u(n), u(-n)$

**Representation II**

geometric series starting with a non-unit term

shifted range  $u(n-1), u(-n-1)$

# Geometric Power Series Property (1)

Each representation has its own ROC  
(Region of Convergence)

common ratio  $a z$   $\longrightarrow$   $|z| < a^{-1}$  ROC

common ratio  $a^{-1} z^{-1}$   $\longrightarrow$   $|z| > a^{-1}$  ROC

common ratio  $a^{-1} z$   $\longrightarrow$   $|z| < a$  ROC

common ratio  $a z^{-1}$   $\longrightarrow$   $|z| > a$  ROC

# Geometric Power Series Property (2)

## Starting terms

geometric series  
starting with  
a unit term

geometric series  
starting with  
a non-unit term  
(common ratio)

$z$ causal	$\frac{1}{1-az}$	$-\frac{a'z'}{1-a'z'}$	anti-causal $z'$
$z'$ anti-causal	$\frac{1}{1-a'z'}$	$-\frac{az}{1-az}$	causal $z$
$z$ causal	$\frac{1}{1-a'z}$	$-\frac{az'}{1-a'z'}$	anti-causal $z'$
$z'$ anti-causal	$\frac{1}{1-az'}$	$-\frac{a'z}{1-a'z}$	causal $z$

Representation I

Representation II

related to shifting



# Geometric Power Series Property (3)

## Complementary Ranges

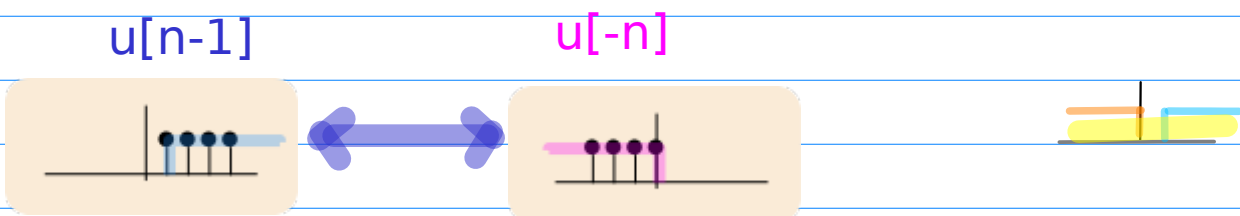
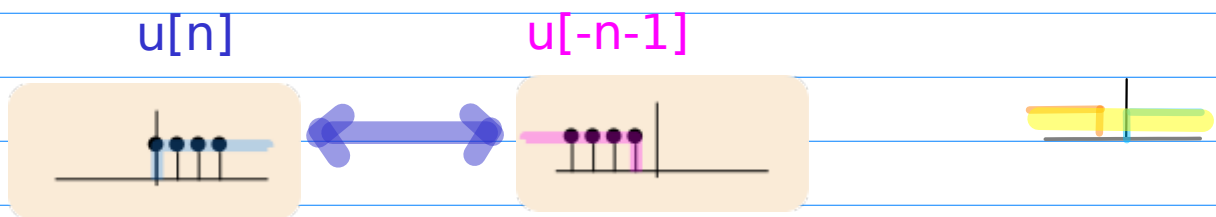

## Shifted Ranges

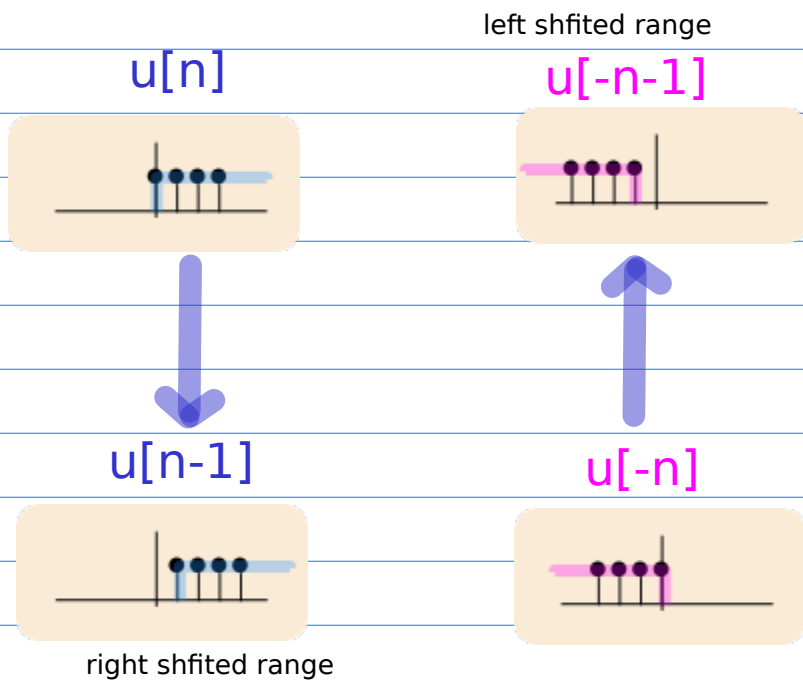

# Geometric Power Series Property (4)

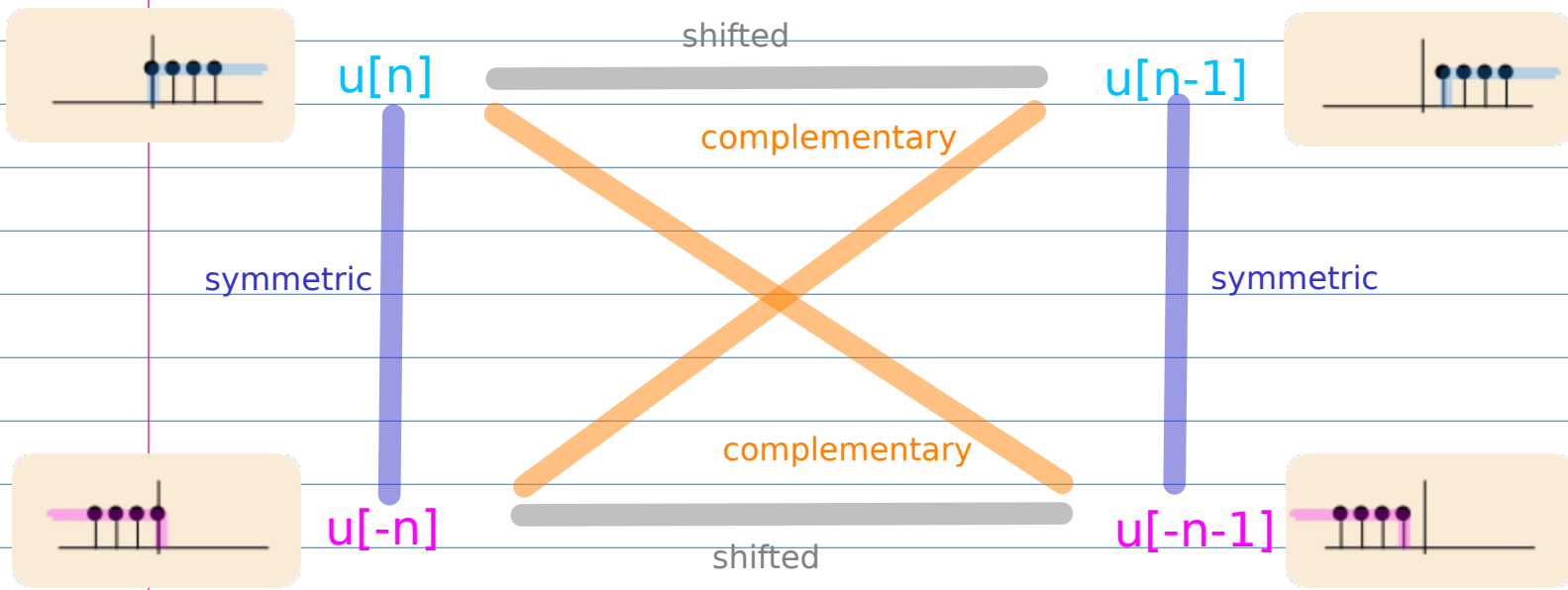

$u[n]$  complementary  $u[-n-1]$  symmetric  $u[n-1]$   
 $u[-n]$  complementary  $u[n-1]$  symmetric  $u[-n-1]$

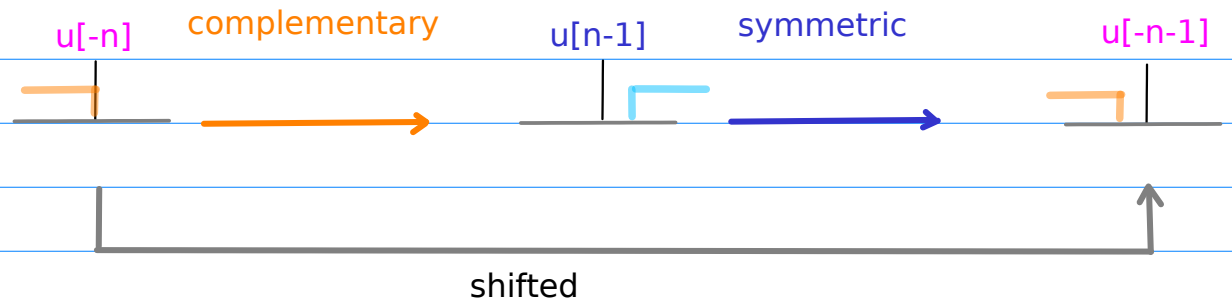
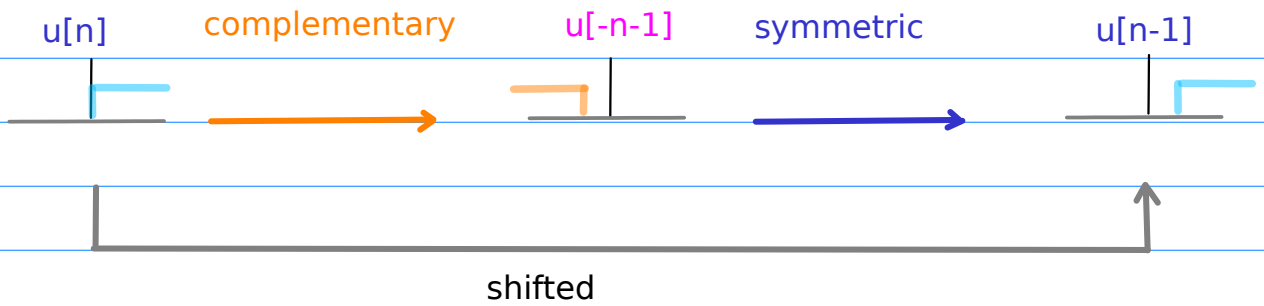

# Geometric Power Series Property (5)

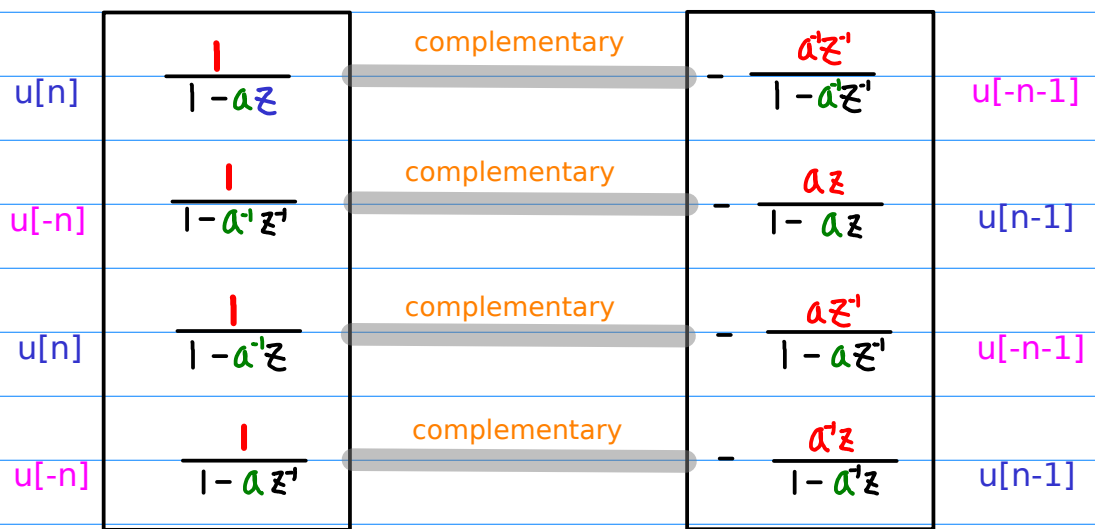
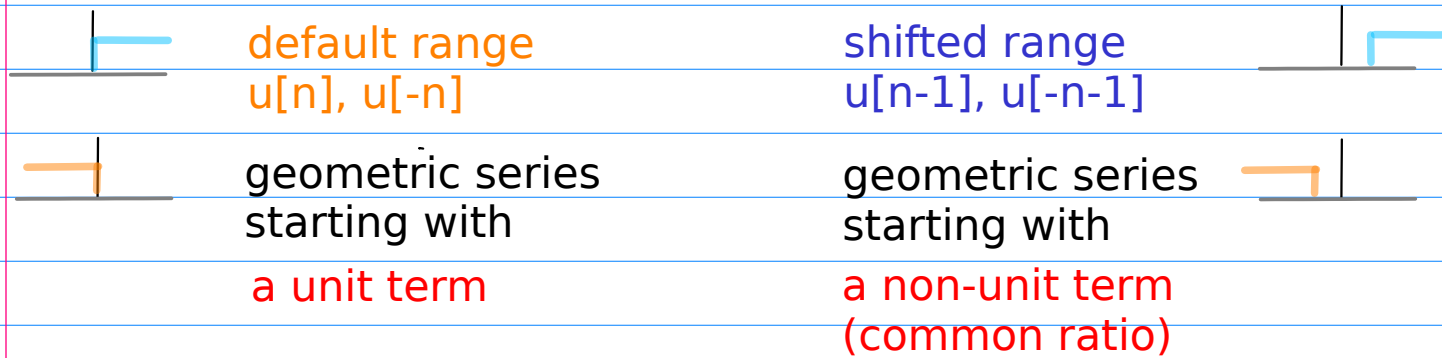

default range  $u(n), u(-n)$

shifted range  $u(n-1), u(-n-1)$

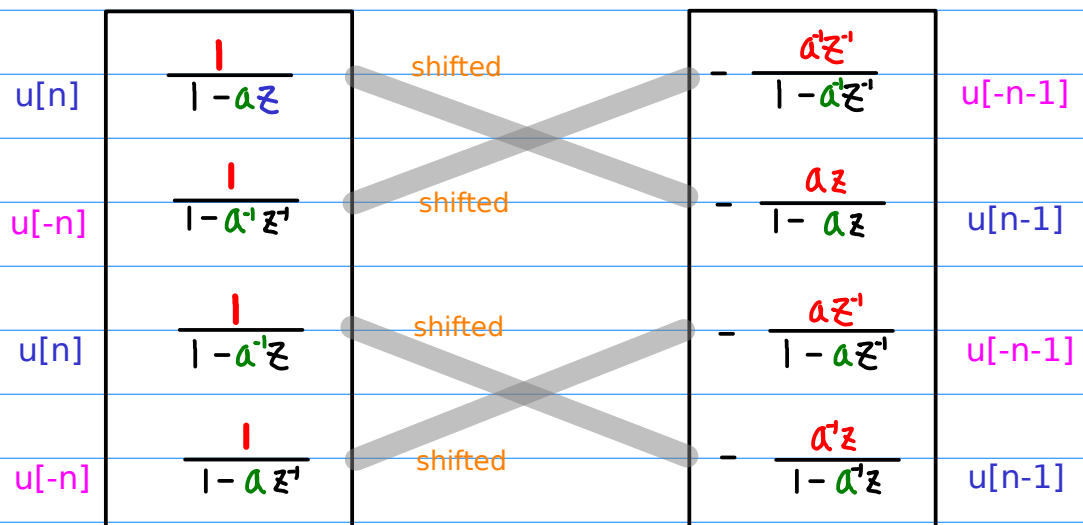

# A Common Ratio and a Exponent

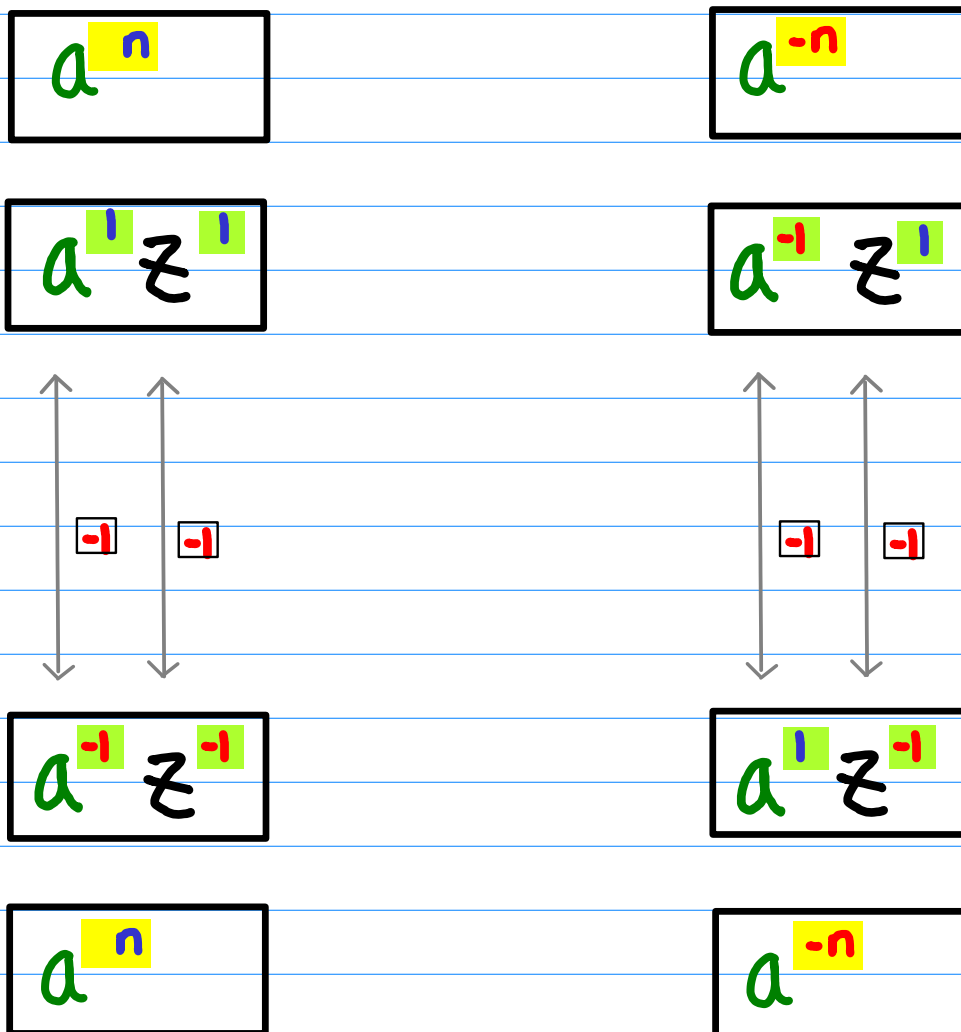

## Exponent

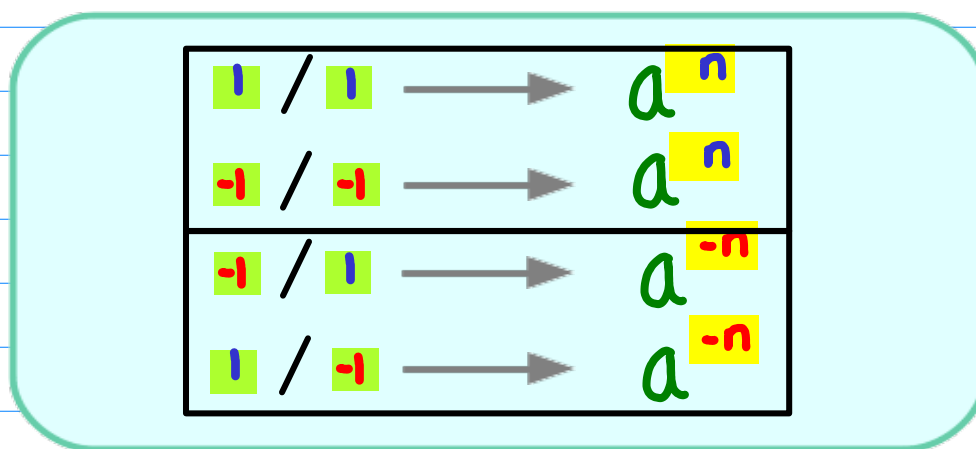

# A Common Ratio and a Default Range

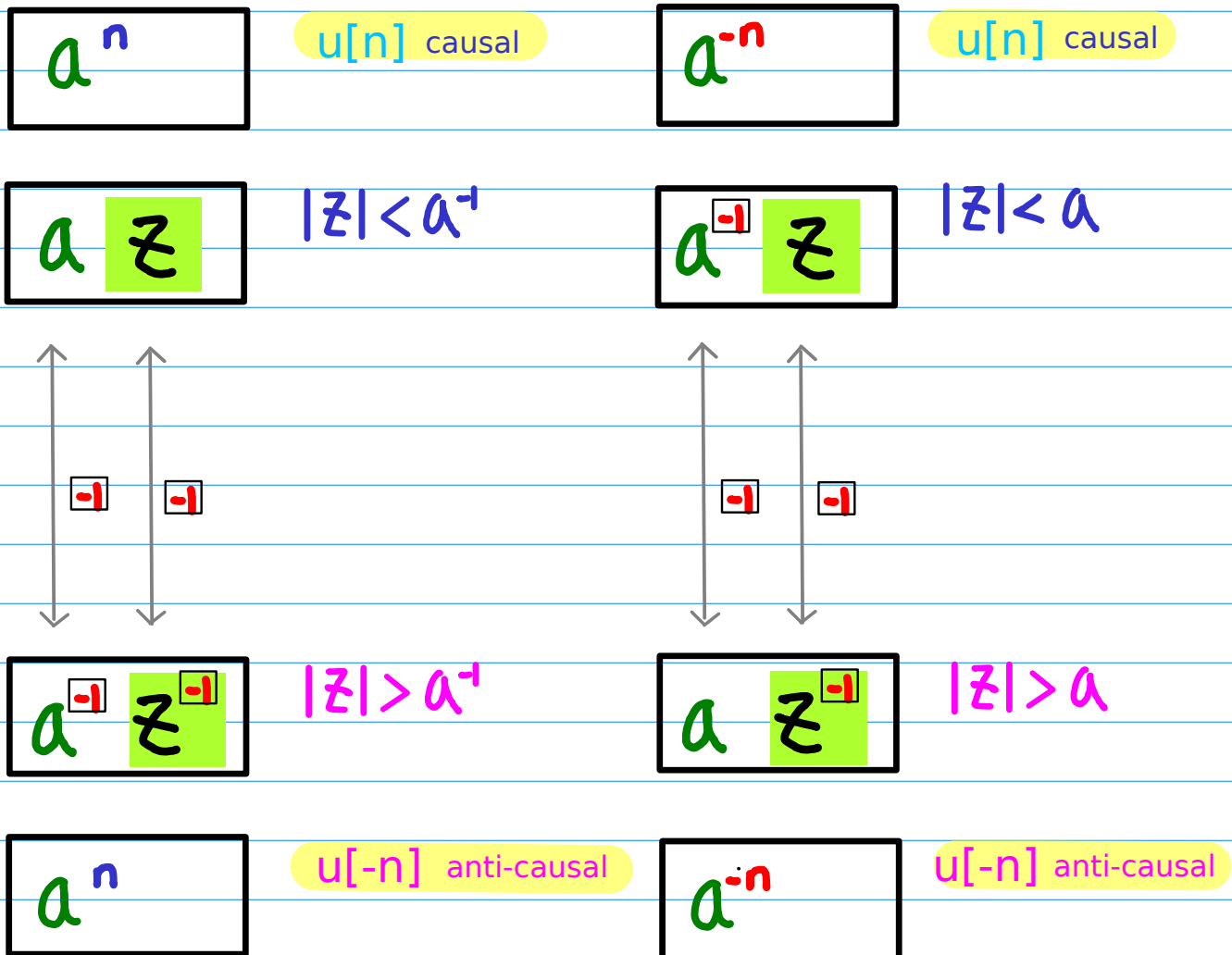

## Default Ranges

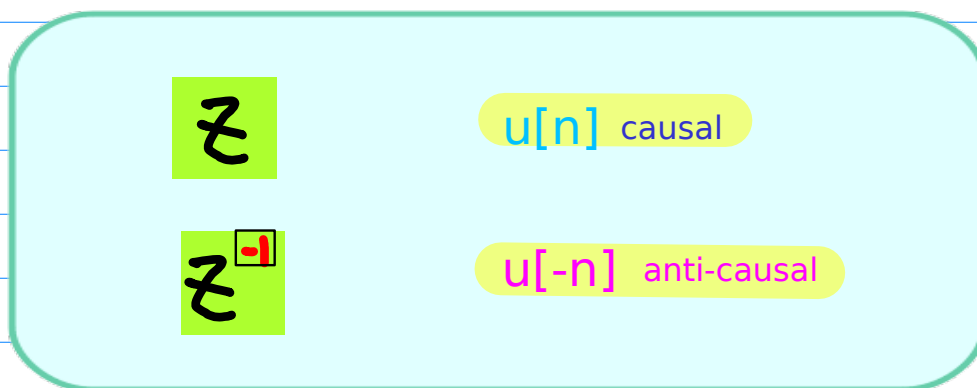

# A Common Ratio and a Complementary Range

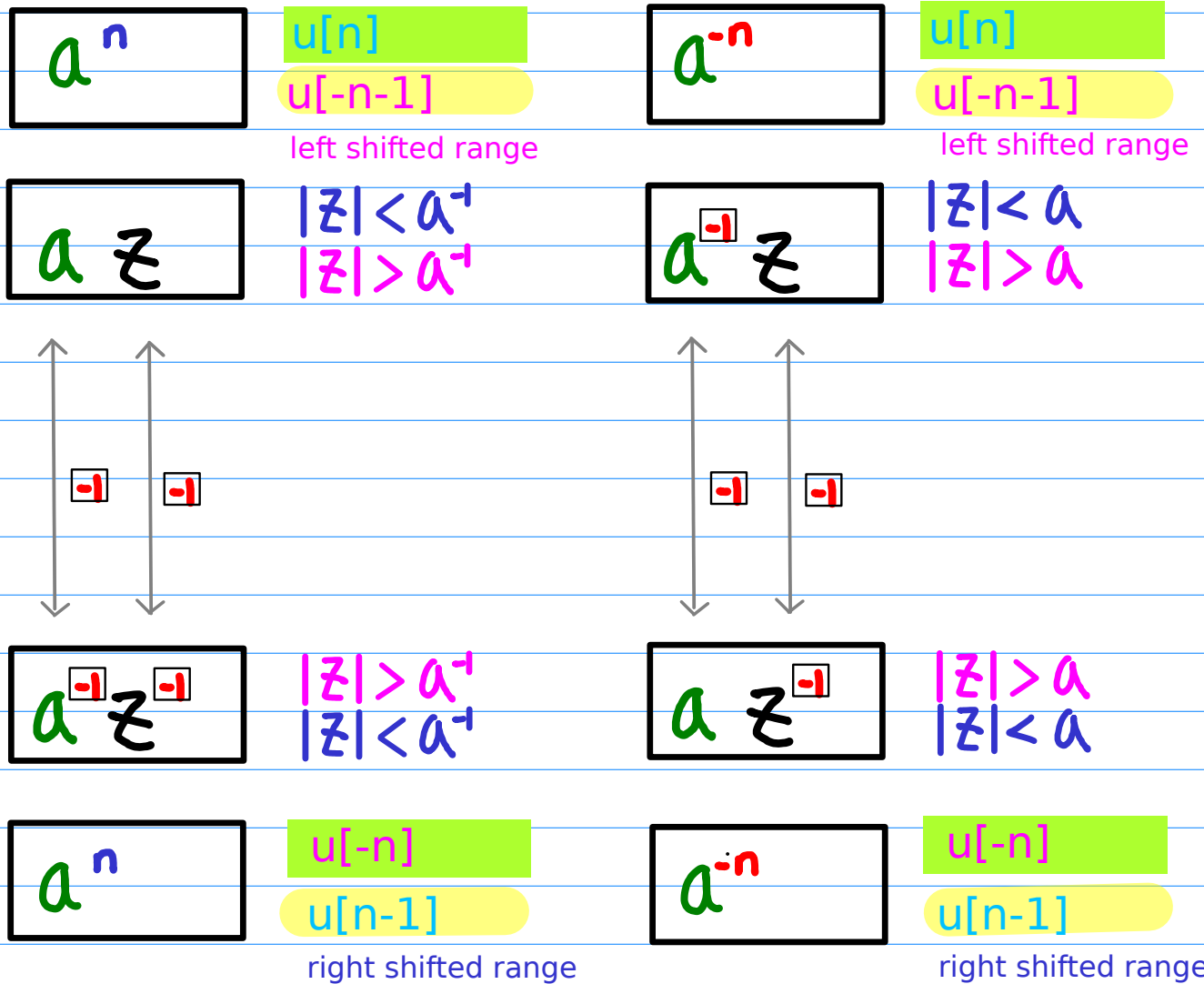

## Complementary Ranges

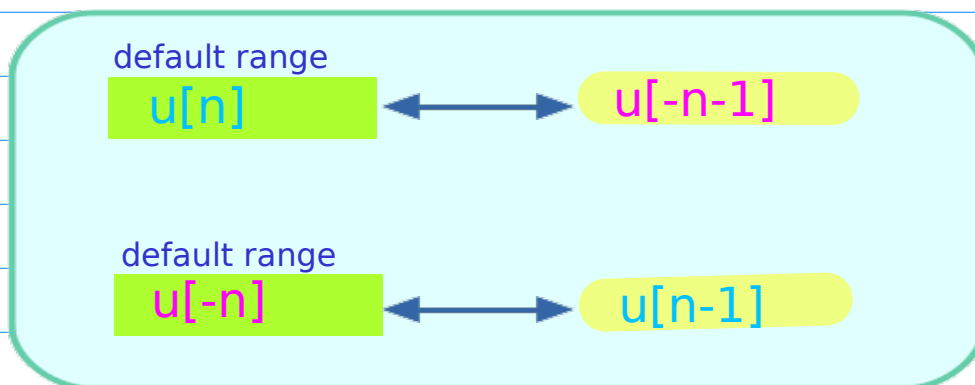

# A Common Ratio and a Symmetric Range

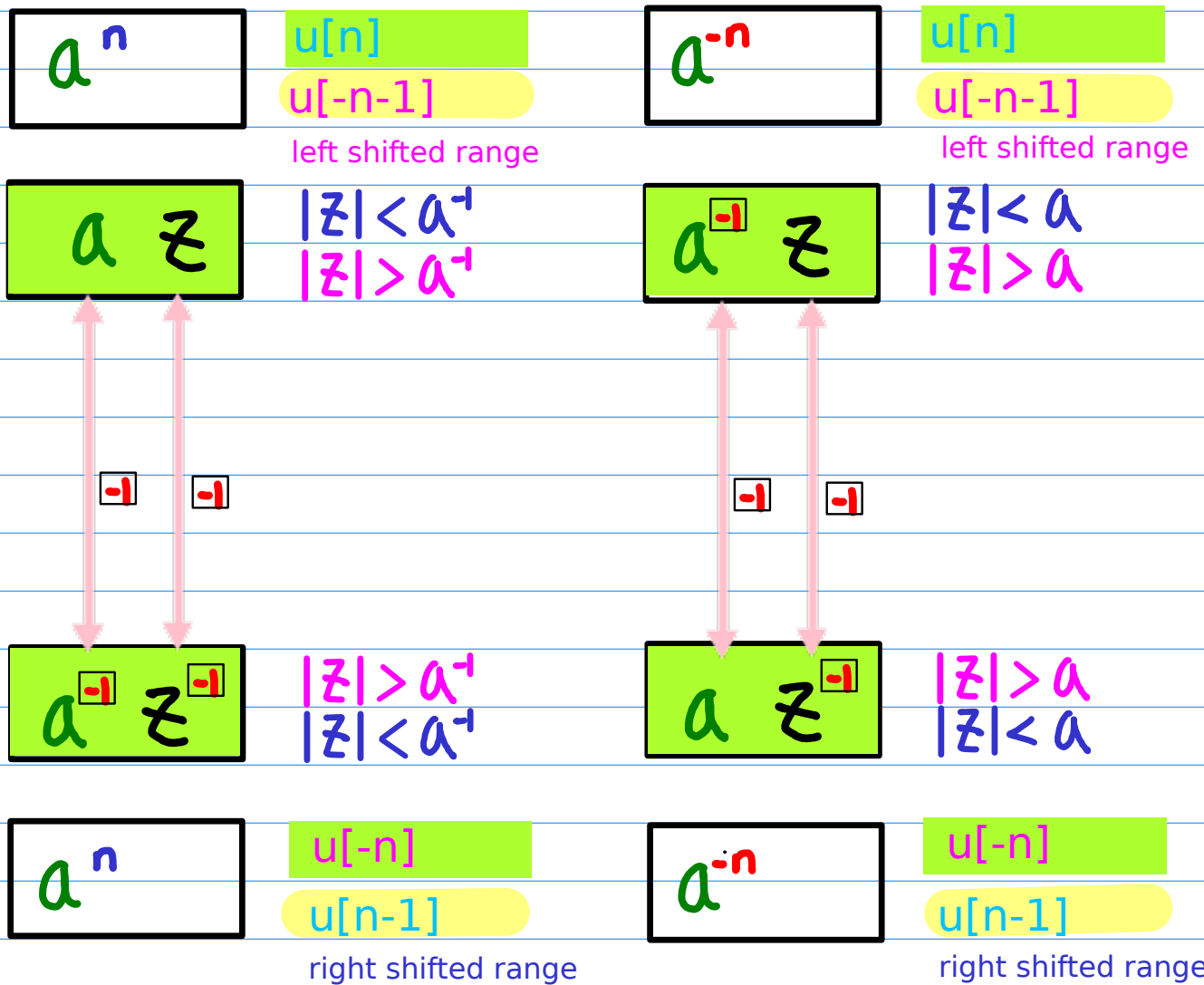

## Symmetric Ranges

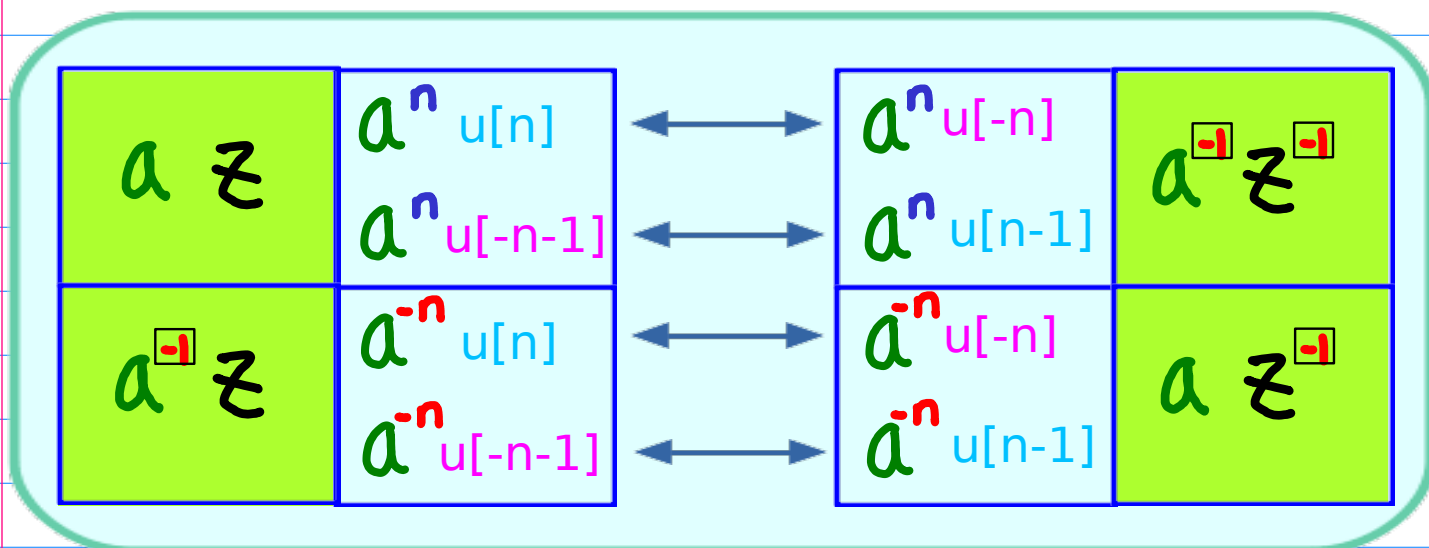

# Common Ratio and ROC

default

$$\star \frac{1}{(1 - az)}$$

complementary

$$\frac{a^{-1}z^{-1}}{(1 - a^{-1}z^{-1})}$$

default

$$\star \frac{1}{(1 - a^{-1}z)}$$

complementary

$$\frac{az^{-1}}{(1 - az^{-1})}$$

$$az$$

$$\begin{aligned} |z| < a^{-1} \\ |z| > a^{-1} \end{aligned}$$

$$a^{-1}z$$

$$\begin{aligned} |z| < a \\ |z| > a \end{aligned}$$

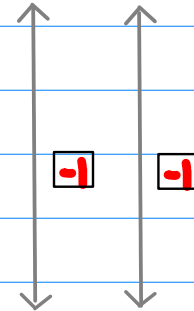
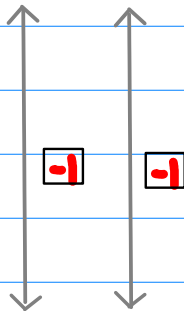

$$a^{-1}z^{-1}$$

$$\begin{aligned} |z| > a^{-1} \\ |z| < a^{-1} \end{aligned}$$

$$az^{-1}$$

$$\begin{aligned} |z| > a \\ |z| < a \end{aligned}$$

default

$$\star \frac{1}{(1 - a^{-1}z^{-1})}$$

complementary

$$\frac{az}{(1 - az)}$$

default

$$\star \frac{1}{(1 - az^{-1})}$$

complementary

$$\frac{a^{-1}z}{(1 - a^{-1}z)}$$

Each common ratio has two representations

Sequences

Each representation has its own ROC

Ranges

The two representations have complementary ROC's

complementary ROC's



# Common Ratio and ROC

$$1/1 = +1$$

★	$1 / (1 - a z)$	$ z  < a$	causal (z)	$a^n u[n]$	★ default range
	$a^{-1} z^{-1} / (1 - a^{-1} z^{-1})$	$ z  > a^{-1}$	anti-causal	$a^n u[-n-1]$	complementary

$$-1/-1 = +1$$

★	$1 / (1 - a^{-1} z^{-1})$	$ z  > a^{-1}$	anti-causal	$a^n u[-n]$	★ default range
	$a z / (1 - a z)$	$ z  < a$	causal (z)	$a^n u[n-1]$	complementary

$$1/1 = +1$$

$$-1/1 = -1$$

★	$1 / (1 - a^{-1} z)$	$ z  < a$	causal (z)	$a^{-n} u[n]$	★ default range
	$a z^{-1} / (1 - a z^{-1})$	$ z  > a$	anti-causal	$a^{-n} u[-n-1]$	complementary

$$1/-1 = -1$$

★	$1 / (1 - a z^{-1})$	$ z  > a$	anti-causal	$a^{-n} u[-n]$	★ default range
	$a^{-1} z / (1 - a^{-1} z)$	$ z  < a$	causal (z)	$a^{-n} u[n-1]$	complementary

$$1/-1 = -1$$

$$-1/1 = -1$$

# Common Ratio and ROC - Summary

ordered by complementary relation

$$\begin{aligned} \star & 1 / (1 - a z) & |z| < a^{-1} \\ a^{-1} z^{-1} / (1 - a^{-1} z^{-1}) & & |z| > a^{-1} \end{aligned}$$

$$\begin{aligned} a^n & u[n] \\ a^{-n} & u[-n-1] \end{aligned}$$

★ default range  
complementary

$$\begin{aligned} \star & 1 / (1 - a^{-1} z^{-1}) & |z| > a^{-1} \\ a z / (1 - a z) & & |z| < a^{-1} \end{aligned}$$

$$\begin{aligned} a^n & u[-n] \\ a^{-n} & u[n-1] \end{aligned}$$

★ default range  
complementary

$$\begin{aligned} \star & 1 / (1 - a^{-1} z) & |z| < a \\ a z^{-1} / (1 - a z^{-1}) & & |z| > a \end{aligned}$$

$$\begin{aligned} a^{-n} & u[n] \\ a^{-n} & u[-n-1] \end{aligned}$$

★ default range  
complementary

$$\begin{aligned} \star & 1 / (1 - a z^{-1}) & |z| > a \\ a^{-1} z / (1 - a^{-1} z) & & |z| < a \end{aligned}$$

$$\begin{aligned} a^{-n} & u[-n] \\ a^{-n} & u[n-1] \end{aligned}$$

★ default range  
complementary

# Common Ratio and ROC - Summary

ordered by symmetric relation

$$\begin{aligned} \star & 1 / (1 - a z) & |z| < a^{-1} \\ \star & 1 / (1 - a^{-1} z^{-1}) & |z| > a^{-1} \end{aligned}$$

$$\begin{aligned} a^n & u[n] \\ a^{-n} & u[-n] \end{aligned}$$

★ default range

★ default range

$$\begin{aligned} a^{-1} z^{-1} / (1 - a^{-1} z^{-1}) & |z| > a^{-1} \\ a z / (1 - a z) & |z| < a^{-1} \end{aligned}$$

$$\begin{aligned} a^{-n} & u[-n-1] \\ a^{-n} & u[n-1] \end{aligned}$$

complementary

complementary

$$\begin{aligned} \star & 1 / (1 - a^{-1} z) & |z| < a \\ \star & 1 / (1 - a z^{-1}) & |z| > a \end{aligned}$$

$$\begin{aligned} a^{-n} & u[n] \\ a^{-n} & u[-n] \end{aligned}$$

★ default range

★ default range

$$\begin{aligned} a z^{-1} / (1 - a z^{-1}) & |z| > a \\ a^{-1} z / (1 - a^{-1} z) & |z| < a \end{aligned}$$

$$\begin{aligned} a^{-n} & u[-n-1] \\ a^{-n} & u[n-1] \end{aligned}$$

complementary

complementary

# Common Ratio and ROC - Summary

ordered by shift relation

$$\begin{aligned} \star 1 &/ (1 - az) & |z| < a^{-1} \\ az &/ (1 - az) & |z| < a^{-1} \end{aligned}$$

$$\begin{aligned} a^n & u[n] \\ a^n & u[n-1] \end{aligned}$$

★ default range  
complementary

$$\begin{aligned} \star 1 &/ (1 - a^{-1}z^{-1}) & |z| > a^{-1} \\ a^{-1}z^{-1} &/ (1 - a^{-1}z^{-1}) & |z| > a^{-1} \end{aligned}$$

$$\begin{aligned} a^n & u[-n] \\ a^n & u[-n-1] \end{aligned}$$

★ default range  
complementary

$$\begin{aligned} \star 1 &/ (1 - a^{-1}z) & |z| < a \\ a^{-1}z &/ (1 - a^{-1}z) & |z| < a \end{aligned}$$

$$\begin{aligned} a^{-n} & u[n] \\ a^{-n} & u[n-1] \end{aligned}$$

★ default range  
complementary

$$\begin{aligned} \star 1 &/ (1 - az^{-1}) & |z| > a \\ az^{-1} &/ (1 - az^{-1}) & |z| > a \end{aligned}$$

$$\begin{aligned} a^{-n} & u[-n] \\ a^{-n} & u[-n-1] \end{aligned}$$

★ default range  
complementary

# Common Ratios and Representations

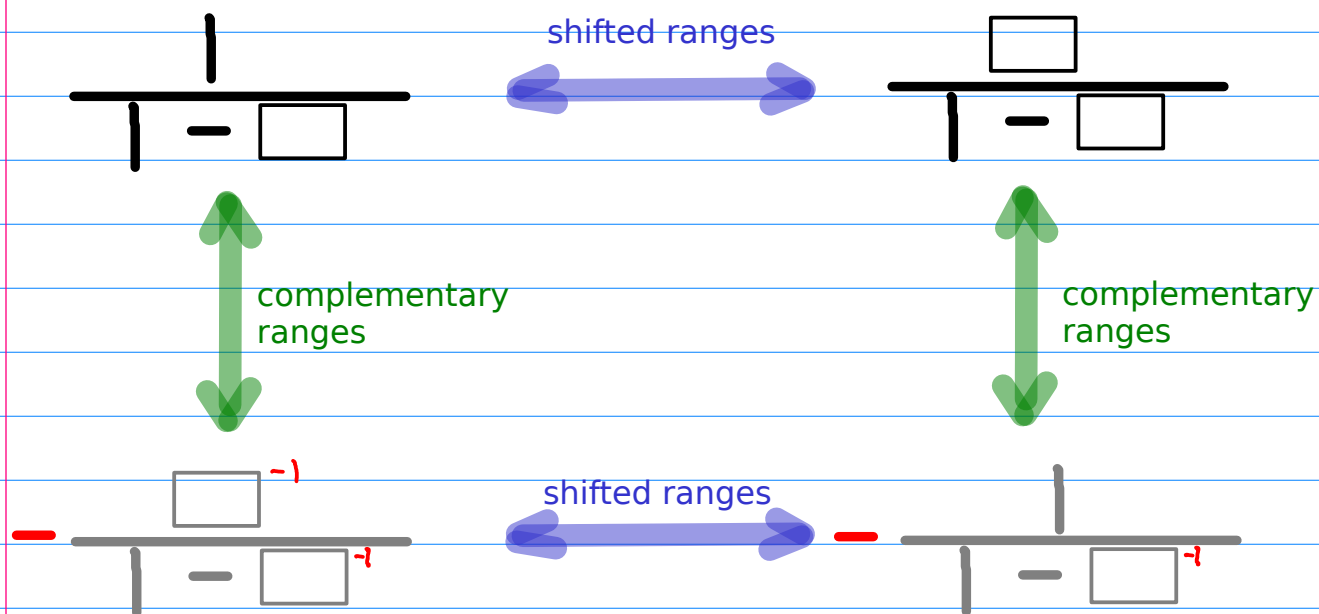

$a z$	$ z  < a^{-1}$
$a^{-1} z^{-1}$	$ z  > a^{-1}$
$a^{-1} z$	$ z  < a$
$a z^{-1}$	$ z  > a$

$$a z \quad |z| < a^{-1}$$

$$\frac{1}{1-az} = \frac{az}{1-az} - \frac{a^{-1}z^{-1}}{1-a^{-1}z^{-1}} - \frac{1}{1-a^{-1}z^{-1}}$$

Right Shifted

$u(n)$	$u(n-1)$
$u(-n-1)$	$u(-n)$

$$a^{-1} z^{-1} \quad |z| > a^{-1}$$

$$\frac{1}{1-a^{-1}z^{-1}} = \frac{a^{-1}z^{-1}}{1-a^{-1}z^{-1}} - \frac{az}{1-az} - \frac{1}{1-az}$$

Left Shifted

$u(-n)$	$u(-n-1)$
$u(n-1)$	$u(n)$

$$a^{-1} z \quad |z| < a$$

$$\frac{1}{1-a^{-1}z} = \frac{a^{-1}z}{1-a^{-1}z} - \frac{az^{-1}}{1-az^{-1}} - \frac{1}{1-az^{-1}}$$

Right Shifted

$u(n)$	$u(n-1)$
$u(-n-1)$	$u(-n)$

$$a z^{-1} \quad |z| > a$$

$$\frac{1}{1-az^{-1}} = \frac{az^{-1}}{1-az^{-1}} - \frac{a^{-1}z}{1-a^{-1}z} - \frac{1}{1-a^{-1}z}$$

Left Shifted

$u(-n)$	$u(-n-1)$
$u(n-1)$	$u(n)$

$a^n$

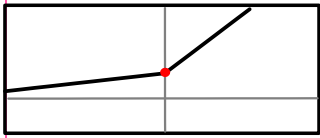

# Geometric Series Combinations (1)

\* inverted relation is ignored

Common Ratio

2 Geometric Series

2 Sequences

$$a z$$

$$\frac{1}{1 - a z} \quad |z| < a^{-1}$$

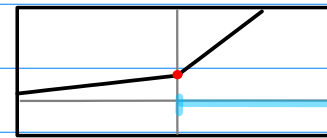

$$a^n u[n]$$

$a^n$

right shifted

$$\frac{a z}{1 - a z} \quad |z| < a^{-1}$$

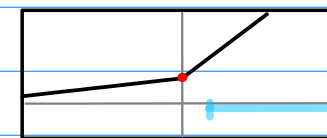

$$a^n u[n-1]$$

$a^n$

$$a z^{-1}$$

$$\frac{1}{1 - a^{-1} z^{-1}} \quad |z| > a^{-1}$$

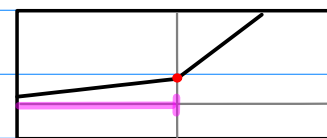

$$a^n u[-n]$$

$a^n$

left shifted

$$\frac{a^{-1} z^{-1}}{1 - a^{-1} z^{-1}} \quad |z| > a^{-1}$$

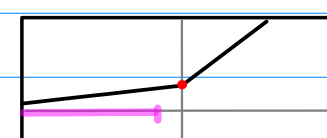

$$a^n u[-n-1]$$

$a^n$

$$a^n u[n]$$

$$\frac{1}{1 - az} \quad |z| < a^{-1}$$

$$a^{-n} u[n]$$

$$\frac{1}{1 - a^{-1}z} \quad |z| < a$$

$$a^n u[n-1]$$

$$\frac{az}{1 - az} \quad |z| < a^{-1}$$

$$a^{-n} u[n-1]$$

$$\frac{a^{-1}z}{1 - a^{-1}z} \quad |z| < a$$

$$a^n u[-n]$$

$$\frac{1}{1 - a^{-1}z^{-1}} \quad |z| > a^{-1}$$

$$a^{-n} u[-n]$$

$$\frac{1}{1 - az^{-1}} \quad |z| > a$$

$$a^n u[-n-1]$$

$$\frac{a^{-1}z^{-1}}{1 - a^{-1}z^{-1}} \quad |z| > a^{-1}$$

$$a^{-n} u[-n-1]$$

$$\frac{az^{-1}}{1 - az^{-1}} \quad |z| > a$$



$a^{-n}$

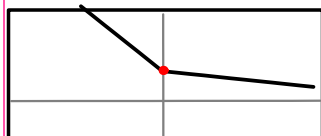

# Geometric Series Combinations (2)

\* inverted relation is ignored

Common Ratio

2 Geometric Series

2 Sequences

$$a^{-1} z$$

$$\frac{1}{1 - a^{-1}z} \quad |z| < a$$

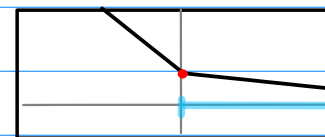

$$a^{-n} u[n]$$

$a^{-n}$

right shifted

$$\frac{a^{-1}z}{1 - a^{-1}z} \quad |z| < a$$

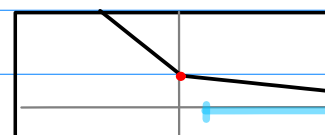

$$a^{-n} u[n-1]$$

$a^{-n}$

$$a z^{-1}$$

$$\frac{1}{1 - a z^{-1}} \quad |z| > a$$

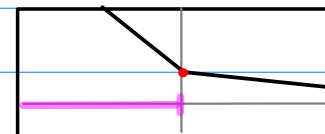

$$a^{-n} u[-n]$$

$a^{-n}$

left shifted

$$\frac{a z^{-1}}{1 - a z^{-1}} \quad |z| > a$$

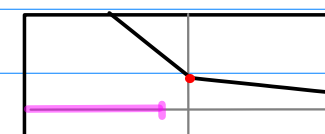

$$a^{-n} u[-n-1]$$

$a^{-n}$



# Shift Relations of Ranges

## Right Shifted Range Relation

$u[n]$

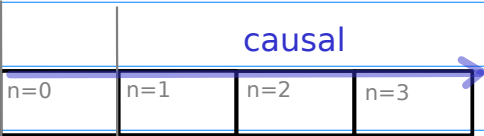

$u[n-1]$

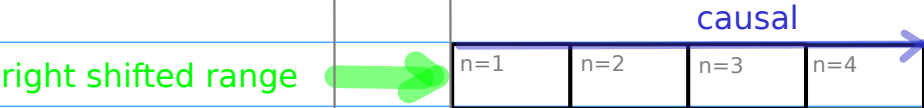

## Left Shifted Range Relation

$u[-n]$

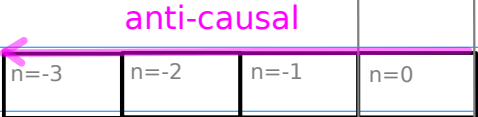

$u[-n-1]$

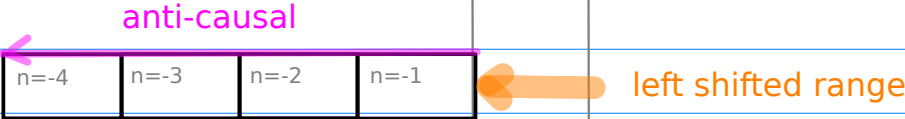

# Complementary Relations of Ranges

## Complementary Range Relation

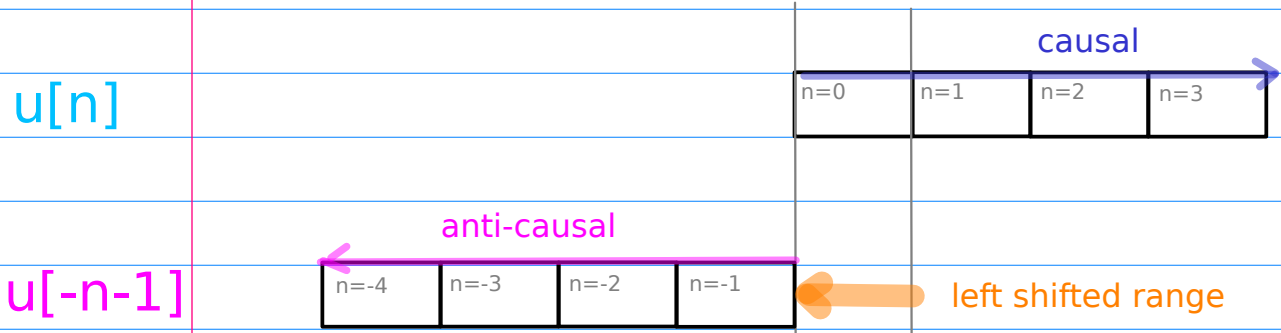

## Complementary Range Relation

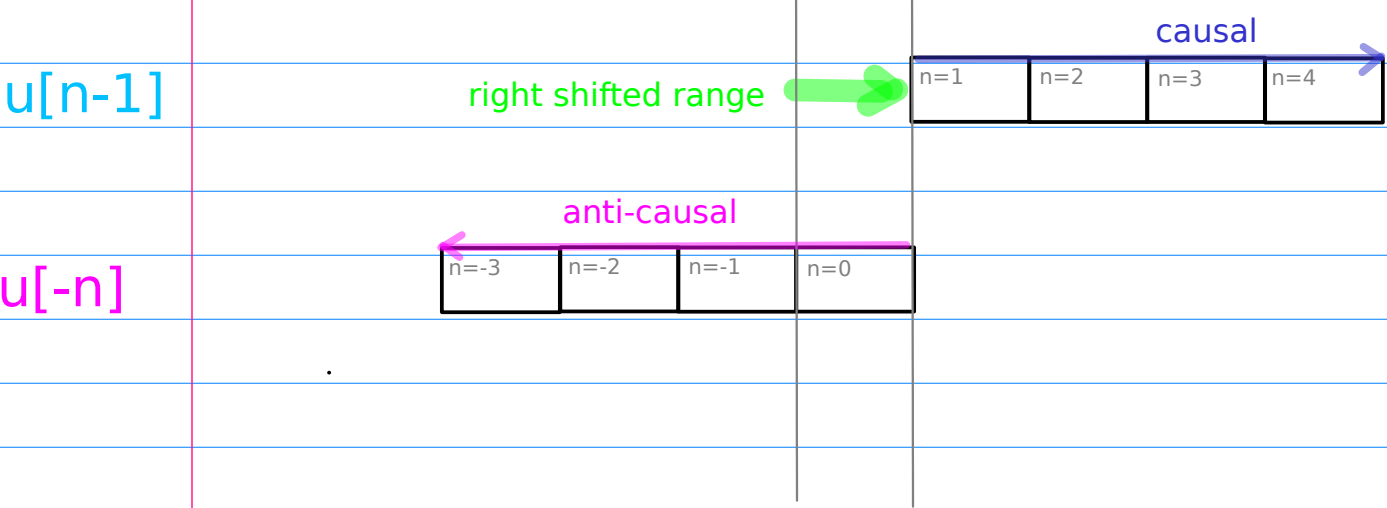

# [Complementary Range & Inverted Relation]

\* inverted relation is ignored

$$a z$$

$$\frac{1}{1 - a z} \quad |z| < a^{-1}$$

$$a^0 z^0 + a^1 z^1 + a^2 z^2 + \dots$$

$$a^n u[n]$$

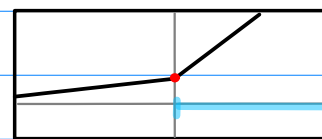

$$a^{-1} z^{-1}$$

$$\frac{a^1 z^1}{1 - a^1 z^1} \quad |z| > a^{-1}$$

$$a^1 z^{-1} + a^2 z^{-2} + a^3 z^{-3} + \dots$$

$$a^n u[-n-1]$$

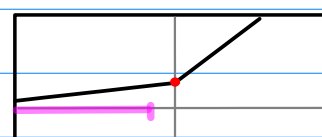

$$a^{-1} z^{-1}$$

$$\frac{1}{1 - a^{-1} z^{-1}} \quad |z| > a^{-1}$$

$$a^0 z^0 + a^1 z^1 + a^2 z^2 + \dots$$

$$a^n u[-n]$$

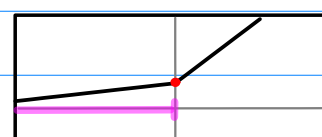

$$a z$$

$$\frac{a z}{1 - a z} \quad |z| < a^{-1}$$

$$a^1 z^1 + a^2 z^2 + a^3 z^3 + \dots$$

$$a^n u[n-1]$$

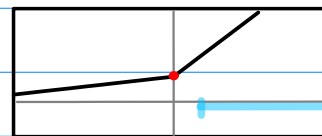

$$a^{-1} z^{-1}$$

$$\frac{1}{1 - a^{-1} z^{-1}} \quad |z| < a$$

$$a^0 z^0 + a^1 z^1 + a^2 z^2 + \dots$$

$$a^{-n} u[n]$$

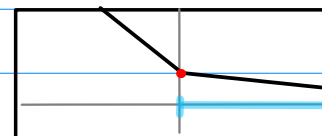

$$a z^{-1}$$

$$\frac{a z^1}{1 - a z^1} \quad |z| > a$$

$$a^1 z^{-1} + a^2 z^{-2} + a^3 z^{-3} + \dots$$

$$a^{-n} u[-n-1]$$

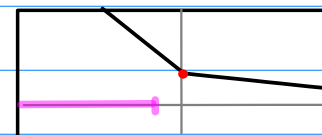

$$a z^{-1}$$

$$\frac{1}{1 - a z^{-1}} \quad |z| > a$$

$$a^0 z^0 + a^1 z^1 + a^2 z^2 + \dots$$

$$a^{-n} u[n-1]$$

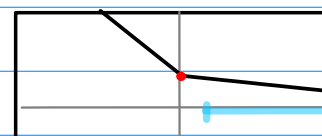

$$a^{-1} z$$

$$\frac{a^1 z}{1 - a^1 z} \quad |z| < a$$

$$a^1 z^{-1} + a^2 z^{-2} + a^3 z^{-3} + \dots$$

$$a^{-n} u[-n]$$

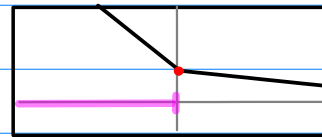

# [Shifted Range Relation]

\* inverted relation is ignored

$$a z$$

$$\frac{1}{1 - a z} \quad |z| < a^{-1}$$

$$a^0 z^0 + a^1 z^1 + a^2 z^2 + \dots$$

$$a^n u[n]$$

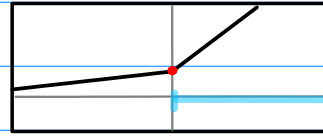

$$a z$$

$$\frac{a z}{1 - a z} \quad |z| < a^{-1}$$

$$a^1 z^1 + a^2 z^2 + a^3 z^3 + \dots$$

$$a^n u[n-1]$$

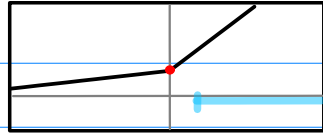

$$a^{-1} z^{-1}$$

$$\frac{1}{1 - a^{-1} z^{-1}} \quad |z| > a^{-1}$$

$$a^0 z^0 + a^{-1} z^{-1} + a^{-2} z^{-2} + \dots$$

$$a^n u[-n]$$

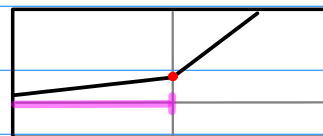

$$a^{-1} z^{-1}$$

$$\frac{a^{-1} z^{-1}}{1 - a^{-1} z^{-1}} \quad |z| > a^{-1}$$

$$a^1 z^1 + a^2 z^2 + a^3 z^3 + \dots$$

$$a^n u[-n-1]$$

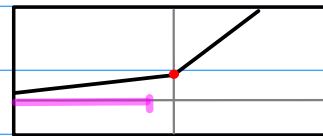

$$a^{-1} z$$

$$\frac{1}{1 - a^{-1} z} \quad |z| < a$$

$$a^0 z^0 + a^{-1} z^1 + a^{-2} z^2 + \dots$$

$$a^{-n} u[n]$$

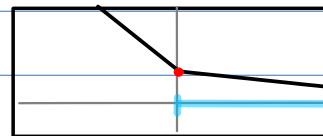

$$a^{-1} z$$

$$\frac{a^{-1} z}{1 - a^{-1} z} \quad |z| < a$$

$$a^1 z^1 + a^2 z^2 + a^3 z^3 + \dots$$

$$a^{-n} u[n-1]$$

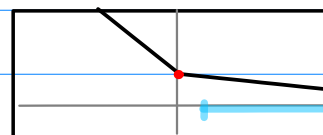

$$a z^{-1}$$

$$\frac{1}{1 - a z^{-1}} \quad |z| > a$$

$$a^0 z^0 + a^1 z^{-1} + a^2 z^{-2} + \dots$$

$$a^{-n} u[-n]$$

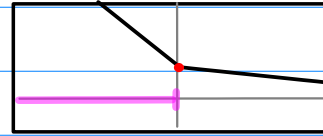

$$a z^{-1}$$

$$\frac{a z^{-1}}{1 - a z^{-1}} \quad |z| > a$$

$$a^1 z^1 + a^2 z^2 + a^3 z^3 + \dots$$

$$a^{-n} u[-n-1]$$

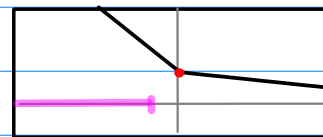

each formula has two geometric series  
 - two common ratios with inversed relation

$$a z$$

$$\frac{1}{1 - a z} \quad |z| < a^{-1}$$

$$a^n u[n]$$

Complementary Ranges

$$a^{-1} z^{-1}$$

$$-\frac{a^{-1} z^{-1}}{1 - a^{-1} z^{-1}} \quad |z| > a^{-1}$$

$$-a^n u[-n-1]$$

$$a^{-1} z^{-1}$$

$$\frac{1}{1 - a^{-1} z^{-1}} \quad |z| > a^{-1}$$

$$a^n u[-n]$$

Complementary Ranges

$$a z$$

$$-\frac{a z}{1 - a z} \quad |z| < a^{-1}$$

$$-a^n u[n-1]$$

$$a^{-1} z$$

$$\frac{1}{1 - a^{-1} z} \quad |z| < a$$

$$a^{-n} u[n]$$

Complementary Ranges

$$a z^{-1}$$

$$-\frac{a z^{-1}}{1 - a z^{-1}} \quad |z| > a$$

$$-a^{-n} u[-n-1]$$

$$a z^{-1}$$

$$\frac{1}{1 - a z^{-1}} \quad |z| > a$$

$$a^{-n} u[-n]$$

Complementary Ranges

$$a^{-1} z$$

$$-\frac{a^{-1} z}{1 - a^{-1} z} \quad |z| < a$$

$$-a^{-n} u[n-1]$$

each common ratio is associated with 2 different sequences (representations)

$$a z$$

$$\frac{1}{1 - a z} \quad |z| < a^{-1}$$

$$a^n u[n]$$

Shifted Ranges

$$a z$$

$$- \frac{a z}{1 - a z} \quad |z| < a^{-1}$$

$$- a^n u[n-1]$$

$$a z^{-1}$$

$$\frac{1}{1 - a^{-1} z^{-1}} \quad |z| > a^{-1}$$

$$a^n u[-n]$$

Shifted Ranges

$$a z^{-1}$$

$$- \frac{a^{-1} z^{-1}}{1 - a^{-1} z^{-1}} \quad |z| > a^{-1}$$

$$- a^n u[-n-1]$$

$$a^{-1} z$$

$$\frac{1}{1 - a^{-1} z} \quad |z| < a$$

$$a^{-n} u[n]$$

Shifted Ranges

$$a^{-1} z$$

$$- \frac{a^{-1} z}{1 - a^{-1} z} \quad |z| < a$$

$$- a^{-n} u[n-1]$$

$$a z^{-1}$$

$$\frac{1}{1 - a z^{-1}} \quad |z| > a$$

$$a^{-n} u[-n]$$

Shifted Ranges

$$a z^{-1}$$

$$- \frac{a z^{-1}}{1 - a z^{-1}} \quad |z| > a$$

$$- a^{-n} u[-n-1]$$



