

BJT Topologies - Basic Bias

Copyright (c) 2012 - 2017 Young W. Lim.

Permission is granted to copy, distribute and/or modify this document under the terms of the GNU Free Documentation License, Version 1.2 or any later version published by the Free Software Foundation; with no Invariant Sections, no Front-Cover Texts, and no Back-Cover Texts. A copy of the license is included in the section entitled "GNU Free Documentation License".

Please send corrections (or suggestions) to youngwlim@hotmail.com.

This document was produced by using OpenOffice and Octave.

BJT Amplifier Topologies

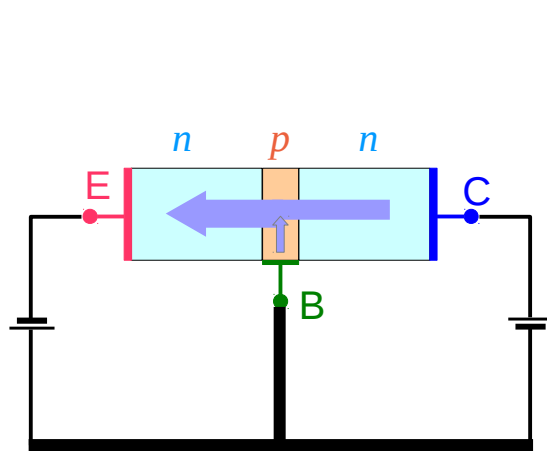

Common Base

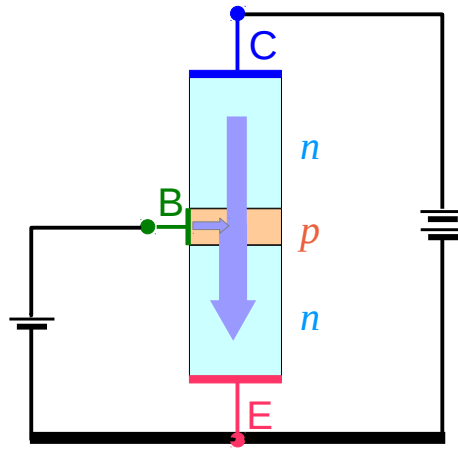

Common Emitter

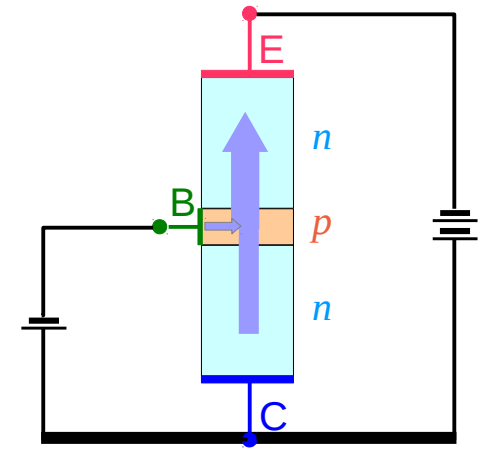

Common Collector

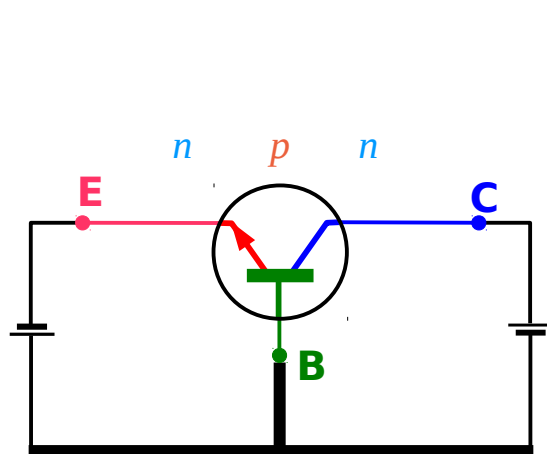

Common Base

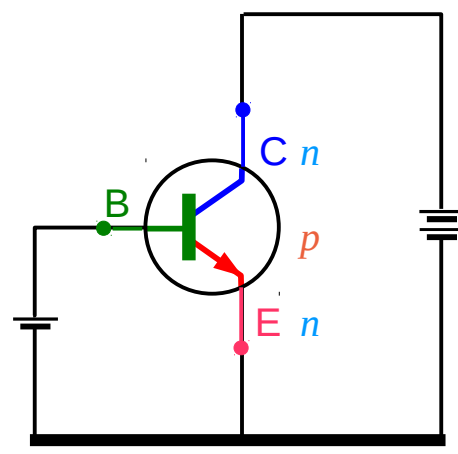

Common Emitter

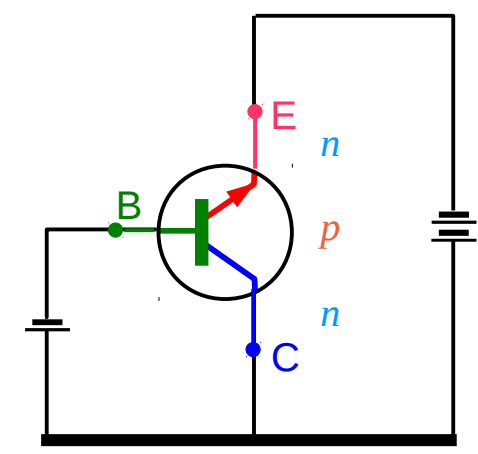

Common Collector

Common Base Topology

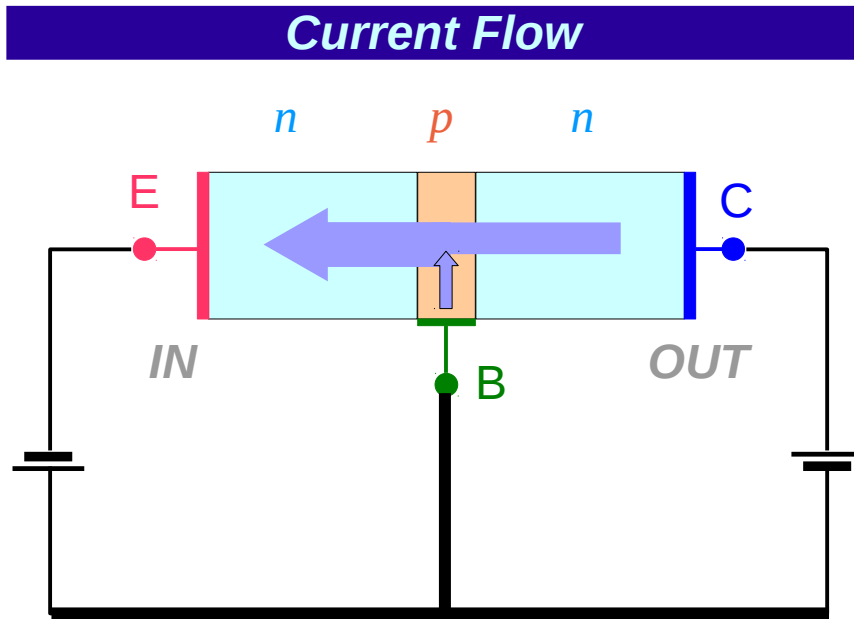

Common Base

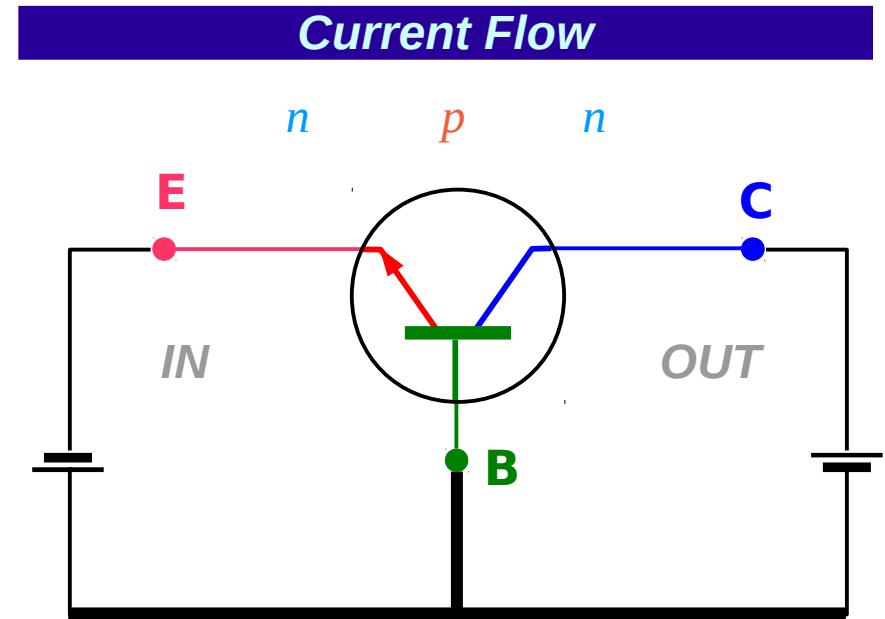

Common Base

Common Emitter Topology

Current Flow

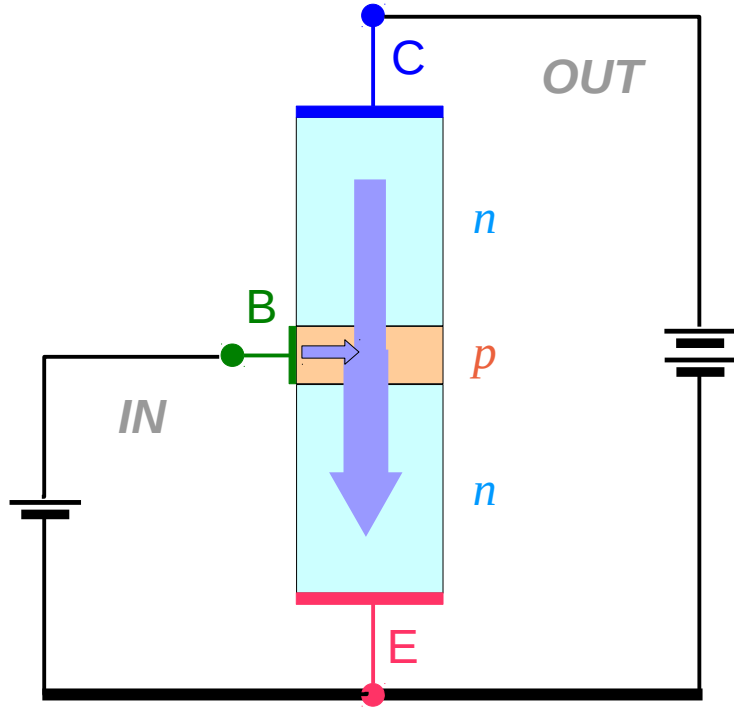

Common Emitter

Current Flow

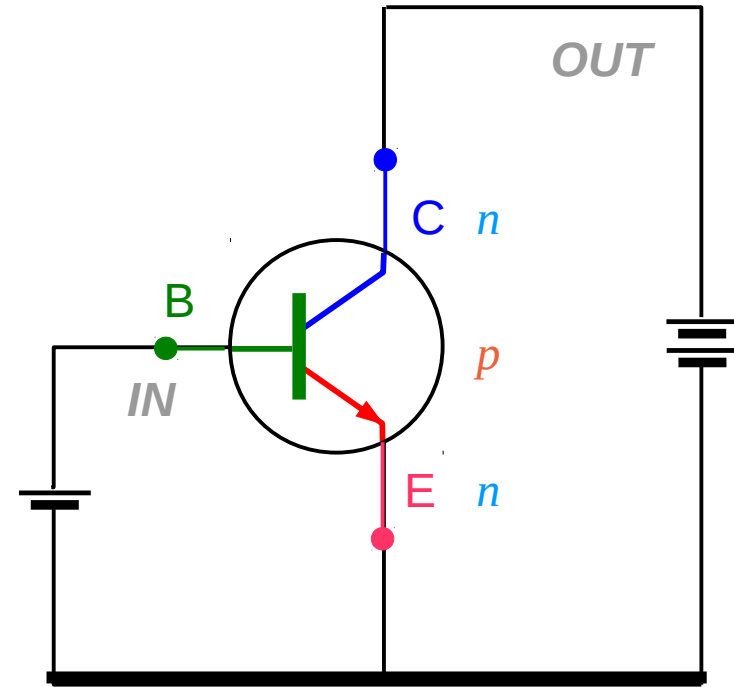

Common Emitter

Common Collector Topology

Current Flow

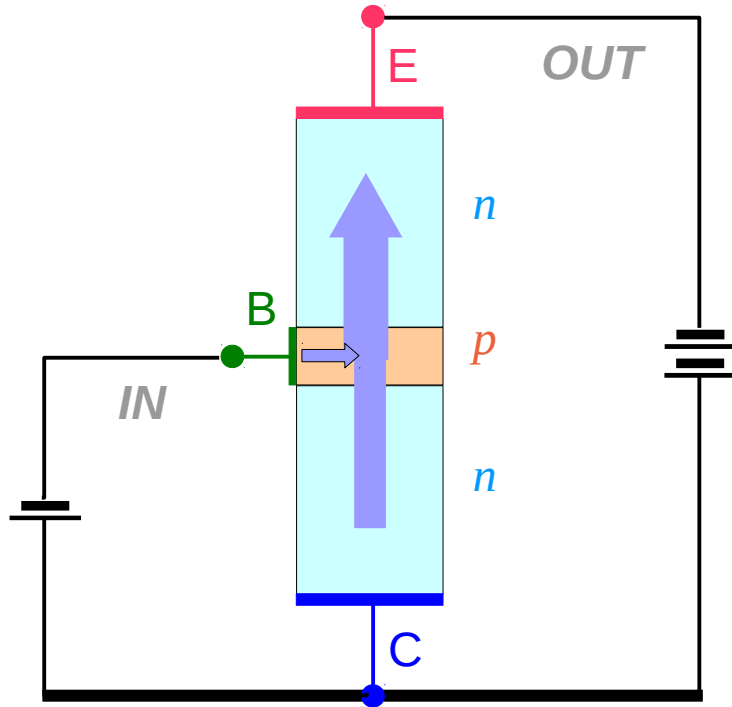

Common Collector

Current Flow

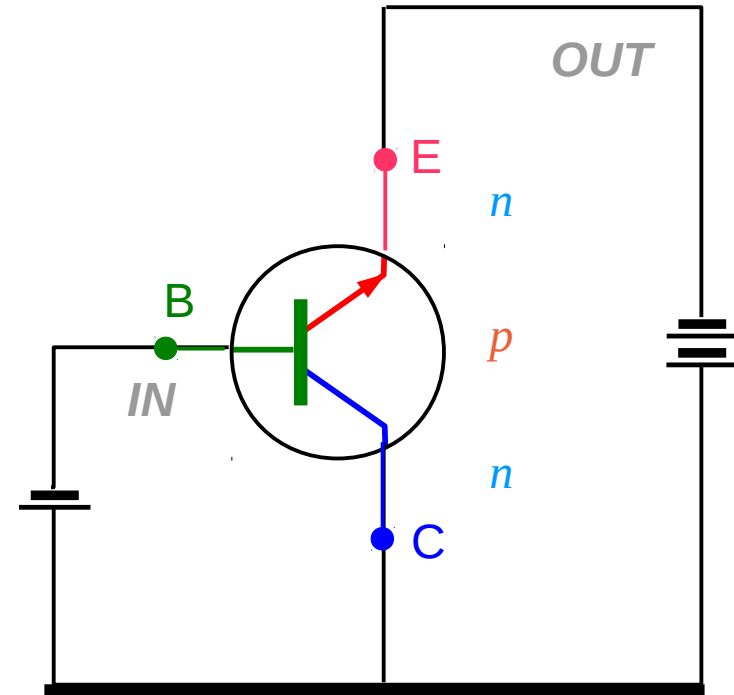

Common Collector

Forward bias (BE) & Reverse bias (CB)

Common Base

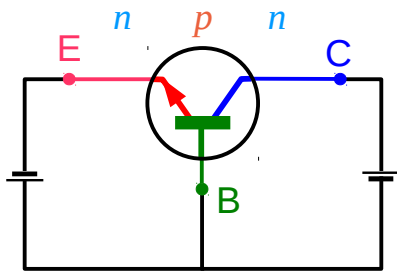

Common Emitter

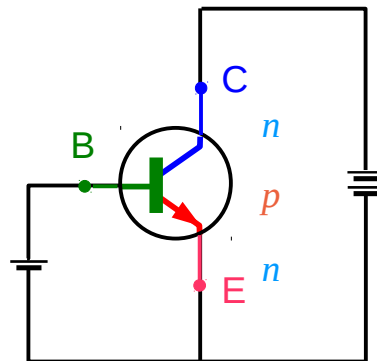

Common Collector

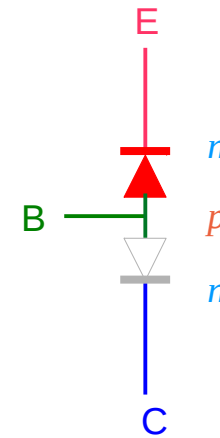
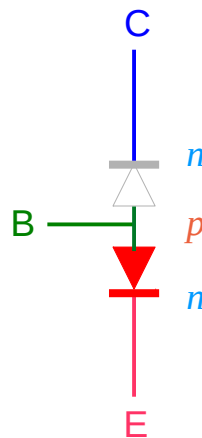
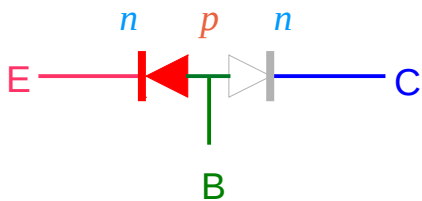
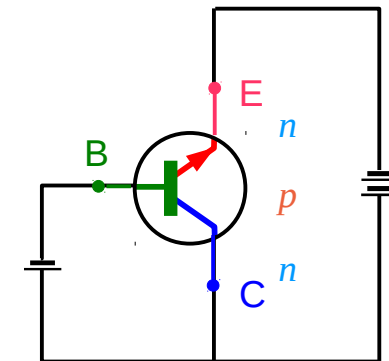

V_{BE} forward bias
 V_{CB} reverse bias

==

V_{BE} forward bias
 V_{CB} reverse bias

==

V_{BE} forward bias
 V_{CB} reverse bias

Bias for Active Region

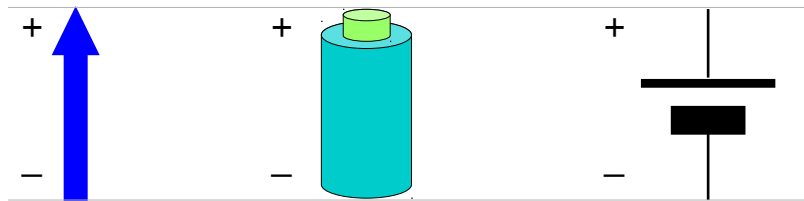

Common Base

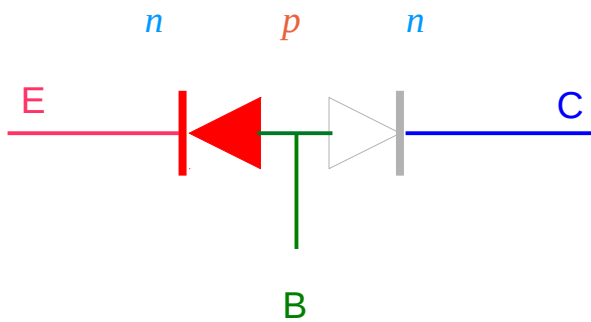

Common Emitter

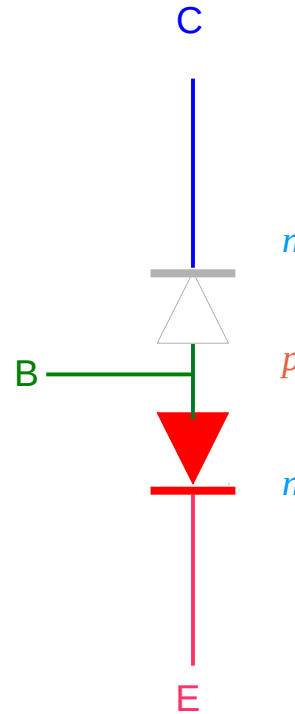

Common Collector

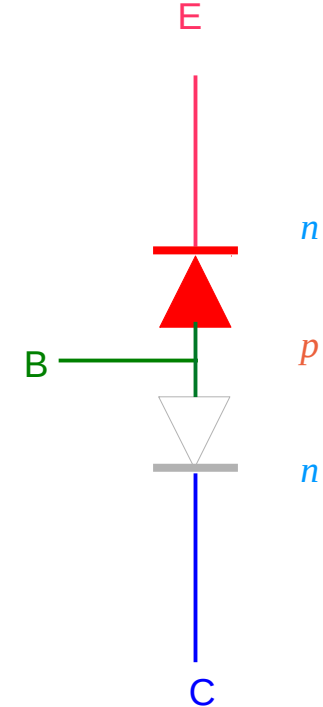

V_{BE} forward bias
 V_{CB} reverse bias

Active region

==

V_{BE} forward bias
 V_{CB} reverse bias

Active region

==

V_{BE} forward bias
 V_{CB} reverse bias

Active region

Common Base

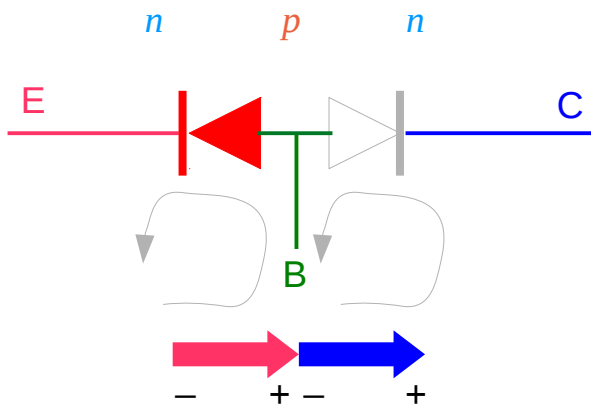

V_{BE} forward bias
 V_{CB} reverse bias

Active region

Common Emitter

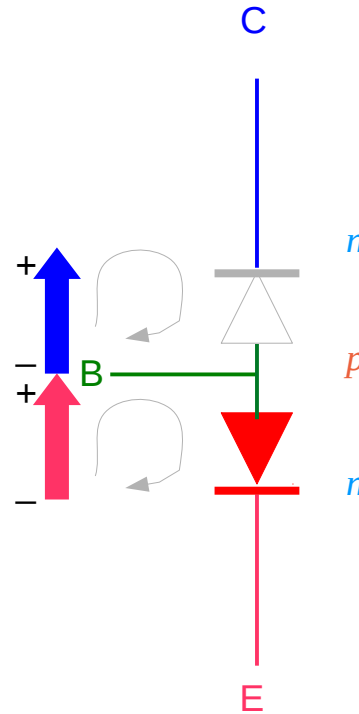

V_{BE} forward bias
 V_{CB} reverse bias

Active region

Common Collector

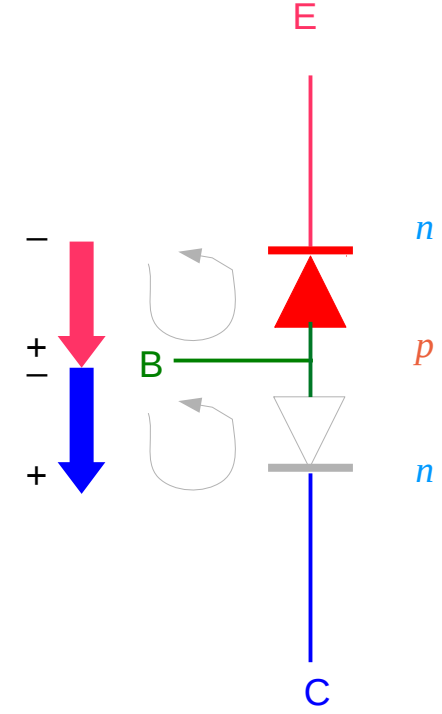

V_{BE} forward bias
 V_{CB} reverse bias

Active region

Polarities of Two voltage supplies

Active Region

Common Base

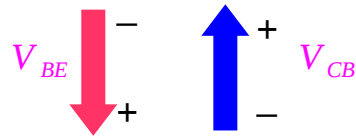
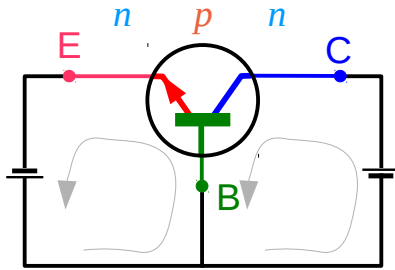

V_{BE} forward bias
 V_{CB} reverse bias

Active region

Common Emitter

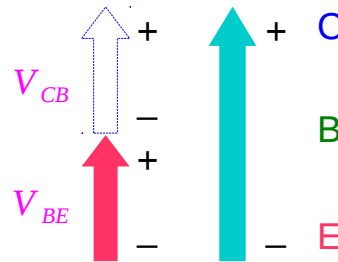
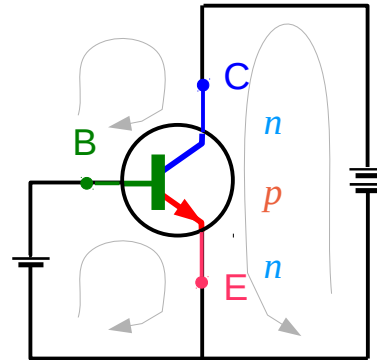

V_{BE} forward bias
 V_{CB} reverse bias

Active region

Common Collector

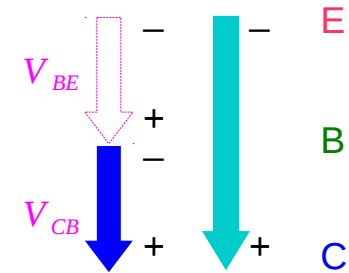
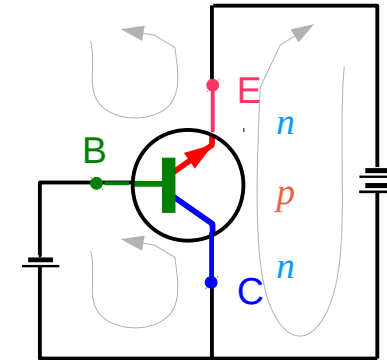

V_{BE} forward bias
 V_{CB} reverse bias

Active region

Two voltage supplies Bias

Active Region

Common Base

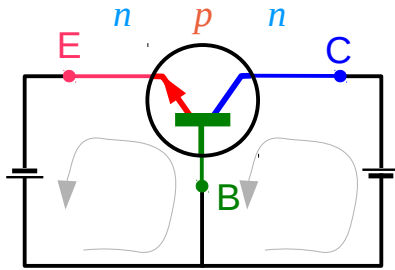

Common Emitter

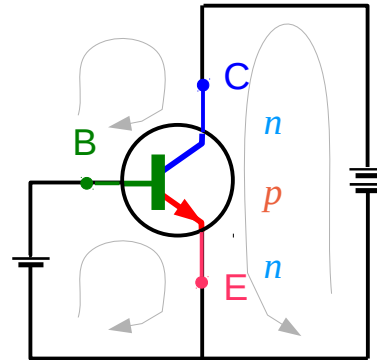

Common Collector

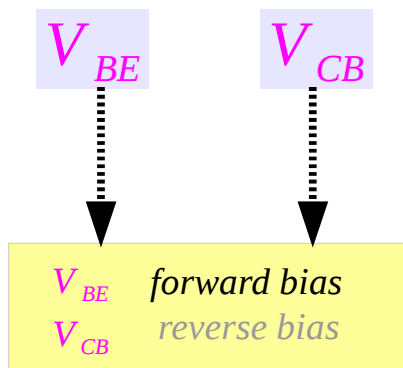
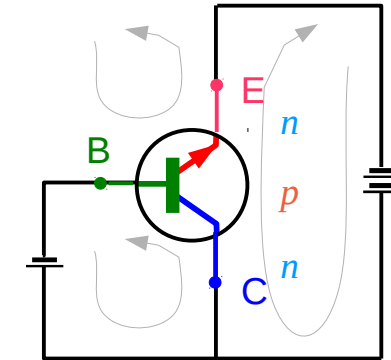

Active region

=

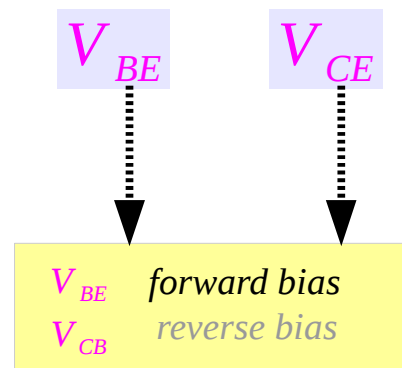

Active region

=

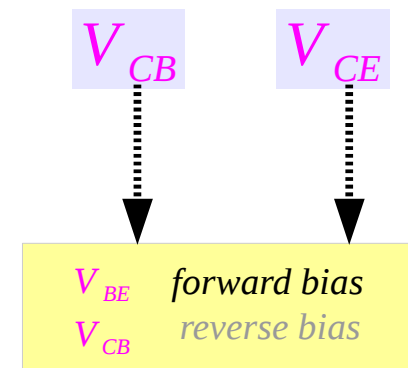

Active region

Common Base

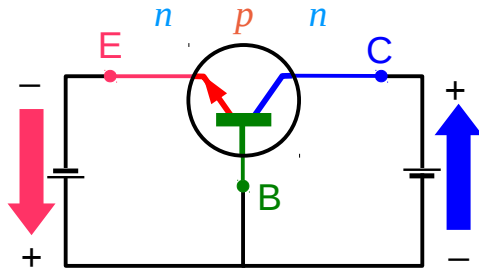

Direct Control

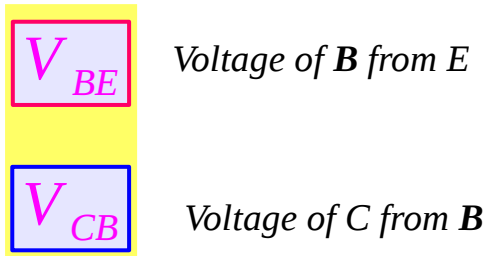

Common Emitter

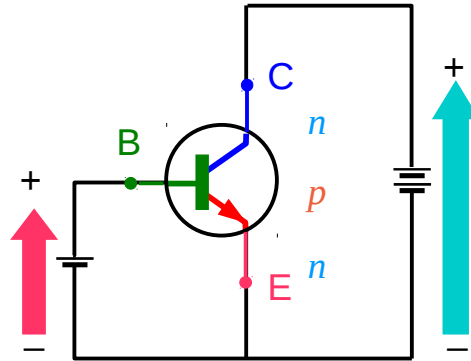

Indirect Control

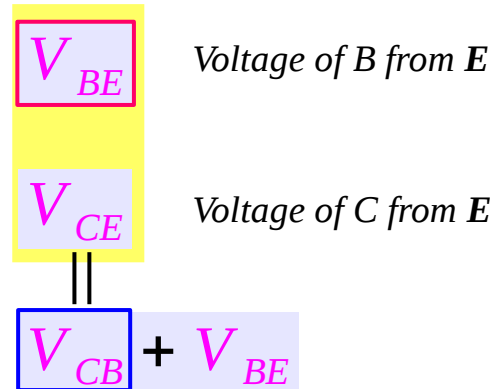

Common Collector

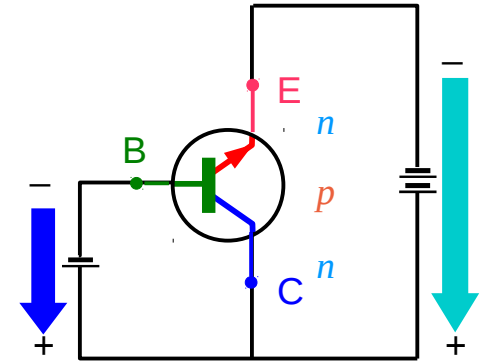

Indirect Control

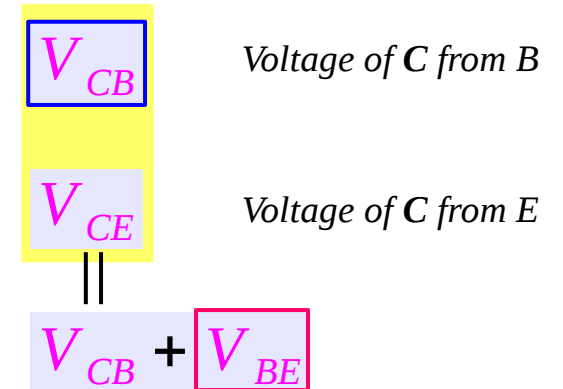

Input Characteristics

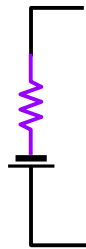
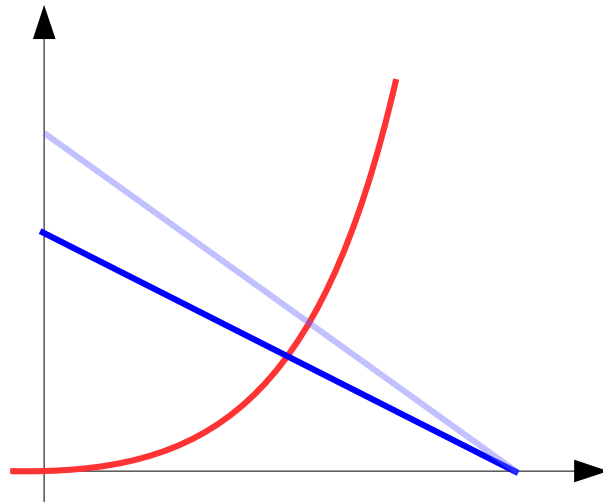

Output Characteristics

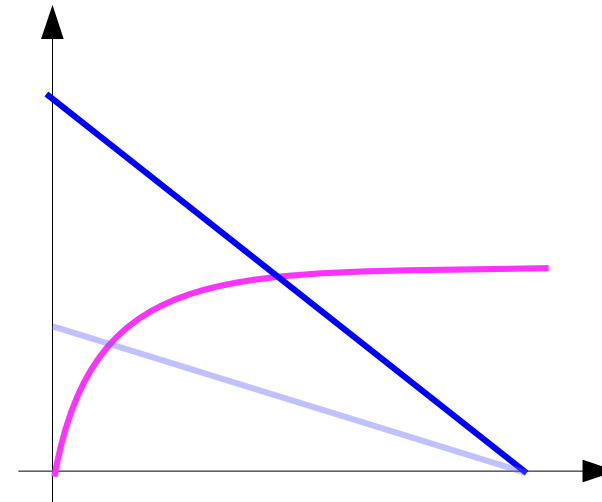

Two Voltage Sources

Active Region

Common Base

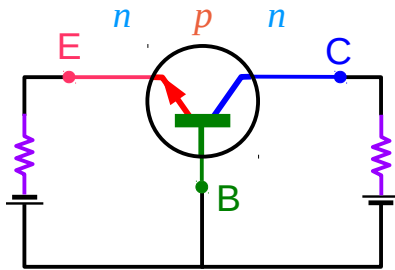

Common Emitter

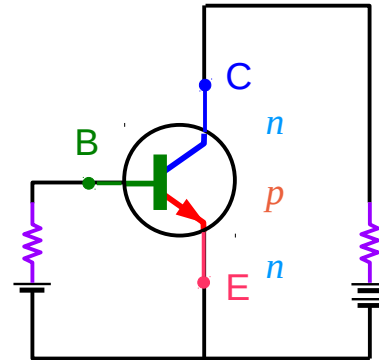

Common Collector

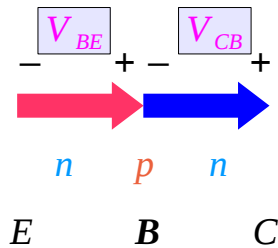
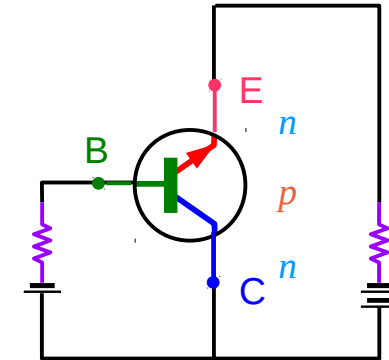

Active region

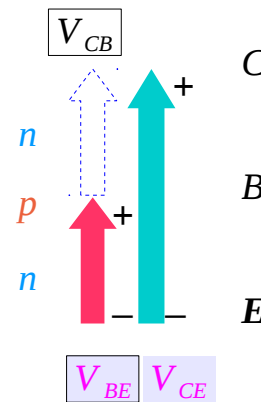

Active region

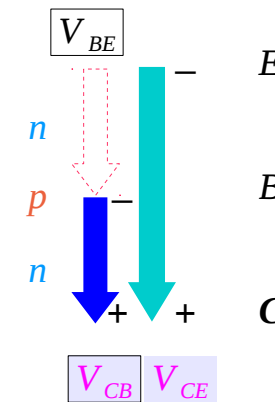

Active region

Common Emitter

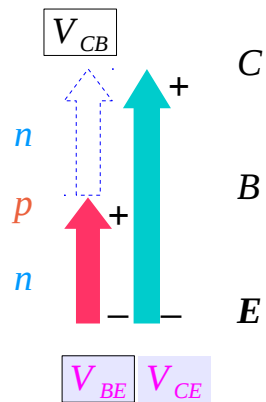
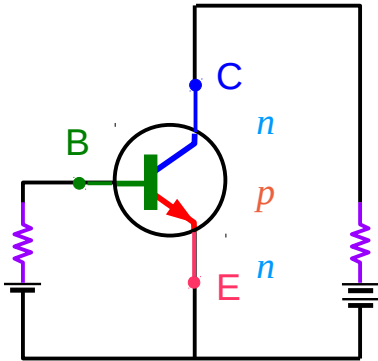

Active region

Common Collector 2

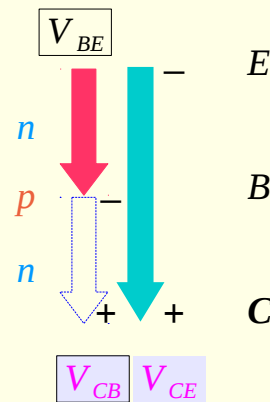
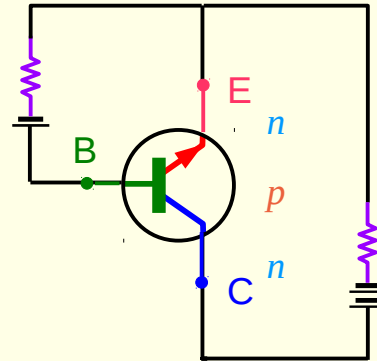

Active region

Common Collector

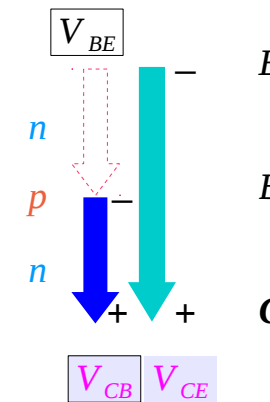
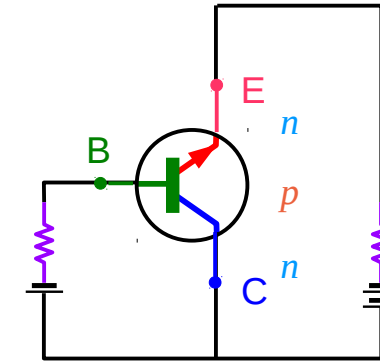

Active region

Bias for Saturation Region

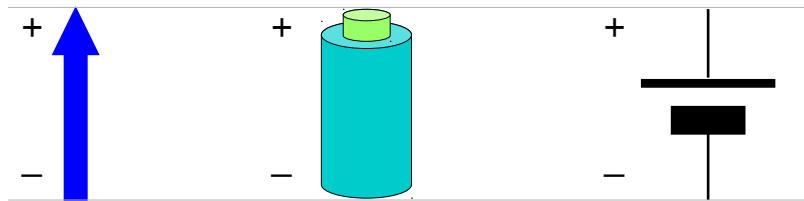

Biassing Back-to-back Diodes - Saturation Region

Common Base

Common Emitter

Common Collector

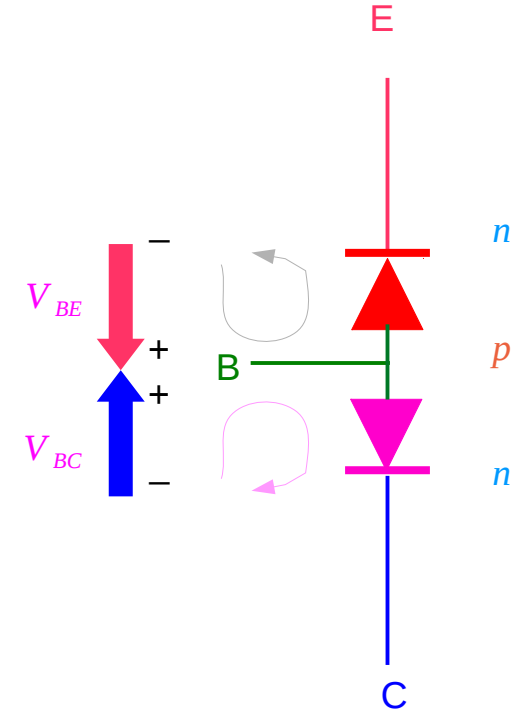
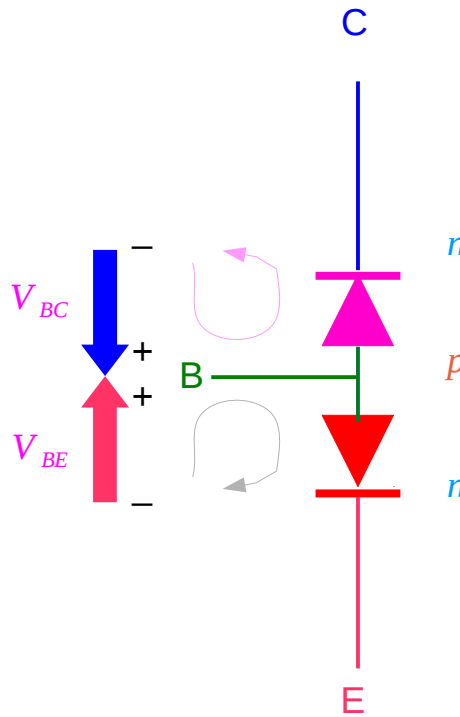
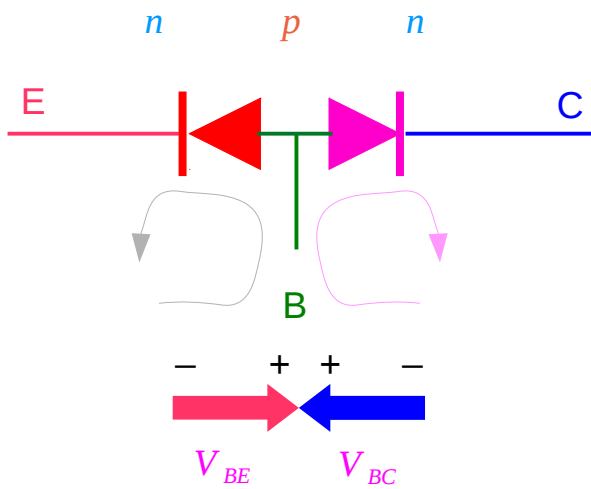

V_{BE} forward bias
 V_{BC} forward bias

==

V_{BE} forward bias
 V_{BC} forward bias

==

V_{BE} forward bias
 V_{BC} forward bias

saturation

saturation

saturation

Two voltage supplies - Saturation Region

Common Base

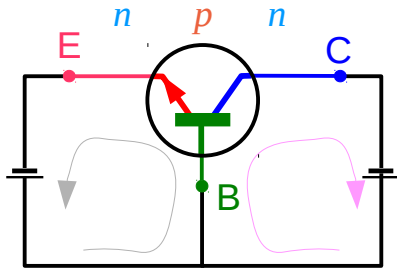

V_{BE} V_{BC}

V_{BE} forward bias
 V_{BC} forward bias

saturation

Common Emitter

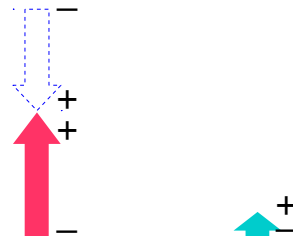
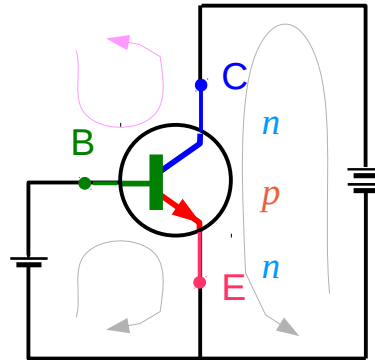

V_{BE} V_{CE}

V_{BE} forward bias
 V_{BC} forward bias

saturation

Common Collector

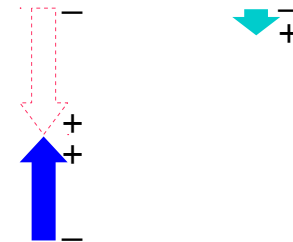
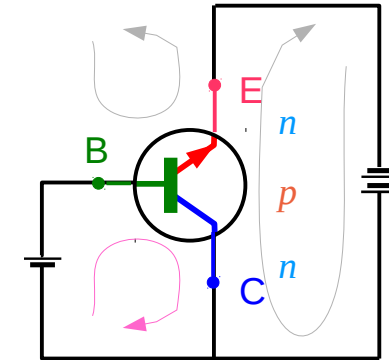

V_{BC} V_{EC}

V_{BE} forward bias
 V_{BC} forward bias

saturation

Two voltage supplies with resistors - Sat Region

Common Base

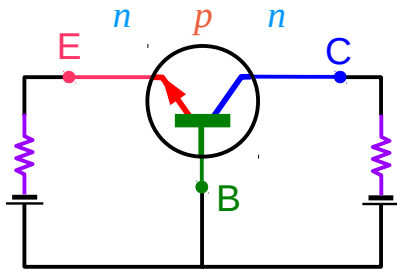

Common Emitter

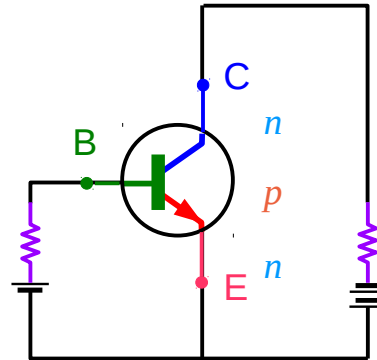

Common Collector

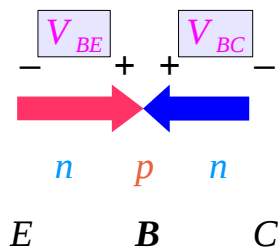
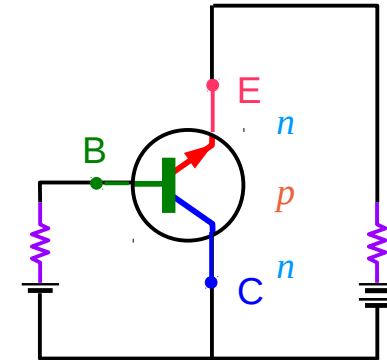

saturation

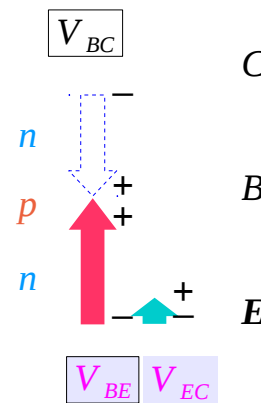

saturation

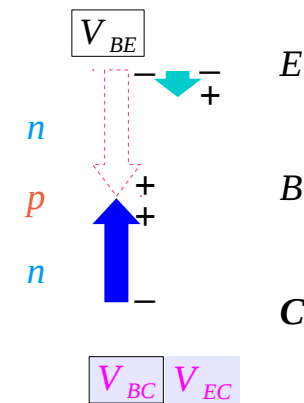

saturation

CE & CC Comparison - Saturation Region

Common Emitter

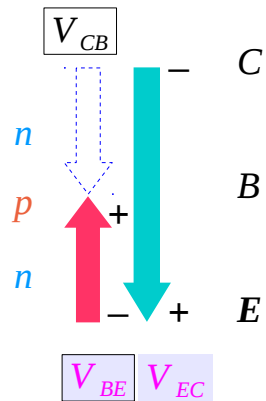
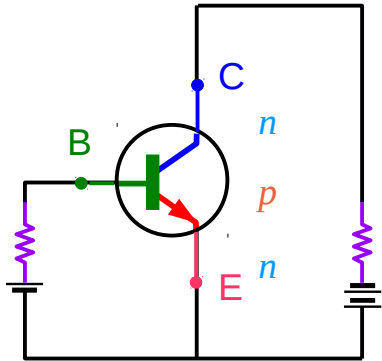

saturation

Common Collector 2

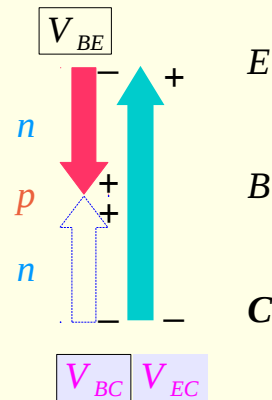
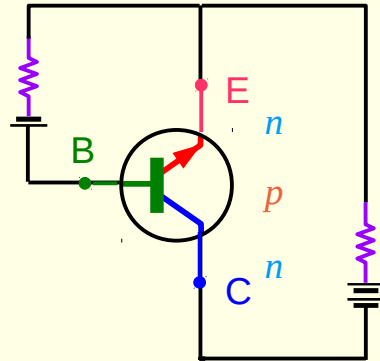

saturation

Common Collector

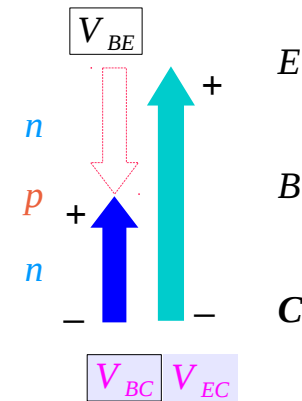
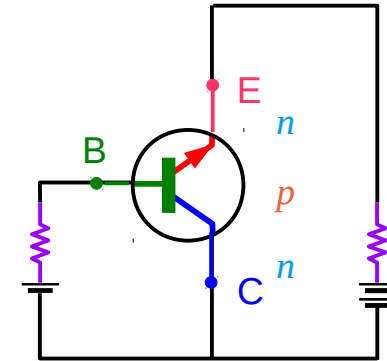

saturation

Active and Saturation Regions (1)

Common Base

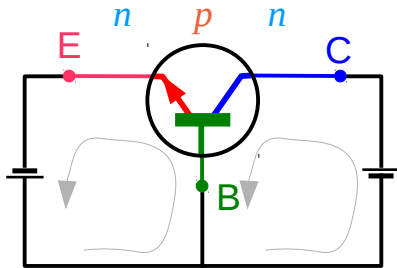

active

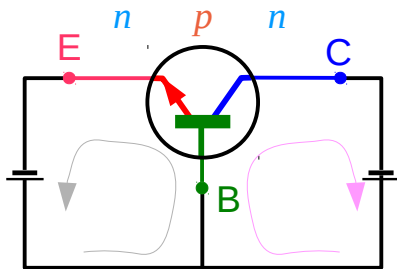

saturation

Common Emitter

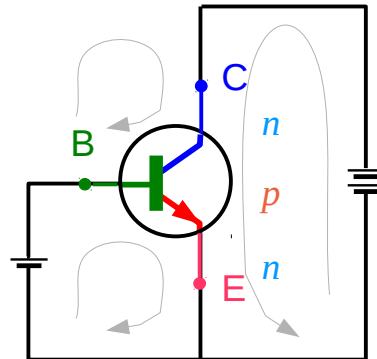

active

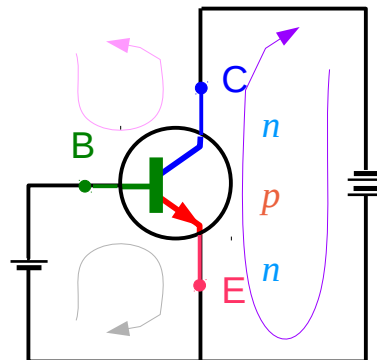

saturation

Common Collector

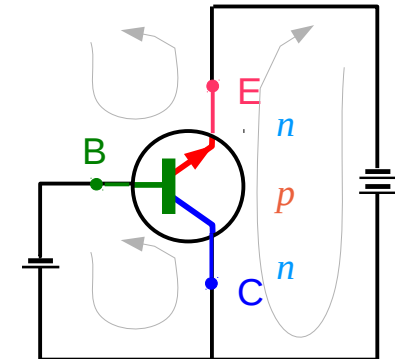

active

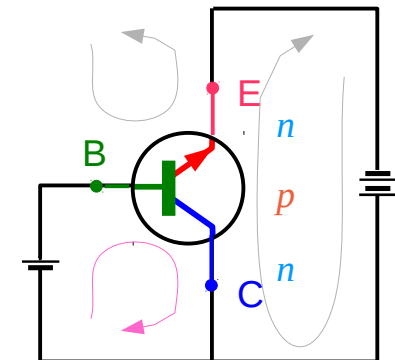

saturation

Active and Saturation Regions (2)

Common Base

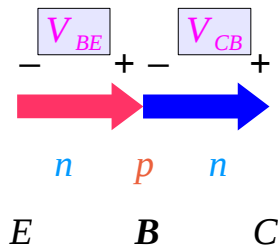

active

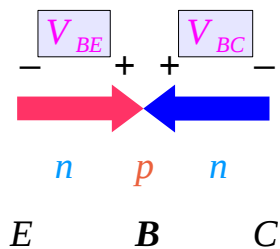

saturation

Common Emitter

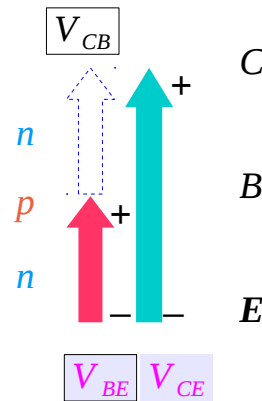

active

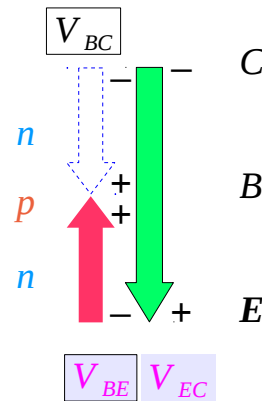

saturation

Common Collector

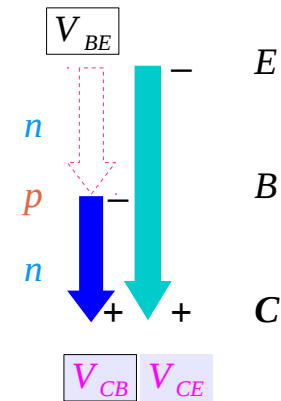

active

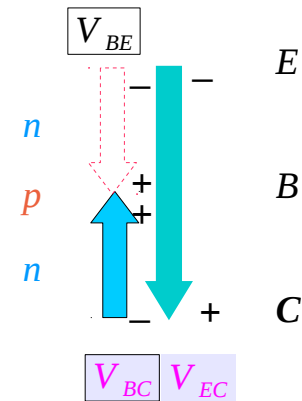

saturation

Active and Saturation Regions (3)

Common Emitter

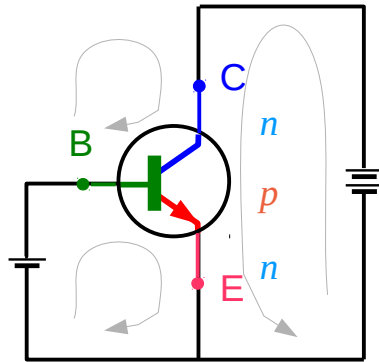

active

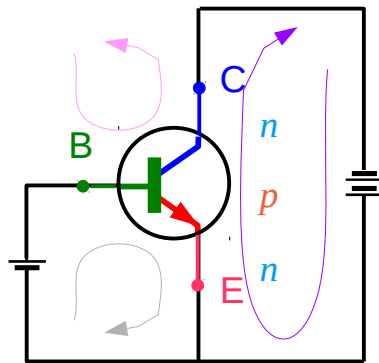

saturation

Common Collector 2

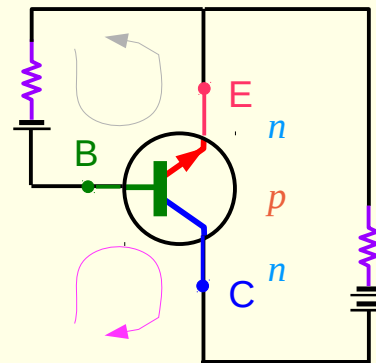
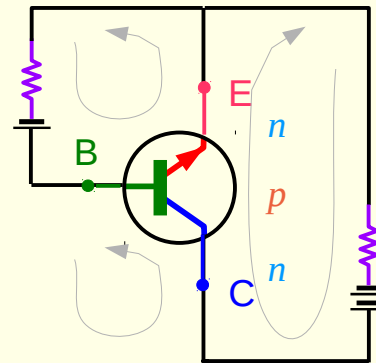

saturation

Common Collector

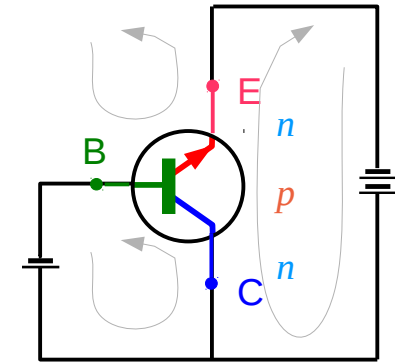

active

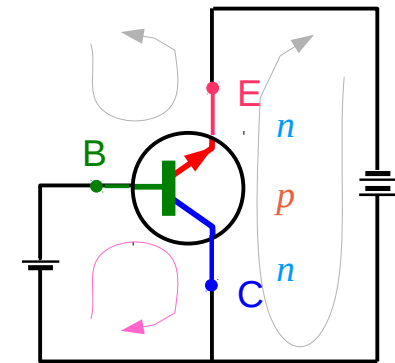

saturation

Active and Saturation Regions (4)

Common Emitter

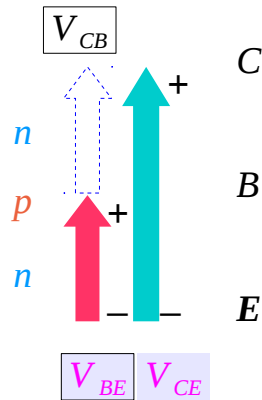

active

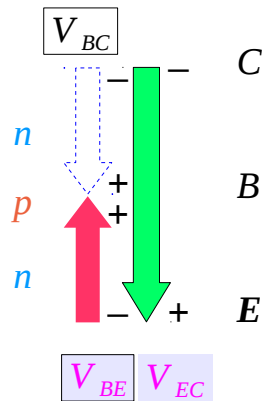

saturation

Common Collector 2

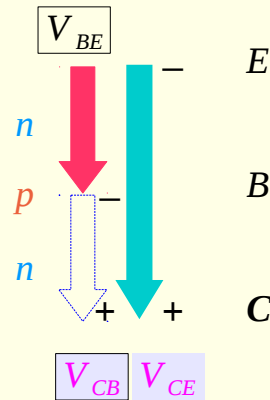

active

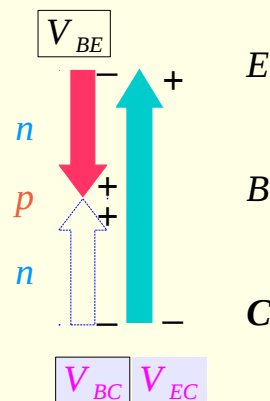

saturation

Common Collector

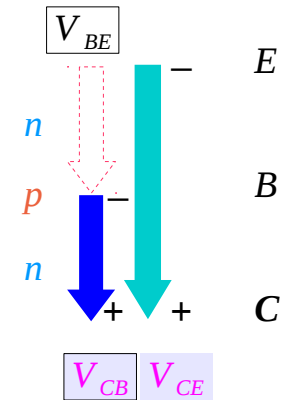

active

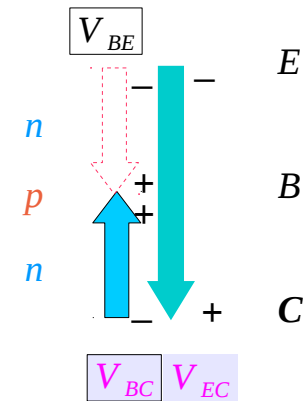

saturation

Active and Saturation Regions (2)

Common Base

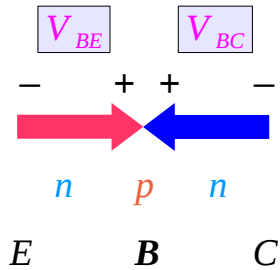

saturation

Common Emitter

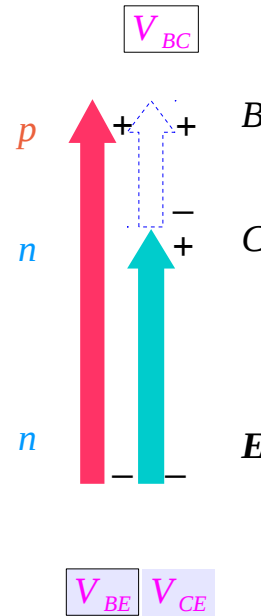

saturation

Common Collector

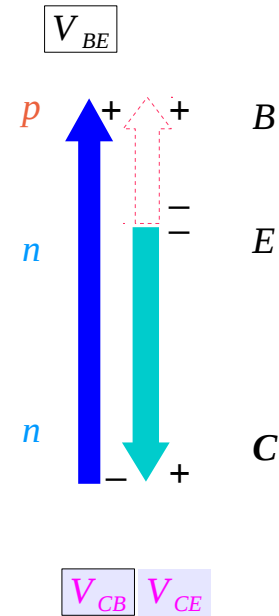

saturation

Active and Saturation Regions (2)

Common Base

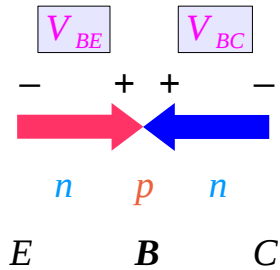

saturation

Common Emitter

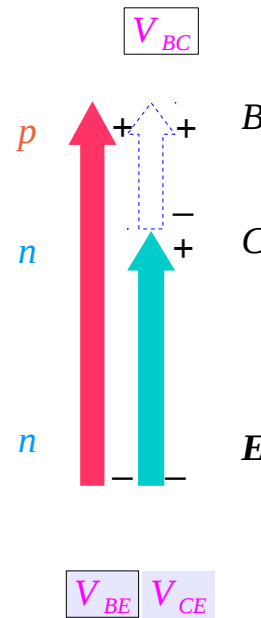

saturation

Common Collector

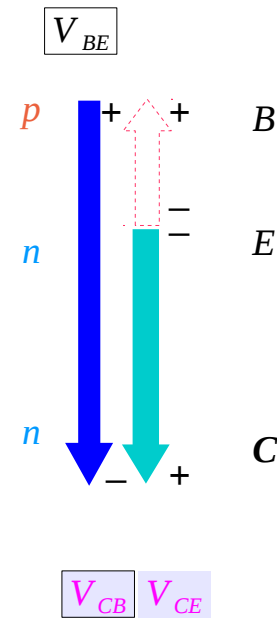

saturation

Common Base (1)

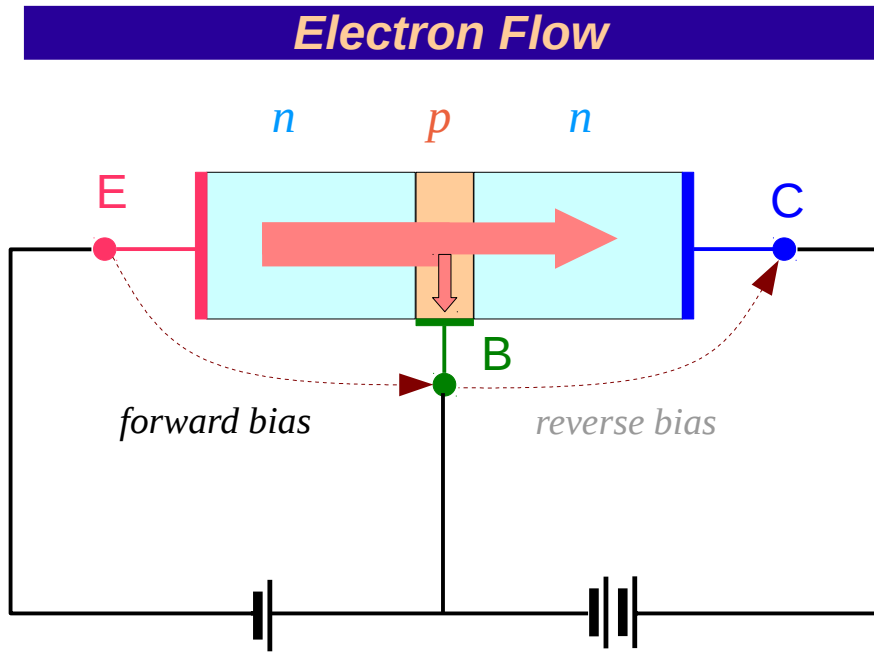

Common Base

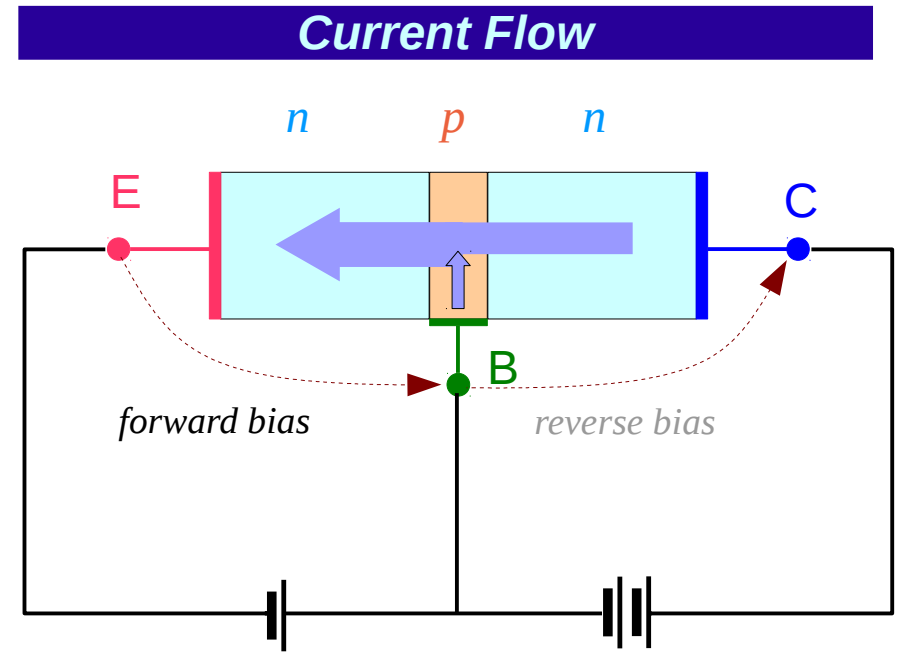

Common Base

Common Base (2)

Electron Flow

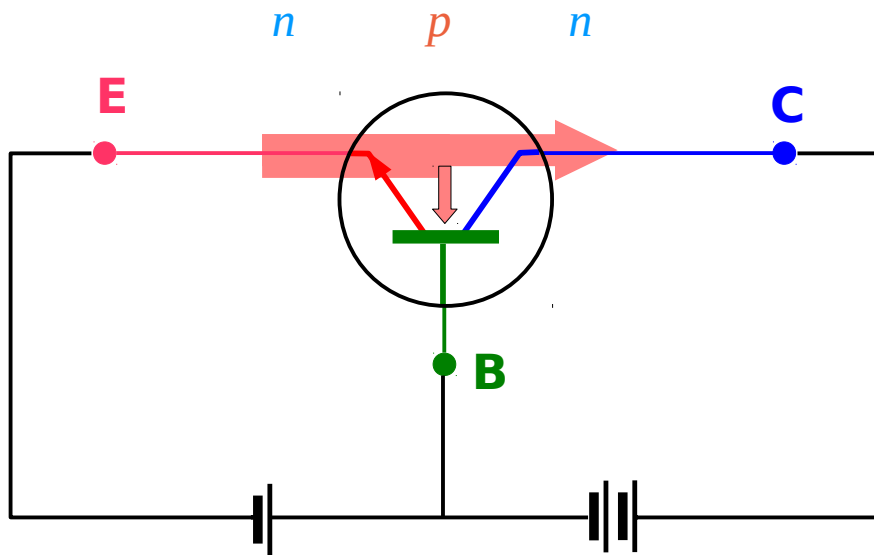

Common Base

Current Flow

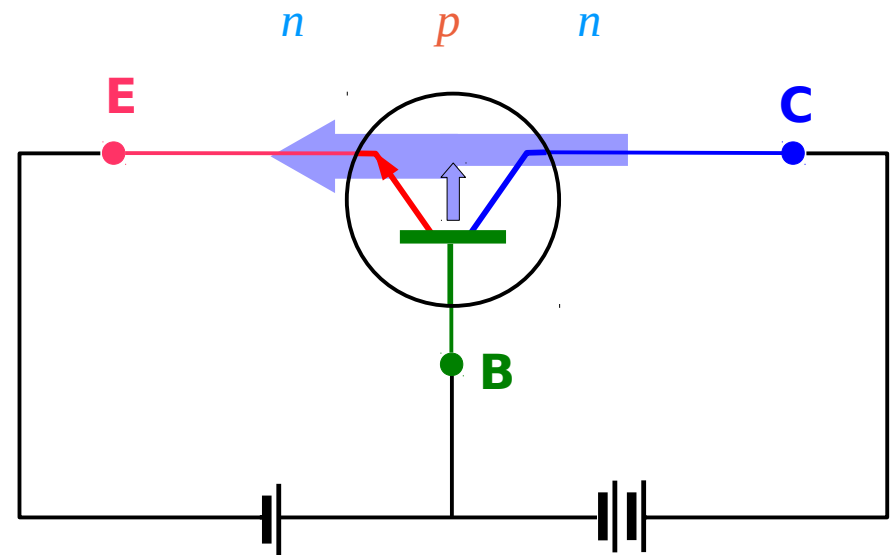

Common Base

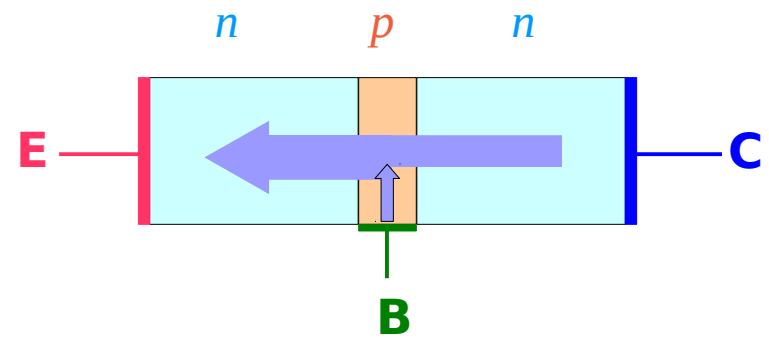
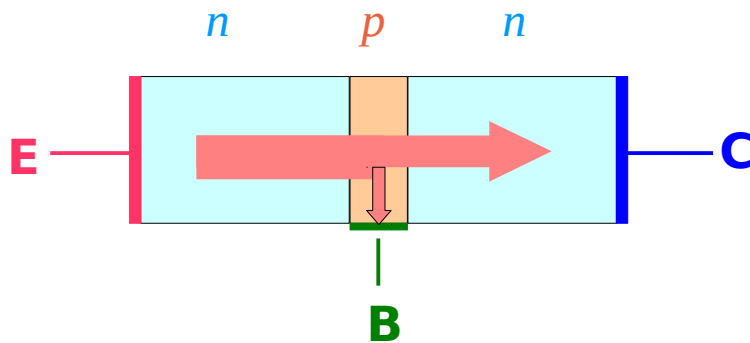

Common Emitter (1)

Electron Flow

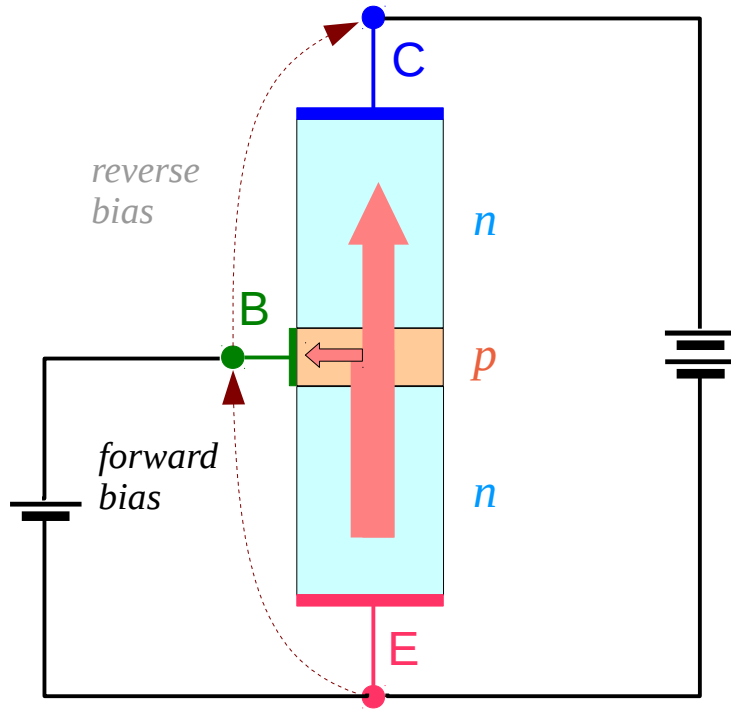

Common Emitter

Current Flow

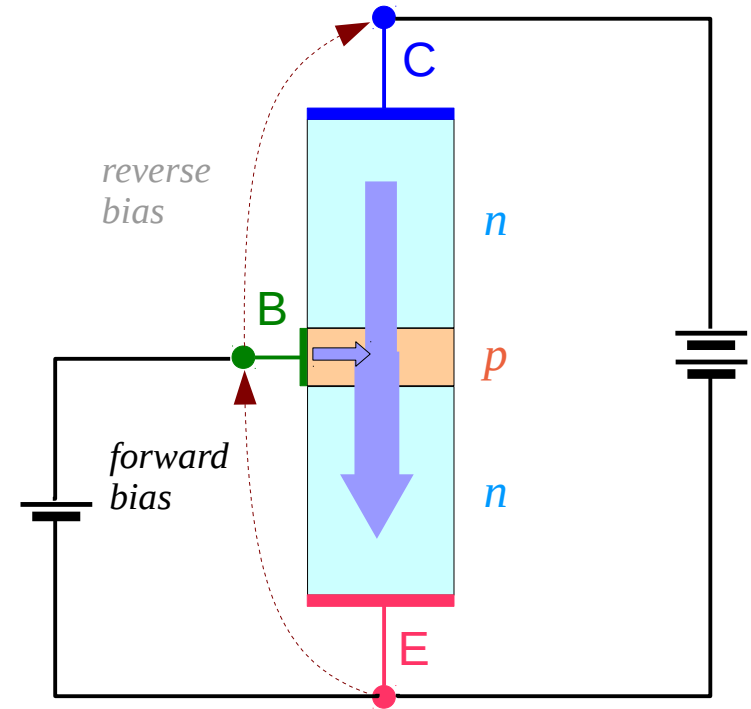

Common Emitter

Common Emitter (2)

Electron Flow

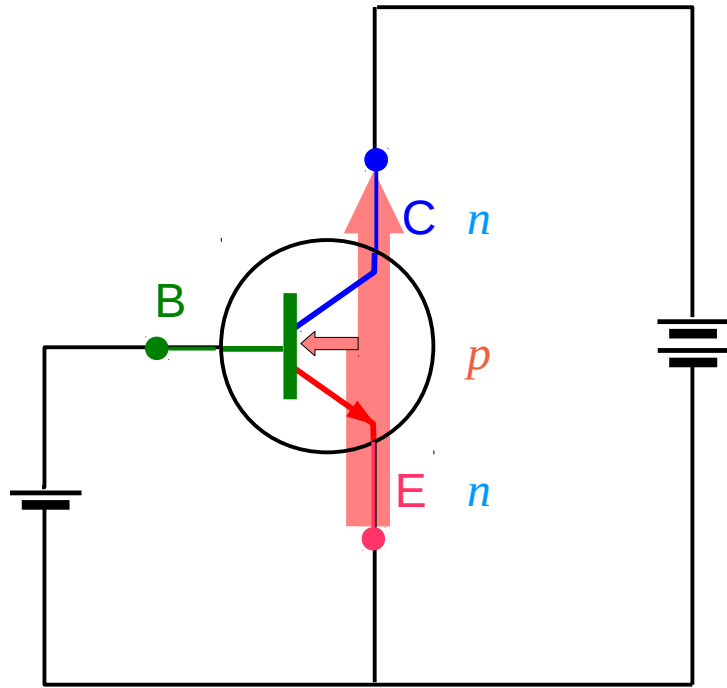

Common Emitter

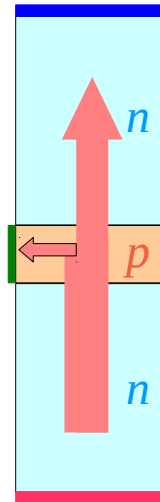

Current Flow

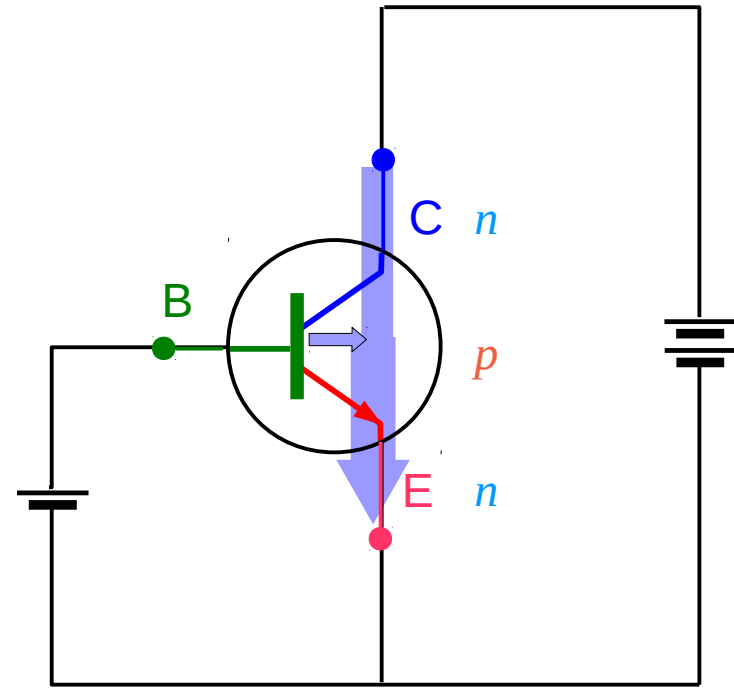

Common Emitter

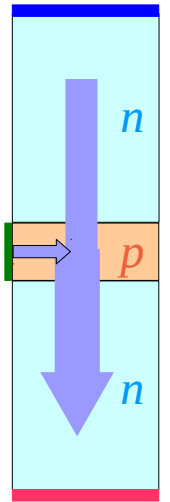

Common Collector (1)

Electron Flow

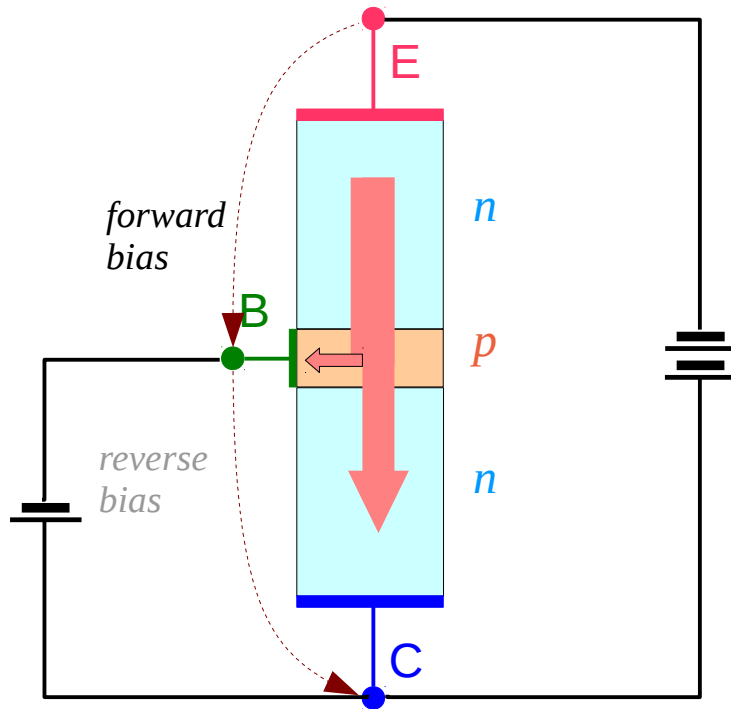

Common Collector

Current Flow

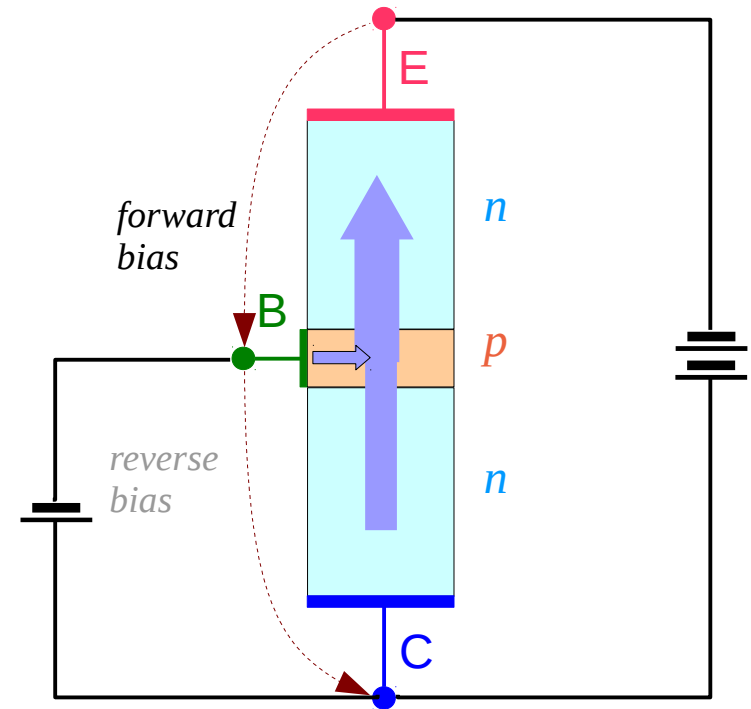

Common Collector

Common Collector (2)

Electron Flow

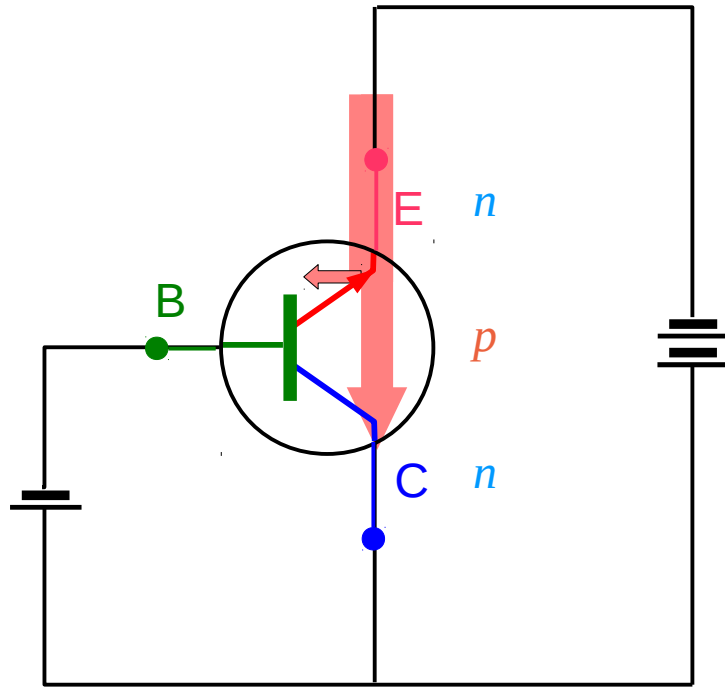

Common Collector

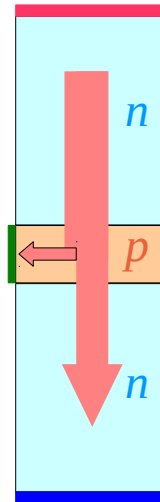

Current Flow

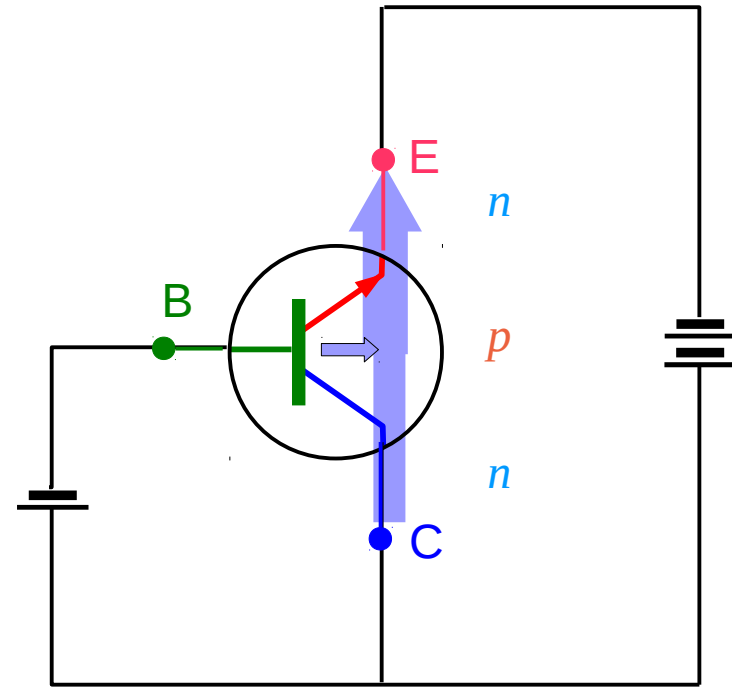

Common Collector

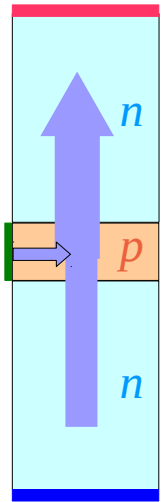

BJT Bias

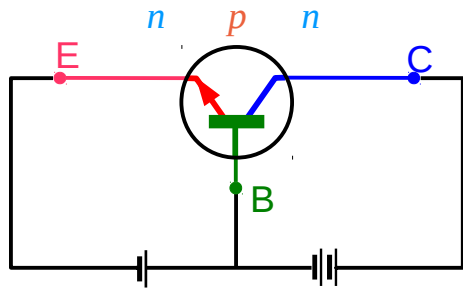

Common Base

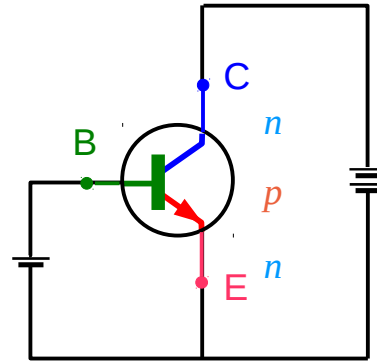

Common Emitter

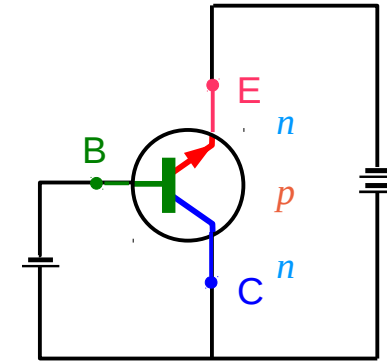

Common Collector

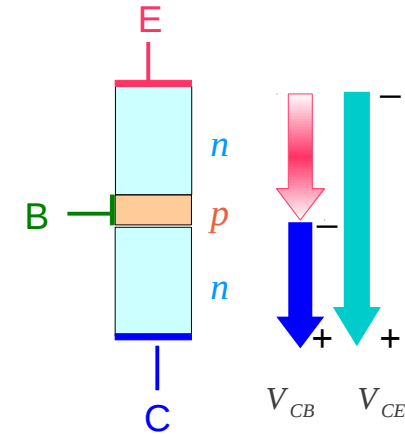
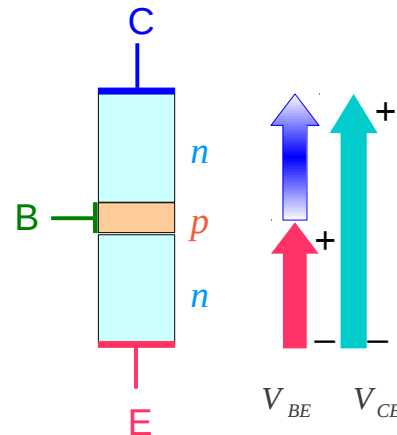
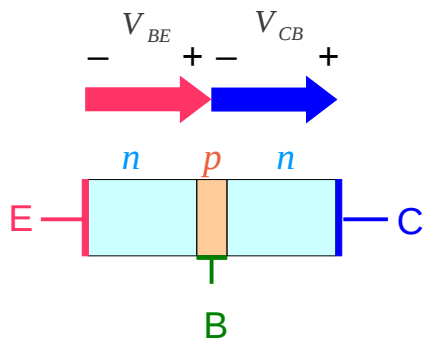

Common Emitter (2)

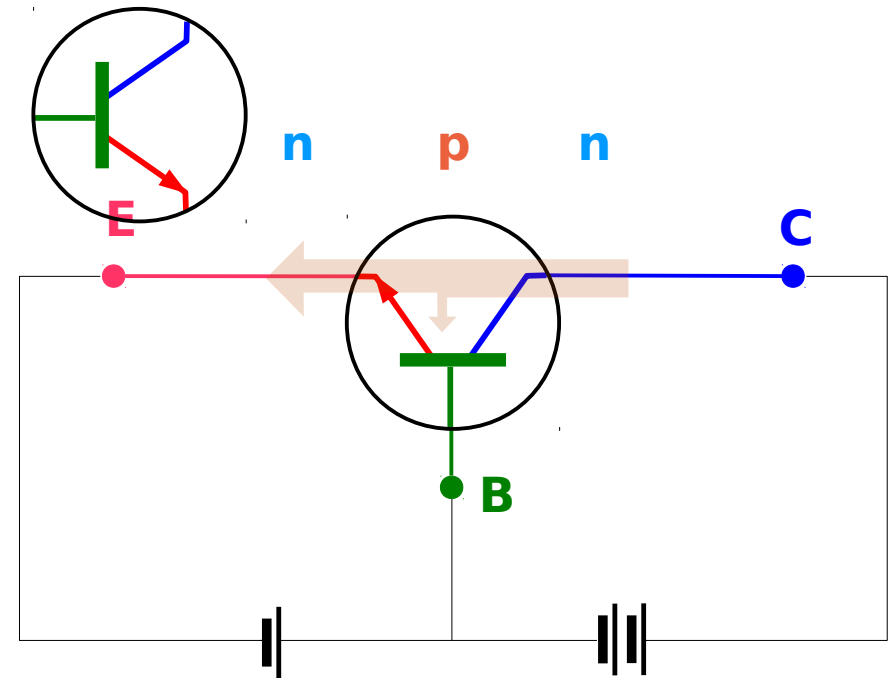

Electron Flow

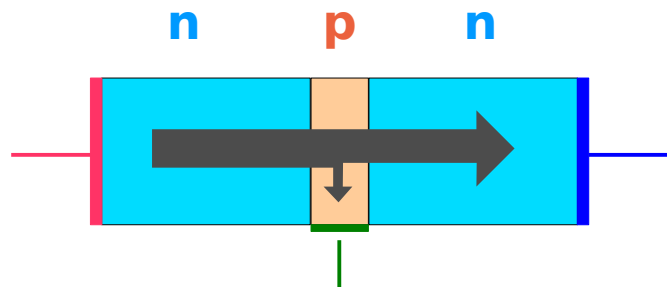

Current Flow

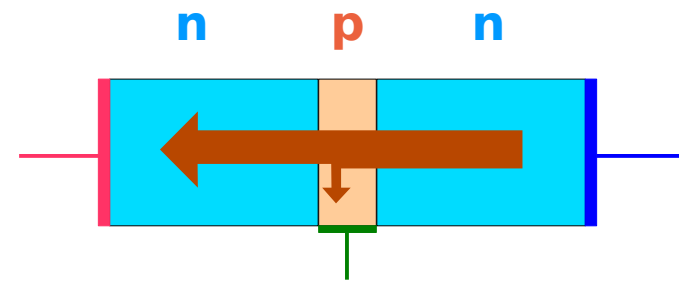

References

[1] <http://en.wikipedia.org/>

[2] J.H. McClellan, et al., *Signal Processing First*, Pearson Prentice Hall, 2003