

Applications of Array Pointers (1A)

Copyright (c) 2010 - 2020 Young W. Lim.

Permission is granted to copy, distribute and/or modify this document under the terms of the GNU Free Documentation License, Version 1.2 or any later version published by the Free Software Foundation; with no Invariant Sections, no Front-Cover Texts, and no Back-Cover Texts. A copy of the license is included in the section entitled "GNU Free Documentation License".

Please send corrections (or suggestions) to youngwlim@hotmail.com.
This document was produced by using LibreOffice.

Multi-dimensional Array Pointers

$(n-1)$ -d array pointer to a n -d array

`int a[4];` **1-d** array
`int (*p);` **0-d** array pointer ($p = a$)

`int b[4][2];` **2-d** array
`int (*q)[2];` **1-d** array pointer ($q = b$)

`int c[4][2][3];` **3-d** array
`int (*r)[2][3];` **2-d** array pointer ($r = c$)

`int d[4][2][3][4];` **4-d** array
`int (*s)[2][3][4];` **3-d** array pointer ($s = d$)



the 1st dimension can be accessed by incrementing $(n-1)$ -d array pointer

n -d array name and $(n-1)$ -d array pointer

```
int a[4];  
int (*p);
```

```
p = &a[0];  
p = a;
```

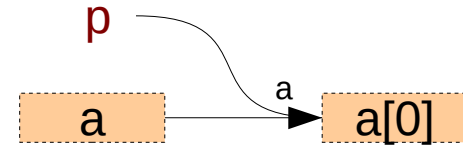

```
int b[4][2];  
int (*q)[2];
```

```
q = &b[0];  
q = b;
```

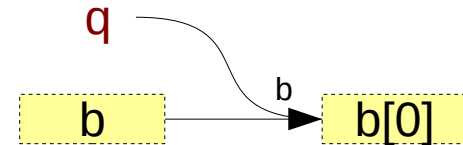

```
int c[4][2][3];  
int (*r)[2][3];
```

```
r = &c[0];  
r = c;
```

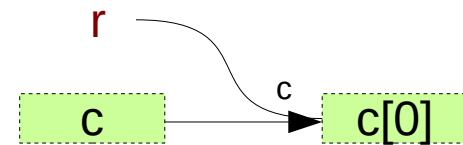

```
int d[4][2][3][4];  
int (*s)[2][3][4];
```

```
s = &d[0];  
s = d;
```

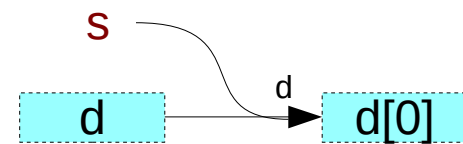

the 1st dimension can be accessed by incrementing $(n-1)$ -d array pointer

n-d array pointer to a *n*-d array

`int a [4] ;` **1-d** array
`int (*p) [4];` **1-d** array pointer (`p = &a`)

`int b [4][2];` **2-d** array
`int (*q) [4][2];` **2-d** array pointer (`q = &b`)

`int c [4][2][3];` **3-d** array
`int (*r) [4][2][3];` **3-d** array pointer (`r = &c`)

`int d [4][2][3][4];` **4-d** array
`int (*s) [4][2][3][4];` **4-d** array pointer (`s = &d`)

n-d array name and *n*-d array pointer

```
int a [4];  
int (*p) [4];
```

```
p = &a;
```

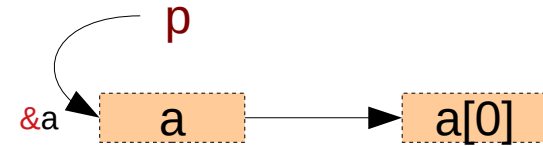

```
int b [4][2];  
int (*q) [4][2];
```

```
q = &b;
```

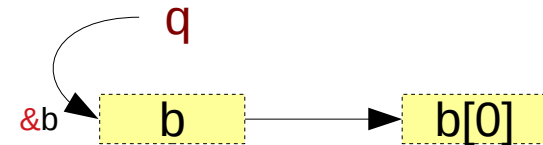

```
int c [4][2][3];  
int (*r) [4][2][3];
```

```
r = &c;
```

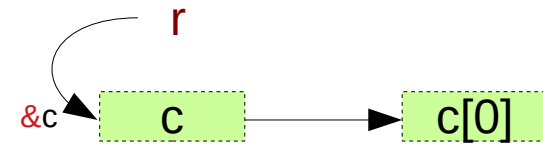

```
int d [4][2][3][4];  
int (*s) [4][2][3][4];
```

```
s = &d;
```

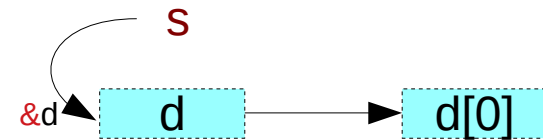

multi-dimensional array pointers

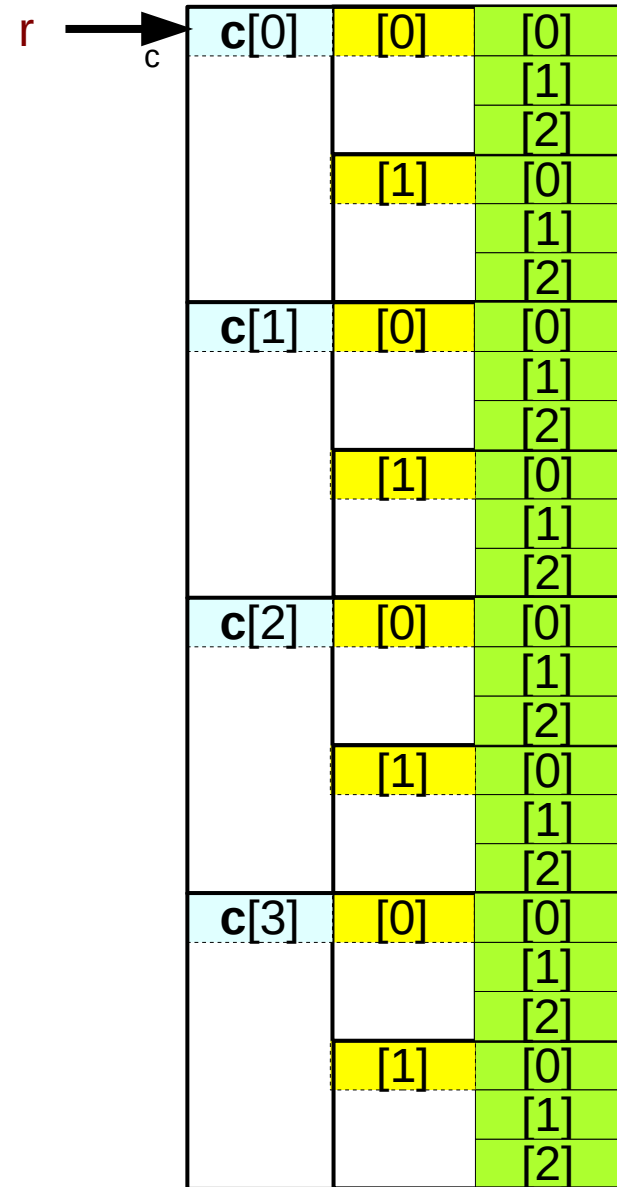
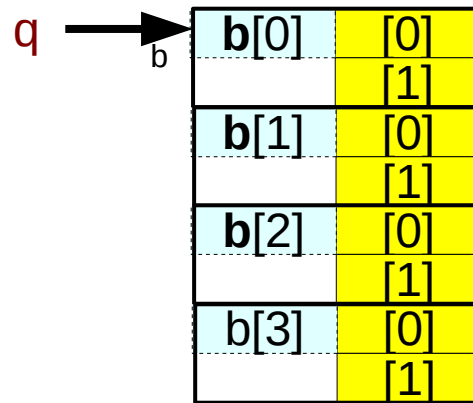
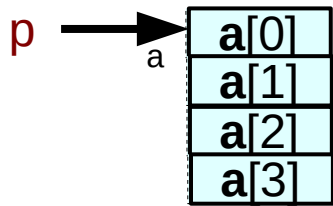

- `int a[4];` **1-d array**
- `int (*p);` **0-d array pointer**
- `int b[4][2];` **2-d array**
- `int (*q)[2];` **1-d array pointer**
- `int c[4][2][3];` **3-d array**
- `int (*r)[2][3];` **2-d array pointer**
- `int d[4][2][3][4];` **4-d array**
- `int (*s)[2][3][4];` **3-d array pointer**

Initializing *n-d* array pointers

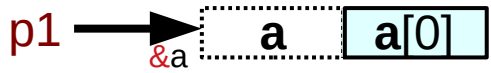

```
int a[4];
int (*p1)[4] = &a;
```

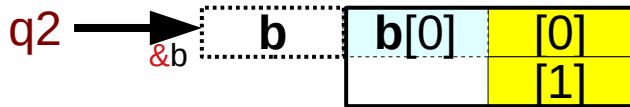

```
int b[4][2];
int (*q2)[4][2] = &b;
```

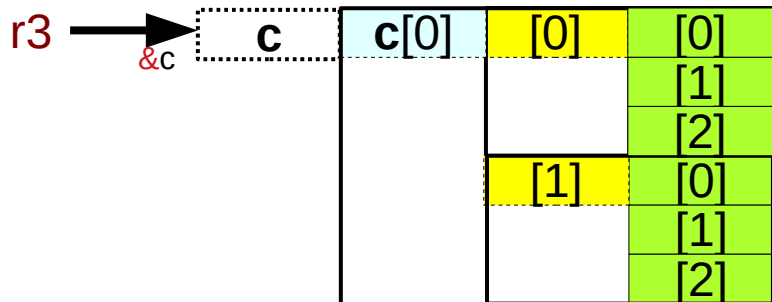

```
int c[4][2][3];
int (*r3)[4][2][3] = &c;
```

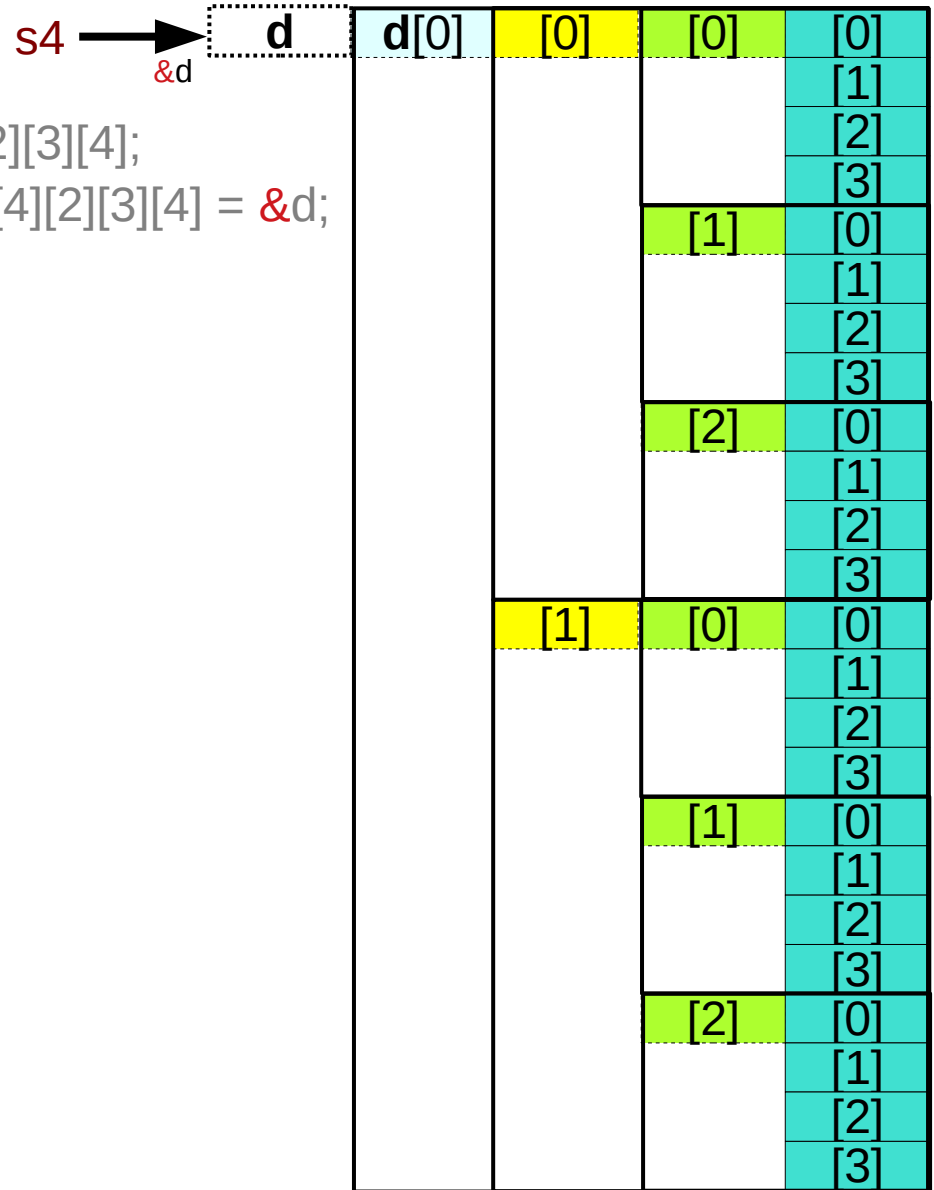

```
int d[4][2][3][4];
int (*s4)[4][2][3][4] = &d;
```

Initializing $(n-1)$ -d array pointers

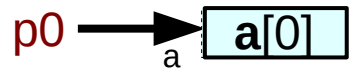

```
int a[4];
int (*p0) = a;
```

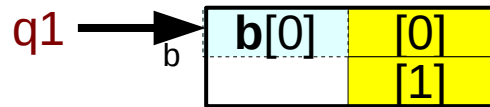

```
int b[4][2];
int (*q1)[2] = b;
```

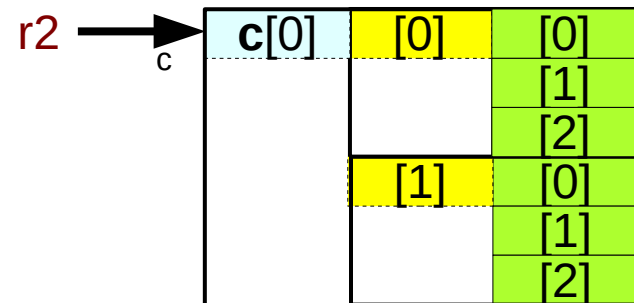

```
int c[4][2][3];
int (*r2)[2][3] = c;
```

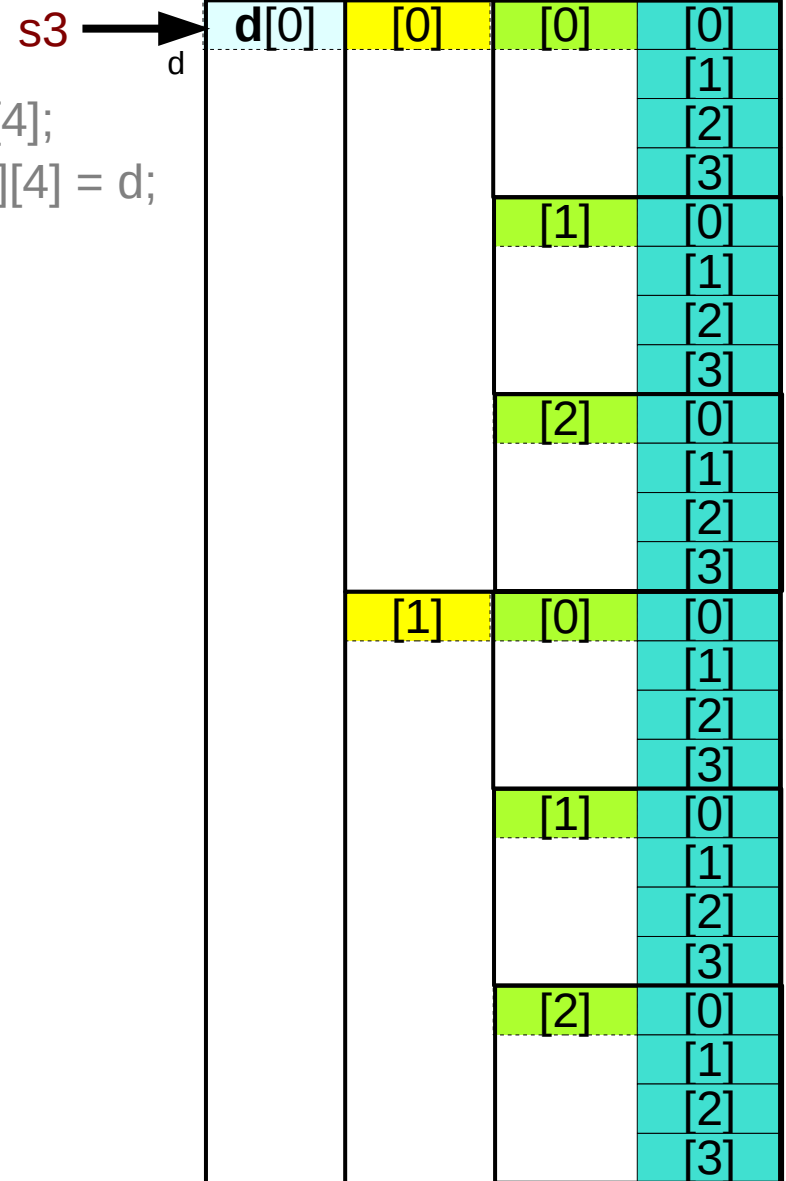

```
int d[4][2][3][4];
int (*s3)[2][3][4] = d;
```

array pointers to multi-dimensional subarrays

```
int d[4][2][3][4];
int (*s)[2][3][4];
```

| | | |
|------------|-------------------|---------------|
| d | 4-d array name | d[4][2][3][4] |
| | 3-d array pointer | (*p)[2][3][4] |
| d[i] | 3-d array name | d[i][2][3][4] |
| | 2-d array pointer | (*q)[3][4] |
| d[i][j] | 2-d array name | d[i][j][3][4] |
| | 1-d array pointer | (*r)[4] |
| d[i][j][k] | 1-d array name | d[i][j][k][4] |
| | 0-d array pointer | (*s) |

i,j,k are specific index values

i = [0..3], j = [0..1], k = [0..2]

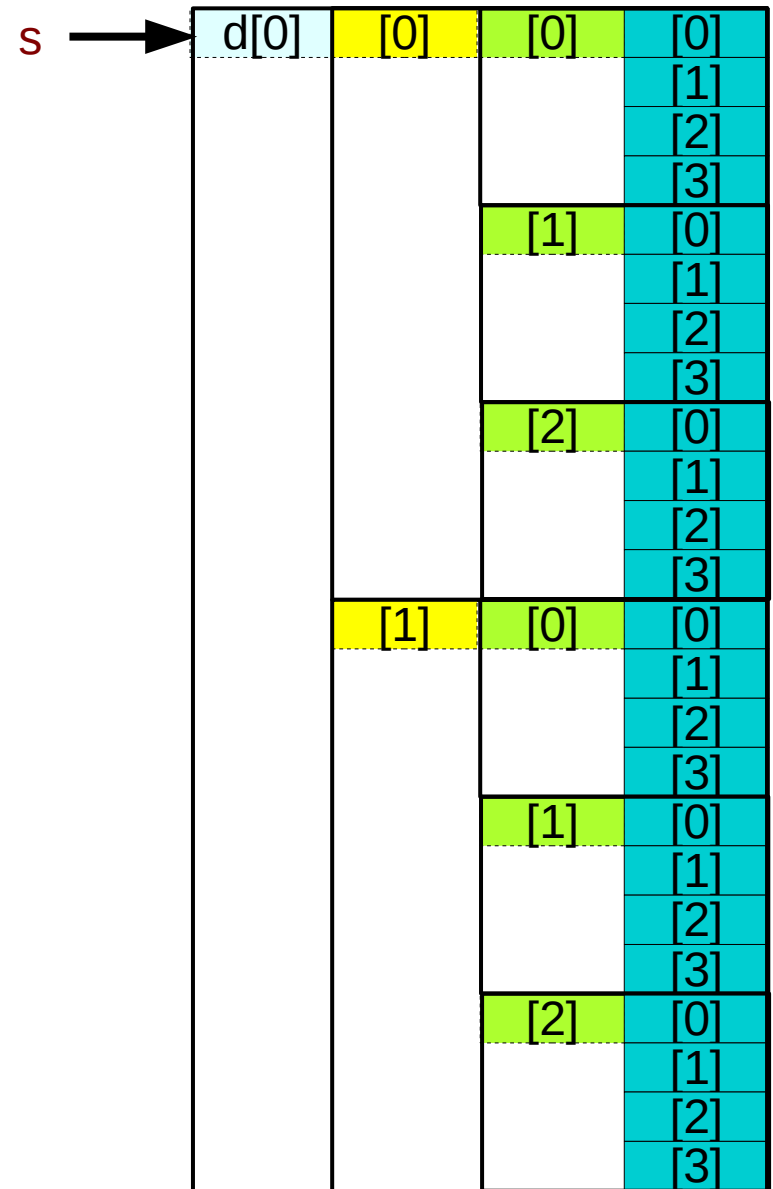

Initializing array pointers to multi-dimensional subarrays

```
int d[4][2][3][4];  
int (*s)[2][3][4];
```

| | | | |
|-------------------------|-------------------------------------|--|---|
| <code>d</code> | 4-d array name 3-d array pointer | <code>d[4][2][3][4]</code> <code>(*p)[2][3][4]</code> | <code>p[i][j][k][l]</code> <code>int (*p)[2][3][4] = d;</code> |
| <code>d[i]</code> | 3-d array name 2-d array pointer | <code>d[i][2][3][4]</code> <code>(*q)[3][4]</code> | <code>q[j][k][l]</code> <code>int (*q)[3][4] = d[i];</code> |
| <code>d[i][j]</code> | 2-d array name 1-d array pointer | <code>d[i][j][3][4]</code> <code>(*r)[4]</code> | <code>r[k][l]</code> <code>int (*r)[4] = d[i][j];</code> |
| <code>d[i][j][k]</code> | 1-d array name 0-d array pointer | <code>d[i][j][k][4]</code> <code>(*s)</code> | <code>s[l]</code> <code>int (*s) = d[i][j][k];</code> |

`i = [0..3], j = [0..1], k = [0..2]`

Passing multidimensional array names

```
int a[4];  
int (*p);
```

call
funa(a, ...);

prototype
void **fun**a(int (*p), ...);

```
int b[4][2];  
int (*q)[2];
```

call
funb(b, ...);

prototype
void **fun**b(int (*q)[2], ...);

```
int c[4][2][3];  
int (*r)[2][3];
```

call
func(c, ...);

prototype
void **func**(int (*r)[2][3], ...);

```
int d[4][2][3][4];  
int (*s)[2][3][4];
```

call
fund(d, ...);

prototype
void **fund**(int (*s)[2][3][4], ...);

Double pointer to a 1-d array – a variable view (p, q)

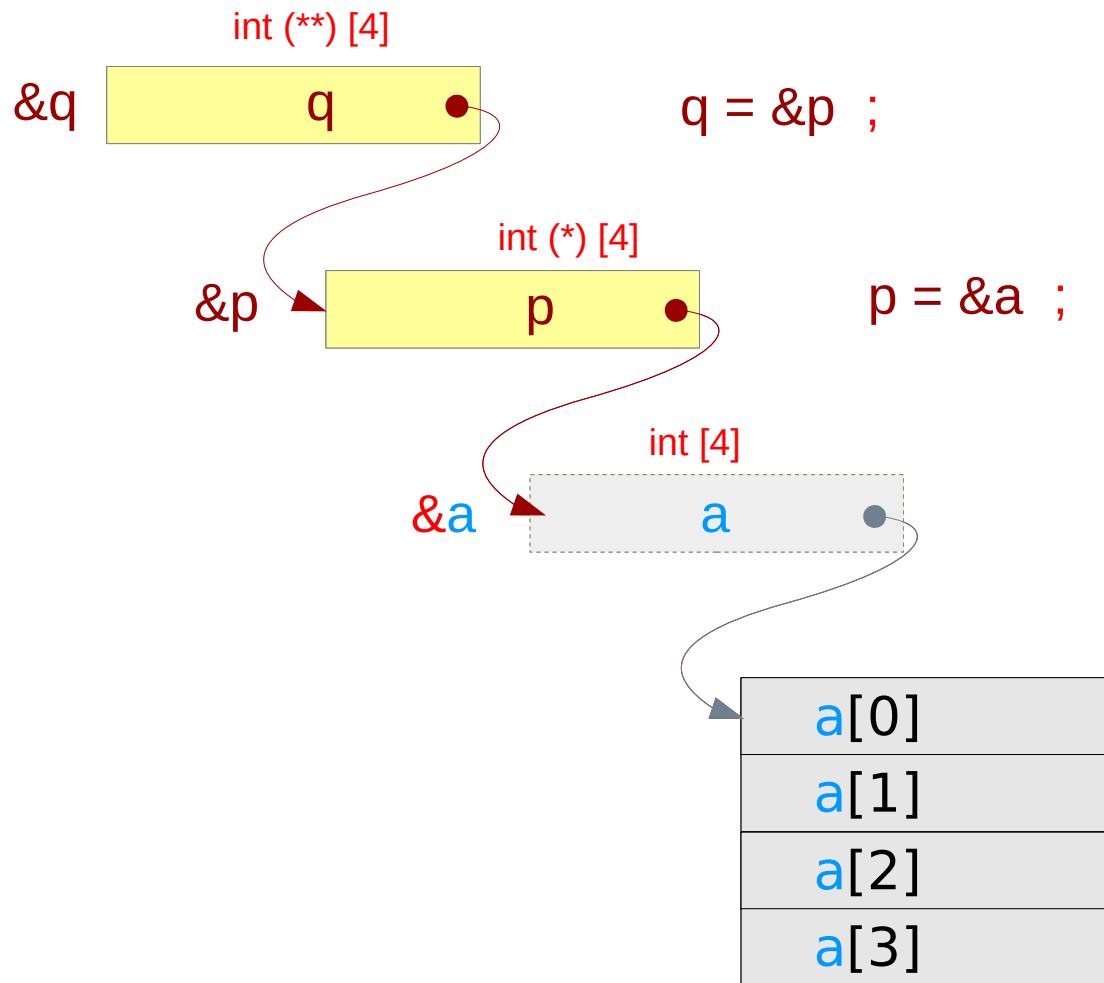

```
int a[4] ;  
int (*p) [4] = &a ;  
int (**q) [4] = &p ;
```

```
➔ p = &a ;  
➔ q = &p ;
```

Double pointer to a 1-d array – a variable view (q)

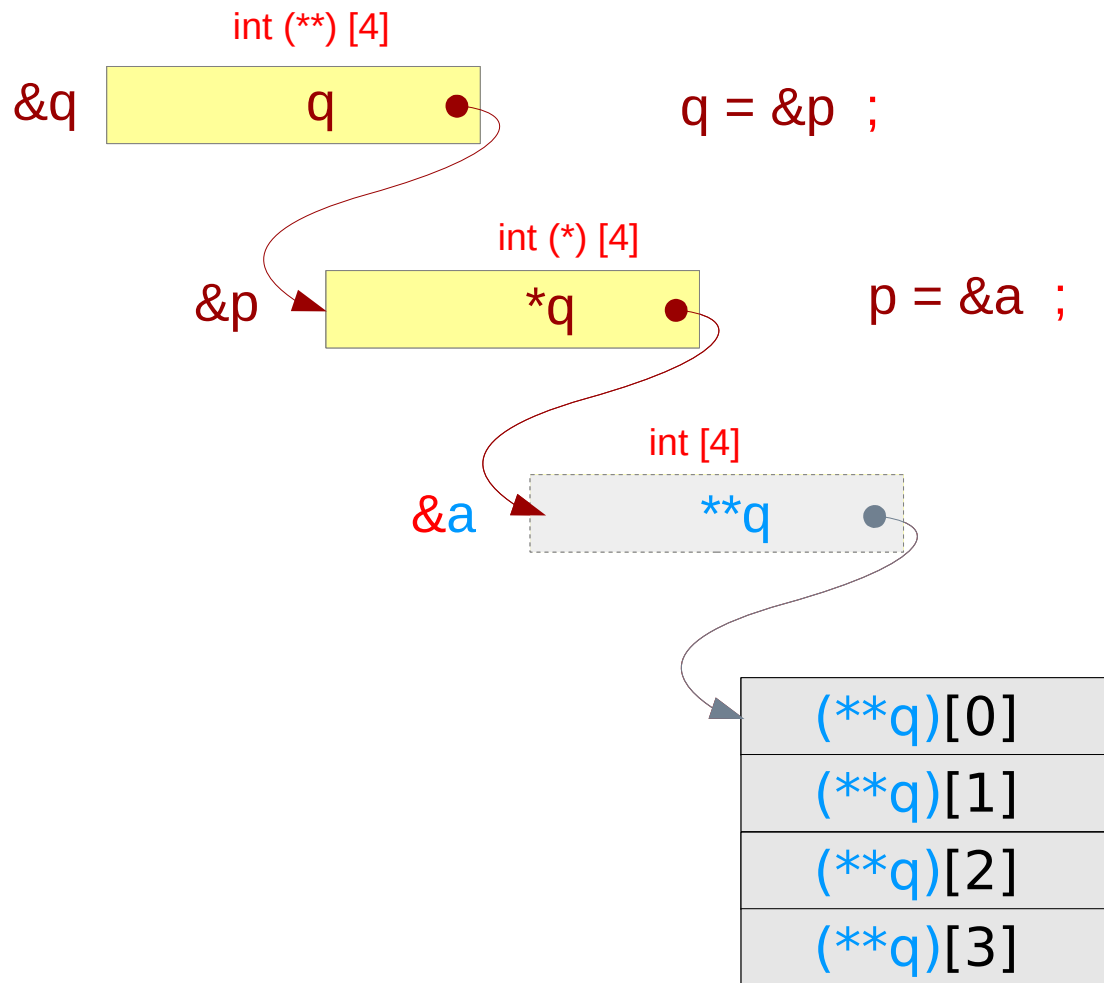

```
int a[4] ;  
int (*p) [4] = &a ;  
int (**q) [4] = &p ;
```

```
➡ p = &a ;  
➡ q = &p ;
```

Double pointer to a 1-d array – a type view

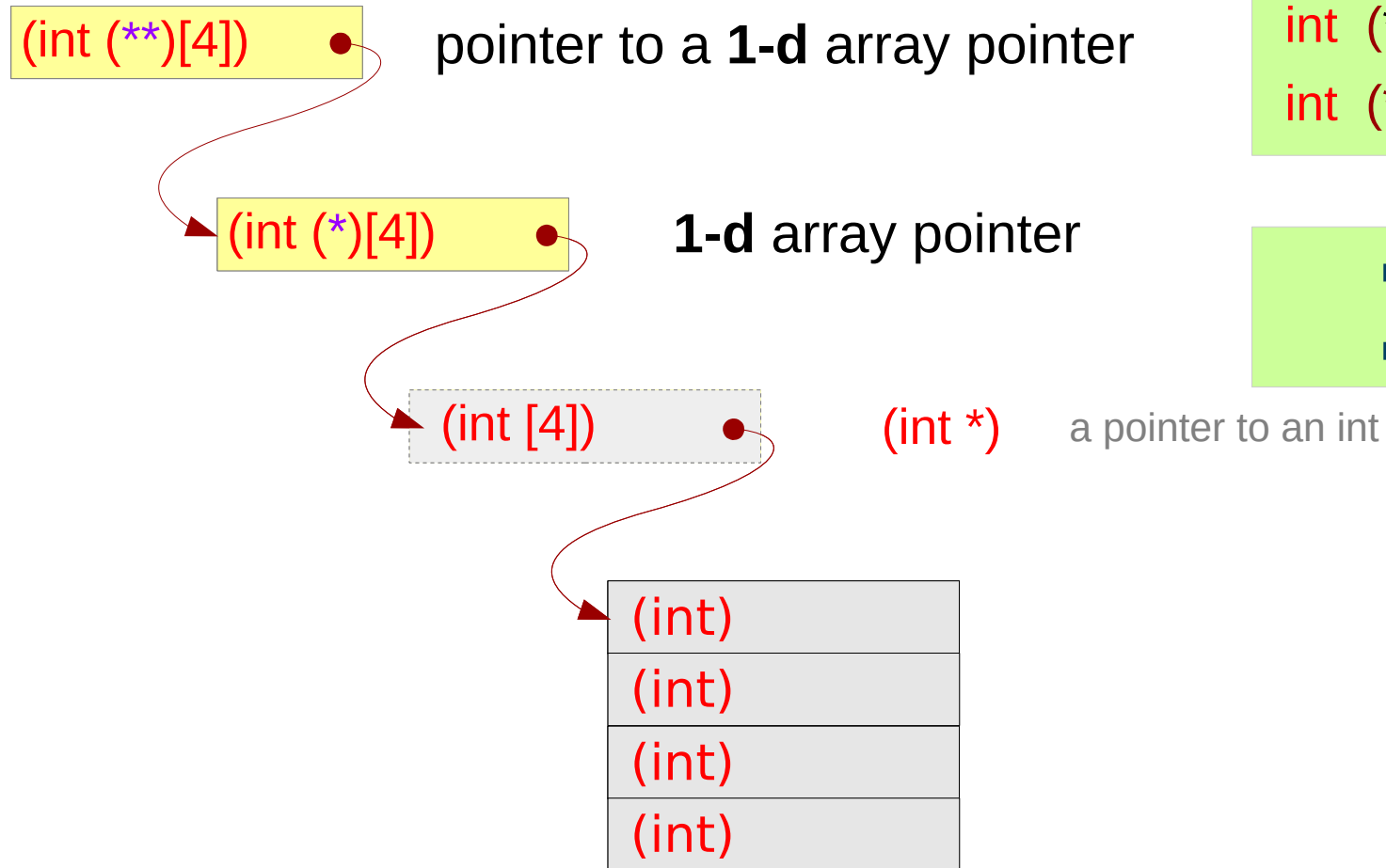

```
int a[4] ;  
int (*p) [4] = &a ;  
int (**q) [4] = &p ;
```

```
➔ p = &a ;  
➔ q = &p ;
```

Virtual Array Pointers in Multi-dimensional Arrays

3-d array structure

- Hierarchical
- Nested Structure
- Virtual Array Pointers over
 - Contiguous
 - Linear Layout

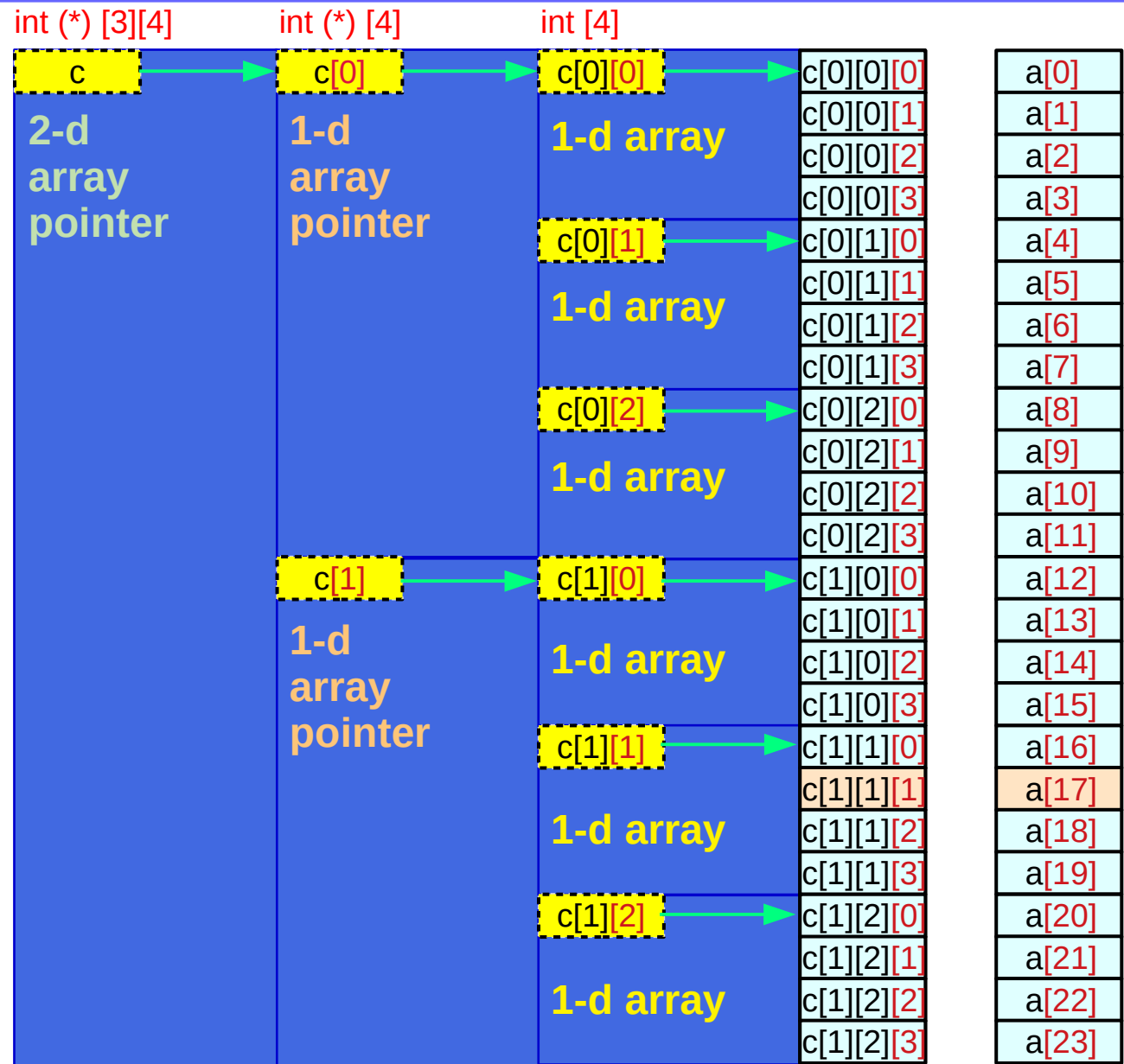

Array **p** and virtual array pointer **p**

Abstract data (array) **p**

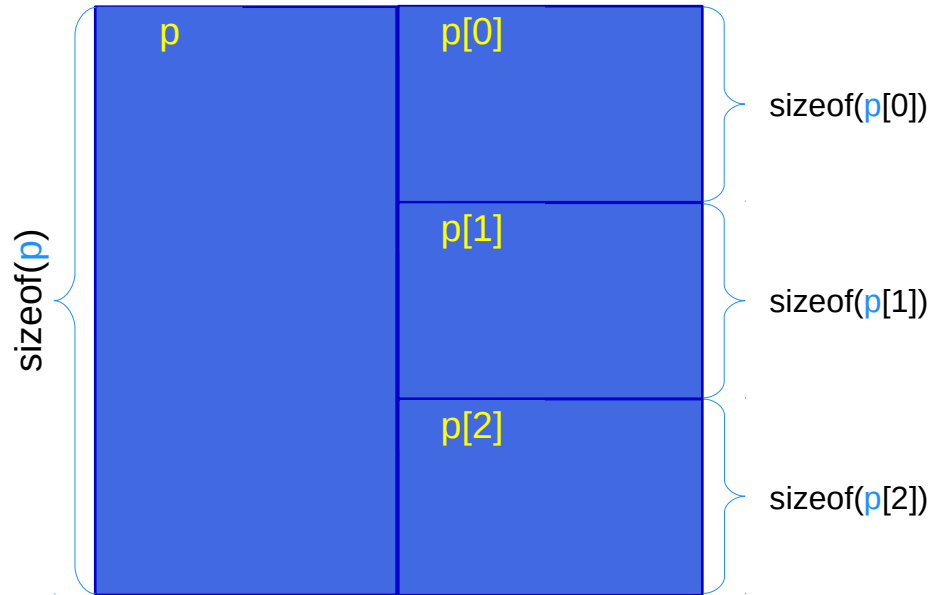

Virtual array pointer **p**

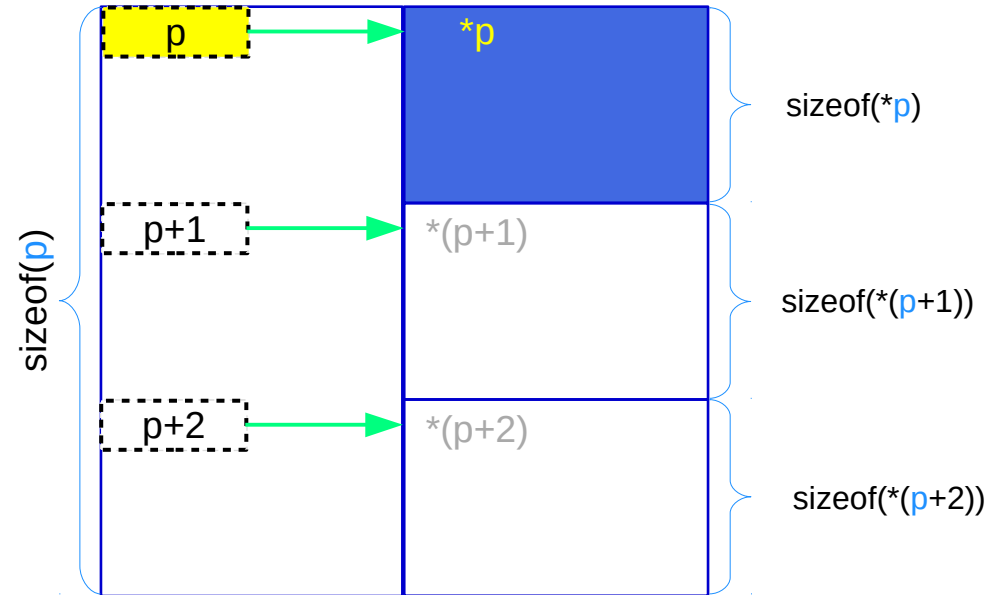

p is the name of an array and has a array pointer type but has a size of the array

p is a virtual array pointer

Virtual array pointer to abstract data

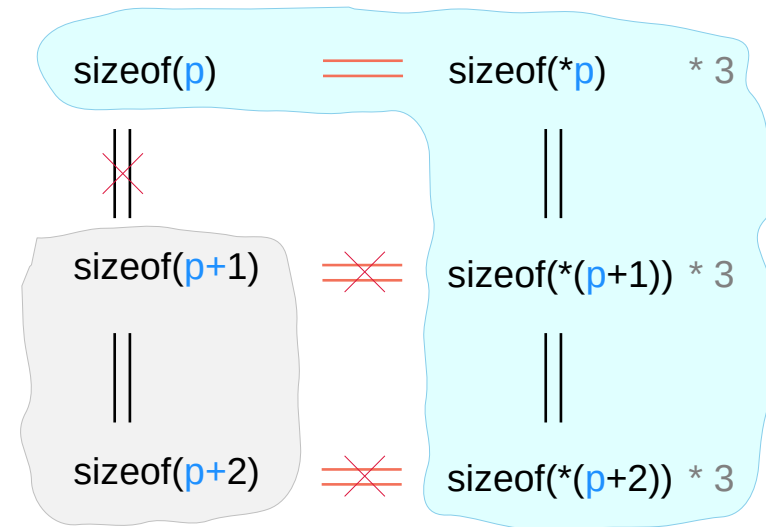
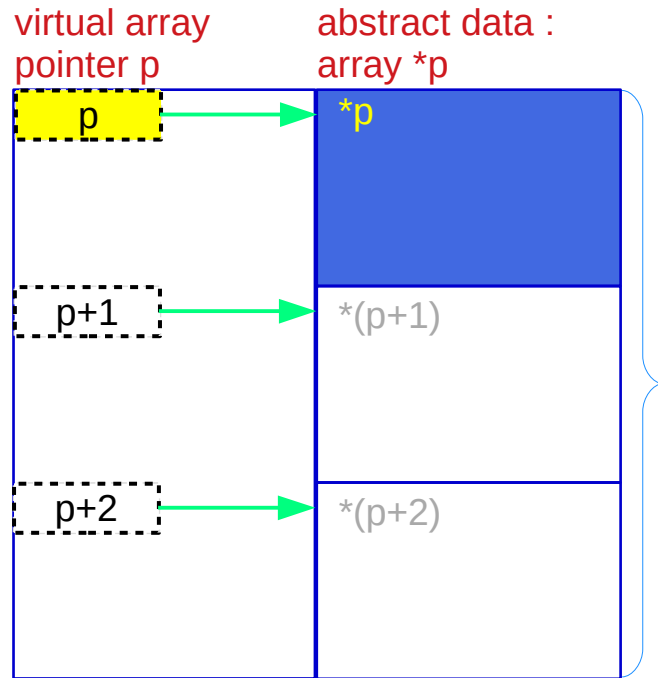

Array **a** and pointer **a**

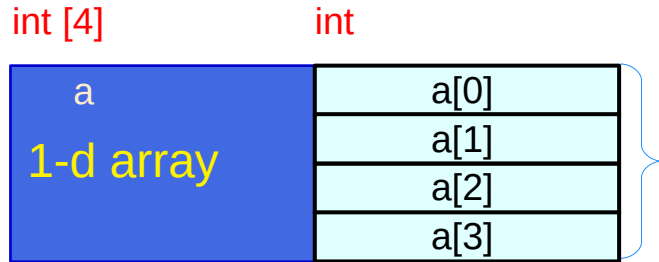

1-d array **a** specific array type

$\text{sizeof}(a)$

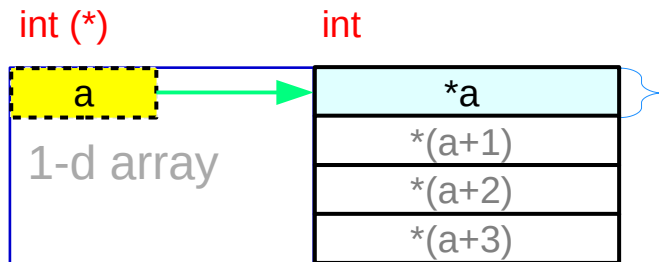

pointer **a** general pointer type

$\text{sizeof}(a) = \text{sizeof}(*a) * 4$

a is the name of a 1-d array and has a pointer type but has a size of the array

a is a virtual array pointer

Array **b** and pointer **b**

2-d array **b** specific array type

`sizeof(b)`

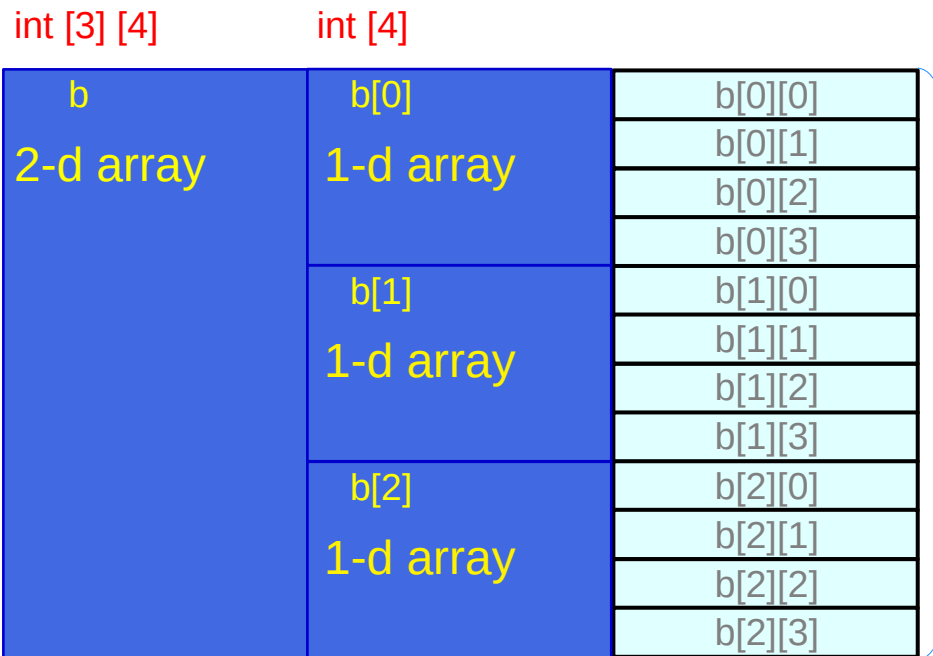

1-d array pointer **b** general pointer type

`sizeof(b) = sizeof(*b) * 3`

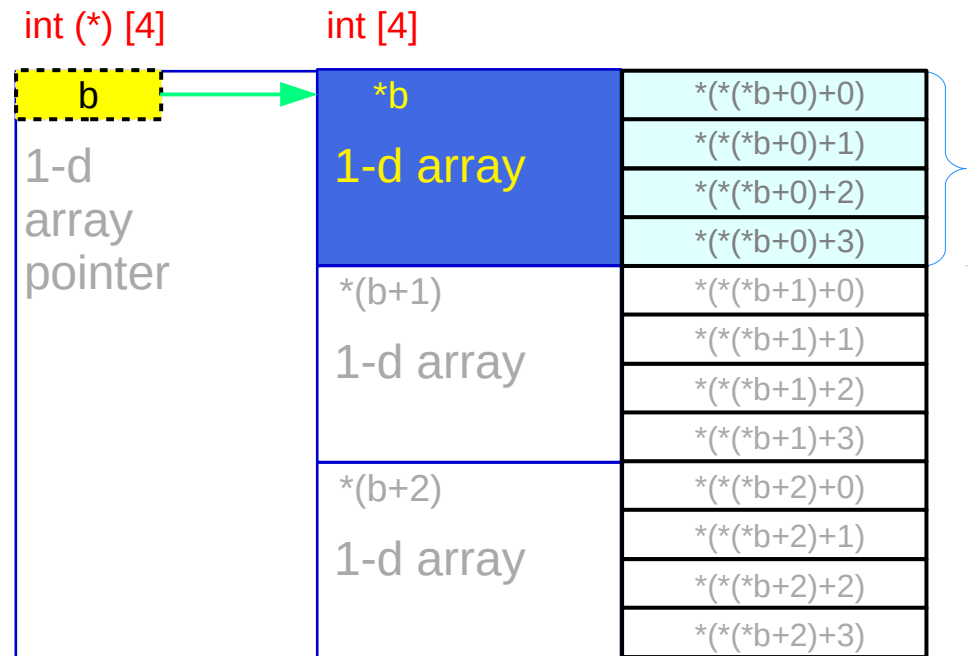

b is the name of a 2-d array and has a 1-d array pointer type but has a size of the array

b is a virtual array pointer

Array c

3-d array c

specific array type

sizeof(c)

c is the name of a 3-d array and has a 2-d array pointer type but has a size of the array

c is a virtual array pointer

| int [2][3][4] | int [3][4] | int [4] | |
|----------------------|----------------------|----------------------|------------|
| c 3-d array | c[0] 2-d array | c[0][0] 1-d array | c[0][0][0] |
| | | | c[0][0][1] |
| | | | c[0][0][2] |
| | | | c[0][0][3] |
| | | c[0][1] 1-d array | c[0][1][0] |
| | | | c[0][1][1] |
| | | | c[0][1][2] |
| | | | c[0][1][3] |
| | | c[0][2] 1-d array | c[0][2][0] |
| | | c[0][2][1] | |
| | | c[0][2][2] | |
| | | c[0][2][3] | |
| c[1] 2-d array | c[1][0] 1-d array | | c[1][0][0] |
| | | | c[1][0][1] |
| | | | c[1][0][2] |
| | | c[1][0][3] | |
| | c[1][1] 1-d array | | c[1][1][0] |
| | | | c[1][1][1] |
| | | | c[1][1][2] |
| | | c[1][1][3] | |
| | c[1][2] 1-d array | | c[1][2][0] |
| | | c[1][2][1] | |
| | | c[1][2][2] | |
| | c[1][2][3] | | |

Pointer c

2-d array pointer c

general pointer type

$\text{sizeof}(c) = \text{sizeof}(*c) * 2$

c is the name of a 3-d array and has a 2-d array pointer type but has a size of the array

c is a virtual array pointer

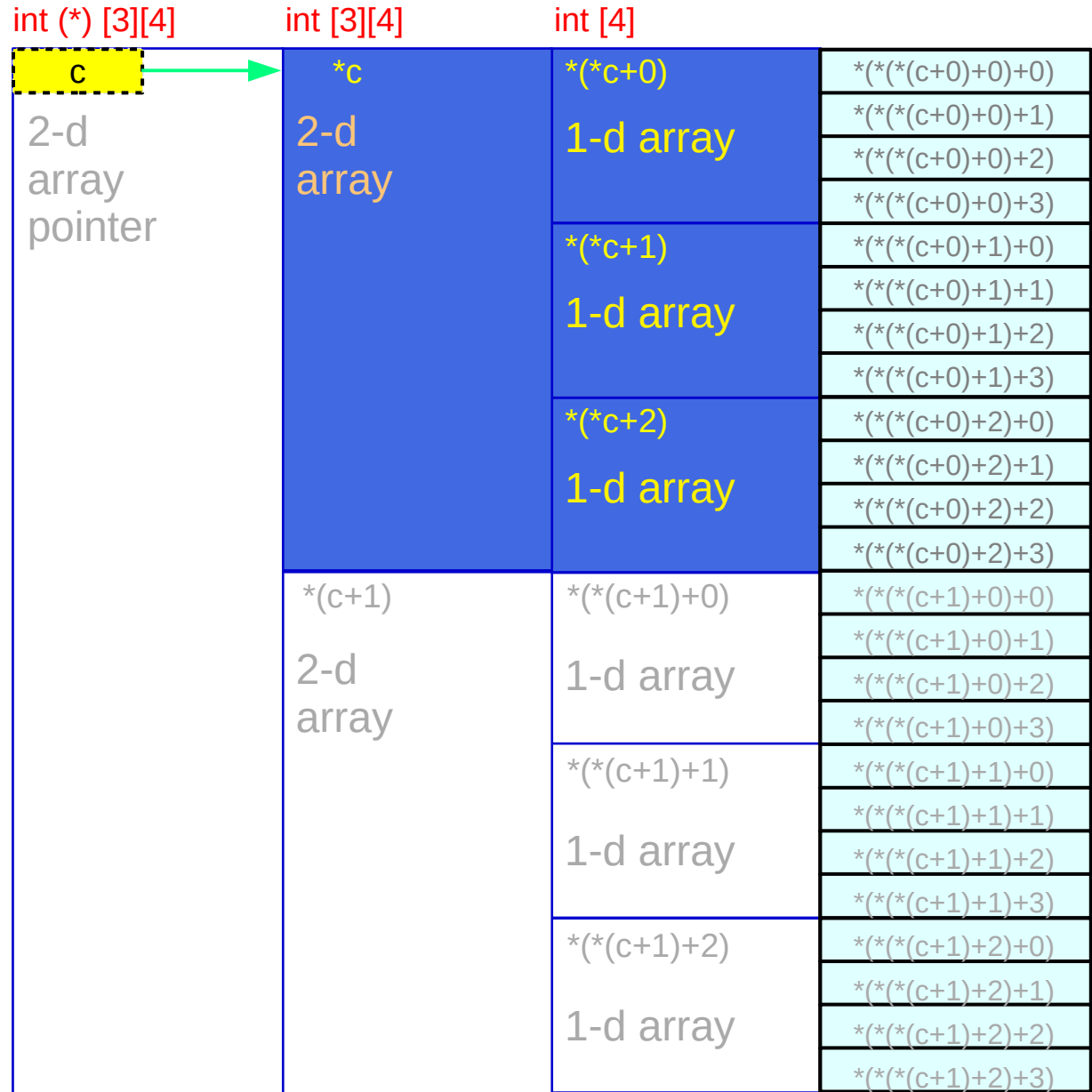

Pointers to primitive data

int *p;

int i, j, k;

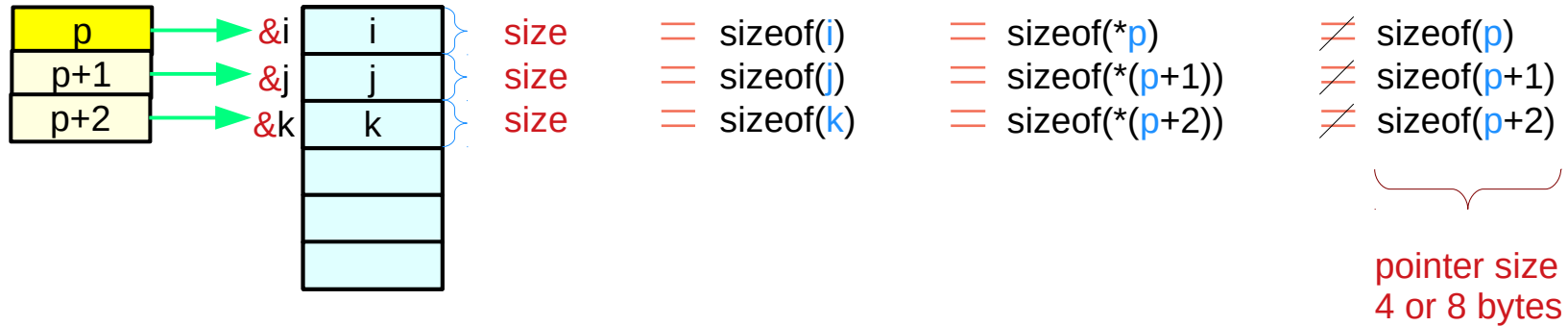

double *q;

double a, b, c;

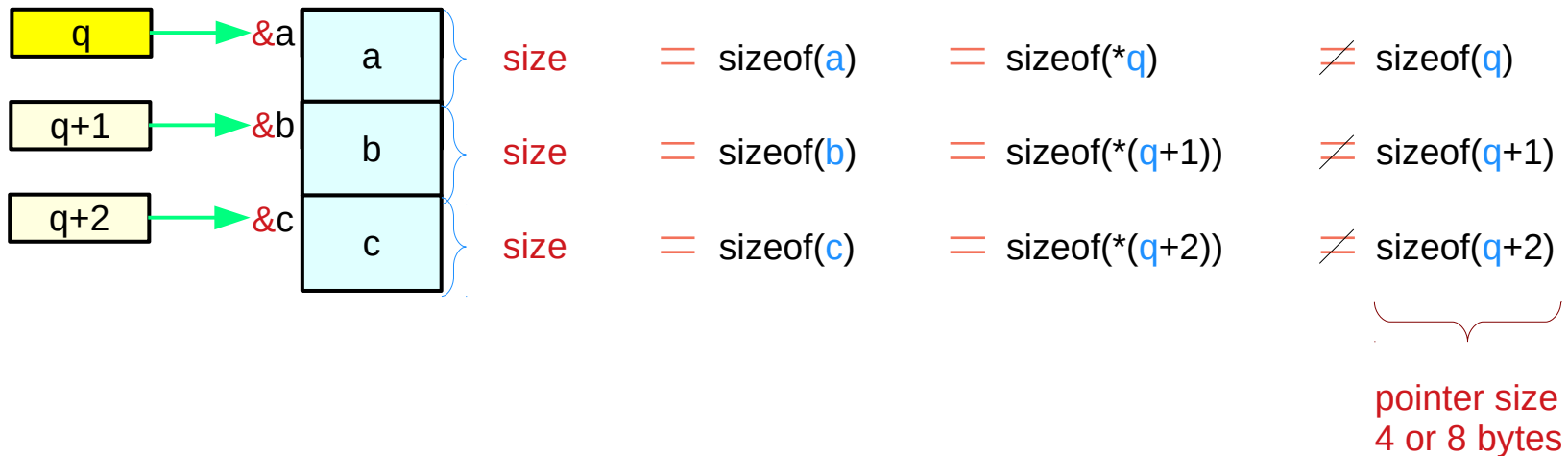

Pointers to abstract data

T *p;

T X, Y, Z;

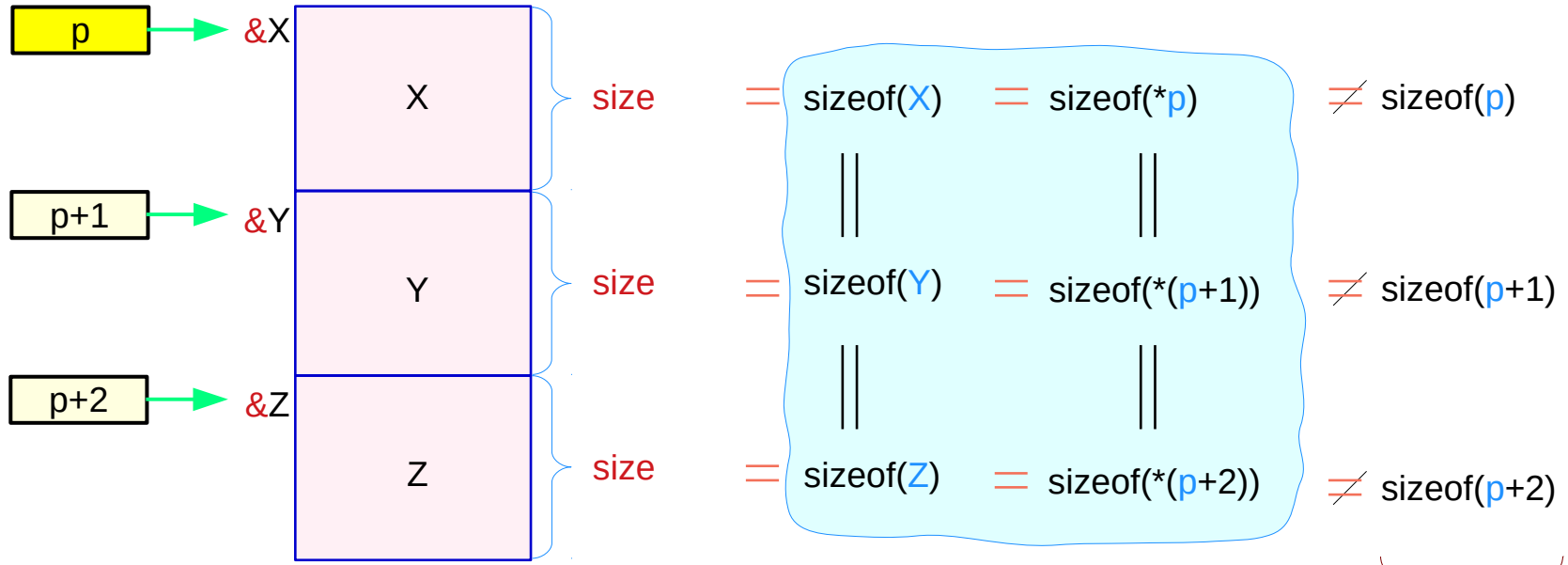

pointer

abstract data

pointer size
4 or 8 bytes

type array
value start address
increment size --- size

Virtual pointers in a multi-dimensional array

$p[i] :: T1$

$*p[i], *p[i+1] :: T2$

$T1 \ p[i][N];$

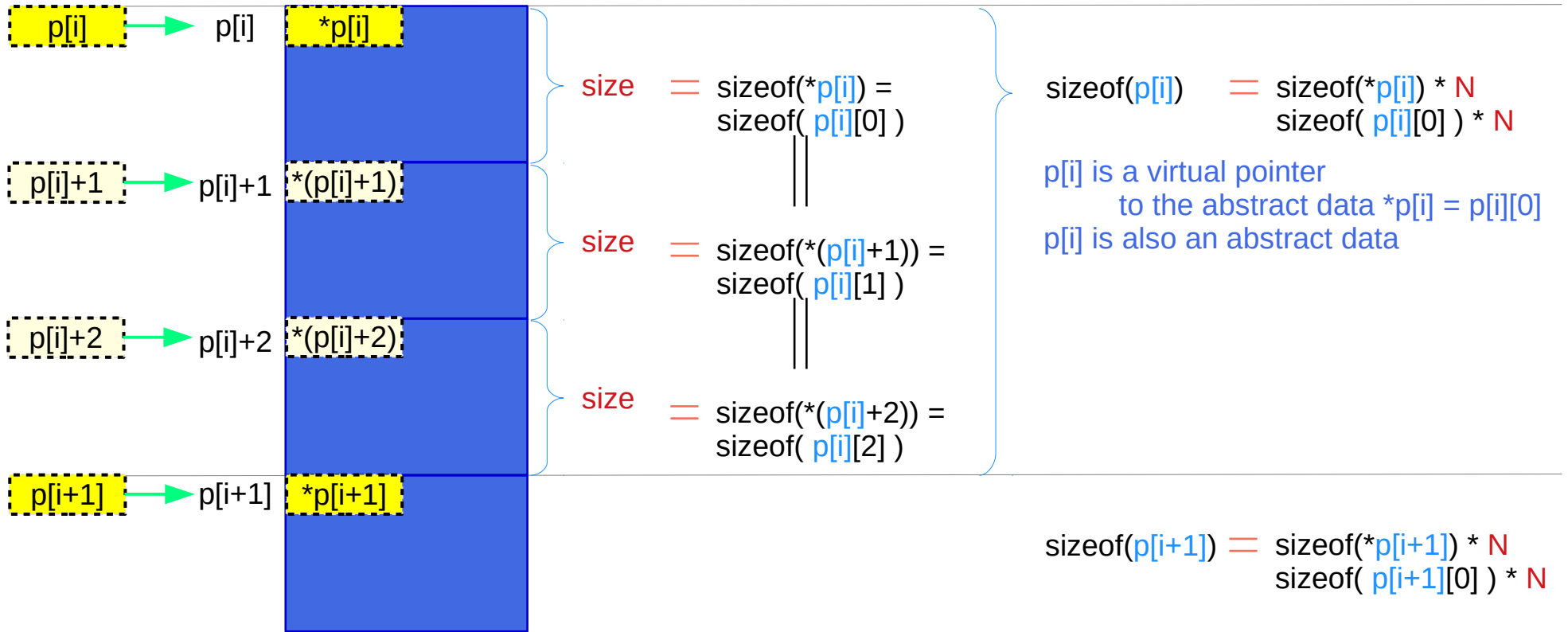

T1

int (*) [4]
 int (*) [3][4]

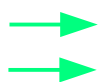

T2

int [4]
 int [3][4]

⊂ int (*)
 ⊂ int (*)[4]

Virtual pointers in a multi-dimensional array

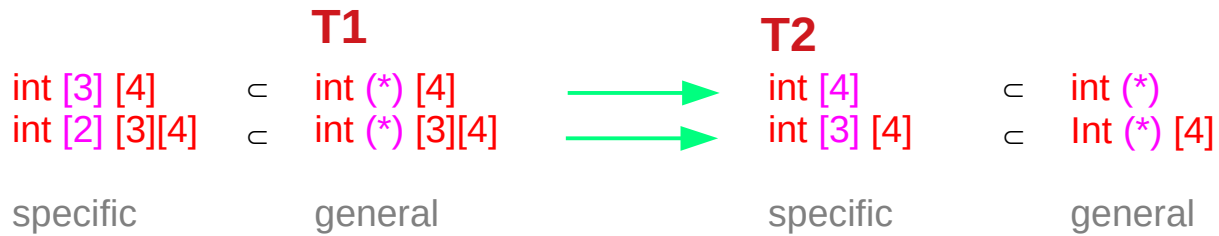

```
typedef int (*T1) [4];  
typedef int (*T1) [3][4];  
  
typedef int T2[4];  
typedef int T2[3][4];
```

T1 a;

T2 b;

T1 references T2
T2 is a dereference of T1

T1 is a pointer type
T2 is an array type
T1 has one more dimension than T2

Virtual array pointer and its increment size

int **c[2][3][4]**;

c[i][j]

int **[4]**
int (*)

sizeof(c[i][j]) =

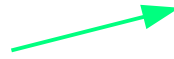

c[i][j][k]

int
int

sizeof(c[i][j][k]) * **4**

- abstract data type
- array pointer type

= sizeof(int) * **4**

int **c[2][3][4]**;

c[i]

int **[3][4]**
int (*)[4]

sizeof(c[i]) =

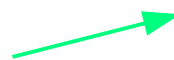

c[i][j]

int [4]
int (*)

sizeof(c[i][j]) * **3**

- abstract data type
- array pointer type

= sizeof(int) * **4 * 3**

int **c[2][3][4]**;

c

int **[2][3][4]**
int (*)[3][4]

sizeof(c) =

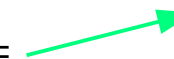

c[i]

int [3][4]
int (*)[4]

sizeof(c[i]) * **2**

- abstract data type
- array pointer type

= sizeof(int) * **4 * 3 * 2**

Virtual array pointer – types and sizes

Types – array pointers

`int (*) [3][4]`

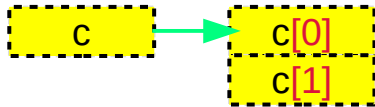

`int (*) [4]`

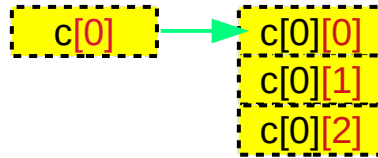

`int [4]`

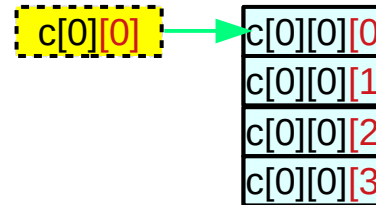

Sizes – abstract data

`sizeof(c)`

`sizeof(c[0]) * 2`

`sizeof(c[0][0]) * 2 * 3`

`sizeof(c[0][0][0]) * 2 * 3 * 4`

`sizeof(int [2][3][4])`

`sizeof(int [2][3][4]) = 96`

`sizeof(int (*)[3][4]) = 4 / 8`

`sizeof(c[0])`

`sizeof(c[0][0]) * 3`

`sizeof(c[0][0][0]) * 3 * 4`

`sizeof(int [3][4])`

`sizeof(int [3][4]) = 48`

`sizeof(int (*)[4]) = 4 / 8`

`sizeof(c[0][0])`

`sizeof(c[0][0][0]) * 4`

`sizeof(int [4])`

`sizeof(int [4]) = 16`

`sizeof(int (*) = 4 / 8`

`sizeof(c[0][0][0])`

`sizeof(int)`

`sizeof(int) = 4`

Sizes of virtual array pointers : c, c[i], c[i][j]

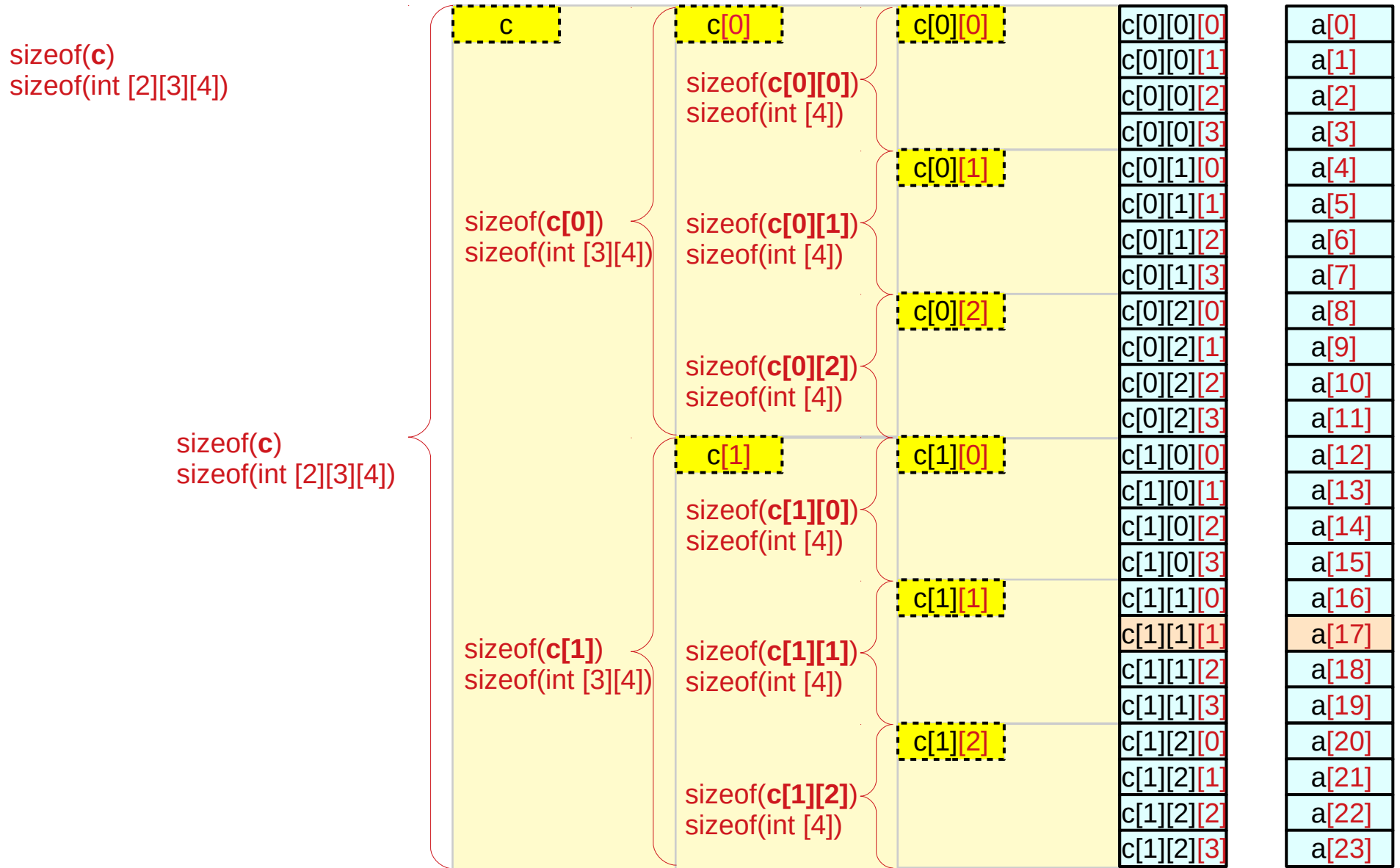

Abstract Data Types: c , $c[i]$, $c[i][j]$

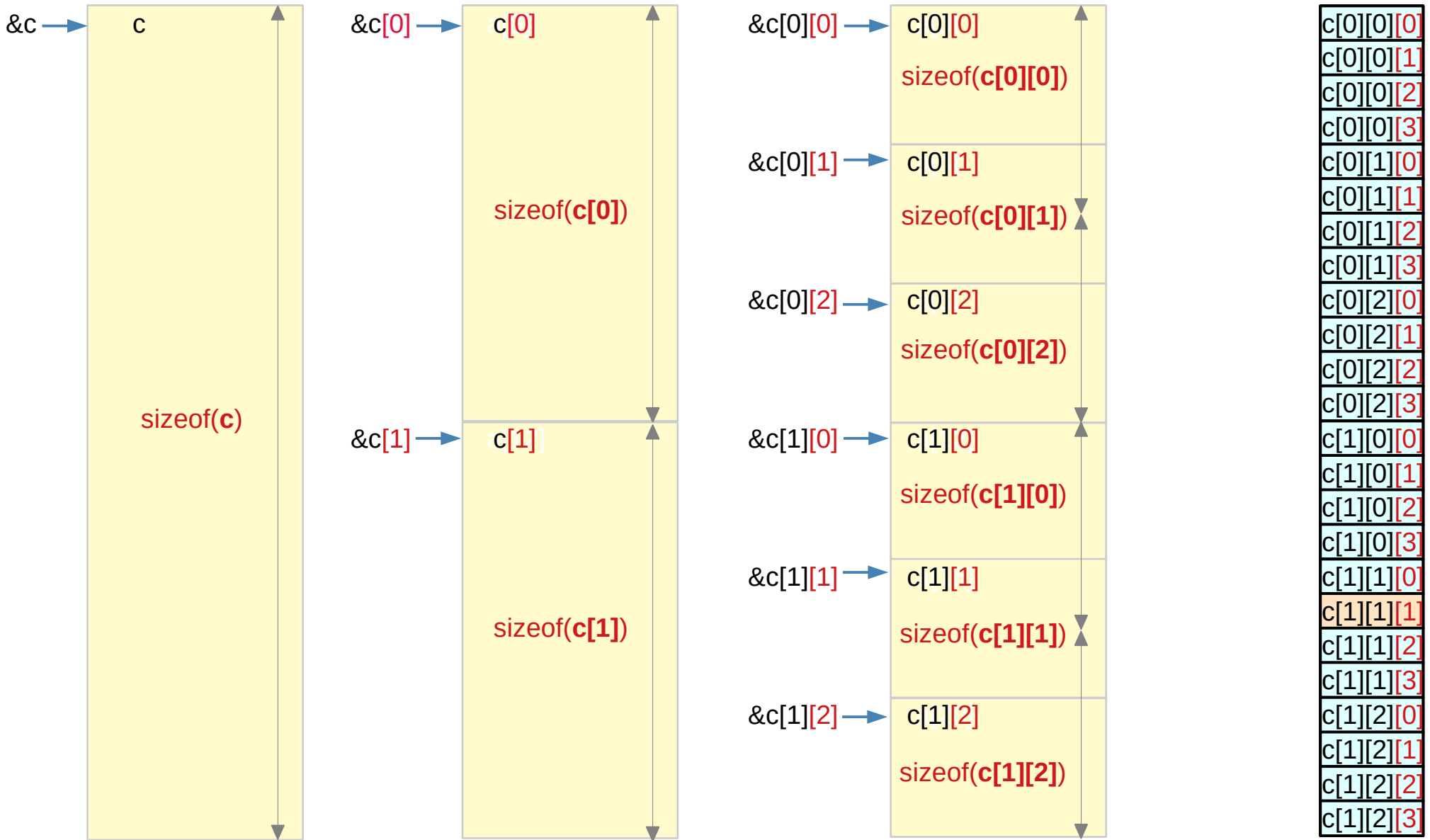

Virtual array pointer – values (addresses)

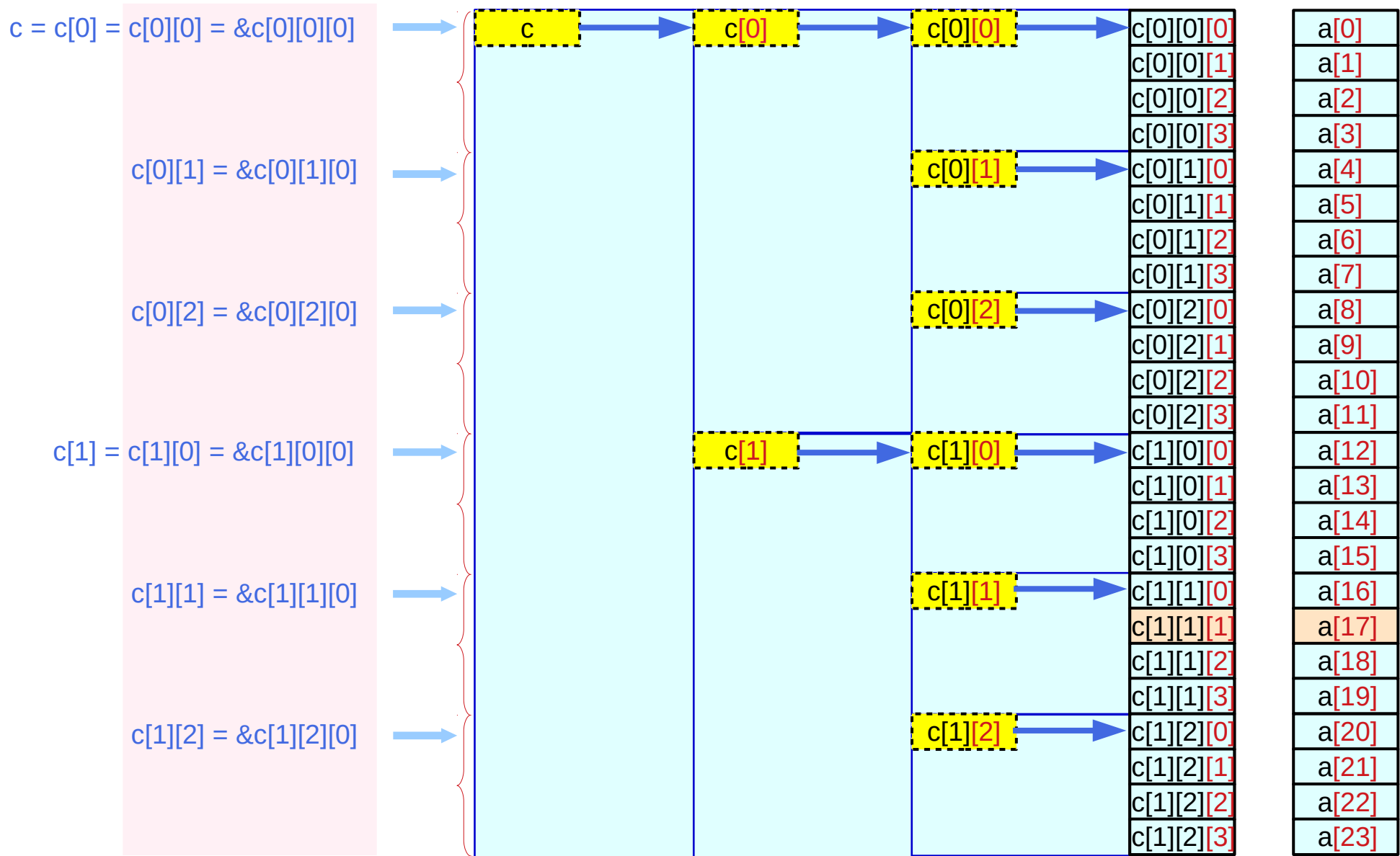

Virtual array pointer – vertical displacement

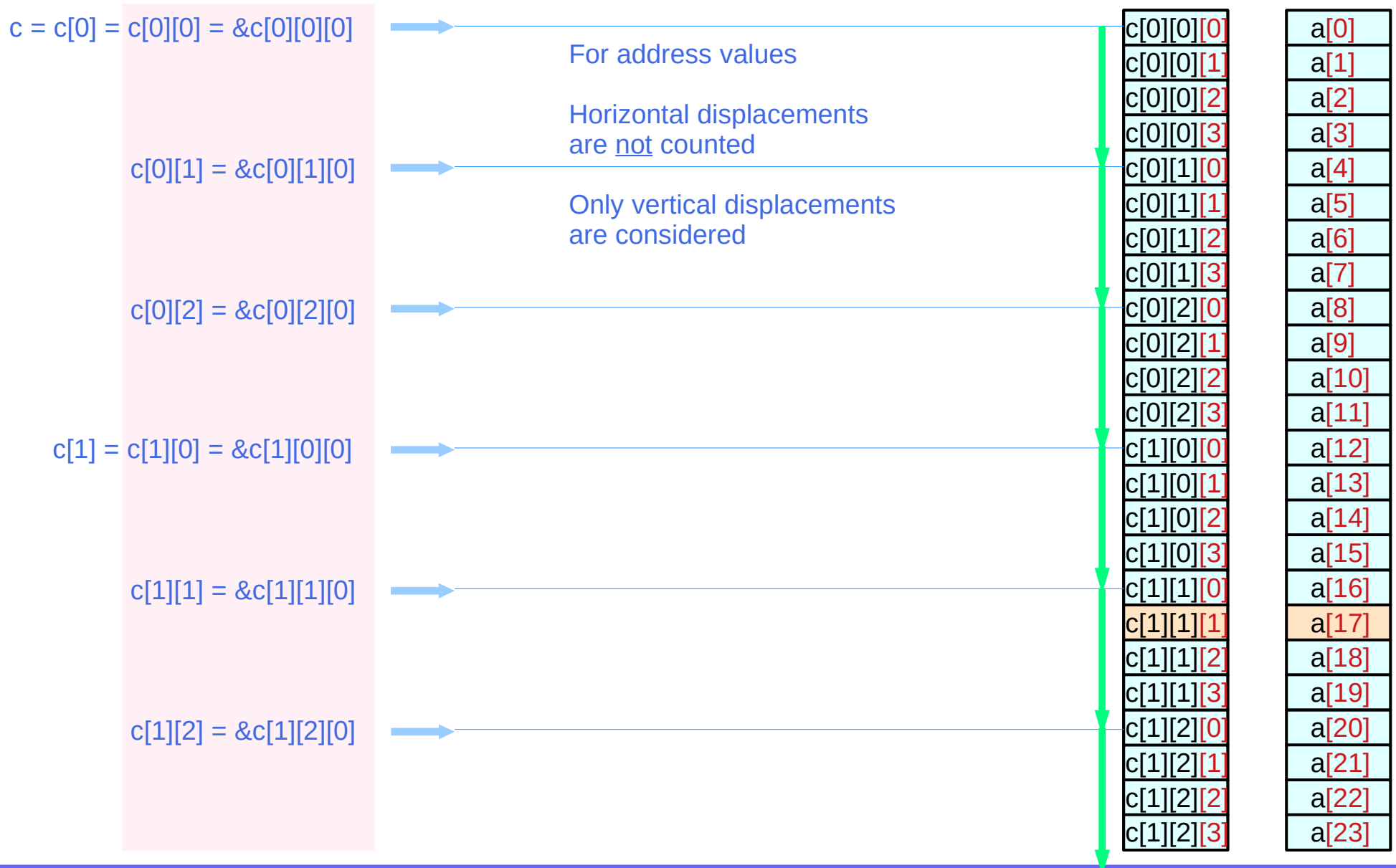

Virtual array pointer – values and types

$c = c[0] = c[0][0] = \&c[0][0][0]$ means \rightarrow
 $c[0][1] = \&c[0][1][0]$ means \rightarrow
 $c[0][2] = \&c[0][2][0]$ means \rightarrow
 $c[1] = c[1][0] = \&c[1][0][0]$ means \rightarrow
 $c[1][1] = \&c[1][1][0]$ means \rightarrow
 $c[1][2] = \&c[1][2][0]$ means \rightarrow

| |
|--|
| $value(c) = value(c[0]) = value(c[0][0]) = value(\&c[0][0][0])$ $type(c) \neq type(c[0]) \neq type(c[0][0]) = type(\&c[0][0][0])$ $int (*) [3][4] \quad int (*) [4] \quad int * \quad int *$ |
| $value(c[0][1]) = value(\&c[0][1][0])$ $type(c[0][1]) = type(\&c[0][1][0])$ $int * \quad int *$ |
| $value(c[0][2]) = value(\&c[0][2][0])$ $type(c[0][2]) = type(\&c[0][2][0])$ $int * \quad int *$ |
| $value(c[1]) = value(c[1][0]) = value(\&c[1][0][0])$ $type(c[1]) \neq type(c[1][0]) = type(\&c[1][0][0])$ $int (*) [4] \quad int * \quad int *$ |
| $value(c[1][1]) = value(\&c[1][1][0])$ $type(c[1][1]) = type(\&c[1][1][0])$ $int * \quad int *$ |
| $value(c[1][2]) = value(\&c[1][2][0])$ $type(c[1][2]) = type(\&c[1][2][0])$ $int * \quad int *$ |

Array pointers in a multi-dimensional array

```
int c [2][3][4];
```

abstract data `int [2] [3][4]`
array pointer `int (*) [3][4]`

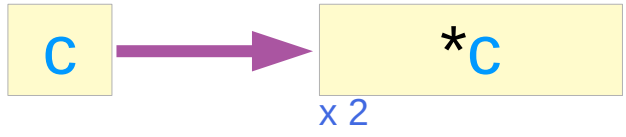

`int [3] [4]` abstract data
`int (*) [4]` array pointer

abstract data `int [3] [4]`
array pointer `int (*) [4]`

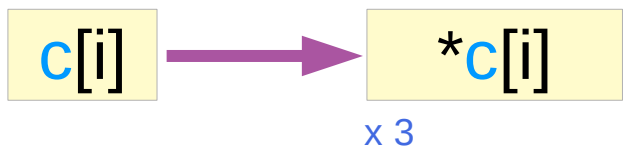

`int [4]` abstract data
`int (*)` array pointer

abstract data `int [4]`
array pointer `int (*)`

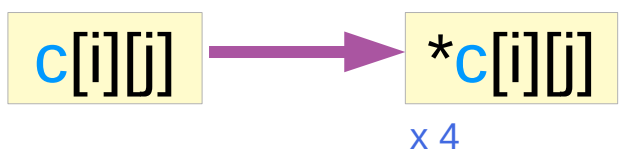

`int` primitive data

Virtual array pointers

```
int c [2][3][4];
```

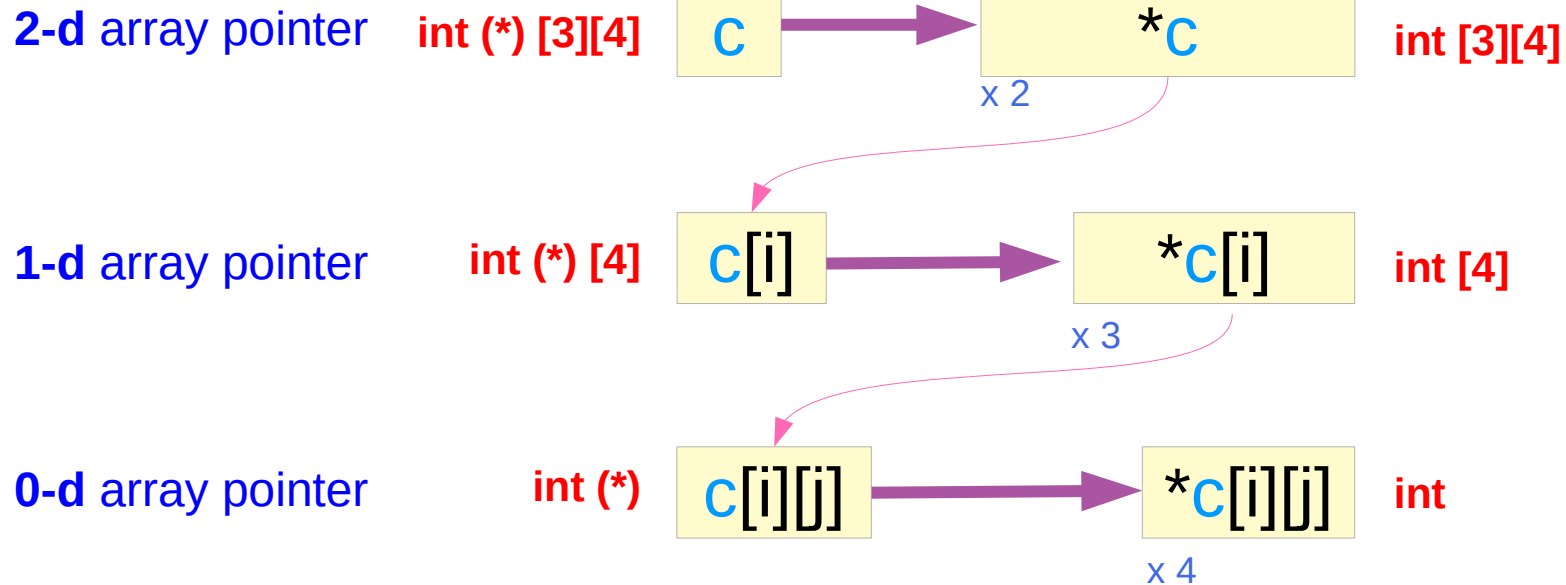

all these pointers are virtual, and take no actual memory locations

exploiting the **contiguity** of allocated memory locations

Virtual array pointers and increment sizes

```
int c [2][3][4];
```

the size of a pointer type is fixed
Here, the sizes of virtual pointers are shown
i.e, the sizes of different abstract data types

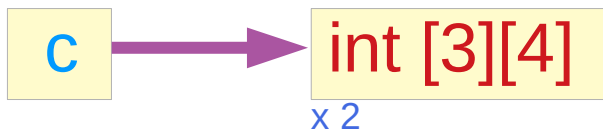

sizeof(c) = sizeof(int [2][3][4])
sizeof(*c) = sizeof(int [3][4])

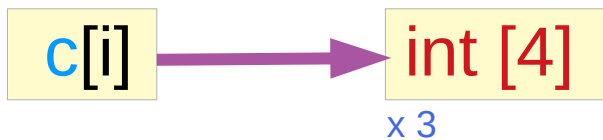

sizeof(c[i]) = sizeof(int [3][4])
sizeof(*c[i]) = sizeof(int [4])



sizeof(c[i][j]) = sizeof(int [4])
sizeof(*c[i][j]) = sizeof(int)

Virtual array pointers and increment sizes

```
int c [2][3][4];
```

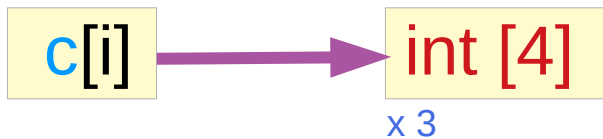
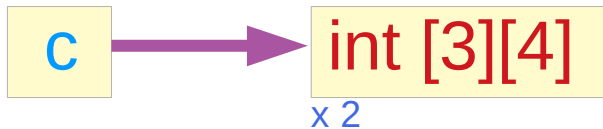

size of a virtual array pointer

=

size of the pointed abstract data type

*

the number of such types

sizeof(c)

= sizeof(*c) * 2

sizeof(c[i])

= sizeof(*c[i]) * 3

sizeof(c[i][j])

= sizeof(*c[i][j]) * 4

Hierarchical nested array pointers

```
int c [2][3][4];
```

c points to a **2-d** array
increment size: $\text{sizeof}(\text{int}) * 2 * 3 * 4$

c[i] points to an **1-d** array
increment size: $\text{sizeof}(\text{int}) * 3 * 4$

c[i][j] points to an integer
increment size: $\text{sizeof}(\text{int}) * 4$

int (*) [3][4]



int (*) [4]

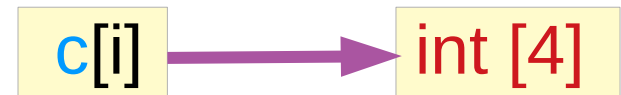

int (*)



Virtual array pointer types and sizes

```
int c [2][3][4];
```

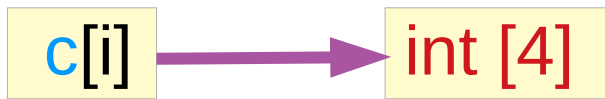
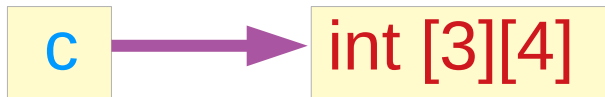

`c` `int (*)[3][4]`
`sizeof(int (*) [3][4])` = pointer size \neq `sizeof(c)`

`c[i]` `int (*) [4]`
`sizeof(int (*) [4])` = pointer size \neq `sizeof(c[i])`

`c[i][j]` `int [4]`
`sizeof(int [4])` = pointer size \neq `sizeof(c[i][j])`

not real array pointers
virtual array pointers



4 bytes for 32-bit machines
8 bytes for 64-bit machines

Sub-array properties in multi-dimensional arrays

`int c [2][3][4];`  3-d access `c [i][j][k]`

| | | |
|--------------------|----------------------|-----------------------------|
| 2-d array pointer | <code>c</code> | <code>int (*) [3][4]</code> |
| 1-d array pointers | <code>c[i]</code> | <code>int (*) [4]</code> |
| 0-d array pointers | <code>c[i][j]</code> | <code>int (*)</code> |

Hierarchical Sub-arrays in a 3-d array

```
int c [L][M][N];
```

```
c [i][j][k]
```

left-to-right associativity

```
c[i][j][k]
```

| | | |
|---------|-----|--------|
| c | [i] | [j][k] |
| c[i] | [j] | [k] |
| c[i][j] | [k] | |

Array Names and Types

| | |
|---------|-----------------|
| c | 3-d array names |
| c[i] | 2-d array names |
| c[i][j] | 1-d array names |

Pointers to hierarchical sub-arrays

| | |
|----------------|-------------------|
| int (*) [M][N] | 2-d array pointer |
| int (*) [N] | 1-d array pointer |
| int (*) | 0-d array pointer |

| | |
|-------------|-------------|
| &c[i][j][k] | = c[i][j]+k |
| &c[i][j] | = c[i]+j |
| &c[i] | = c+i |

| | |
|-------------|-----------|
| &c[i][j][0] | = c[i][j] |
| &c[i][0] | = c[i] |
| &c[0] | = c |

3-d access pattern $c[i][j][k]$

General requirements

```
&c[i][j][k] = c[i][j]+k  
&c[i][j]   = c[i]+j  
&c[i]      = c+i
```

```
&c[i][j][0] = c[i][j]  
&c[i][0]    = c[i]  
&c[0]       = c
```

Pointer array approach

```
int** c[2];  
int*  b[2*3];  
int   c[2*3*4];
```

```
c[i][j][k] :: int  
c[i][j]    :: int *  
c[i]       :: int **
```

```
c[i] ← &b[i*3]  
b[j] ← &a[j*4]
```

Hierarchical Pointer Array Constraints

Abstract Data Type

Array pointer approach

```
int c[2][3][4];
```

```
c[i][j][k] :: int  
c[i][j]    :: int [4]  
c[i]       :: int (*) [4]
```

```
c[i][j] = &c[i][j][0]  
c[i]    = &c[i][0][0]  
c       = &c[0][0][0]
```

Virtual Array Pointer Constraints

Abstract Data Type

3-d access pattern $c[i][j][k]$ – array pointer approach

General requirements

```
&c[i][j][k] = c[i][j]+k  
&c[i][j]   = c[i]+j  
&c[i]      = c+i
```

```
&c[i][j][0] = c[i][j]  
&c[i][0]    = c[i]  
&c[0]       = c
```



Array pointer approach

```
int c[2][3][4];
```

```
c[i][j][k] :: int  
c[i][j]   :: int [4]  
c[i]      :: int (*) [4]  
c         :: int (*) [3][4]
```

```
c[i][j] = &c[i][j][0]  
c[i]    = &c[i][0][0]  
c       = &c[0][0][0]
```

Virtual Array Pointer Constraints

Abstract Data Type

Using virtual array pointers

```
int c [2][3][4];
```



```
c [i][j][k];
```

constraints

```
c = &c[0][0][0]
```

```
c[i] = &c[i][0][0]
```

```
c[i][j] = &c[i][j][0]
```

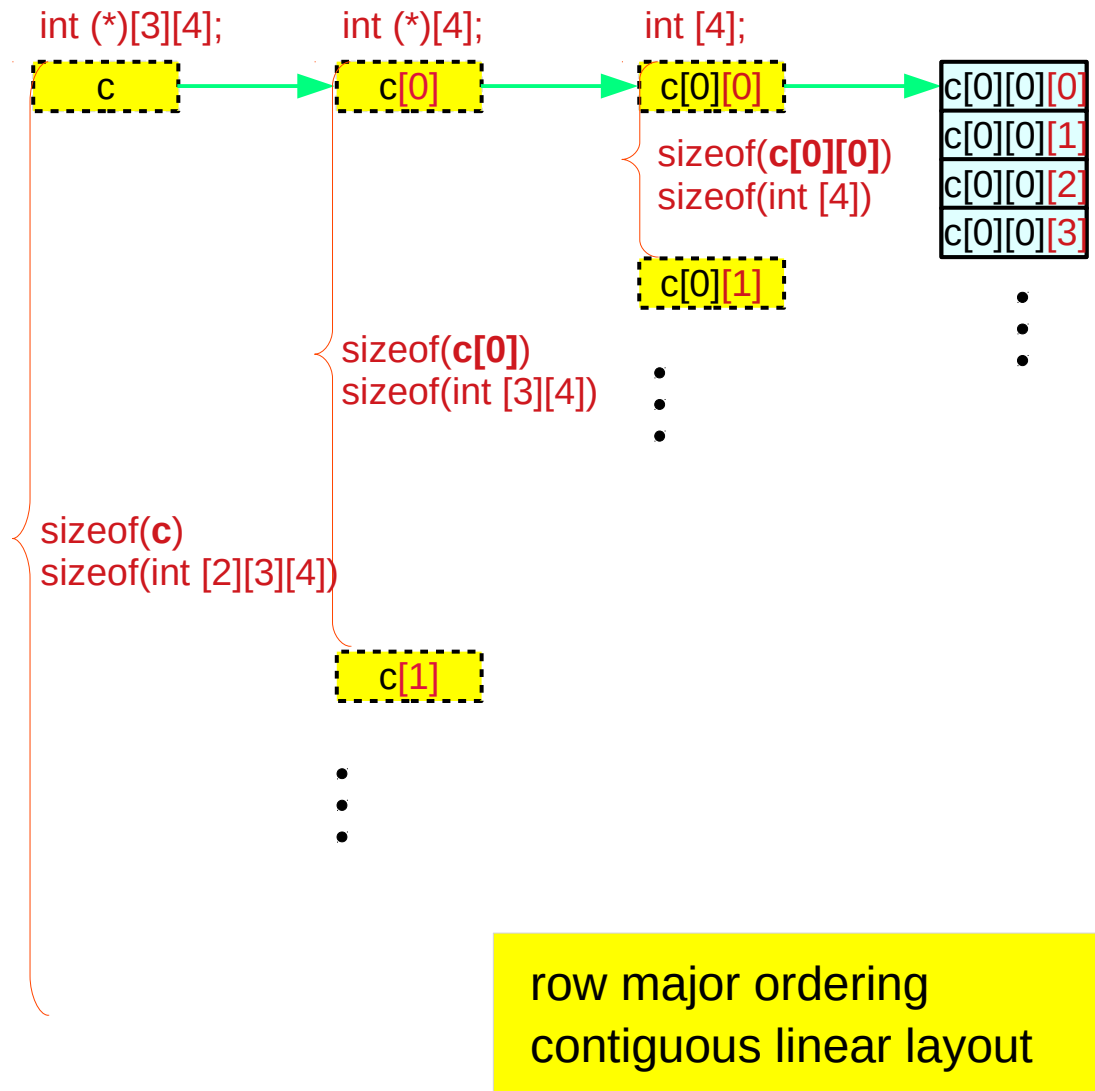

Types of `c[i]` and `c[i][j]`

`c [i][j][k];`

`&c[i][j][0] = c[i][j]`
`&c[i][0] = c[i]`
`&c[0] = c`

`&c[i][j][k] = c[i][j]+k`
`&c[i][j] = c[i]+j`
`&c[i] = c+i`

`int c [2][3][4];`

`c[i]` virtual array pointer of the type `int (*) [4]`

`c[i][j]` : the name of 1-d array with 4 integers

`c[i][j]` (virtual array) pointer of the type `int (*)`

`c[i][j][k]` : an element of a 4-integer array

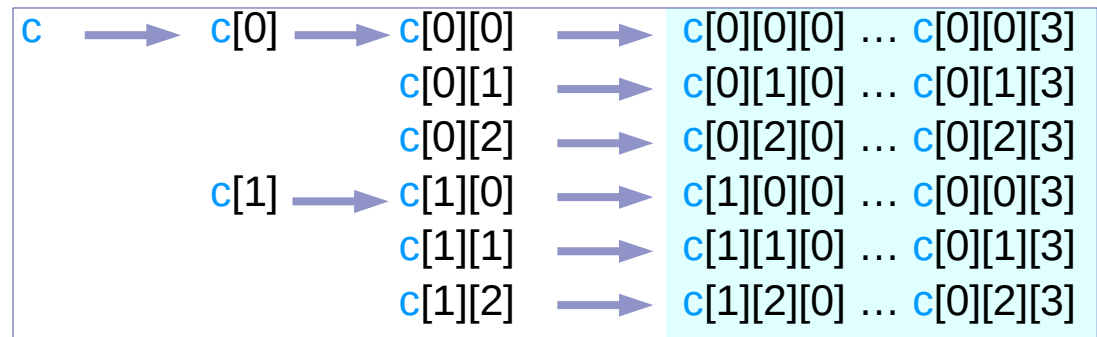

`int (*) [3][4]` `int (*) [4]` `int [4]` `int` `...` `int`

pointers to a 2-d array pointers to a 1-d array 1-d array names

leading element of 4-integer array

Values of $c[i]$ and $c[i][j]$

```
c [i][j][k];
```

```
&c[i][j][0] = c[i][j]  
&c[i][0]     = c[i]  
&c[0]       = c
```

```
&c[i][j][k] = c[i][j]+k  
&c[i][j]    = c[i]+j  
&c[i]       = c+i
```

```
int c [2][3][4];
```

```
                c[i][j] = &c[i][j][0]  
c → c[0] → c[0][0] == &c[0][0][0]  
                c[0][1] == &c[0][1][0]  
                c[0][2] == &c[0][2][0]  
                c[1] → c[1][0] == &c[1][0][0]  
                c[1][1] == &c[1][1][0]  
                c[1][2] == &c[1][2][0]
```

```
                c[i] = &c[i][0]  
c → c[0] == &c[0][0]  
                == &c[0][1]  
                == &c[0][2]  
                c[1] == &c[1][0]  
                == &c[1][1]  
                == &c[1][2]
```

c[i] and c[i][j] : virtual array pointers

c [i][j][k];

$\&c[i][j][0] = c[i][j]$
 $\&c[i][0] = c[i]$
 $\&c[0] = c$

$\&c[i][j][k] = c[i][j] + k$
 $\&c[i][j] = c[i] + j$
 $\&c[i] = c + i$

int c [2][3][4];

c[i] virtual array pointer of the type **int (*) [4]**
c[i][j] : a 4-element 1-d array name

$*(c[0]+0) = c[0][0]$

c[0] is the address of **c[0][0]**

$*(c[1]+0) = c[1][0]$

c[1] is the address of **c[1][0]**

c[i][j] virtual array pointer of the type **int (*)**
c[i][j][0] : leading element of a 4-integer array

$*(c[0][0]+0) = c[0][0][0]$

c[0][0] is the address of **c[0][0][0]**

$*(c[0][1]+0) = c[0][1][0]$

c[0][1] is the address of **c[0][1][0]**

$*(c[0][2]+0) = c[0][2][0]$

c[0][2] is the address of **c[0][2][0]**

$*(c[1][0]+0) = c[1][0][0]$

c[1][0] is the address of **c[1][0][0]**

$*(c[1][1]+0) = c[1][1][0]$

c[1][1] is the address of **c[1][1][0]**

$*(c[1][2]+0) = c[1][2][0]$

c[1][2] is the address of **c[1][2][0]**

Values of $c[i]$ and $c[i][j]$

$c[i][j][k];$

$\&c[i][j][0] = c[i][j]$
 $\&c[i][0] = c[i]$
 $\&c[0] = c$

$\&c[i][j][k] = c[i][j] + k$
 $\&c[i][j] = c[i] + j$
 $\&c[i] = c + i$

$\text{int } c[2][3][4];$

virtual array pointers

in each row in the following figure
have the same value (address value)

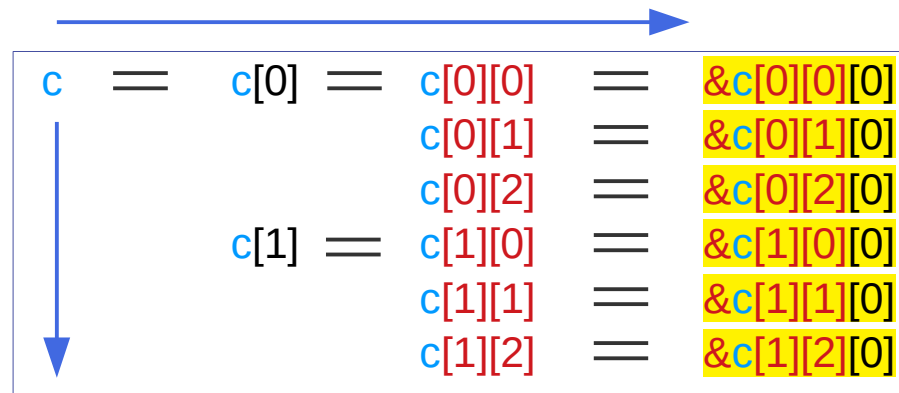

Horizontal displacements are not counted
only **vertical displacements** are considered
for address values

$c[i][j] = \&c[i][j][0]$
 $c[i] = \&c[i][0][0]$
 $c = \&c[0][0][0]$

Finding address values of $c[i]$ and $c[i][j]$

$c[i][j][k];$

$\&c[i][j][0] = c[i][j]$
 $\&c[i][0] = c[i]$
 $\&c[0] = c$

$\&c[i][j][k] = c[i][j] + k$
 $\&c[i][j] = c[i] + j$
 $\&c[i] = c + i$

$int\ c[2][3][4];$

$c[i][j] = \&c[i][j][0]$
 $c[i] = \&c[i][0][0]$
 $c = \&c[0][0][0]$

add [0] to the right

| | | | | | | |
|-----|----------------------|--------|----------------------|-----------|----------------------|----------------|
| c | $\xrightarrow{+[0]}$ | $c[0]$ | $\xrightarrow{+[0]}$ | $c[0][0]$ | $\xrightarrow{+[0]}$ | $\&c[0][0][0]$ |
| | | | | $c[0][1]$ | $\xrightarrow{+[0]}$ | $\&c[0][1][0]$ |
| | | | | $c[0][2]$ | $\xrightarrow{+[0]}$ | $\&c[0][2][0]$ |
| | | $c[1]$ | $\xrightarrow{+[0]}$ | $c[1][0]$ | $\xrightarrow{+[0]}$ | $\&c[1][0][0]$ |
| | | | | $c[1][1]$ | $\xrightarrow{+[0]}$ | $\&c[1][1][0]$ |
| | | | | $c[1][2]$ | $\xrightarrow{+[0]}$ | $\&c[1][2][0]$ |

$int (*) [3][4]$ $int (*) [4]$ $int [4]$ int

delete [0] from the right

| | | | | | | |
|----------------|----------------------|-----------|----------------------|--------|----------------------|-----|
| $\&c[0][0][0]$ | $\xrightarrow{-[0]}$ | $c[0][0]$ | $\xrightarrow{-[0]}$ | $c[0]$ | $\xrightarrow{-[0]}$ | c |
| $\&c[0][1][0]$ | $\xrightarrow{-[0]}$ | $c[0][1]$ | | | | |
| $\&c[0][2][0]$ | $\xrightarrow{-[0]}$ | $c[0][2]$ | | | | |
| $\&c[1][0][0]$ | $\xrightarrow{-[0]}$ | $c[1][0]$ | $\xrightarrow{-[0]}$ | $c[1]$ | | |
| $\&c[1][1][0]$ | $\xrightarrow{-[0]}$ | $c[1][1]$ | | | | |
| $\&c[1][2][0]$ | $\xrightarrow{-[0]}$ | $c[1][2]$ | | | | |

int $int [4]$ $int (*) [4]$ $int (*) [3][4]$

c[i] = c[i][0] relation

```
c [i][j][k];
```

```
&c[i][j][0] = c[i][j]
&c[i][0]    = c[i]
&c[0]      = c
```

```
&c[i][j][k] = c[i][j]+k
&c[i][j]    = c[i]+j
&c[i]       = c+i
```

```
int c [2][3][4];
```

```
c == c[0] == c[0][0] == &c[0][0][0]
```

```
value(c[0]) = &c[0][0][0]
```

```
value(c[0][0]) = &c[0][0][0]
```

```
type(c[0]) = int (*)[4]
```

```
type(c[0][0]) = int [4]
```

```
c[0] = c[0][0] means
value(c[0]) = value(c[0][0])
```



```
c[i][j] = &c[i][j][0]
c[i]    = &c[i][0][0]
c       = &c[0][0][0]
```

Addresses and Values of $c[i]$ and $c[i][0]$

$c[i][j][k];$

$\&c[i][j][0] = c[i][j]$
 $\&c[i][0] = c[i]$
 $\&c[0] = c$

$\&c[i][j][k] = c[i][j] + k$
 $\&c[i][j] = c[i] + j$
 $\&c[i] = c + i$

$int\ c[2][3][4];$

$c \rightarrow c[0] \rightarrow c[0][0] = \&c[0][0][0]$

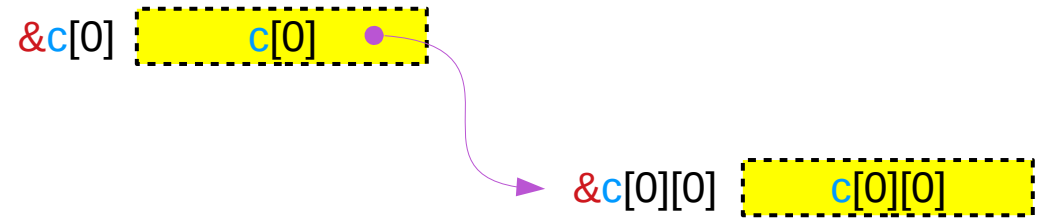

$c = c[0] = c[0][0] \quad \&c[0][0][0]$

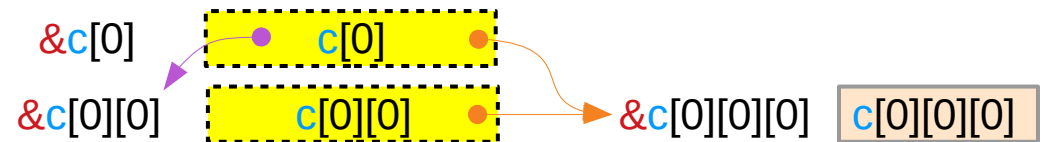

A virtual pointer's address and value are the same

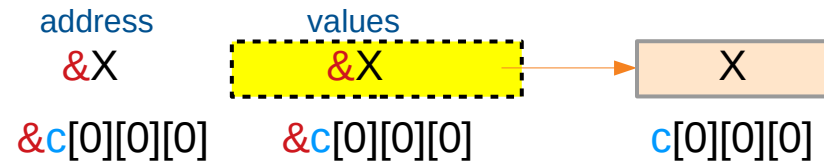

c[i] and c[i][0] point to the same c[i][0][0]

```
c [i][j][k];
```

```
&c[i][j][0] = c[i][j]
&c[i][0]    = c[i]
&c[0]      = c
```

```
&c[i][j][k] = c[i][j]+k
&c[i][j]    = c[i]+j
&c[i]       = c+i
```

```
int c [2][3][4];
```

```
c[i][j] = &c[i][j][0]
c[i]    = &c[i][0][0]
c       = &c[0][0][0]
```

```
c = c[0] = c[0][0] = &c[0][0][0] ← value
int(*)[3][4] int(*)[4] int(*) int ← type
```

```
c[1] = c[1][0] = &c[1][0][0] ← value
int(*)[4] int(*) int ← type
```

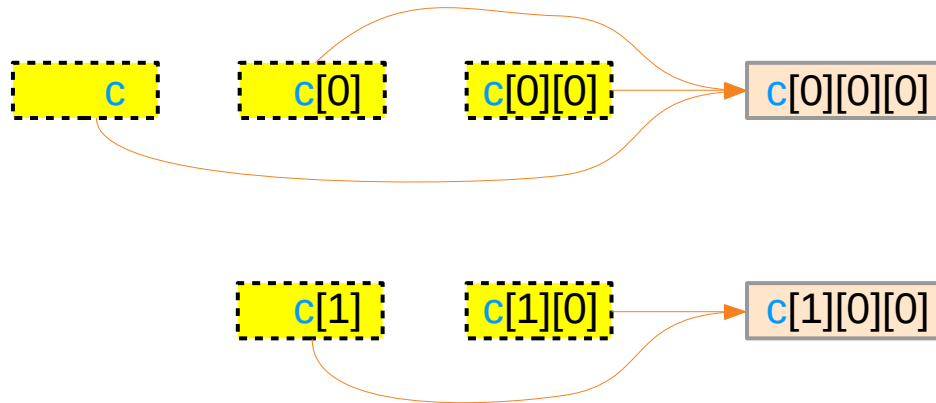

These virtual pointers have different types but the same value (address)

&c[i][0] and &c[i][0][0] – equivalence relations

`c [i][j][k];`

`&c[i][j][0] = c[i][j]`
`&c[i][0] = c[i]`
`&c[0] = c`

`&c[i][j][k] = c[i][j]+k`
`&c[i][j] = c[i]+j`
`&c[i] = c+i`

`int c [2][3][4];`

`c[i][j] = &c[i][j][0]`
`c[i] = &c[i][0][0]`
`c = &c[0][0][0]`

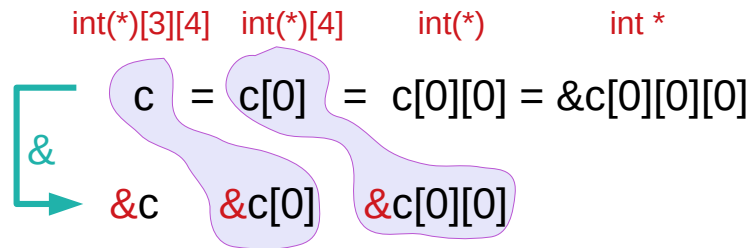

equivalences

`c ≡ &c[0],`
`c[0] ≡ &c[0][0]`
`c[0][0] ≡ &c[0][0][0]`

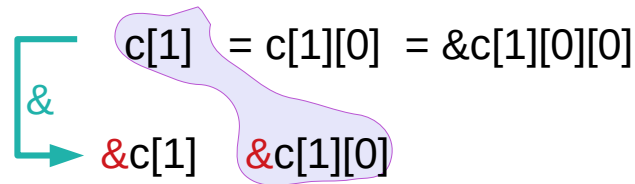

equivalences

`c[1] ≡ &c[1][0]`
`c[1][0] ≡ &c[1][0][0]`

Horizontal displacements are not counted
 only vertical displacements are considered
 for address values

equivalences

`c ≡ &c[0],`
`c[i] ≡ &c[i][0]`
`c[i][0] ≡ &c[i][0][0]`

$c[i] = \&c[i]$ and $c[i][0] = \&c[i][0]$

$c[i][j][k];$

$\&c[i][j][0] = c[i][j]$
 $\&c[i][0] = c[i]$
 $\&c[0] = c$

$\&c[i][j][k] = c[i][j] + k$
 $\&c[i][j] = c[i] + j$
 $\&c[i] = c + i$

$\text{int } c[2][3][4];$

$c[i][j] = \&c[i][j][0]$
 $c[i] = \&c[i][0][0]$
 $c = \&c[0][0][0]$

$c = c[0] = c[0][0] = \&c[0][0][0]$
 $\&c = \&c[0] = \&c[0][0]$

$c[1] = c[1][0] = \&c[1][0][0]$
 $\&c[1] = \&c[1][0]$

A virtual pointer's address and value are the same

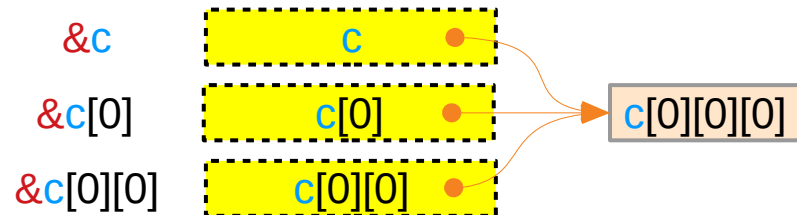

Array Pointers to $c[i][0][0]$

$c[i][j][k];$

$\&c[i][j][0] = c[i][j]$
 $\&c[i][0] = c[i]$
 $\&c[0] = c$

$\&c[i][j][k] = c[i][j] + k$
 $\&c[i][j] = c[i] + j$
 $\&c[i] = c + i$

$\text{int } c[2][3][4];$

$c[i][j] = \&c[i][j][0]$
 $c[i] = \&c[i][0][0]$
 $c = \&c[0][0][0]$

$\&c[i][0][0] \equiv c[i][0]$

$\&c[i][0] \equiv c[i]$

$\&c[i] \equiv c + i$

$= \&c[0][0][0] + i * 3 * 4$

virtual pointers:
the address of a pointer is
the same as its value

delete [0] from the right

$\&c[0][0][0] \xrightarrow{-[0]} c[0][0] \xrightarrow{-[0]} c[0] \xrightarrow{-[0]} c$
 $\&c[1][0][0] \xrightarrow{-[0]} c[1][0] \xrightarrow{-[0]} c[1]$

Array Pointers to $c[i][j][0]$

$c[i][j][k];$

$\&c[i][j][0] = c[i][j]$
 $\&c[i][0] = c[i]$
 $\&c[0] = c$

$\&c[i][j][k] = c[i][j] + k$
 $\&c[i][j] = c[i] + j$
 $\&c[i] = c + i$

$int\ c[2][3][4];$

$c[i][j] = \&c[i][j][0]$
 $c[i] = \&c[i][0][0]$
 $c = \&c[0][0][0]$

$\&c[i][j][0] \equiv c[i][j]$

$\&c[i][j] \equiv c[i] + j$

$= \&c[0][0][0] + i*3*4 + j*4$

delete [0] from the right

| | | | | | | |
|----------------|----------|-----------|----------|--------|----------|-----|
| $\&c[0][0][0]$ | \equiv | $c[0][0]$ | \equiv | $c[0]$ | \equiv | c |
| $\&c[0][1][0]$ | \equiv | $c[0][1]$ | | | | |
| $\&c[0][2][0]$ | \equiv | $c[0][2]$ | | | | |
| $\&c[1][0][0]$ | \equiv | $c[1][0]$ | \equiv | $c[1]$ | | |
| $\&c[1][1][0]$ | \equiv | $c[1][1]$ | | | | |
| $\&c[1][2][0]$ | \equiv | $c[1][2]$ | | | | |

Contiguity Constraints

c [i][j][k];

Virtual Array Pointers and Contiguity

Using array pointers

```
int (*) [N], int (*) [M][N], int (*) [L][M][N], ...
```

Array pointer approach for 3-d access patterns

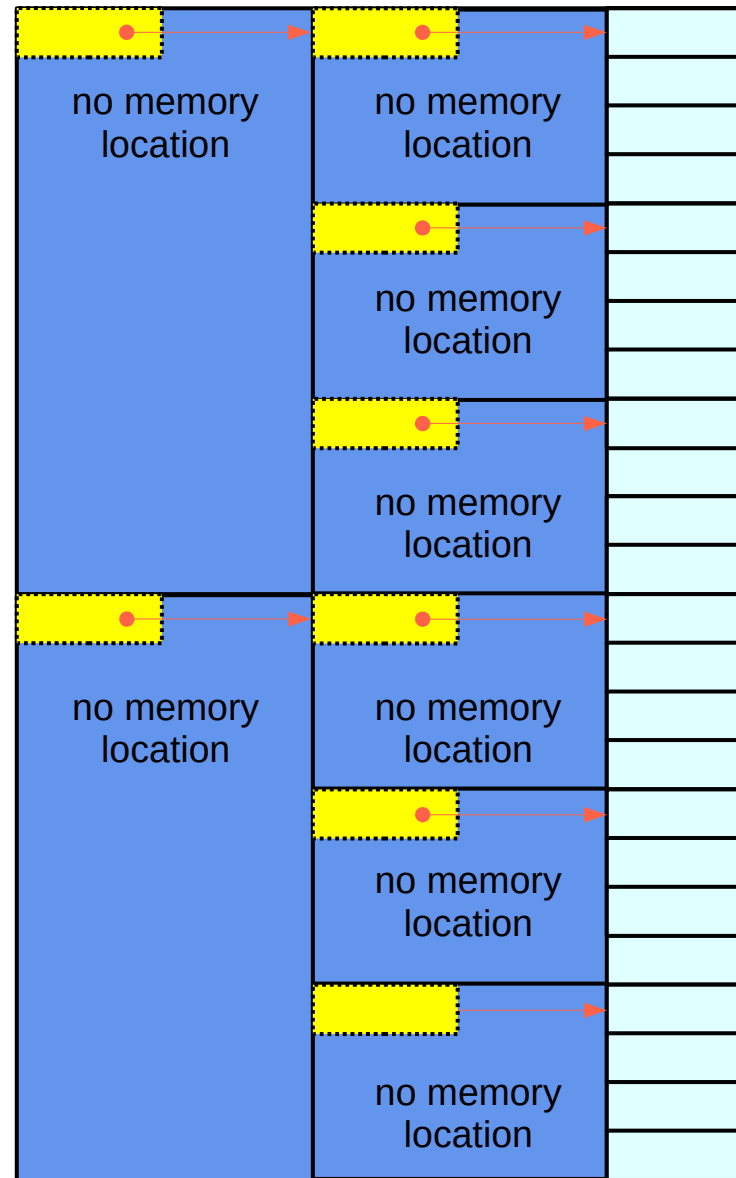

Array Pointer Approach
(pointer to arrays)

Array pointer approach – contiguity constraints

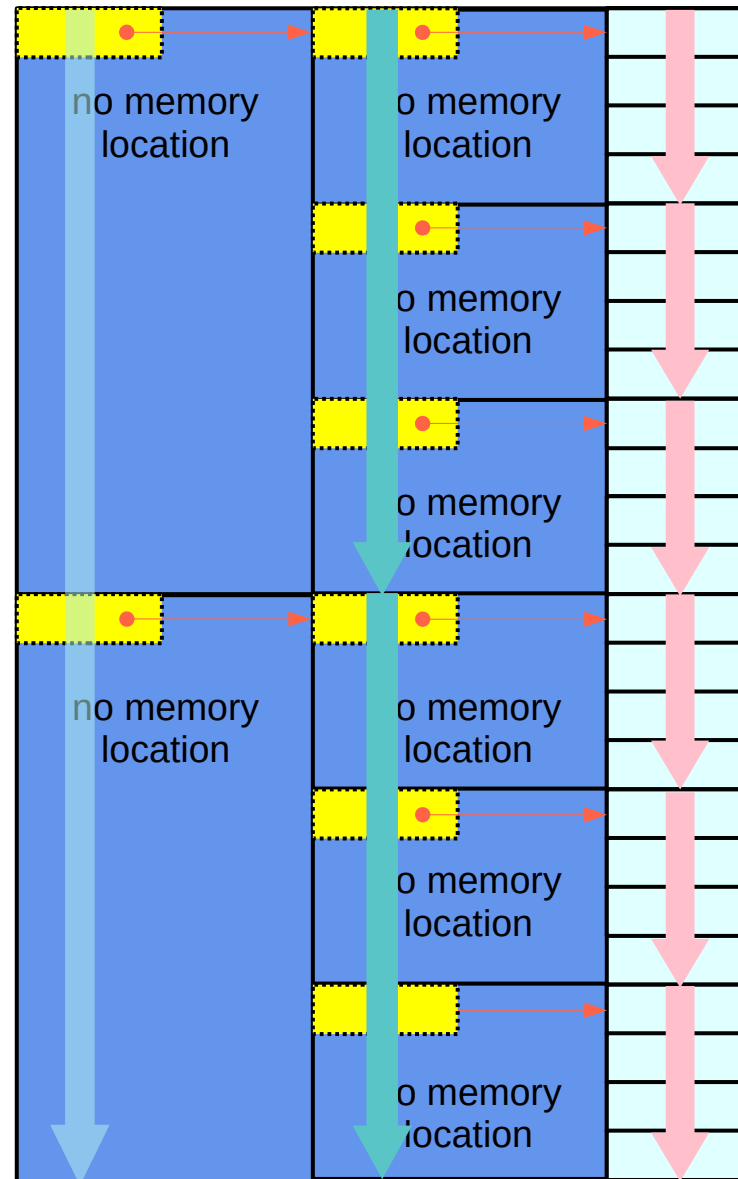

Array **Pointer Approach**
(**pointer to arrays**)

Three contiguity constraints

Pointer Array Approach (array of pointers)

$c[i][j][k]$ \rightarrow $*(c[i][j] + k)$
 $*(c[i][j] + k)$ \rightarrow $*(*(c[i] + j) + k)$
 $*(*(c[i] + j) + k)$ \rightarrow $*(**(*c + i) + j) + k)$

contiguous **1-d** array elements int
contiguous **int** pointers int^*
contiguous **int** double pointers int^{**}

The contiguity constraints are satisfied by the allocated arrays of pointers

Array Pointer Approach (pointer to arrays)

$c[i][j][k]$ \rightarrow $*(c[i][j] + k)$
 $*(c[i][j] + k)$ \rightarrow $*(*(c[i] + j) + k)$
 $*(*(c[i] + j) + k)$ \rightarrow $*(**(*c + i) + j) + k)$

contiguous **1-d** array elements int
contiguous **1-d** arrays $\text{int} [4]$
contiguous **1-d** array pointers $\text{int} (*) [4]$

The contiguity constraints are satisfied by row major ordered linear data layout

$$c[i][j][k] \equiv *(c[i][j] + k)$$

```

c[0][0][0] = *(c[0][0] + 0)
c[0][0][1] = *(c[0][0] + 1)
c[0][0][2] = *(c[0][0] + 2)
c[0][0][3] = *(c[0][0] + 3)
c[0][1][0] = *(c[0][1] + 0)
c[0][1][1] = *(c[0][1] + 1)
c[0][1][2] = *(c[0][1] + 2)
c[0][1][3] = *(c[0][1] + 3)

```

```

•
•
•

```

contiguous 1-d
array elements

c[i][j] :: int *
contiguous 1-d
array elements
int ... 4 elements
sizeof(c[i][j])
sizeof(int) * 4

Address Value

c[i][j] + k

&c[i][j][0] + k * sizeof(*c[i][j])

&c[i][j][0] + k * sizeof(c[i][j][0])

&c[i][j][0] + k * 4

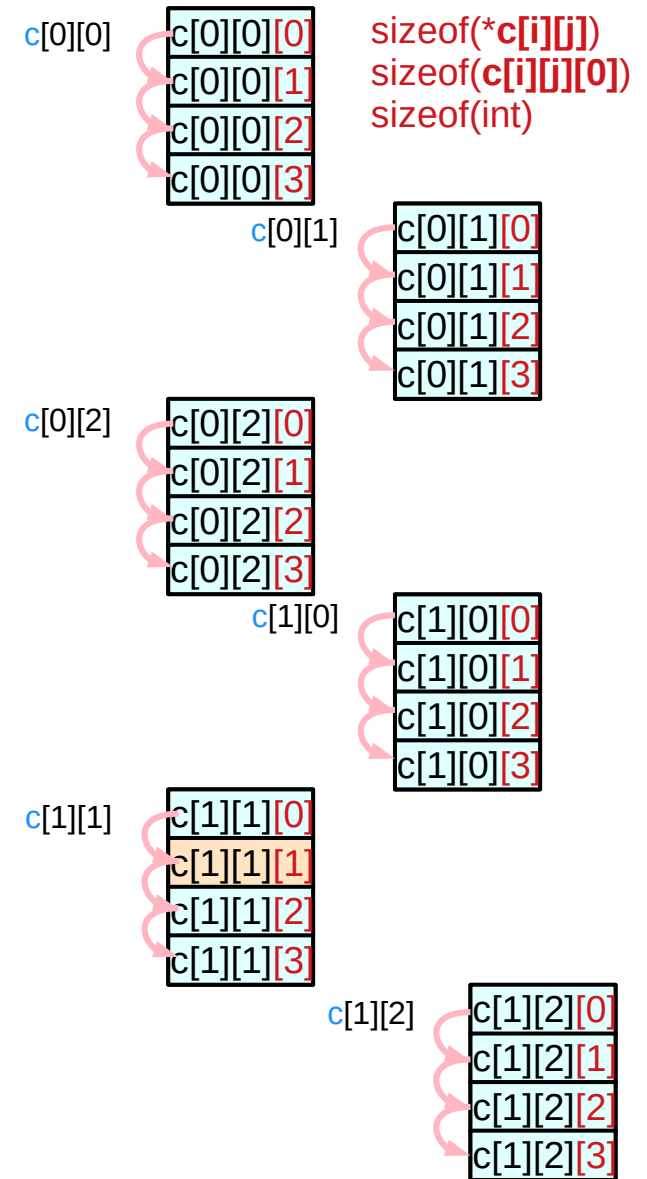

$$c[i][j] \equiv *(c[i] + j)$$

```

c[0][0] = *(c[0] + 0)
c[0][1] = *(c[0] + 1)
c[0][2] = *(c[0] + 2)
c[1][0] = *(c[1] + 0)
c[1][1] = *(c[1] + 1)
c[1][2] = *(c[1] + 2)

```

c[i] :: int (*) [4]
 contiguous 1-d arrays
int[4] = int * ... 3 arrays
 sizeof(**c[i]**)
 sizeof(**c[i][j]**) * 3
 sizeof(**c[i][j][k]**) * 3 * 4
 sizeof(int) * 3 * 4

Address Value

$c[i] + j$

$\&c[i][0][0] + j * \text{sizeof}(*c[i])$

$\&c[i][0][0] + j * \text{sizeof}(c[i][0])$

$\&c[i][0][0] + j * 4 * 4$

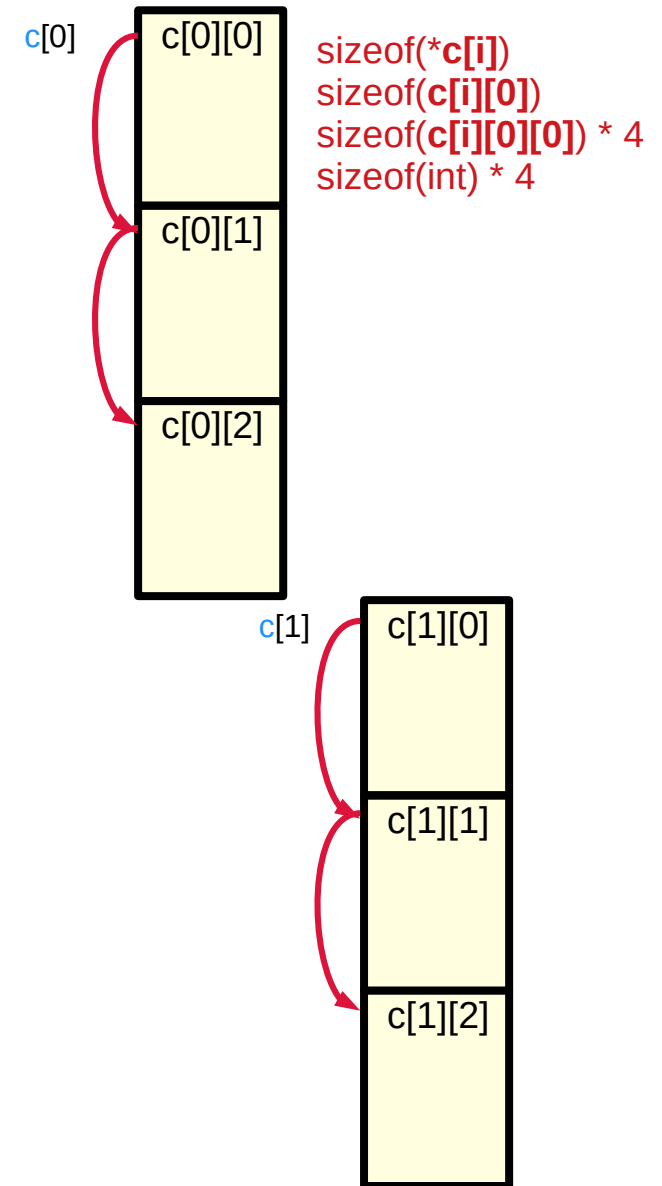

$$c[i] \equiv *(c + i)$$

```
c[0] = *(c + 0)
c[1] = *(c + 1)
```

`c :: int (*) [3][4]`
 contiguous
 1-d array pointers
`int (*) [4]` ... 2 array pointers
`sizeof(c)`
`sizeof(c[i]) * 2`
`sizeof(c[i][j]) * 2 * 3`
`sizeof(c[i][j][k]) * 2 * 3 * 4`
`sizeof(int) * 2 * 3 * 4`

Address Value

`c + i`
`&c[0][0][0] + i * sizeof(*c)`
`&c[0][0][0] + i * sizeof(c[0])`
`&c[0][0][0] + i * 4 * 4 * 3`

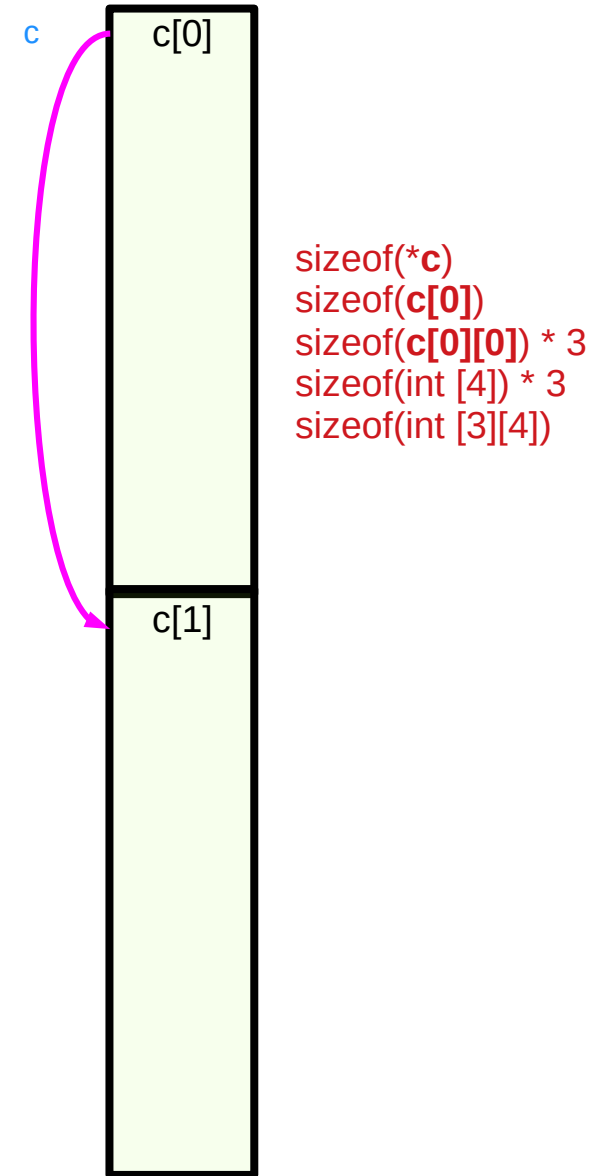

$$c[i] \equiv *(c + i)$$

2-d array pointer c
`int (*) [3][4]`

1-d array pointers $c[i]$
`int (*) [4]`

0-d array pointers $c[i][j]$
`int (*)`

$$c[i] \equiv *(c + i)$$

$$c[i][j] \equiv *(c[i] + j)$$

$$c[i][j][k] \equiv *(c[i][j] + k)$$

address value $c + i$

$\&c[0][0][0] + i * \text{sizeof}(*c)$
 $\&c[0][0][0] + i * \text{sizeof}(c[0])$
 $\&c[0][0][0] + i * 4 * 4 * 3$

address value $c[i] + j$

$\&c[i][0][0] + j * \text{sizeof}(*c[i])$
 $\&c[i][0][0] + j * \text{sizeof}(c[i][0])$
 $\&c[i][0][0] + j * 4 * 4$

address value $c[i][j] + k$

$\&c[i][j][0] + k * \text{sizeof}(*c[i][j])$
 $\&c[i][j][0] + k * \text{sizeof}(c[i][j][0])$
 $\&c[i][j][0] + k * 4$

leading elements

$c[0][0][0]$

leading elements

$c[0][0][0]$

$c[1][0][0]$

leading elements

$c[0][0][0]$

$c[0][1][0]$

$c[0][2][0]$

$c[1][0][0]$

$c[1][1][0]$

$c[1][2][0]$

Equivalence and contiguity

$$*(X+n) \equiv X[n]$$

contiguous index : n

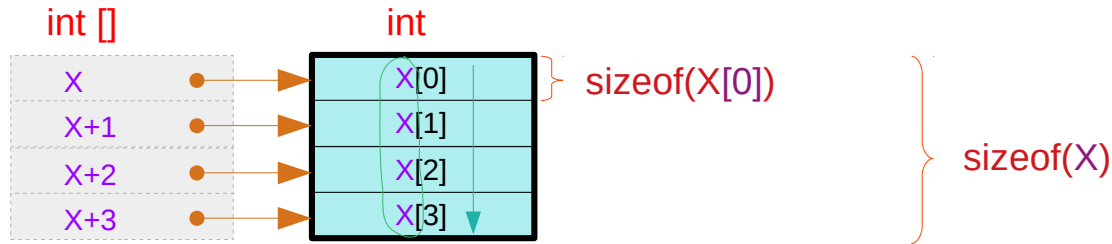

contiguous X[n] for a given X : **int X[4];**

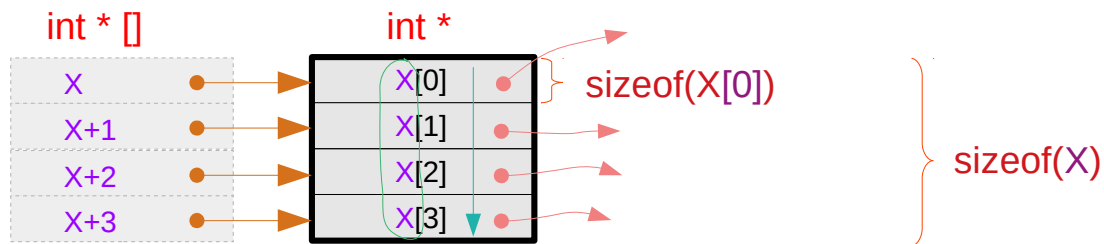

contiguous X[n] for a given X : **int * X[4];**

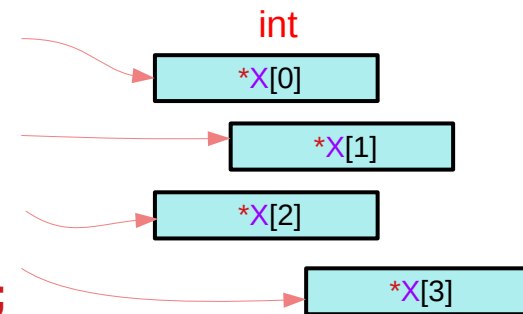

Equivalence

By definition, contiguous memory locations are assumed

$$*(X+n) \equiv X[n]$$

contiguous index : n

$$*(p[m]+n) \leftrightarrow p[m][n]$$

$$(*(p+m))[n]; \leftrightarrow p[m][n];$$

$$X = p[m] \quad \text{contiguous index : } n$$

$$X = p \quad \text{contiguous index : } m$$

For a given $p[m]$ – int pointer / pointer to int pointer

$$*(p[m]+n) \longleftrightarrow p[m][n]$$

for a given $p[m]$ contiguous index : n

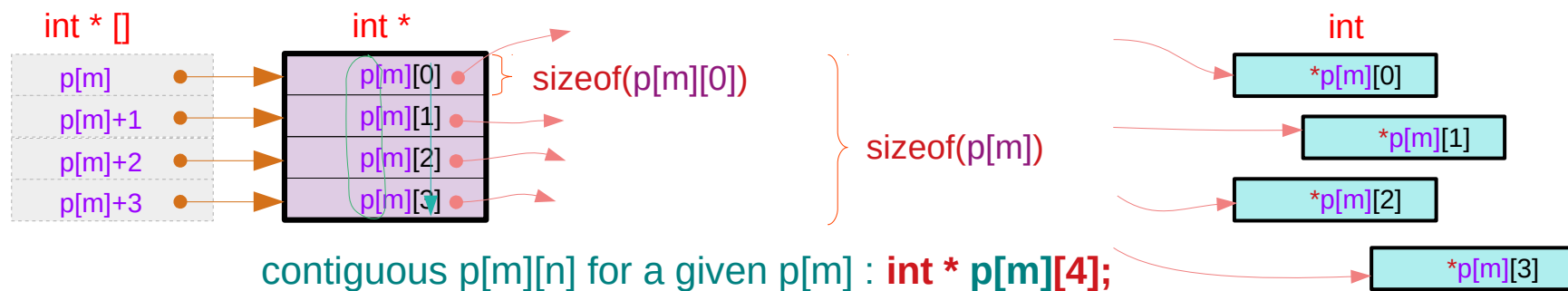
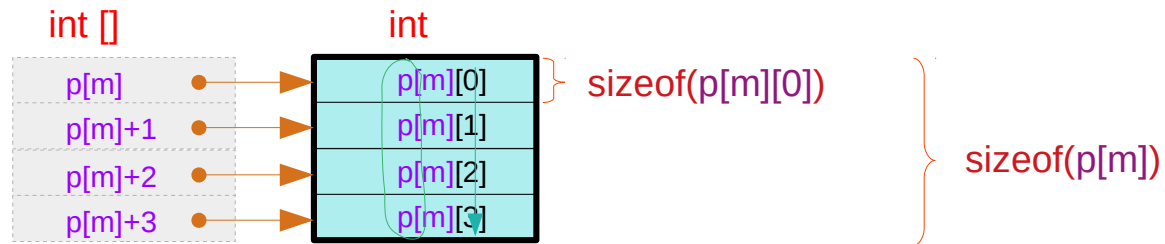

For a given $p[m]$ – pointer to an abstract data

$$*(p[m]+n) \longleftrightarrow p[m][n]$$

for a given $p[m]$ contiguous index : n

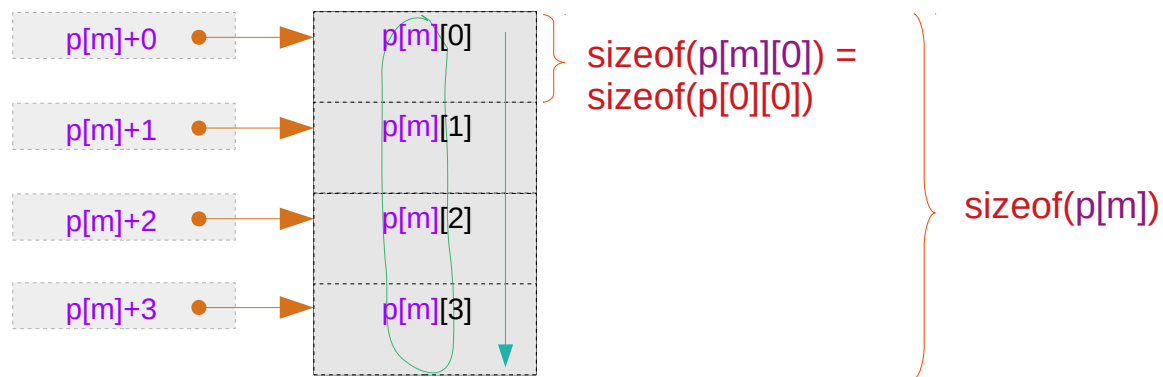
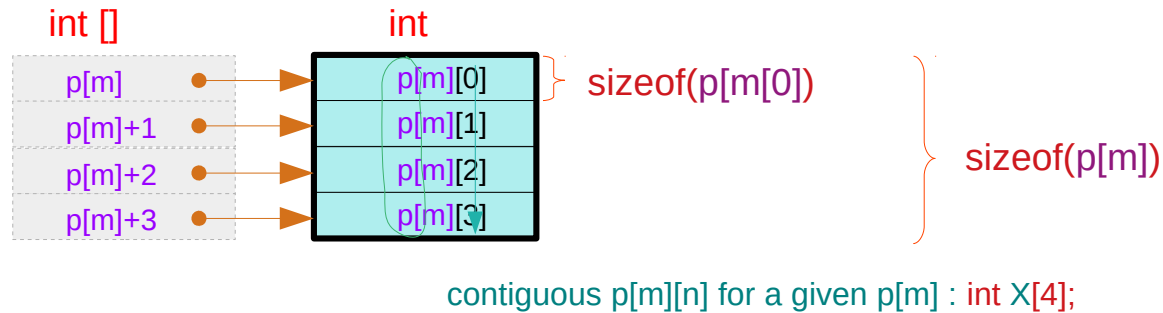

Contiguity constraints

$$(*(\mathbf{p}+\mathbf{m}))[\mathbf{n}]; \iff \mathbf{p}[\mathbf{m}][\mathbf{n}];$$

for a given \mathbf{p} contiguous index : \mathbf{m}

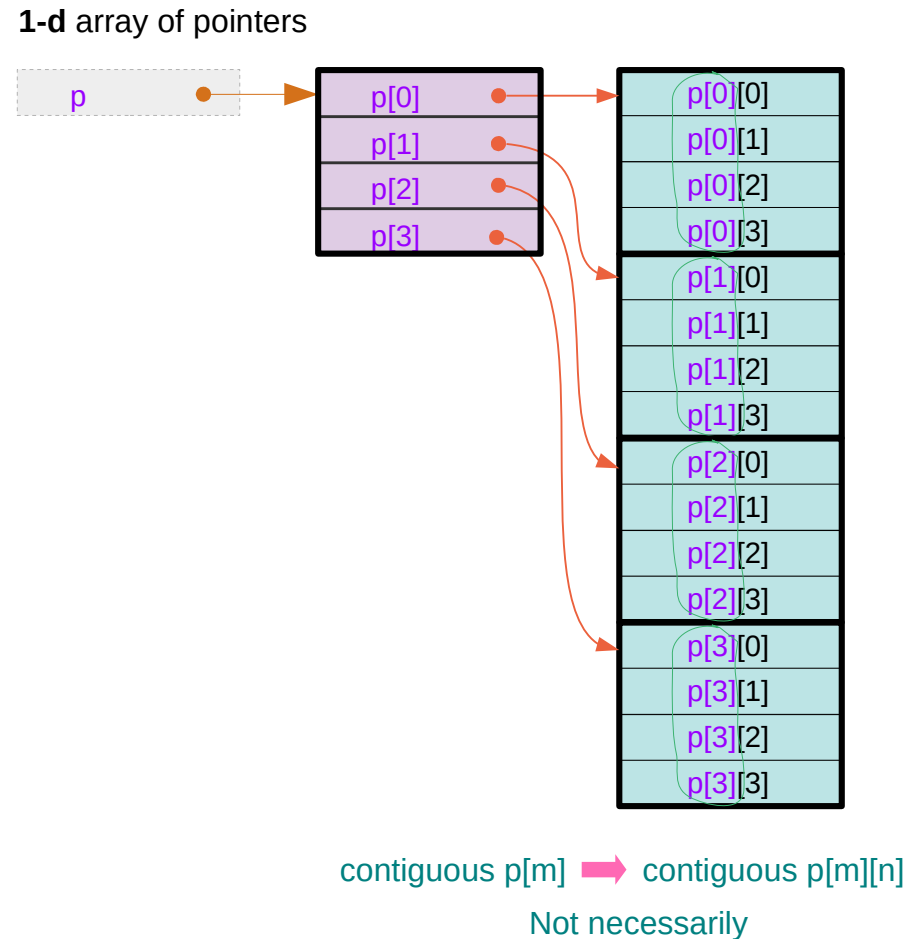
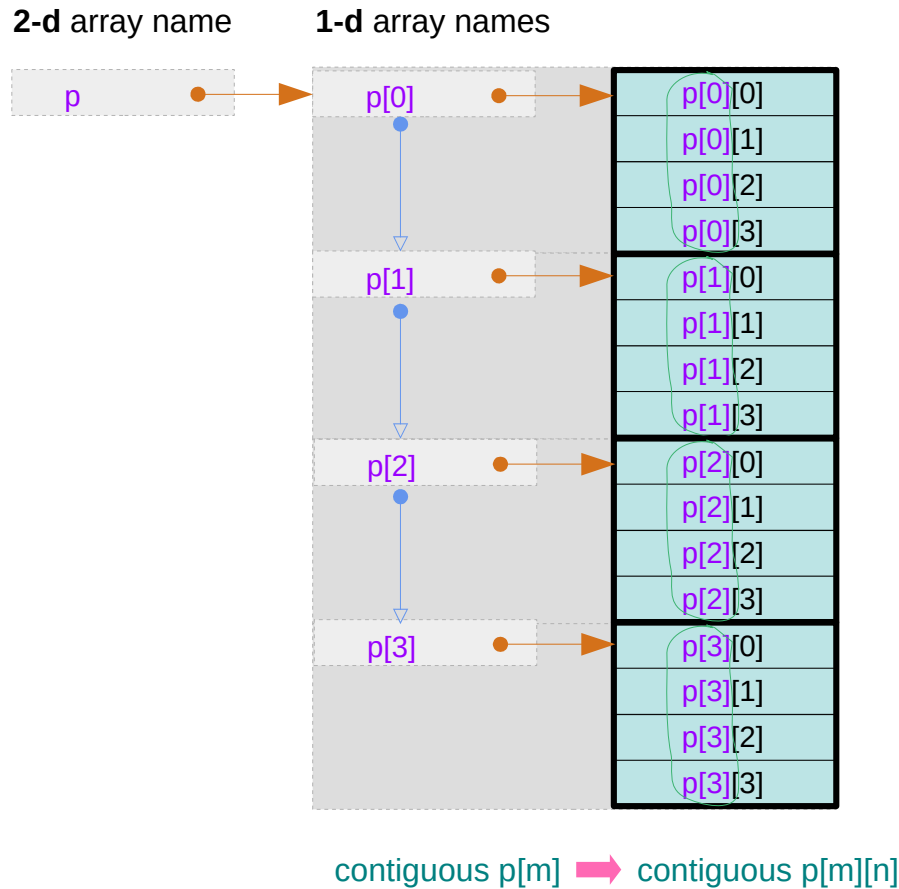

Contiguity constraints – using array pointers

$$(*(\mathbf{p}+\mathbf{m}))[\mathbf{n}]; \iff \mathbf{p}[\mathbf{m}][\mathbf{n}];$$

for a given \mathbf{p} contiguous index : \mathbf{m}

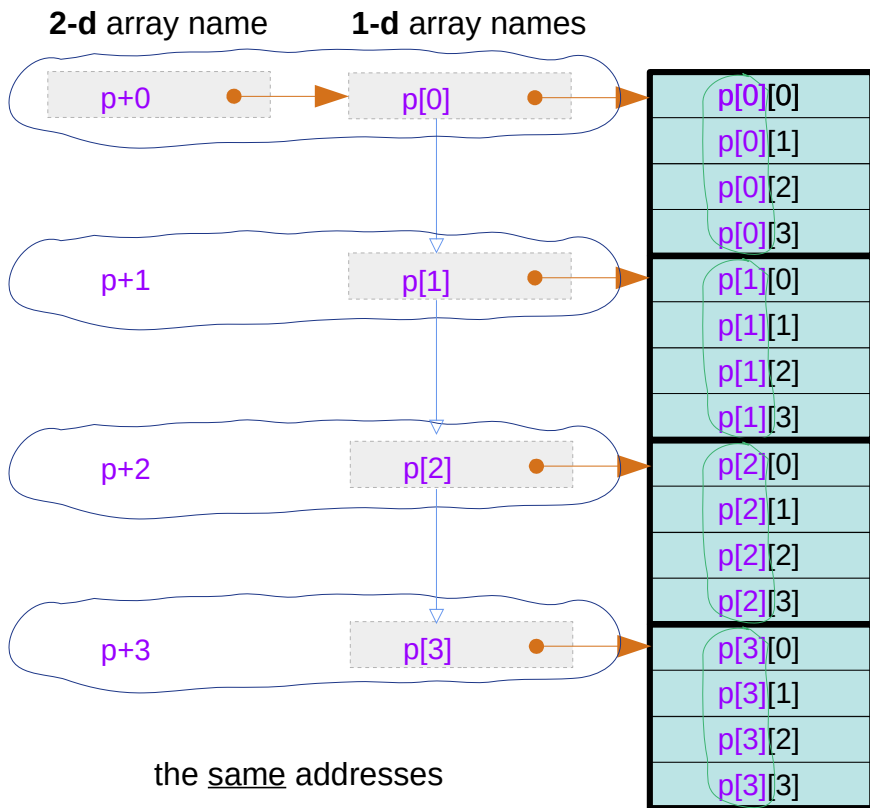

contiguous $p[m]$ \rightarrow contiguous $p[m][n]$

virtual array pointer

$$\begin{array}{l} \text{data} \\ p[0][0] = *(p[0]+0) \end{array} \xrightarrow{\text{addr}} (p[0]+0) = p[0] \xrightarrow{\text{addr}} p+0$$

$$\begin{array}{l} \text{data} \\ p[1][0] = *(p[1]+0) \end{array} \xrightarrow{\text{addr}} (p[1]+0) = p[1] \xrightarrow{\text{addr}} p+1$$

$$\begin{array}{l} \text{data} \\ p[2][0] = *(p[2]+0) \end{array} \xrightarrow{\text{addr}} (p[2]+0) = p[2] \xrightarrow{\text{addr}} p+2$$

$$\begin{array}{l} \text{data} \\ p[3][0] = *(p[3]+0) \end{array} \xrightarrow{\text{addr}} (p[3]+0) = p[3] \xrightarrow{\text{addr}} p+3$$

the same addresses

\iff no real memory locations

Contiguity constraints – using pointer arrays

$$(*(\mathbf{p}+\mathbf{m}))[\mathbf{n}]; \iff \mathbf{p}[\mathbf{m}][\mathbf{n}];$$

for a given \mathbf{p} contiguous index : \mathbf{m}

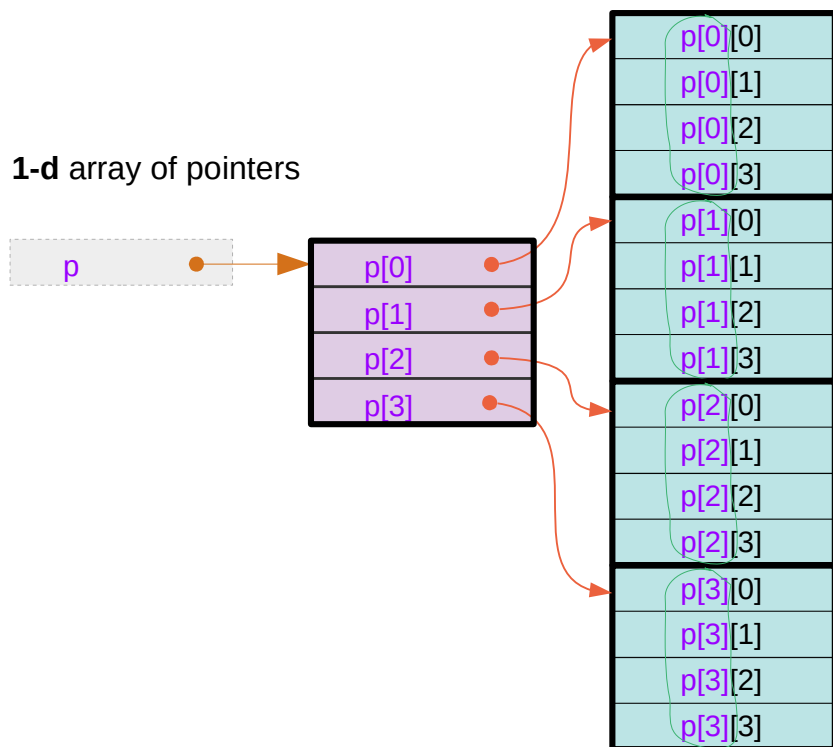

contiguous $p[m]$ \rightarrow contiguous $p[m][n]$
Not necessarily

the different addresses

$$\begin{array}{l} \text{data} \\ p[0][0] = *(p[0]+0) \end{array} \xrightarrow{\text{addr}} (p[0]+0) = p[0] \xrightarrow{\text{addr}} p+0$$

$$\begin{array}{l} \text{data} \\ p[1][0] = *(p[1]+0) \end{array} \xrightarrow{\text{addr}} (p[1]+0) = p[1] \xrightarrow{\text{addr}} p+1$$

$$\begin{array}{l} \text{data} \\ p[2][0] = *(p[2]+0) \end{array} \xrightarrow{\text{addr}} (p[2]+0) = p[2] \xrightarrow{\text{addr}} p+2$$

$$\begin{array}{l} \text{data} \\ p[3][0] = *(p[3]+0) \end{array} \xrightarrow{\text{addr}} (p[3]+0) = p[3] \xrightarrow{\text{addr}} p+3$$

Contiguity constraints

$$*(p[m]+n) \iff p[m][n]$$

for a given $p[m]$, thus for a given m ,
 $p[m][n]$ must be contiguous for all n .
 $p[m][0], p[m][1], \dots, p[m][N-1]$

contiguous index : n

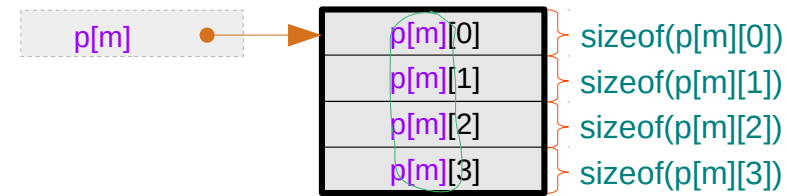

$$(*(p+m))[n]; \iff p[m][n];$$

for a given p ,
 $p[m]$'s must be contiguous for all m .
 $p[0], p[1], \dots, p[M-1]$

contiguous index : m

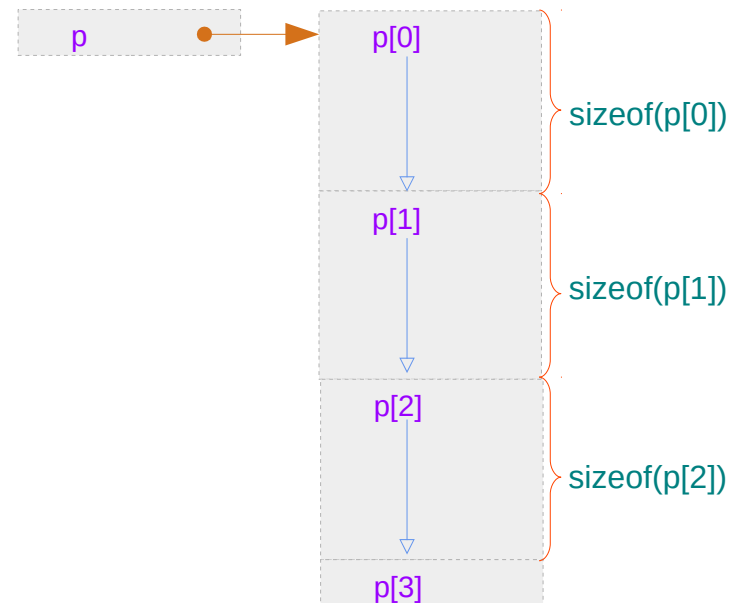

all $p[m][n]$'s must be contiguous for all m, n

Contiguity constraints

```
int a[M][N] ;
```

$(*(a+m))[n]$ \longleftrightarrow $a[m][n]$
 $*(a[m]+n)$ \longleftrightarrow $a[m][n]$

```
int (*b)[N] ;
```

$(*(b+m))[n]$ \longleftrightarrow $b[m][n]$
 $*(b[m]+n)$ \longleftrightarrow $b[m][n]$

```
int * c[M] ;
```

$(*(c+m))$ \longleftrightarrow $c[m]$
needs assignments

Contiguity constraints

```
int a[M][N] ;
```

$(*(a+m))[n] \longleftrightarrow a[m][n]$

$a[0], a[1], \dots, a[M-1]$
are contiguous

$*(a[m]+n) \longleftrightarrow a[m][n]$

$a[m][0], a[m][1], \dots, a[m][N-1]$
are contiguous

```
int (*b)[N] ;
```

$(*(b+m))[n] \longleftrightarrow b[m][n]$

$b[0], b[1], \dots, b[M-1]$
are contiguous

$*(b[m]+n) \longleftrightarrow b[m][n]$

$b[m][0], b[m][1], \dots, b[m][N-1]$
are contiguous

Contiguity constraints

```
int a[M][N] ;
```

$(*(a+m))[n] \longleftrightarrow a[m][n]$

$a[0], a[1], \dots, a[M-1]$
are contiguous

$*(a[m]+n) \longleftrightarrow a[m][n]$

$a[m][0], a[m][1], \dots, a[m][N-1]$
are contiguous

```
int * c[M] ;
```

$*(c+m) \longleftrightarrow c[m]$

$c[0], c[1], \dots, c[M-1]$
are contiguous

$*(c+m)[n] \longleftrightarrow c[m][n]$

$c[m][0], c[m][1], \dots, c[m][N-1]$
are contiguous

a set of assignments of pointers
are necessary for this contiguity

Pointer Arrays vs Array Pointers

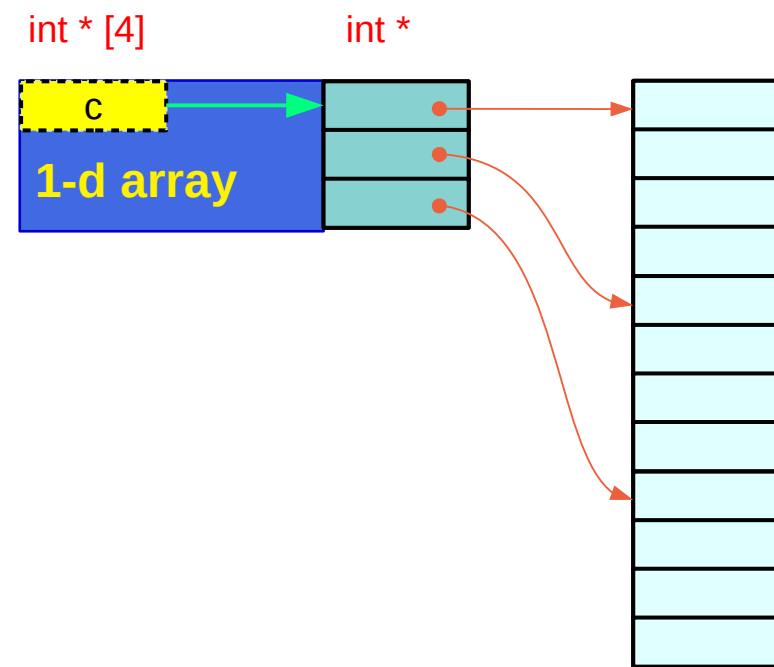
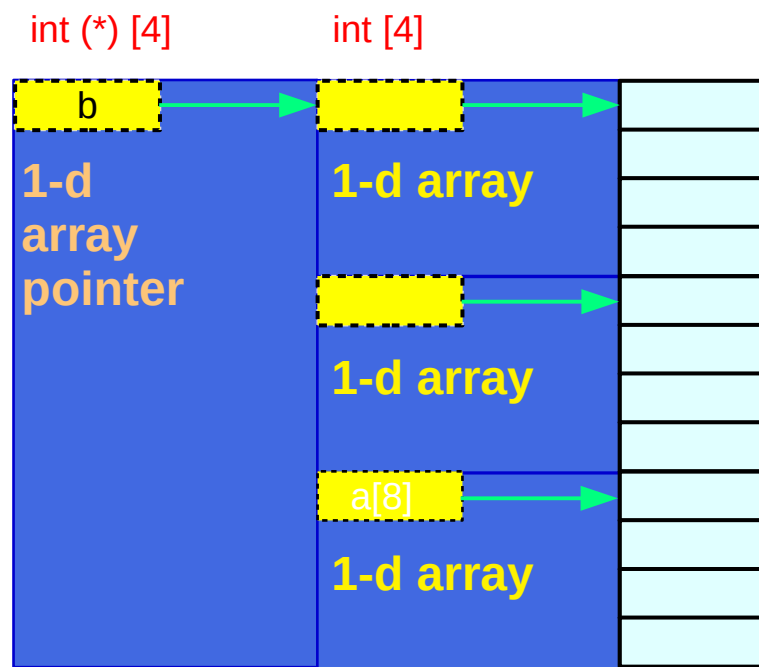

`int (*b)[N] ;`

`int * c[M] ;`

$(*(b+m))[n] \iff b[m][n]$
 $*(b[m]+n) \iff b[m][n]$

$*(c+m) \iff c[m] \text{ or}$
 $*(c+m)[n] \iff c[m][n]$

Contiguous linear layout

```
int c [L][M][N];
```

| L | M | N |
|-------------|----------|----------|
| <i>i</i> | <i>j</i> | <i>k</i> |
| $i * M * N$ | $j * N$ | <i>k</i> |

Base Index = 0

Offset Index 1 (*i*=1)

Offset Index 2 (*j*=1)

Offset Index 3 (*k*=1)

$$(i * M * N + j * N + k)$$

$$((i * M + j) * N + k)$$

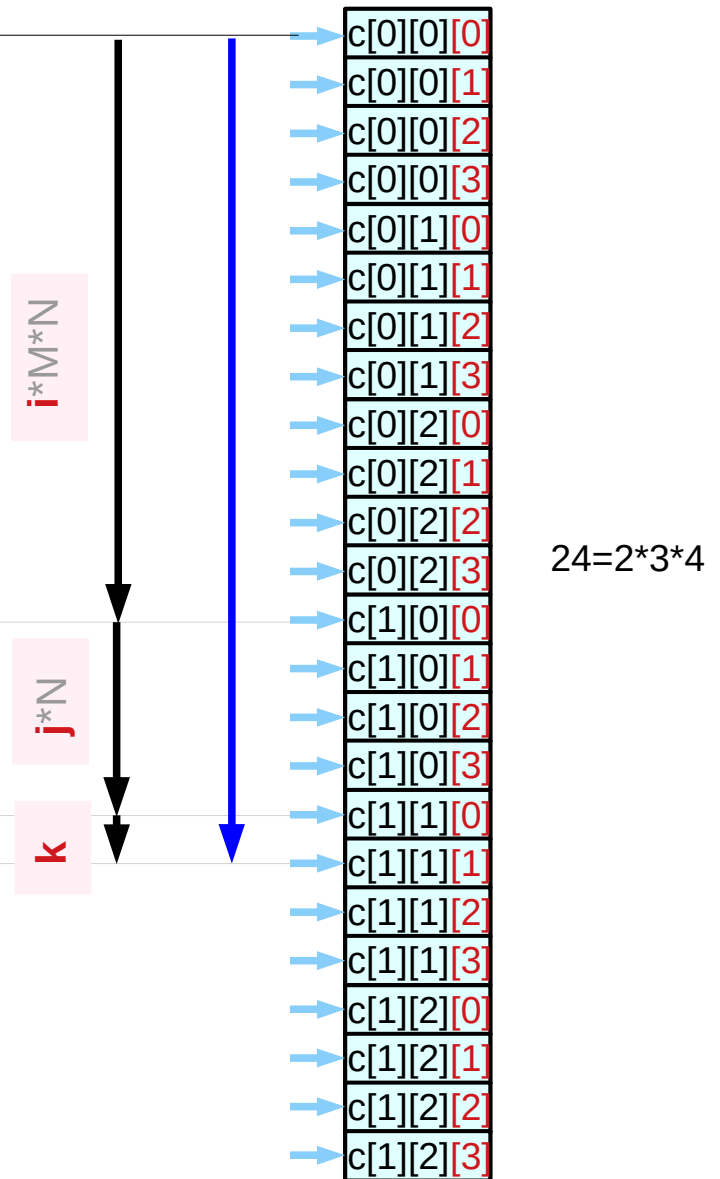

Base and Offset Addressing

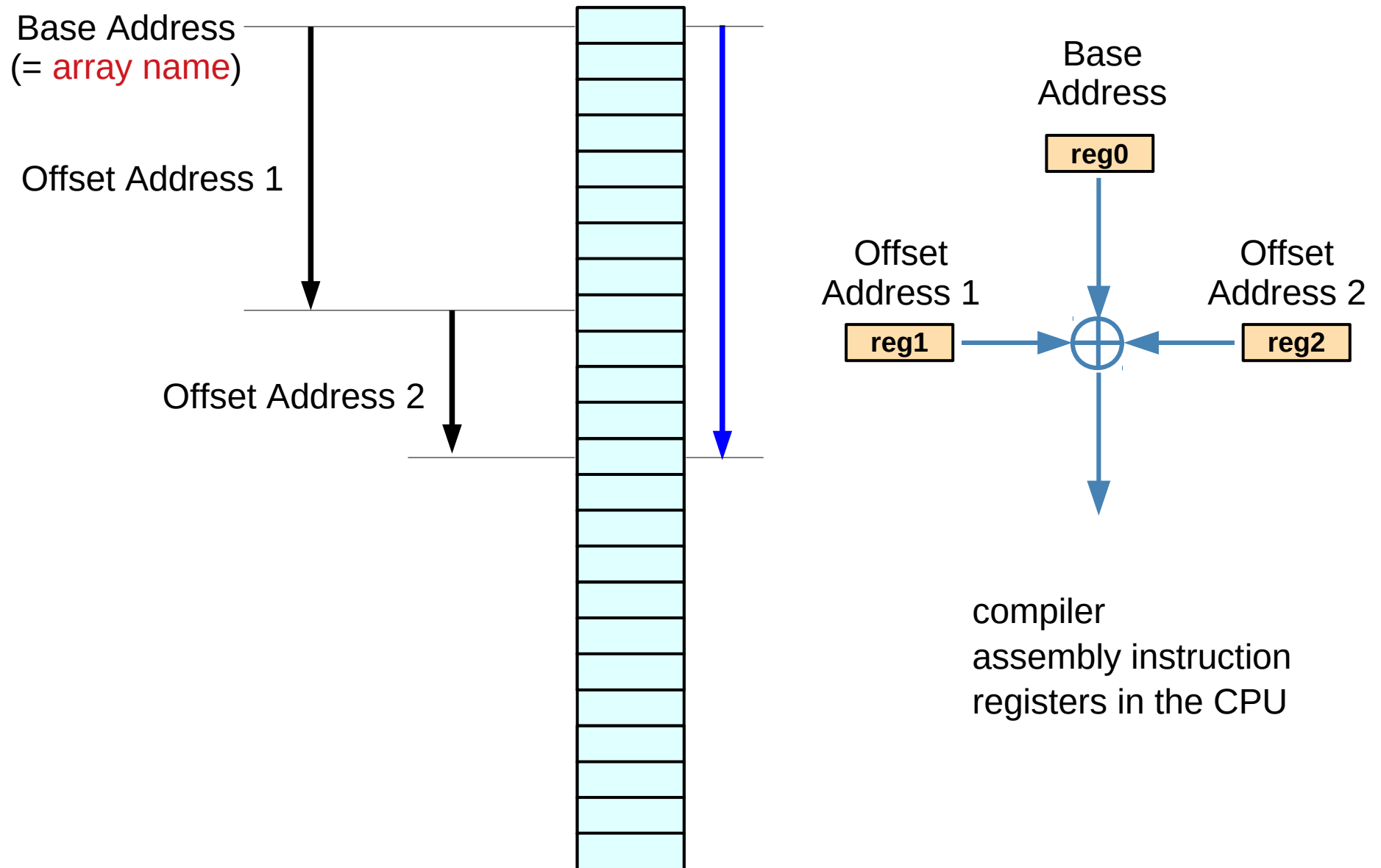

Array Pointer Approach

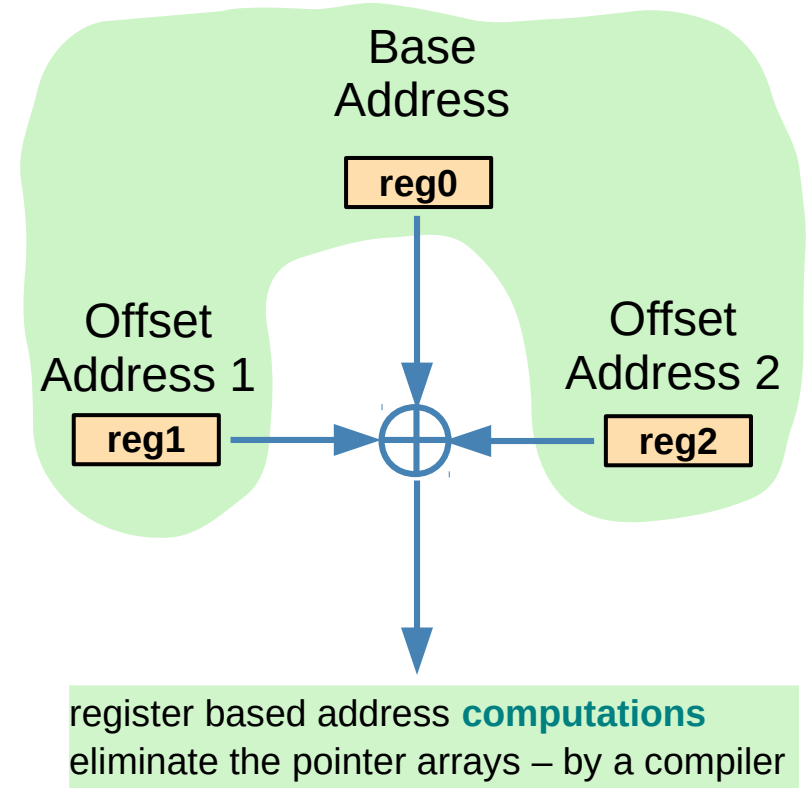
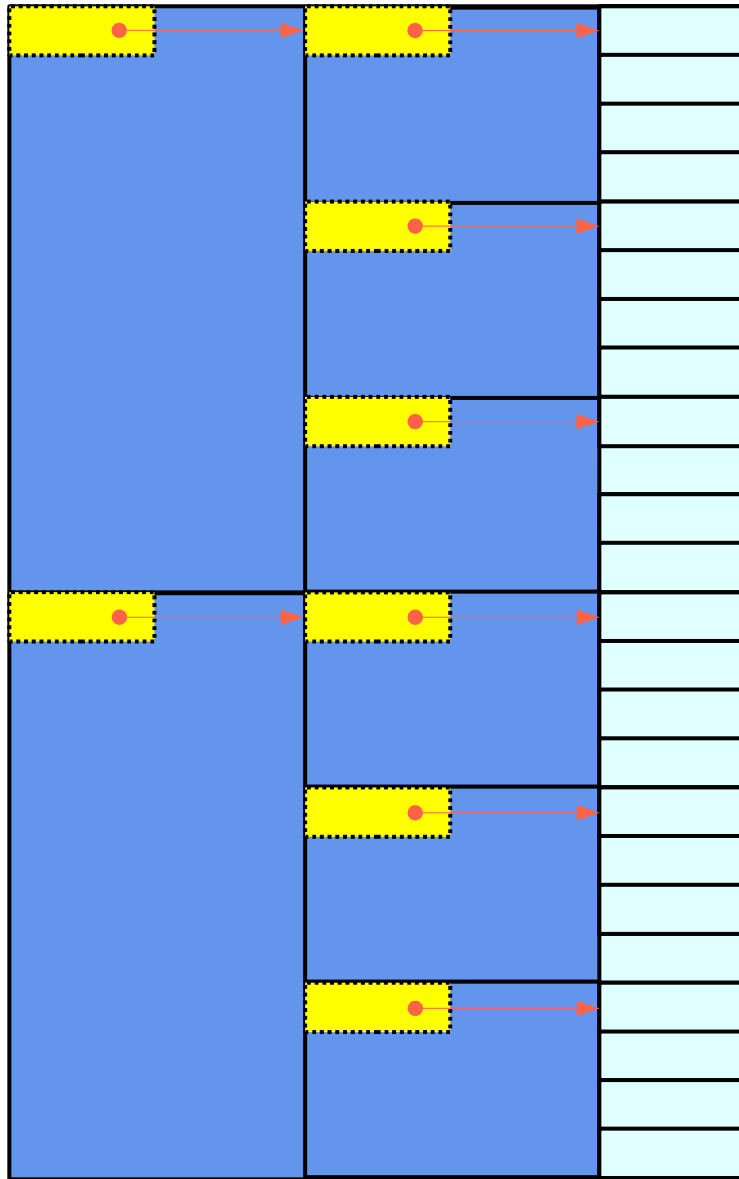

Array Pointer Approach
(pointer to arrays)

References

- [1] Essential C, Nick Parlante
- [2] Efficient C Programming, Mark A. Weiss
- [3] C A Reference Manual, Samuel P. Harbison & Guy L. Steele Jr.
- [4] C Language Express, I. K. Chun