

Applications of Array Pointers (1A)

Copyright (c) 2010 - 2020 Young W. Lim.

Permission is granted to copy, distribute and/or modify this document under the terms of the GNU Free Documentation License, Version 1.2 or any later version published by the Free Software Foundation; with no Invariant Sections, no Front-Cover Texts, and no Back-Cover Texts. A copy of the license is included in the section entitled "GNU Free Documentation License".

Please send corrections (or suggestions) to youngwlim@hotmail.com.
This document was produced by using LibreOffice.

Multi-dimensional Array Pointers

$(n-1)$ -d array pointer to a n -d array

`int a[4];` **1-d** array
`int (*p);` **0-d** array pointer ($p = a$)

`int b[4][2];` **2-d** array
`int (*q)[2];` **1-d** array pointer ($q = b$)

`int c[4][2][3];` **3-d** array
`int (*r)[2][3];` **2-d** array pointer ($r = c$)

`int d[4][2][3][4];` **4-d** array
`int (*s)[2][3][4];` **3-d** array pointer ($s = d$)



the 1st dimension can be accessed by incrementing $(n-1)$ -d array pointer

n -d array name and $(n-1)$ -d array pointer

```
int a[4];  
int (*p);
```

```
p = &a[0];  
p = a;
```

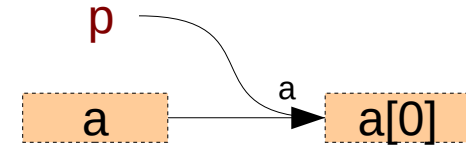

```
int b[4][2];  
int (*q)[2];
```

```
q = &b[0];  
q = b;
```

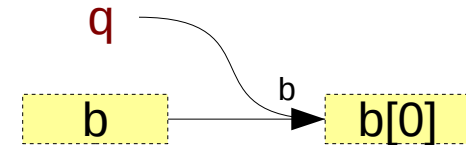

```
int c[4][2][3];  
int (*r)[2][3];
```

```
r = &c[0];  
r = c;
```

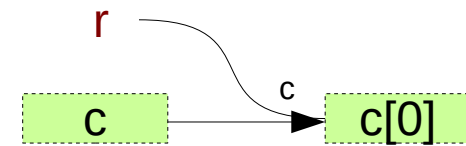

```
int d[4][2][3][4];  
int (*s)[2][3][4];
```

```
s = &d[0];  
s = d;
```

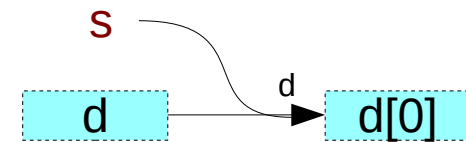

the 1st dimension can be accessed by incrementing $(n-1)$ -d array pointer

n-d array pointer to a *n*-d array

`int a [4] ;` **1-d** array
`int (*p) [4];` **1-d** array pointer (`p = &a`)

`int b [4][2];` **2-d** array
`int (*q) [4][2];` **2-d** array pointer (`q = &b`)

`int c [4][2][3];` **3-d** array
`int (*r) [4][2][3];` **3-d** array pointer (`r = &c`)

`int d [4][2][3][4];` **4-d** array
`int (*s) [4][2][3][4];` **4-d** array pointer (`s = &d`)

n-d array name and *n*-d array pointer

```
int a [4];  
int (*p) [4];
```

```
p = &a;
```

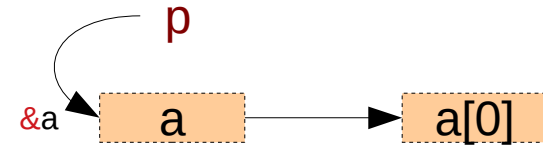

```
int b [4][2];  
int (*q) [4][2];
```

```
q = &b;
```

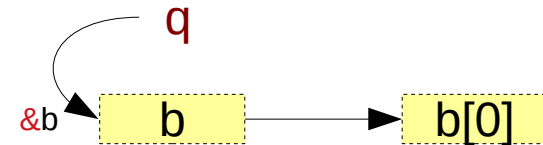

```
int c [4][2][3];  
int (*r) [4][2][3];
```

```
r = &c;
```



```
int d [4][2][3][4];  
int (*s) [4][2][3][4];
```

```
s = &d;
```

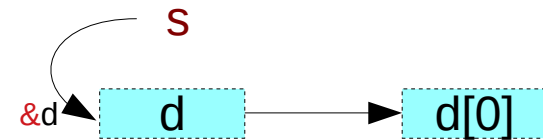

multi-dimensional array pointers

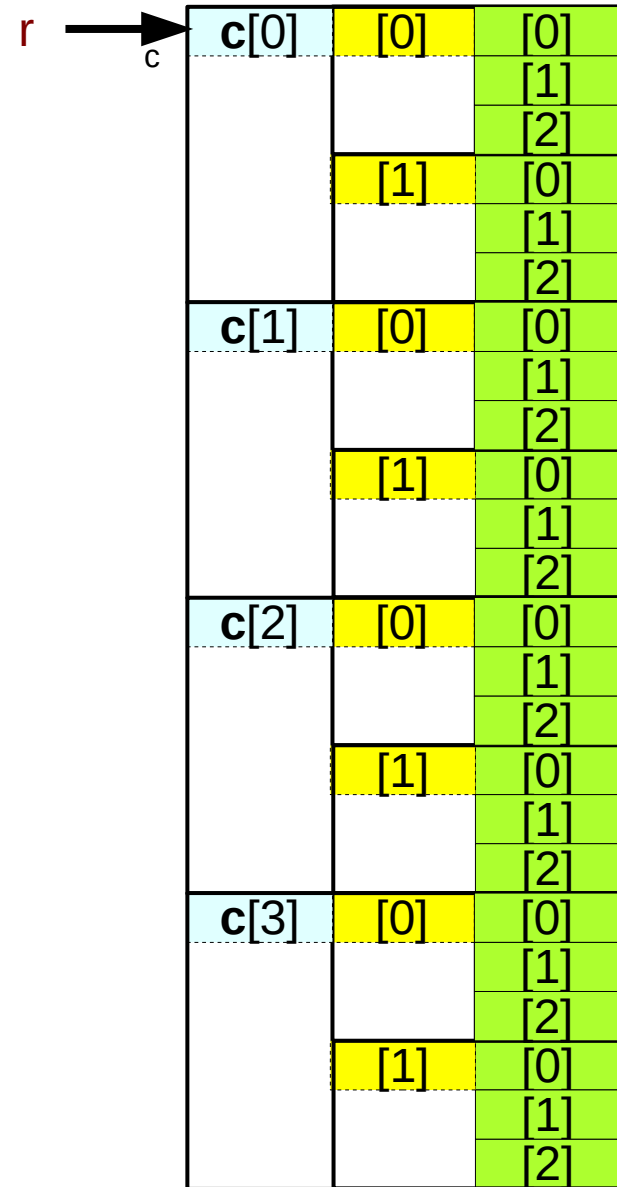
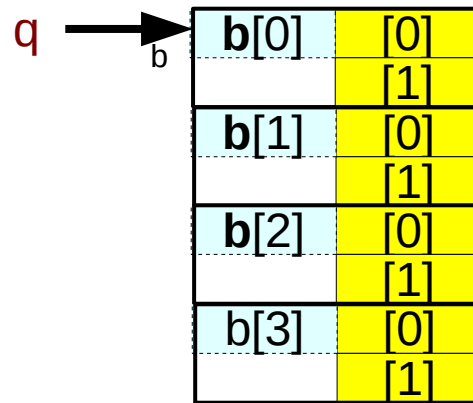
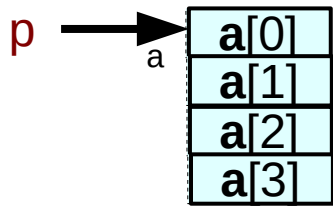

<code>int a[4];</code>	1-d array
<code>int (*p);</code>	0-d array pointer
<code>int b[4][2];</code>	2-d array
<code>int (*q)[2];</code>	1-d array pointer
<code>int c[4][2][3];</code>	3-d array
<code>int (*r)[2][3];</code>	2-d array pointer
<code>int d[4][2][3][4];</code>	4-d array
<code>int (*s)[2][3][4];</code>	3-d array pointer

Initializing *n-d* array pointers

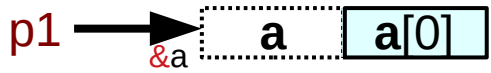

```
int a[4];
int (*p1)[4] = &a;
```

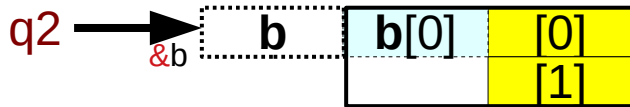

```
int b[4][2];
int (*q2)[4][2] = &b;
```

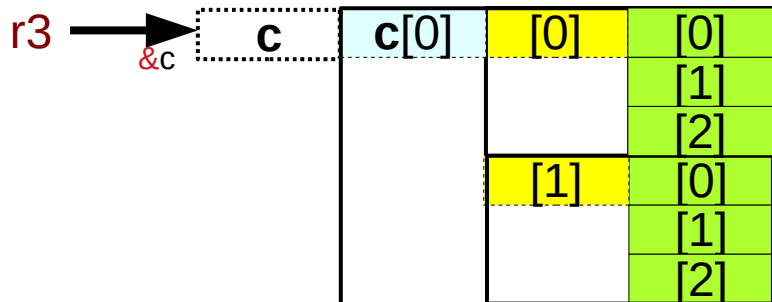

```
int c[4][2][3];
int (*r3)[4][2][3] = &c;
```

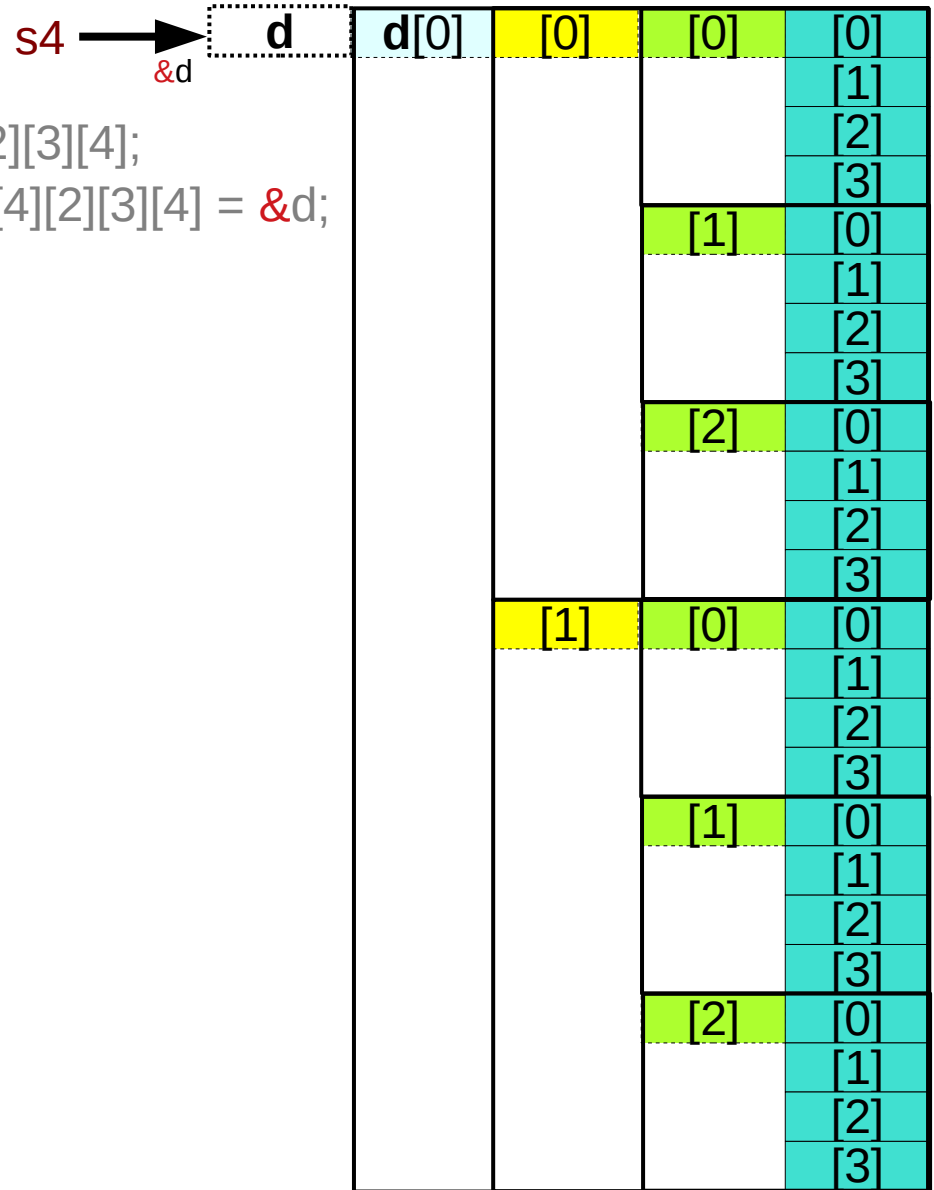

```
int d[4][2][3][4];
int (*s4)[4][2][3][4] = &d;
```

Initializing $(n-1)$ -d array pointers

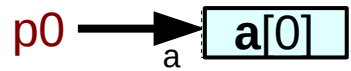

```
int a[4];
int (*p0) = a;
```

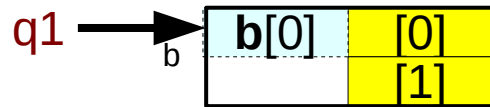

```
int b[4][2];
int (*q1)[2] = b;
```

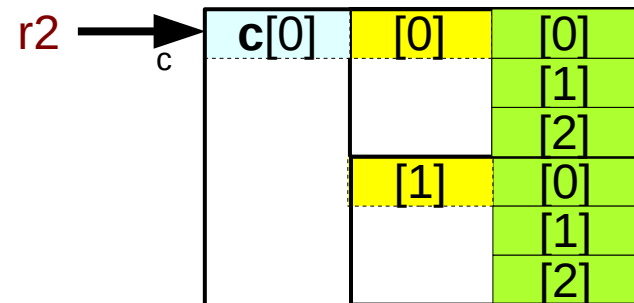

```
int c[4][2][3];
int (*r2)[2][3] = c;
```

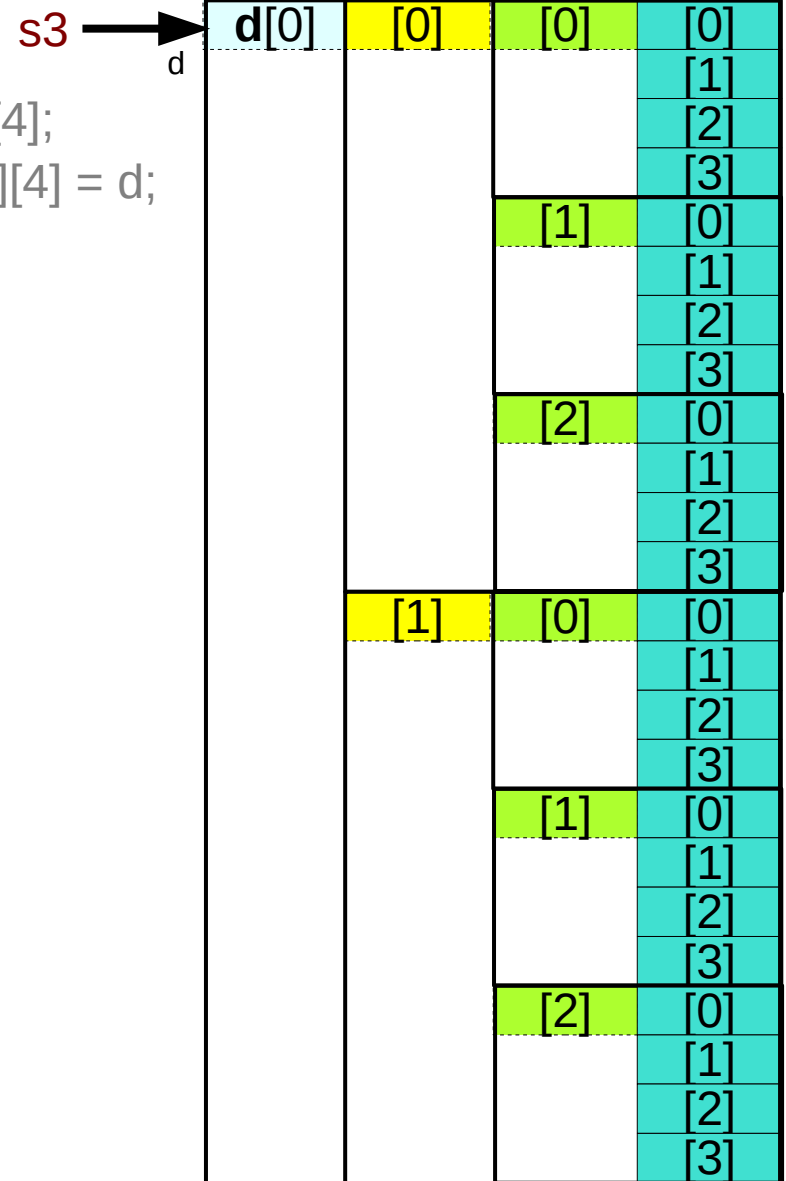

```
int d[4][2][3][4];
int (*s3)[2][3][4] = d;
```

array pointers to multi-dimensional subarrays

```
int d[4][2][3][4];
int (*s)[2][3][4];
```

d	4-d array name	d[4][2][3][4]
	3-d array pointer	(*p)[2][3][4]
d[i]	3-d array name	d[i][2][3][4]
	2-d array pointer	(*q)[3][4]
d[i][j]	2-d array name	d[i][j][3][4]
	1-d array pointer	(*r)[4]
d[i][j][k]	1-d array name	d[i][j][k][4]
	0-d array pointer	(*s)

i,j,k are specific index values

i = [0..3], j = [0..1], k = [0..2]

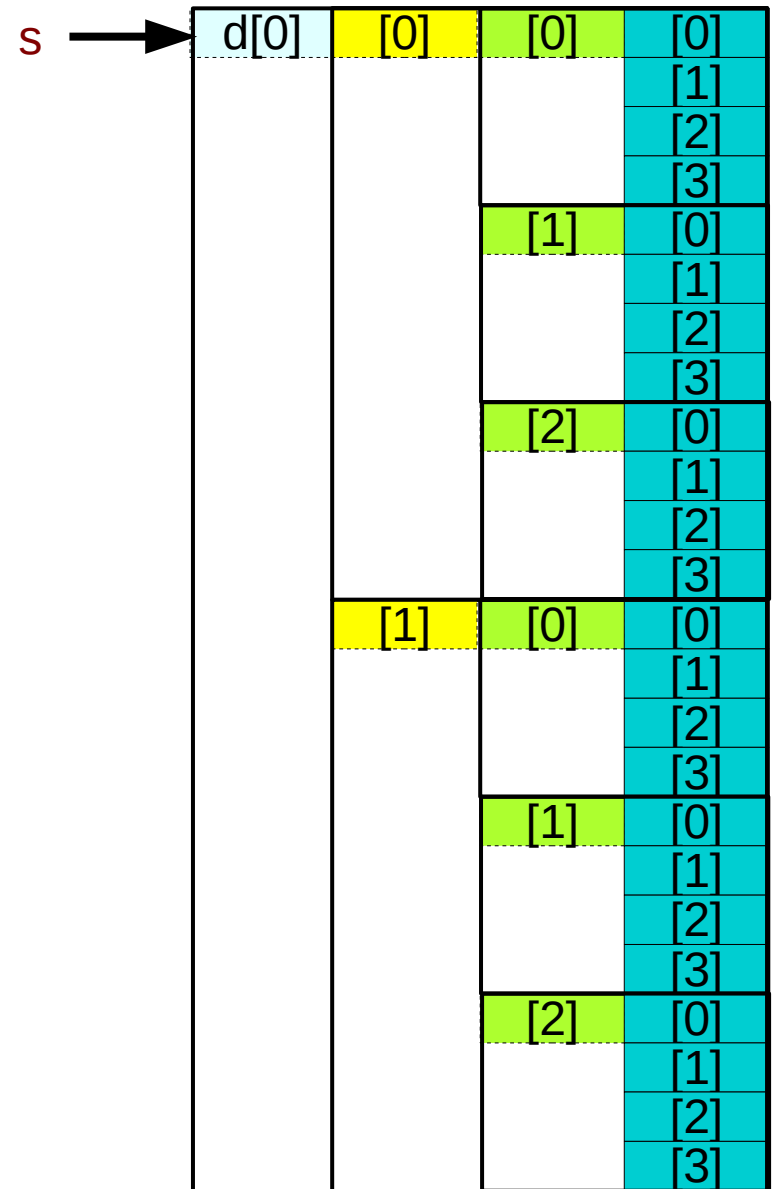

Initializing array pointers to multi-dimensional subarrays

```
int d[4][2][3][4];  
int (*s)[2][3][4];
```

<code>d</code>	4-d array name 3-d array pointer	<code>d[4][2][3][4]</code> <code>(*p)[2][3][4]</code>	<code>p[i][j][k][l]</code> <code>int (*p)[2][3][4] = d;</code>
<code>d[i]</code>	3-d array name 2-d array pointer	<code>d[i][2][3][4]</code> <code>(*q)[3][4]</code>	<code>q[j][k][l]</code> <code>int (*q)[3][4] = d[i];</code>
<code>d[i][j]</code>	2-d array name 1-d array pointer	<code>d[i][j][3][4]</code> <code>(*r)[4]</code>	<code>r[k][l]</code> <code>int (*r)[4] = d[i][j];</code>
<code>d[i][j][k]</code>	1-d array name 0-d array pointer	<code>d[i][j][k][4]</code> <code>(*s)</code>	<code>s[l]</code> <code>int (*s) = d[i][j][k];</code>

`i = [0..3], j = [0..1], k = [0..2]`

Passing multidimensional array names

```
int a[4];  
int (*p);
```

call
funa(a, ...);

prototype
void **fun**a(int (*p), ...);

```
int b[4][2];  
int (*q)[2];
```

call
funb(b, ...);

prototype
void **fun**b(int (*q)[2], ...);

```
int c[4][2][3];  
int (*r)[2][3];
```

call
func(c, ...);

prototype
void **func**(int (*r)[2][3], ...);

```
int d[4][2][3][4];  
int (*s)[2][3][4];
```

call
fund(d, ...);

prototype
void **fund**(int (*s)[2][3][4], ...);

Double pointer to a 1-d array – a variable view (p, q)

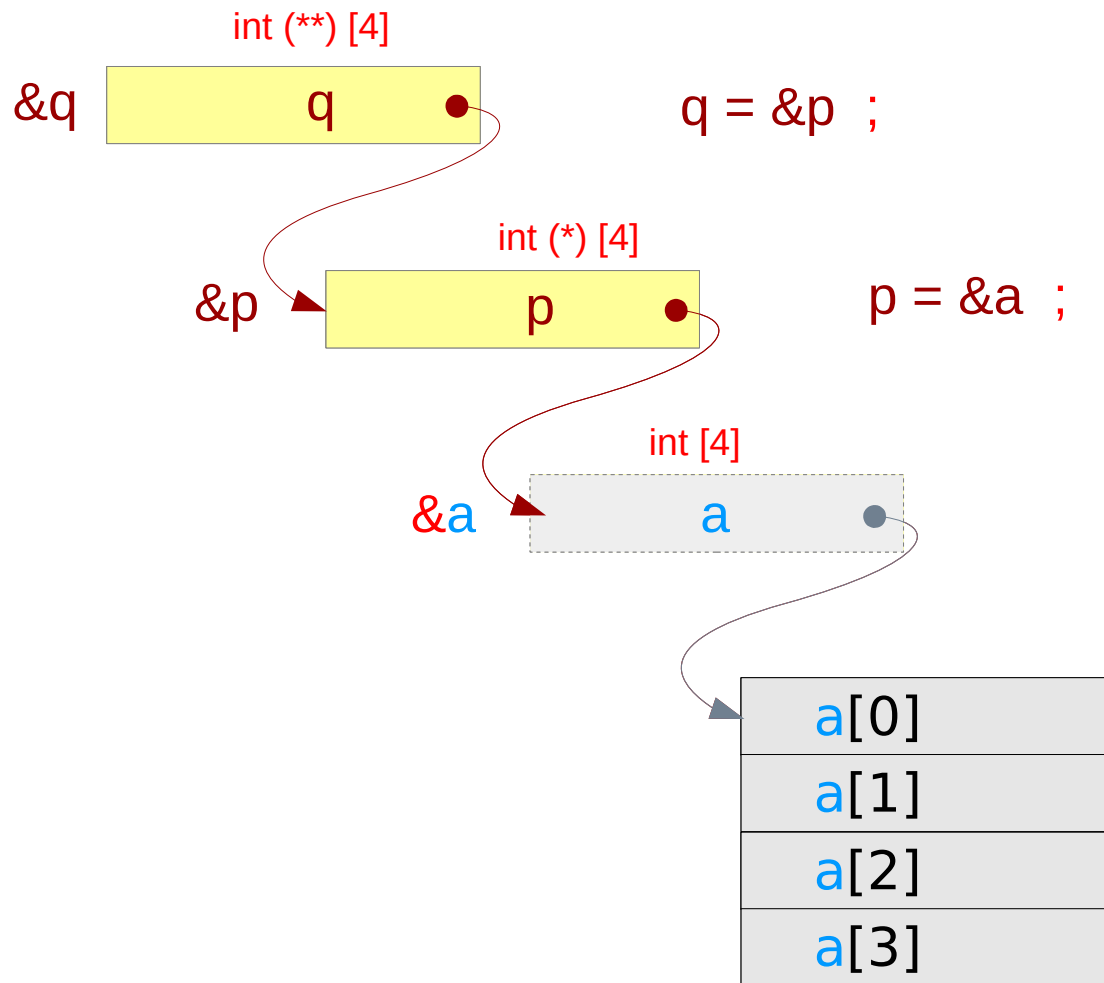

```
int a[4] ;  
int (*p) [4] = &a ;  
int (**q) [4] = &p ;
```

```
➔ p = &a ;  
➔ q = &p ;
```

Double pointer to a 1-d array – a variable view (q)

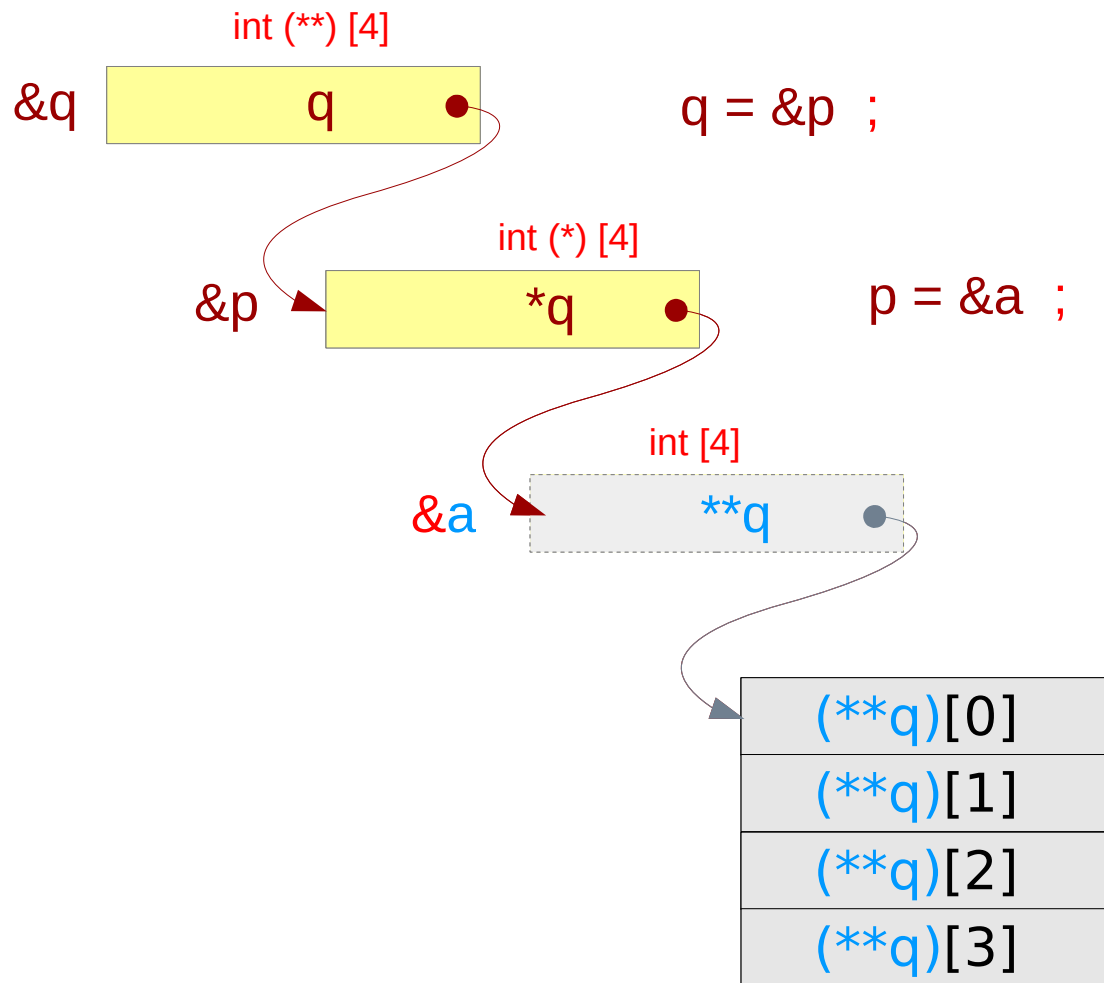

```
int a[4] ;  
int (*p) [4] = &a ;  
int (**q) [4] = &p ;
```

```
➔ p = &a ;  
➔ q = &p ;
```

Double pointer to a 1-d array – a type view

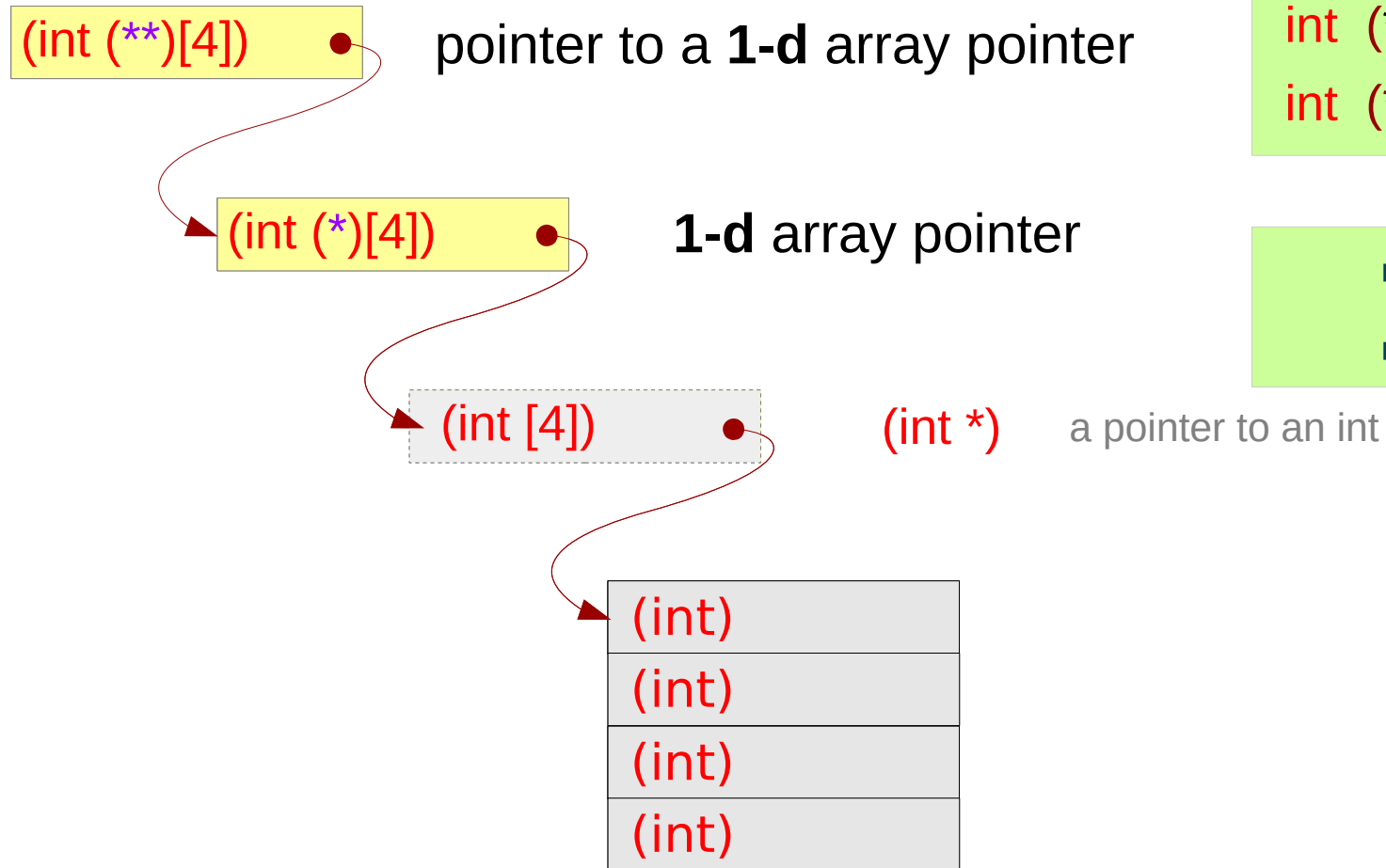

```
int a[4] ;  
int (*p) [4] = &a ;  
int (**q) [4] = &p ;
```

```
➔ p = &a ;  
➔ q = &p ;
```

Virtual Array Pointers in Multi-dimensional Arrays

3-d array structure

- Hierarchical
- Nested Structure
- Virtual Array Pointers over
 - Contiguous
 - Linear Layout

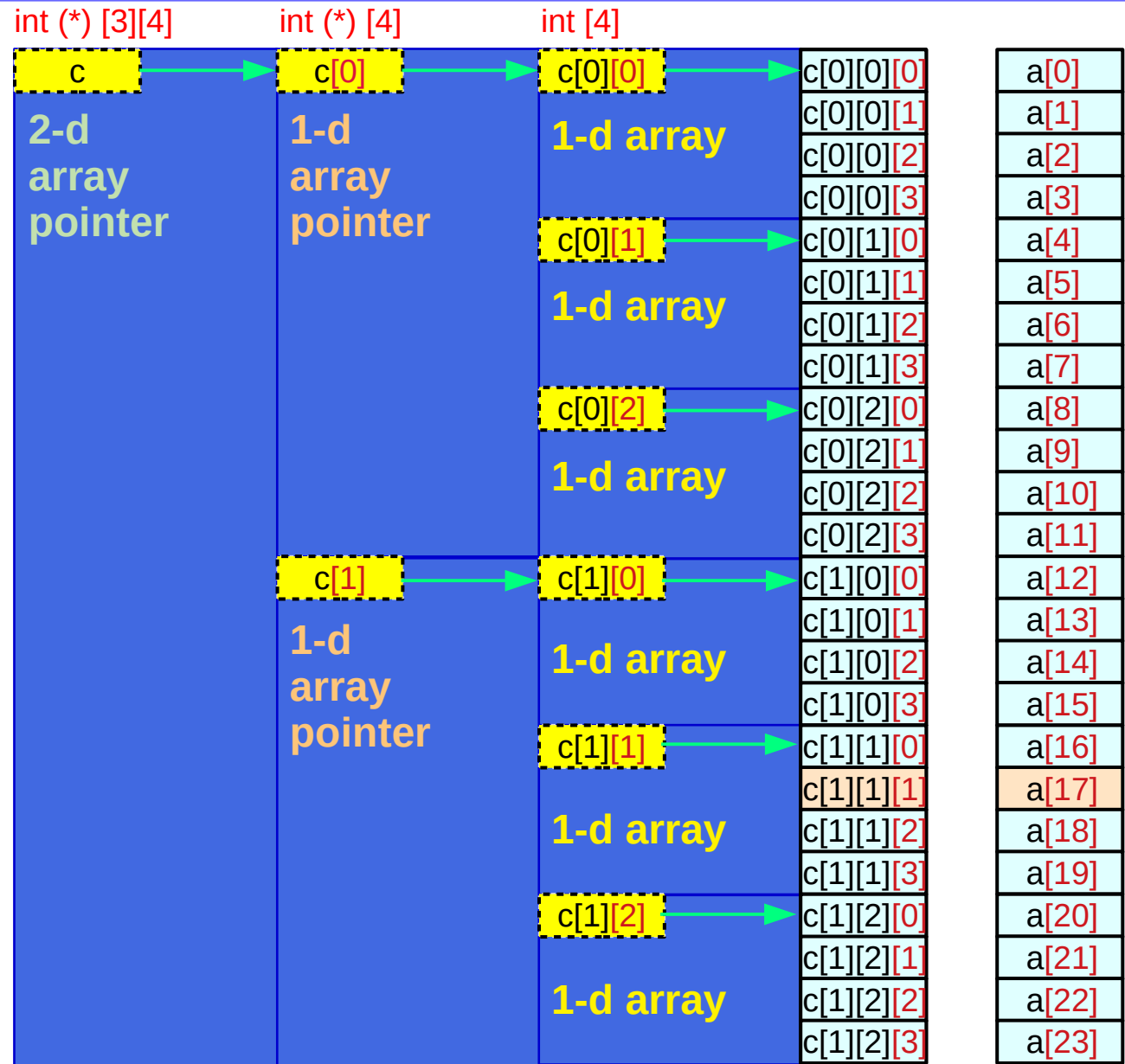

Array **p** and virtual array pointer **p**

Abstract data (array) **p**

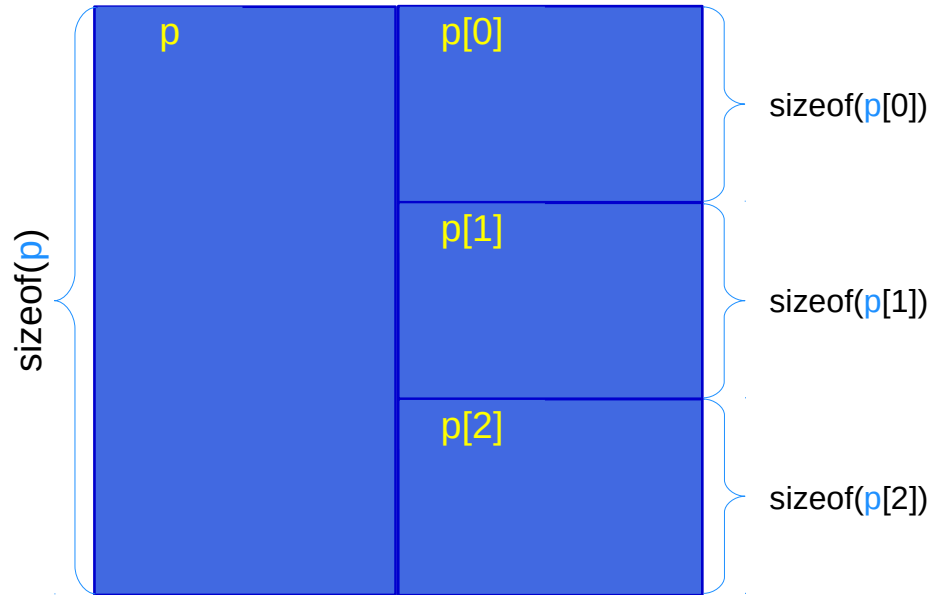

Virtual array pointer **p**

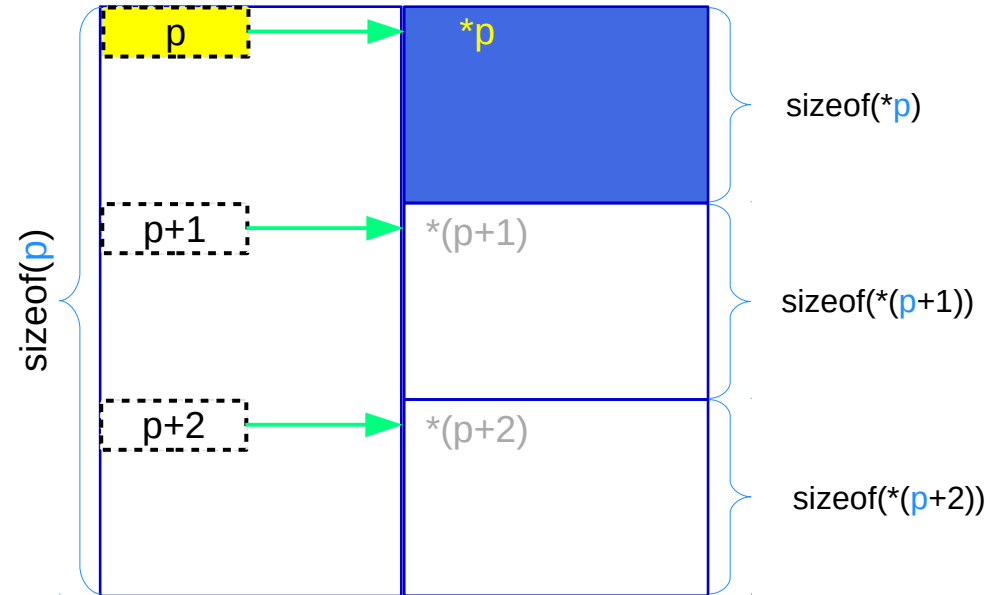

p is the name of an array and has a array pointer type but has a size of the array

p is a virtual array pointer

Virtual array pointer to abstract data

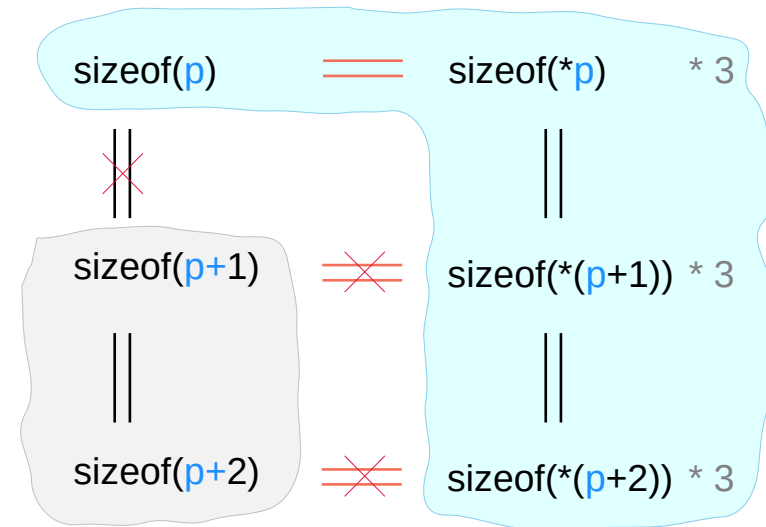
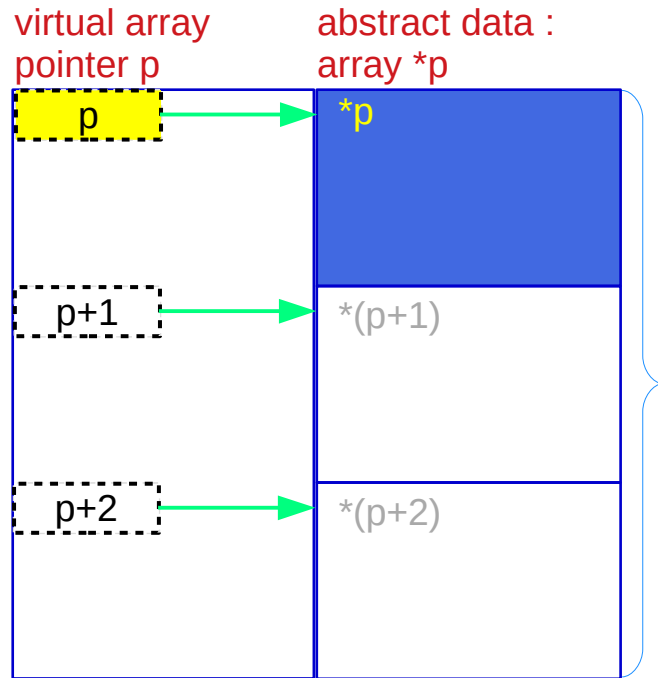

Array **a** and pointer **a**

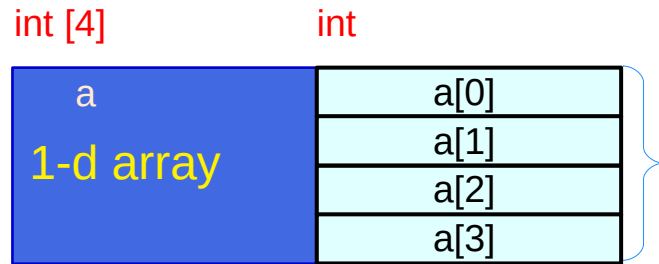

1-d array **a** specific array type

$\text{sizeof}(a)$

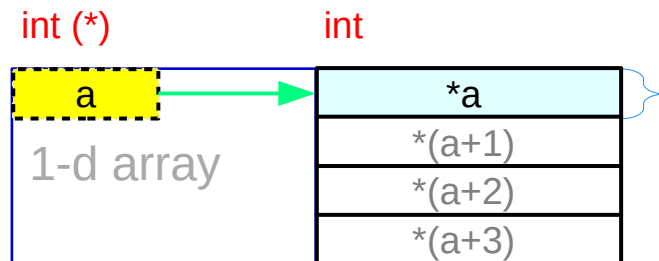

pointer **a** general pointer type

$\text{sizeof}(a) = \text{sizeof}(*a) * 4$

a is the name of a 1-d array and has a pointer type but has a size of the array

a is a virtual array pointer

Array **b** and pointer **b**

2-d array **b** specific array type

`sizeof(b)`

`int [3] [4]`

`int [4]`

b 2-d array	b[0] 1-d array	b[0][0]
		b[0][1]
		b[0][2]
		b[0][3]
	b[1] 1-d array	b[1][0]
		b[1][1]
		b[1][2]
		b[1][3]
	b[2] 1-d array	b[2][0]
		b[2][1]
		b[2][2]
		b[2][3]

1-d array pointer **b** general pointer type

`sizeof(b) = sizeof(*b) * 3`

`int (*) [4]`

`int [4]`

b 1-d array pointer	*b 1-d array	<code>*(b+0)</code>
		<code>*(b+1)</code>
		<code>*(b+2)</code>
		<code>*(b+3)</code>
	<code>*(b+1)</code> 1-d array	<code>*(b+1)</code>
		<code>*(b+1)</code>
		<code>*(b+1)</code>
		<code>*(b+1)</code>
	<code>*(b+2)</code> 1-d array	<code>*(b+2)</code>
		<code>*(b+2)</code>
		<code>*(b+2)</code>
		<code>*(b+2)</code>

b is the name of a 2-d array and has a 1-d array pointer type but has a size of the array

b is a virtual array pointer

Array c

3-d array c

specific array type

sizeof(c)

c is the name of a 3-d array and has a 2-d array pointer type but has a size of the array

c is a virtual array pointer

int [2][3][4]	int [3][4]	int [4]	
c 3-d array	c[0] 2-d array	c[0][0] 1-d array	c[0][0][0]
			c[0][0][1]
			c[0][0][2]
			c[0][0][3]
		c[0][1] 1-d array	c[0][1][0]
			c[0][1][1]
			c[0][1][2]
			c[0][1][3]
		c[0][2] 1-d array	c[0][2][0]
		c[0][2][1]	
		c[0][2][2]	
		c[0][2][3]	
c[1] 2-d array	c[1][0] 1-d array		c[1][0][0]
			c[1][0][1]
			c[1][0][2]
		c[1][0][3]	
	c[1][1] 1-d array		c[1][1][0]
			c[1][1][1]
			c[1][1][2]
		c[1][1][3]	
	c[1][2] 1-d array		c[1][2][0]
		c[1][2][1]	
		c[1][2][2]	
	c[1][2][3]		

Pointer c

2-d array pointer c

general pointer type

$\text{sizeof}(c) = \text{sizeof}(*c) * 2$

c is the name of a 3-d array and has a 2-d array pointer type but has a size of the array

c is a virtual array pointer

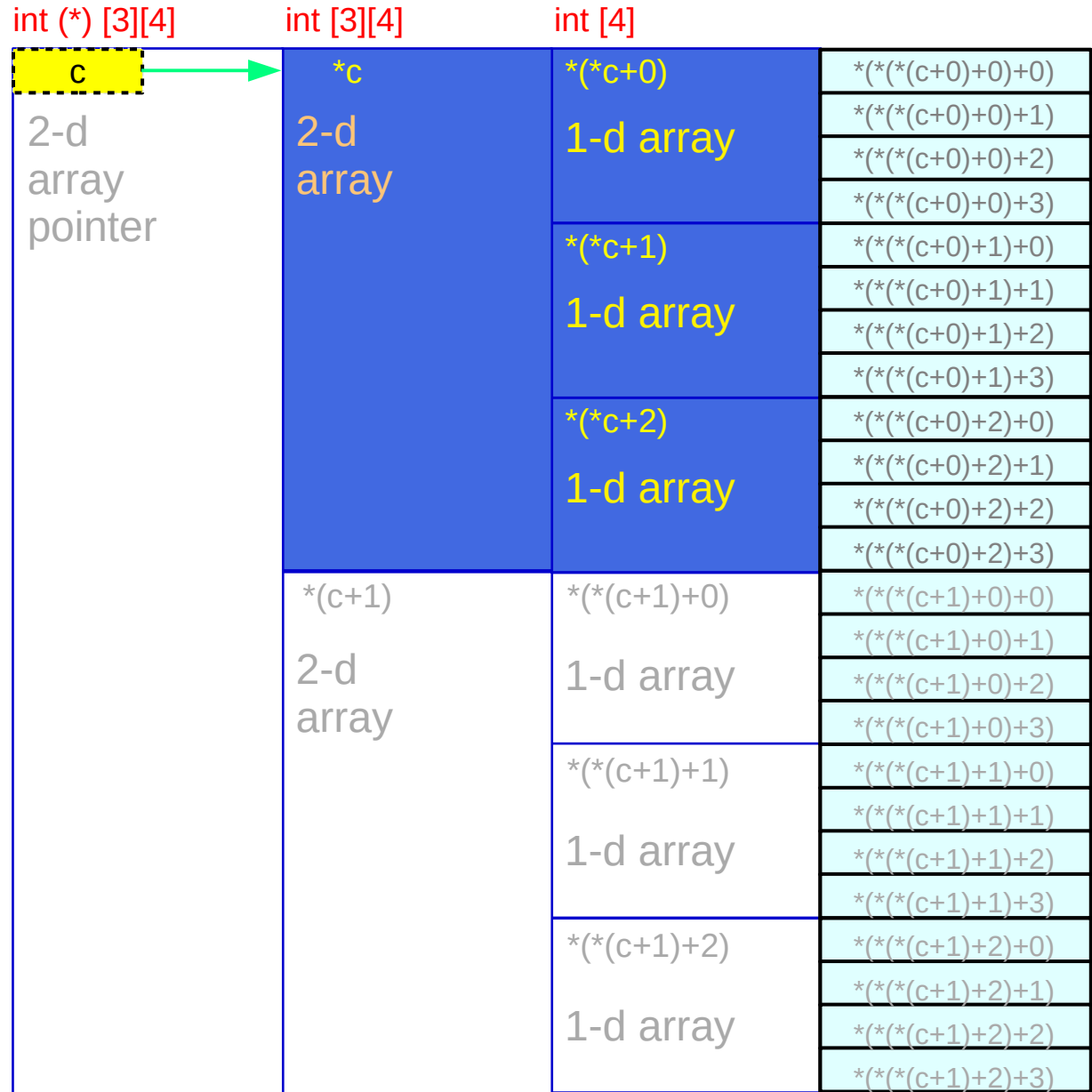

Pointers to primitive data

int *p;

int i, j, k;

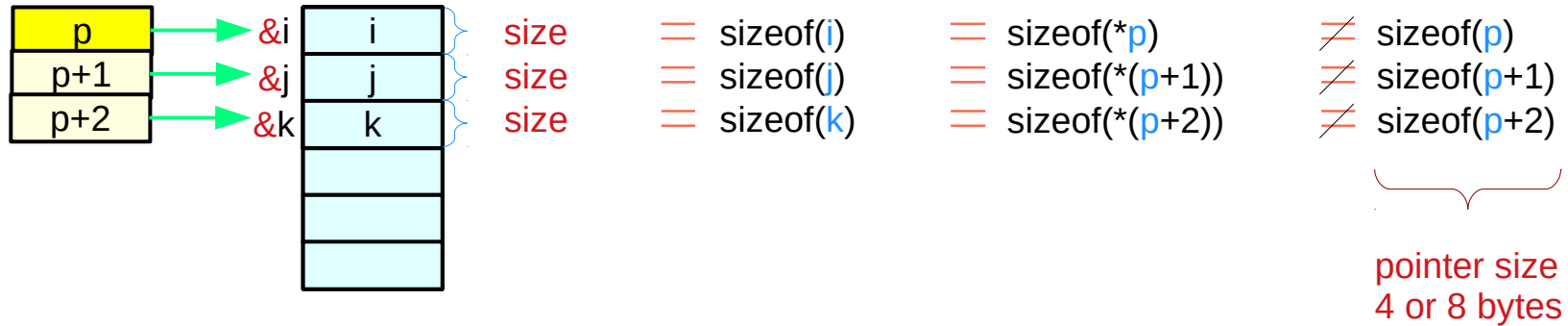

double *q;

double a, b, c;

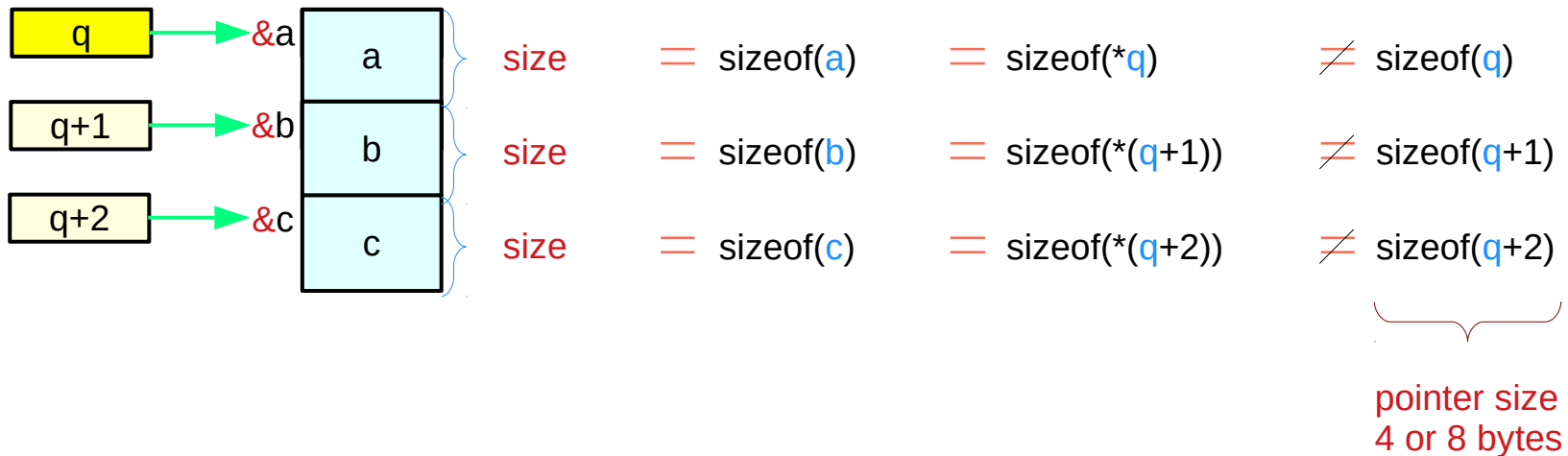

Pointers to abstract data

T *p;

T X, Y, Z;

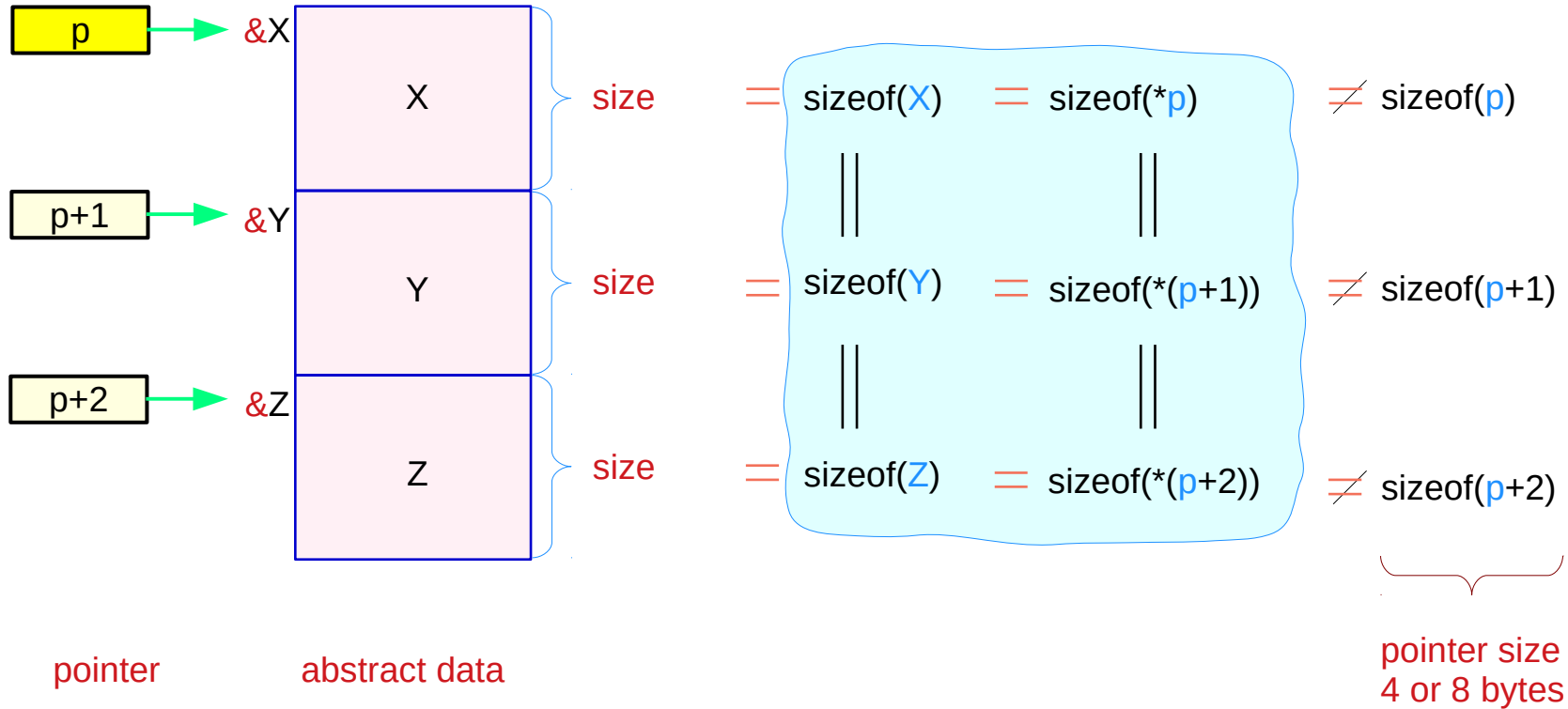

type ----- array
 value ----- start address
 increment size ----- size

Virtual pointers in a multi-dimensional array

$p[i] :: T1$ $*p[i], *p[i+1] :: T2$

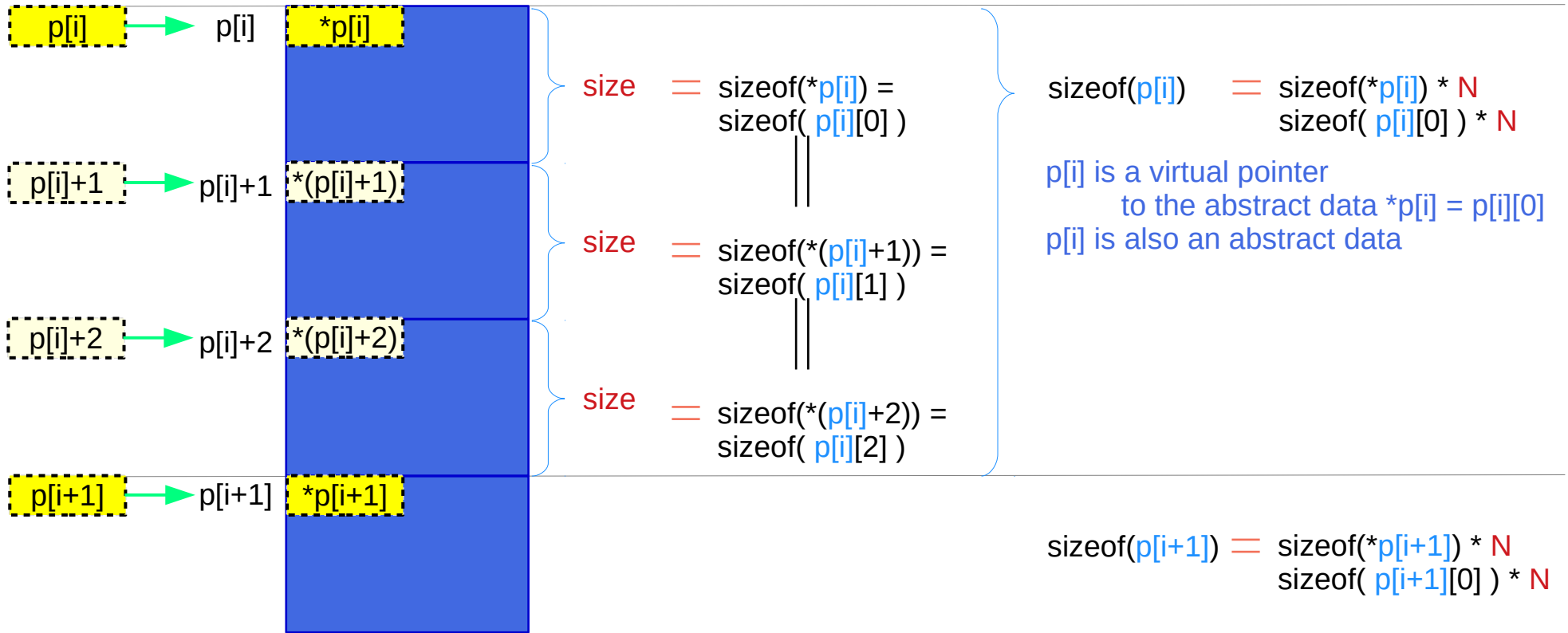

T1 **T2**

$\text{int} (*) [4]$ $\text{int} [4]$ $\subset \text{int} (*)$

$\text{int} (*) [3][4]$ $\text{int} [3][4]$ $\subset \text{int} (*) [4]$

Virtual pointers in a multi-dimensional array

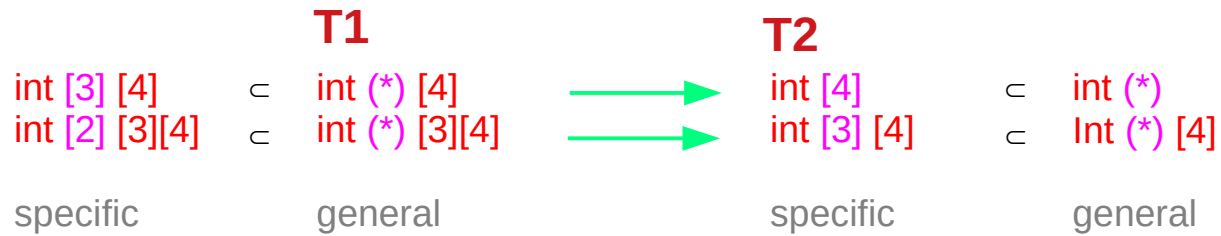

```
typedef int (*T1) [4];  
typedef int (*T1) [3][4];  
  
typedef int T2[4];  
typedef int T2[3][4];
```

T1 a;

T2 b;

T1 references T2
T2 is a dereference of T1

T1 is a pointer type
T2 is an array type
T1 has one more dimension than T2

Virtual array pointers – types, sizes, and values

int c[2][3][4];	c[i][j]	c[i][j][0]	
type	int [4] int (*)	int int	<ul style="list-style-type: none"> abstract data type array pointer type
size	sizeof(c[i][j]) =	sizeof(c[i][j][0]) * 4	= sizeof(int) * 4
value (address)	c[i][j] =	&c[i][j][0]	
int c[2][3][4];	c[i]	c[i][0]	
type	int [3][4] int (*)[4]	int [4] int (*)	<ul style="list-style-type: none"> abstract data type array pointer type
size	sizeof(c[i]) =	sizeof(c[i][0]) * 3	= sizeof(int) * 4 * 3
value (address)	c[i] =	&c[i][0]	
int c[2][3][4];	c	c[0]	
type	int [2][3][4] int (*)[3][4]	int [3][4] int (*)[4]	<ul style="list-style-type: none"> abstract data type array pointer type
size	sizeof(c) =	sizeof(c[0]) * 2	= sizeof(int) * 4 * 3 * 2
value (address)	c =	&c[0]	

virtual array pointers c , $c[i]$, $c[i][j]$ – sizes

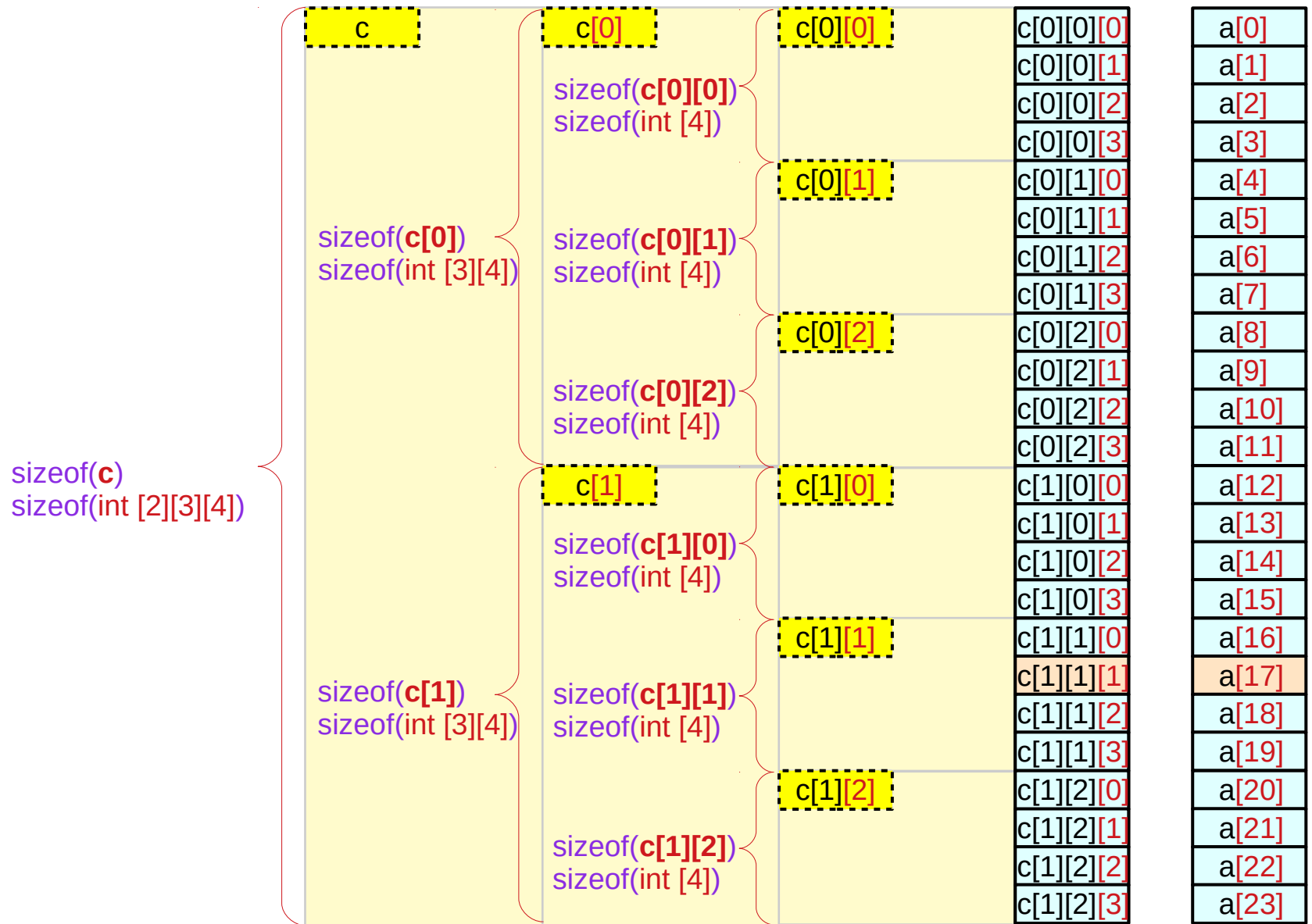

Virtual array pointer c , $c[i]$, $c[i][j]$ – values (addresses)

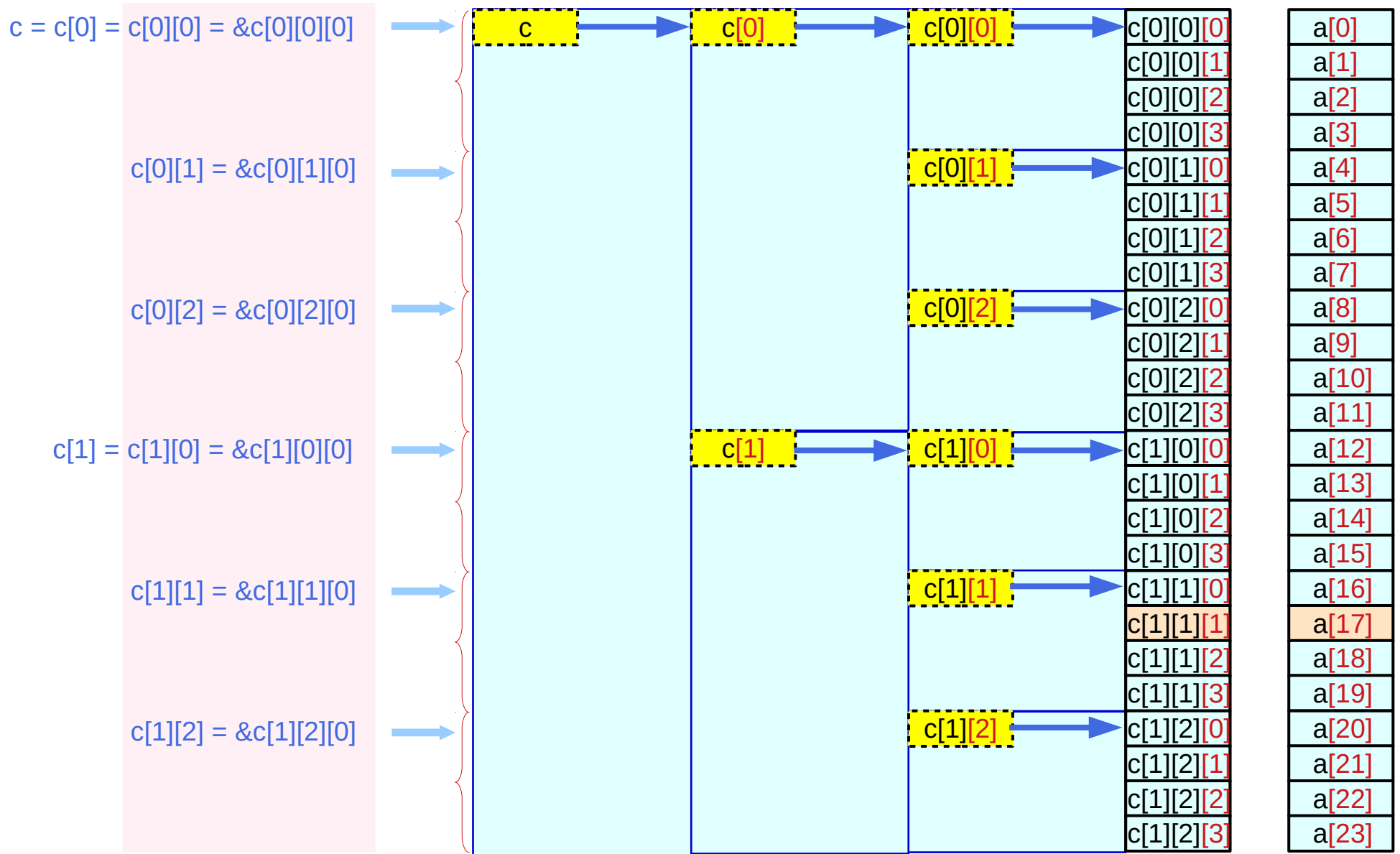

Virtual array pointer c , $c[i]$, $c[i][j]$ – vertical displacement

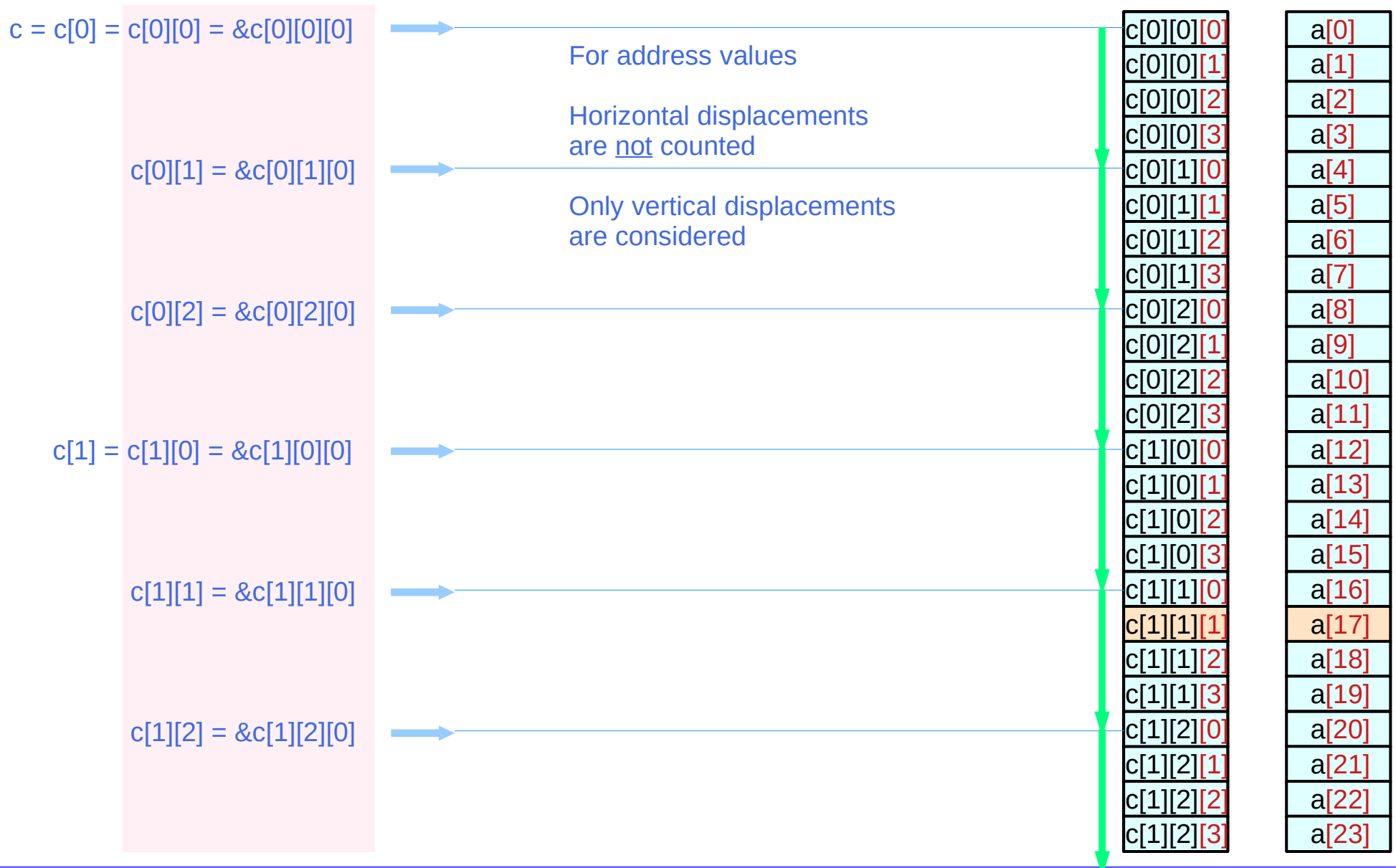

Virtual array pointer c, c[i], c[i][j] – values and types

$c = c[0] = c[0][0] = \&c[0][0][0]$ means \rightarrow
 $c[0][1] = \&c[0][1][0]$ means \rightarrow
 $c[0][2] = \&c[0][2][0]$ means \rightarrow
 $c[1] = c[1][0] = \&c[1][0][0]$ means \rightarrow
 $c[1][1] = \&c[1][1][0]$ means \rightarrow
 $c[1][2] = \&c[1][2][0]$ means \rightarrow

$value(c) = value(c[0]) = value(c[0][0]) = value(\&c[0][0][0])$ $type(c) \neq type(c[0]) \neq type(c[0][0]) = type(\&c[0][0][0])$ $int (*) [3][4] \quad int (*) [4] \quad int * \quad int *$
$value(c[0][1]) = value(\&c[0][1][0])$ $type(c[0][1]) = type(\&c[0][1][0])$ $int * \quad int *$
$value(c[0][2]) = value(\&c[0][2][0])$ $type(c[0][2]) = type(\&c[0][2][0])$ $int * \quad int *$
$value(c[1]) = value(c[1][0]) = value(\&c[1][0][0])$ $type(c[1]) \neq type(c[1][0]) = type(\&c[1][0][0])$ $int (*) [4] \quad int * \quad int *$
$value(c[1][1]) = value(\&c[1][1][0])$ $type(c[1][1]) = type(\&c[1][1][0])$ $int * \quad int *$
$value(c[1][2]) = value(\&c[1][2][0])$ $type(c[1][2]) = type(\&c[1][2][0])$ $int * \quad int *$

Virtual array pointer c, c[0], c[0][0] – types and sizes

Types – array pointers

`int (*) [3][4]`

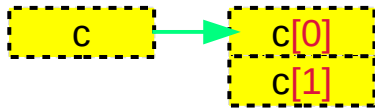

`int (*) [4]`

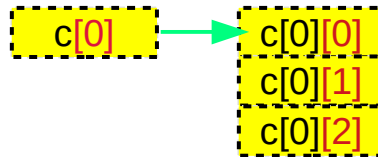

`int [4]`

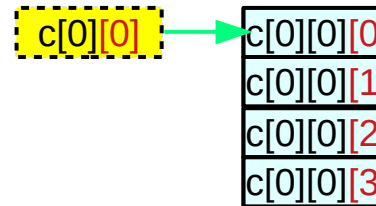

Sizes – abstract data

`sizeof(c)`

`sizeof(c[0]) * 2`

`sizeof(c[0][0]) * 2 * 3`

`sizeof(c[0][0][0]) * 2 * 3 * 4`

`sizeof(int [2][3][4])`

`sizeof(int [2][3][4]) = 96`

`sizeof(int (*)[3][4]) = 4 / 8`

`sizeof(c[0])`

`sizeof(c[0][0]) * 3`

`sizeof(c[0][0][0]) * 3 * 4`

`sizeof(int [3][4])`

`sizeof(int [3][4]) = 48`

`sizeof(int (*)[4]) = 4 / 8`

`sizeof(c[0][0])`

`sizeof(c[0][0][0]) * 4`

`sizeof(int [4])`

`sizeof(int [4]) = 16`

`sizeof(int (*) = 4 / 8`

`sizeof(c[0][0][0])`

`sizeof(int)`

`sizeof(int) = 4`

Abstract Data c , $c[i]$, $c[i][j]$ – start addresses and sizes

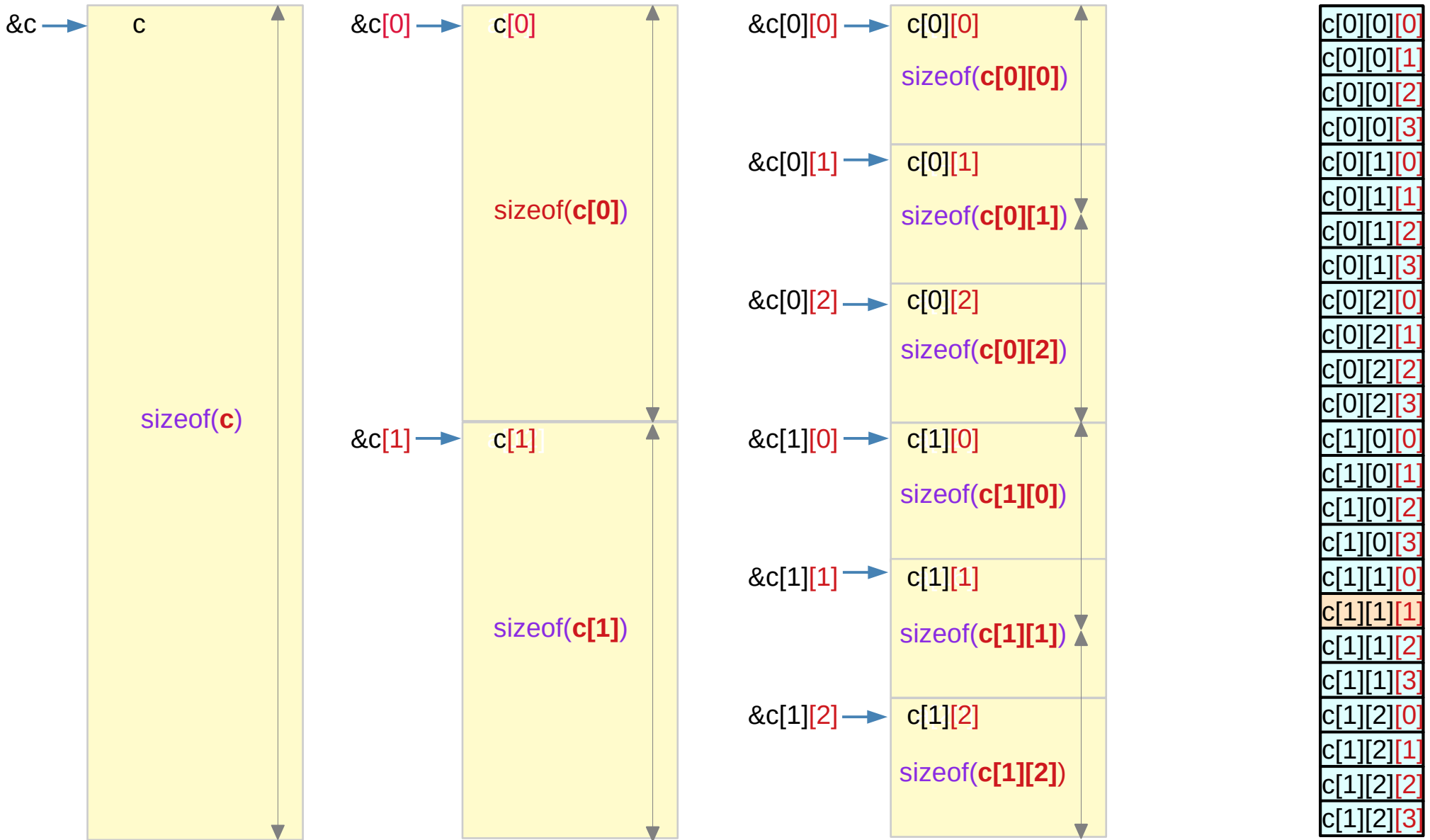

Types in a multi-dimensional array

```
int c [2][3][4];
```

abstract data `int [2] [3][4]`
array pointer `int (*) [3][4]`

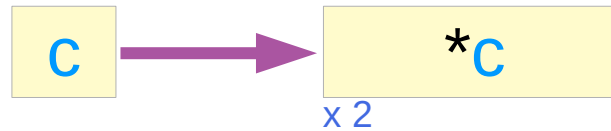

`int [3] [4]` abstract data
`int (*) [4]` array pointer

abstract data `int [3] [4]`
array pointer `int (*) [4]`

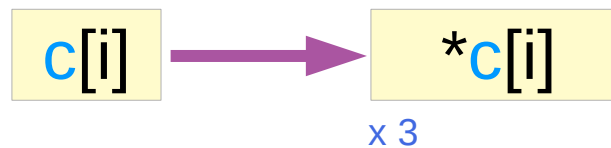

`int [4]` abstract data
`int (*)` array pointer

abstract data `int [4]`
array pointer `int (*)`

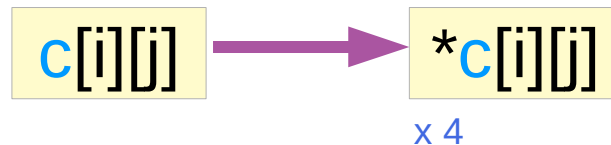

`int` primitive data

Virtual array pointers and abstract data

```
int c [2][3][4];
```

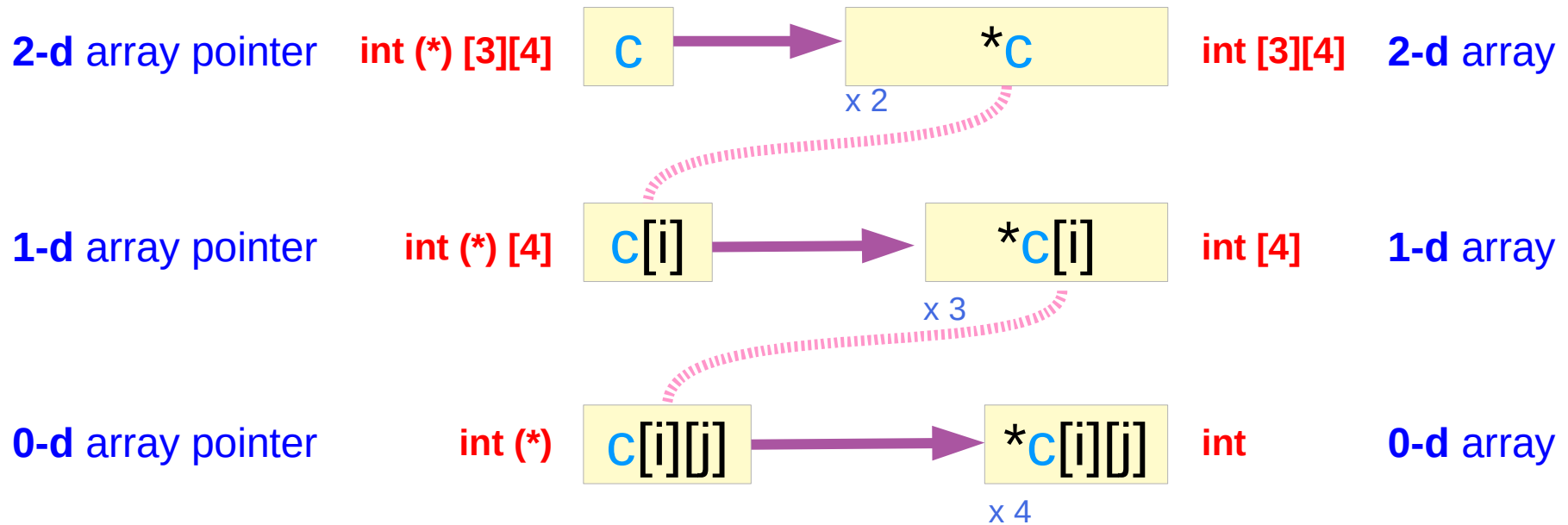

all these pointers are virtual, and take no actual memory locations

exploiting the **contiguity** of allocated memory locations

Abstract Data Sizes

```
int c [2][3][4];
```

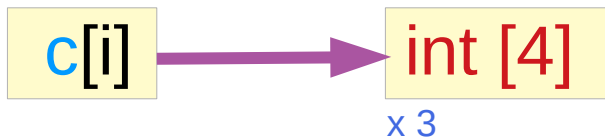
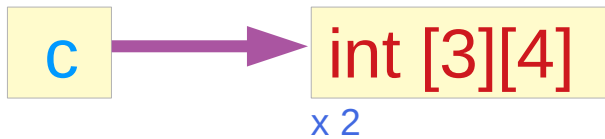

c, c[i], c[i][j] are virtual array pointers and they are also abstract data (arrays)

when sizes are considered, view them as abstract data (arrays)

the size of a pointer type is fixed
Here, the sizes of virtual pointers are shown
i.e, the sizes of different abstract data types

sizeof(c)	=	sizeof(int [2][3][4])
sizeof(*c)	=	sizeof(int [3][4])
sizeof(c[i])	=	sizeof(int [3][4])
sizeof(*c[i])	=	sizeof(int [4])
sizeof(c[i][j])	=	sizeof(int [4])
sizeof(*c[i][j])	=	sizeof(int)

all are sizes of arrays

Virtual array pointer sizes and abstract data sizes

```
int c [2][3][4];
```

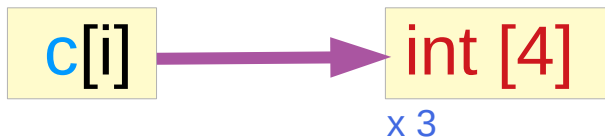
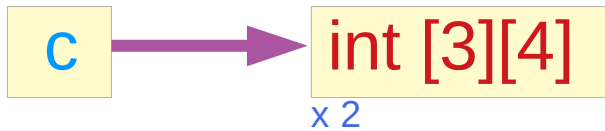

$$\text{size of a virtual array pointer} = \text{size of the pointed abstract data type} * \text{the number of such types}$$

$$\text{sizeof}(c) = \text{sizeof}(*c) * 2$$

$$\text{sizeof}(c[i]) = \text{sizeof}(*c[i]) * 3$$

$$\text{sizeof}(c[i][j]) = \text{sizeof}(*c[i][j]) * 4$$

Sizes of array pointer types

```
int c [2][3][4];
```

```
c → int [3][4]
```

```
c[i] → int [4]
```

```
c[i][j] → int
```

not real array pointers
virtual array pointers



```
c int (*)[3][4]  
sizeof(int (*) [3][4]) = pointer size ≠ sizeof(c)
```

```
c[i] int (*) [4]  
sizeof(int (*) [4]) = pointer size ≠ sizeof(c[i])
```

```
c[i][j] int [4]  
sizeof(int [4]) = pointer size ≠ sizeof(c[i][j])
```

4 bytes for 32-bit machines
8 bytes for 64-bit machines

Hierarchical nested array pointers

```
int c [2][3][4];
```

c points to a **2-d** array
increment size: $\text{sizeof(int)} * 2 * 3 * 4$

c[i] points to an **1-d** array
increment size: $\text{sizeof(int)} * 3 * 4$

c[i][j] points to an integer
increment size: $\text{sizeof(int)} * 4$

int (*) [3][4]

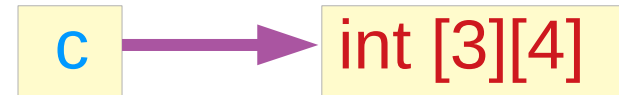

int (*) [4]

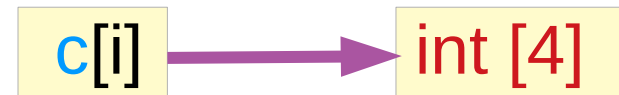

int (*)



Sub-array properties in multi-dimensional arrays

`int c [2][3][4];` → 3-d access `c [i][j][k]`

2-d array pointer	<code>c</code>	<code>int (*) [3][4]</code>
1-d array pointers	<code>c[i]</code>	<code>int (*) [4]</code>
0-d array pointers	<code>c[i][j]</code>	<code>int (*)</code>

Hierarchical Sub-arrays in a 3-d array

```
int c [L][M][N];
```

```
c [i][j][k]
```

left-to-right associativity

Array Names and Types

Pointers to hierarchical sub-arrays

c	[i]	[j][k]
c[i]	[j]	[k]
c[i][j]	[k]	

c	3-d array names	int (*) [M][N]	2-d array pointer
c[i]	2-d array names	int (*) [N]	1-d array pointer
c[i][j]	1-d array names	int (*)	0-d array pointer

General requirements for accessing `c[i][j][k]`

```
int c[L][M][N];
```

```
c[i][j][k]
```

```
&c[i][j][k] = c[i][j]+k  
&c[i][j]    = c[i]+j  
&c[i]       = c+i
```

```
&c[i][j][0] = c[i][j]  
&c[i][0]    = c[i]  
&c[0]       = c
```

3-d access pattern $c[i][j][k]$

General requirements

```
&c[i][j][k] = c[i][j]+k  
&c[i][j]   = c[i]+j  
&c[i]      = c+i
```

```
&c[i][j][0] = c[i][j]  
&c[i][0]   = c[i]  
&c[0]     = c
```

Pointer array approach

```
int** c[2];  
int*  b[2*3];  
int   c[2*3*4];
```

```
c[i][j][k] :: int  
c[i][j]    :: int *  
c[i]       :: int **
```

```
c[i] ← &b[i*3]  
b[j] ← &a[j*4]
```

**Hierarchical
Pointer Array
Constraints**

Nested Array approach

```
int c[2][3][4];
```

```
c[i][j][k] :: int  
c[i][j]    :: int [4]  
c[i]       :: int (*) [4]
```

```
c[i][j] ← &c[i][j][0]  
c[i]    ← &c[i][0][0]  
c       ← &c[0][0][0]
```

**Virtual
Array Pointer
Constraints**

3-d access pattern $c[i][j][k]$ – array pointer approach

General requirements

```
&c[i][j][k] = c[i][j]+k  
&c[i][j]    = c[i]+j  
&c[i]       = c+i
```

```
&c[i][j][0] = c[i][j]  
&c[i][0]    = c[i]  
&c[0]       = c
```



Nested array approach

```
int c[2][3][4];
```

```
c[i][j][k] :: int  
c[i][j]    :: int [4]  
c[i]       :: int (*) [4]  
c          :: int (*) [3][4]
```

```
c[i][j] ← &c[i][j][0]  
c[i]    ← &c[i][0][0]  
c       ← &c[0][0][0]
```

**Virtual
Array Pointer
Constraints**

Using virtual array pointers

```
int c [2][3][4];
```



```
c [i][j][k];
```

constraints

```
c ← &c[0][0][0]  
c[i] ← &c[i][0][0]  
c[i][j] ← &c[i][j][0]
```

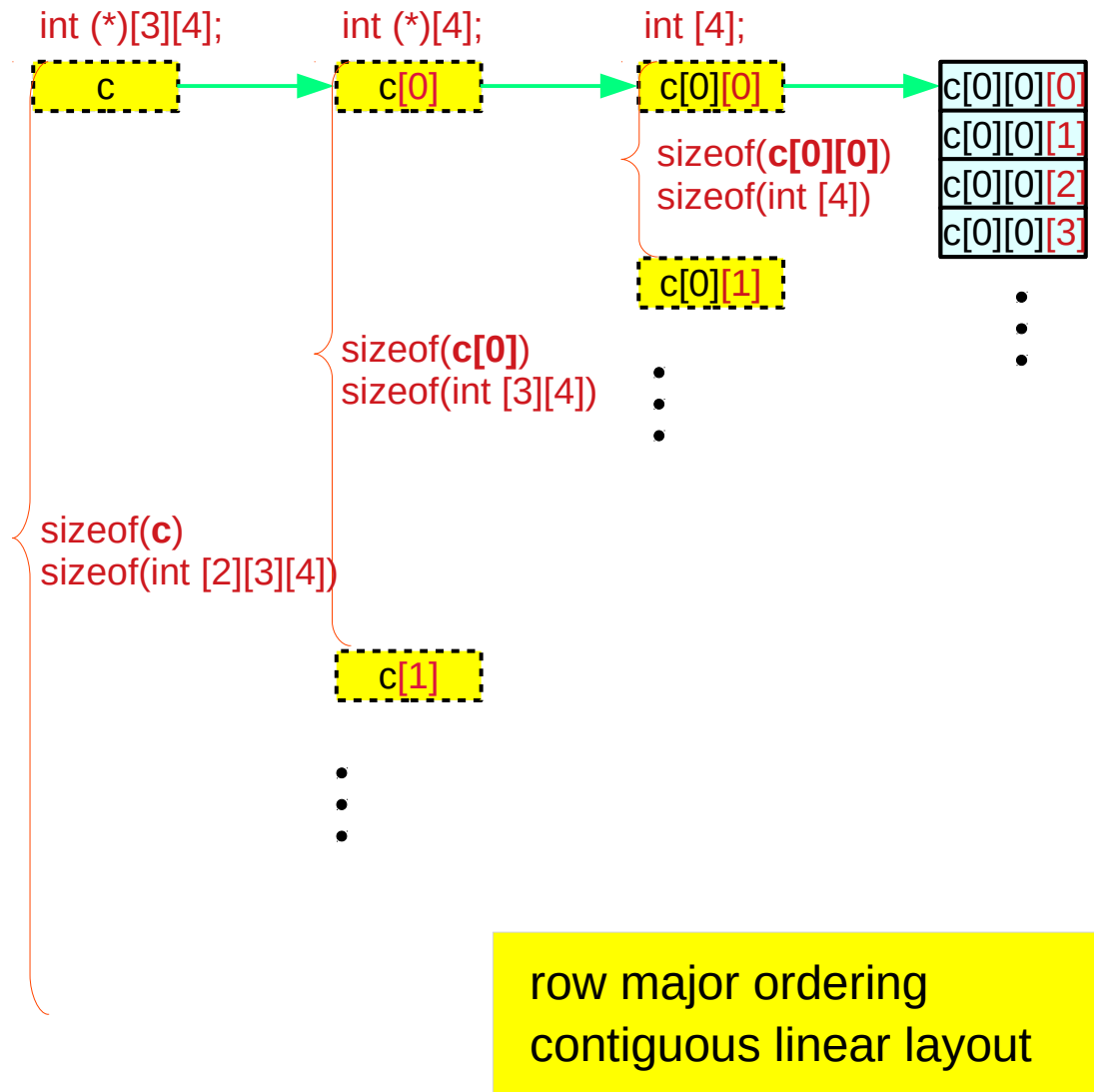

Types of `c[i]` and `c[i][j]`

`c [i][j][k];`

```
&c[i][j][0] = c[i][j]
&c[i][0]    = c[i]
&c[0]      = c
```

```
&c[i][j][k] = c[i][j]+k
&c[i][j]    = c[i]+j
&c[i]       = c+i
```

`int c [2][3][4];`

`c[i]` virtual array pointer of the type `int (*) [4]`

`c[i][j]` : the name of 1-d array with 4 integers `int [4]`

`c[i][j]` (virtual array) pointer of the type `int (*)`

`c[i][j][k]` : an element of a 4-integer array `int`

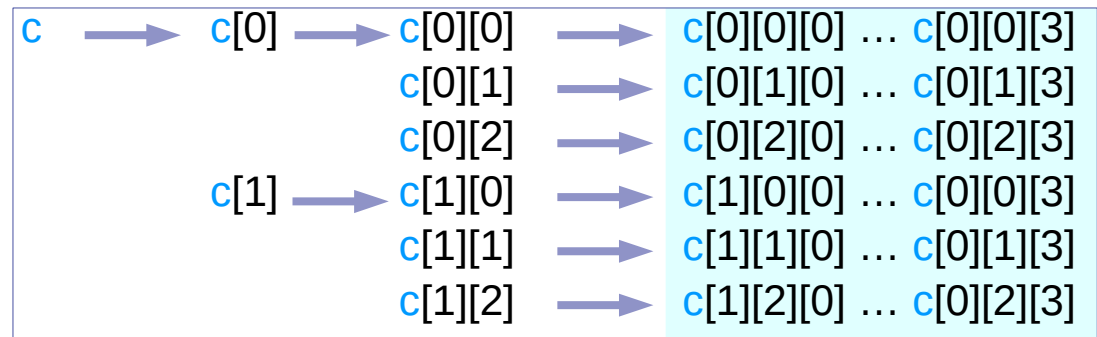

`int [2] [3][4]` `int [3] [4]` `int [4]` `int ... int`
`int (*) [3][4]` `int (*) [4]` `int (*)` `int ... int`

pointers to a 2-d array pointers to a 1-d array 1-d array names leading element of 4-integer array

Values of $c[i]$ and $c[i][j]$

$c[i][j][k];$

$\&c[i][j][0] = c[i][j]$
 $\&c[i][0] = c[i]$
 $\&c[0] = c$

$\&c[i][j][k] = c[i][j] + k$
 $\&c[i][j] = c[i] + j$
 $\&c[i] = c + i$

$\text{int } c[2][3][4];$

		$c[i][j]$	=	$\&c[i][j][0]$		
c	\rightarrow	$c[0]$	\rightarrow	$c[0][0]$	\equiv	$\&c[0][0][0]$
				$c[0][1]$	\equiv	$\&c[0][1][0]$
				$c[0][2]$	\equiv	$\&c[0][2][0]$
		$c[1]$	\rightarrow	$c[1][0]$	\equiv	$\&c[1][0][0]$
				$c[1][1]$	\equiv	$\&c[1][1][0]$
				$c[1][2]$	\equiv	$\&c[1][2][0]$

		$c[i]$	=	$\&c[i][0]$
c	\rightarrow	$c[0]$	\equiv	$\&c[0][0]$
		$c[1]$	\equiv	$\&c[1][0]$

c	$=$	$\&c[0]$
c	\equiv	$c[0]$

c[i] and c[i][j] : virtual array pointers

c [i][j][k];

$\&c[i][j][0] = c[i][j]$
 $\&c[i][0] = c[i]$
 $\&c[0] = c$

$\&c[i][j][k] = c[i][j] + k$
 $\&c[i][j] = c[i] + j$
 $\&c[i] = c + i$

int c [2][3][4];

c[i] virtual array pointer of the type **int (*) [4]**
c[i][j] : a 4-element 1-d array name

$*(c[0]+0) = c[0][0]$

c[0] is the address of **c[0][0]**

$*(c[1]+0) = c[1][0]$

c[1] is the address of **c[1][0]**

c[i][j] virtual array pointer of the type **int (*)**
c[i][j][0] : leading element of a 4-integer array

$*(c[0][0]+0) = c[0][0][0]$

c[0][0] is the address of **c[0][0][0]**

$*(c[0][1]+0) = c[0][1][0]$

c[0][1] is the address of **c[0][1][0]**

$*(c[0][2]+0) = c[0][2][0]$

c[0][2] is the address of **c[0][2][0]**

$*(c[1][0]+0) = c[1][0][0]$

c[1][0] is the address of **c[1][0][0]**

$*(c[1][1]+0) = c[1][1][0]$

c[1][1] is the address of **c[1][1][0]**

$*(c[1][2]+0) = c[1][2][0]$

c[1][2] is the address of **c[1][2][0]**

Values of $c[i]$ and $c[i][j]$

$c[i][j][k];$

$\&c[i][j][0] = c[i][j]$
 $\&c[i][0] = c[i]$
 $\&c[0] = c$

$\&c[i][j][k] = c[i][j] + k$
 $\&c[i][j] = c[i] + j$
 $\&c[i] = c + i$

$\text{int } c[2][3][4];$

virtual array pointers

in each row in the following figure
have the same value (address value)

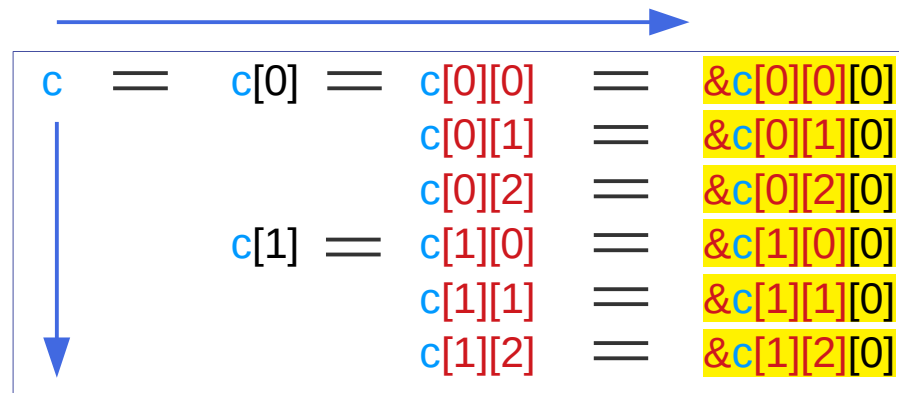

Horizontal displacements are not counted
only **vertical displacements** are considered
for address values

$c[i][j] = \&c[i][j][0]$
 $c[i] = \&c[i][0][0]$
 $c = \&c[0][0][0]$

Finding address values of $c[i]$ and $c[i][j]$

$c[i][j][k];$

$\&c[i][j][0] = c[i][j]$
 $\&c[i][0] = c[i]$
 $\&c[0] = c$

$\&c[i][j][k] = c[i][j] + k$
 $\&c[i][j] = c[i] + j$
 $\&c[i] = c + i$

$int\ c[2][3][4];$

$c[i][j] = \&c[i][j][0]$
 $c[i] = \&c[i][0][0]$
 $c = \&c[0][0][0]$

append [0] to the right

c	$\xlongequal{+[0]}$	$c[0]$	$\xlongequal{+[0]}$	$c[0][0]$	$\xlongequal{+[0]}$	$\&c[0][0][0]$
				$c[0][1]$	$\xlongequal{+[0]}$	$\&c[0][1][0]$
				$c[0][2]$	$\xlongequal{+[0]}$	$\&c[0][2][0]$
		$c[1]$	$\xlongequal{+[0]}$	$c[1][0]$	$\xlongequal{+[0]}$	$\&c[1][0][0]$
				$c[1][1]$	$\xlongequal{+[0]}$	$\&c[1][1][0]$
				$c[1][2]$	$\xlongequal{+[0]}$	$\&c[1][2][0]$
$int (*) [3][4]$		$int (*) [4]$		$int [4]$		int

Finding leading elements of `c[i][j][k]`

```
c [i][j][k];
```

```
&c[i][j][0] = c[i][j]  
&c[i][0]    = c[i]  
&c[0]      = c
```

```
&c[i][j][k] = c[i][j]+k  
&c[i][j]   = c[i]+j  
&c[i]      = c+i
```

```
int c [2][3][4];
```

```
c[i][j] = &c[i][j][0]  
c[i]    = &c[i][0][0]  
c       = &c[0][0][0]
```

delete [0] from the right

<code>&c[0][0][0]</code>	<u><u>-[0]</u></u>	<code>c[0][0]</code>	<u><u>-[0]</u></u>	<code>c[0]</code>	<u><u>-[0]</u></u>	<code>c</code>
<code>&c[0][1][0]</code>	<u><u>-[0]</u></u>	<code>c[0][1]</code>				
<code>&c[0][2][0]</code>	<u><u>-[0]</u></u>	<code>c[0][2]</code>				
<code>&c[1][0][0]</code>	<u><u>-[0]</u></u>	<code>c[1][0]</code>	<u><u>-[0]</u></u>	<code>c[1]</code>		
<code>&c[1][1][0]</code>	<u><u>-[0]</u></u>	<code>c[1][1]</code>				
<code>&c[1][2][0]</code>	<u><u>-[0]</u></u>	<code>c[1][2]</code>				
int		int [4]		int (*) [4]		int (*) [3][4]

c[i] = c[i][0] relation

`c [i][j][k];`

`&c[i][j][0] = c[i][j]`
`&c[i][0] = c[i]`
`&c[0] = c`

`&c[i][j][k] = c[i][j]+k`
`&c[i][j] = c[i]+j`
`&c[i] = c+i`

`int c [2][3][4];`

`c == c[0] == c[0][0] == &c[0][0][0]`

`value(c[0]) = &c[0][0][0]`

`value(c[0][0]) = &c[0][0][0]`

`type(c[0]) = int (*)[4]`

`type(c[0][0]) = int [4]`

`c[0] = c[0][0] means`
`value(c[0]) = value(c[0][0])`



`c[i][j] = &c[i][j][0]`
`c[i] = &c[i][0][0]`
`c = &c[0][0][0]`

Addresses and Values of $c[i]$ and $c[i][0]$

$c[i][j][k];$

$\&c[i][j][0] = c[i][j]$
 $\&c[i][0] = c[i]$
 $\&c[0] = c$

$\&c[i][j][k] = c[i][j] + k$
 $\&c[i][j] = c[i] + j$
 $\&c[i] = c + i$

$\text{int } c[2][3][4];$

$c \rightarrow c[0] \rightarrow c[0][0] = \&c[0][0][0]$

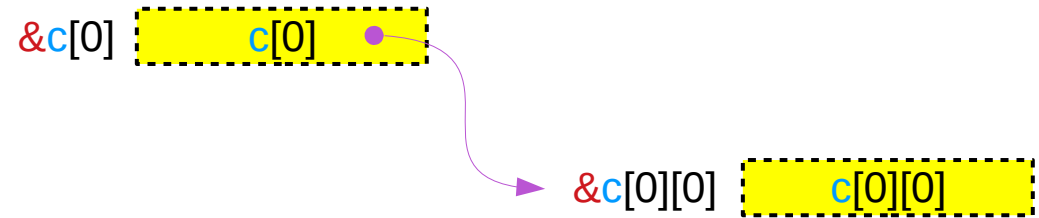

$c = c[0] = c[0][0] \quad \&c[0][0][0]$

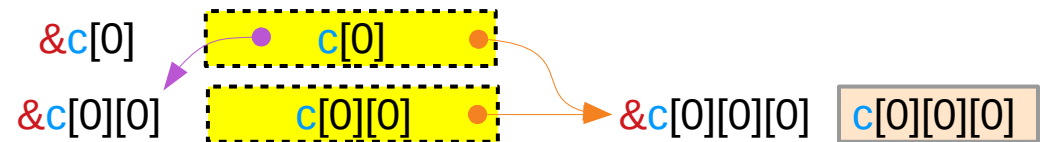

A virtual pointer's address and value are the same

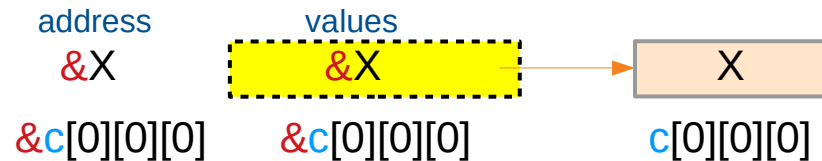

c[i] and c[i][0] point to the same c[i][0][0]

```
c [i][j][k];
```

```
&c[i][j][0] = c[i][j]
&c[i][0]    = c[i]
&c[0]      = c
```

```
&c[i][j][k] = c[i][j]+k
&c[i][j]    = c[i]+j
&c[i]       = c+i
```

```
int c [2][3][4];
```

```
c[i][j] = &c[i][j][0]
c[i]    = &c[i][0][0]
c       = &c[0][0][0]
```

```
c = c[0] = c[0][0] = &c[0][0][0] ← value
int(*)[3][4] int(*)[4] int(*) int ← type
```

```
c[1] = c[1][0] = &c[1][0][0] ← value
int(*)[4] int(*) int ← type
```

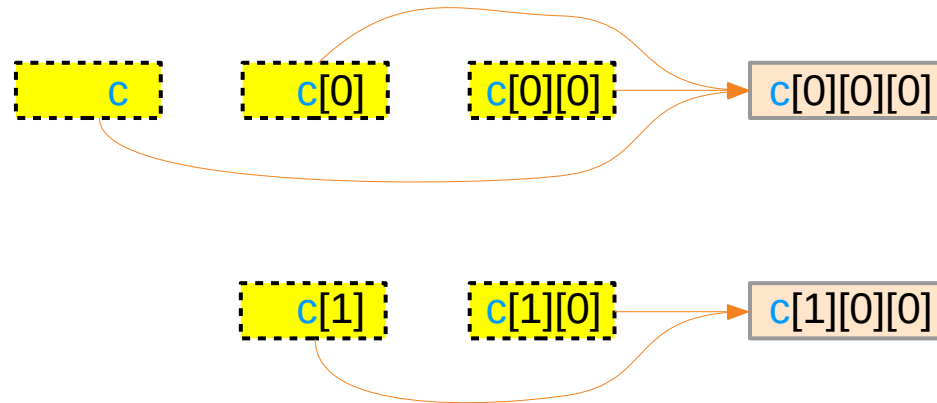

These virtual pointers have different types but the same value (address)

&c[i][0] and &c[i][0][0] – equivalence relations

`c [i][j][k];`

`&c[i][j][0] = c[i][j]`
`&c[i][0] = c[i]`
`&c[0] = c`

`&c[i][j][k] = c[i][j]+k`
`&c[i][j] = c[i]+j`
`&c[i] = c+i`

`int c [2][3][4];`

`c[i][j] = &c[i][j][0]`
`c[i] = &c[i][0][0]`
`c = &c[0][0][0]`

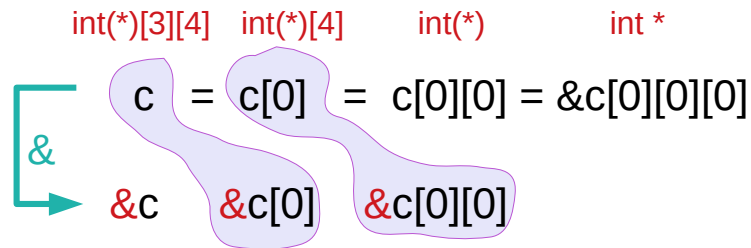

equivalences

`c ≡ &c[0],`
`c[0] ≡ &c[0][0]`
`c[0][0] ≡ &c[0][0][0]`

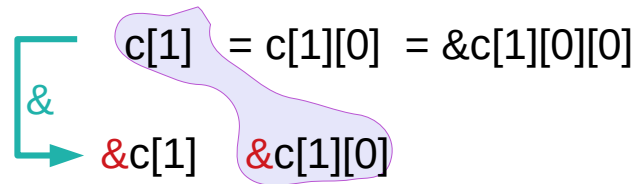

equivalences

`c[1] ≡ &c[1][0]`
`c[1][0] ≡ &c[1][0][0]`

Horizontal displacements are not counted
 only vertical displacements are considered
 for address values

equivalences

`c ≡ &c[0],`
`c[i] ≡ &c[i][0]`
`c[i][0] ≡ &c[i][0][0]`

$c[i] = \&c[i]$ and $c[i][0] = \&c[i][0]$

$c[i][j][k];$

$\&c[i][j][0] = c[i][j]$
 $\&c[i][0] = c[i]$
 $\&c[0] = c$

$\&c[i][j][k] = c[i][j] + k$
 $\&c[i][j] = c[i] + j$
 $\&c[i] = c + i$

$\text{int } c[2][3][4];$

$c[i][j] = \&c[i][j][0]$
 $c[i] = \&c[i][0][0]$
 $c = \&c[0][0][0]$

$c = c[0] = c[0][0] = \&c[0][0][0]$
 $\&c = \&c[0] = \&c[0][0]$

$c[1] = c[1][0] = \&c[1][0][0]$
 $\&c[1] = \&c[1][0]$

A virtual pointer's address and value are the same

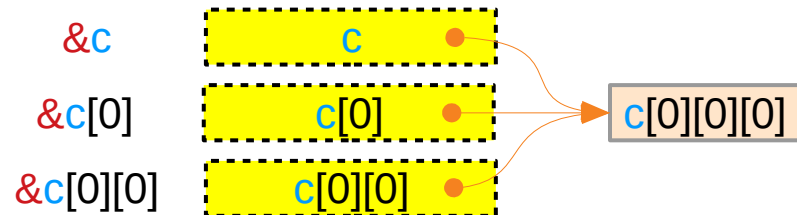

Array Pointers to $c[i][0][0]$

$c[i][j][k];$

$\&c[i][j][0] = c[i][j]$
 $\&c[i][0] = c[i]$
 $\&c[0] = c$

$\&c[i][j][k] = c[i][j] + k$
 $\&c[i][j] = c[i] + j$
 $\&c[i] = c + i$

$\text{int } c[2][3][4];$

$c[i][j] = \&c[i][j][0]$
 $c[i] = \&c[i][0][0]$
 $c = \&c[0][0][0]$

$\&c[i][0][0] \equiv c[i][0]$

$\&c[i][0] \equiv c[i]$

$\&c[i] \equiv c + i$

$= \&c[0][0][0] + i * 3 * 4$

virtual pointers:
the address of a pointer is
the same as its value

delete [0] from the right

$\&c[0][0][0] \xrightarrow{-[0]} c[0][0] \xrightarrow{-[0]} c[0] \xrightarrow{-[0]} c$
 $\&c[1][0][0] \xrightarrow{-[0]} c[1][0] \xrightarrow{-[0]} c[1]$

Array Pointers to $c[i][j][0]$

$c[i][j][k];$

$\&c[i][j][0] = c[i][j]$
 $\&c[i][0] = c[i]$
 $\&c[0] = c$

$\&c[i][j][k] = c[i][j] + k$
 $\&c[i][j] = c[i] + j$
 $\&c[i] = c + i$

$\text{int } c[2][3][4];$

$c[i][j] = \&c[i][j][0]$
 $c[i] = \&c[i][0][0]$
 $c = \&c[0][0][0]$

$\&c[i][j][0] \equiv c[i][j]$

$\&c[i][j] \equiv c[i] + j$

$= \&c[0][0][0] + i*3*4 + j*4$

delete [0] from the right

$\&c[0][0][0]$	\equiv	$c[0][0]$	\equiv	$c[0]$	\equiv	c
$\&c[0][1][0]$	\equiv	$c[0][1]$				
$\&c[0][2][0]$	\equiv	$c[0][2]$				
$\&c[1][0][0]$	\equiv	$c[1][0]$	\equiv	$c[1]$		
$\&c[1][1][0]$	\equiv	$c[1][1]$				
$\&c[1][2][0]$	\equiv	$c[1][2]$				

Contiguity Constraints

c [i][j][k];

Virtual Array Pointers and Contiguity

Using array pointers

```
int (*) [N], int (*) [M][N], int (*) [L][M][N], ...
```

Array pointer approach for 3-d access patterns

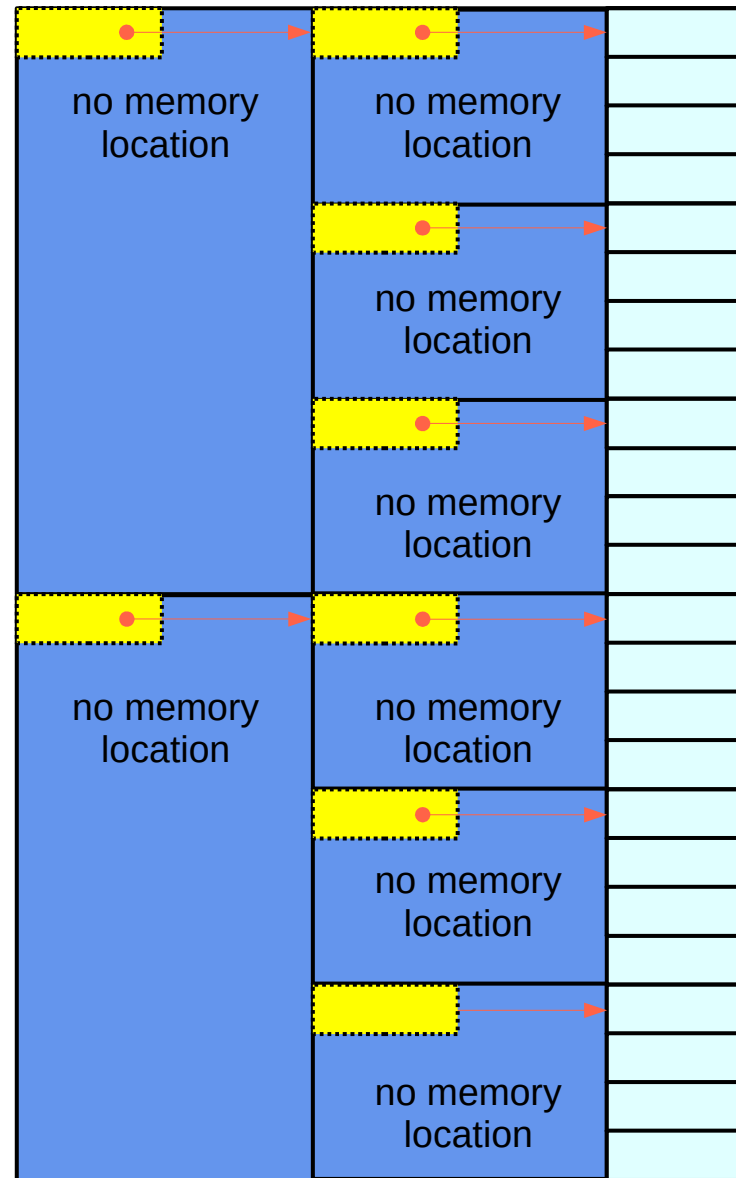

Array Pointer Approach
(pointer to arrays)

Array pointer approach – contiguity constraints

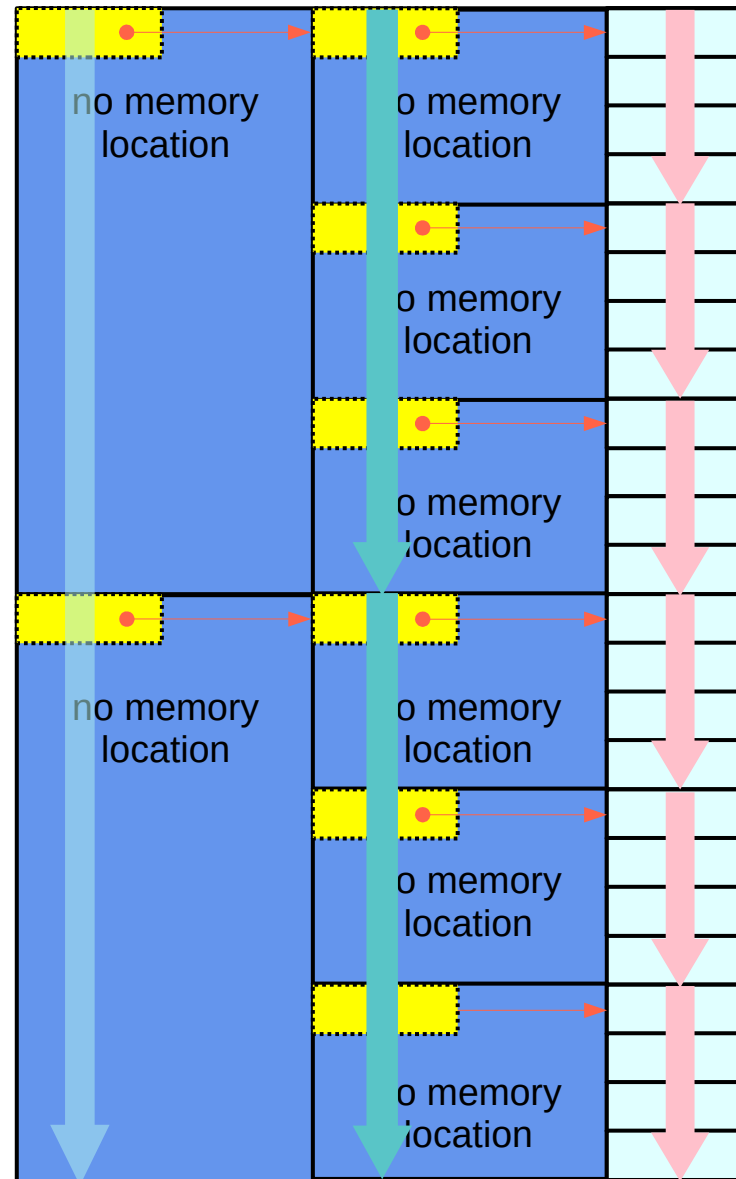

Array Pointer Approach
(pointer to arrays)

Three contiguity constraints

Pointer Array Approach (array of pointers)

$c[i][j][k]$ \rightarrow $*(c[i][j] + k)$
 $*(c[i][j] + k)$ \rightarrow $*(*(c[i] + j) + k)$
 $*(*(c[i] + j) + k)$ \rightarrow $*(**(*c + i) + j) + k)$

contiguous **1-d** array elements int
contiguous **int** pointers int^*
contiguous **int** double pointers int^{**}

The contiguity constraints are satisfied by the allocated arrays of pointers

Array Pointer Approach (pointer to arrays)

$c[i][j][k]$ \rightarrow $*(c[i][j] + k)$
 $*(c[i][j] + k)$ \rightarrow $*(*(c[i] + j) + k)$
 $*(*(c[i] + j) + k)$ \rightarrow $*(**(*c + i) + j) + k)$

contiguous **1-d** array elements int
contiguous **1-d** arrays $\text{int} [4]$
contiguous **1-d** array pointers $\text{int} (*) [4]$

The contiguity constraints are satisfied by row major ordered linear data layout

$$c[i][j][k] \equiv *(c[i][j] + k)$$

```

c[0][0][0] = *(c[0][0] + 0)
c[0][0][1] = *(c[0][0] + 1)
c[0][0][2] = *(c[0][0] + 2)
c[0][0][3] = *(c[0][0] + 3)
c[0][1][0] = *(c[0][1] + 0)
c[0][1][1] = *(c[0][1] + 1)
c[0][1][2] = *(c[0][1] + 2)
c[0][1][3] = *(c[0][1] + 3)

```

• •
• •
• •

contiguous 1-d
array elements

c[i][j] :: int *
contiguous 1-d
array elements
int ... 4 elements
sizeof(c[i][j])
sizeof(int) * 4

Address Value

c[i][j] + k

&c[i][j][0] + k * sizeof(*c[i][j])

&c[i][j][0] + k * sizeof(c[i][j][0])

&c[i][j][0] + k * 4

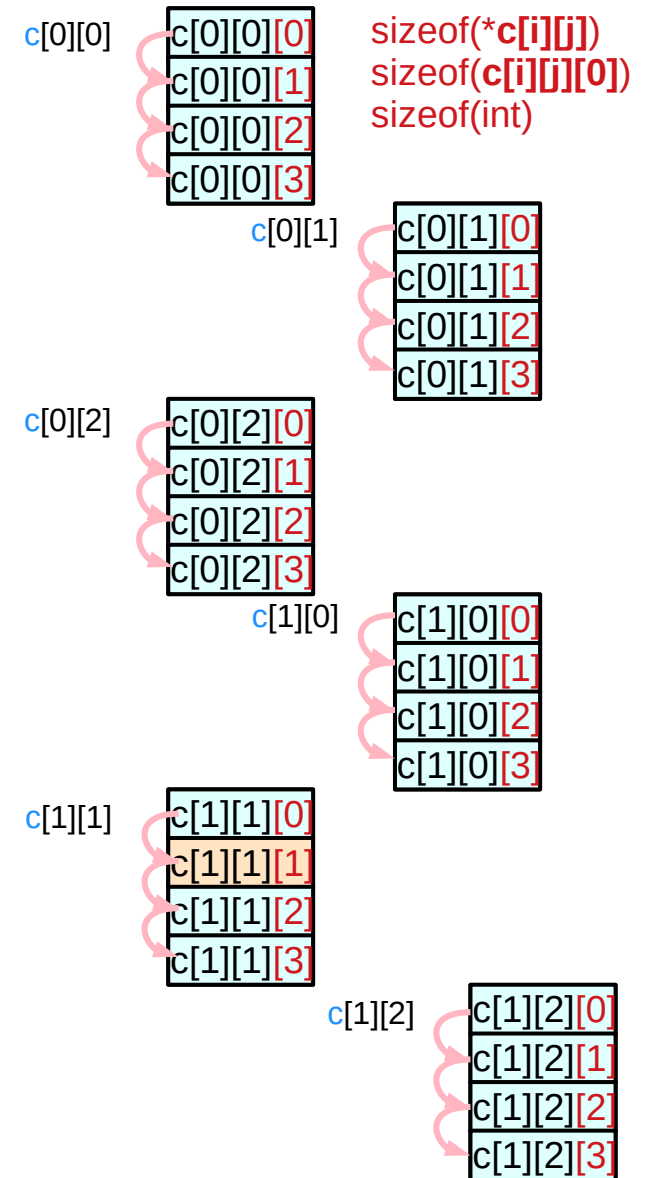

$$c[i][j] \equiv *(c[i] + j)$$

```

c[0][0] = *(c[0] + 0)
c[0][1] = *(c[0] + 1)
c[0][2] = *(c[0] + 2)
c[1][0] = *(c[1] + 0)
c[1][1] = *(c[1] + 1)
c[1][2] = *(c[1] + 2)

```

c[i] :: int (*) [4]
 contiguous 1-d arrays
int[4] = int * ... 3 arrays
 sizeof(**c[i]**)
 sizeof(**c[i][j]**) * 3
 sizeof(**c[i][j][k]**) * 3 * 4
 sizeof(int) * 3 * 4

Address Value

$c[i] + j$

$\&c[i][0][0] + j * \text{sizeof}(*c[i])$

$\&c[i][0][0] + j * \text{sizeof}(c[i][0])$

$\&c[i][0][0] + j * 4 * 4$

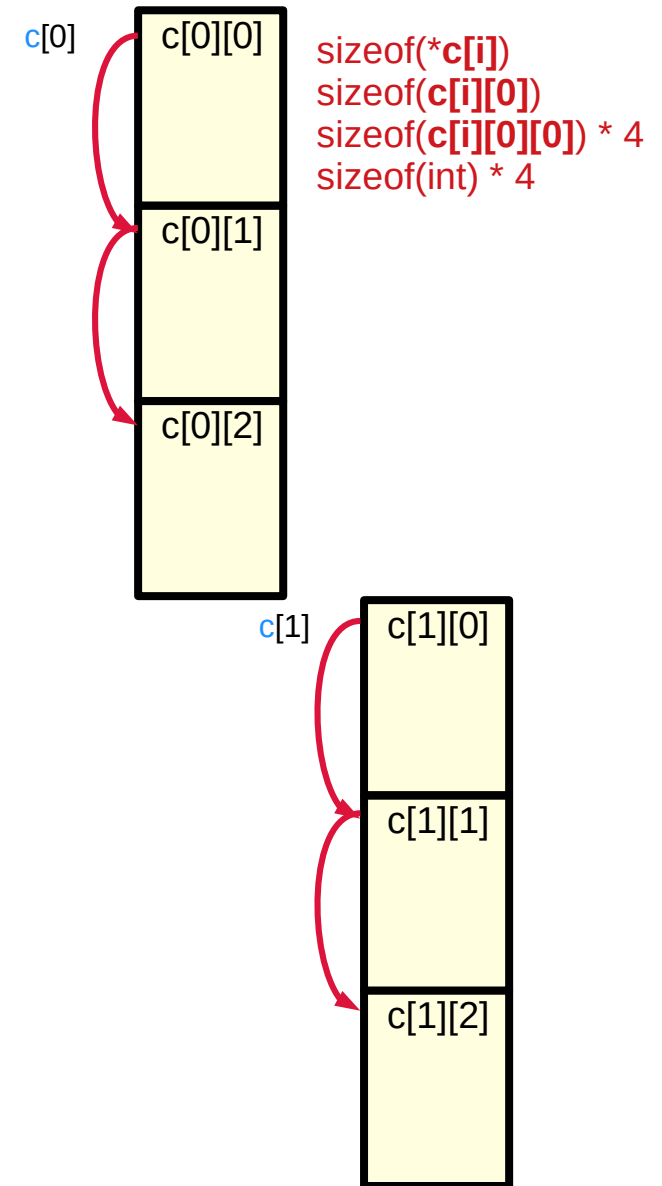

$$c[i] \equiv *(c + i)$$

```
c[0] = *(c + 0)
c[1] = *(c + 1)
```

`c :: int (*) [3][4]`
 contiguous
 1-d array pointers
`int (*) [4]` ... 2 array pointers
`sizeof(c)`
`sizeof(c[i]) * 2`
`sizeof(c[i][j]) * 2 * 3`
`sizeof(c[i][j][k]) * 2 * 3 * 4`
`sizeof(int) * 2 * 3 * 4`

Address Value

`c + i`
`&c[0][0][0] + i * sizeof(*c)`
`&c[0][0][0] + i * sizeof(c[0])`
`&c[0][0][0] + i * 4 * 4 * 3`

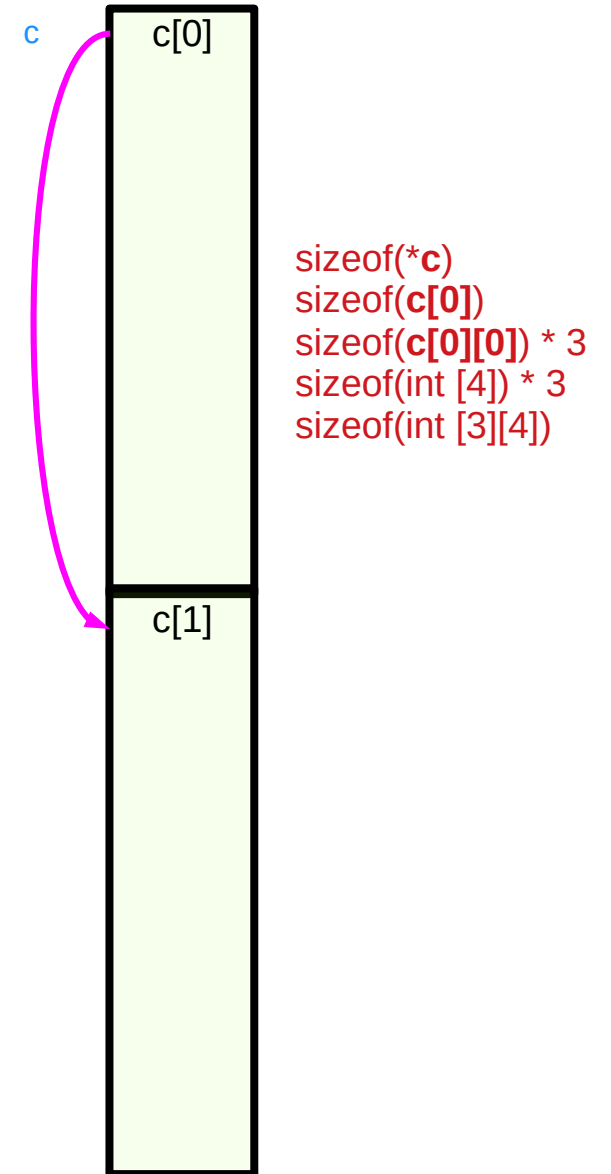

$$c[i] \equiv *(c + i)$$

2-d array pointer c
`int (*) [3][4]`

1-d array pointers $c[i]$
`int (*) [4]`

0-d array pointers $c[i][j]$
`int (*)`

$$c[i] \equiv *(c + i)$$

$$c[i][j] \equiv *(c[i] + j)$$

$$c[i][j][k] \equiv *(c[i][j] + k)$$

address value $c + i$

$\&c[0][0][0] + i * \text{sizeof}(*c)$
 $\&c[0][0][0] + i * \text{sizeof}(c[0])$
 $\&c[0][0][0] + i * 4 * 4 * 3$

address value $c[i] + j$

$\&c[i][0][0] + j * \text{sizeof}(*c[i])$
 $\&c[i][0][0] + j * \text{sizeof}(c[i][0])$
 $\&c[i][0][0] + j * 4 * 4$

address value $c[i][j] + k$

$\&c[i][j][0] + k * \text{sizeof}(*c[i][j])$
 $\&c[i][j][0] + k * \text{sizeof}(c[i][j][0])$
 $\&c[i][j][0] + k * 4$

leading elements

$c[0][0][0]$

leading elements

$c[0][0][0]$

$c[1][0][0]$

leading elements

$c[0][0][0]$

$c[0][1][0]$

$c[0][2][0]$

$c[1][0][0]$

$c[1][1][0]$

$c[1][2][0]$

Equivalence and contiguity

$$*(X+n) \equiv X[n]$$

contiguous index : n

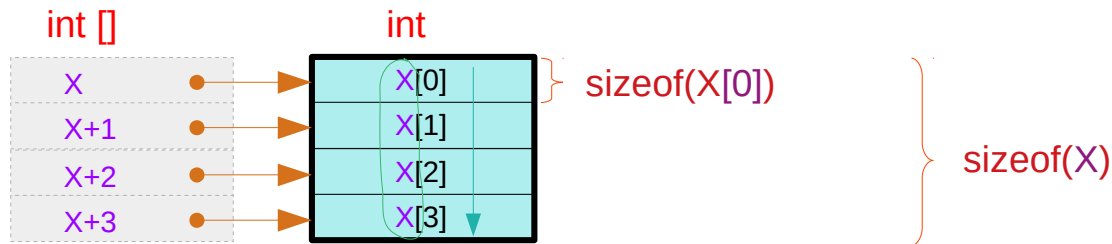

contiguous X[n] for a given X : **int X[4];**

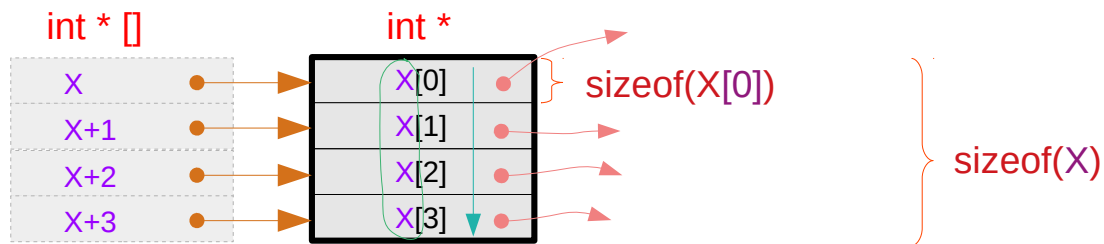

contiguous X[n] for a given X : **int * X[4];**

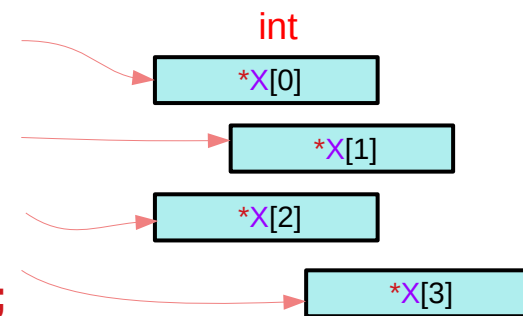

Equivalence

By definition, contiguous memory locations are assumed

$$*(X+n) \equiv X[n]$$

contiguous index : n

$$*(p[m]+n) \leftrightarrow p[m][n]$$

$$X = p[m] \quad \text{contiguous index : } n$$

$$(*(p+m))[n]; \leftrightarrow p[m][n];$$

$$X = p \quad \text{contiguous index : } m$$

For a given $p[m]$ – int pointer / pointer to int pointer

$$*(p[m]+n) \longleftrightarrow p[m][n]$$

for a given $p[m]$ contiguous index : n

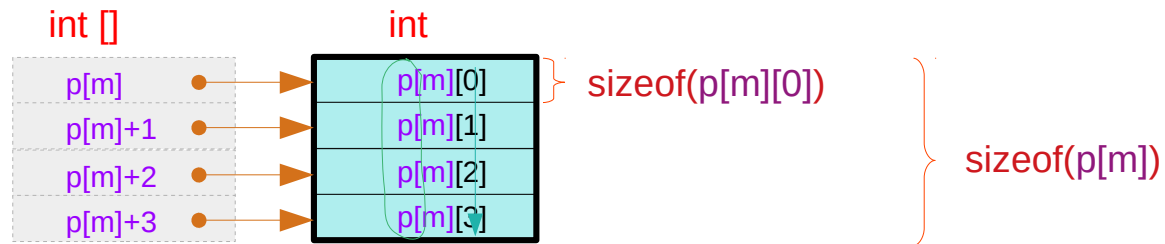

contiguous $p[m][n]$ for a given $p[m]$: `int p[m][4];`

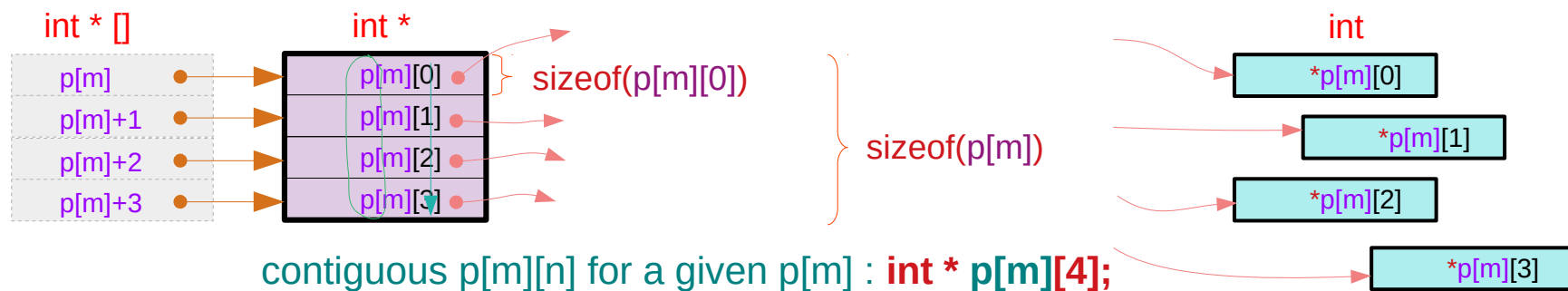

contiguous $p[m][n]$ for a given $p[m]$: `int * p[m][4];`

For a given $p[m]$ – pointer to an abstract data

$$*(p[m]+n) \longleftrightarrow p[m][n]$$

for a given $p[m]$ contiguous index : n

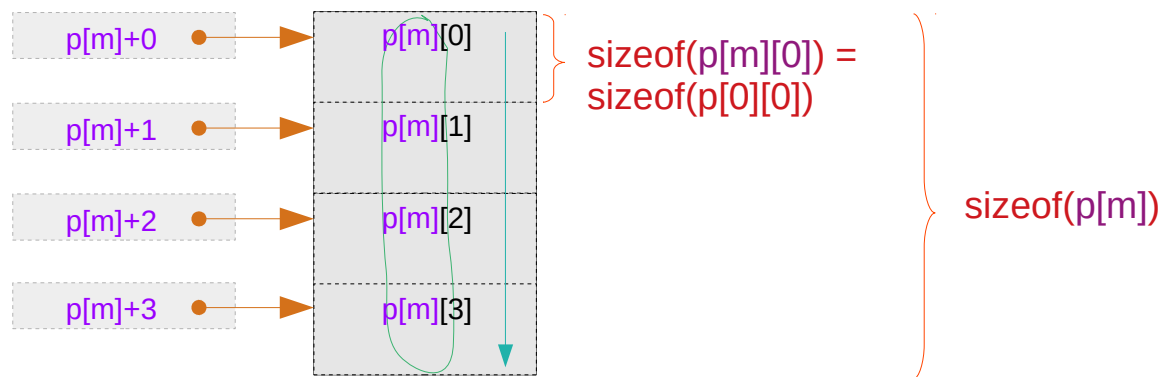
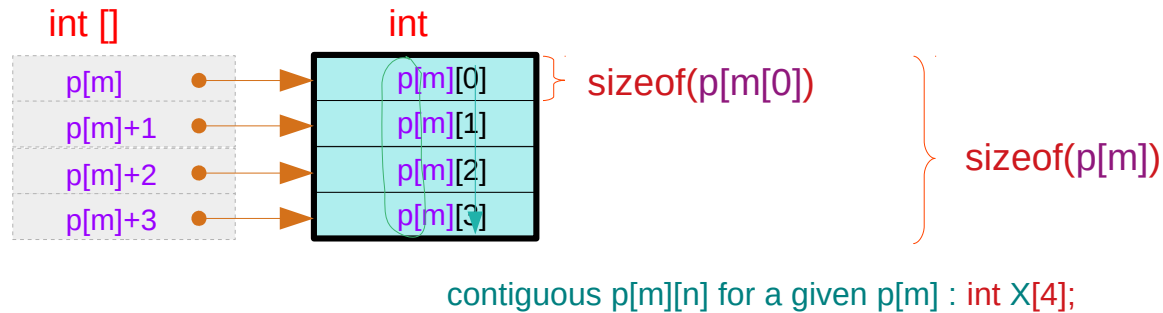

Contiguity constraints

$$(*(\mathbf{p}+\mathbf{m}))[\mathbf{n}]; \iff \mathbf{p}[\mathbf{m}][\mathbf{n}];$$

for a given \mathbf{p} contiguous index : \mathbf{m}

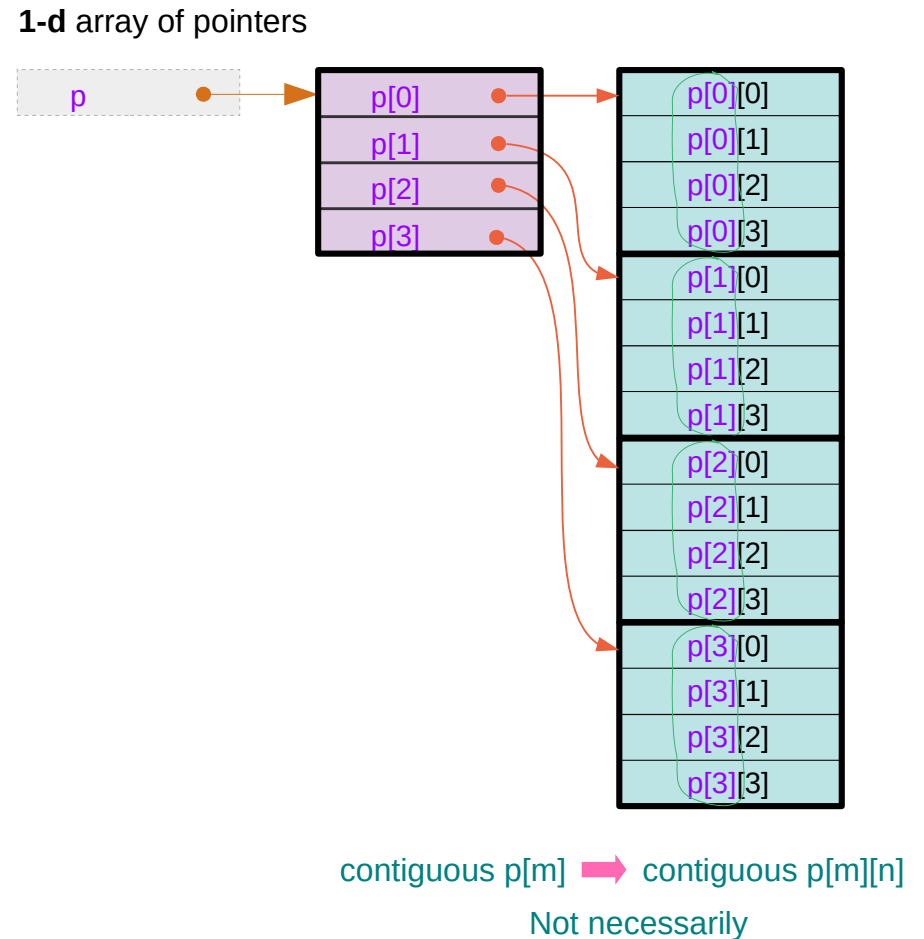
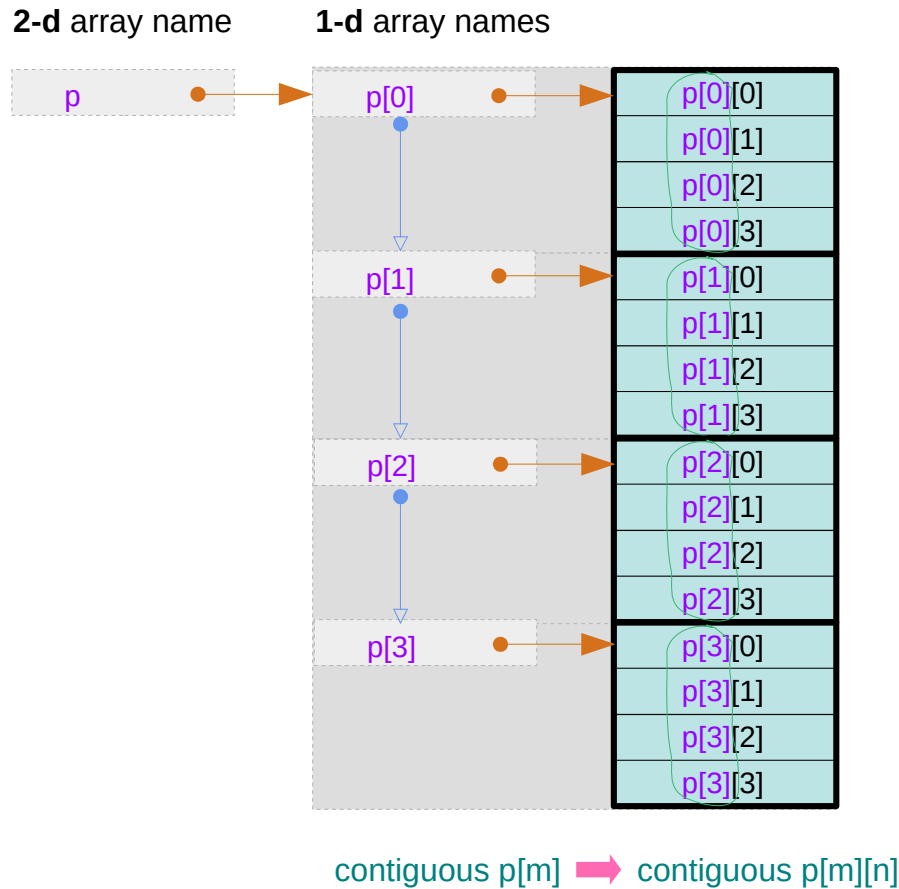

Contiguity constraints – using array pointers

$$(*(\mathbf{p}+\mathbf{m}))[\mathbf{n}]; \iff \mathbf{p}[\mathbf{m}][\mathbf{n}];$$

for a given \mathbf{p} contiguous index : \mathbf{m}

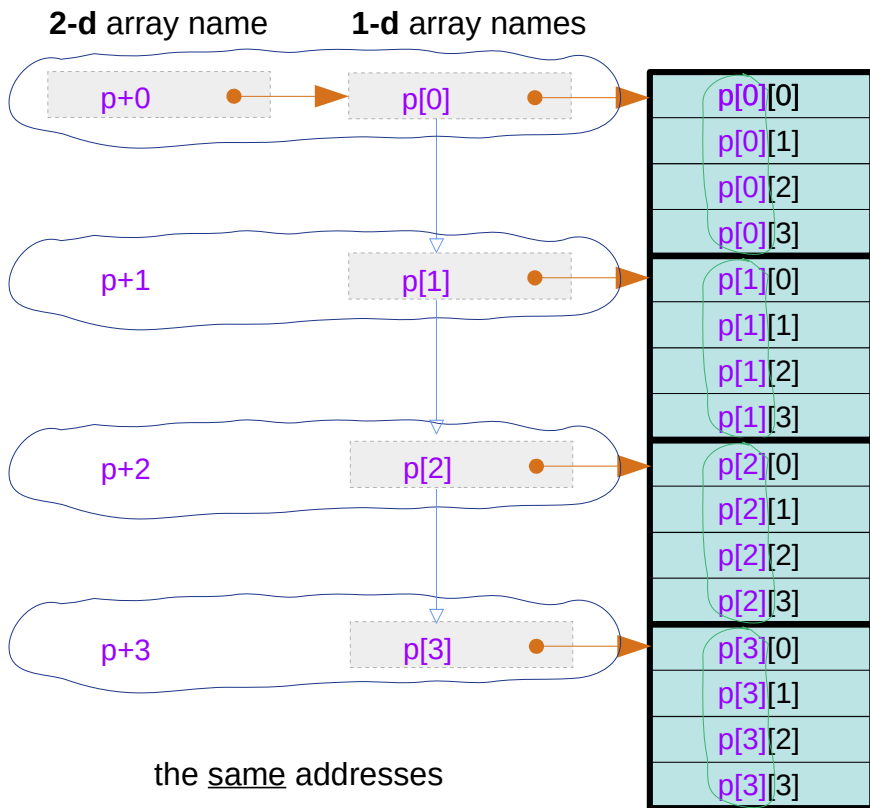

contiguous $\mathbf{p}[\mathbf{m}]$ \rightarrow contiguous $\mathbf{p}[\mathbf{m}][\mathbf{n}]$

virtual array pointer

$$\begin{array}{l} \text{data} \\ \mathbf{p}[\mathbf{0}][\mathbf{0}] = *(\mathbf{p}[\mathbf{0}]+\mathbf{0}) \end{array} \xrightarrow{\text{addr}} (\mathbf{p}[\mathbf{0}]+\mathbf{0}) = \mathbf{p}[\mathbf{0}] \xrightarrow{\text{addr}} \mathbf{p}+\mathbf{0}$$

$$\begin{array}{l} \text{data} \\ \mathbf{p}[\mathbf{1}][\mathbf{0}] = *(\mathbf{p}[\mathbf{1}]+\mathbf{0}) \end{array} \xrightarrow{\text{addr}} (\mathbf{p}[\mathbf{1}]+\mathbf{0}) = \mathbf{p}[\mathbf{1}] \xrightarrow{\text{addr}} \mathbf{p}+\mathbf{1}$$

$$\begin{array}{l} \text{data} \\ \mathbf{p}[\mathbf{2}][\mathbf{0}] = *(\mathbf{p}[\mathbf{2}]+\mathbf{0}) \end{array} \xrightarrow{\text{addr}} (\mathbf{p}[\mathbf{2}]+\mathbf{0}) = \mathbf{p}[\mathbf{2}] \xrightarrow{\text{addr}} \mathbf{p}+\mathbf{2}$$

$$\begin{array}{l} \text{data} \\ \mathbf{p}[\mathbf{3}][\mathbf{0}] = *(\mathbf{p}[\mathbf{3}]+\mathbf{0}) \end{array} \xrightarrow{\text{addr}} (\mathbf{p}[\mathbf{3}]+\mathbf{0}) = \mathbf{p}[\mathbf{3}] \xrightarrow{\text{addr}} \mathbf{p}+\mathbf{3}$$

the same addresses

\iff no real memory locations

Contiguity constraints – using pointer arrays

$$(*(\mathbf{p}+\mathbf{m}))[\mathbf{n}]; \iff \mathbf{p}[\mathbf{m}][\mathbf{n}];$$

for a given \mathbf{p} contiguous index : \mathbf{m}

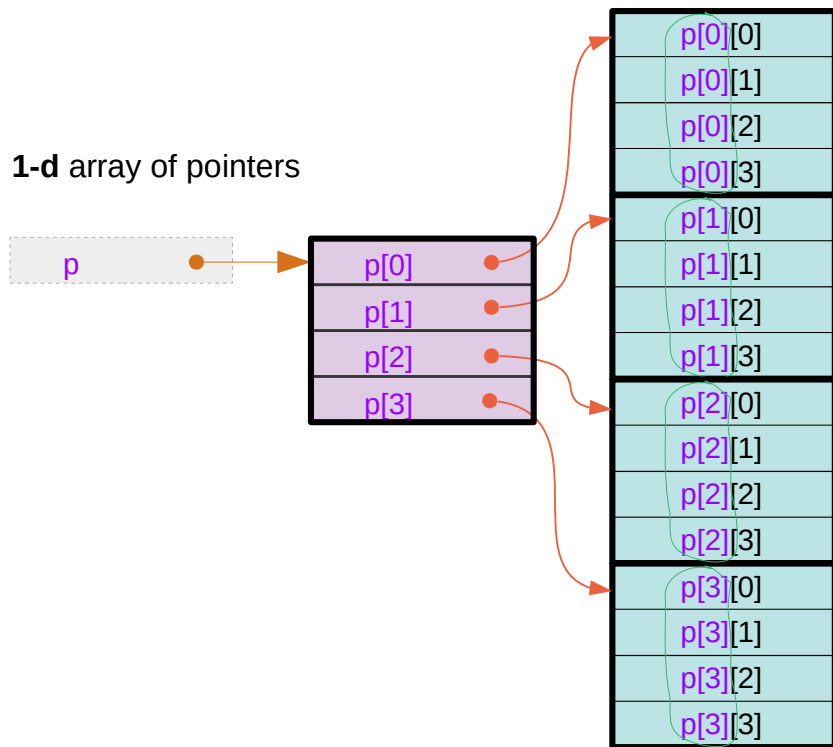

contiguous $p[m]$ \rightarrow contiguous $p[m][n]$
Not necessarily

the different addresses

$$\begin{array}{l} \text{data} \\ p[0][0] = *(p[0]+0) \end{array} \xrightarrow{\text{addr}} (p[0]+0) = p[0] \xrightarrow{\text{addr}} p+0$$

$$\begin{array}{l} \text{data} \\ p[1][0] = *(p[1]+0) \end{array} \xrightarrow{\text{addr}} (p[1]+0) = p[1] \xrightarrow{\text{addr}} p+1$$

$$\begin{array}{l} \text{data} \\ p[2][0] = *(p[2]+0) \end{array} \xrightarrow{\text{addr}} (p[2]+0) = p[2] \xrightarrow{\text{addr}} p+2$$

$$\begin{array}{l} \text{data} \\ p[3][0] = *(p[3]+0) \end{array} \xrightarrow{\text{addr}} (p[3]+0) = p[3] \xrightarrow{\text{addr}} p+3$$

Contiguity constraints

$$*(p[m]+n) \iff p[m][n]$$

for a given $p[m]$, thus for a given m ,
 $p[m][n]$ must be contiguous for all n .
 $p[m][0], p[m][1], \dots, p[m][N-1]$

contiguous index : n

$$(*(p+m))[n]; \iff p[m][n];$$

for a given p ,
 $p[m]$'s must be contiguous for all m .
 $p[0], p[1], \dots, p[M-1]$

contiguous index : m



all $p[m][n]$'s must be contiguous for all m, n

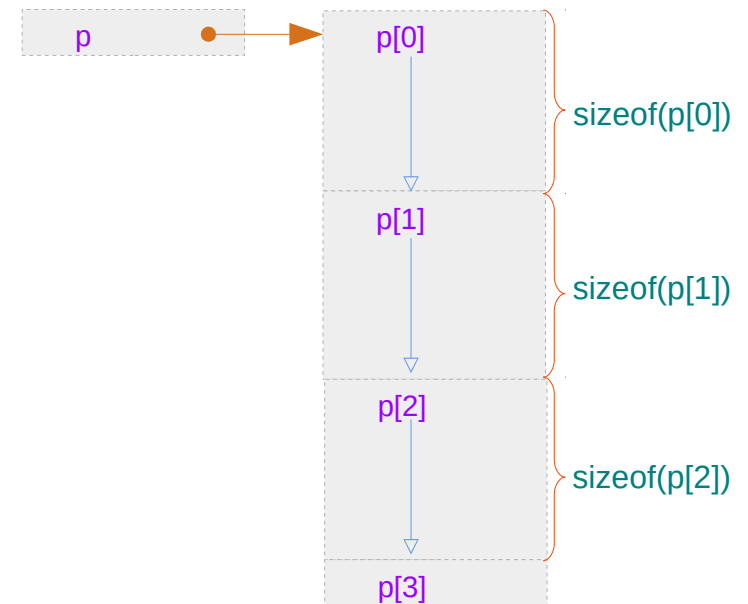
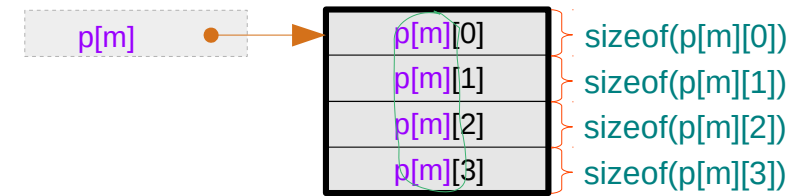

Contiguity constraints

```
int a[M][N] ;
```

$(*(a+m))[n]$ \longleftrightarrow $a[m][n]$
 $*(a[m]+n)$ \longleftrightarrow $a[m][n]$

```
int (*b)[N] ;
```

$(*(b+m))[n]$ \longleftrightarrow $b[m][n]$
 $*(b[m]+n)$ \longleftrightarrow $b[m][n]$

```
int * c[M] ;
```

$(*(c+m))$ \longleftrightarrow $c[m]$
needs assignments

Contiguity constraints

```
int a[M][N] ;
```

$(*(a+m))[n] \longleftrightarrow a[m][n]$

$a[0], a[1], \dots, a[M-1]$
are contiguous

$*(a[m]+n) \longleftrightarrow a[m][n]$

$a[m][0], a[m][1], \dots, a[m][N-1]$
are contiguous

```
int (*b)[N] ;
```

$(*(b+m))[n] \longleftrightarrow b[m][n]$

$b[0], b[1], \dots, b[M-1]$
are contiguous

$*(b[m]+n) \longleftrightarrow b[m][n]$

$b[m][0], b[m][1], \dots, b[m][N-1]$
are contiguous

Contiguity constraints

```
int a[M][N] ;
```

$(*(a+m))[n] \longleftrightarrow a[m][n]$

$a[0], a[1], \dots, a[M-1]$
are contiguous

$*(a[m]+n) \longleftrightarrow a[m][n]$

$a[m][0], a[m][1], \dots, a[m][N-1]$
are contiguous

```
int * c[M] ;
```

$(*(c+m)) \longleftrightarrow c[m]$

$c[0], c[1], \dots, c[M-1]$
are contiguous

$(*(c+m))[n] \longleftrightarrow c[m][n]$

$c[m][0], c[m][1], \dots, c[m][N-1]$
are contiguous

a set of assignments of pointers
are necessary for this contiguity

Pointer Arrays vs Array Pointers

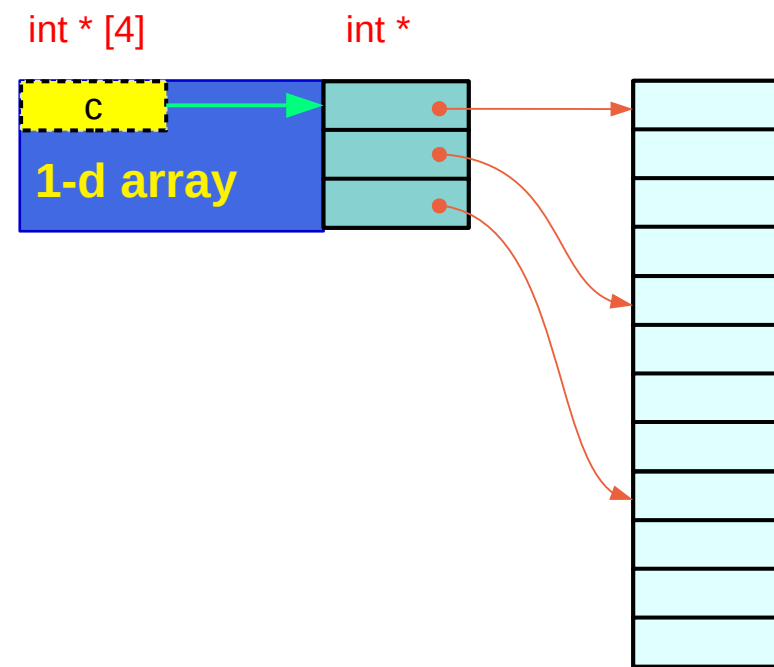
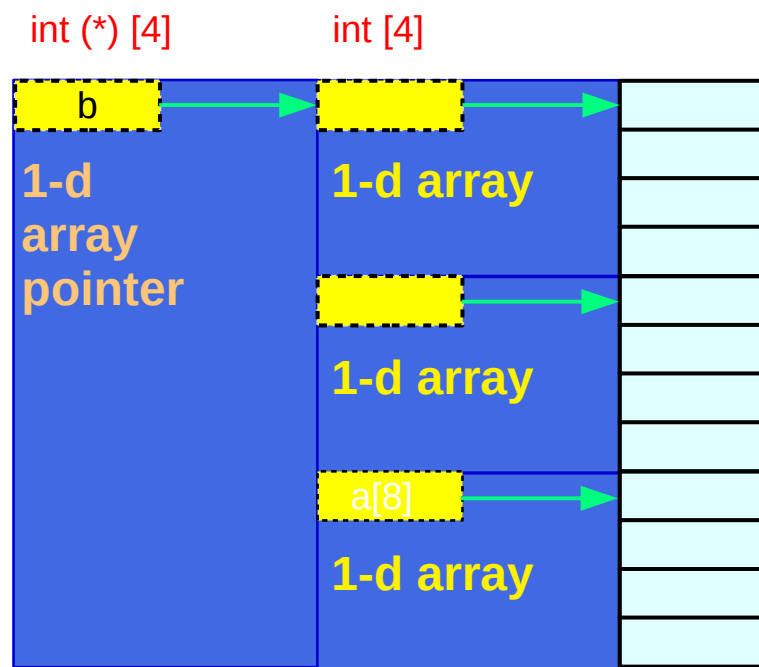

`int (*b)[N] ;`

`int * c[M] ;`

$(*(b+m))[n] \iff b[m][n]$
 $*(b[m]+n) \iff b[m][n]$

$*(c+m) \iff c[m] \text{ or}$
 $*(c+m)[n] \iff c[m][n]$

Contiguous linear layout

```
int c [L][M][N];
```

L	M	N
i	j	k
$i * M * N$	$j * N$	k

Base Index = 0

Offset Index 1 (i=1)

Offset Index 2 (j=1)

Offset Index 3 (k=1)

$$(i * M * N + j * N + k)$$

$$((i * M + j) * N + k)$$

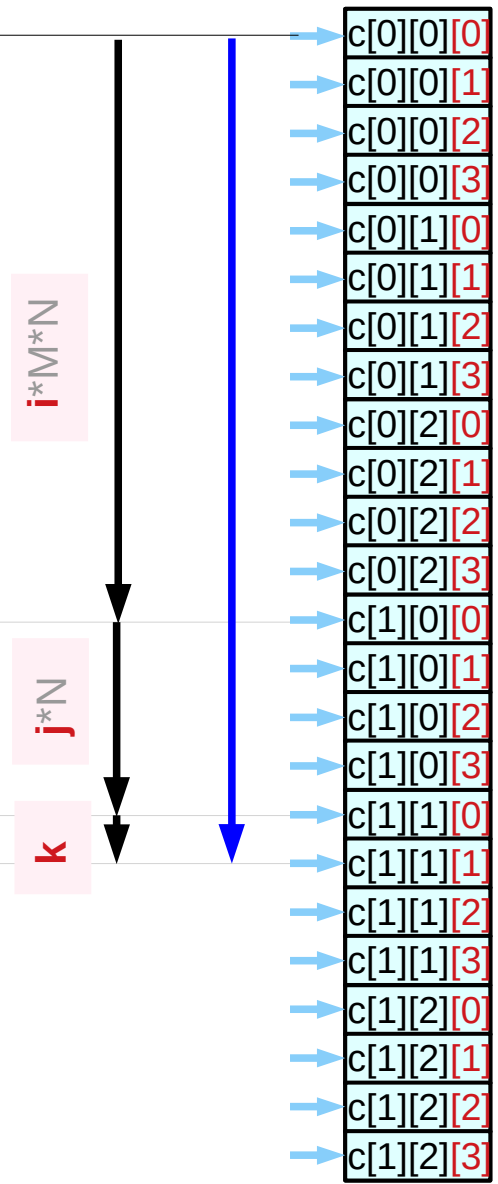

24=2*3*4

Base and Offset Addressing

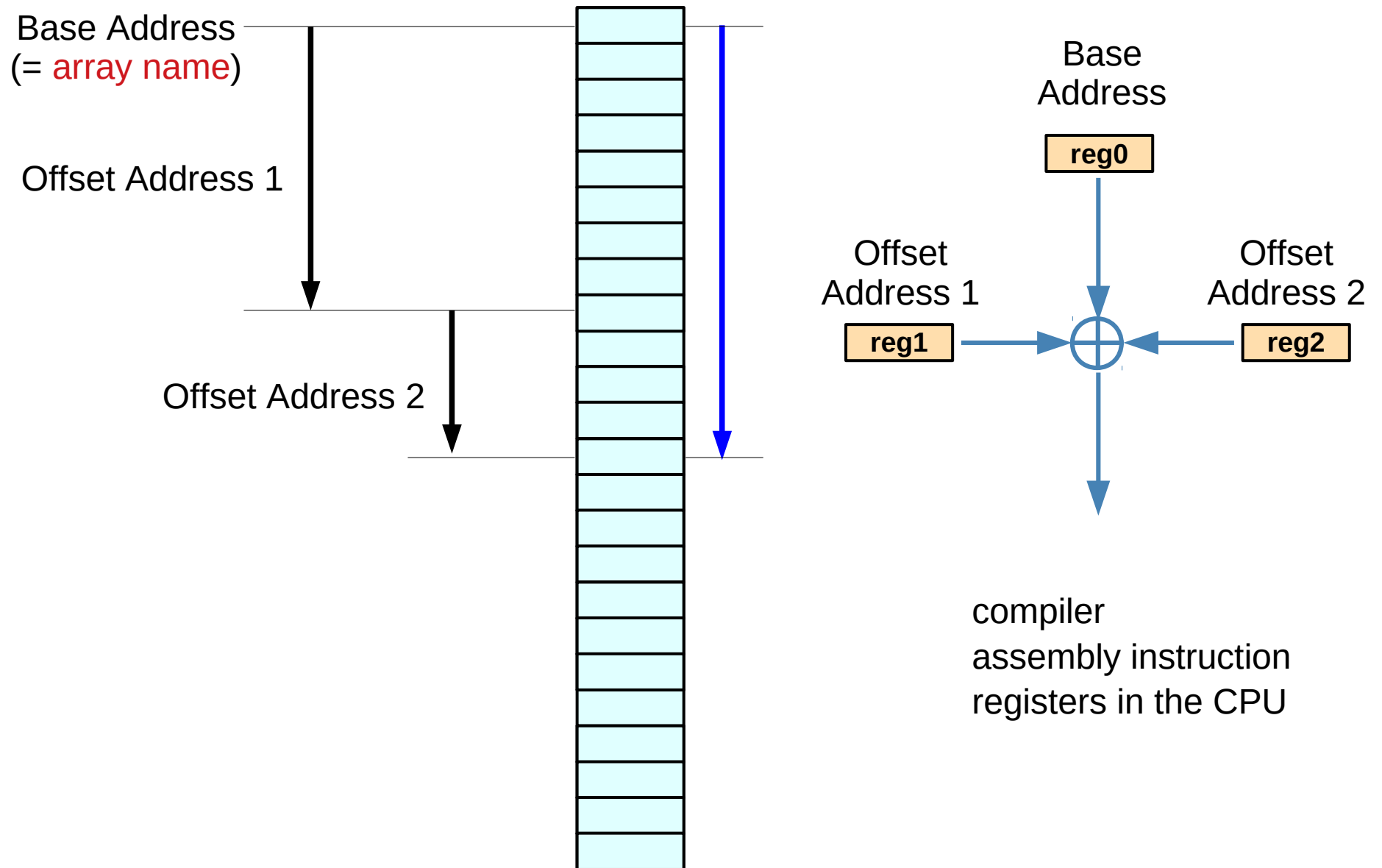

Array Pointer Approach

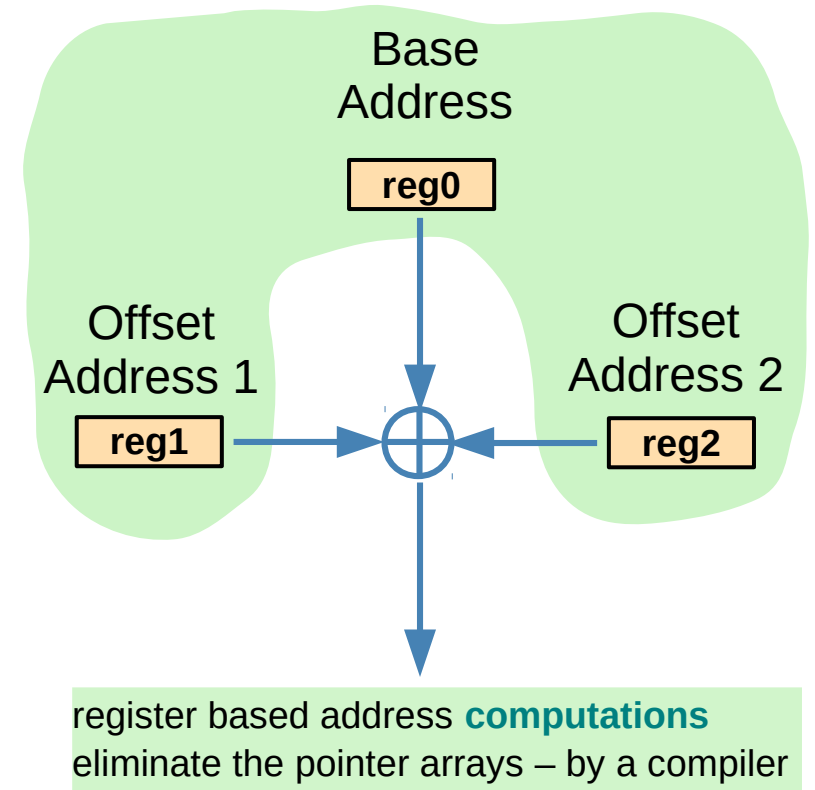
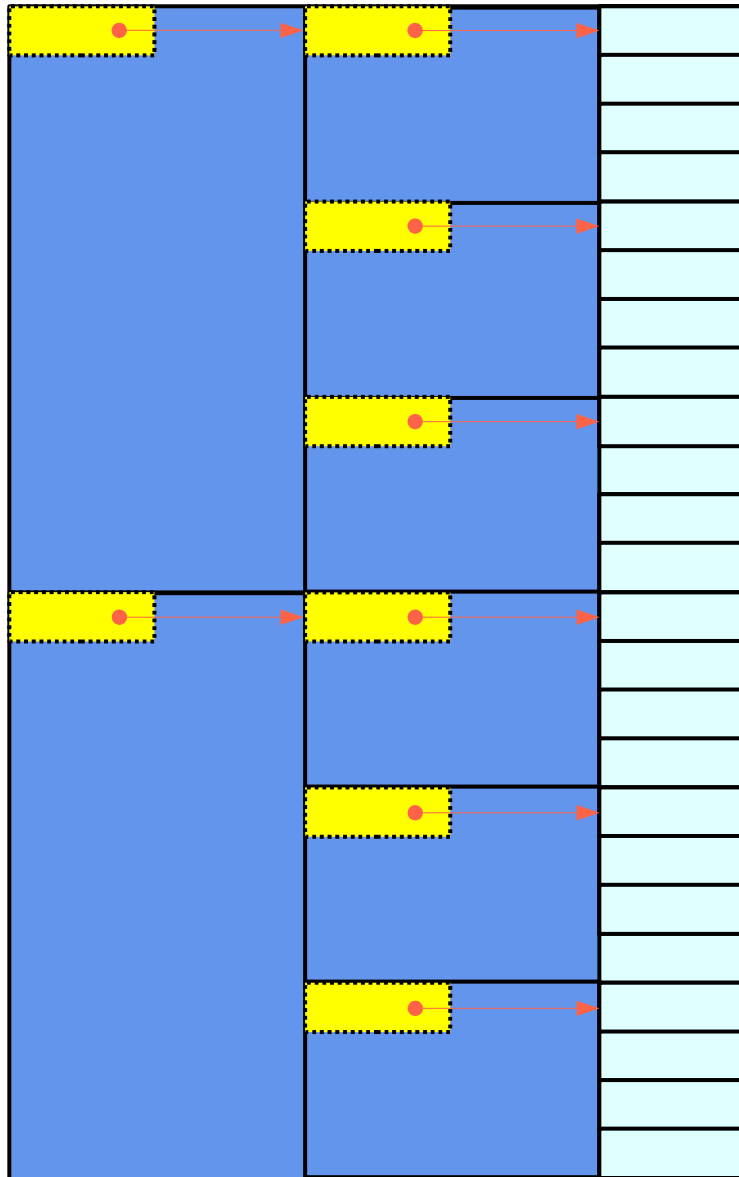

Array Pointer Approach
(pointer to arrays)

References

- [1] Essential C, Nick Parlante
- [2] Efficient C Programming, Mark A. Weiss
- [3] C A Reference Manual, Samuel P. Harbison & Guy L. Steele Jr.
- [4] C Language Express, I. K. Chun