

Laurent Series with z-Transform

20170522

Copyright (c) 2016 - 2017 Young W. Lim.

Permission is granted to copy, distribute and/or modify this document under the terms of the GNU Free Documentation License, Version 1.2 or any later version published by the Free Software Foundation; with no Invariant Sections, no Front-Cover Texts, and no Back-Cover Texts. A copy of the license is included in the section entitled "GNU Free Documentation License".

Series Expansion at $z=0$

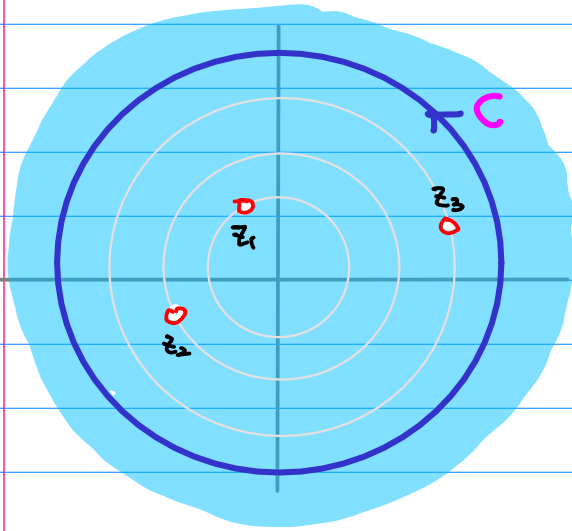

$$f(z) = \sum_{n=\eta_1}^{\infty} a_n^{(mf)} z^n$$

$$a_n^{(mf)} = \frac{1}{2\pi i} \oint_C \frac{f(z)}{z^{n+1}} dz$$
$$= \sum_k \text{Res} \left(\frac{f(z)}{z^{n+1}}, z_k \right)$$

Poles z_k

$$n \geq 0 \quad z_1, z_2, z_3, \circ$$

$$n < 0 \quad z_1, z_2, z_3$$

$a_n \quad (n \geq 0)$

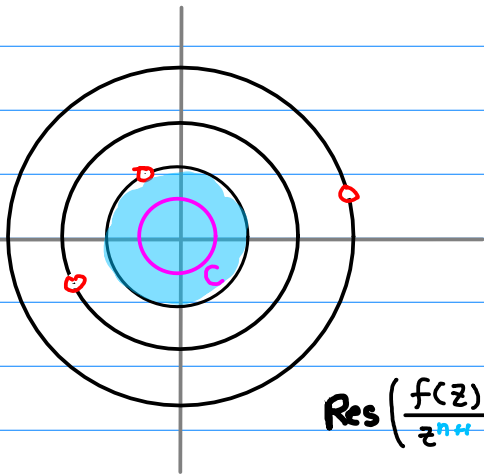

$$\text{Res} \left(\frac{f(z)}{z^{n+1}}, 0 \right)$$

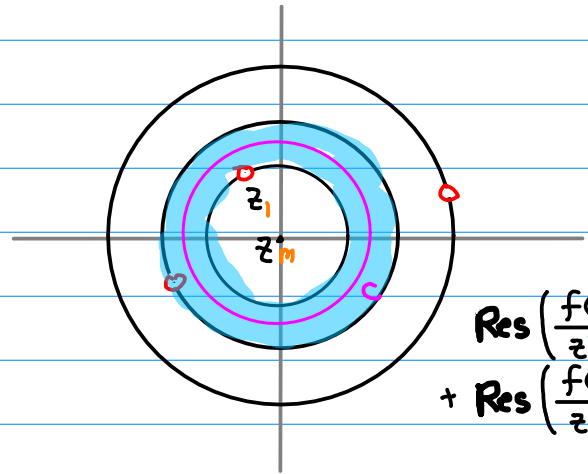

$$\text{Res} \left(\frac{f(z)}{z^{n+1}}, 0 \right) + \text{Res} \left(\frac{f(z)}{z^{n+1}}, z_1 \right)$$

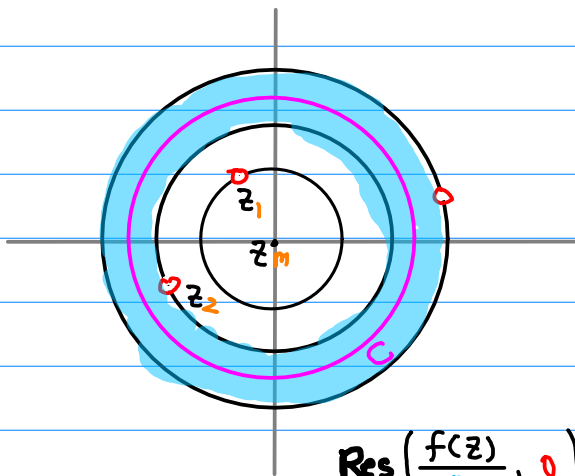

$$\begin{aligned} & \text{Res} \left(\frac{f(z)}{z^{n+1}}, 0 \right) \\ & + \text{Res} \left(\frac{f(z)}{z^{n+1}}, z_1 \right) \\ & + \text{Res} \left(\frac{f(z)}{z^{n+1}}, z_2 \right) \end{aligned}$$

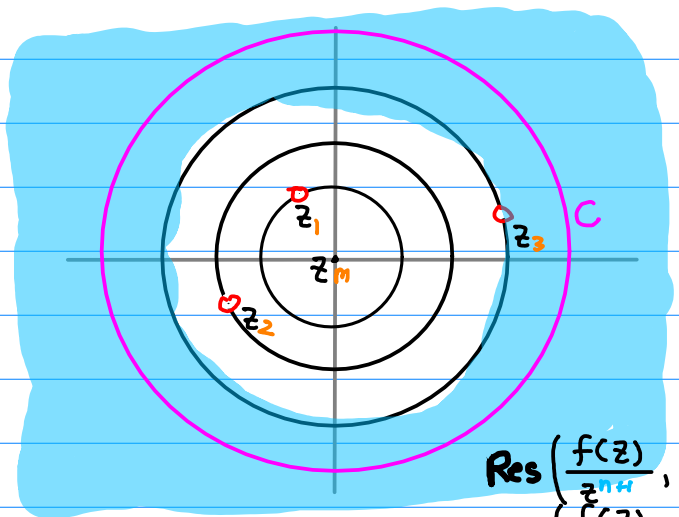

$$\begin{aligned} & \text{Res} \left(\frac{f(z)}{z^{n+1}}, 0 \right) \\ & + \text{Res} \left(\frac{f(z)}{z^{n+1}}, z_1 \right) \\ & + \text{Res} \left(\frac{f(z)}{z^{n+1}}, z_2 \right) \\ & + \text{Res} \left(\frac{f(z)}{z^{n+1}}, z_3 \right) \end{aligned}$$

$$a_n \quad (n \geq 0)$$

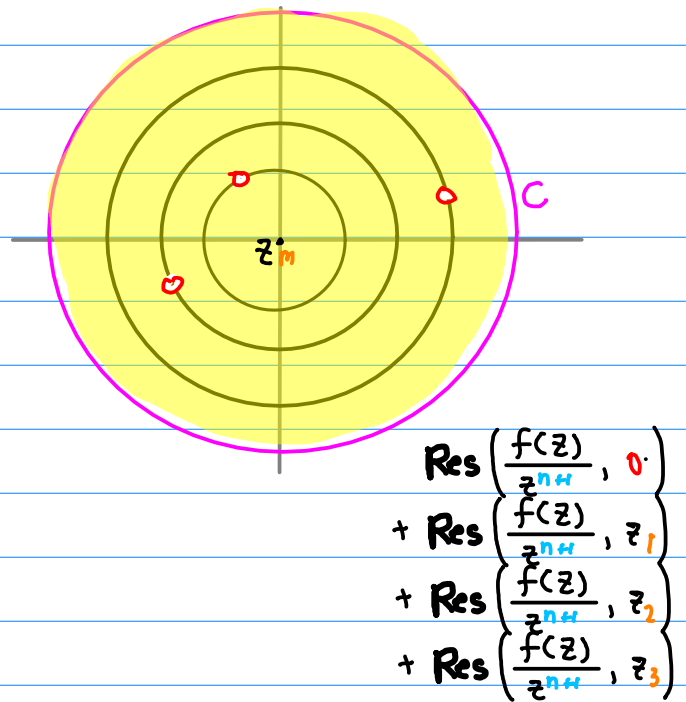
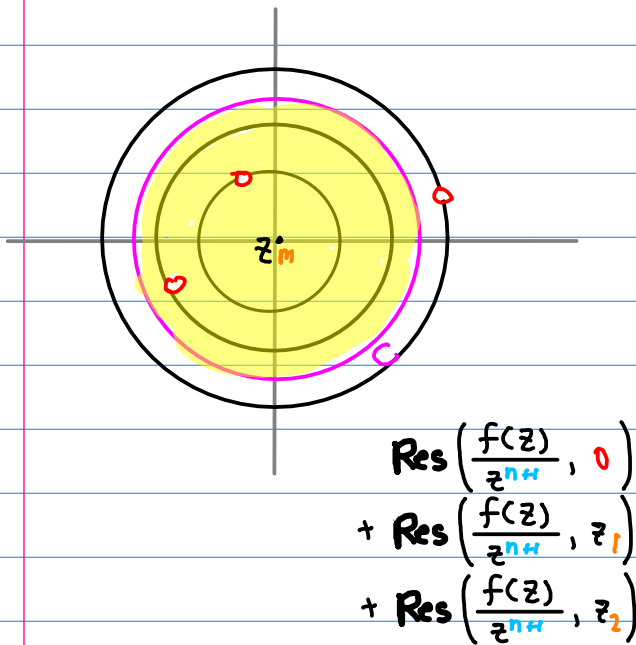
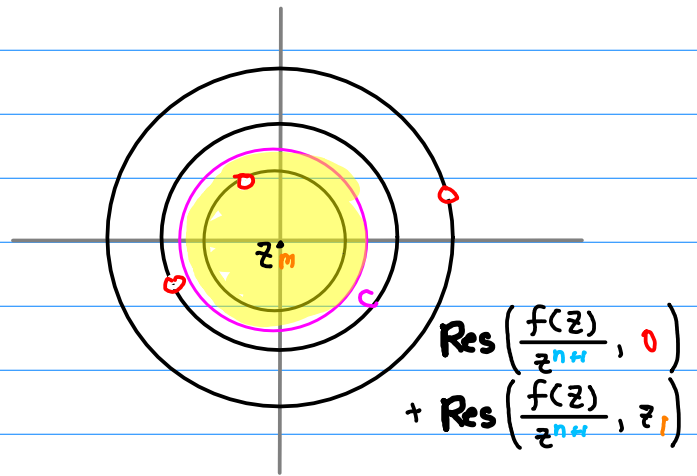
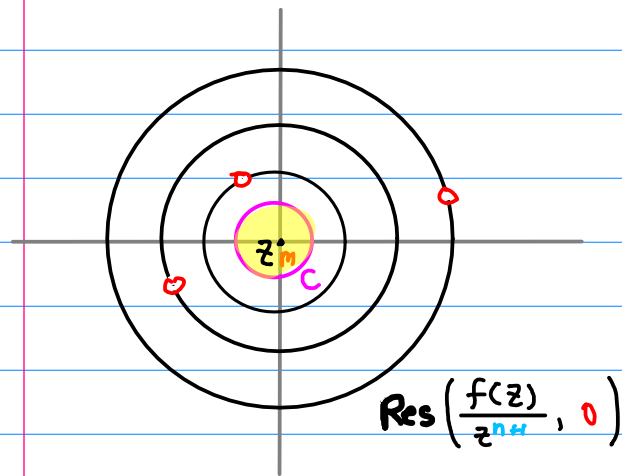

* General Series Expansion at $z=0$

$$f(z) = \sum_{n=n_1}^{\infty} a_n z^n$$

$$\begin{aligned} a_n &= \frac{1}{2\pi i} \oint_C \frac{f(z)}{z^{n+1}} dz \\ &= \sum_k \operatorname{Res}\left(\frac{f(z)}{z^{n+1}}, z_k\right) \end{aligned}$$

* z -transform

$$X(z) = \sum_{k=0}^{\infty} x_k z^{-k}$$

$$\begin{aligned} x_n &= \frac{1}{2\pi i} \oint_C X(z) z^{n+1} dz \\ &= \sum_k \operatorname{Res}(X(z) z^{n+1}, z_k) \end{aligned}$$

Inverse z-Transform $x[n] = \frac{1}{2\pi i} \int_C X(z) z^{n+1} dz$

$$X(z) = \sum_{k=0}^{\infty} x_k z^{-k}$$

$$z^{n+1} X(z) = \left(\sum_{k=0}^{\infty} x_k z^{-k} \right) z^{n+1}$$

$$\int z^{n+1} \text{LHS } dz = \int \text{RHS } z^{n+1} dz$$

$$= \sum_{k=0}^{\infty} x_k z^{-k+n+1}$$

$$[0, \infty) = [0, n+1] \cup [n+1, \infty)$$

$$= \sum_{k=0}^{n-1} x_k z^{-k+n+1} + \sum_{k=n}^n x_k z^{-k+n+1} + \sum_{k=n+1}^{\infty} x_k z^{-k+n+1}$$

$$= \sum_{k=0}^{n-1} x_k z^{-k+n+1} + \frac{x_n}{z^1} + \sum_{k=n+1}^{\infty} \frac{x_k}{z^{k-n+1}}$$

$$\begin{aligned} \int_C X(z) z^{n+1} dz &= \int_C \sum_{k=0}^{n-1} x_k z^{-k+n+1} dz + \int_C \frac{x_n}{z^1} dz + \int_C \sum_{k=n+1}^{\infty} \frac{x_k}{z^{k-n+1}} dz \\ &= \sum_{k=0}^{n-1} x_k \int_C z^{-k+n+1} dz + x_n \int_C \frac{1}{z^1} dz + \sum_{k=n+1}^{\infty} x_k \int_C \frac{1}{z^{k-n+1}} dz \\ &= \sum_{k=0}^{n-1} x_k \cdot 0 + x_n \cdot 2\pi i + \sum_{k=n+1}^{\infty} x_k \cdot 0 \end{aligned}$$

$$x[n] = \frac{1}{2\pi i} \int_C X(z) z^{n+1} dz$$

z -Transform $X(z)$
Laurent Series $f(z)$

z -Transform $X(z) \longleftrightarrow x_n$
Laurent Series $f(z) \longleftrightarrow a_n$

$$X(z) = f(z^{-1}) \longleftrightarrow x_n = a_n$$

z -Transform $X(z) \longleftrightarrow x_n$
Laurent Series $f(z) \longleftrightarrow a_n$

$$X(z) = f(z) \longleftrightarrow x_n = a_{-n}$$

$$X(z) = f(z^{-1}), \quad x_n = a_n$$

$$f(z) = \dots + a_2 z^{-2} + a_1 z^{-1} + a_0 z^0 + a_1 z^1 + a_2 z^2 + \dots$$

$$\left[\begin{aligned} f(z^{-1}) &= \dots + a_2 z^2 + a_1 z^1 + a_0 z^0 + a_1 z^{-1} + a_2 z^{-2} + \dots \\ X(z) &= \dots + x_{-2} z^{-2} + x_{-1} z^{-1} + x_0 z^0 + x_1 z^1 + x_2 z^2 + \dots \end{aligned} \right.$$

$$f(z^{-1}) = X(z) \quad \longleftrightarrow \quad a_n = x_n$$

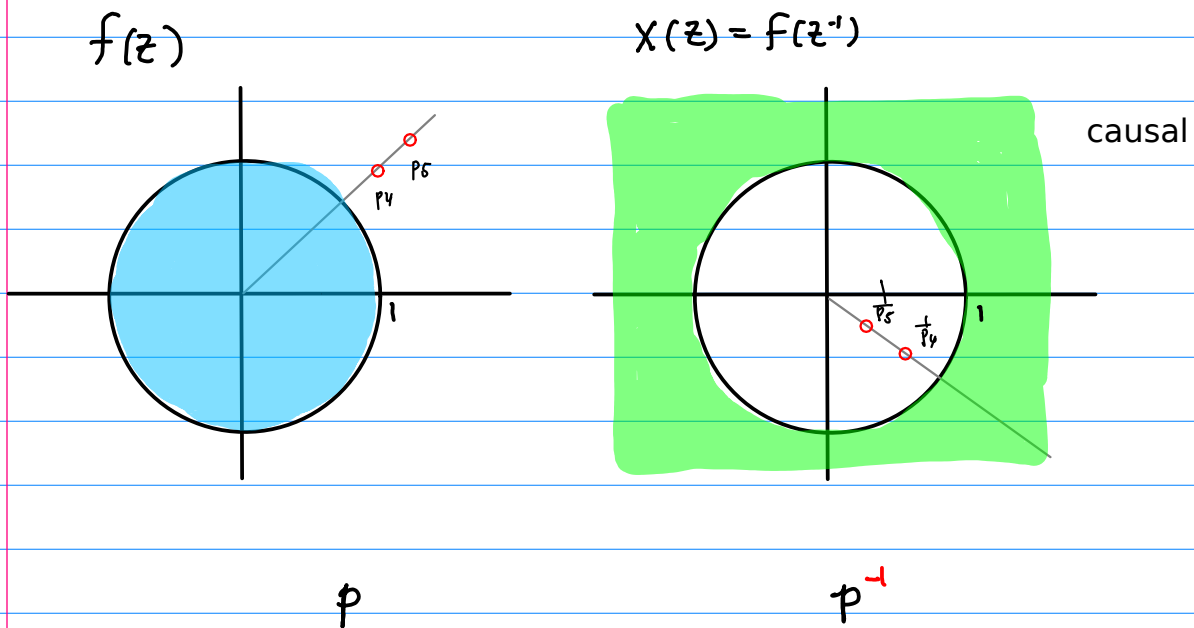

$$X(z) = f(z^{-1}), \quad x_n = a_n$$

$$f(z) = \dots + a_{-2}z^{-2} + a_{-1}z^{-1} + a_0z^0 + a_1z^1 + a_2z^2 + \dots$$

$$f(z^{-1}) = \dots + a_{-2}z^2 + a_{-1}z^1 + a_0z^0 + a_1z^{-1} + a_2z^{-2} + \dots$$

$$f(z^{-1}) = \dots + a_{-2}z^{-2} + a_{-1}z^{-1} + a_0z^0 + a_1z^1 + a_2z^2 + \dots$$

	...	z^{-2}	z^{-1}	z^0	z^1	z^2	...
$f(z)$...	a_{-2}	a_{-1}	a_0	a_1	a_2	...
$f(z^{-1})$...	a_2	a_1	a_0	a_{-1}	a_{-2}	...

$$X(z) = \dots + x_{-2}z^2 + x_{-1}z^1 + x_0z^0 + x_1z^{-1} + x_2z^{-2} + \dots$$

$$X(z) = \dots + x_{-2}z^{-2} + x_{-1}z^{-1} + x_0z^0 + x_1z^1 + x_2z^2 + \dots$$

	...	z^{-2}	z^{-1}	z^0	z^1	z^2	...
$X(z)$...	x_2	x_1	x_0	x_{-1}	x_{-2}	...

z-Transform

$$X(z) \longleftrightarrow x_n$$

Laurent Series

$$f(z) \longleftrightarrow a_n$$

$$X(z) = f(z^{-1}) \longleftrightarrow x_n = a_n$$

$$X(z) = f(z^{-1}), \quad x_n = a_n$$

$$a_n \longleftrightarrow f(z)$$

$$x_n \longleftrightarrow X(z)$$

$$a'_n \longleftrightarrow f(z^{-1}) = f(w)$$

$$a_n = \frac{1}{2\pi i} \oint_C \frac{f(z)}{z^{n+1}} dz$$

$$= \sum_k \text{Res}\left(\frac{f(z)}{z^{n+1}}, z_k\right)$$

$$a'_n = \frac{1}{2\pi i} \oint_{C'} \frac{f(z^{-1})}{z^{n+1}} dz$$

$$= \frac{1}{2\pi i} \oint_{C'} f(z^{-1}) z^{-n-1} dz$$

$$w = z^{-1}$$

$$dw = -z^{-2} dz$$

$$= \frac{-1}{2\pi i} \oint_{C'} f(z^{-1}) z^{-n-1} z^2 dz$$

$$= \frac{1}{2\pi i} \oint_C f(w) w^{n-1} dw$$

$$= \sum_k \text{Res}(f(w) w^{n-1}, w_k)$$

$$a_n = \sum_k \text{Res}\left(\frac{f(z)}{z^{n+1}}, z_k\right)$$

$$x_n = \sum_k \text{Res}(X(z) z^{n-1}, z_k)$$

$f(z)$

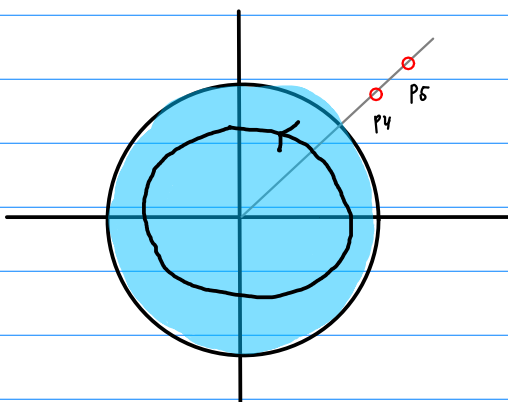

$X(z) = f(z^{-1})$

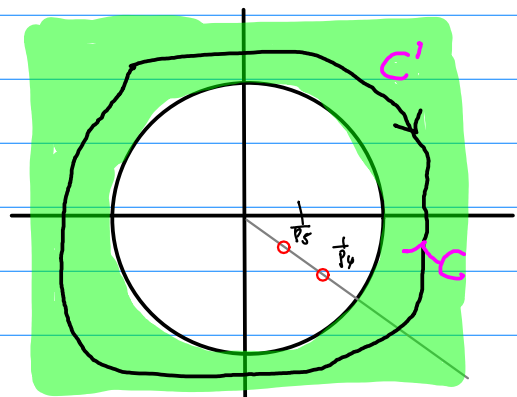

causal

$$X(z) = f(z), \quad x_n = a_{-n}$$

$$\begin{aligned} X(z) &= \dots + x_2 z^2 + x_1 z^1 + x_0 z^0 + x_{-1} z^{-1} + x_{-2} z^{-2} + \dots \\ &= \dots + x_2 z^{-2} + x_1 z^{-1} + x_0 z^0 + x_{-1} z^1 + x_{-2} z^2 + \dots \\ f(z) &= \dots + a_{-2} z^{-2} + a_{-1} z^{-1} + a_0 z^0 + a_1 z^1 + a_2 z^2 + \dots \end{aligned}$$

$$f(z) = X(z) \iff a_{-n} = x_n$$

$$X(z) = f(z), \quad x_n = a_{-n}$$

$$f(z) = \dots + a_{-2}z^{-2} + a_{-1}z^{-1} + a_0z^0 + a_1z^1 + a_2z^2 + \dots$$

$$f(z) \quad \begin{array}{cccccc} \dots & z^{-2} & z^{-1} & z^0 & z^1 & z^2 & \dots \\ \dots & a_{-2} & a_{-1} & a_0 & a_1 & a_2 & \dots \end{array}$$

$$X(z) = \dots + x_{-2}z^{-2} + x_{-1}z^{-1} + x_0z^0 + x_1z^1 + x_2z^2 + \dots$$

$$X(z) = \dots x_{-2}z^{-2} + x_{-1}z^{-1} + x_0z^0 + x_1z^1 + x_2z^2 + \dots$$

$$X(z) \quad \begin{array}{cccccc} \dots & z^{-2} & z^{-1} & z^0 & z^1 & z^2 & \dots \\ \dots & x_{-2} & x_{-1} & x_0 & x_1 & x_2 & \dots \end{array}$$

$$X(z) \quad \begin{array}{cccccc} \dots & x_{-2} & x_{-1} & x_0 & x_1 & x_2 & \dots \end{array}$$

z-Transform

$$X(z) \longleftrightarrow x_n$$

Laurent Series

$$f(z) \longleftrightarrow a_n$$

$$X(z) = f(z) \longleftrightarrow x_n = a_{-n}$$

$$X(z) = f(z), \quad x_n = a_{-n}$$

$$f(z) = X(z) \quad \longleftrightarrow \quad a_{-n} = x_n$$

$$a_n = \frac{1}{2\pi i} \oint_C \frac{X(z)}{z^{n+1}} dz = \sum_k \operatorname{Res}\left(\frac{X(z)}{z^{n+1}}, z_k\right)$$

$$x_n = a_{-n} = \frac{1}{2\pi i} \oint_C \frac{X(z)}{z^{-n+1}} dz = \sum_k \operatorname{Res}\left(\frac{X(z)}{z^{-n+1}}, z_k\right)$$

$$x_n = \frac{1}{2\pi i} \oint_C X(z) z^{n-1} dz = \sum_k \operatorname{Res}(X(z) z^{n-1}, z_k)$$

Mapping $w = \frac{1}{z}$

$$z = \rho e^{j\theta}$$

$$z^{-1} = \frac{1}{\rho} e^{-j\theta}$$

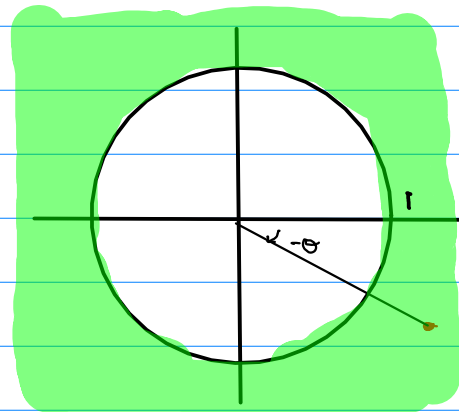
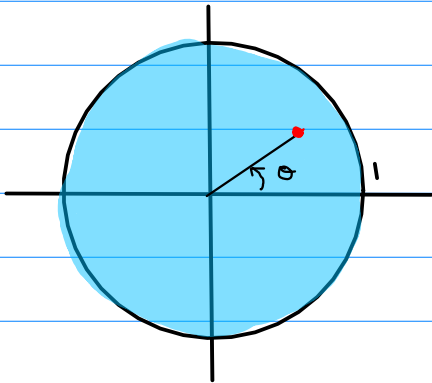
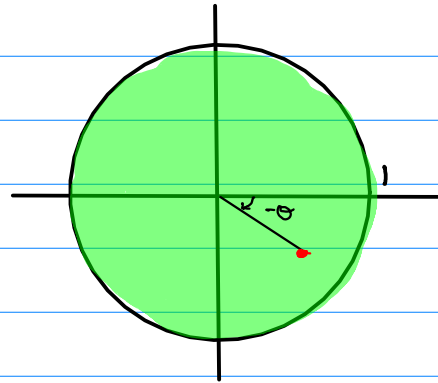
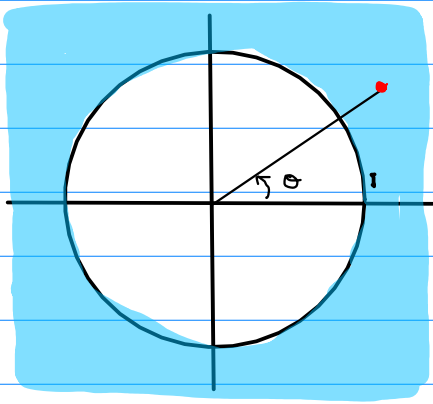

$$f(z) = \frac{(z - z_1)(z - z_2)}{(z - p_1)(z - p_2)(z - p_3)}$$

$$f(z^{-1}) = \frac{(\frac{1}{z} - z_1)(\frac{1}{z} - z_2)}{(\frac{1}{z} - p_1)(\frac{1}{z} - p_2)(\frac{1}{z} - p_3)}$$

$$= \frac{(1 - z_1 z)(1 - z_2 z)}{(1 - p_1 z)(1 - p_2 z)(1 - p_3 z)}$$

$$\frac{1}{z_1}, \frac{1}{z_2}$$

$$\frac{1}{p_1}, \frac{1}{p_2}, \frac{1}{p_3}$$

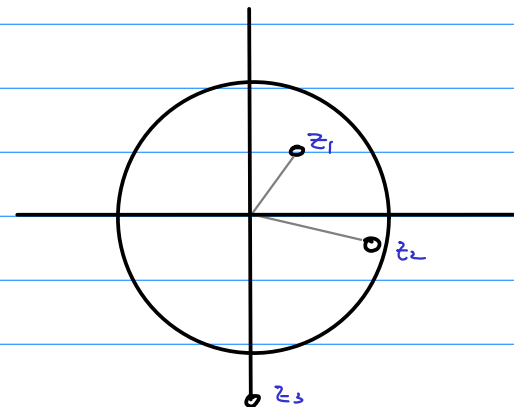
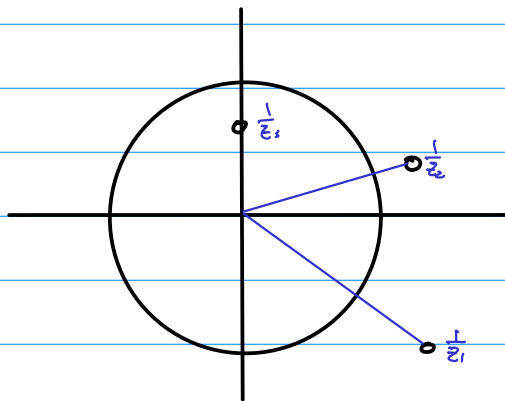
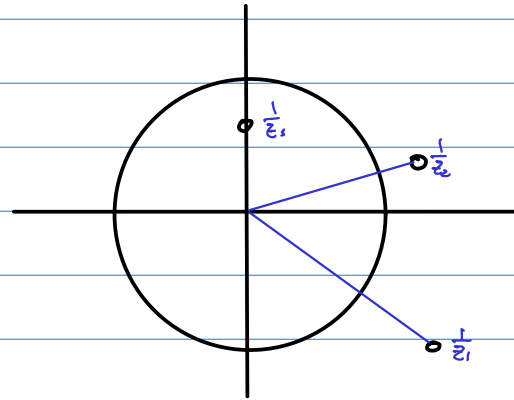
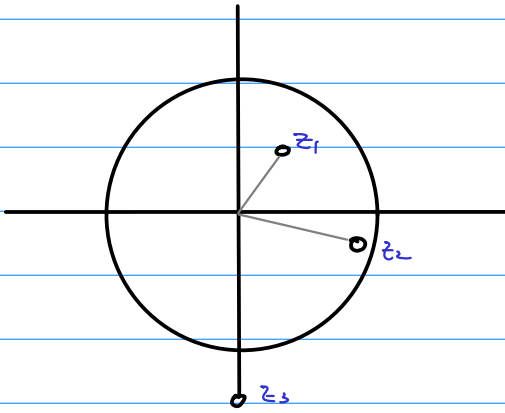

$$g(z) = \frac{1}{1-bz} = \frac{b^{-1}}{b^{-1}-z} \quad |bz| < 1 \quad \text{●} \quad |z| < \frac{1}{b}$$

$$h(z) = \frac{1}{1-\frac{b}{z}} = \frac{z}{z-b} \quad \left|\frac{b}{z}\right| < 1 \quad \text{○} \quad |z| > b$$

$$g(z^{-1}) = \frac{b^{-1}}{b^{-1}-z^{-1}} = \frac{z}{z-b}$$

$$h(z^{-1}) = \frac{z^{-1}}{z^{-1}-b} = \frac{b^{-1}}{b^{-1}-z}$$

$$\frac{b^{-1}}{b^{-1}-z} \Rightarrow b^{-1}-z > 0 \quad |z| < b^{-1}$$

$$\frac{z}{z-b} \Rightarrow z-b > 0 \quad |z| > b$$

$$\begin{aligned}
 a_n &= \left(\frac{1}{2}\right)^n \quad (n \geq 0) \\
 &= p^{-n} \quad (n \geq 0) \quad p=2 \\
 f(z) &= \frac{2}{2-z}
 \end{aligned}$$

$$\begin{aligned}
 x_n &= \left(\frac{1}{2}\right)^n \quad (n \geq 0) \\
 &= p^n \quad (n \geq 0) \quad p=\frac{1}{2} \\
 X(z) &= \frac{z}{z-0.5}
 \end{aligned}$$

$$\begin{aligned}
 a_n &= \left(\frac{1}{2}\right)^{-n} \quad (n \leq 0) \\
 &= p^{-n} \quad (n \leq 0) \quad p=\frac{1}{2} \\
 f(z) &= \frac{z}{z-0.5}
 \end{aligned}$$

$$\begin{aligned}
 x_n &= \left(\frac{1}{2}\right)^{-n} \quad (n \leq 0) \\
 &= p^n \quad (n \leq 0) \quad p=2 \\
 X(z) &= \frac{2}{2-z}
 \end{aligned}$$

$$\begin{aligned}
 a_n &= b^n \quad (n \geq 0) \\
 &= p^{-n} \quad (n \geq 0) \quad p=b^{-1} \\
 f(z) &= \frac{b^{-1}}{b^{-1}-z}
 \end{aligned}$$

$$\begin{aligned}
 x_n &= b^n \quad (n \geq 0) \\
 &= p^n \quad (n \geq 0) \quad p=b \\
 X(z) &= \frac{z}{z-b}
 \end{aligned}$$

$$\begin{aligned}
 a_n &= b^{-n} \quad (n \leq 0) \\
 &= p^{-n} \quad (n \leq 0) \quad p=b \\
 f(z) &= \frac{z}{z-b}
 \end{aligned}$$

$$\begin{aligned}
 x_n &= b^{-n} \quad (n \leq 0) \\
 &= p^n \quad (n \leq 0) \quad p=b^{-1} \\
 X(z) &= \frac{b^{-1}}{b^{-1}-z}
 \end{aligned}$$

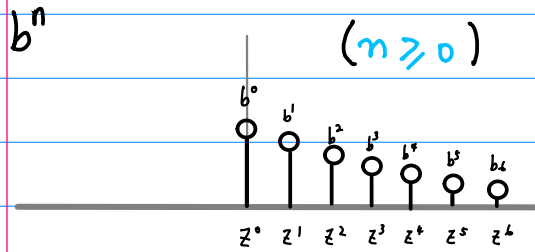

$$X(z^{-1}) = \frac{z^{-1}}{z^{-1} - 0.5} \quad |z| < 2$$

$$f(z) = \frac{z}{2-z} = \sum_{n=0}^{\infty} \left(\frac{1}{2}\right)^n z^n$$

$$a_n = \left(\frac{1}{2}\right)^n = p^{-n} \quad \boxed{p=2}$$

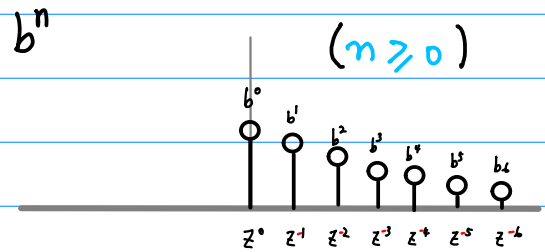

$$X(z) = \frac{z}{z - 0.5} = \sum_{n=0}^{\infty} \left(\frac{1}{2}\right)^n z^{-n} \quad |z| > \frac{1}{2}$$

$$x_n = \left(\frac{1}{2}\right)^n = p^n \quad \boxed{p=\frac{1}{2}}$$

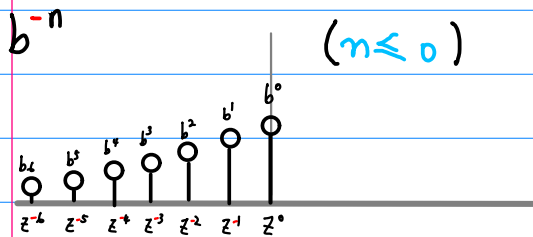

$$X(z^{-1}) = \frac{2}{2 - z^{-1}} \quad |z| > \frac{1}{2}$$

$$f(z) = \frac{z}{z - 0.5} = \sum_{n=-\infty}^0 \left(\frac{1}{2}\right)^{-n} z^n = \sum_{n=0}^{\infty} \left(\frac{1}{2}\right)^n z^{-n}$$

$$a_n = \left(\frac{1}{2}\right)^{-n} = p^{-n} \quad \boxed{p=\frac{1}{2}}$$

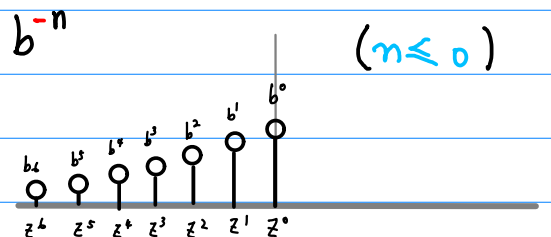

$$X(z) = \frac{2}{2 - z} = \sum_{n=-\infty}^0 \left(\frac{1}{2}\right)^{-n} z^{-n} = \sum_{n=0}^{\infty} \left(\frac{1}{2}\right)^n z^n \quad |z| < 2$$

$$x_n = \left(\frac{1}{2}\right)^{-n} = p^n \quad \boxed{p=2}$$

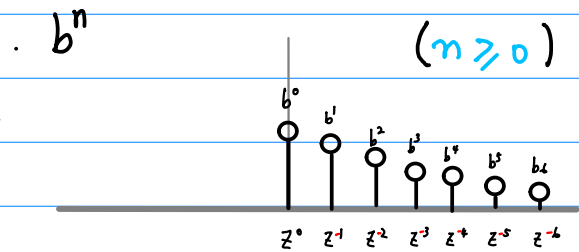
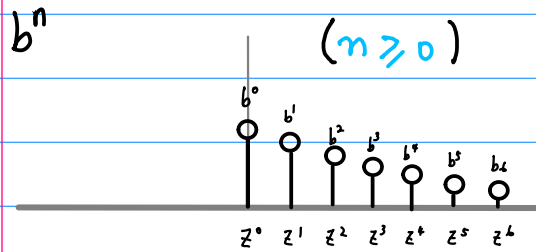

$$X(z^{-1}) = \frac{z^{-1}}{z^{-1} - b} \quad |z| < b^{-1}$$

$$|z| > b$$

$$f(z) = \frac{b^{-1}}{b^{-1} - z} = \sum_{n=0}^{\infty} b^n z^n$$

$$X(z) = \frac{z}{z - b} = \sum_{n=0}^{\infty} b^n z^{-n}$$

$$a_n = b^n$$

$$= p^{-n} \quad \boxed{p = b^{-1}}$$

$$x_n = b^n$$

$$= p^n \quad \boxed{p = b}$$

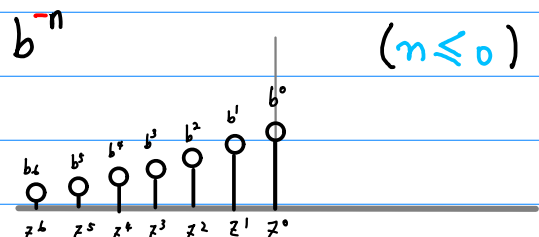
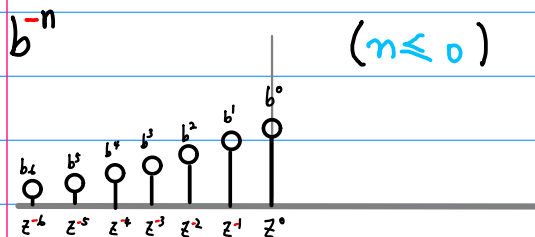

$$X(z^{-1}) = \frac{b^{-1}}{b^{-1} - z^{-1}} \quad |z| > b$$

$$|z| < b^{-1}$$

$$f(z) = \frac{z}{z - b} = \sum_{n=-\infty}^0 b^{-n} z^n$$

$$= \sum_{n=0}^{\infty} b^n z^{-n}$$

$$X(z) = \frac{b^{-1}}{b^{-1} - z} = \sum_{n=-\infty}^0 b^{-n} z^{-n}$$

$$= \sum_{n=0}^{\infty} b^n z^n$$

$$a_n = b^{-n}$$

$$= p^{-n} \quad \boxed{p = b}$$

$$x_n = b^{-n}$$

$$= p^n \quad \boxed{p = b^{-1}}$$

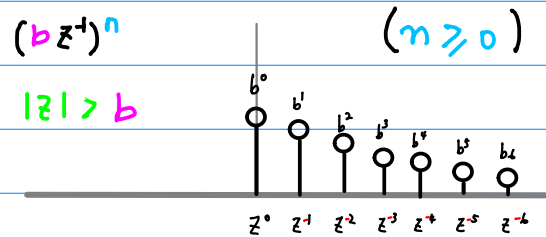
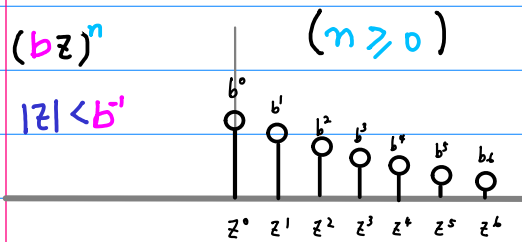

$$f(z) = \frac{1}{1-bz} = \frac{b^{-1}}{b^{-1}-z}$$

$$X(z) = \frac{1}{1-b/z} = \frac{z}{z-b}$$

$$a_n = b^n$$

$$= p^{-n} \quad \boxed{p = b^{-1}}$$

$$x_n = b^n$$

$$= p^n \quad \boxed{p = b}$$

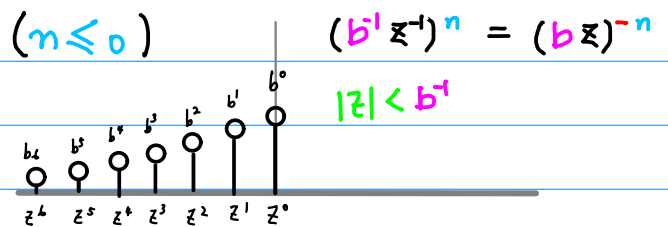
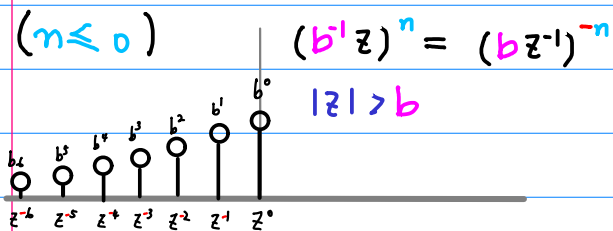

$$f(z) = \frac{1}{1-(bz^{-1})} = \frac{z}{z-b}$$

$$X(z) = \frac{1}{1-(bz)} = \frac{b^{-1}}{b^{-1}-z}$$

$$a_n = b^{-n}$$

$$= p^{-n} \quad \boxed{p = b}$$

$$x_n = b^{-n}$$

$$= p^n \quad \boxed{p = b^{-1}}$$

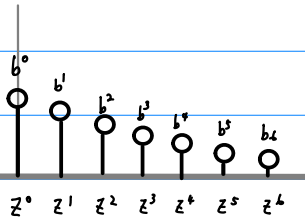

$$f(z) = \sum_{n=0}^{\infty} (bz)^n \quad |bz| < 1$$

$$a_n = b^n \\ = p^{-n} \quad \boxed{p = b^{-1}}$$

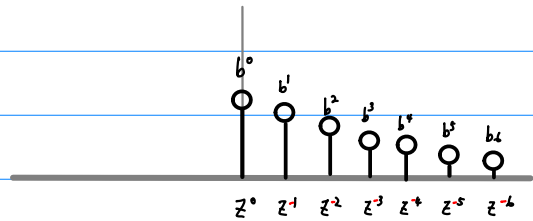

$$X(z) = \sum_{n=0}^{\infty} (bz^{-1})^n \quad |bz^{-1}| < 1$$

$$x_n = b^n \\ = p^n \quad \boxed{p = b}$$

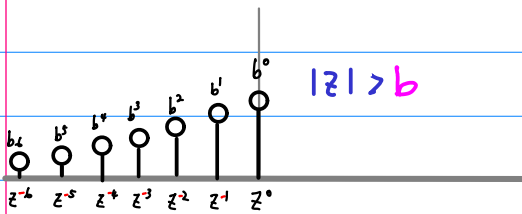

$$f(z) = \sum_{n=-\infty}^0 (bz^{-1})^{-n} \quad |bz^{-1}| < 1 \\ = \sum_{n=0}^{\infty} (bz^{-1})^n$$

$$a_n = b^{-n} \\ = p^{-n} \quad \boxed{p = b}$$

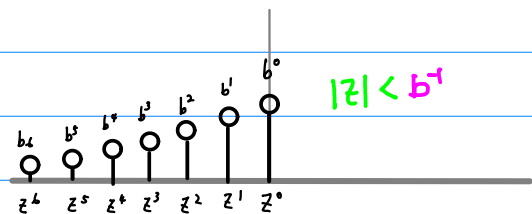

$$X(z) = \sum_{n=-\infty}^0 (bz)^{-n} \quad |bz| < 1 \\ = \sum_{n=0}^{\infty} (bz)^n$$

$$x_n = b^{-n} \\ = p^n \quad \boxed{p = b^{-1}}$$

$$\frac{1}{1 - (bz)} = \frac{b^{-1}}{z - b^{-1}}$$

$$\frac{1}{1 - (bz^{-1})} = \frac{z}{z - b}$$

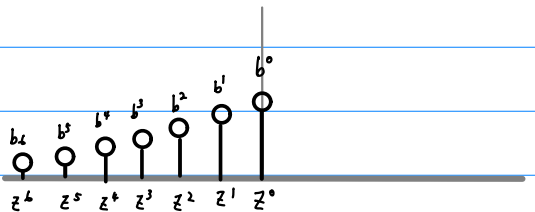
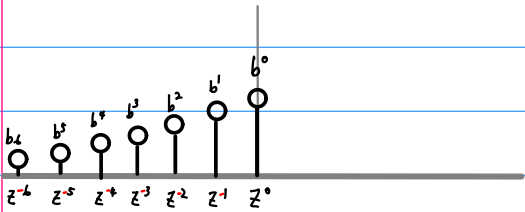
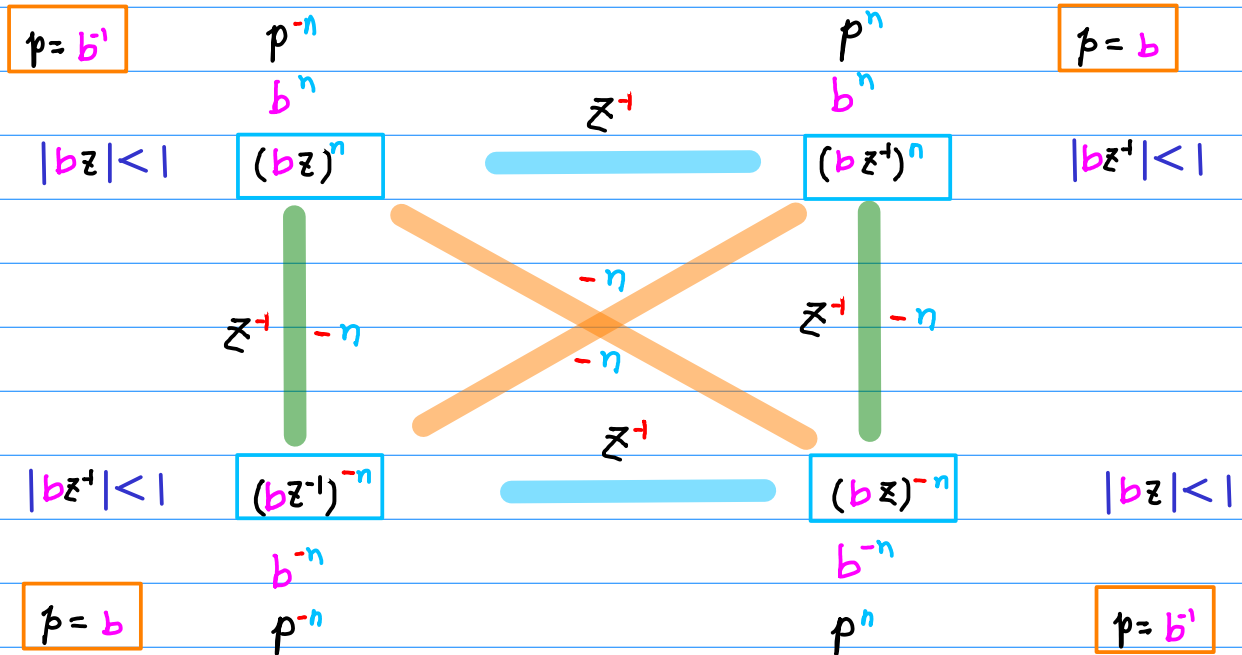
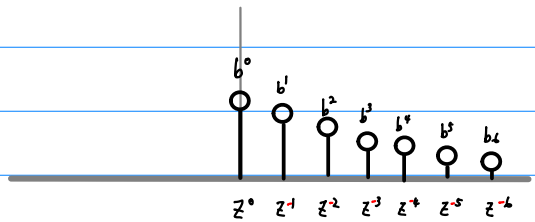
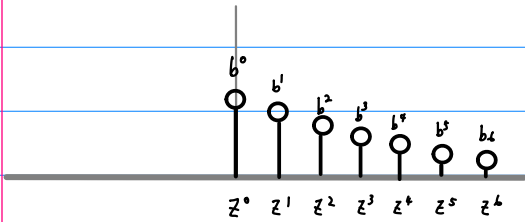

$$\frac{1}{1 - (bz^{-1})} = \frac{z}{z - b}$$

$$\frac{1}{1 - (bz)} = \frac{b^{-1}}{z - b^{-1}}$$

$$\frac{1}{1 - (bz)} = \frac{b^{-1}}{b^{-1} - z}$$

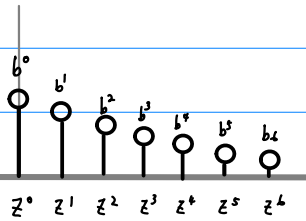

$$\frac{1}{1 - (bz^{-1})} = \frac{z}{z - b}$$

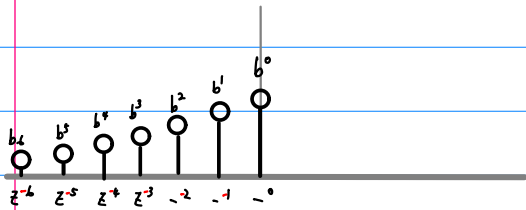
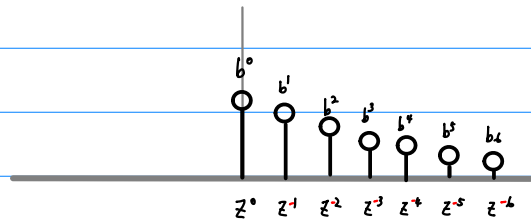

$$\frac{1}{1 - (bz^{-1})} = \frac{z}{z - b}$$

$$\frac{1}{1 - (bz)} = \frac{b^{-1}}{b^{-1} - z}$$

$$x_n = a_{-n} \quad X(z) = f(z)$$

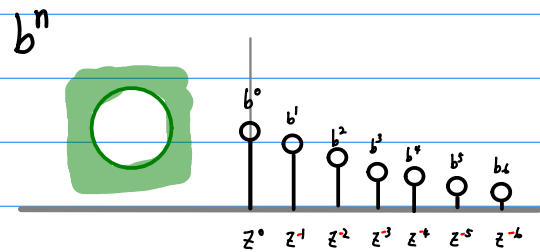
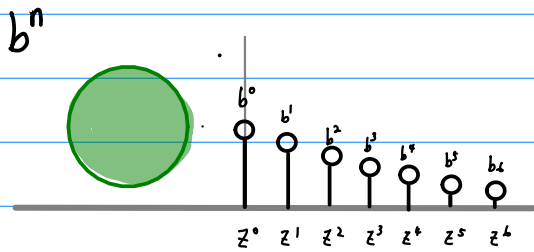

$$f(z) = \frac{1}{1-(bz)} \quad |z| < b$$

$$X(z) = \frac{1}{1-(b/z)} \quad |z| > b$$

$$a_n = b^n \quad (n \geq 0)$$

$$= p^{-n} \quad (p=b^{-1})$$

$$x_n = b^n \quad (n \geq 0)$$

$$= p^n \quad (p=b)$$

$$f(z) = \frac{1}{1-(b/z)} \quad |z| > b$$

$$X(z) = \frac{1}{1-(bz)} \quad |z| < b$$

$$a_n = b^{-n} \quad (n \leq 0)$$

$$= p^{-n} \quad (p=b)$$

$$x_n = b^{-n} \quad (n \leq 0)$$

$$= p^n \quad (p=b^{-1})$$

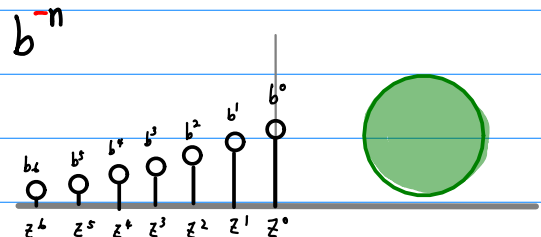
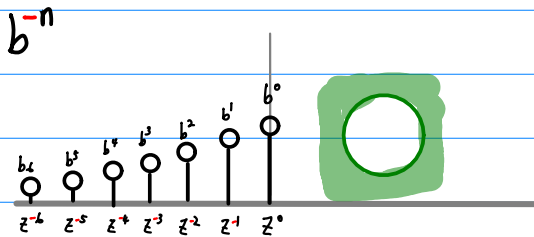

$$x_n = a_n \quad X(z) = f(z^{-1})$$

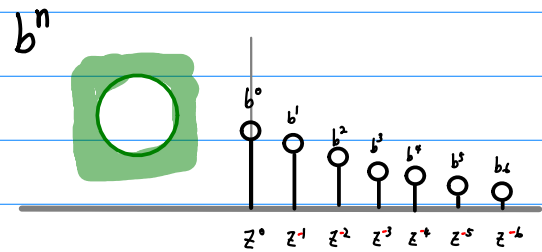
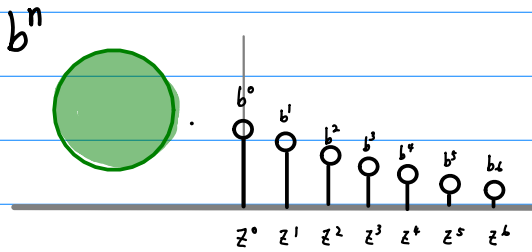

$$f(z) = \frac{1}{1-(bz)} \quad |z| < b$$

$$X(z) = \frac{1}{1-(b/z)} \quad |z| > b$$

$$a_n = b^n \quad (n \geq 0)$$

$$x_n = b^n \quad (n \geq 0)$$

$$f(z) = \frac{1}{1-(b/z)} \quad |z| > b$$

$$X(z) = \frac{1}{1-(bz)} \quad |z| < b$$

$$a_n = b^{-n} \quad (n \leq 0)$$

$$x_n = b^{-n} \quad (n \leq 0)$$

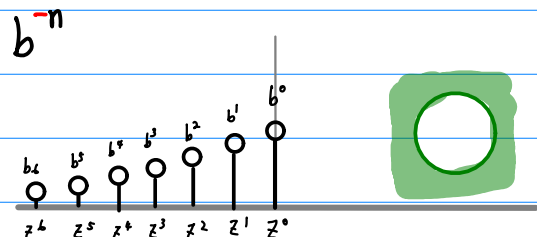
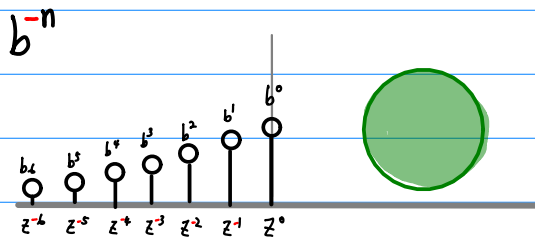

$$a_n = p^n$$

$$x_n = p^{-n}$$

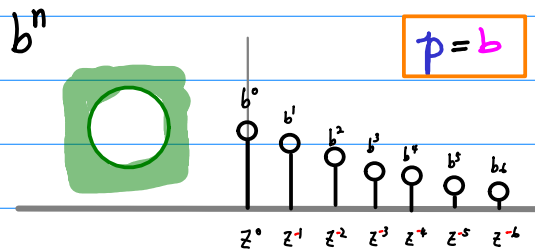
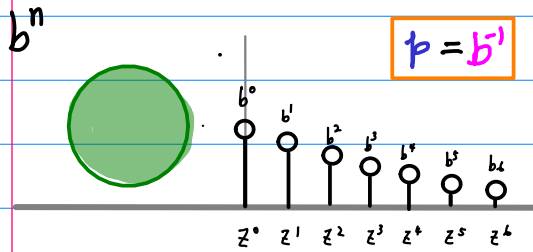

$$f(z) = \frac{1}{1 - (b/z)} \quad |z| < b^{-1}$$

$$X(z) = \frac{1}{1 - (b/z)} \quad |z| > b$$

$$a_n = p^{-n} \quad (n \geq 0)$$

$$x_n = p^n \quad (n \geq 0)$$

$$f(z) = \frac{1}{1 - (b/z)} \quad |z| > b$$

$$X(z) = \frac{1}{1 - (b/z)} \quad |z| < b^{-1}$$

$$a_n = p^{-n} \quad (n \leq 0)$$

$$x_n = p^n \quad (n \leq 0)$$

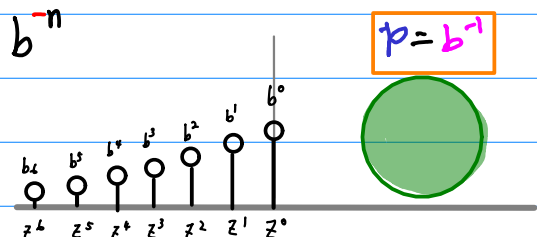
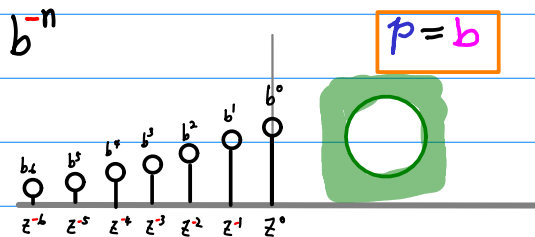

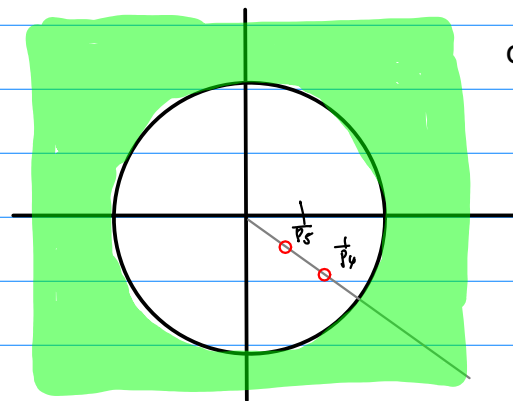
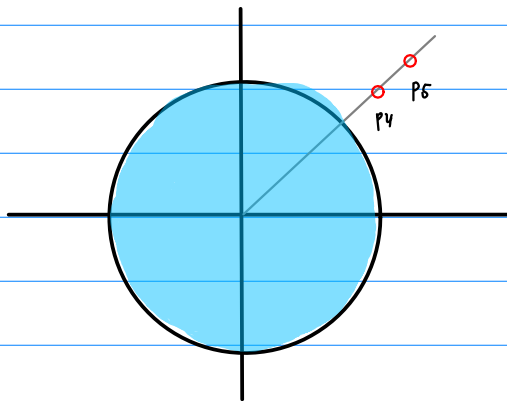
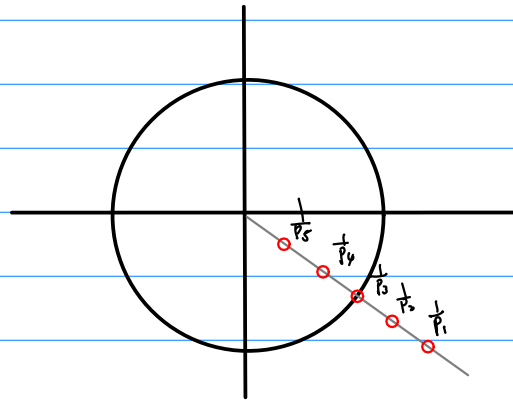
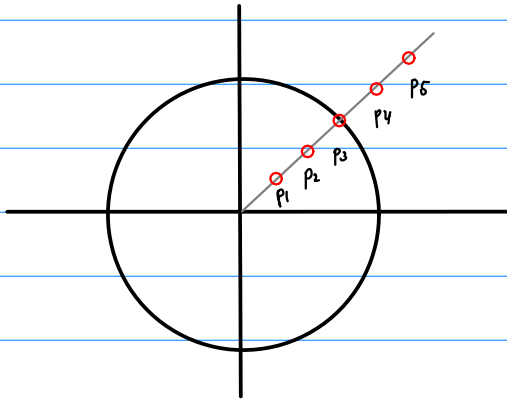

causal

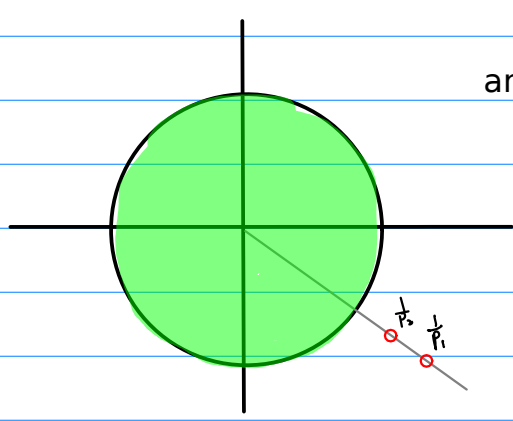
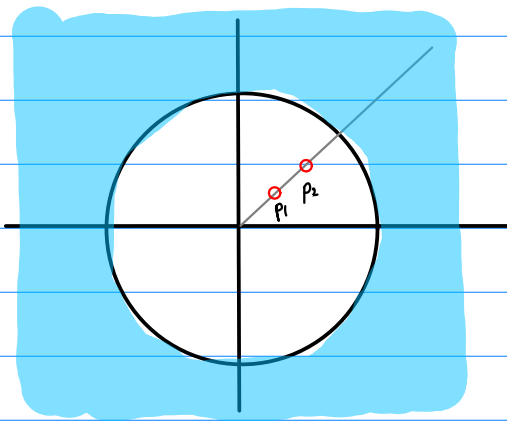

anticausal

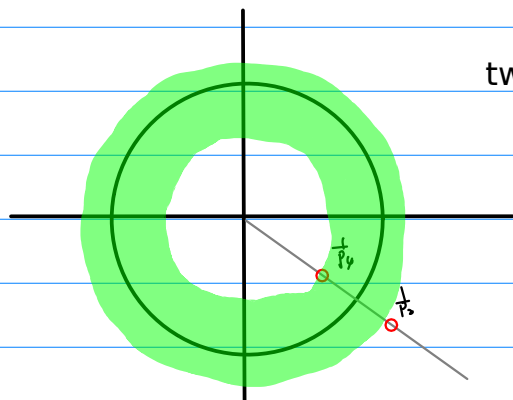
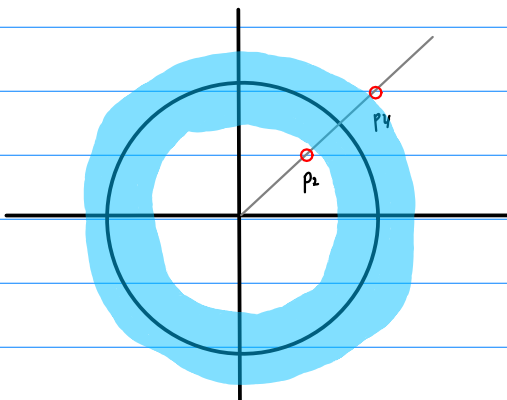

two-sided

Causal

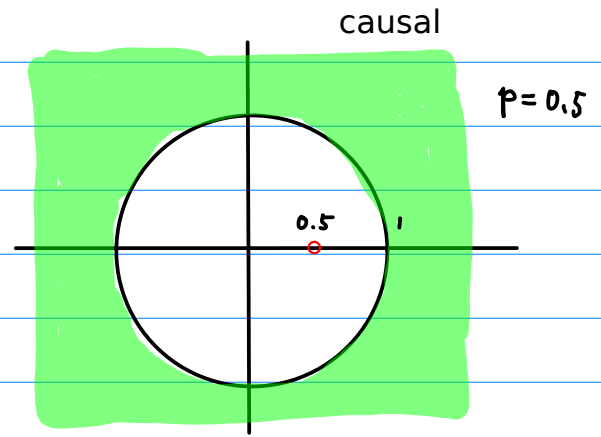
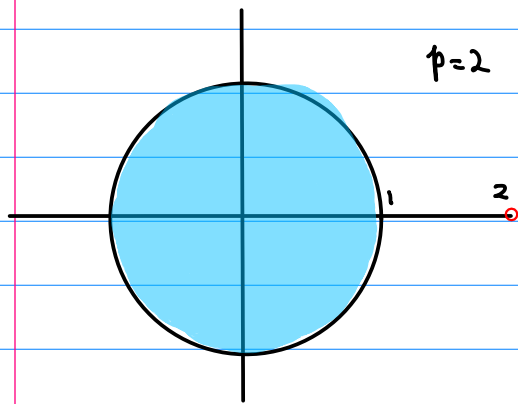

$$\dots 0, 0, 0, 1, b, b^2, b^3, \dots$$

$$f(z) = X(z^{-1}) = \frac{z^{-1}}{z^{-1} - 0.5}$$

$$= \frac{1}{1 - 0.5z} = \frac{2}{2 - z}$$

$$X(z) = \sum_{n=-\infty}^{\infty} x_n z^{-n} = \sum_{n=0}^{\infty} \left(\frac{b}{z}\right)^n$$

$$= \frac{1}{1 - \frac{b}{z}} = \frac{z}{z - b} \quad b \leftarrow 0.5$$

$$a_n = \text{Res}\left(\frac{f(z)}{z^{n+1}}, 0\right) \quad n \geq 0$$

$$= \text{Res}\left(\frac{2}{z^{n+1}(2-z)}, 0\right)$$

$$= \left(\frac{1}{2}\right)^n \quad (n \geq 0)$$

$$X(z) = \frac{z}{z - 0.5}$$

$$\dots 0, 0, 0, 1, \left(\frac{1}{2}\right), \left(\frac{1}{2}\right)^2, \left(\frac{1}{2}\right)^3, \dots$$

$$f(z) = 1 + \left(\frac{1}{2}\right)^1 z^1 + \left(\frac{1}{2}\right)^2 z^2 + \left(\frac{1}{2}\right)^3 z^3 + \dots$$

$$X(z) = 1 + \left(\frac{1}{2}\right) z^{-1} + \left(\frac{1}{2}\right)^2 z^{-2} + \dots$$

$$a_0 = 1$$

$$x_0 = 1$$

$$a_1 = \left(\frac{1}{2}\right)$$

$$x_1 = \left(\frac{1}{2}\right)$$

$$a_2 = \left(\frac{1}{2}\right)^2$$

$$x_2 = \left(\frac{1}{2}\right)^2$$

$$a_3 = \left(\frac{1}{2}\right)^3$$

$$x_3 = \left(\frac{1}{2}\right)^3$$

$$f(z) = \sum_{n=0}^{\infty} \left(\frac{1}{2}\right)^n z^n$$

$$X(z) = \sum_{n=0}^{\infty} \left(\frac{1}{2}\right)^n z^{-n}$$

$$a_n = \left(\frac{1}{2}\right)^n$$

$$x_n = \left(\frac{1}{2}\right)^n$$

$$\text{Res}\left(\frac{2}{z^{n+1}(2-z)}, 0\right) = \left(\frac{1}{2}\right)^n$$

$$n=0 \quad \text{Res}\left(\frac{2}{z^1(2-z)}, 0\right) = 1$$

$$n=1 \quad \text{Res}\left(\frac{2}{z^2(2-z)}, 0\right) = \frac{2}{1!} \frac{d}{dz} \frac{1}{2-z} \Big|_{z=0} = \frac{2}{(2-z)^2} = \left(\frac{1}{2}\right)^1$$

$$n=2 \quad \text{Res}\left(\frac{2}{z^3(2-z)}, 0\right) = \frac{2}{2!} \frac{d^2}{dz^2} \frac{1}{2-z} \Big|_{z=0} = \frac{2}{(2-z)^3} = \left(\frac{1}{2}\right)^2$$

$$n=3 \quad \text{Res}\left(\frac{2}{z^4(2-z)}, 0\right) = \frac{2}{3!} \frac{d^3}{dz^3} \frac{1}{2-z} \Big|_{z=0} = \frac{2}{(2-z)^4} = \left(\frac{1}{2}\right)^3$$

$$n=4 \quad \text{Res}\left(\frac{2}{z^5(2-z)}, 0\right) = \frac{2}{4!} \frac{d^4}{dz^4} \frac{1}{2-z} \Big|_{z=0} = \frac{2}{(2-z)^5} = \left(\frac{1}{2}\right)^4$$

$$f(z) = \sum_{n=0}^{\infty} \left(\frac{1}{2}\right)^n z^n = 1 + \left(\frac{1}{2}\right)z^1 + \left(\frac{1}{2}\right)^2 z^2 + \left(\frac{1}{2}\right)^3 z^3 + \dots$$

$$X(z) = \sum_{n=0}^{\infty} \left(\frac{1}{2}\right)^n z^{-n} = 1 + \left(\frac{1}{2}\right)z^{-1} + \left(\frac{1}{2}\right)^2 z^{-2} + \left(\frac{1}{2}\right)^3 z^{-3} + \dots$$

	...	z^{-3}	z^{-2}	z^{-1}	z^0	z^1	z^2	z^3	...
$f(z)$		0	0	0	1	$\left(\frac{1}{2}\right)$	$\left(\frac{1}{2}\right)^2$	$\left(\frac{1}{2}\right)^3$	
$X(z)$		$\left(\frac{1}{2}\right)^3$	$\left(\frac{1}{2}\right)^2$	$\left(\frac{1}{2}\right)$	1	0	0	0	

Anti-causal

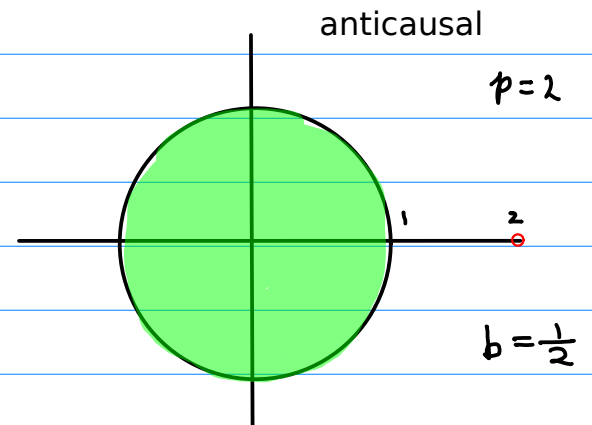
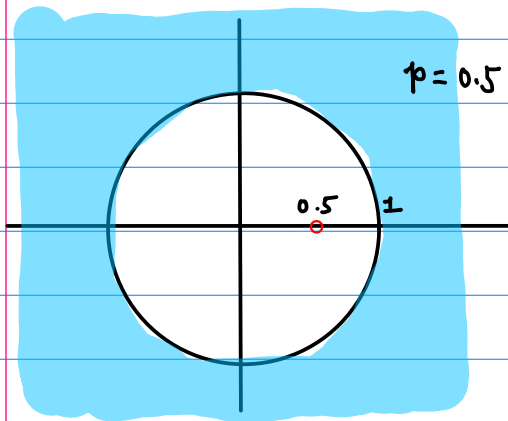

..., $b^3, b^2, b^1, 1, 0, 0, 0, \dots$

$$f(z) = X(z^{-1}) = \frac{2}{2 - z^{-1}}$$

$$= \frac{2z}{2z - 1} = \frac{z}{z - 0.5}$$

Anticausal

$$X(z) = \sum_{n=-\infty}^{\infty} x_n z^{-n} = \sum_{n=0}^{\infty} (bz)^n$$

$$= \frac{1}{1 - bz} = \frac{b^{-1}}{b^{-1} - z} \quad b < 0.5$$

$$a_n = \text{Res}\left(\frac{f(z)}{z^{n+1}}, \frac{1}{2}\right) \quad n \leq 0$$

$$= \text{Res}\left(\frac{z}{z^{n+1}(z-0.5)}, \frac{1}{2}\right)$$

$$= \left(\frac{1}{2}\right)^{-n} \quad (n \leq 0)$$

$$X(z) = \frac{2}{2 - z} = \frac{-2}{z - 2}$$

..., $(\frac{1}{2})^3, (\frac{1}{2})^2, (\frac{1}{2}), 1, 0, 0, 0, \dots$

$$f(z) = 1 + \left(\frac{1}{2}\right)^{-1} z^{-1} + \left(\frac{1}{2}\right)^{-2} z^{-2} + \left(\frac{1}{2}\right)^{-3} z^{-3} + \dots$$

$$a_0 = 1 = 2^0$$

$$a_{-1} = \left(\frac{1}{2}\right)^{-1} = 2^1$$

$$a_{-2} = \left(\frac{1}{2}\right)^{-2} = 2^2$$

$$a_{-3} = \left(\frac{1}{2}\right)^{-3} = 2^3$$

$$X(z) = 1 + \left(\frac{1}{2}\right) z^1 + \left(\frac{1}{2}\right)^2 z^2 + \left(\frac{1}{2}\right)^3 z^3 + \dots$$

$$x_0 = 1$$

$$x_1 = \left(\frac{1}{2}\right)^1 = \left(\frac{1}{2}\right)^{-(-1)}$$

$$x_2 = \left(\frac{1}{2}\right)^2 = \left(\frac{1}{2}\right)^{-(-2)}$$

$$x_3 = \left(\frac{1}{2}\right)^3 = \left(\frac{1}{2}\right)^{-(-3)}$$

$$f(z) = \sum_{n=-\infty}^{\infty} \left(\frac{1}{2}\right)^{-n} z^n \quad (a_n = 0, n > 0)$$

$$X(z) = \sum_{n=-\infty}^{\infty} \left(\frac{1}{2}\right)^{-n} z^{-n} \quad (x_n = 0, n > 0)$$

$$a_n = \left(\frac{1}{2}\right)^{-n} \quad (n \leq 0)$$

$$x_n = \left(\frac{1}{2}\right)^{-n} \quad (n \leq 0)$$

$$\text{Res}\left(\frac{1}{z^n(z-0.5)}, \frac{1}{2}\right) = \left(\frac{1}{2}\right)^{-n} \quad n \leq 0$$

$$n=0 \quad \text{Res}\left(\frac{1}{z^0(z-0.5)}, \frac{1}{2}\right) = 1$$

$$n=-1 \quad \text{Res}\left(\frac{1}{z^{-1}(z-0.5)}, \frac{1}{2}\right) = \left(\frac{1}{2}\right)^1$$

$$n=-2 \quad \text{Res}\left(\frac{1}{z^{-2}(z-0.5)}, \frac{1}{2}\right) = \left(\frac{1}{2}\right)^2$$

$$n=-3 \quad \text{Res}\left(\frac{1}{z^{-3}(z-0.5)}, \frac{1}{2}\right) = \left(\frac{1}{2}\right)^3$$

$$n=-4 \quad \text{Res}\left(\frac{1}{z^{-4}(z-0.5)}, \frac{1}{2}\right) = \left(\frac{1}{2}\right)^4$$

$$f(z) = \sum_{n=-\infty}^{\infty} \left(\frac{1}{2}\right)^n z^{-n} = 1 + \left(\frac{1}{2}\right) z^{-1} + \left(\frac{1}{2}\right)^2 z^{-2} + \left(\frac{1}{2}\right)^3 z^{-3} + \dots$$

$$X(z) = \sum_{n=-\infty}^{\infty} \left(\frac{1}{2}\right)^n z^{-n} = 1 + \left(\frac{1}{2}\right) z^1 + \left(\frac{1}{2}\right)^2 z^2 + \left(\frac{1}{2}\right)^3 z^3 + \dots$$

Summary

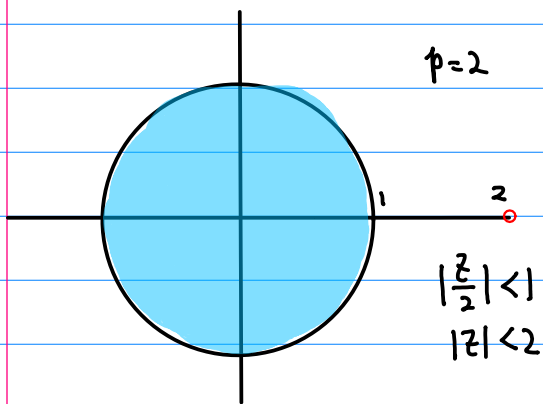

$$X(z^{-1}) = \frac{z^{-1}}{z^{-1} - 0.5} = \frac{1}{1 - (z/2)}$$

$$f(z) = \frac{2}{2-z} = \sum_{n=0}^{\infty} \left(\frac{1}{2}\right)^n z^n$$

$$a_n = \left(\frac{1}{2}\right)^n \quad (n \geq 0)$$

$$= p^{-n} \quad (n \geq 0) \quad p=2$$

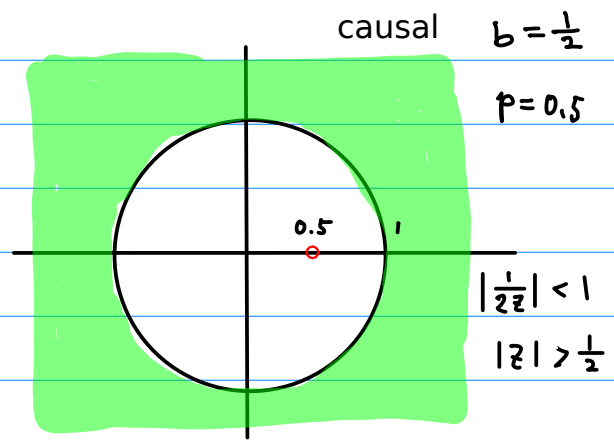

$$\dots, 0, 0, 0, 1, b, b^2, b^3, \dots$$

$$X(z) = \frac{z}{z - 0.5} = \sum_{n=0}^{\infty} \left(\frac{1}{2}\right)^n z^{-n}$$

$$x_n = \left(\frac{1}{2}\right)^n \quad (n \geq 0)$$

$$= p^n \quad (n \geq 0) \quad p = \frac{1}{2}$$

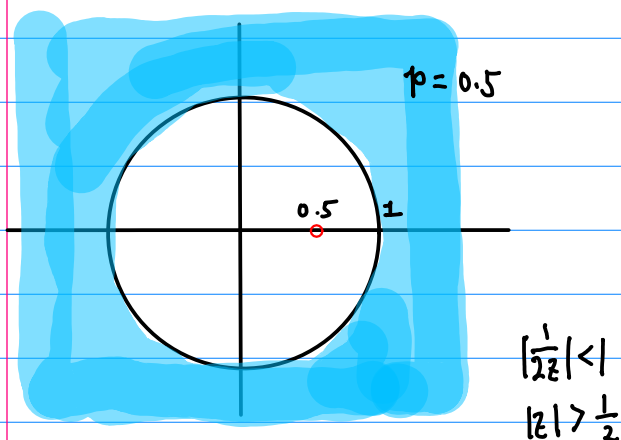

$$X(z^{-1}) = \frac{2}{2 - z^{-1}}$$

$$f(z) = \frac{z}{z - 0.5} = \sum_{n=-\infty}^0 \left(\frac{1}{2}\right)^{-n} z^n$$

$$a_n = \left(\frac{1}{2}\right)^{-n} \quad (n \leq 0)$$

$$= p^{-n} \quad (n \leq 0) \quad p = \frac{1}{2}$$

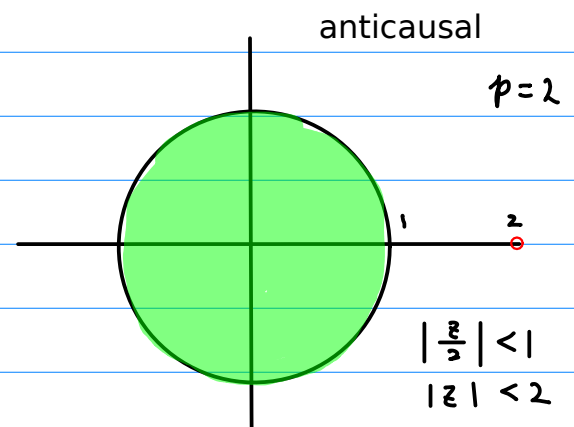

$$\dots, b^3, b^2, b^1, 1, 0, 0, 0, \dots$$

$$X(z) = \frac{2}{2-z} = \sum_{n=-\infty}^0 \left(\frac{1}{2}\right)^{-n} z^{-n}$$

$$x_n = \left(\frac{1}{2}\right)^{-n} \quad (n \leq 0)$$

$$= p^n \quad (n \leq 0) \quad p = 2$$

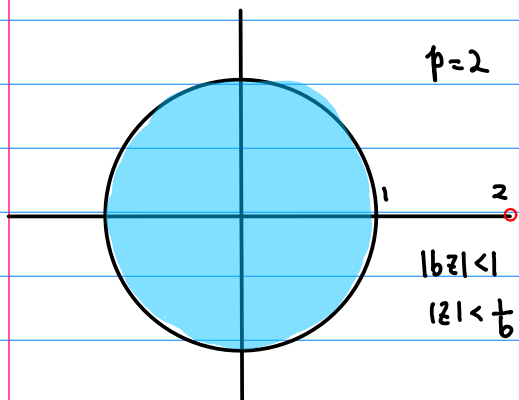

$$X(z^{-1}) = \frac{z^{-1}}{z^{-1} - b} = \frac{1}{1 - bz}$$

$$= (bz)^0 + (bz)^1 + (bz)^2 + \dots$$

$$f(z) = \frac{b^{-1}}{b^{-1} - z} = \sum_{n=0}^{\infty} b^n z^n$$

$$a_n = b^n \quad (n \geq 0)$$

$$p = b^{-1} \quad |z| < p \quad |pz| < 1$$

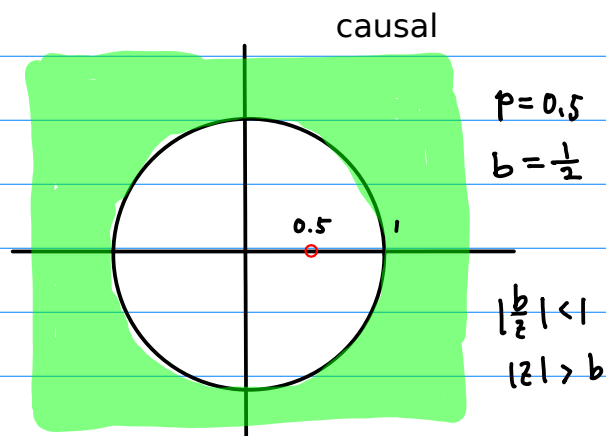

$$\dots, 0, 0, 0, 1, b, b^2, b^3, \dots$$

$$\left(\frac{1}{2}\right)^0 + \left(\frac{1}{2}\right)^1 + \left(\frac{1}{2}\right)^2 + \dots$$

$$X(z) = \frac{1}{1 - \frac{b}{z}} = \frac{z}{z - b}$$

$$x_n = b^n \quad (n \geq 0)$$

$$p = b \quad |z| > p \quad \left|\frac{p}{z}\right| < 1$$

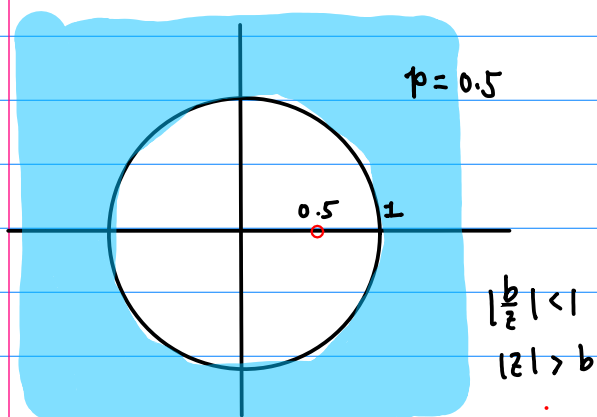

$$X(z^{-1}) = \frac{b^{-1}}{b^{-1} - z^{-1}} = \frac{1}{1 - \frac{b}{z}}$$

$$= \left(\frac{1}{z}\right)^0 + \left(\frac{1}{z}\right)^1 + \left(\frac{1}{z}\right)^2 + \dots$$

$$f(z) = \frac{z}{z - b} = \sum_{n=-\infty}^0 b^{-n} z^n$$

$$a_n = b^{-n} \quad (n \leq 0)$$

$$p = b$$

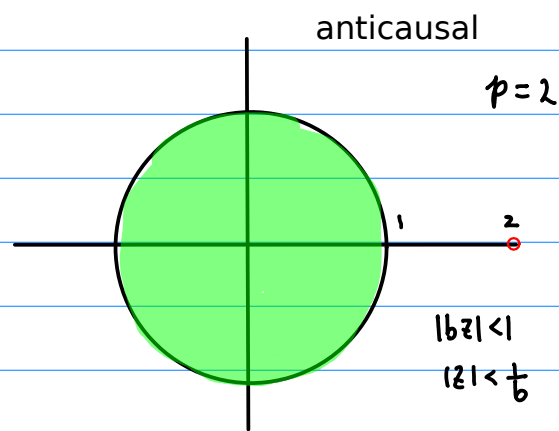

$$\dots, b^3, b^2, b^1, 1, 0, 0, 0, \dots$$

$$(bz)^0 + (bz)^1 + (bz)^2 + \dots$$

$$X(z) = \frac{1}{1 - bz} = \frac{b^{-1}}{b^{-1} - z}$$

$$x_n = b^{-n} \quad (n \leq 0)$$

$$p = b^{-1} \quad |z| < p \quad \left|\frac{z}{p}\right| < 1$$

Two-sided

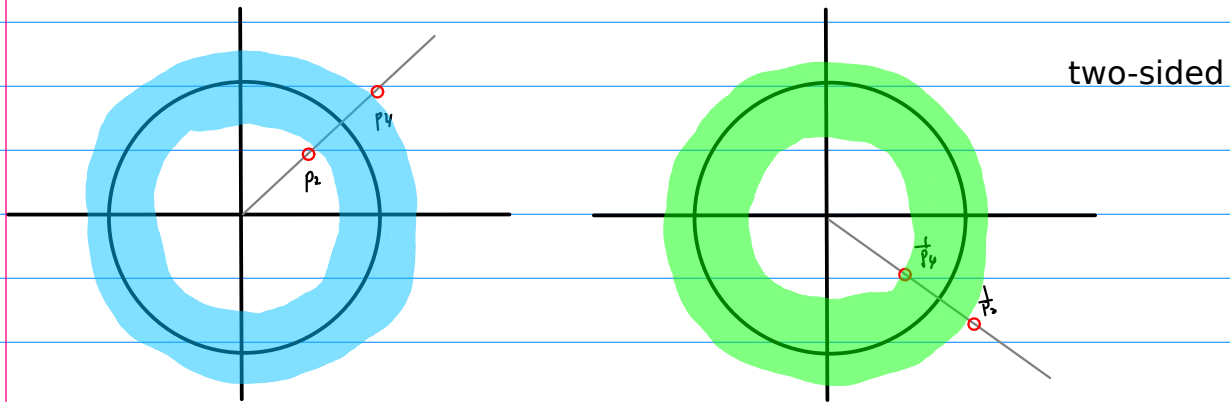

$$a_n = \text{Res}\left(\frac{f(z)}{z^{n+1}}, 0\right) \quad n \leq 0$$

$$+ \text{Res}\left(\frac{f(z)}{z^{n+1}}, p_1\right)$$

$$\frac{1}{2} < |z| < 2 \Rightarrow \left|\frac{1}{2z}\right| < 1, \quad \left|\frac{z}{2}\right| < 1$$

$$\frac{1}{1 - \frac{1}{2z}} + \frac{1}{1 - \frac{z}{2}} = \frac{2z}{2z-1} + \frac{2}{2-z}$$

$$= \frac{z}{z-0.5} - \frac{2}{z-2}$$

$$\frac{1}{1 - \frac{1}{2z}} = \left(\frac{1}{2z}\right)^0 + \left(\frac{1}{2z}\right)^1 + \left(\frac{1}{2z}\right)^2 + \left(\frac{1}{2z}\right)^3 + \dots = \frac{2z}{2z-1} = \frac{z}{z-0.5}$$

$$\left(\frac{1}{2z}\right)^1 + \left(\frac{1}{2z}\right)^2 + \left(\frac{1}{2z}\right)^3 + \dots = \frac{z}{z-0.5} - 1 = \frac{0.5}{z-0.5}$$

$$\frac{1}{1 - \frac{z}{2}} = \left(\frac{z}{2}\right)^0 + \left(\frac{z}{2}\right)^1 + \left(\frac{z}{2}\right)^2 + \left(\frac{z}{2}\right)^3 + \dots = \frac{2}{2-z}$$

$$\underbrace{\left(\frac{1}{2z}\right)^1 + \left(\frac{1}{2z}\right)^2 + \left(\frac{1}{2z}\right)^3 + \dots}_{\text{blue arrow}} = \frac{0.5}{z-0.5} = \sum_{n=1}^{\infty} \left(\frac{1}{2z}\right)^n$$

$$\underbrace{\left(\frac{z}{2}\right)^0 + \left(\frac{z}{2}\right)^1 + \left(\frac{z}{2}\right)^2 + \left(\frac{z}{2}\right)^3 + \dots}_{\text{pink arrow}} = \frac{2}{2-z} = \sum_{n=0}^{\infty} \left(\frac{z}{2}\right)^n$$

$$\dots + \left(\frac{z}{2}\right)^3 + \left(\frac{z}{2}\right)^2 + \left(\frac{z}{2}\right)^1 + \left(\frac{z}{2}\right)^0 + \underbrace{\left(\frac{1}{2z}\right)^1 + \left(\frac{1}{2z}\right)^2 + \left(\frac{1}{2z}\right)^3 + \dots}_{\text{blue arrow}} = \boxed{\frac{2}{2-z}} + \boxed{\frac{0.5}{z-0.5}}$$

$$\begin{aligned} &= \frac{0.5}{z-0.5} + \frac{2}{2-z} \\ &= \frac{0.5}{z-0.5} - \frac{2}{z-2} \\ &= \frac{\cancel{\frac{1}{2}z} - 2\cancel{z}}{(z-0.5)(z-2)} \\ &= \frac{-\frac{3}{2}z}{(z-0.5)(z-2)} \end{aligned}$$

$$= \sum_{n=1}^{\infty} \left(\frac{1}{2z}\right)^n + \sum_{n=0}^{\infty} \left(\frac{z}{2}\right)^n$$

$$= \sum_{n=1}^{\infty} \left(\frac{1}{2}\right)^n z^{-n} + \sum_{n=0}^{\infty} \left(\frac{1}{2}\right)^n z^n$$

... 0, 0, 0, 1, $(\frac{1}{2})$, $(\frac{1}{2})^2$, $(\frac{1}{2})^3$, ...

$$X(z) = \frac{1}{1 - \frac{0.5}{z}} = \frac{z}{z - 0.5}$$
$$\left| \frac{0.5}{z} \right| < 1 \quad |z| > 0.5$$

... 0, 0, 0, $(\frac{1}{2})^1$, $(\frac{1}{2})^2$, $(\frac{1}{2})^3$, $(\frac{1}{2})^4$, ...

$$X(z) = \frac{0.5}{1 - \frac{0.5}{z}} = \frac{0.5z}{z - 0.5}$$
$$\left| \frac{0.5}{z} \right| < 1 \quad |z| > 0.5$$

... 0, 0, 0, 0, $(\frac{1}{2})$, $(\frac{1}{2})^2$, $(\frac{1}{2})^3$, ...

$$X(z) = \frac{0.5}{1 - \frac{0.5}{z}} \cdot z^1 = \frac{0.5z}{z - 0.5}$$
$$\left| \frac{0.5}{z} \right| < 1 \quad |z| > 0.5$$

..., $(\frac{1}{2})^3$, $(\frac{1}{2})^2$, $(\frac{1}{2})$, 1, 0, 0, 0, ...

$$X(z) = \frac{1}{1 - \frac{z}{2}} = \frac{2}{2 - z}$$
$$\left| \frac{z}{2} \right| < 1 \quad |z| < 2$$

$b^3, b^2, b^1, 1, a, a^2, a^3$

... 0, 0, 0, 0, a, a^2, a^3, ...

..., $b^3, b^2, b^1, 1, 0, 0, 0, \dots$

$$X(z) = \frac{0.5}{z - 0.5} + \frac{2}{2 - z}$$
$$= \frac{0.5}{z - 0.5} - \frac{2}{z - 2}$$
$$= \frac{\frac{1}{2}z - 2z}{(z - 0.5)(z - 2)}$$
$$= \frac{-\frac{3}{2}z}{(z - 0.5)(z - 2)}$$

..., $b^3, b^2, b^1, 1, 0, 0, 0, \dots$

... 0, 0, 0, 1, a, a^2, a^3, ...

$$\frac{z}{z - 0.5} + \frac{2}{2 - z} - 1$$
$$= \frac{z^2 - 2z - 2z + 1}{(z - 0.5)(z - 2)} +$$
$$= \frac{\cancel{z^2} - 4z + \cancel{1} - \cancel{z^2} + 2.5z - \cancel{1}}{(z - 0.5)(z - 2)}$$
$$= \frac{-1.5z}{(z - 0.5)(z - 2)}$$

$$f(z) = \frac{-\frac{3}{2}z}{(z-0.5)(z-2)}$$

$$\chi(z) = \frac{-\frac{3}{2}z}{(z-0.5)(z-2)}$$

$$a_n = \begin{cases} \operatorname{Res}\left(\frac{f(z)}{z^{n+1}}, \frac{1}{2}\right) + \operatorname{Res}\left(\frac{f(z)}{z^{n+1}}, 0\right) & (n \geq 0) \\ \operatorname{Res}\left(\frac{f(z)}{z^{n+1}}, \frac{1}{2}\right) & (n < 0) \end{cases}$$

$$a_n = \begin{cases} \operatorname{Res}\left(\frac{-\frac{3}{2}}{(z-0.5)(z-2)z^n}, \frac{1}{2}\right) + \operatorname{Res}\left(\frac{-\frac{3}{2}}{(z-0.5)(z-2)z^n}, 0\right) & (n \geq 0) \\ \operatorname{Res}\left(\frac{-\frac{3}{2}}{(z-0.5)(z-2)z^n}, \frac{1}{2}\right) & (n < 0) \end{cases}$$

$$n=-3 \quad \operatorname{Res}\left(\frac{-\frac{3}{2}}{(z-0.5)(z-2)z^{-3}}, \frac{1}{2}\right) = \left(\frac{1}{2}\right)^3 = \left(\frac{1}{2}\right)^{-(-3)}$$

$$n=-2 \quad \operatorname{Res}\left(\frac{-\frac{3}{2}}{(z-0.5)(z-2)z^{-2}}, \frac{1}{2}\right) = \left(\frac{1}{2}\right)^2 = \left(\frac{1}{2}\right)^{-(-2)}$$

$$n=-1 \quad \operatorname{Res}\left(\frac{-\frac{3}{2}}{(z-0.5)(z-2)z^{-1}}, \frac{1}{2}\right) = \left(\frac{1}{2}\right)^1 = \left(\frac{1}{2}\right)^{-(-1)}$$

$$n=0 \quad \operatorname{Res}\left(\frac{-\frac{3}{2}}{(z-0.5)(z-2)z^0}, \frac{1}{2}\right) = \left(\frac{1}{2}\right)^0 = \left(\frac{1}{2}\right)^0$$

$$n=1 \quad \operatorname{Res}\left(\frac{-\frac{3}{2}}{(z-0.5)(z-2)z^1}, \frac{1}{2}\right) + \operatorname{Res}\left(\frac{-\frac{3}{2}}{(z-0.5)(z-2)z^1}, 0\right) = \left(\frac{1}{2}\right)^1 + \left(-\frac{3}{2}\right) = \left(\frac{1}{2}\right)$$

$$n=2 \quad \operatorname{Res}\left(\frac{-\frac{3}{2}}{(z-0.5)(z-2)z^2}, \frac{1}{2}\right) + \operatorname{Res}\left(\frac{-\frac{3}{2}}{(z-0.5)(z-2)z^2}, 0\right) = \left(\frac{1}{2}\right)^{-2} - \frac{1}{4} = \left(\frac{1}{2}\right)^2$$

$$n=3 \quad \operatorname{Res}\left(\frac{-\frac{3}{2}}{(z-0.5)(z-2)z^3}, \frac{1}{2}\right) + \operatorname{Res}\left(\frac{-\frac{3}{2}}{(z-0.5)(z-2)z^3}, 0\right) = \left(\frac{1}{2}\right)^{-3} - \frac{1}{8} = \left(\frac{1}{2}\right)^3$$

$$\text{Res}(G(z), z_0) \left\{ \begin{array}{l} \lim_{z \rightarrow z_0} (z-z_0) G(z) = a_{-1} \quad \text{Simple pole } z_0 \\ \frac{1}{(n-1)!} \lim_{z \rightarrow z_0} \frac{d^{n-1}}{dz^{n-1}} (z-z_0)^n G(z) = a_{-1} \quad n\text{-th order pole } z_0 \end{array} \right.$$

$$\text{Res}\left(\frac{-\frac{3}{2}}{(z-0.5)(z-2)z^n}, 0\right) ?$$

$$\frac{-\frac{3}{2}}{(z-0.5)(z-2)} = \frac{A}{z-0.5} + \frac{B}{z-2}$$

$$A = \frac{-\frac{3}{2}}{z-2} \Big|_{z=0.5} = 1 \quad \frac{-\frac{3}{2}}{z-2}$$

$$B = \frac{-\frac{3}{2}}{z-0.5} \Big|_{z=2} = \frac{-\frac{3}{2}}{\frac{3}{2}} = -1$$

$$\frac{-\frac{3}{2}}{(z-0.5)(z-2)} = \frac{1}{z-0.5} - \frac{1}{z-2}$$

$$\frac{d}{dz} \frac{-\frac{3}{2}}{(z-0.5)(z-2)} = \frac{-1}{(z-0.5)^2} + \frac{1}{(z-2)^2}$$

$$\frac{d^2}{dz^2} \frac{-\frac{3}{2}}{(z-0.5)(z-2)} = \frac{2}{(z-0.5)^3} - \frac{2}{(z-2)^3}$$

$$\frac{d^3}{dz^3} \frac{-\frac{3}{2}}{(z-0.5)(z-2)} = \frac{-6}{(z-0.5)^4} + \frac{6}{(z-2)^4}$$

$$\left\{ \begin{array}{l} \frac{d}{dz} \frac{-\frac{3}{2}}{(z-0.5)(z-2)} = \frac{-1}{(z-0.5)^2} + \frac{1}{(z-2)^2} \\ \frac{1}{2!} \frac{d^2}{dz^2} \frac{-\frac{3}{2}}{(z-0.5)(z-2)} = \frac{1}{(z-0.5)^3} - \frac{1}{(z-2)^3} \\ \frac{1}{3!} \frac{d^3}{dz^3} \frac{-\frac{3}{2}}{(z-0.5)(z-2)} = \frac{-1}{(z-0.5)^4} + \frac{1}{(z-2)^4} \end{array} \right.$$

$$\text{Res}\left(\frac{-\frac{3}{2}}{(z-0.5)(z-2)z^1}, 0\right) = \frac{-\frac{3}{2}}{(z-0.5)(z-2)} \Big|_{z=0} = \left[\frac{1}{(z-0.5)} - \frac{1}{(z-2)} \right]_{z=0}$$

$$= -2 + \frac{1}{2} = -\frac{3}{2}$$

$$\text{Res}\left(\frac{-\frac{3}{2}}{(z-0.5)(z-2)z^2}, 0\right) = \frac{d}{dz} \frac{-\frac{3}{2}}{(z-0.5)(z-2)} \Big|_{z=0} = \left[\frac{-1}{(z-0.5)^2} + \frac{1}{(z-2)^2} \right]_{z=0}$$

$$= -4 + \frac{1}{4} = -\frac{15}{4}$$

$$\text{Res}\left(\frac{-\frac{3}{2}}{(z-0.5)(z-2)z^3}, 0\right) = \frac{1}{2!} \frac{d^2}{dz^2} \frac{-\frac{3}{2}}{(z-0.5)(z-2)} \Big|_{z=0} = \left[\frac{1}{(z-0.5)^3} - \frac{1}{(z-2)^3} \right]_{z=0}$$

$$= \left(-8 + \frac{1}{8}\right) = -\frac{63}{8}$$

$$a_n = \begin{cases} \text{Res}\left(\frac{-\frac{3}{2}}{(z-0.5)(z-2)z^n}, \frac{1}{2}\right) + \text{Res}\left(\frac{-\frac{3}{2}}{(z-0.5)(z-2)z^n}, 0\right) = \left(\frac{1}{2}\right)^n & (n \geq 0) \\ \text{Res}\left(\frac{-\frac{3}{2}}{(z-0.5)(z-2)z^n}, \frac{1}{2}\right) = \left(\frac{1}{2}\right)^{-n} & (n < 0) \end{cases}$$

$$a_n = \begin{cases} \left(\frac{1}{2}\right)^n & (n \geq 0) \\ \left(\frac{1}{2}\right)^{-n} & (n < 0) \end{cases}$$

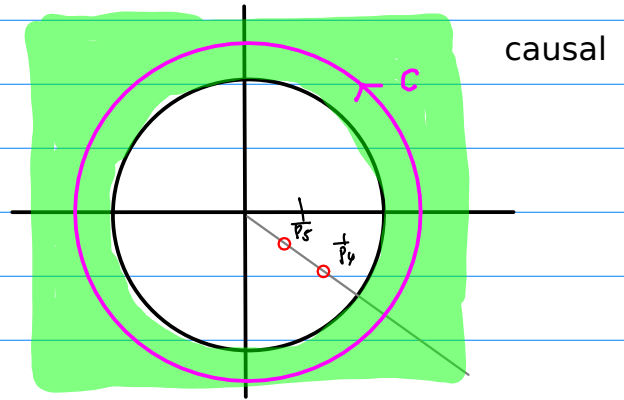
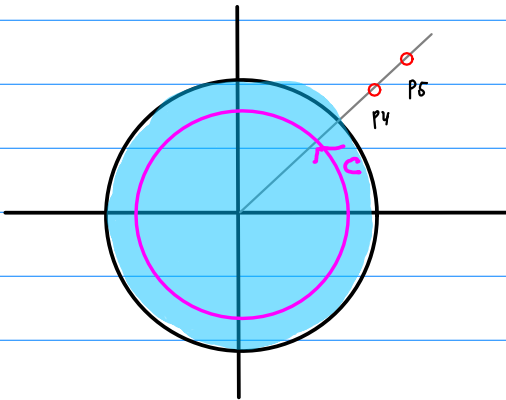

$$f(z) = \sum_{n=n_1}^{\infty} a_n^{[m]} z^n$$

$$X(z) = \sum_{k=0}^{\infty} x_k z^{-k}$$

$$a_n^{[m]} = \frac{1}{2\pi i} \oint_C \frac{f(z)}{z^{n+1}} dz$$

$$= \sum_k \text{Res} \left(\frac{f(z)}{z^{n+1}}, z_k \right)$$

$$x_n = \frac{1}{2\pi i} \oint_C X(z) z^{n-1} dz$$

$$= \sum_k \text{Res} (X(z) z^{n-1}, z_k)$$

Poles z_k

$$n \geq 0 \quad z_1, z_2, z_3, \circ$$

$$n < 0 \quad z_1, z_2, z_3$$

Poles z_k

$$n > 0 \quad z_1, z_2, z_3$$

$$n \leq 0 \quad z_1, z_2, z_3, \circ$$

Z-transform

$$z_m = 0$$

$$\begin{aligned} x[n] &= \frac{1}{2\pi i} \oint_C f(z) z^{n-1} dz \\ &= \sum_k \operatorname{Res}(f(z) z^{n-1}, z_k) \end{aligned}$$

$n > 0$ z_k : poles of $f(z)$

$n = 0$ z_k : poles of $f(z)$ + $z = 0$
 $z^{n-1} = z^{-1} = \frac{1}{z}$

$x[n]$ includes $u[n] \rightarrow X[z]$ contains z on its numerator

Also, think about modified partial fraction $\frac{X[z]}{z}$

Laurent Expansion

expansion at z_m

$$\begin{aligned} a_n^{\{m\}} &= \frac{1}{2\pi i} \oint_C \frac{f(z)}{(z-z_m)^{n+1}} dz \\ &= \sum_k \operatorname{Res}\left(\frac{f(z)}{(z-z_m)^{n+1}}, z_k\right) \end{aligned}$$

$$z_m = 0$$

$$\begin{aligned} a_n^{\{0\}} &= \frac{1}{2\pi i} \oint_C \frac{f(z)}{z^{n+1}} dz \\ &= \sum_k \operatorname{Res}\left(\frac{f(z)}{z^{n+1}}, z_k\right) \end{aligned}$$

$$\begin{aligned} a_{-n}^{\{0\}} &= \frac{1}{2\pi i} \oint_C f(z) z^{n-1} dz \\ &= \sum_k \operatorname{Res}(f(z) z^{n-1}, z_k) \end{aligned}$$

$$\begin{aligned} a_{-n}^{\{0\}} &= \frac{1}{2\pi i} \oint_C \frac{f(z)}{z^{-n+1}} dz \\ &= \sum_k \operatorname{Res}\left(\frac{f(z)}{z^{-n+1}}, z_k\right) \end{aligned}$$

Different D, Different Laurent Series

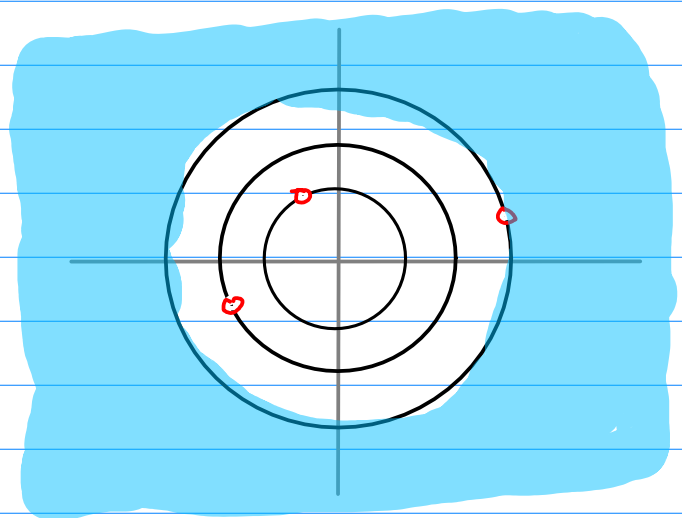
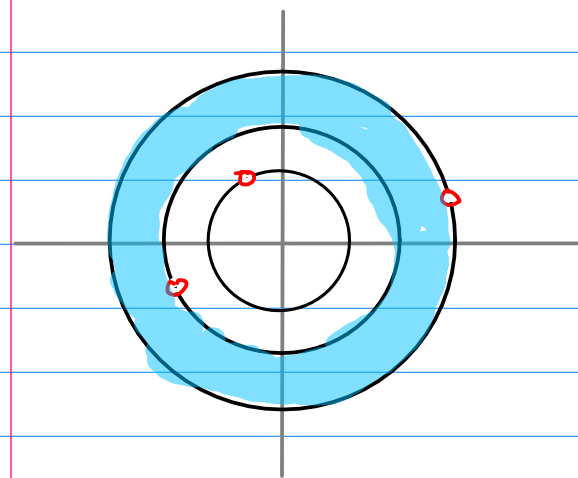
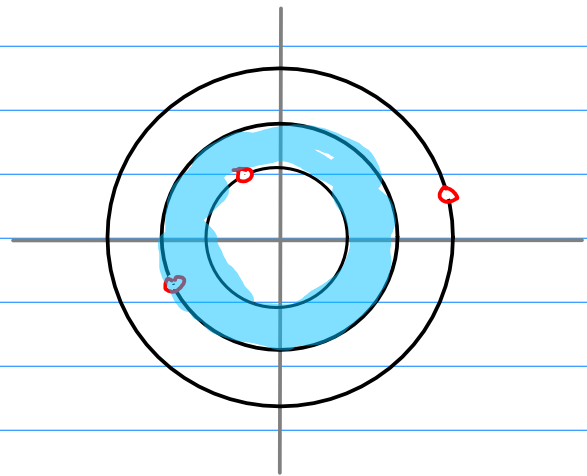
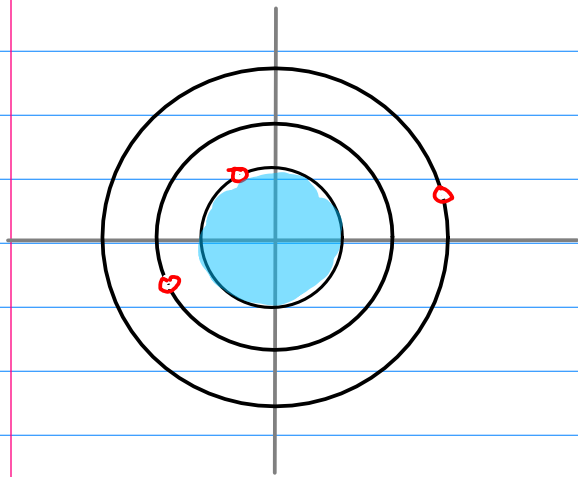

$$\begin{aligned} x[n] &= \frac{1}{2\pi i} \int_C X(z) z^{n-1} dz \\ &= \sum_{z_k} \text{Res}(X(z) z^{n-1}, z_k) \end{aligned}$$

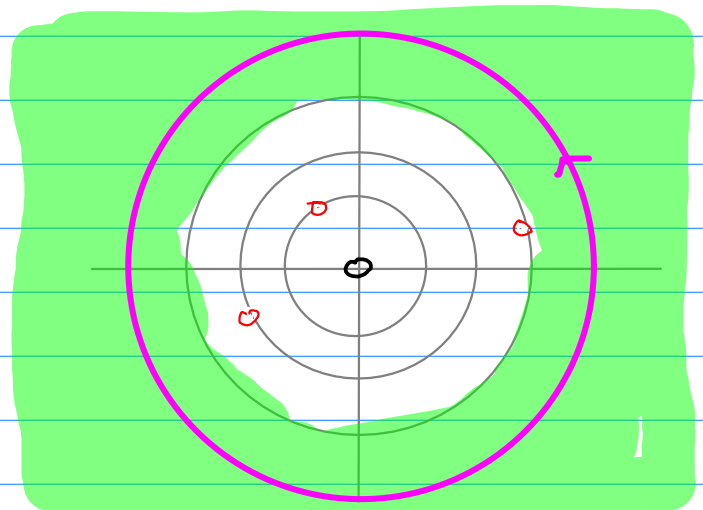

z -transform

$$f(z) = \frac{-1}{(z-1)(z-2)}$$

Complex Variables and Ap
Brown & Churchill

$$f(z) = \frac{-1}{(z-1)(z-2)} = \frac{1}{z-1} - \frac{1}{z-2}$$

$$D_1: |z| < 1$$

$$D_2: 1 < |z| < 2$$

$$D_3: 2 < |z|$$

$$\textcircled{1} D_1 \quad |z| < 1, \quad \left|\frac{z}{2}\right| < 1$$

$$\begin{aligned} f(z) &= \frac{1}{z-1} - \frac{1}{z-2} = \frac{-1}{1-z} + \frac{1}{1-\left(\frac{z}{2}\right)} \\ &= -\sum_{n=0}^{\infty} z^n + \sum_{n=0}^{\infty} \frac{z^n}{2^{n+1}} = \sum_{n=0}^{\infty} (2^{-n-1} - 1)z^n \quad |z| < 1 \end{aligned}$$

$$\textcircled{2} D_2 \quad 1 < |z| < 2 \Rightarrow \left|\frac{1}{z}\right| < 1, \quad \left|\frac{z}{2}\right| < 1$$

$$\begin{aligned} f(z) &= \frac{1}{z-1} - \frac{1}{z-2} = \frac{1}{z} \cdot \frac{1}{1-\left(\frac{1}{z}\right)} + \frac{1}{2} \frac{1}{1-\left(\frac{z}{2}\right)} \\ &= \sum_{n=0}^{\infty} \frac{1}{z^{n+1}} + \sum_{n=0}^{\infty} \frac{z^n}{2^{n+1}} \\ &= \sum_{n=1}^{\infty} \frac{1}{z^n} + \sum_{n=0}^{\infty} \frac{z^n}{2^{n+1}} \end{aligned}$$

$$\textcircled{3} D_3 \quad 2 < |z| \quad \left|\frac{2}{z}\right| < 1 \quad \left|\frac{1}{z}\right| < 1$$

$$\begin{aligned} f(z) &= \frac{1}{z-1} - \frac{1}{z-2} = \frac{1}{z} \frac{1}{1-\left(\frac{1}{z}\right)} - \frac{1}{z} \frac{1}{1-\left(\frac{2}{z}\right)} \\ &= \sum_{n=0}^{\infty} \frac{1}{z^{n+1}} - \sum_{n=0}^{\infty} \frac{2^n}{z^{n+1}} = \sum_{n=0}^{\infty} \frac{1-2^n}{z^{n+1}} \\ &= \sum_{n=1}^{\infty} \frac{1-2^{n-1}}{z^n} \end{aligned}$$

$$f(z) = \frac{-1}{(z-1)(z-2)}$$

① D_1 $|z| < 1, \quad \left|\frac{z}{2}\right| < 1$

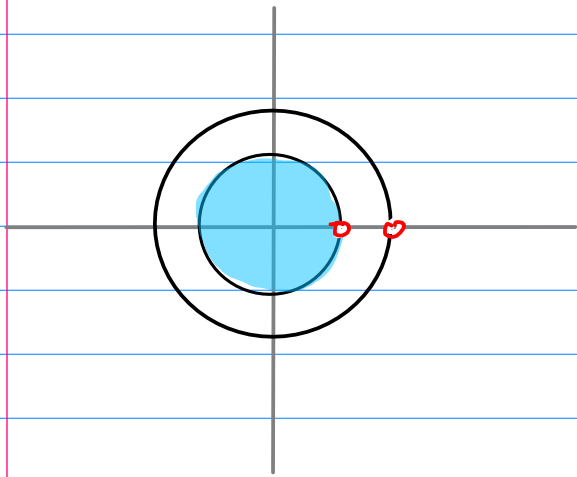

$$\frac{f(z)}{z^{n+1}} = \frac{-1}{(z-1)(z-2)z^{n+1}}$$

$$\begin{aligned} f(z) &= \frac{1}{z-1} - \frac{1}{z-2} = \frac{-1}{1-z} + \frac{1}{1-\left(\frac{z}{2}\right)} \\ &= -\sum_{n=0}^{\infty} z^n + \sum_{n=0}^{\infty} \frac{z^n}{2^{n+1}} = \sum_{n=0}^{\infty} (2^{-n-1} - 1)z^n \quad |z| < 1 \end{aligned}$$

$$a_n = \frac{f(z)}{z^{n+1}} = \frac{1}{(z-1)(z-2)z^{n+1}} \quad \frac{1}{z-1} - \frac{1}{z-2}$$

$$a_n = \sum_{k=1}^M \operatorname{Res} \left(\frac{f(z)}{(z-z_k)^{n+1}}, z_k \right) = \operatorname{Res} \left(\frac{-1}{(z-1)(z-2)z^{n+1}}, 0 \right)$$

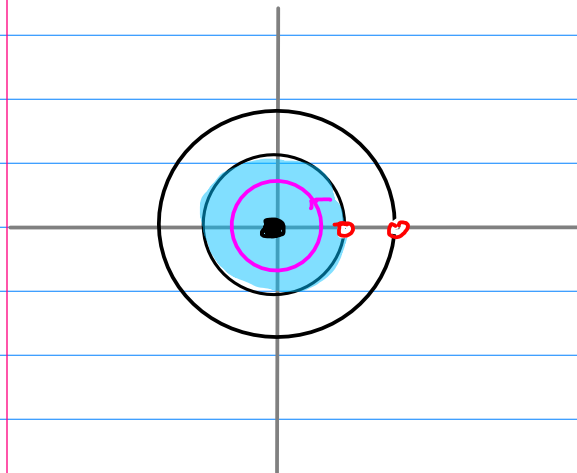

$$a_n = \sum_{k=1}^M \operatorname{Res} \left(\frac{f(z)}{(z-z_k)^{n+1}}, z_k \right) = \operatorname{Res} \left(\frac{-1}{(z-1)(z-2)z^{n+1}}, 0 \right)$$

$n \geq 0$ then the pole $z=0$

$$\frac{1}{(n-1)!} \lim_{z \rightarrow z_0} \frac{d^{n-1}}{dz^{n-1}} (z-z_0)^n f(z) \quad (\text{order } n)$$

$$\frac{d}{dz} ((z-1)^{-1} - (z-2)^{-1}) = (-1) ((z-1)^{-2} - (z-2)^{-2})$$

$$\frac{d^2}{dz^2} ((z-1)^{-1} - (z-2)^{-1}) = (-1)(-2) ((z-1)^{-3} - (z-2)^{-3})$$

$$\frac{d^3}{dz^3} ((z-1)^{-1} - (z-2)^{-1}) = (-1)(-2)(-3) ((z-1)^{-4} - (z-2)^{-4})$$

$$\frac{d^n}{dz^n} ((z-1)^{-1} - (z-2)^{-1}) = (-1)^n n! ((z-1)^{-n-1} - (z-2)^{-n-1})$$

$$\begin{aligned} \frac{1}{n!} \lim_{z \rightarrow 0} \frac{d^n}{dz^n} ((z-1)^{-1} - (z-2)^{-1}) &= (-1)^n \lim_{z \rightarrow 0} ((z-1)^{-n-1} - (z-2)^{-n-1}) \\ &= (-1)^n ((-1)^{-n-1} - (-2)^{-n-1}) \\ &= -1 + 2^{-n-1} \end{aligned}$$

$$a_n = -1 + 2^{-n-1} \quad (n \geq 0)$$

$$f(z) = \sum_{n=-n_1}^{\infty} a_n z^n = \sum_{n=0}^{\infty} (2^{-n-1} - 1) z^n$$

$$f(z) = \frac{-1}{(z-1)(z-2)}$$

$$\textcircled{2} D_2 \quad 1 < |z| < 2 \Rightarrow \left| \frac{1}{z} \right| < 1, \quad \left| \frac{z}{2} \right| < 1$$

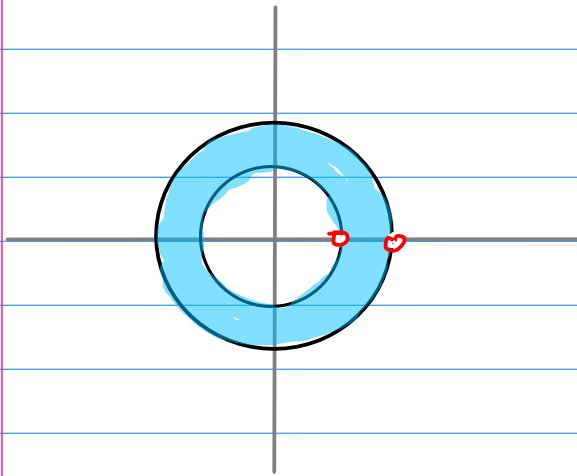

$$\begin{aligned} f(z) &= \frac{1}{z-1} - \frac{1}{z-2} = \frac{1}{z} \cdot \frac{1}{1-\left(\frac{1}{z}\right)} + \frac{1}{2} \frac{1}{1-\left(\frac{z}{2}\right)} \\ &= \sum_{n=0}^{\infty} \frac{1}{z^{n+1}} + \sum_{n=0}^{\infty} \frac{z^n}{2^{n+1}} \\ &= \sum_{n=1}^{\infty} \frac{1}{z^n} + \sum_{n=0}^{\infty} \frac{z^n}{2^{n+1}} \end{aligned}$$

$$\begin{aligned} a_n &= \sum_{k=1}^M \text{Res} \left(\frac{f(z)}{(z-z_k)^{n+1}}, z_k \right) = \text{Res} \left(\frac{-1}{(z-1)(z-2)z^{n+1}}, 0 \right) \\ &\quad + \text{Res} \left(\frac{-1}{(z-1)(z-2)z^{n+1}}, 1 \right) \end{aligned}$$

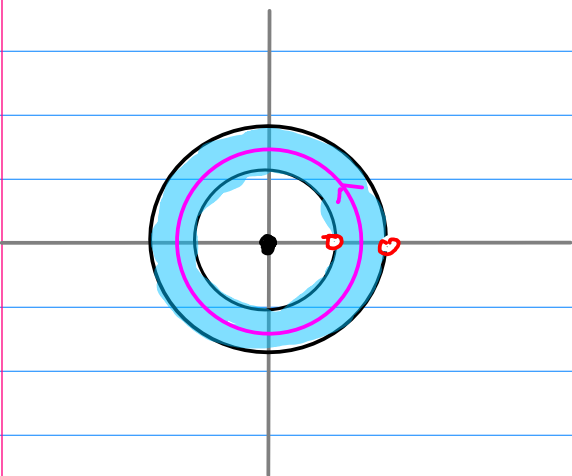

$$a_n = \sum_{k=1}^M \operatorname{Res} \left(\frac{f(z)}{(z-z_k)^{n+1}}, z_k \right) = \operatorname{Res} \left(\frac{-1}{(z-1)(z-2)z^{n+1}}, 0 \right) + \operatorname{Res} \left(\frac{-1}{(z-1)(z-2)z^{n+1}}, 1 \right)$$

$$\frac{1}{(n-1)!} \lim_{z \rightarrow z_0} \frac{d^{n-1}}{dz^{n-1}} (z-z_0)^n f(z) \quad (\text{order } n)$$

$$\begin{aligned} \frac{1}{n!} \lim_{z \rightarrow 0} \frac{d^n}{dz^n} ((z-1)^{-1} - (z-2)^{-1}) &= (-1)^n \lim_{z \rightarrow 0} ((z-1)^{-n-1} - (z-2)^{-n-1}) \\ &= (-1)^n ((-1)^{-n-1} - (-2)^{-n-1}) \\ &= -1 + 2^{-n-1} \end{aligned}$$

$$\operatorname{Res} \left(\frac{-1}{(z-1)(z-2)z^{n+1}}, 0 \right) = -1 + 2^{-n-1} \quad (n \geq 0)$$

$$\operatorname{Res} \left(\frac{-1}{(z-1)(z-2)z^{n+1}}, 1 \right) = \lim_{z \rightarrow 1} (z-1) \frac{-1}{(z-1)(z-2)z^{n+1}} = 1$$

$n=-3$	$n=-2$	$n=-1$	$n=0$	$n=1$	$n=2$	
0	0	0	$-1+2^{-1}$	$-1+2^{-2}$	$-1+2^{-3}$	$\operatorname{Res} \left(\frac{f(z)}{z^{n+1}}, 0 \right)$
1	1	1	1	1	1	$\operatorname{Res} \left(\frac{f(z)}{z^{n+1}}, 1 \right)$
1	1	1	2^{-1}	2^{-2}	2^{-3}	

$$\begin{cases} a_n = 2^{-n-1} & n \geq 0 \\ a_n = 1 & n < 0 \end{cases} \quad \begin{cases} 2^{-n-1} z^n \\ z^{-n} \end{cases}$$

$$f(z) = \sum_{n=1}^{\infty} \frac{1}{z^n} + \sum_{n=0}^{\infty} \frac{z^n}{2^{n+1}}$$

$$f(z) = \frac{-1}{(z-1)(z-2)}$$

$$\textcircled{3} \quad D_3 \quad 2 < |z| \quad \left| \frac{2}{z} \right| < 1 \quad \left| \frac{1}{z} \right| < 1$$

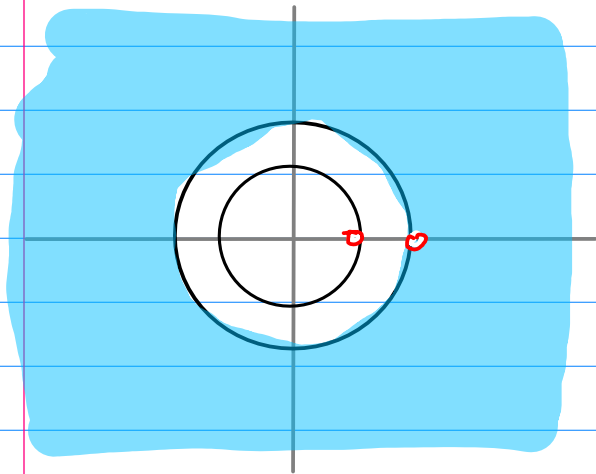

$$\begin{aligned} f(z) &= \frac{1}{z-1} - \frac{1}{z-2} = \frac{1}{z} \frac{1}{1-(\frac{1}{z})} - \frac{1}{z} \frac{1}{1-(\frac{2}{z})} \\ &= \sum_{n=0}^{\infty} \frac{1}{z^{n+1}} - \sum_{n=0}^{\infty} \frac{2^n}{z^{n+1}} = \sum_{n=0}^{\infty} \frac{1-2^n}{z^{n+1}} \\ &= \sum_{n=1}^{\infty} \frac{1-2^{n-1}}{z^n} \end{aligned}$$

$$\begin{aligned} a_n &= \sum_{k=1}^M \text{Res} \left(\frac{f(z)}{(z-z_k)^{n+1}}, z_k \right) = \text{Res} \left(\frac{-1}{(z-1)(z-2)z^{n+1}}, 0 \right) \\ &\quad + \text{Res} \left(\frac{-1}{(z-1)(z-2)z^{n+1}}, 1 \right) \\ &\quad + \text{Res} \left(\frac{-1}{(z-1)(z-2)z^{n+1}}, 2 \right) \end{aligned}$$

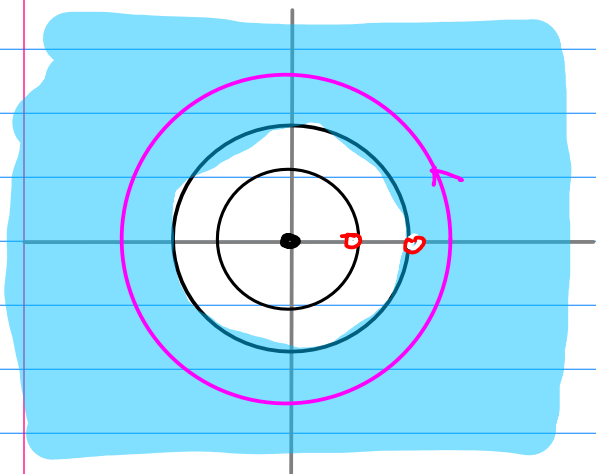

$$\text{Res} \left(\frac{-1}{(z-1)(z-2)z^{n+1}}, 0 \right) = -1 + 2^{-n+1} \quad (n \geq 0)$$

$$\text{Res} \left(\frac{-1}{(z-1)(z-2)z^{n+1}}, 1 \right) = \lim_{z \rightarrow 1} (z-1) \frac{-1}{(z-1)(z-2)z^{n+1}} = 1$$

$$\text{Res} \left(\frac{-1}{(z-1)(z-2)z^{n+1}}, 2 \right) = \lim_{z \rightarrow 2} (z-2) \frac{-1}{(z-1)(z-2)z^{n+1}} = -\frac{1}{2^{n+1}}$$

$n=-3$	$n=-2$	$n=-1$	$n=0$	$n=1$	$n=2$	
0	0	0	$-1+2^1$	$-1+2^2$	$-1+2^3$	$\text{Res} \left(\frac{f(z)}{z^{n+1}}, 0 \right)$
1	1	1	1	1	1	$\text{Res} \left(\frac{f(z)}{z^{n+1}}, 1 \right)$
-2^2	-2	-1	-2^1	-2^2	-2^3	$\text{Res} \left(\frac{f(z)}{z^{n+1}}, 2 \right)$
$1-2^2$	$1-2$	0	0	0	0	

$$a_n = 1 - 2^{-n+1} \quad n < 0 = \sum_{n=1}^{\infty} \frac{1-2^{n+1}}{z^n}$$

$$f(z) = \sum_{n=-1}^{-\infty} (1-2^{-n+1}) z^n = \sum_{n=1}^{\infty} \frac{1-2^{n+1}}{z^n}$$

$$f(z) = \frac{-1}{(z-1)(z-2)}$$

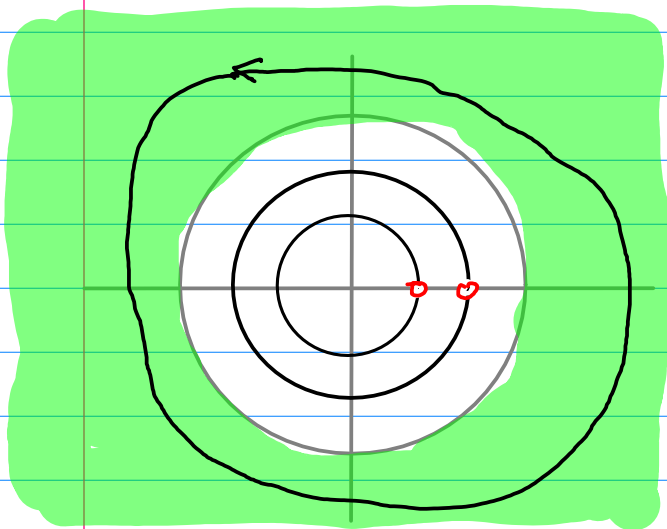

$$x[n]$$

$$= \frac{1}{2\pi i} \int_C \boxed{X(z) z^{n-1}} dz$$

$$= \sum_{j=1}^k \text{Res}(\boxed{X(z) z^{n-1}}, z_j)$$

$$X(z) = \frac{-1}{(z-1)(z-2)}$$

$$X(z) z^{n-1} = \frac{-1}{(z-1)(z-2)} z^{n-1}$$

$$\text{Res}(\boxed{X(z) z^{n-1}}, 1) = (z-2) \frac{-1}{(z-1)(z-2)} z^{n-1} \Big|_{z=1} = 1$$

$$\text{Res}(\boxed{X(z) z^{n-1}}, 2) = (z-1) \frac{-1}{(z-1)(z-2)} z^{n-1} \Big|_{z=2} = -2^{n-1}$$

$$x[n] = 1 - 2^{n-1}$$

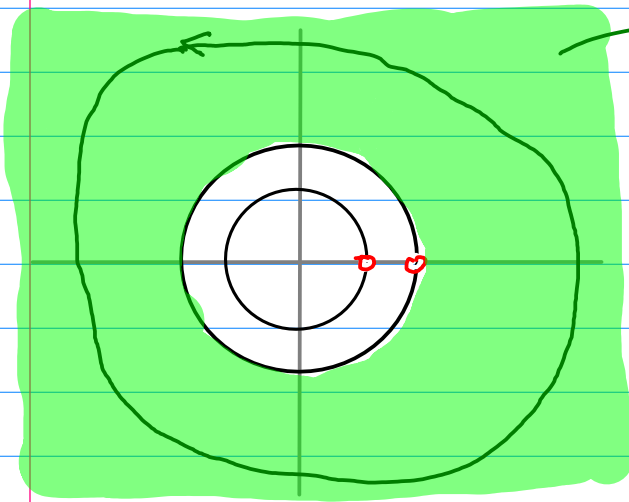

ROC (Region of Convergence)

$$|z| > 2 \Rightarrow \frac{2}{|z|} < 1$$

$$\left(\frac{2}{z}\right)^0 + \left(\frac{2}{z}\right)^1 + \left(\frac{2}{z}\right)^2 + \dots \longrightarrow \frac{1}{1 - \frac{2}{z}}$$

Converge

$$|z| > 2 \Rightarrow \frac{1}{|z|} < 1$$

$$\left(\frac{1}{z}\right)^0 + \left(\frac{1}{z}\right)^1 + \left(\frac{1}{z}\right)^2 + \dots \longrightarrow \frac{1}{1 - \frac{1}{z}}$$

Converge

$$\begin{aligned} f(z) &= \frac{1}{z-1} - \frac{1}{z-2} = \frac{1}{z} \frac{1}{1 - (\frac{1}{z})} - \frac{1}{z} \frac{1}{1 - (\frac{2}{z})} \\ &= \sum_{n=0}^{\infty} \frac{1}{z^{n+1}} - \sum_{n=0}^{\infty} \frac{2^n}{z^{n+1}} = \sum_{n=0}^{\infty} \frac{1 - 2^n}{z^{n+1}} \\ &= \sum_{n=1}^{\infty} \frac{1 - 2^{n-1}}{z^n} \end{aligned}$$

$$\left(\frac{1}{z}\right) + \left(\frac{1}{z}\right)^2 + \left(\frac{1}{z}\right)^3 + \dots + \frac{1}{z} \left\{ \left(\frac{2}{z}\right) + \left(\frac{2}{z}\right)^2 + \left(\frac{2}{z}\right)^3 + \dots \right\} \longrightarrow \frac{1}{z-1} - \frac{1}{z-2} = \frac{-1}{(z-1)(z-2)}$$

Converge

$$(1-2^0)z^{-1} + (1-2^1)z^{-2} + (1-2^2)z^{-3} + \dots \longrightarrow \frac{-1}{(z-1)(z-2)} \quad (|z| > 2)$$

Converge

$$x[n] = 1 - 2^n \quad \longleftrightarrow \quad X(z) = \frac{-1}{(z-1)(z-2)} \quad (|z| > 2)$$





