

Laurent Series and z-Transform

- Geometric Series

Permutations B

20240910 Tue

Copyright (c) 2024 - 2016 Young W. Lim.

Permission is granted to copy, distribute and/or modify this document under the terms of the GNU Free Documentation License, Version 1.2 or any later version published by the Free Software Foundation; with no Invariant Sections, no Front-Cover Texts, and no Back-Cover Texts. A copy of the license is included in the section entitled "GNU Free Documentation License".

a^n \times $R(n)$

a^n	a^{-n}

 \times

$u(n)$	$u(-n-1)$
$u(-n)$	$u(n-1)$

(1)	$a^n u(n)$	$a^{-n} u(n)$	(2)
(3)	$a^n u(-n)$	$a^{-n} u(-n)$	(4)
(5)	$a^n u(-n-1)$	$a^{-n} u(-n-1)$	(6)
(7)	$a^n u(n-1)$	$a^{-n} u(n-1)$	(8)

Exponent Shifting

	$shl(b^n)$
b^n	b^{n+1}
a^n	$a^{(n+1)}$
a^{-n}	$a^{-(n+1)}$

	$shr(b^n)$
b^n	b^{n-1}
a^n	$a^{(n-1)}$
a^{-n}	$a^{-(n-1)}$

Range Shifting

	$shl(R(n))$
$R(n)$	$R(n+1)$
$u(n-1)$	$u(n)$
$u(-n)$	$u(-(n+1))$

	$shr(R(n))$
$R(n)$	$R(n-1)$
$u(n)$	$u(n-1)$
$u(-(n+1))$	$u(-n)$

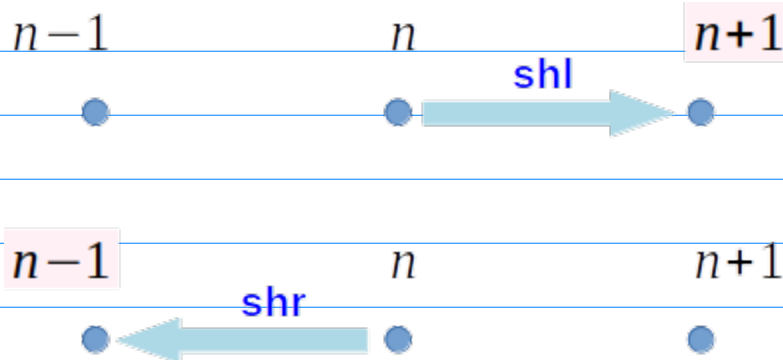

$$\begin{array}{ccc} b^n & \longleftrightarrow & b^{n+1} \\ R(n) & \longleftrightarrow & R(n+1) \end{array}$$

$$\begin{array}{ccc} b^n & \longleftrightarrow & b^{-(n+1)} \\ R(n) & \longleftrightarrow & R(n+1) \end{array}$$

$$\begin{array}{ccc} b^n & \longleftrightarrow & b^{n-1} \\ R(n) & \longleftrightarrow & R(n-1) \end{array}$$

$$\begin{array}{ccc} b^n & \longleftrightarrow & b^{-(n-1)} \\ R(n) & \longleftrightarrow & R(n-1) \end{array}$$

Exponent Shifting

$$\text{shl}(b^n) = b^{n+1}$$

$$\text{shr}(b^n) = b^{n-1}$$

$$b^n \longleftrightarrow b^{n+1}$$

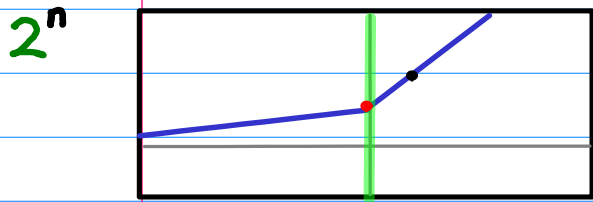

shift left
 $n \leftarrow n+1$

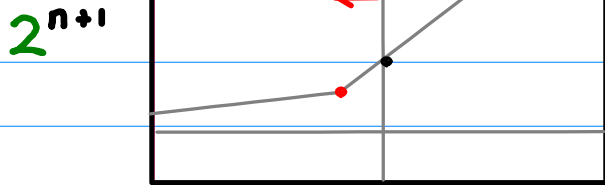

$$b^n \longleftrightarrow b^{-(n+1)}$$

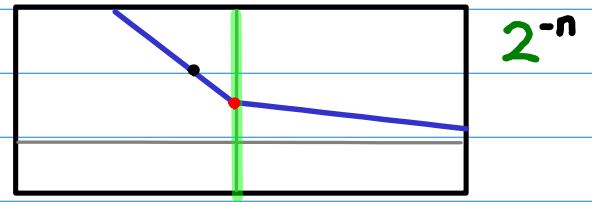

shift left
 $n \leftarrow n+1$

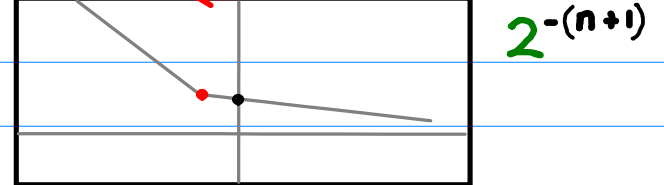

$$b^n \longleftrightarrow b^{n-1}$$

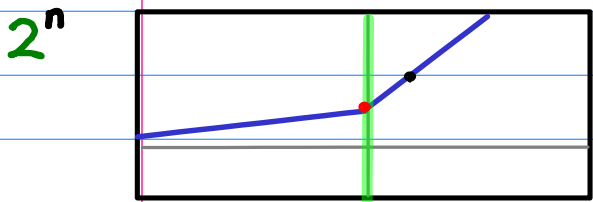

shift right
 $n \leftarrow n-1$

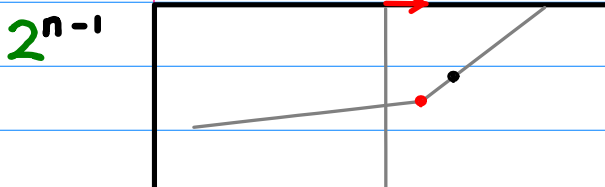

$$b^n \longleftrightarrow b^{-(n-1)}$$

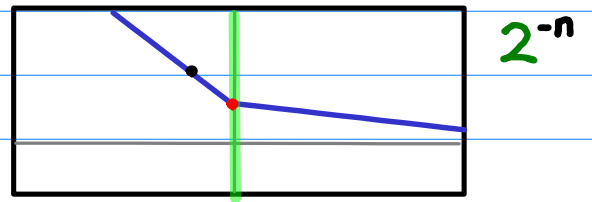

shift right
 $n \leftarrow n-1$

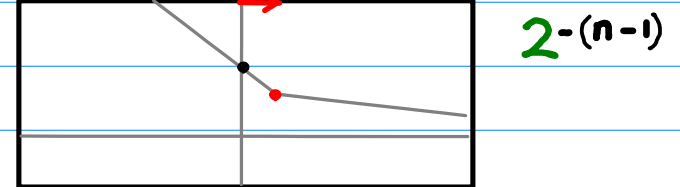

Range Shifting

$$\text{shl}(R(n)) = R(n+1)$$

$$\text{shr}(R(n)) = R(n-1)$$

$R(n) \longleftrightarrow R(n+1)$

$R(n) \longleftrightarrow R(n+1)$

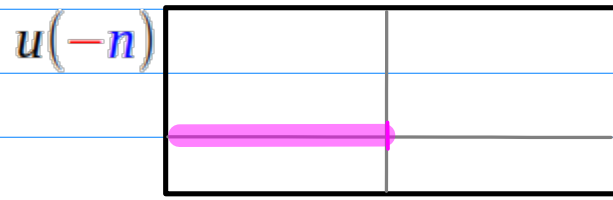
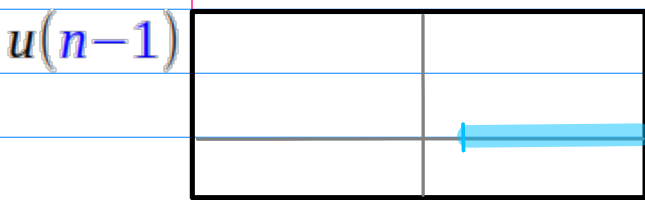

shift left
 $n \leftarrow n+1$

shift left
 $n \leftarrow n+1$

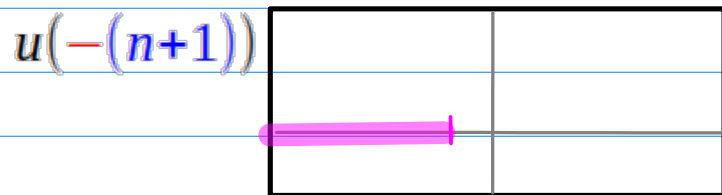

$R(n) \longleftrightarrow R(n-1)$

$R(n) \longleftrightarrow R(n-1)$

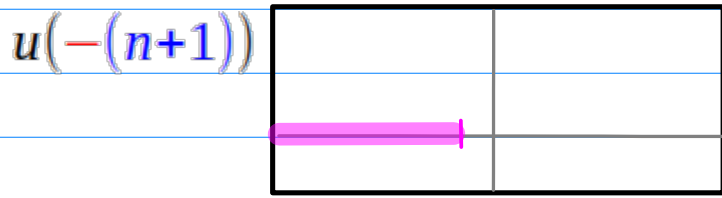
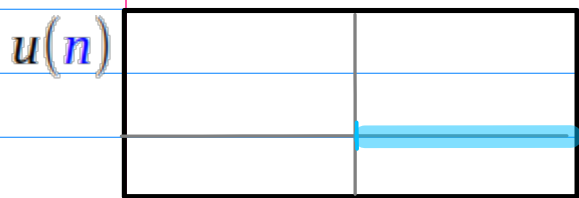

shift right
 $n \leftarrow n-1$

shift right
 $n \leftarrow n-1$

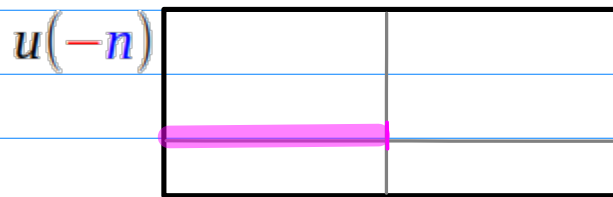
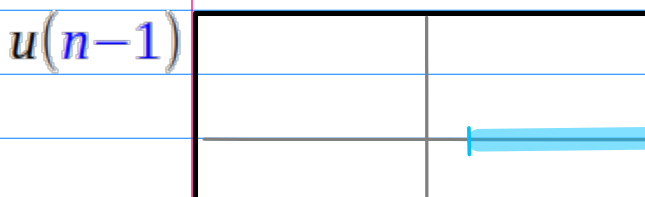

a^n \times $R(n)$

a^{n+1}	a^{-n-1}
a^{n-1}	a^{-n+1}

 \times

$u(n)$	$u(-n-1)$
$u(-n)$	$u(n-1)$

(1')	$a^{n+1}u(n)$	$a^{-n-1}u(n)$	(2')
(3')	$a^{n-1}u(-n)$	$a^{-n+1}u(-n)$	(4')
(5')	$a^{n+1}u(-n-1)$	$a^{-n-1}u(-n-1)$	(6')
(7')	$a^{n-1}u(n-1)$	$a^{-n+1}u(n-1)$	(8')

(1'')	$a^{n-1}u(n)$	$a^{-n+1}u(n)$	(2'')
(3'')	$a^{n+1}u(-n)$	$a^{-n-1}u(-n)$	(4'')
(5'')	$a^{n-1}u(-n-1)$	$a^{-n+1}u(-n-1)$	(6'')
(7'')	$a^{n+1}u(n-1)$	$a^{-n-1}u(n-1)$	(8'')

a^n \times $R(n)$

a^{n+1}	a^{-n-1}

 \times

$u(n)$	$u(-n-1)$
$u(-n)$	$u(n-1)$

$$(1') \quad a^{n+1} u(n) \quad a^{-n-1} u(n) \quad (2')$$

$$(3') \quad a^{n-1} u(-n) \quad a^{-n+1} u(-n) \quad (4')$$

$$(5') \quad a^{n+1} u(-n-1) \quad a^{-n-1} u(-n-1) \quad (6')$$

$$(7') \quad a^{n-1} u(n-1) \quad a^{-n+1} u(n-1) \quad (8')$$

a^n \times $R(n)$

a^{n+1}	a^{-n-1}
a^{n-1}	a^{-n+1}

 \times

$u(n)$	$u(-n-1)$
$u(-n)$	$u(n-1)$

(1'')	$a^{n-1} u(n)$	$a^{-n+1} u(n)$	(2'')
(3'')	$a^{n+1} u(-n)$	$a^{-n-1} u(-n)$	(4'')
(5'')	$a^{n-1} u(-n-1)$	$a^{-n+1} u(-n-1)$	(6'')
(7'')	$a^{n+1} u(n-1)$	$a^{-n-1} u(n-1)$	(8'')

Unshifted Sequence x

Shifted Sequence 1 x'

Shifted Sequence 2 x''

(1) $a^n u(n)$

$shl(b^n) a^{n+i} u(n)$ (1')

$shr(b^n) a^{n-i} u(n)$ (1'')

(2) $a^{-n} u(n)$

$shl(b^n) a^{-n-i} u(n)$ (2')

$shr(b^n) a^{-n+i} u(n)$ (2'')

(3) $a^n u(-n)$

$shr(b^n) a^{n-i} u(-n)$ (3')

$shl(b^n) a^{n+i} u(-n)$ (3'')

(4) $a^{-n} u(-n)$

$shr(b^n) a^{-n+i} u(-n)$ (4')

$shl(b^n) a^{-n-i} u(-n)$ (4'')

(5) $a^n u(-n-1)$

$shl(b^n) a^{n+i} u(-n-1)$ (5')

$shr(b^n) a^{n-i} u(-n-1)$ (5'')

(6) $a^{-n} u(-n-1)$

$shl(b^n) a^{-n-i} u(-n-1)$ (6')

$shr(b^n) a^{-n+i} u(-n-1)$ (6'')

(7) $a^n u(n-1)$

$shr(b^n) a^{n-i} u(n-1)$ (7')

$shl(b^n) a^{n+i} u(n-1)$ (7'')

(8) $a^{-n} u(n-1)$

$shr(b^n) a^{-n+i} u(n-1)$ (8')

$shl(b^n) a^{-n-i} u(n-1)$ (8'')

many possible permutations are possible
but consider these two

Unshifted Sequence x



Shifted Sequence $1 x'$

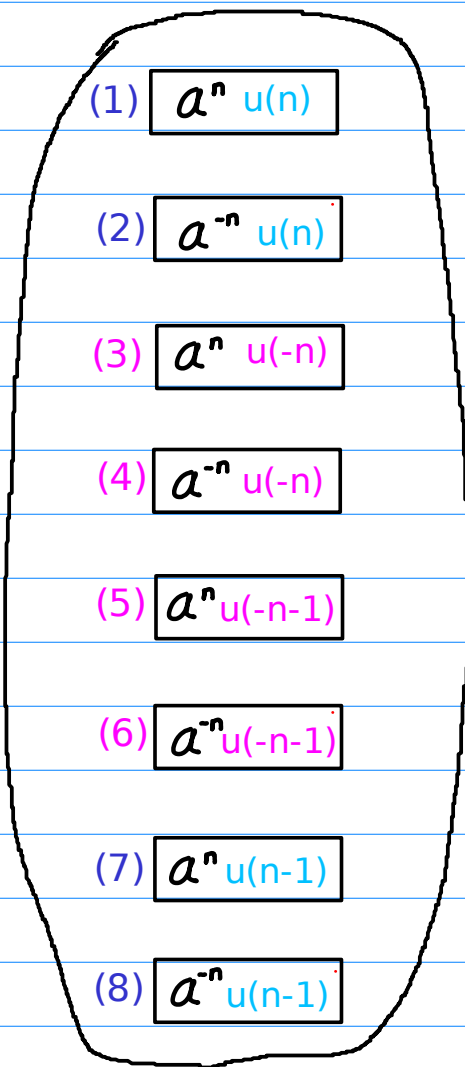

$shl(b^n)$

$a^{n+1} u(n)$ (1')

$shl(b^n)$

$a^{-n-1} u(n)$ (2')

$shr(b^n)$

$a^{n-1} u(-n)$ (3')

$shr(b^n)$

$a^{-n+1} u(-n)$ (4')

$shl(b^n)$

$a^{n+1} u(-n-1)$ (5')

$shl(b^n)$

$a^{-n-1} u(-n-1)$ (6')

$shr(b^n)$

$a^{n-1} u(n-1)$ (7')

$shr(b^n)$

$a^{-n+1} u(n-1)$ (8')

Inter-permutations over unshifted sequence and shifted sequence

Intra-permutations over unshifted sequence

Intra-permutations over shifted sequence

**Unshifted
Sequence x**



**Shifted
Sequence 2 x''**

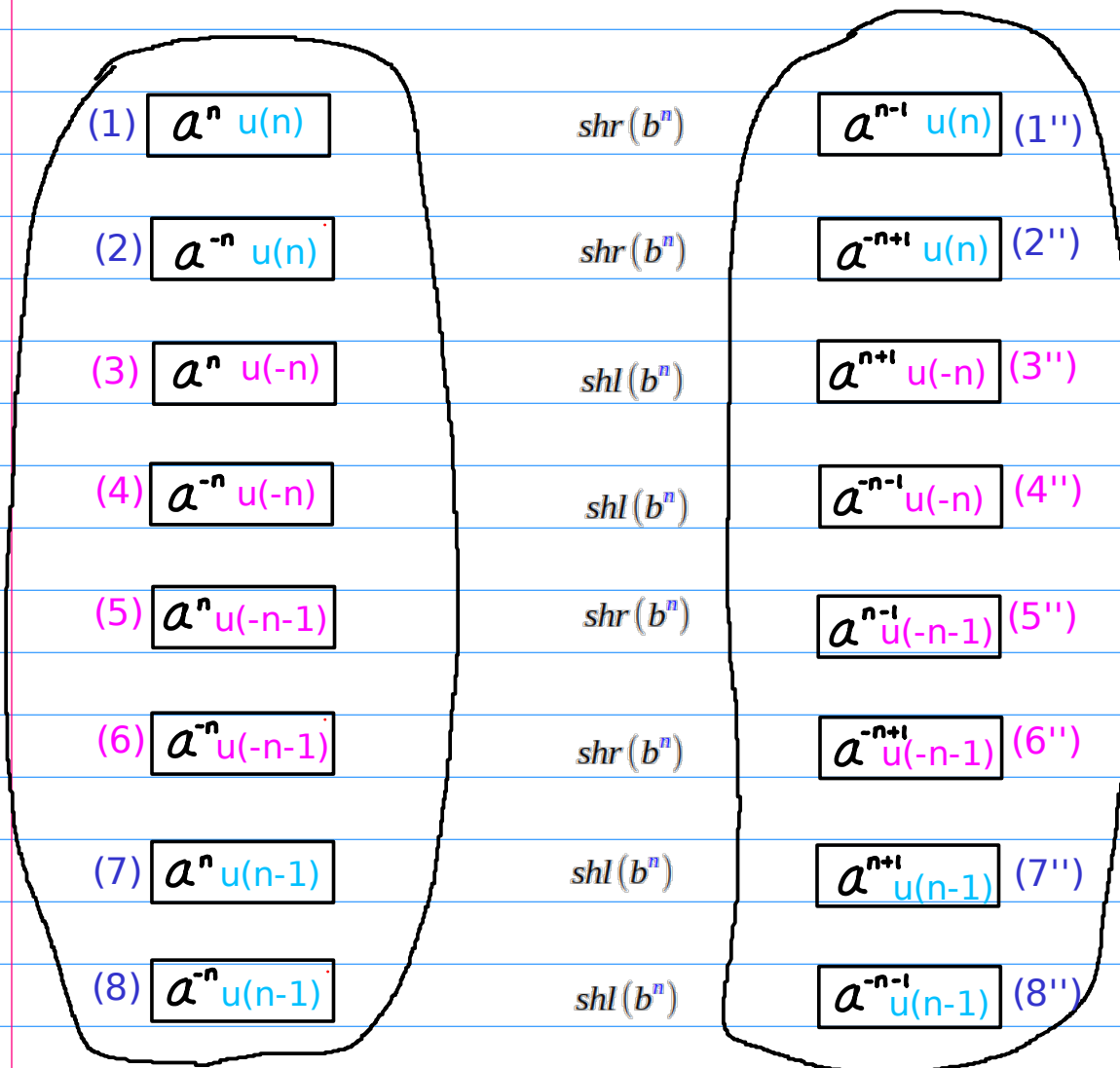

Inter-permutations over unshifted sequence and shifted sequence

Intra-permutations over unshifted sequence

Intra-permutations over shifted sequence

(1) - (1')
(7) - (7')
(5) - (5')
(3) - (3')

(2) - (2')
(8) - (8')
(6) - (6')
(4) - (4')

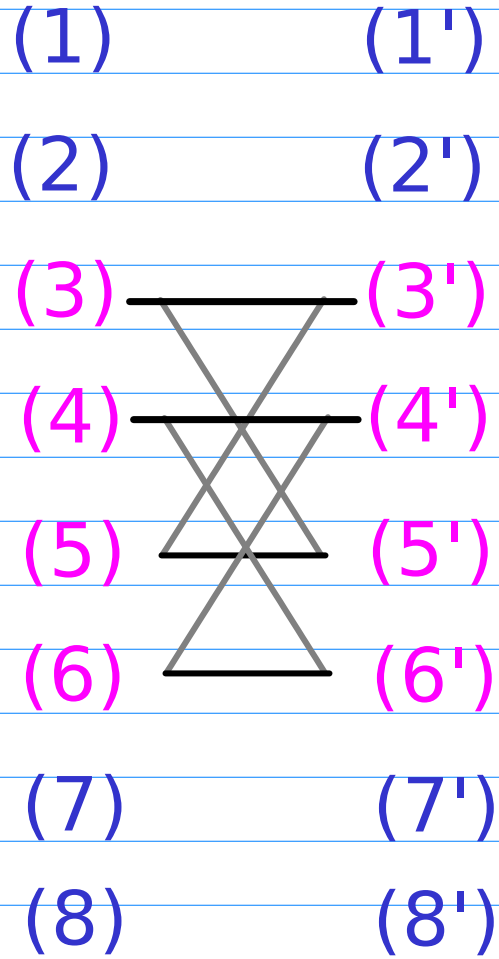
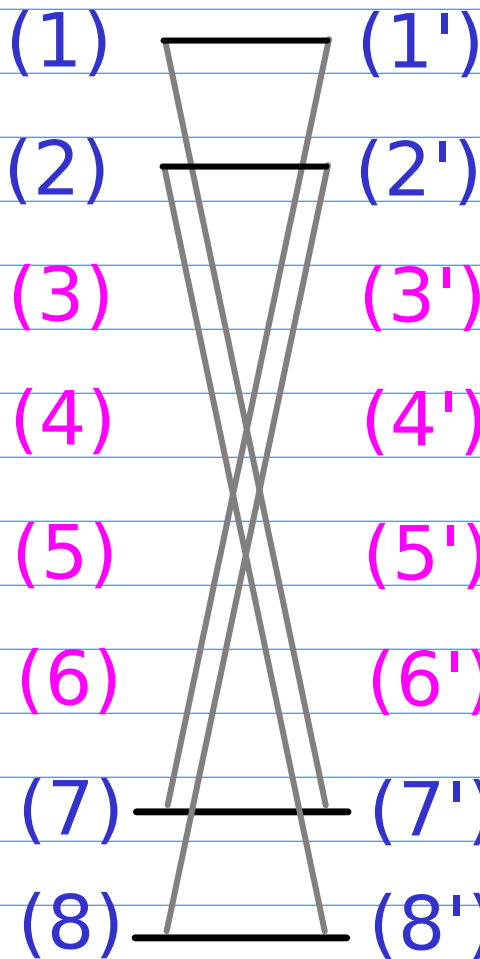
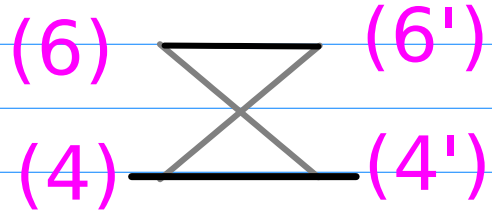
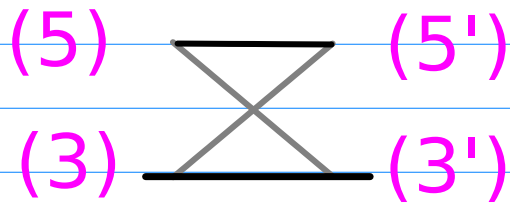
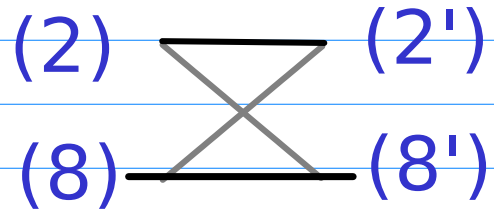
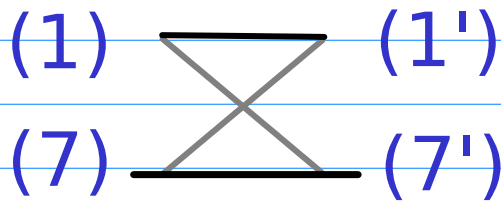

(x)  **(x')**
(1)~(8) (1')~(8')





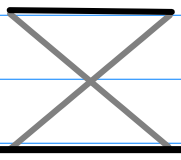

(1) - (1')
(7) - (7')
(5) - (5')
(3) - (3')

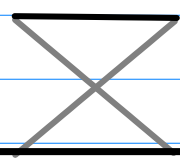

(2) - (2')
(8) - (8')
(6) - (6')
(4) - (4')

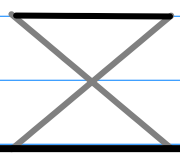

(x)  **(x'')**
(1)~(8) (1')~(8')



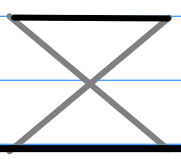

(1)  (1'')
(7)  (7'')

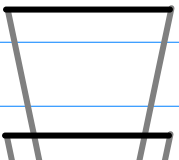
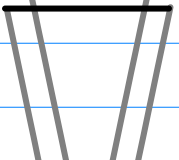
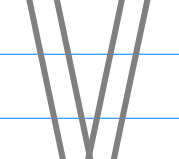
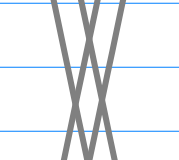
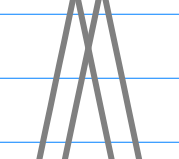
(2)  (2'')
(8)  (8'')

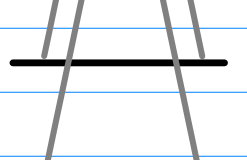
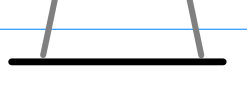
(5)  (5'')
(3)  (3'')

(6)  (6'')
(4)  (4'')

(1)  (1'')
(2)  (2'')
(3)  (3'')
(4)  (4'')
(5)  (5'')
(6)  (6'')
(7)  (7'')
(8)  (8'')

(1) (1'')
(2) (2'')
(3)  (3'')
(4)  (4'')
(5)  (5'')
(6)  (6'')
(7) (7'')
(8) (8'')

A Shifting Shifted Sequence 1

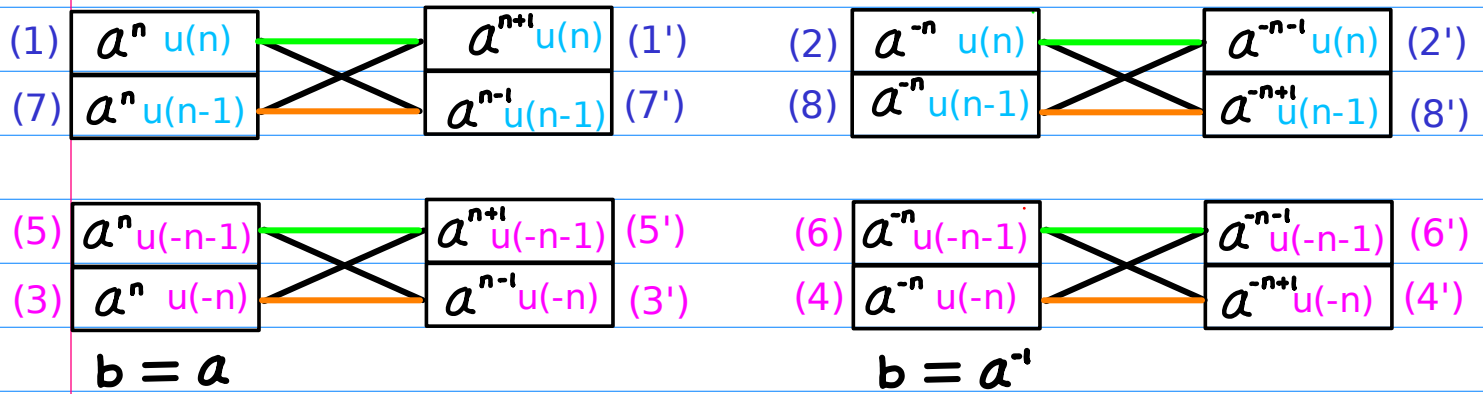

B Shifting Shifted Sequence 2

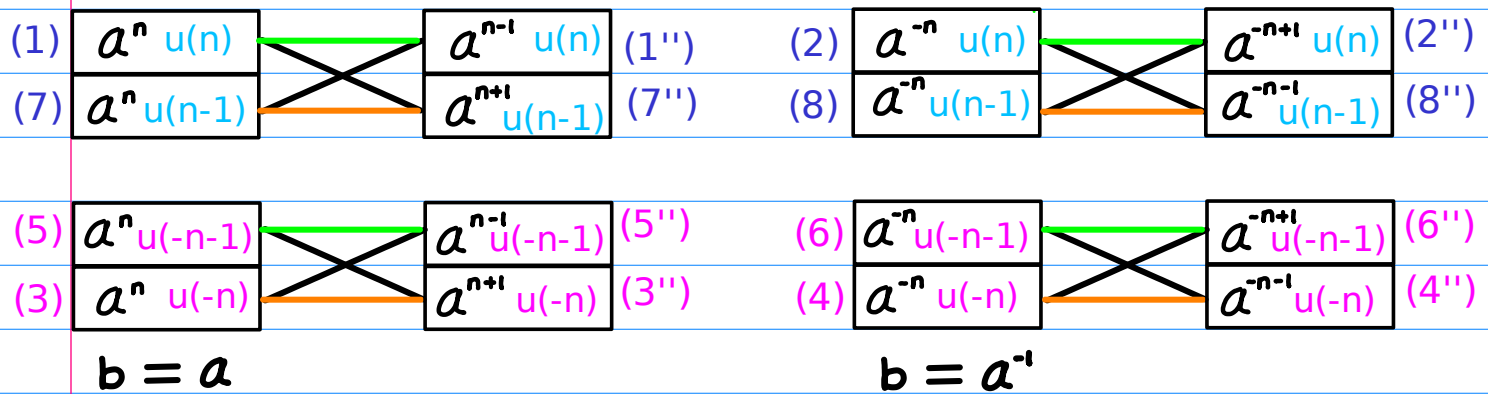

A Shifting Shifted Sequence 1

(1) Exponent Shifting
(2) Range Shifting

B Shifting Shifted Sequence 2

(1) Exponent Shifting
(2) Range Shifting

(1)/(2)
(7)/(8)

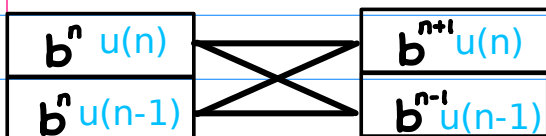

(1')/(2')
(7')/(8')

(1)/(2)
(7)/(8)

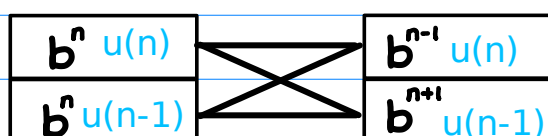

(1'')/(2'')
(7'')/(8'')

(5)/(6)
(3)/(4)

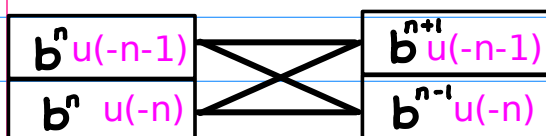

(5')/(6')
(3')/(4')

(5)/(6)
(3)/(4)

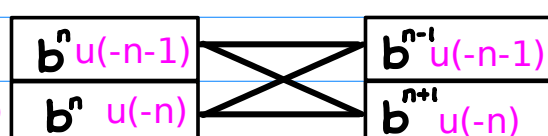

(5'')/(6'')
(3'')/(4'')

$$b = a/a^i$$

$$b = a/a^i$$

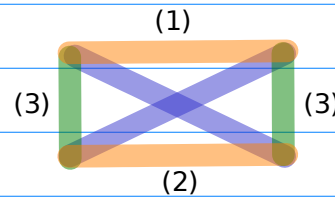
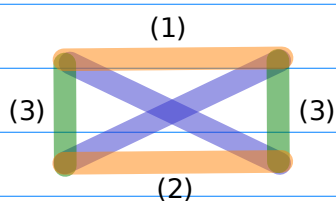

$$b^n \xleftrightarrow{(1)} b^{n+1}$$

$$b^n \xleftrightarrow{(1)} b^{n-1}$$

$$b^n \xleftrightarrow{(2)} b^{n-1}$$

$$b^n \xleftrightarrow{(2)} b^{n+1}$$

$$R(n) \xleftrightarrow{(3)} R(n-1)$$

$$R(n) \xleftrightarrow{(3)} R(n-1)$$

Exponent Shifting

b^n	$b^{sh(n)}$	
a^n	$a^{(n+1)}$	$shl(b^n)$
a^n	$a^{(n-1)}$	$shr(b^n)$
a^{-n}	$a^{-(n+1)}$	$shl(b^n)$
a^{-n}	$a^{-(n-1)}$	$shr(b^n)$

Exponent Shifting

b^n	$b^{sh(n)}$	
a^n	$a^{(n-1)}$	$shr(b^n)$
a^n	$a^{(n+1)}$	$shl(b^n)$
a^{-n}	$a^{-(n-1)}$	$shr(b^n)$
a^{-n}	$a^{-(n+1)}$	$shl(b^n)$

Range Shifting

$R(n)$	$R(sh(n))$	
$u(n)$	$u(n-1)$	$shr(R(n))$
$u(-(n+1))$	$u(-n)$	$shr(R(n))$

Range Shifting

$R(n)$	$R(sh(n))$	
$u(n)$	$u(n-1)$	$shr(R(n))$
$u(-(n+1))$	$u(-n)$	$shr(R(n))$

A Shifting Shifted Sequence 1

B Shifting Shifted Sequence 2

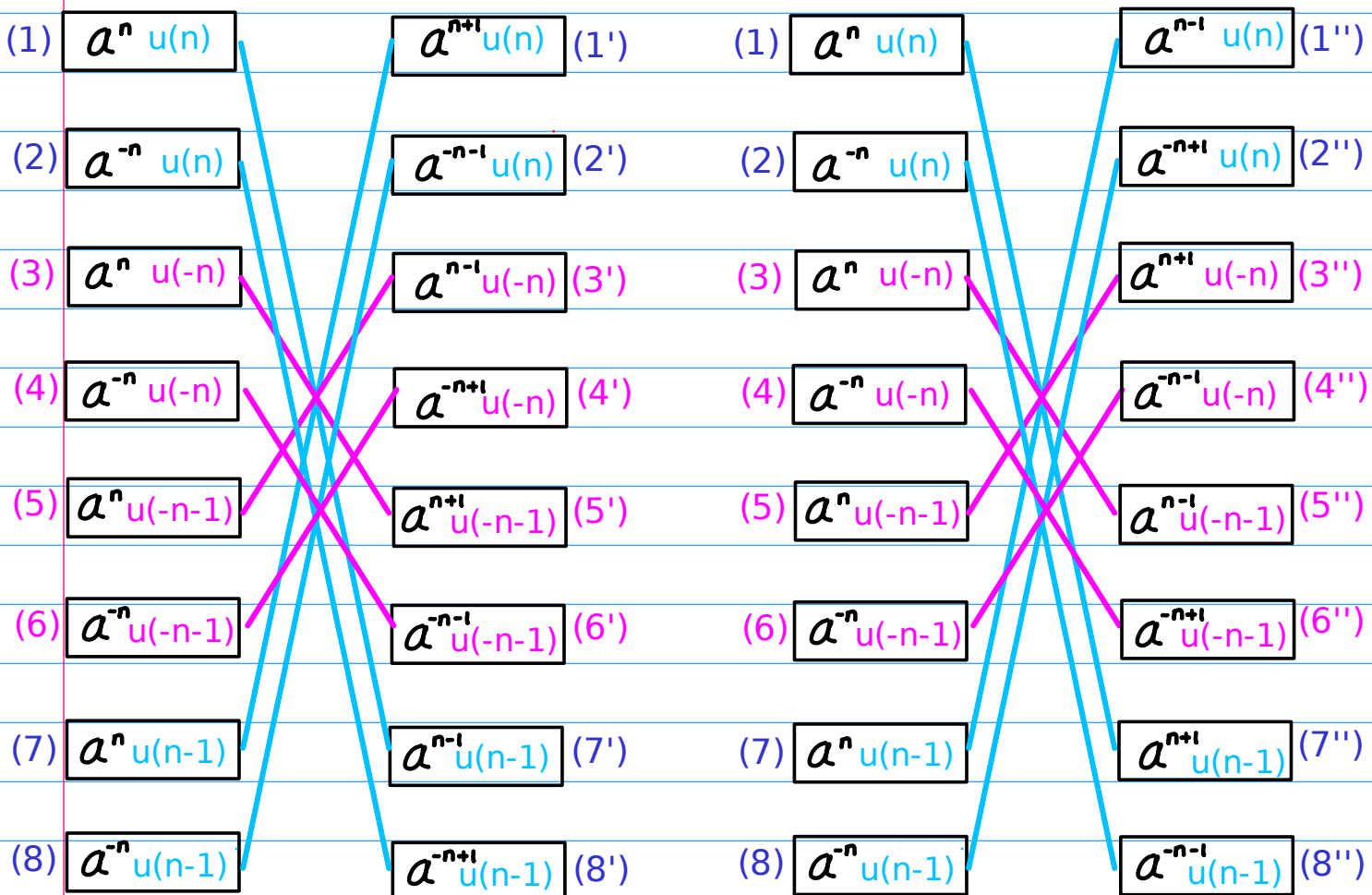
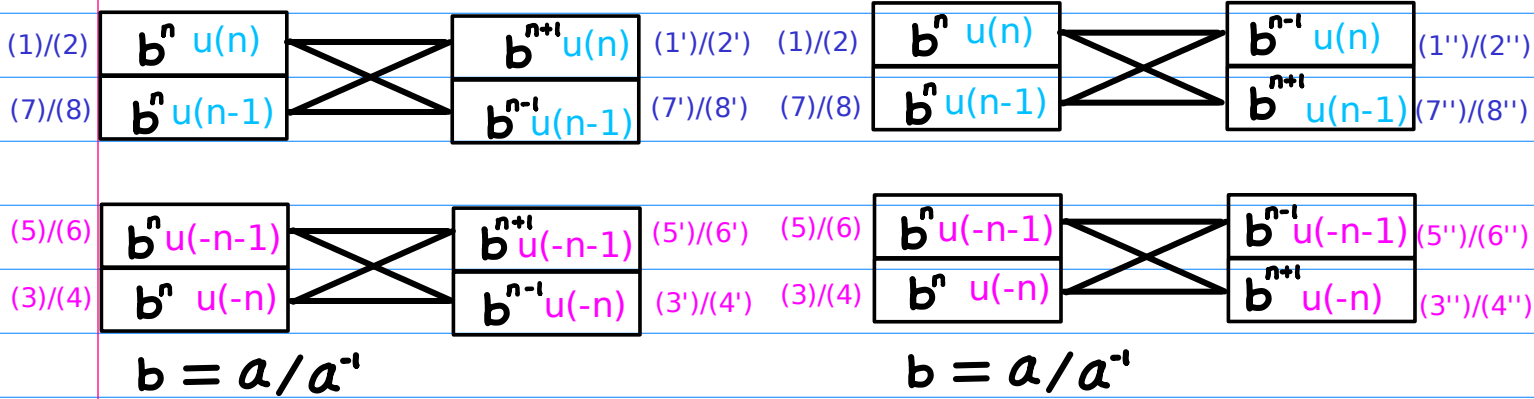

A Shifting Shifted Sequence 1

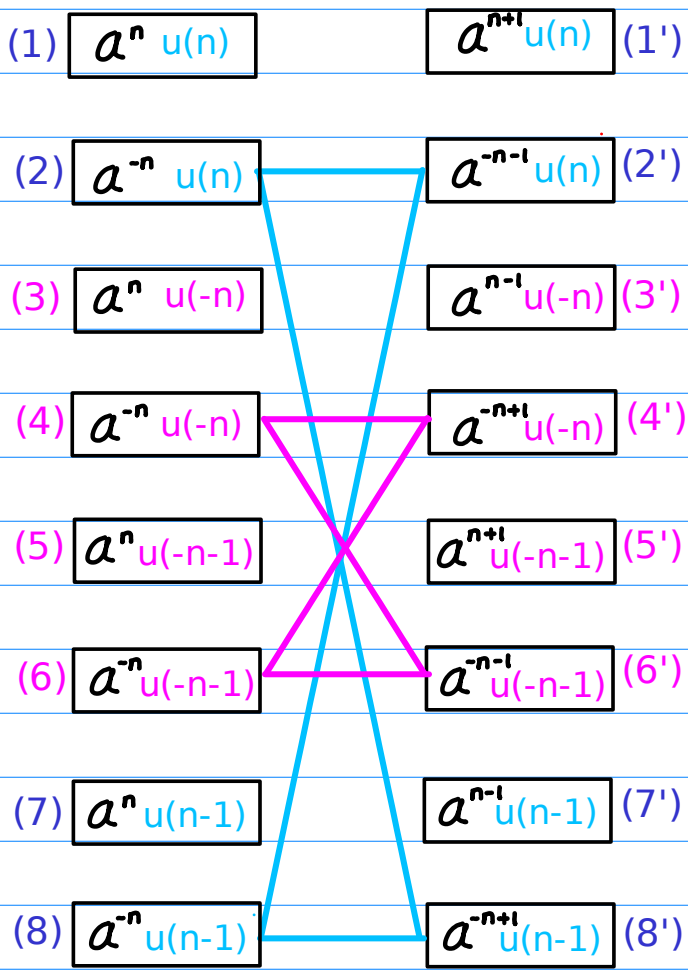
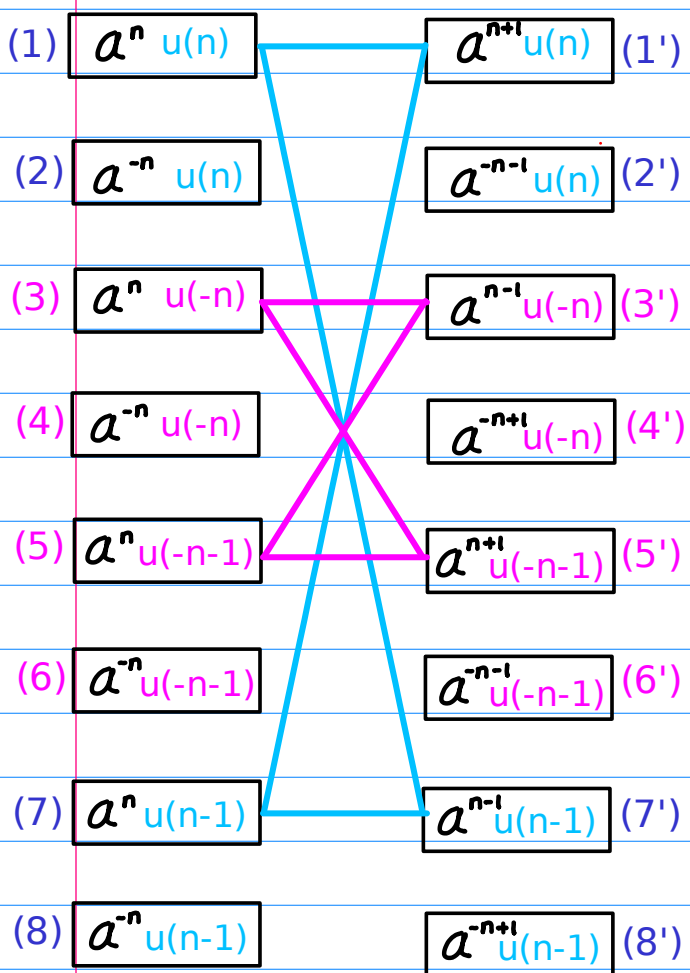
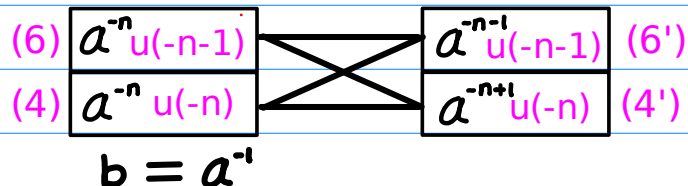
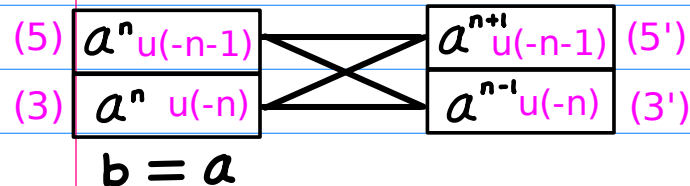
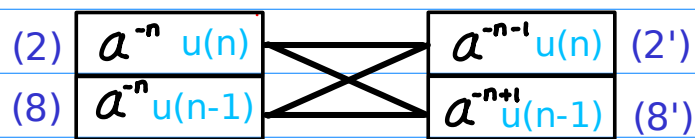
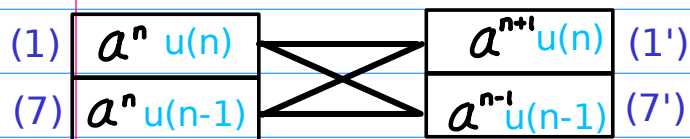

B Shifting Shifted Sequence 2

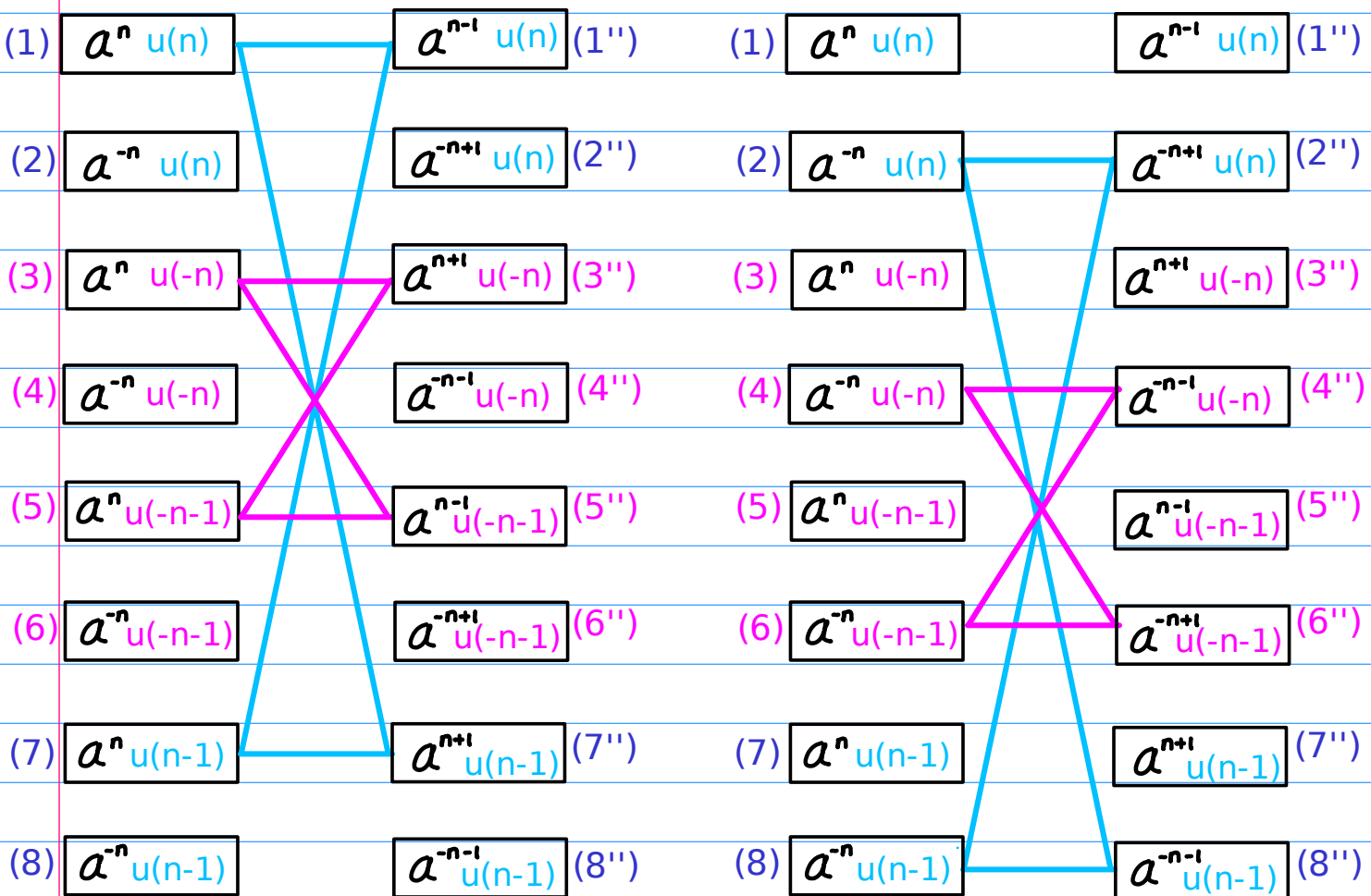
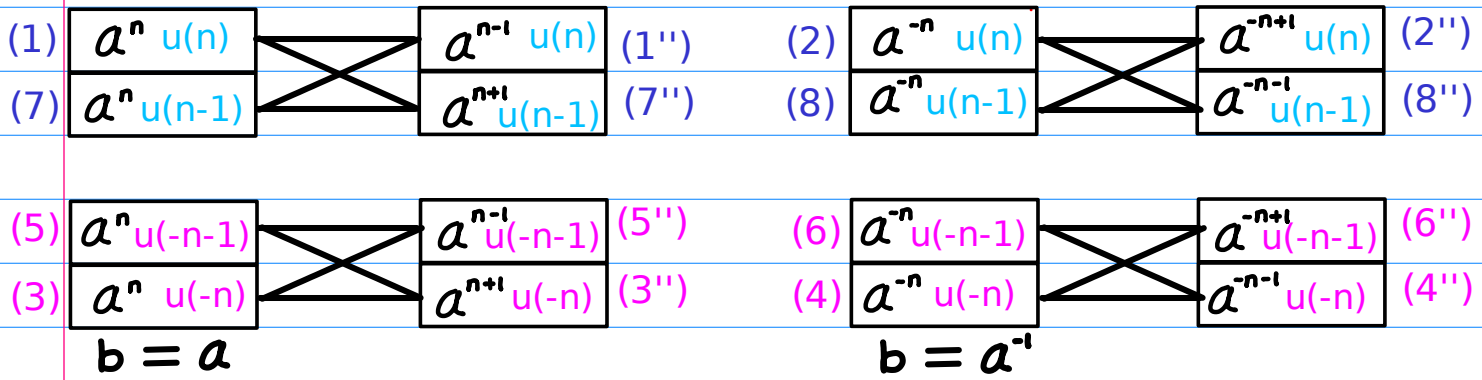

A Shifting Shifted Sequence 1

Unshifted Sequence x \rightarrow Shifted Sequence 1 x'

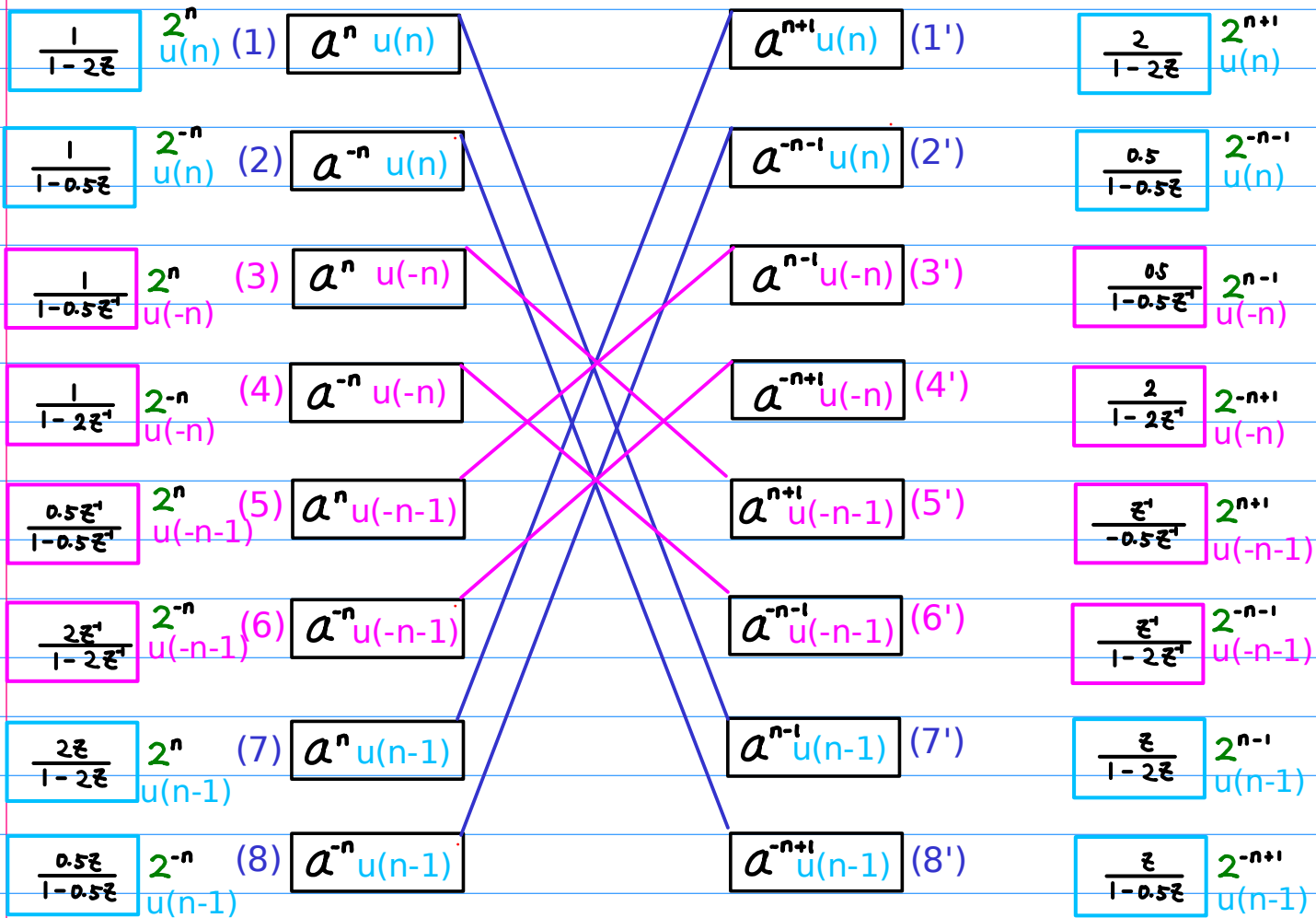
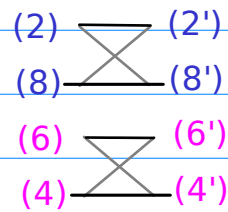
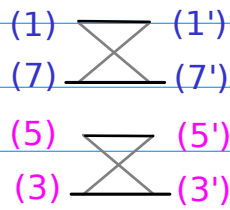

B Shifting Shifted Sequence 2

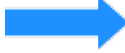
Unshifted Sequence x  Shifted Sequence 2 x''

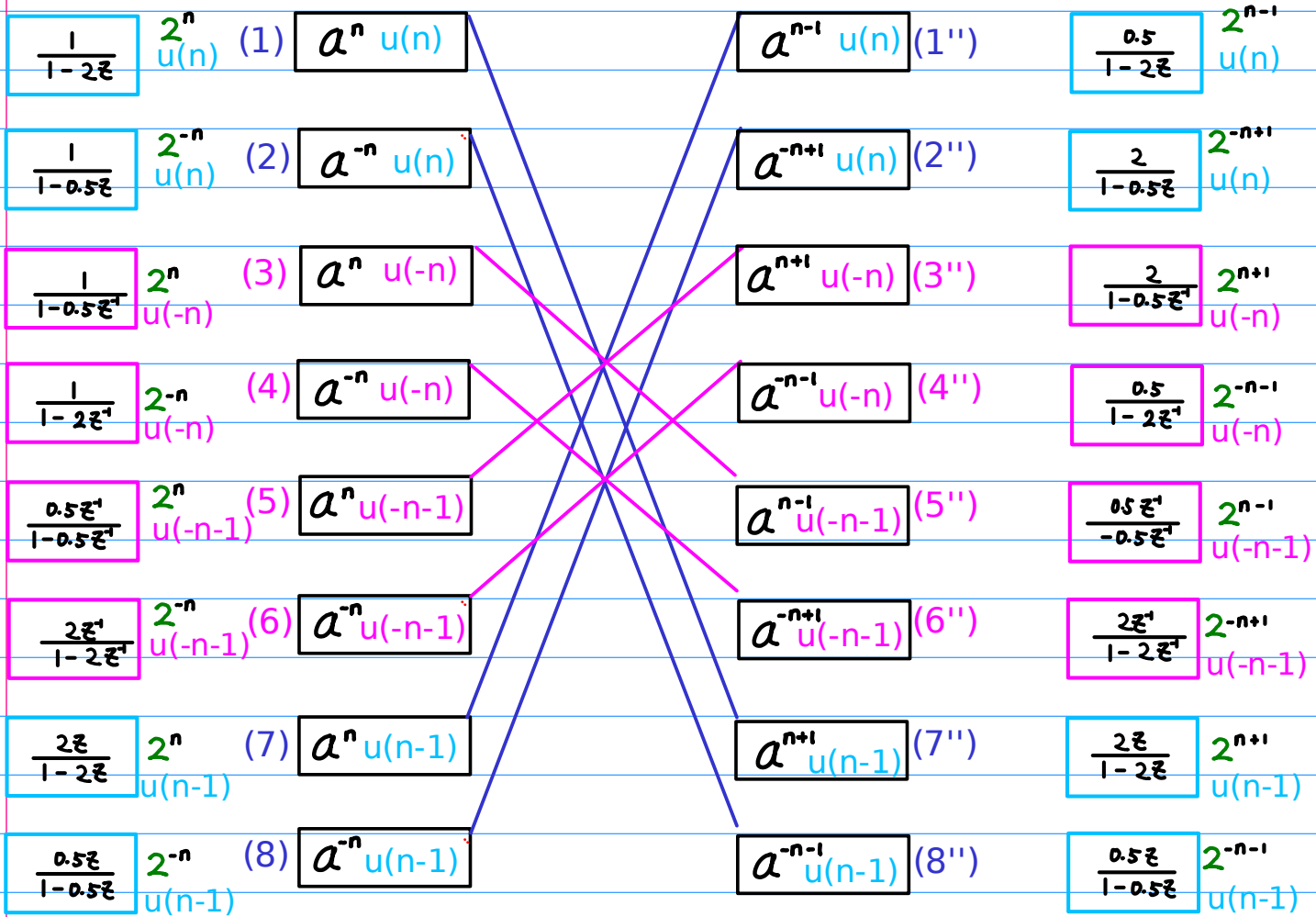
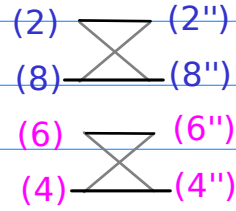
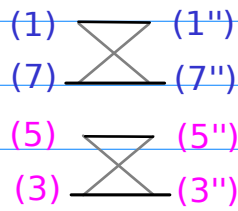

Inter-permutation

A Shifting Shifted Sequence 1

(x) \longrightarrow (x')

(1)~(8)

(1')~(8')

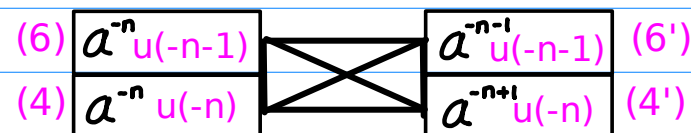
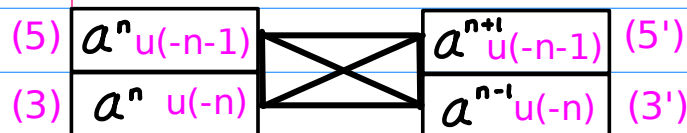
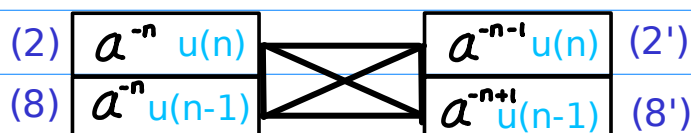
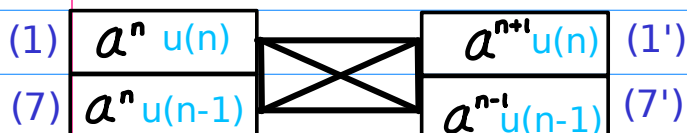
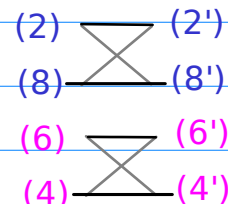
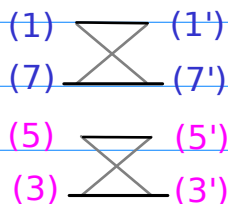
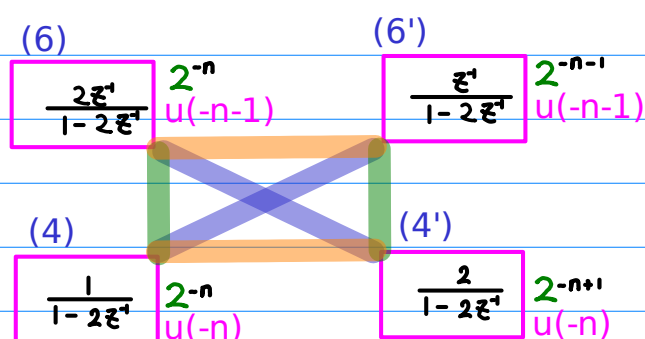
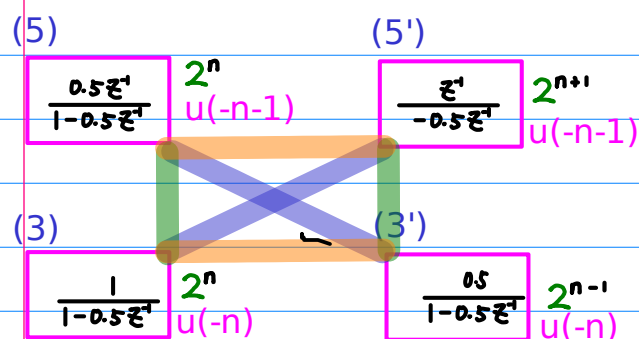
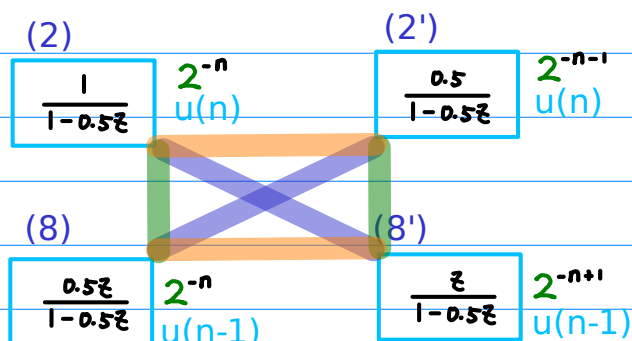
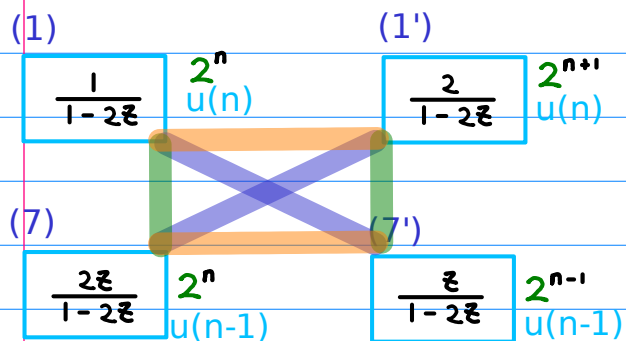

Inter-permutation

B Shifting Shifted Sequence 2

(x) \longrightarrow (x'')

(1)~(8) (1'')~(8'')

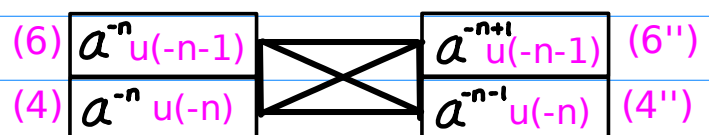
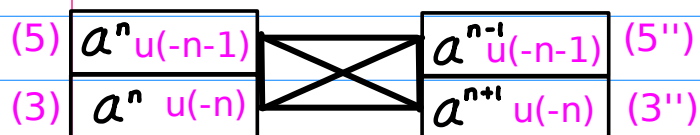
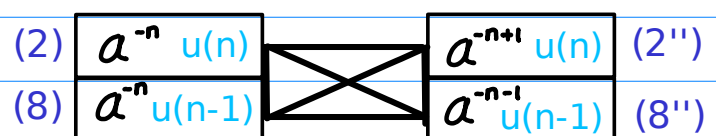
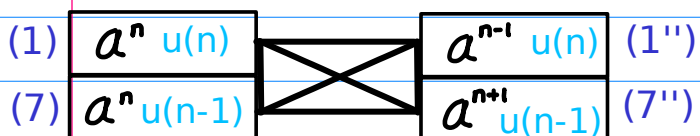
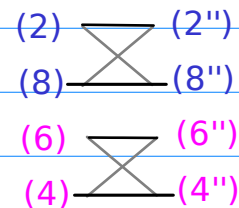
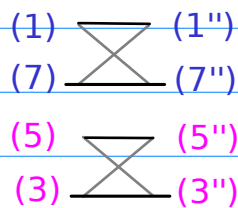
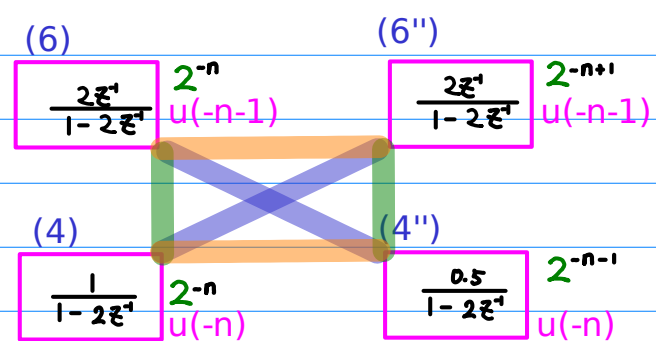
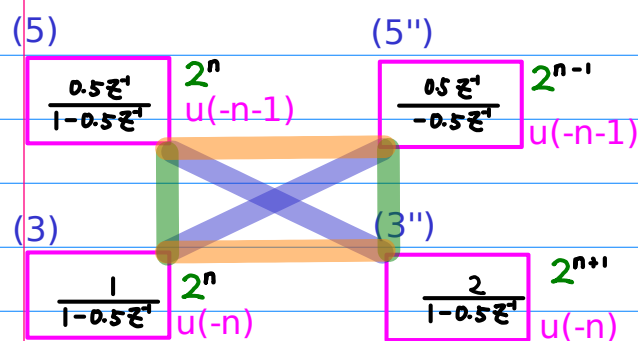
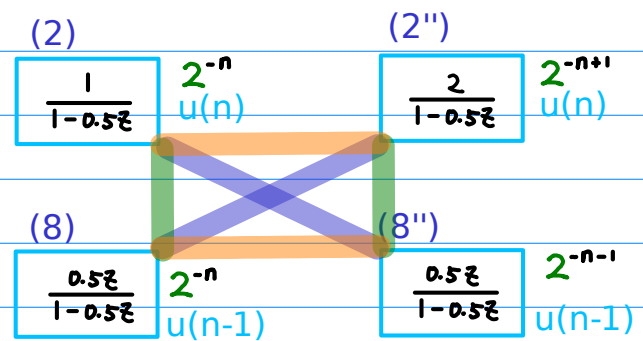
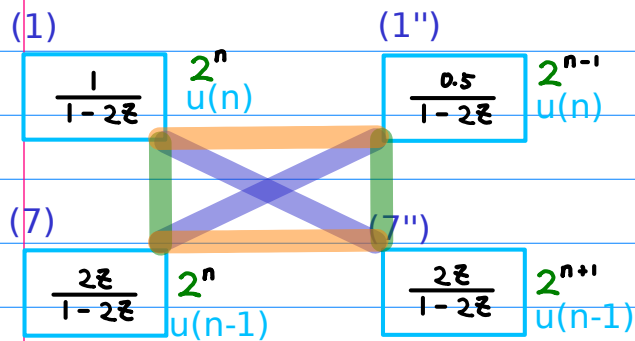

Decomposing Shift Operations

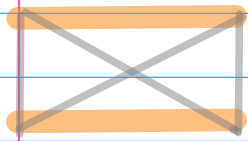

(exponent shift, identity)

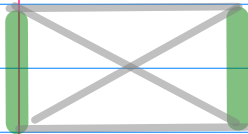

(identity, range shift)

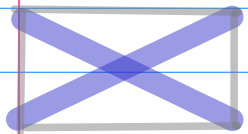

(exponent shift, range shift)
= (exponent shift, identity)
+ (identity, range shift)

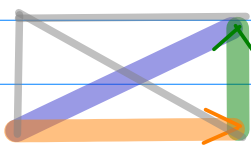
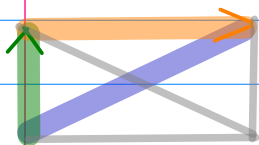
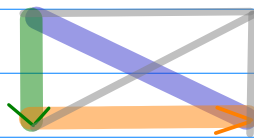
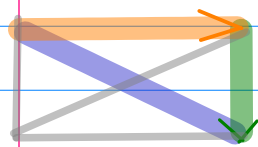

A Shifting Shifted Sequence 1
(1) Exponent Shifting
(2) Range Shifting

$$\begin{aligned}(\text{SR}, \text{id}) + (\text{id}, \text{SR}) &= (\text{SR}, \text{SR}) \\ (\text{SL}, \text{id}) + (\text{id}, \text{SL}) &= (\text{SL}, \text{SL})\end{aligned}$$

B Shifting Shifted Sequence 2
(1) Exponent Shifting, Flipping
(2) Range Shifting

$$\begin{aligned}(\text{SR}, \text{id}) + (\text{id}, \text{SL}) &= (\text{SR}, \text{SL}) \\ (\text{SL}, \text{id}) + (\text{id}, \text{SR}) &= (\text{SL}, \text{SR})\end{aligned}$$

A Shifting Shifted Sequence 1

(1) Exponent Shifting

(2) Range Shifting

(SR, id) or (SL, id)

(id, SR) or (id, SL)

Exponent Shifts : (SR, id) or (SL, id)

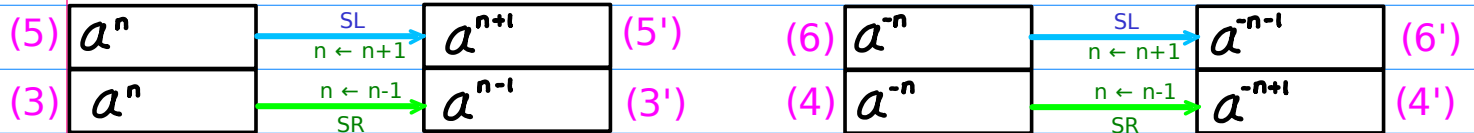
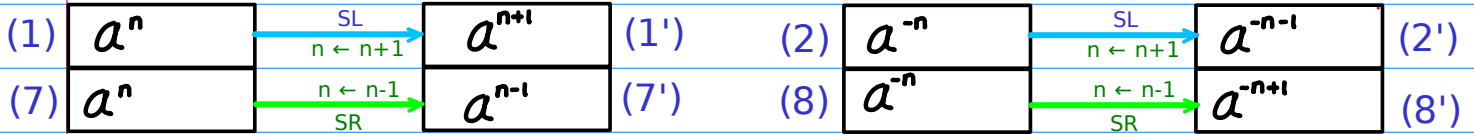

Range Shifts : (id, SR) or (id, SL)

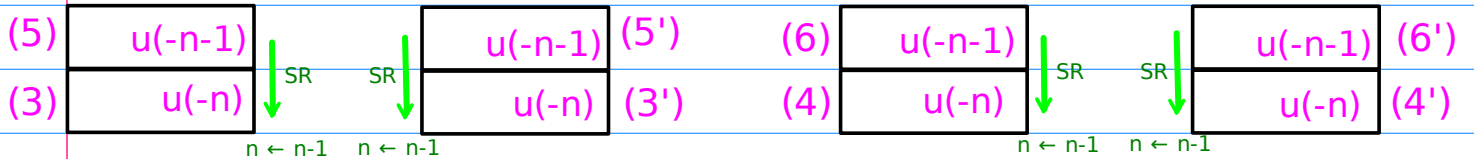
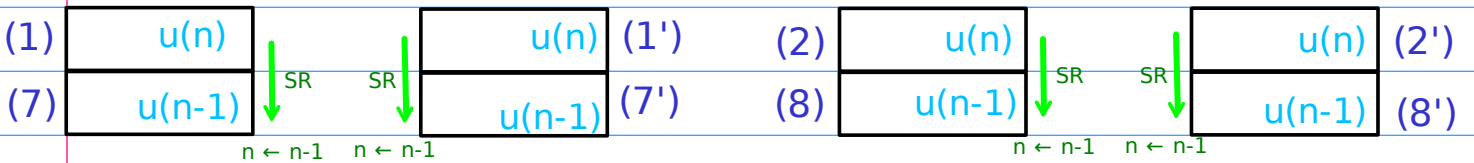

Exponent & Range Permutations

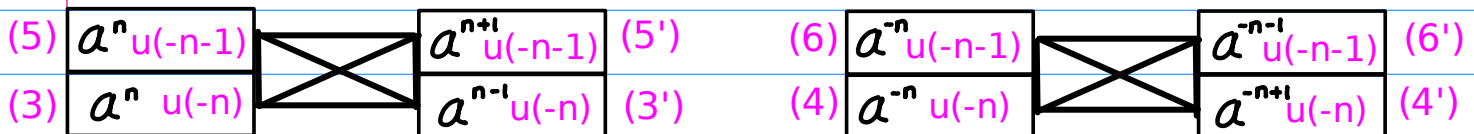
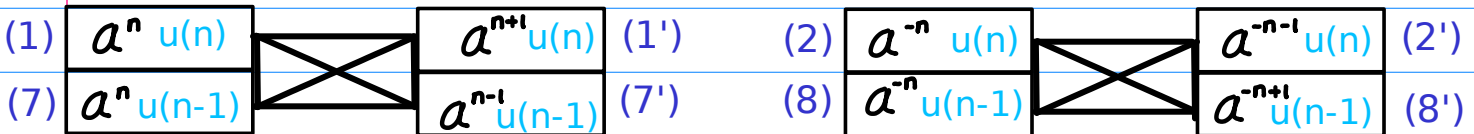

Decomposition

$$(EP, RP) = (EP, id) + (id, RP)$$

EP : Exponent Permutations

RP : Range Permutations

B Shifting Shifted Sequence 2

- (1) Exponent Shifting, Flipping (SR, id) or (SL, id)
 (2) Range Shifting (id, SR) or (id, SL)

Exponent Shifts : (SR, id) or (SL, id)

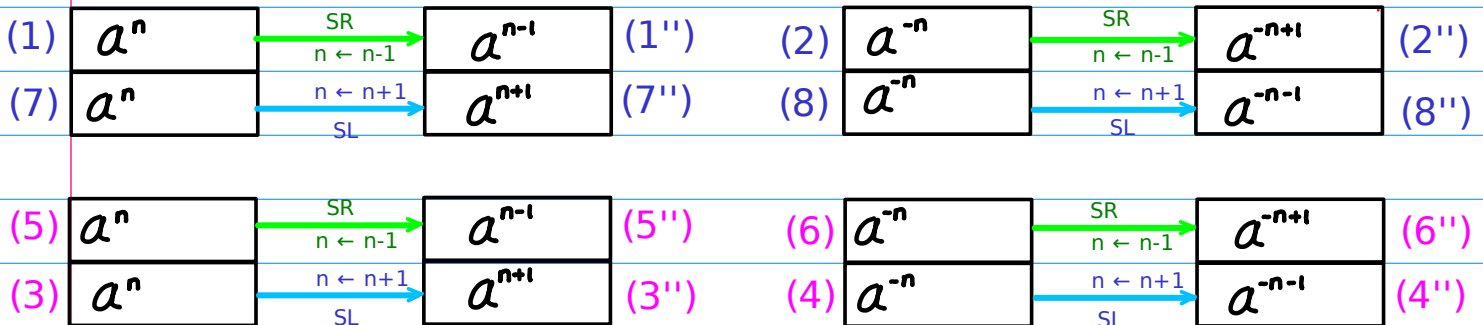

Range Shifts : (id, SR) or (id, SL)

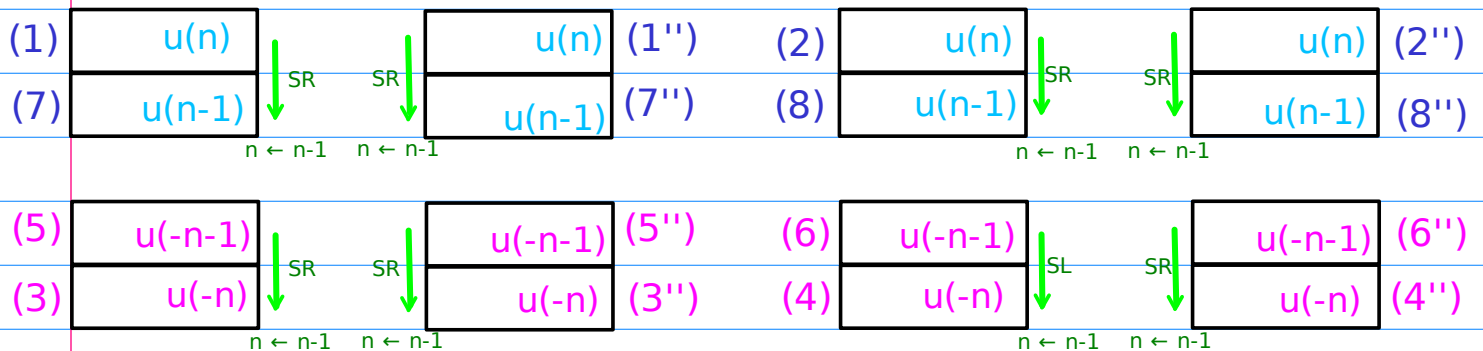

Exponent & Range Permutations

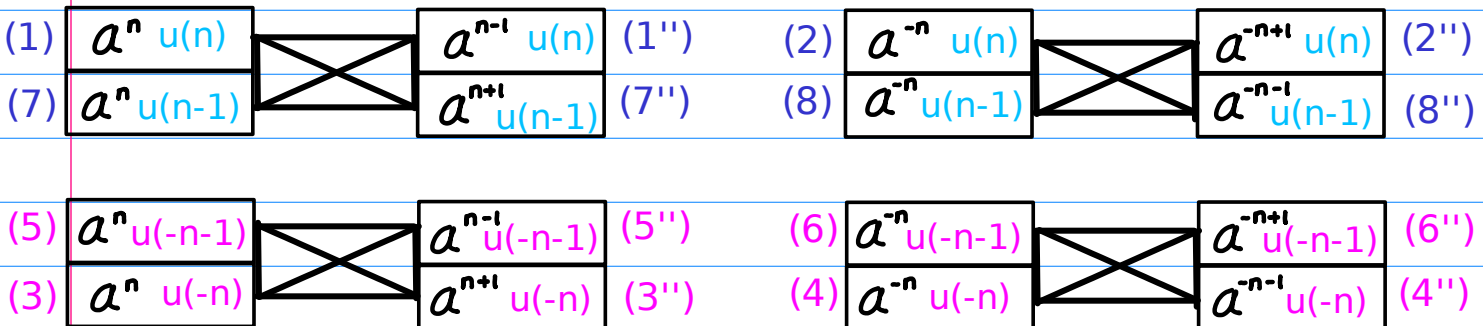

Decomposition

$$(EP, RP) = (EP, id) + (id, RP)$$

EP : Exponent Permutations

RP : Range Permutations

A Shifting Shifted Sequence 1

- (1) Exponent Shifting
- (2) Range Shifting

$$(SR, id) + (id, SR) = (SR, SR)$$

$$(SL, id) + (id, SL) = (SL, SL)$$

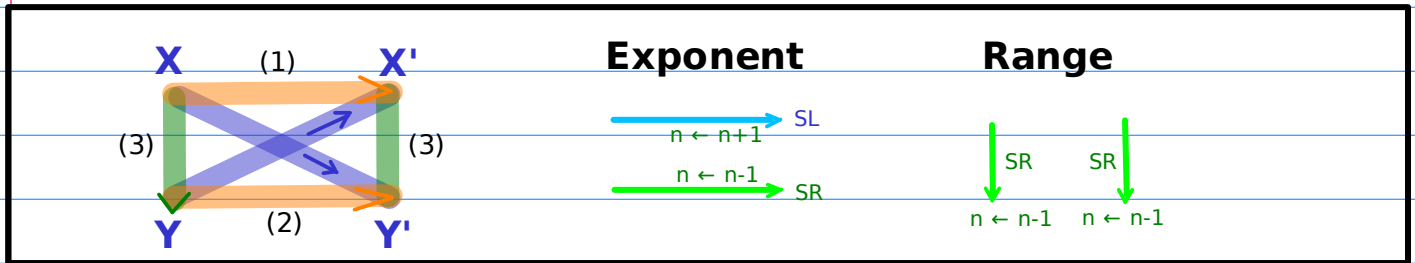
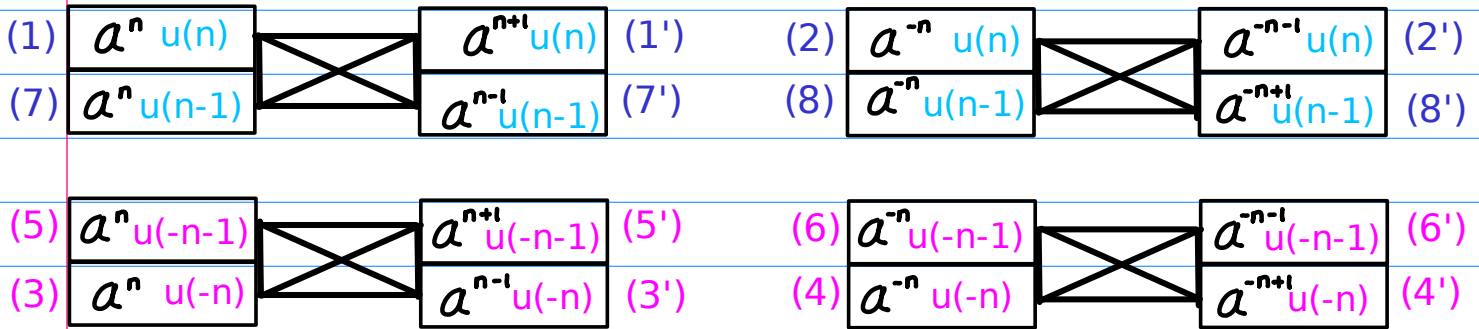

B Shifting Shifted Sequence 2

- (1) Exponent Shifting
- (2) Range Shifting

$$(SR, id) + (id, SL) = (SR, SL)$$

$$(SL, id) + (id, SR) = (SL, SR)$$

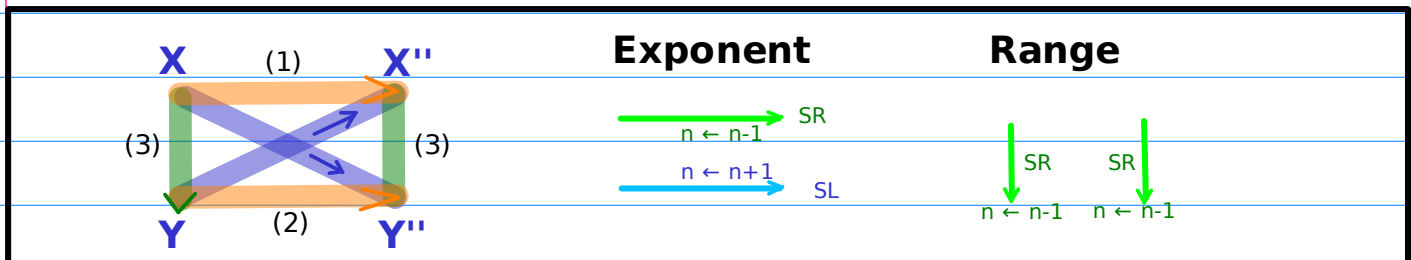
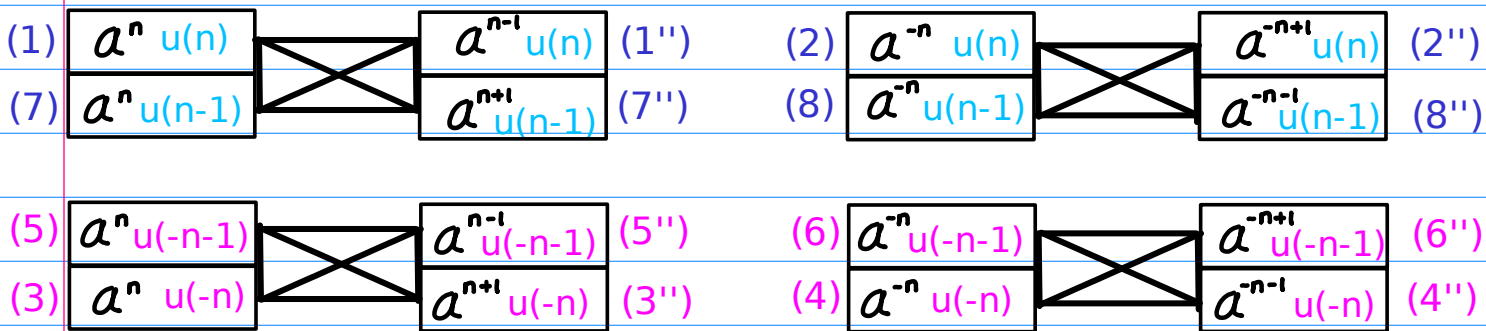

A Shifting Shifted Sequence 1

(1) Exponent Shifting

(2) Range Shifting

$$(SR, id) + (id, SR) = (SR, SR)$$

$$(SL, id) + (id, SL) = (SL, SL)$$

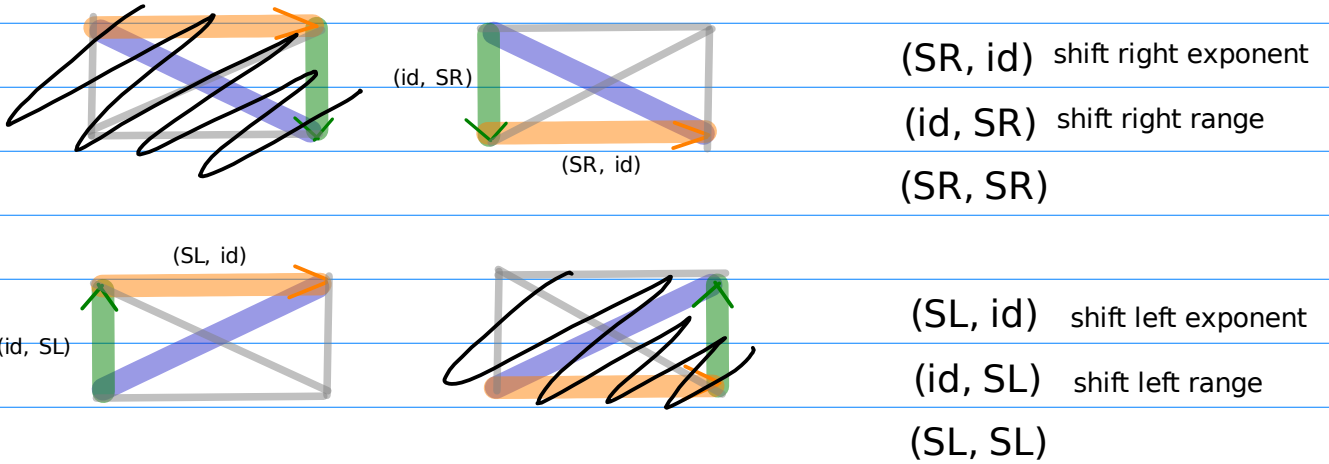
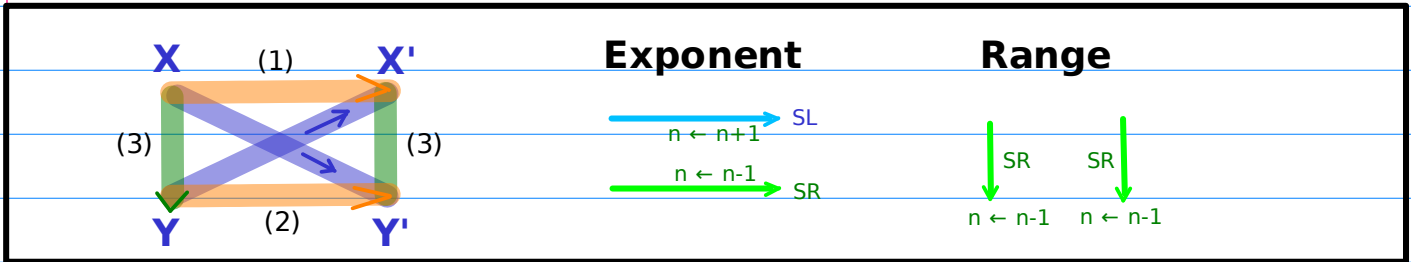
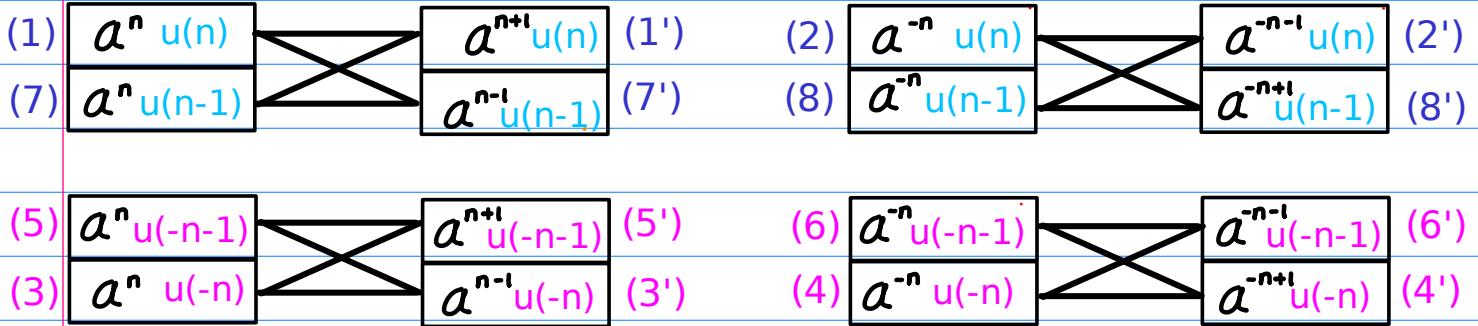

$$(SR, id) + (id, SR) = (SR, SR)$$

$$(SL, id) + (id, SL) = (SL, SL)$$

B Shifting Shifted Sequence 2

(1) Exponent Shifting

(2) Range Shifting

$$(SR, id) + (id, SL) = (SR, SL)$$

$$(SL, id) + (id, SR) = (SL, SR)$$

$$\begin{array}{|c|} \hline (1) \quad a^n u(n) \\ \hline (7) \quad a^n u(n-1) \\ \hline \end{array} \begin{array}{|c|} \hline \times \\ \hline \end{array} \begin{array}{|c|} \hline a^{n-1} u(n) \quad (1'') \\ \hline a^{n+1} u(n-1) \quad (7'') \\ \hline \end{array}$$

$$\begin{array}{|c|} \hline (2) \quad a^{-n} u(n) \\ \hline (8) \quad a^{-n} u(n-1) \\ \hline \end{array} \begin{array}{|c|} \hline \times \\ \hline \end{array} \begin{array}{|c|} \hline a^{-n+1} u(n) \quad (2'') \\ \hline a^{-n-1} u(n-1) \quad (8'') \\ \hline \end{array}$$

$$\begin{array}{|c|} \hline (5) \quad a^n u(-n-1) \\ \hline (3) \quad a^n u(-n) \\ \hline \end{array} \begin{array}{|c|} \hline \times \\ \hline \end{array} \begin{array}{|c|} \hline a^{n-1} u(-n-1) \quad (5'') \\ \hline a^{n+1} u(-n) \quad (3'') \\ \hline \end{array}$$

$$\begin{array}{|c|} \hline (6) \quad a^{-n} u(-n-1) \\ \hline (4) \quad a^{-n} u(-n) \\ \hline \end{array} \begin{array}{|c|} \hline \times \\ \hline \end{array} \begin{array}{|c|} \hline a^{-n+1} u(-n-1) \quad (6'') \\ \hline a^{-n-1} u(-n) \quad (4'') \\ \hline \end{array}$$

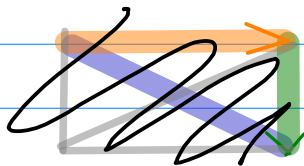
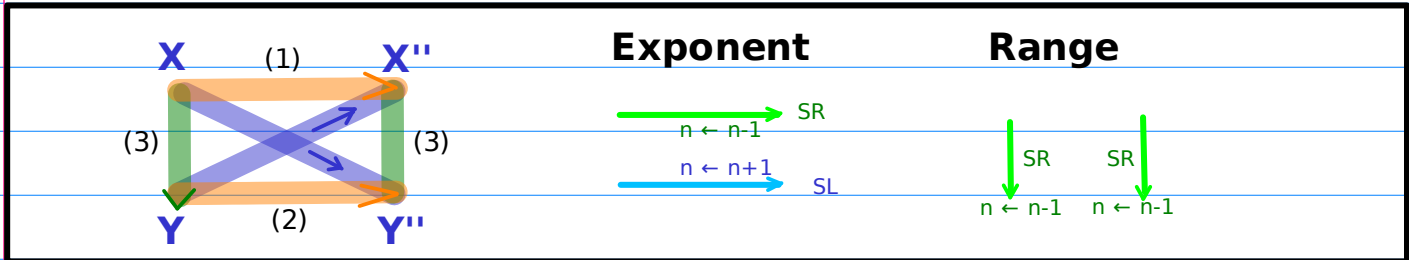

(id, SR)

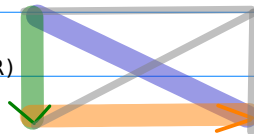

(SL, id)

(SL, id) shift right exponent

(id, SR) shift right range

(SL, SR)

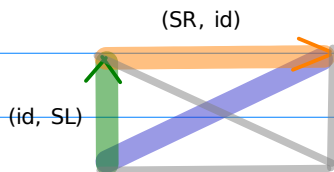

(SR, id)

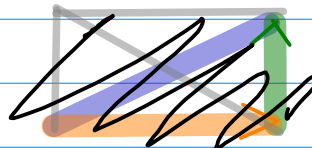

(SR, id) shift left exponent

(id, SL) shift left range

(SR, SL)

$$(SL, id) + (id, SR) = (SL, SR)$$

$$(SR, id) + (id, SL) = (SR, SL)$$



Butterfly Relations

A Shifting Shifted Sequence 1

Unshifted Sequence x \longrightarrow Shifted Sequence 1 x'

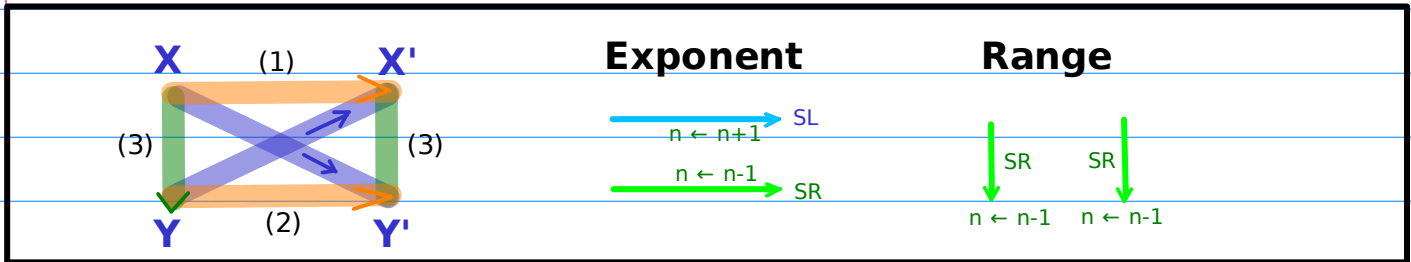

(*) unit starting

(1) $\xrightarrow{*a \leftarrow (SL, id)}$ (1') SL

$/z \leftarrow (SL, SL)$

C.R. starting

(7) $\xrightarrow{/a \rightarrow (SR, id)}$ (7') SR

$*z \Rightarrow (SR, SR)$

$/a \rightarrow (SR, id)$

(*) C.R. starting

(5) $\xrightarrow{*a \leftarrow (SL, id)}$ (5') SL

$/z \leftarrow (SL, SL)$

unit starting

(3) $\xrightarrow{/a \rightarrow (SR, id)}$ (3') SR

$*z \Rightarrow (SR, SR)$

$/a \rightarrow (SR, id)$

(*) unit starting

(2) $\xrightarrow{/a \leftarrow (SL, id)}$ (2') SL

$/z \leftarrow (SL, SL)$

C.R. starting

(8) $\xrightarrow{*a \rightarrow (SR, id)}$ (8') SR

$*z \Rightarrow (SR, SR)$

$*a \rightarrow (SR, id)$

(*) C.R. starting

(6) $\xrightarrow{/a \leftarrow (SL, id)}$ (6') SL

$/z \leftarrow (SL, SL)$

unit starting

(4) $\xrightarrow{*a \rightarrow (SR, id)}$ (4') SR

$*z \Rightarrow (SR, SR)$

$*a \rightarrow (SR, id)$

Butterfly Relations

A Shifting Shifted Sequence 1

Unshifted Sequence $x \rightarrow$ Shifted Sequence 1 x'

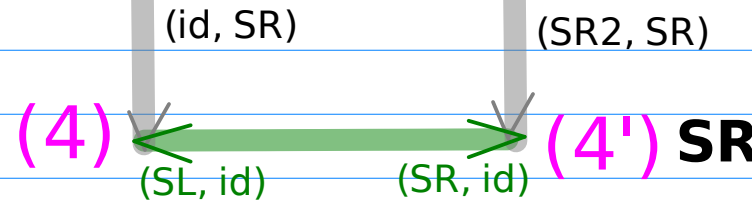
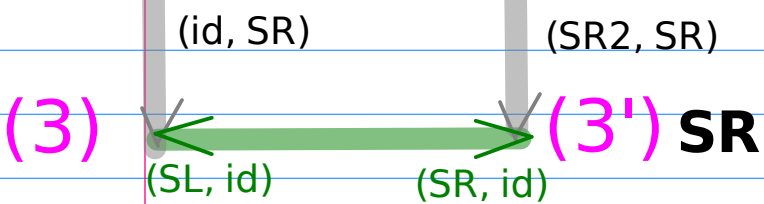
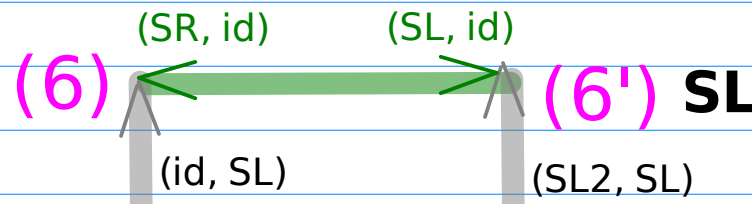
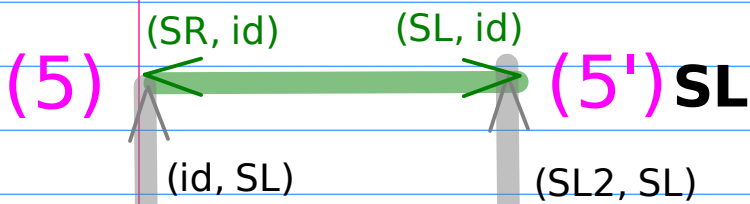
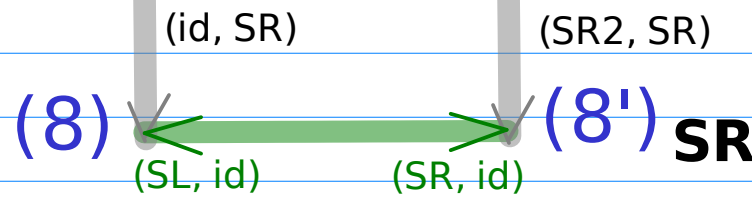
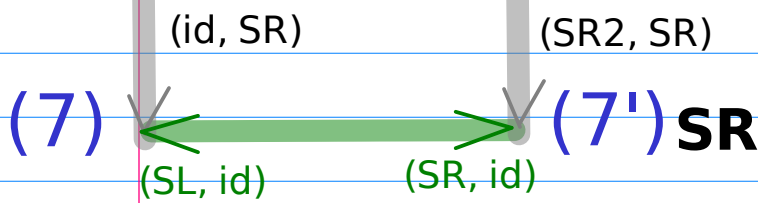
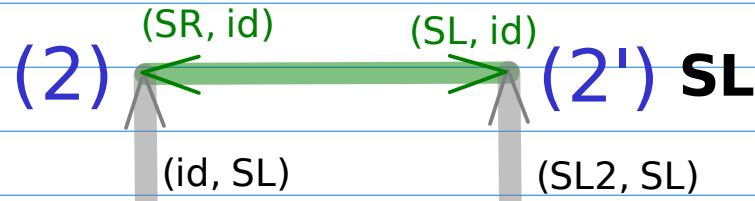
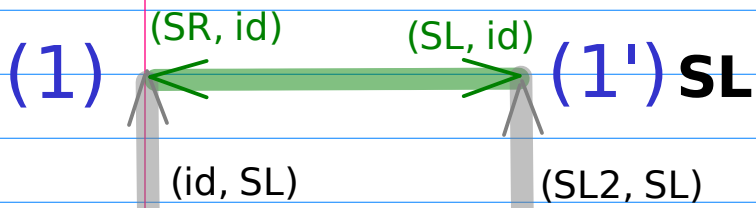
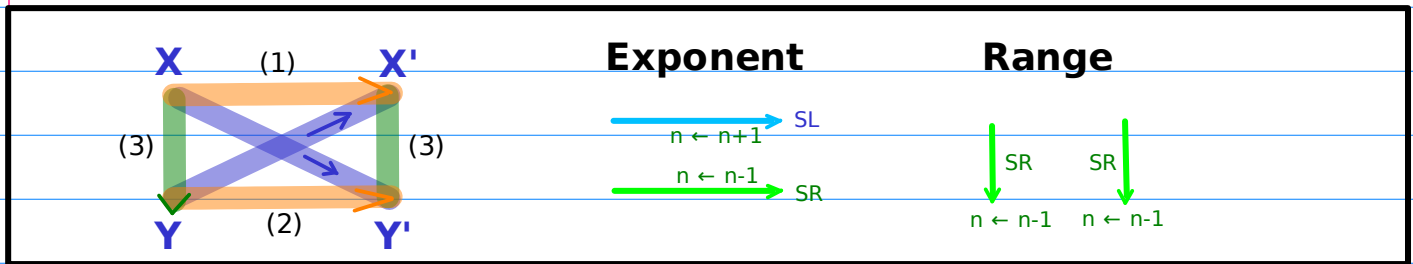

Decomposition of Exp and Rng Shifts (1)

A Shifting Shifted Sequence 1

Unshifted Sequence x \rightarrow Shifted Sequence 1 x'

$$(id, SR) + (SR, id) = (SR, SR)$$

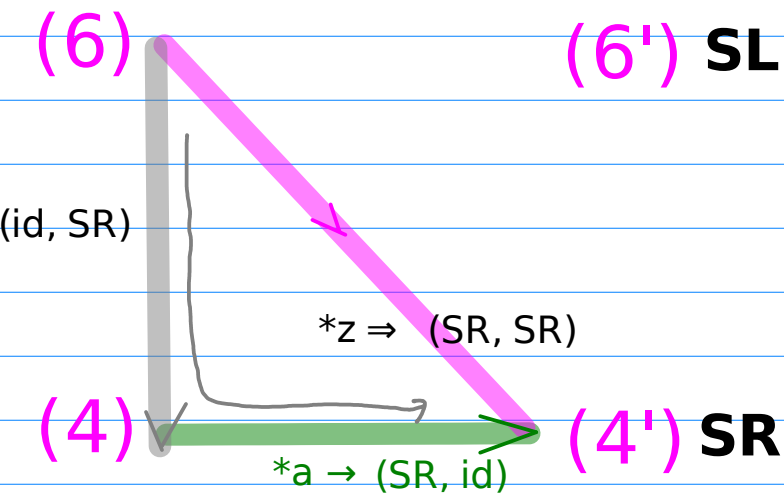
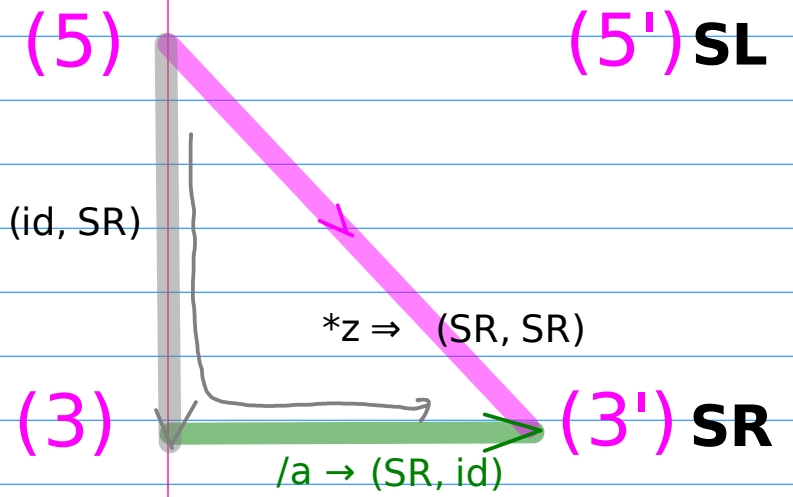
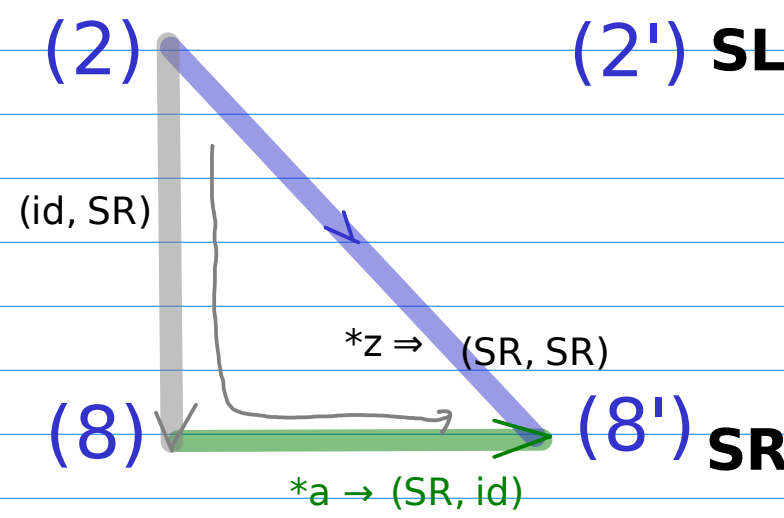
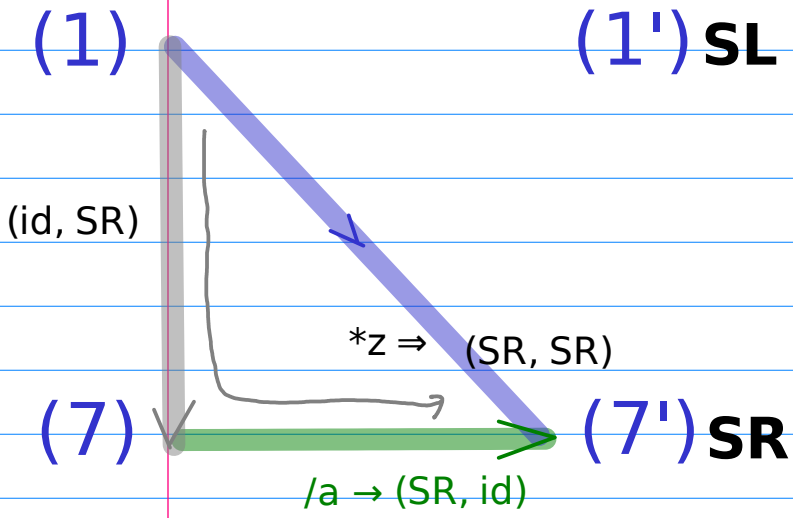
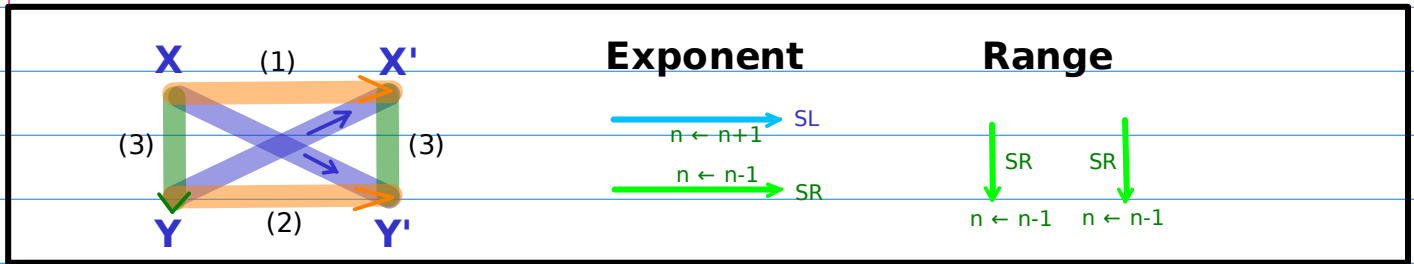

Decomposition of Exp and Rng Shifts (2)

A Shifting Shifted Sequence 1

Unshifted Sequence x \rightarrow Shifted Sequence 1 x'

$$(id, SL) + (SL, id) = (SL, SL)$$

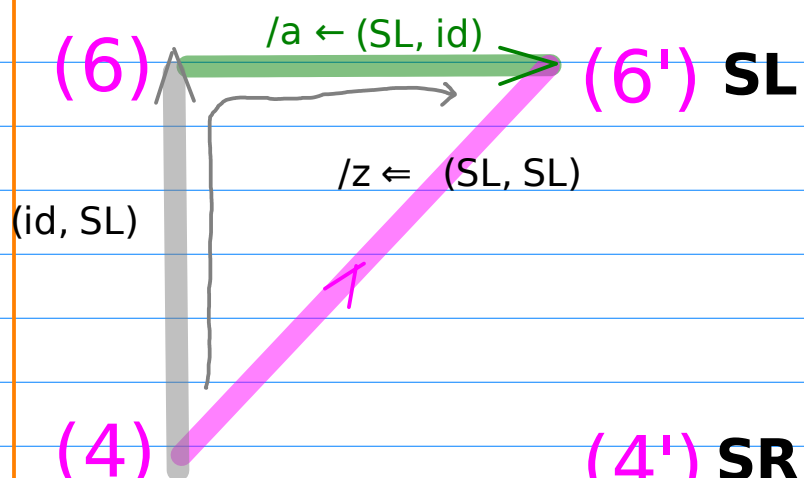
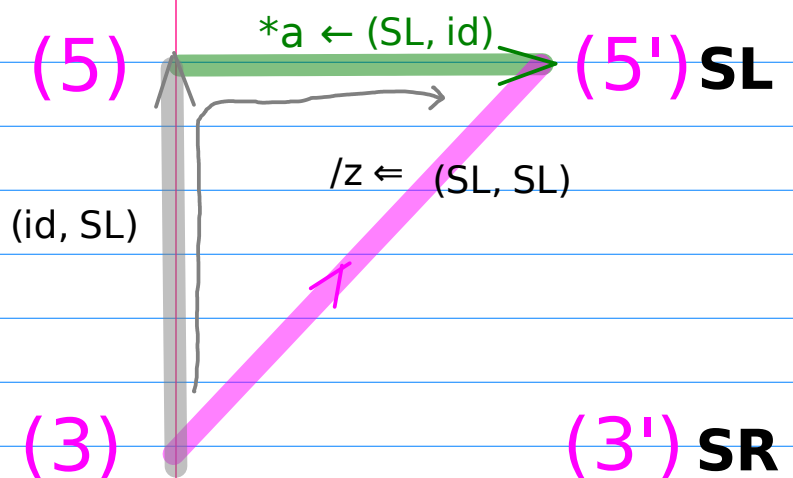
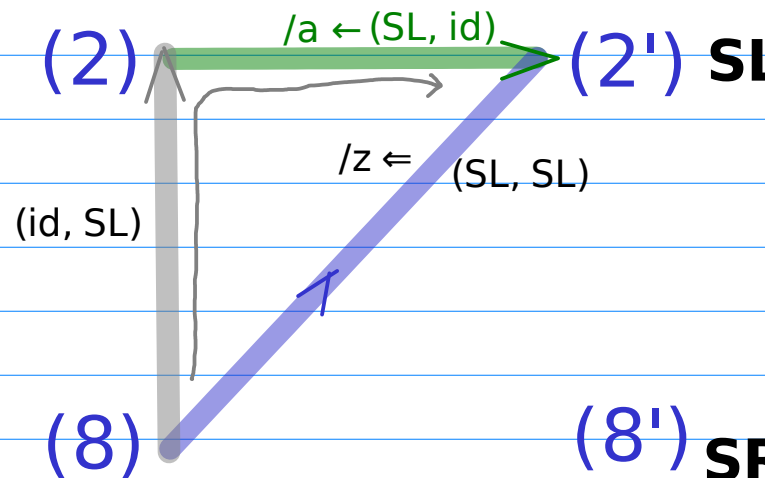
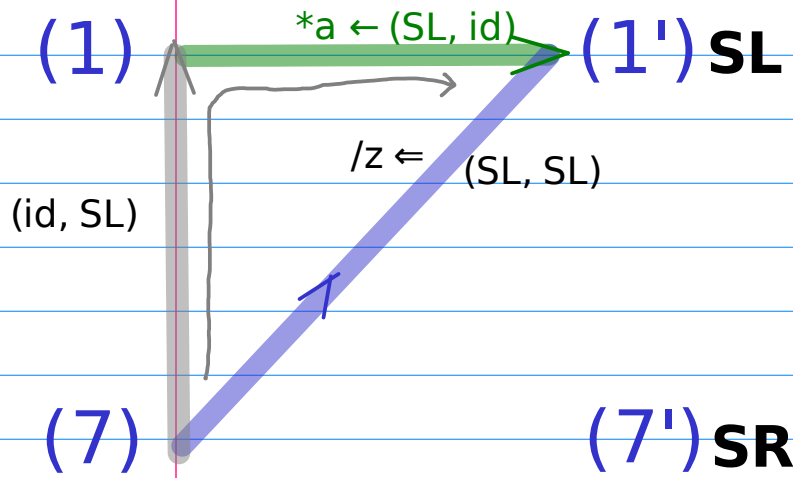
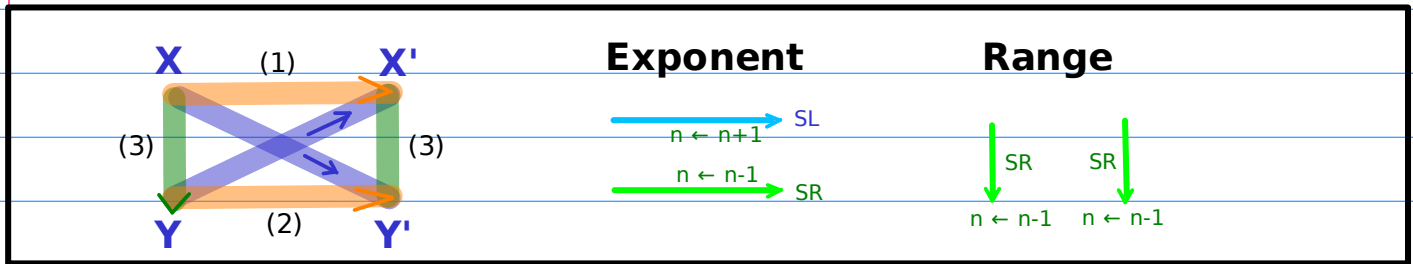

Decomposition of Exp and Rng Shifts (3)

A Shifting Shifted Sequence 1
 Unshifted Sequence x \rightarrow Shifted Sequence 1 x'

$$(SR, id) + (id, SR) + (SR, id) = (SR2, SR)$$

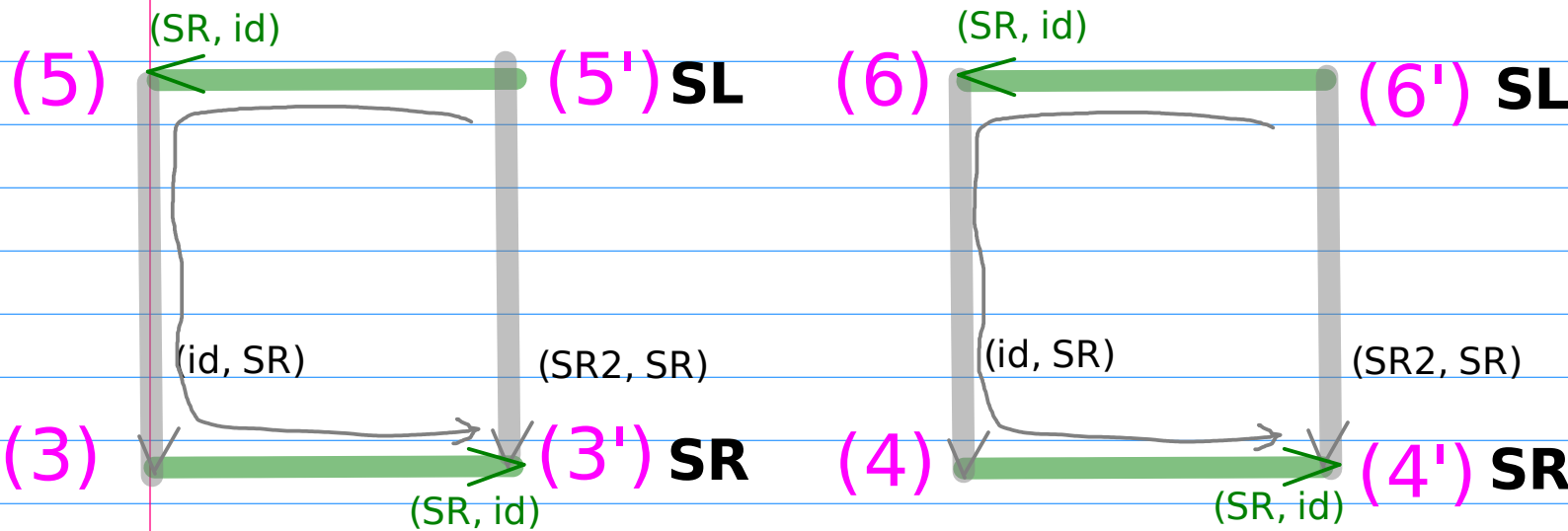
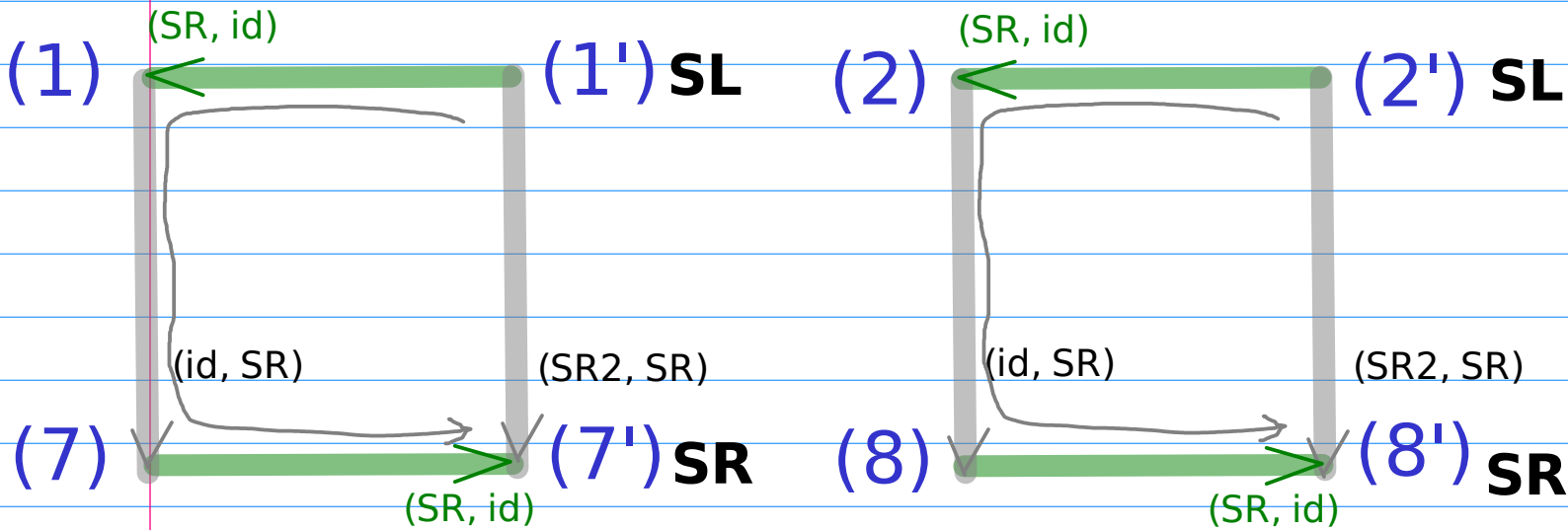
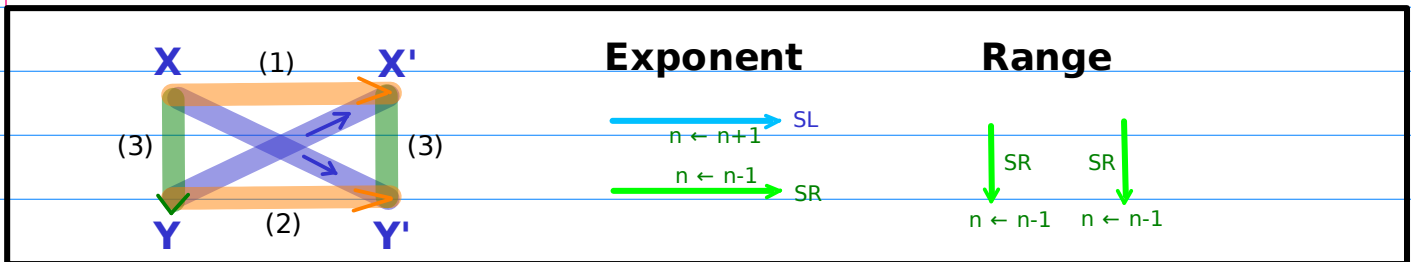





Intra-Permutations over (1) ~ (8)

Unshifted
Sequence x



Unshifted
Sequence x

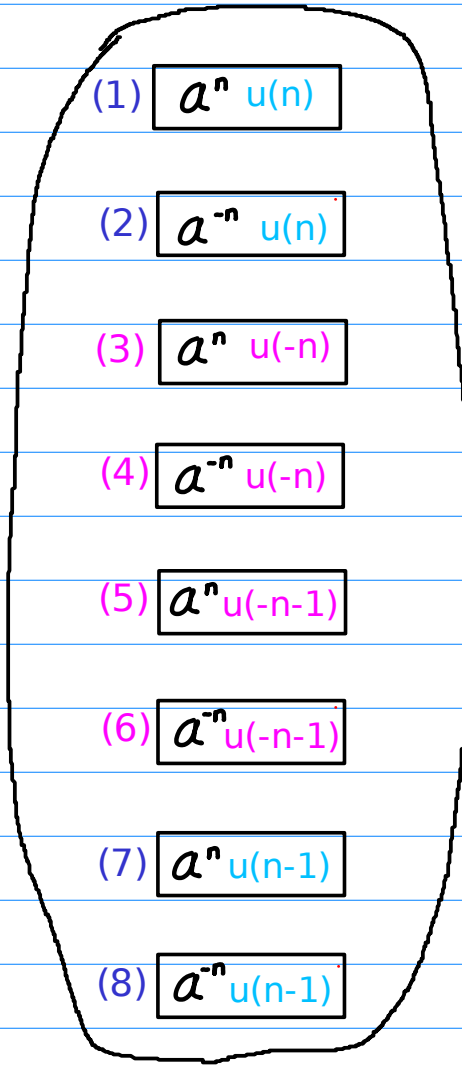
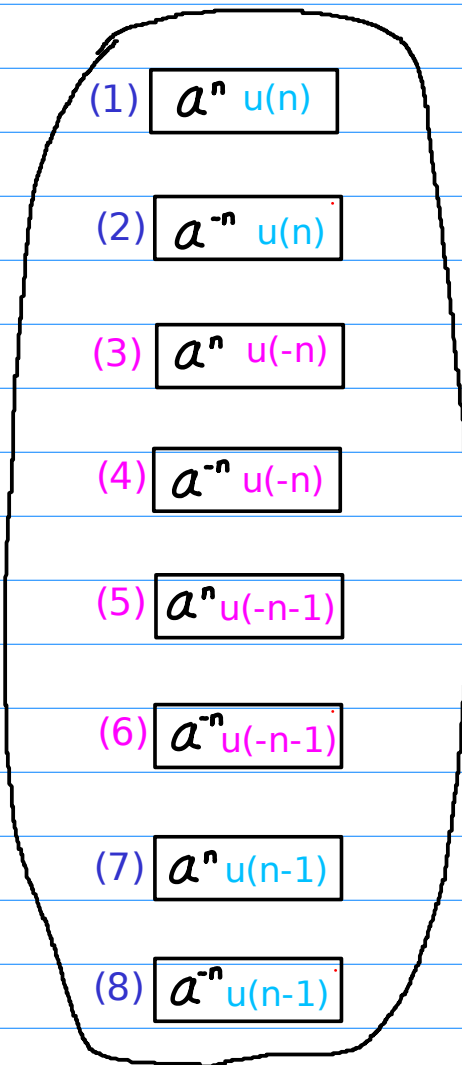

Inter-permutations over unshifted sequence and shifted sequence

Intra-permutations over unshifted sequence

Intra-permutations over shifted sequence

Intra-Permutations over (1') ~ (8')

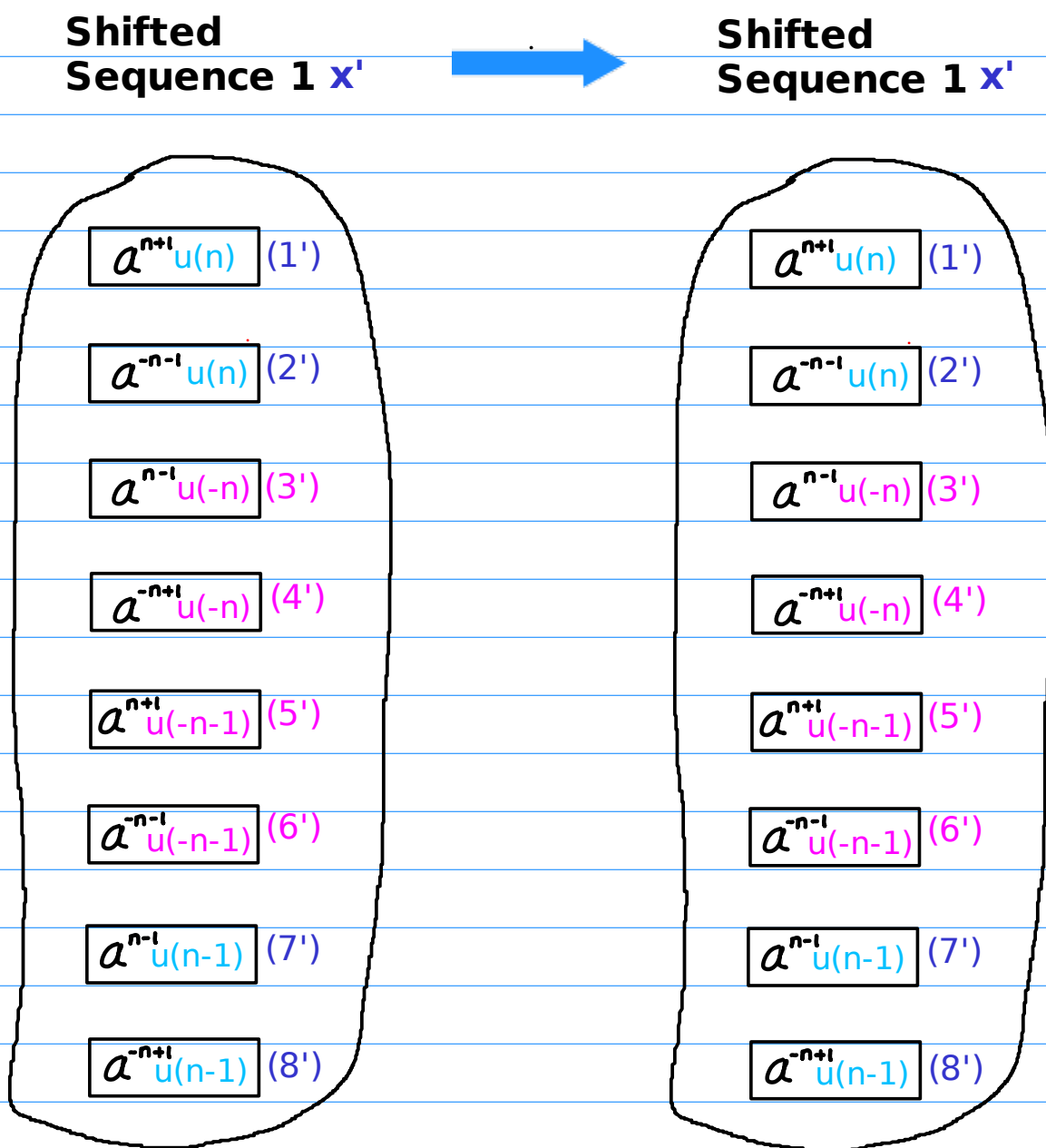

Inter-permutations over unshifted sequence and shifted sequence

Intra-permutations over unshifted sequence

Intra-permutations over shifted sequence

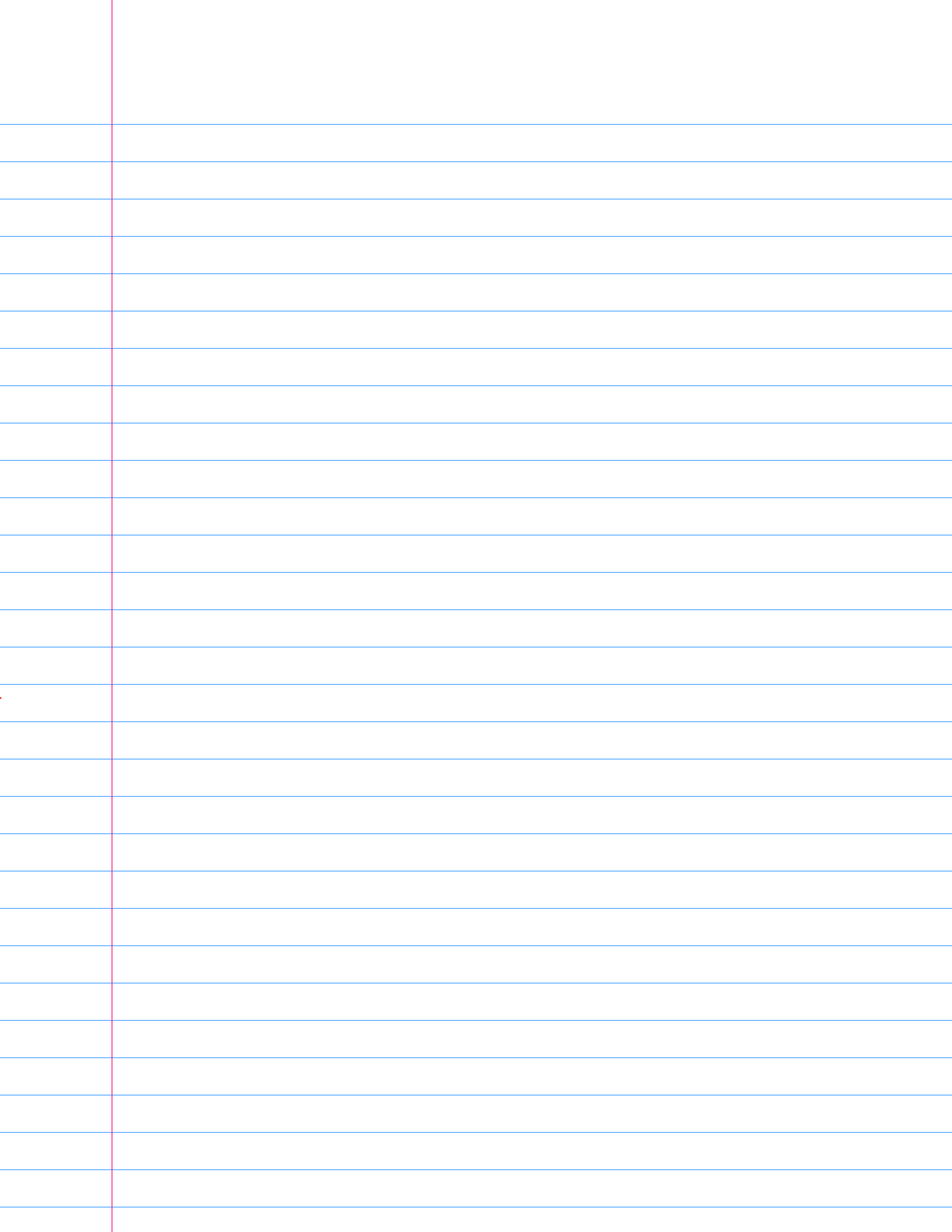

$$a^n \times R(n)$$

$$\begin{array}{|c|c|} \hline a^{n+1} & a^{-n-1} \\ \hline a^{n-1} & a^{-n+1} \\ \hline \end{array} \times \begin{array}{|c|c|} \hline u(n) & u(-n-1) \\ \hline u(n-1) & u(-n) \\ \hline \end{array}$$

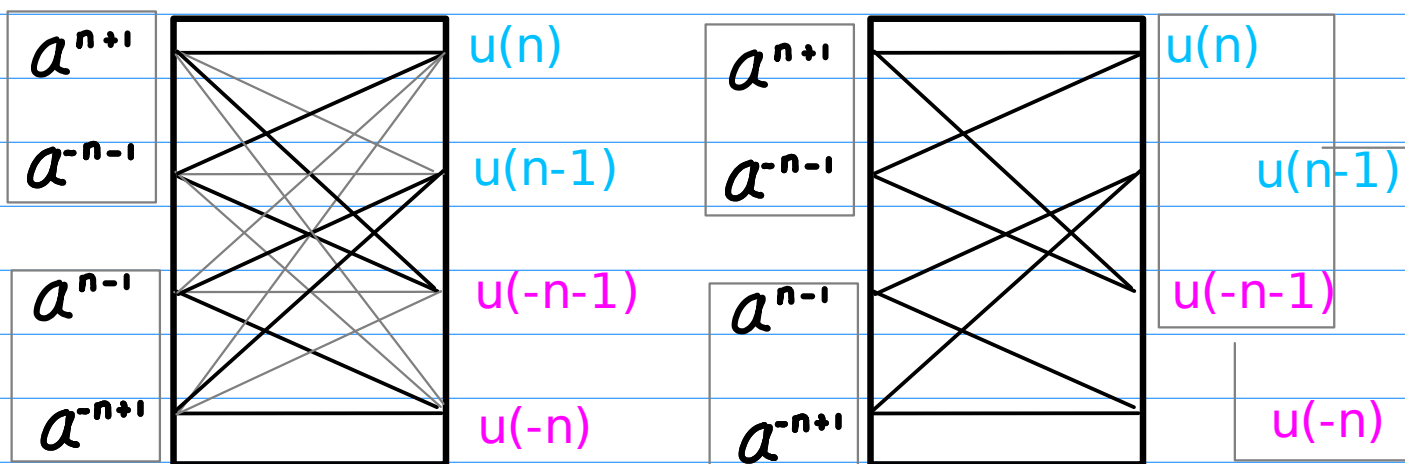

$$\begin{array}{l} n \leftarrow n+2 \text{ or} \\ n \leftarrow n-2 \end{array}$$

$$\begin{array}{|c|c|} \hline (1') a^{n+1} u(n) & a^{-n-1} u(n) \quad (2') \\ \hline (3') a^{n-1} u(-n) & a^{-n+1} u(-n) \quad (4') \\ \hline (5') a^{n+1} u(-n-1) & a^{-n-1} u(-n-1) \quad (6') \\ \hline (7') a^{n-1} u(n-1) & a^{-n+1} u(n-1) \quad (8') \\ \hline \end{array}$$

$$\begin{array}{|c|c|} \hline (1'') a^{n-1} u(n) & a^{-n+1} u(n) \quad (2'') \\ \hline (3'') a^{n+1} u(-n) & a^{-n-1} u(-n) \quad (4'') \\ \hline (5'') a^{n-1} u(-n-1) & a^{-n+1} u(-n-1) \quad (6'') \\ \hline (7'') a^{n+1} u(n-1) & a^{-n-1} u(n-1) \quad (8'') \\ \hline \end{array}$$



permutation over (1) ~ (8) **(x)**  **(x)**

A. Flipping	(1) - (4)	(5) - (8)
Base Inverting	(2) - (3)	(6) - (7)
Range Flipping	(3) - (2)	(7) - (6)
	(4) - (1)	(8) - (5)
B. Range Shifting	(1) - (7)	(5) - (3)
Range Flipping	(2) - (8)	(6) - (4)
Range Complementing	(3) - (5)	(7) - (1)
	(4) - (6)	(8) - (2)
C. Complementary Inverting	(1) - (6)	(5) - (2)
Base Inverting	(6) - (1)	(6) - (1)
Range Complementing	(2) - (5)	(7) - (4)
	(5) - (2)	(8) - (3)

permutation over (1') ~ (8') **(x')**  **(x')**

D. Flipping2	(1') - (4')	(5') - (8')
Base Inverting	(2') - (3')	(6') - (7')
Shifted Range Flipping	(3') - (2')	(7') - (6')
	(4') - (1')	(8') - (5')
E. Shifting2	(1') - (7')	(5') - (3')
Shifted Range Flipping	(2') - (8')	(6') - (4')
Range Complementing	(3') - (5')	(7') - (1')
	(4') - (6')	(8') - (2')
F. Complementary Inverting	(1') - (6')	(5') - (2')
Base Inverting	(6') - (1')	(6') - (1')
Range Complementing	(2') - (5')	(7') - (4')
	(5') - (2')	(8') - (3')

Shifted Range Flipping = Exponent Shifting2 + Range Flipping

Shifting2 = Shifted Range Flipping + Range Complementing
= Exponent Shifting2 + Range Flipping + Range Complementing
= Exponent Shifting2 + Range (Flipping + Complementing)
= Exponent Shifting2 + Range Shifting

Permutation over (1) ~ (8)

Permutations	A	B	C
Base Inverting	X		X
Range Flipping	X	X	
Range Complementing		X	X

Permutation over (1') ~ (8')

Permutations	D	E	F
Base Inverting	X		X
Shifted Range Flipping	X	X	
Range Complementing		X	X

Shifted Range Flipping = Exponent Shifting₂ + Range Flipping

Shifting₂ = Shifted Range Flipping + Range Complementing
= Exponent Shifting₂ + Range Flipping + Range Complementing
= Exponent Shifting₂ + Range (Flipping + Complementing)
= Exponent Shifting₂ + Range Shifting

Over (1) ~ (8)

Base Inverting

$$a^n \longleftrightarrow a^{-n}$$

Range Flipping

$$R(n) \longleftrightarrow R(-n)$$

Range Complementing

$$R(n) \longleftrightarrow \overline{R(n)}$$

Over (1') ~ (8')

Base Inverting

$$a^n \longleftrightarrow a^{-n}$$

Shifted Range Flipping

$$a^n R(n) \longleftrightarrow a^{sh2(n)} R(-n)$$

Range Complementing

$$R(n) \longleftrightarrow \overline{R(n)}$$

A.I Flipping
Base Inverting
Range Flipping

$$a^n \longleftrightarrow a^{-n}$$

$$R(n) \longleftrightarrow R(-n)$$

$$a^n R(n) \longleftrightarrow a^{-n} R(-n)$$

D.I Flipping2
Base Inverting
Shifted Range Flipping

$$a^n \longleftrightarrow a^{-n}$$

$$a^n R(n) \longleftrightarrow a^{sh2(n)} R(-n)$$

$$a^n R(n) \longleftrightarrow a^{-sh2(n)} R(-n)$$

B.I Range Shifting
Range Flipping
Range Complementing

$$R(n) \longleftrightarrow R(-n)$$

$$R(n) \longleftrightarrow \overline{R(n)}$$

$$R(n) \longleftrightarrow \overline{R(-n)}$$

E.I Shifting2
Shifted Range Flipping
Range Complementing

$$a^n R(n) \longleftrightarrow a^{sh2(n)} R(-n)$$

$$R(n) \longleftrightarrow \overline{R(n)}$$

$$a^n R(n) \longleftrightarrow a^{sh2(n)} \overline{R(-n)}$$

C.I Complementary Inverting
Base Inverting
Range Complementing

$$a^n \longleftrightarrow a^{-n}$$

$$R(n) \longleftrightarrow \overline{R(n)}$$

$$a^n R(n) \longleftrightarrow a^{-n} \overline{R(n)}$$

F.I Complementary Inverting
Base Inverting
Range Complementing

$$a^n \longleftrightarrow a^{-n}$$

$$R(n) \longleftrightarrow \overline{R(n)}$$

$$a^n R(n) \longleftrightarrow a^{-n} \overline{R(n)}$$

A.I Flipping
Base Inverting
Range Flipping

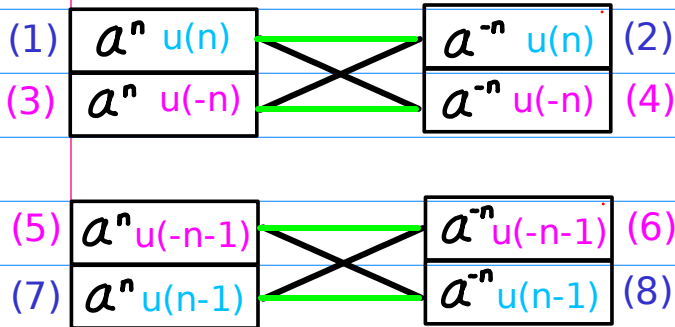

D.I Flipping2
Base Inverting
Shifted Range Flipping

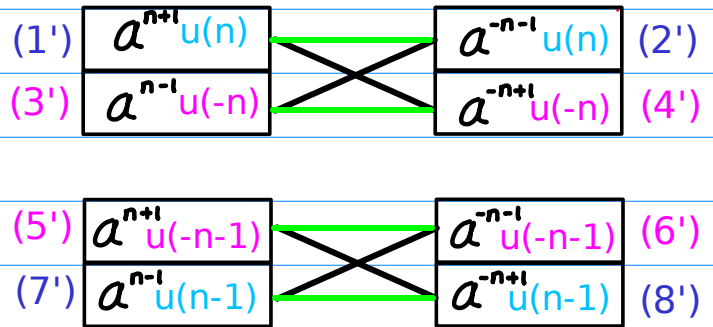

B.I Range Shifting
Range Flipping
Range Complementing

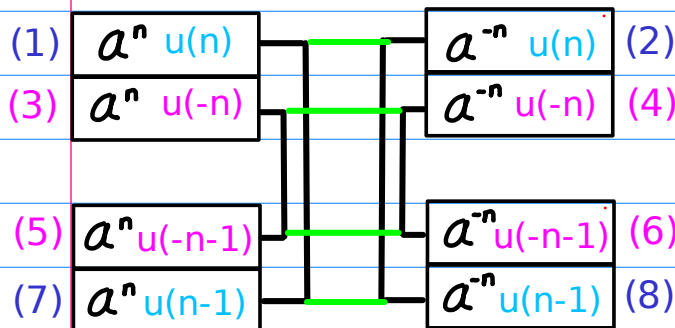

E.I Shifting2
Shifted Range Flipping
Range Complementing

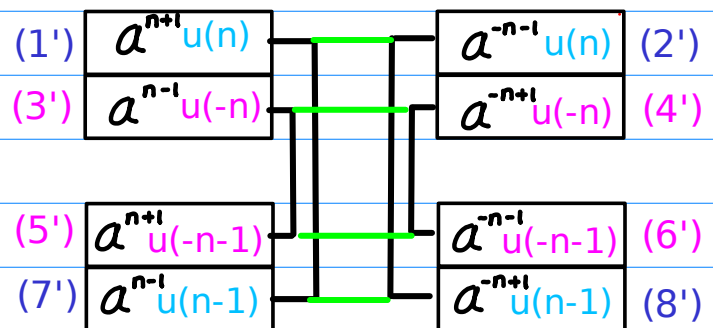

C.I Complementary Inverting
Base Inverting
Range Complementing

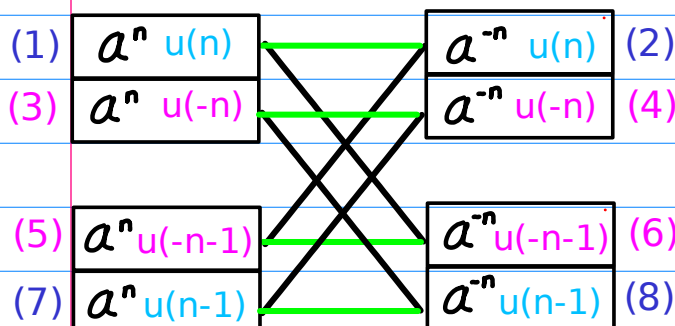

F.I Complementary Inverting
Base Inverting
Range Complementing

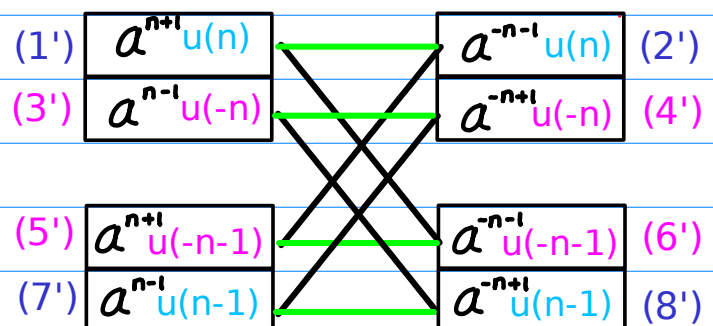

A.I Flipping
Base Inverting
Range Flipping

D.I Flipping2
Base Inverting
Shifted Range Flipping

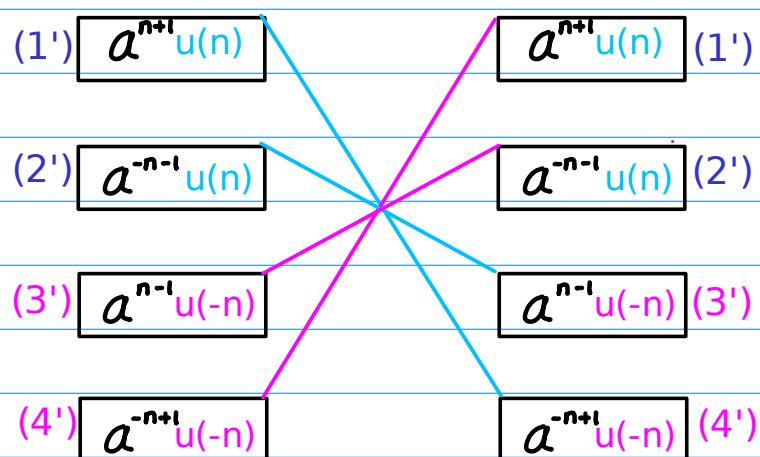
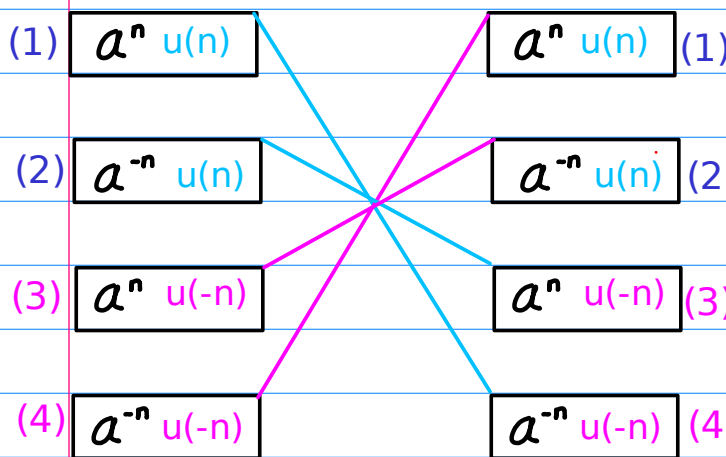
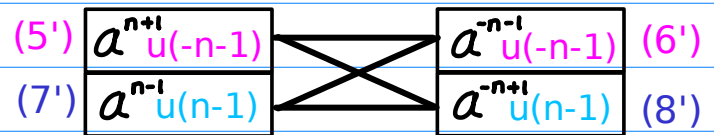
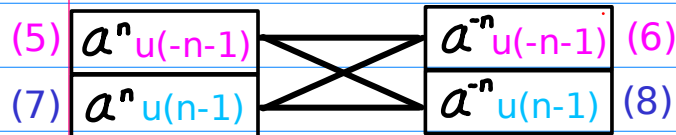
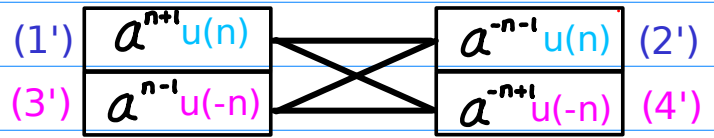
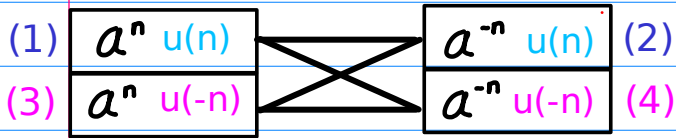

- (1) - (4)
- (2) - (3)
- (3) - (2)
- (4) - (1)
- (5) - (8)
- (6) - (7)
- (7) - (6)
- (8) - (5)

- (1') - (4')
- (2') - (3')
- (3') - (2')
- (4') - (1')
- (5') - (8')
- (6') - (7')
- (7') - (6')
- (8') - (5')

**B.I Range Shifting
Range Flipping
Range Complementing**

**E.I Shifting2
Shifted Range Flipping
Range Complementing**

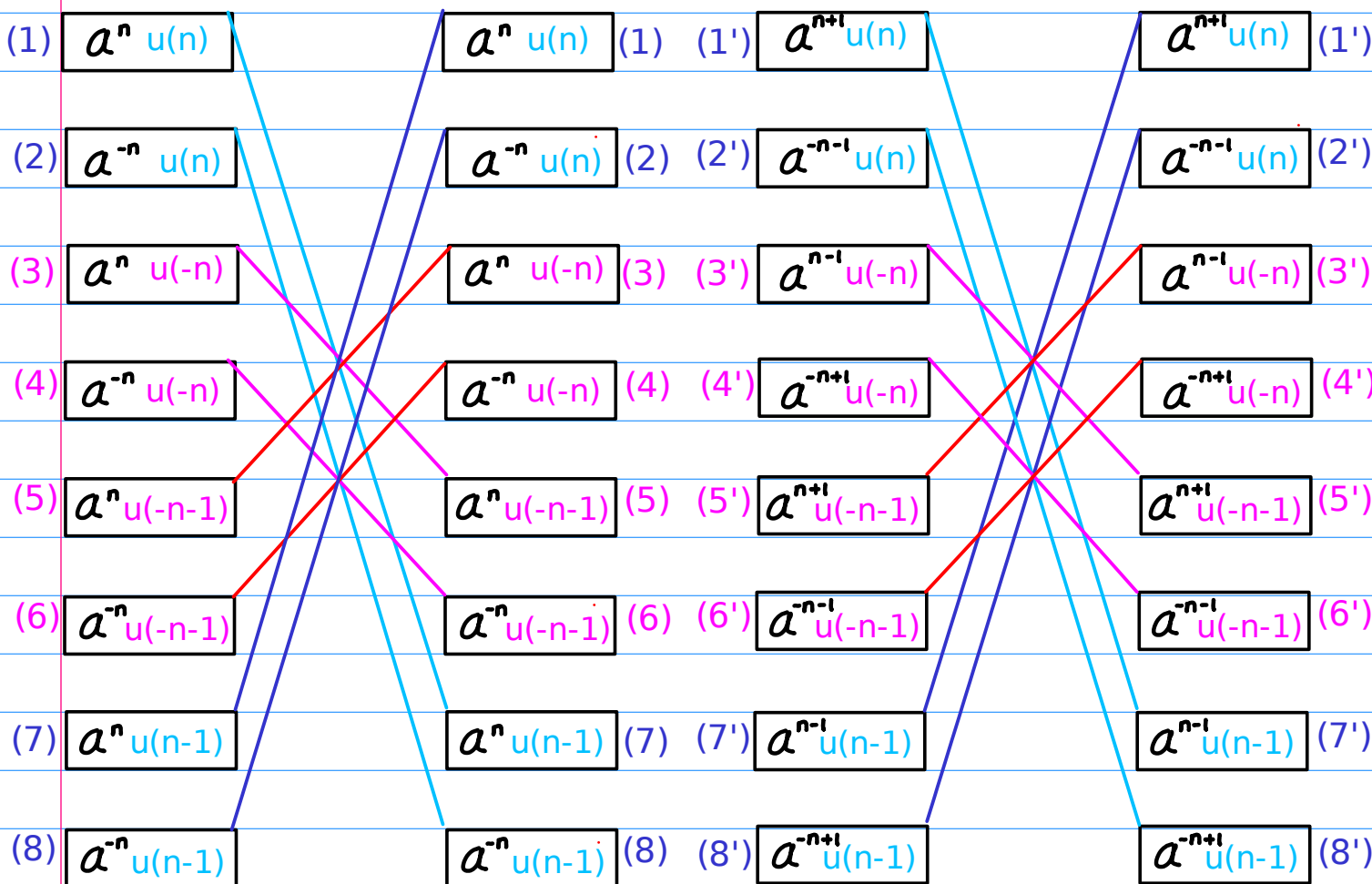
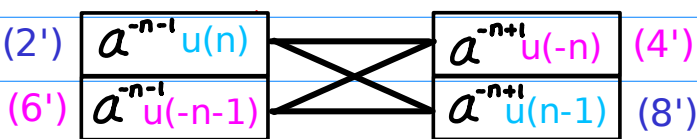
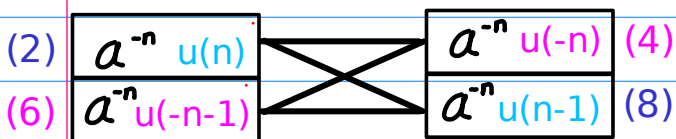
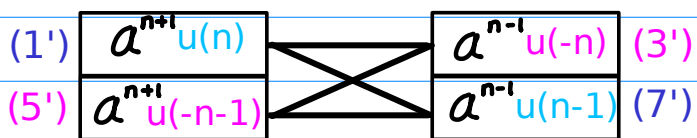
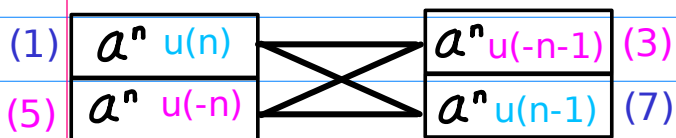

(1) - (7) (5) - (3)
 (2) - (8) (6) - (4)
 (3) - (5) (7) - (1)
 (4) - (6) (8) - (2)

(1') - (7') (5') - (3')
 (2') - (8') (6') - (4')
 (3') - (5') (7') - (1')
 (4') - (6') (8') - (2')

C.I Complementary Inverting Base Inverting Range Complementing

F.I Complementary Inverting Base Inverting Range Complementing

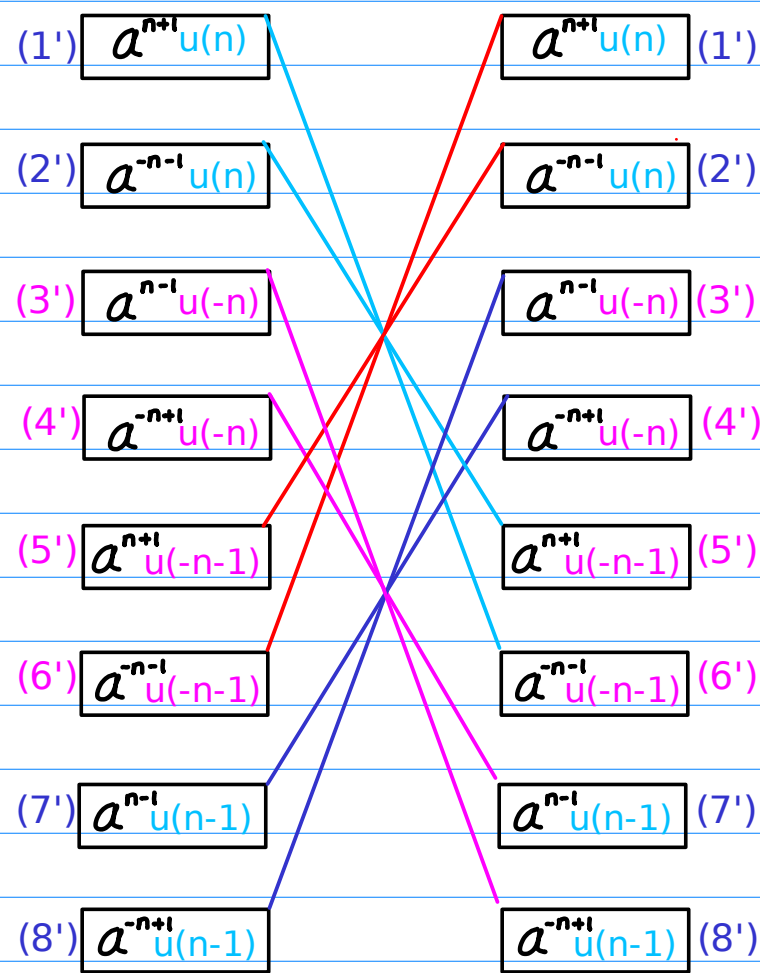
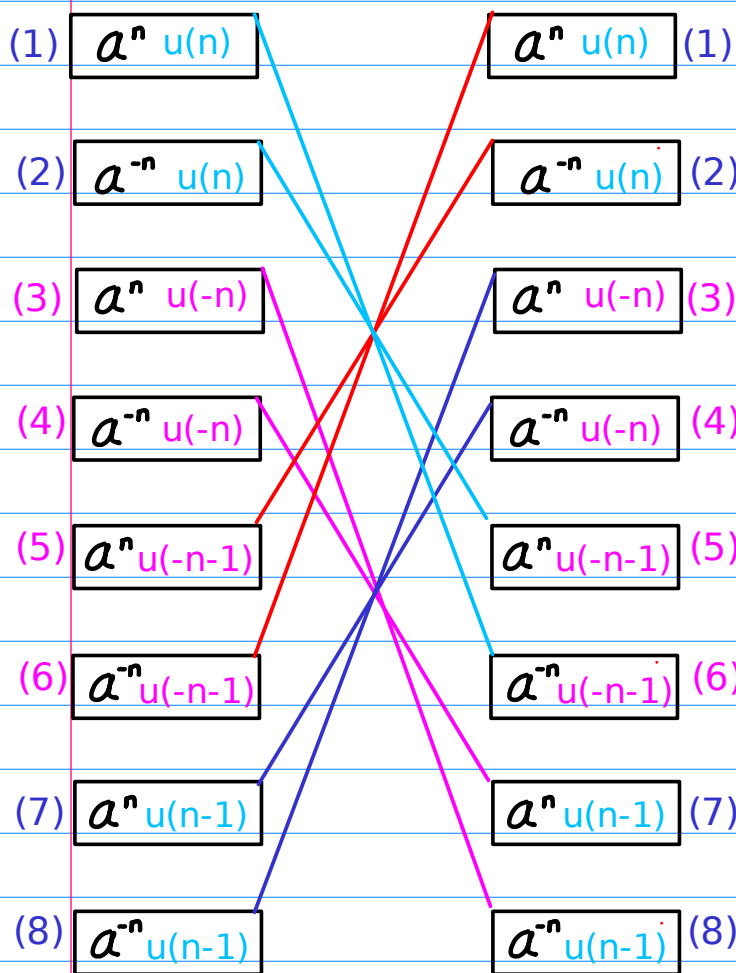
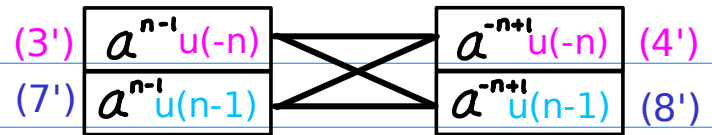
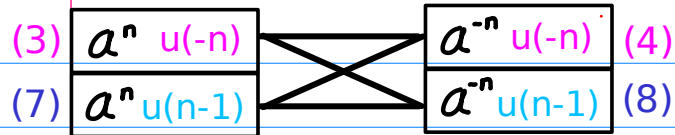
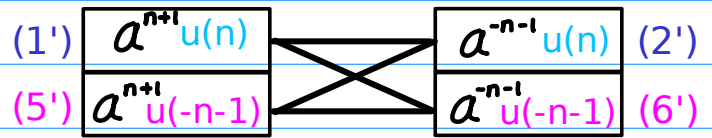
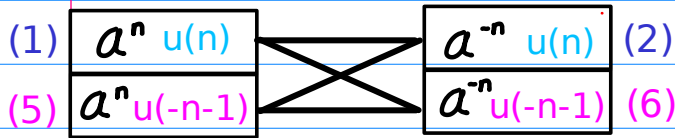

- (1) - (6)
- (6) - (1)
- (2) - (5)
- (5) - (2)
- (5) - (2)
- (3) - (4)
- (4) - (3)
- (7) - (8)
- (8) - (7)

- (1') - (6')
- (6') - (1')
- (2') - (5')
- (5') - (2')
- (3') - (4')
- (4') - (3')
- (7') - (8')
- (8') - (7')



A.I Flipping

- (1) Base Inverting
- (2) Range Flipping

$$\begin{array}{|c|} \hline (1) \ a^n u(n) \\ \hline (3) \ a^n u(-n) \\ \hline \end{array}
 \begin{array}{c} \diagdown \quad \diagup \\ \diagup \quad \diagdown \end{array}
 \begin{array}{|c|} \hline a^{-n} u(n) \quad (2) \\ \hline a^{-n} u(-n) \quad (4) \\ \hline \end{array}$$

$$\begin{array}{|c|} \hline (5) \ a^n u(-n-1) \\ \hline (7) \ a^n u(n-1) \\ \hline \end{array}
 \begin{array}{c} \diagdown \quad \diagup \\ \diagup \quad \diagdown \end{array}
 \begin{array}{|c|} \hline a^{-n} u(-n-1) \quad (6) \\ \hline a^{-n} u(n-1) \quad (8) \\ \hline \end{array}$$

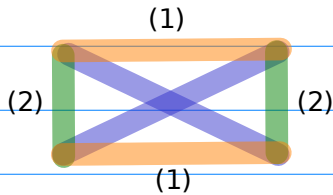

D.I Flipping2

- (1) Base Inverting
- (2) Shifted Range Flipping

$$\begin{array}{|c|} \hline (1') \ a^{n+1} u(n) \\ \hline (3') \ a^{n+1} u(-n) \\ \hline \end{array}
 \begin{array}{c} \diagdown \quad \diagup \\ \diagup \quad \diagdown \end{array}
 \begin{array}{|c|} \hline a^{-n-1} u(n) \quad (2') \\ \hline a^{-n+1} u(-n) \quad (4') \\ \hline \end{array}$$

$$\begin{array}{|c|} \hline (5') \ a^{n+1} u(-n-1) \\ \hline (7') \ a^{n+1} u(n-1) \\ \hline \end{array}
 \begin{array}{c} \diagdown \quad \diagup \\ \diagup \quad \diagdown \end{array}
 \begin{array}{|c|} \hline a^{-n-1} u(-n-1) \quad (6') \\ \hline a^{-n+1} u(n-1) \quad (8') \\ \hline \end{array}$$

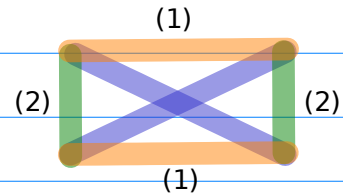

$$\begin{array}{ccc}
 a^n & \xleftrightarrow{(1)} & a^{-n} \\
 R(n) & \xleftrightarrow{(2)} & R(-n) \\
 a^n R(n) & \longleftrightarrow & a^{-n} R(-n)
 \end{array}$$

$$\begin{array}{ccc}
 a^n & \xleftrightarrow{(1)} & a^{-n} \\
 a^n R(n) & \xleftrightarrow{(2)} & a^{sh2(n)} R(-n) \\
 a^n R(n) & \longleftrightarrow & a^{-sh2(n)} R(-n)
 \end{array}$$

b^n	b^{-n}
a^n	a^{-n}
a^{-n}	a^n

b^n	$b^{-sh2(n)}$
$a^{(n+1)}$	$a^{-(n-1)}$
$a^{-(n+1)}$	$a^{(n-1)}$
$a^{(n-1)}$	$a^{-(n+1)}$
$a^{-(n-1)}$	$a^{(n+1)}$

$R(n)$	$R(-n)$
$u(n)$	$u(-n)$
$u(n-1)$	$u(-n-1)$
$u(-n)$	$u(n)$
$u(-n-1)$	$u(n-1)$

$R(n)$	$R(-n)$
$u(n)$	$u(-n)$
$u(n-1)$	$u(-n-1)$
$u(-n)$	$u(n)$
$u(-n-1)$	$u(n-1)$

B.I Range Shifting
(1) Range Complementing
(2) Range Flipping

E.I Shifting2
(1) Shifted Range Flipping
(2) Range Complementing

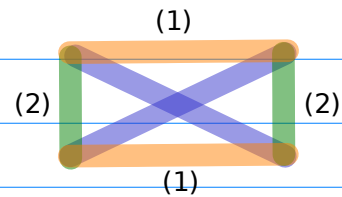
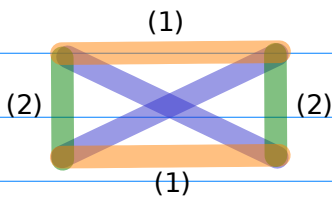
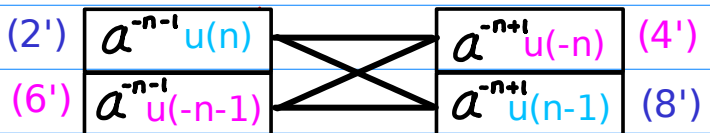
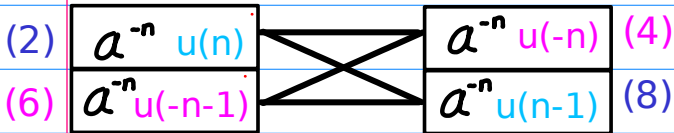
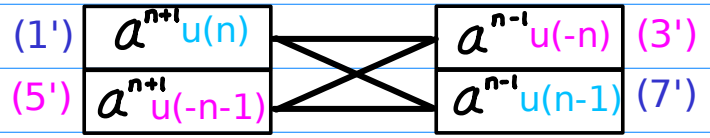
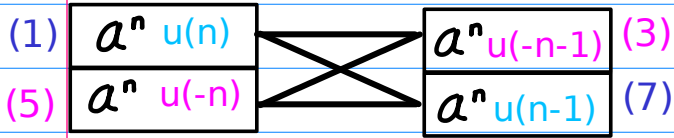

$$R(n) \xleftrightarrow{(1)} R(-n)$$

$$R(n) \xleftrightarrow{(2)} \overline{R(n)}$$

$$R(n) \longleftrightarrow \overline{R(-n)}$$

$$a^n R(n) \xleftrightarrow{(1)} a^{sh2(n)} R(-n)$$

$$R(n) \xleftrightarrow{(2)} \overline{R(n)}$$

$$a^n R(n) \longleftrightarrow a^{sh2(n)} \overline{R(-n)}$$

b^n	$b^{sh2(n)}$
$a^{(n+1)}$	$a^{(n-1)}$
$a^{-(n+1)}$	$a^{-(n-1)}$
$a^{(n-1)}$	$a^{(n+1)}$
$a^{-(n-1)}$	$a^{-(n+1)}$

$R(n)$	$\overline{R(-n)}$
$u(n)$	$u(n-1)$
$u(n-1)$	$u(n)$
$u(-n)$	$u(-n-1)$
$u(-n-1)$	$u(-n)$

$R(n)$	$\overline{R(-n)}$
$u(n)$	$u(n-1)$
$u(n-1)$	$u(n)$
$u(-n)$	$u(-n-1)$
$u(-n-1)$	$u(-n)$

C.I Complementary Inverting

(1) Base Inverting
(2) Range Complementing

$$\begin{array}{|c|} \hline (1) \quad a^n u(n) \\ \hline (5) \quad a^n u(-n-1) \\ \hline \end{array} \begin{array}{c} \diagdown \quad \diagup \\ \diagup \quad \diagdown \end{array} \begin{array}{|c|} \hline a^{-n} u(n) \quad (2) \\ \hline a^{-n} u(-n-1) \quad (6) \\ \hline \end{array}$$

$$\begin{array}{|c|} \hline (3) \quad a^n u(-n) \\ \hline (7) \quad a^n u(n-1) \\ \hline \end{array} \begin{array}{c} \diagdown \quad \diagup \\ \diagup \quad \diagdown \end{array} \begin{array}{|c|} \hline a^{-n} u(-n) \quad (4) \\ \hline a^{-n} u(n-1) \quad (8) \\ \hline \end{array}$$

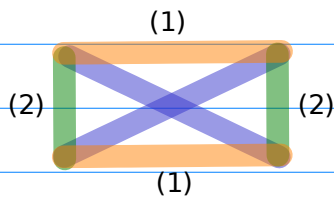

$$\begin{array}{ccc} a^n & \xleftrightarrow{(1)} & a^{-n} \\ R(n) & \xleftrightarrow{(2)} & \overline{R(n)} \\ a^n R(n) & \longleftrightarrow & a^{-n} \overline{R(n)} \end{array}$$

F.I Complementary Inverting

(1) Base Inverting
(2) Range Complementing

$$\begin{array}{|c|} \hline (1') \quad a^{n+1} u(n) \\ \hline (5') \quad a^{n+1} u(-n-1) \\ \hline \end{array} \begin{array}{c} \diagdown \quad \diagup \\ \diagup \quad \diagdown \end{array} \begin{array}{|c|} \hline a^{-n-1} u(n) \quad (2') \\ \hline a^{-n-1} u(-n-1) \quad (6') \\ \hline \end{array}$$

$$\begin{array}{|c|} \hline (3') \quad a^{n-1} u(-n) \\ \hline (7') \quad a^{n-1} u(n-1) \\ \hline \end{array} \begin{array}{c} \diagdown \quad \diagup \\ \diagup \quad \diagdown \end{array} \begin{array}{|c|} \hline a^{-n+1} u(-n) \quad (4') \\ \hline a^{-n+1} u(n-1) \quad (8') \\ \hline \end{array}$$

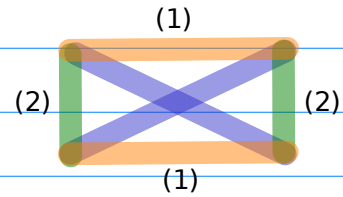

$$\begin{array}{ccc} a^n & \xleftrightarrow{(1)} & a^{-n} \\ R(n) & \xleftrightarrow{(2)} & \overline{R(n)} \\ a^n R(n) & \longleftrightarrow & a^{-n} \overline{R(n)} \end{array}$$

b^n	b^{-n}
a^n	a^{-n}
a^{-n}	a^n

b^n	b^{-n}
$a^{(n+1)}$	$a^{-(n+1)}$
$a^{-(n+1)}$	$a^{(n+1)}$
$a^{(n-1)}$	$a^{-(n-1)}$
$a^{-(n-1)}$	$a^{(n-1)}$

$R(n)$	$\overline{R(n)}$
$u(n)$	$u(-n-1)$
$u(n-1)$	$u(-n)$
$u(-n)$	$u(n)$
$u(-n-1)$	$u(n-1)$

$R(n)$	$\overline{R(n)}$
$u(n)$	$u(-n-1)$
$u(n-1)$	$u(-n)$
$u(-n)$	$u(n)$
$u(-n-1)$	$u(n-1)$

A.I Flipping

- (1) Base Inverting
- (2) Range Flipping

$$\begin{array}{ccc}
 a^n & \xleftrightarrow{(1)} & a^{-n} \\
 R(n) & \xleftrightarrow{(2)} & R(-n) \\
 a^n R(n) & \longleftrightarrow & a^{-n} R(-n)
 \end{array}$$

D.I Flipping2

- (1) Base Inverting
- (2) Shifted Range Flipping

$$\begin{array}{ccc}
 a^n & \xleftrightarrow{(1)} & a^{-n} \\
 a^n R(n) & \xleftrightarrow{(2)} & a^{sh2(n)} R(-n) \\
 a^n R(n) & \longleftrightarrow & a^{-sh2(n)} R(-n)
 \end{array}$$

$$\begin{array}{ccc}
 a^n R(n) & \xrightarrow{(1)} & a^{-n} R(n) \\
 & \xrightarrow{(2)} & a^{-n} R(-n)
 \end{array}$$

$$\begin{array}{ccc}
 a^n R(n) & \xrightarrow{(1)} & a^{-n} R(n) \\
 & \xrightarrow{(2)} & a^{-sh2(n)} R(-n)
 \end{array}$$

$$\begin{array}{ccc}
 a^n R(n) & \xrightarrow{(2)} & a^n R(-n) \\
 & \xrightarrow{(1)} & a^{-n} R(-n)
 \end{array}$$

$$\begin{array}{ccc}
 a^n R(n) & \xrightarrow{(2)} & a^{sh2(n)} R(-n) \\
 & \xrightarrow{(1)} & a^{-sh2(n)} R(-n)
 \end{array}$$

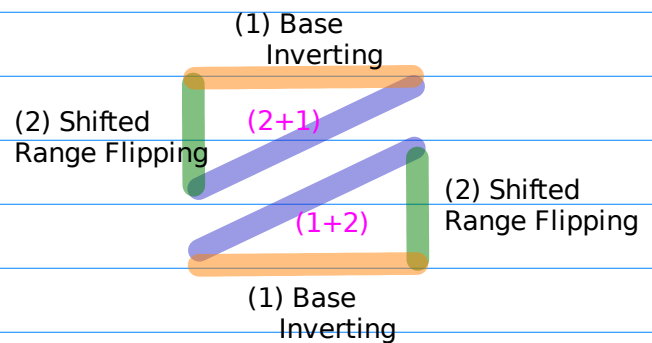
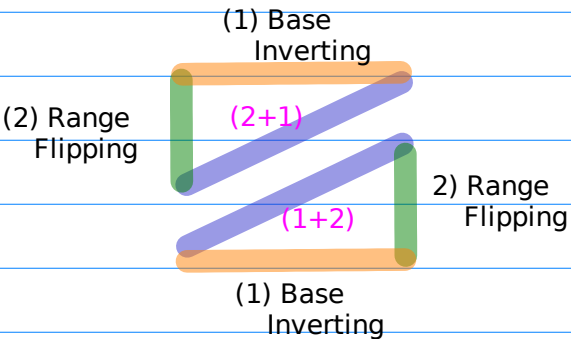
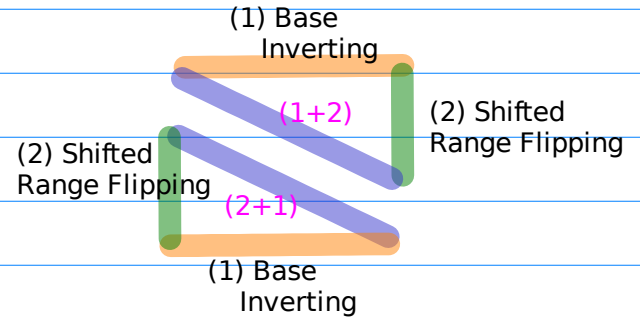
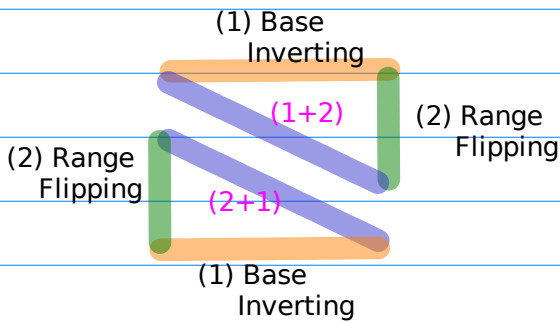

B.I Range Shifting
(1) Range Complementing
(2) Range Flipping

E.I Shifting2
(1) Shifted Range Flipping
(2) Range Complementing

$$R(n) \xleftrightarrow{(1)} R(-n)$$

$$a^n R(n) \xleftrightarrow{(1)} a^{sh2(n)} R(-n)$$

$$R(n) \xleftrightarrow{(2)} \overline{R(n)}$$

$$R(n) \xleftrightarrow{(2)} \overline{R(n)}$$

$$R(n) \longleftrightarrow \overline{R(-n)}$$

$$a^n R(n) \longleftrightarrow a^{sh2(n)} \overline{R(-n)}$$

$$a^n R(n) \xrightarrow{(1)} a^{-n} R(n)$$

$$\xrightarrow{(2)} a^{-n} \overline{R(n)}$$

$$a^n R(n) \xrightarrow{(1)} a^{-n} R(n)$$

$$\xrightarrow{(2)} a^{-sh2(n)} R(-n)$$

$$a^n \text{rng}(n) \xrightarrow{(2)} a^n \overline{R(n)}$$

$$\xrightarrow{(1)} a^{-n} \overline{R(n)}$$

$$a^n R(n) \xrightarrow{(2)} a^{sh2(n)} R(-n)$$

$$\xrightarrow{(1)} a^{-sh2(n)} R(-n)$$

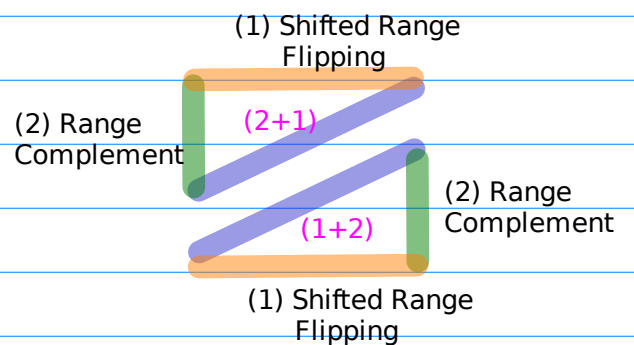
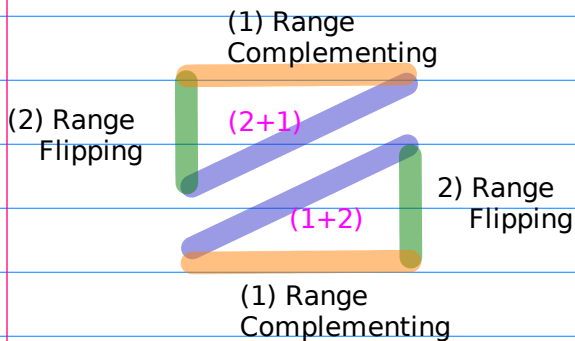
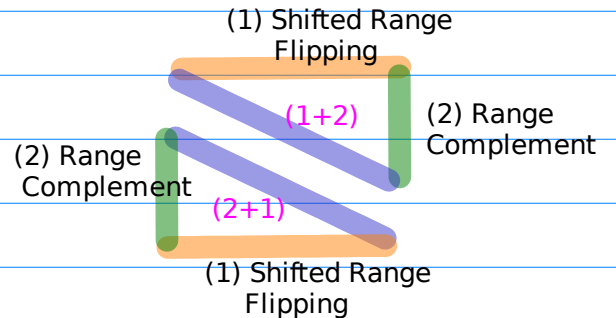
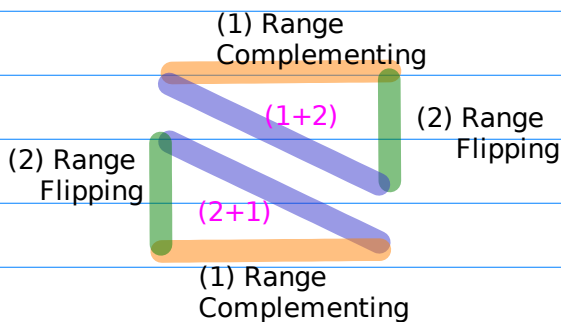

C.I Complementary Inverting

(1) Base Inverting
(2) Range Complementing

F.I Complementary Inverting

(1) Base Inverting
(2) Range Complementing

$$\begin{array}{ccc}
 a^n & \xleftrightarrow{(1)} & a^{-n} \\
 R(n) & \xleftrightarrow{(2)} & \overline{R(n)} \\
 a^n R(n) & \longleftrightarrow & a^{-n} \overline{R(n)}
 \end{array}$$

$$\begin{array}{ccc}
 a^n & \xleftrightarrow{(1)} & a^{-n} \\
 R(n) & \xleftrightarrow{(2)} & \overline{R(n)} \\
 a^n R(n) & \longleftrightarrow & a^{-n} \overline{R(n)}
 \end{array}$$

$$\begin{array}{ccc}
 a^n R(n) & \xrightarrow{(1)} & a^{-n} R(n) \\
 & \xrightarrow{(2)} & a^{-n} \overline{R(n)}
 \end{array}$$

$$\begin{array}{ccc}
 a^n R(n) & \xrightarrow{(1)} & a^{-n} R(n) \\
 & \xrightarrow{(2)} & a^{-n} \overline{R(n)}
 \end{array}$$

$$\begin{array}{ccc}
 a^n R(n) & \xrightarrow{(2)} & a^n \overline{R(n)} \\
 & \xrightarrow{(1)} & a^{-n} \overline{R(n)}
 \end{array}$$

$$\begin{array}{ccc}
 a^n R(n) & \xrightarrow{(2)} & a^n \overline{R(n)} \\
 & \xrightarrow{(1)} & a^{-n} \overline{R(n)}
 \end{array}$$

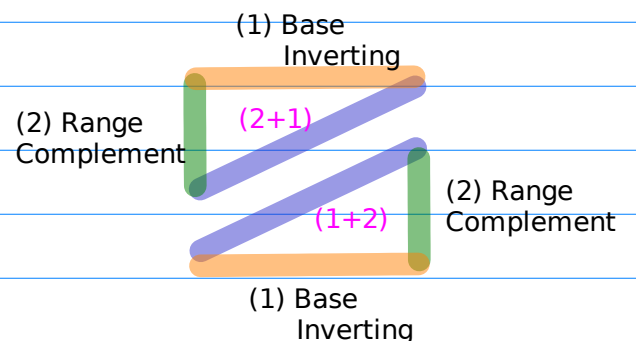
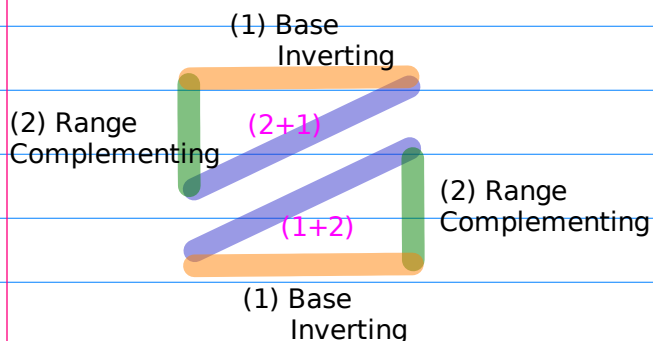
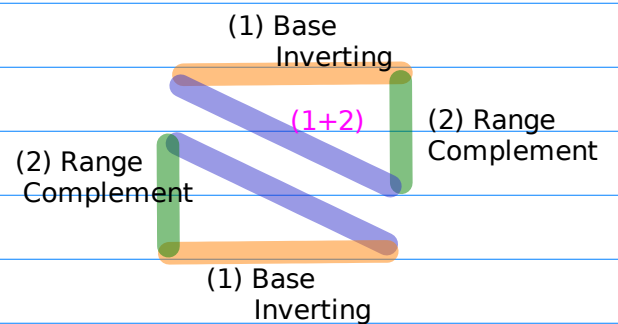
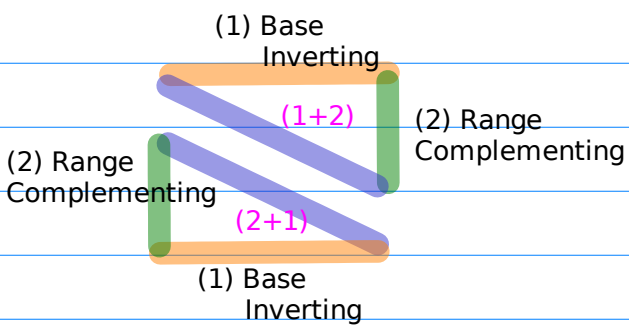



A.II Flipping Base Inverting Range Flipping

(1) 0000

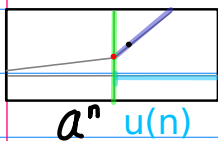

(4) 0011

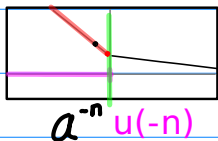

(3) 0010

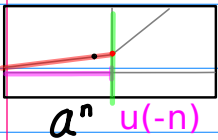

(2) 0001

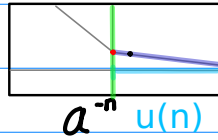

(5) 0100

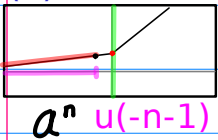

(8) 0111

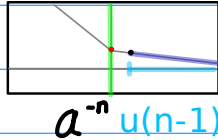

(7) 0110

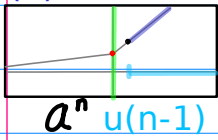

(6) 0101

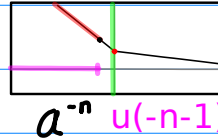

D.II Flipping2 Base Inverting Shifted Range Flipping

(1') 1000

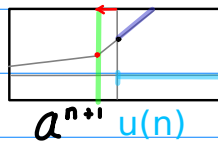

(4') 1011

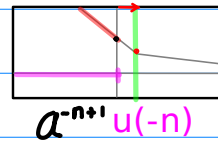

(3') 1010

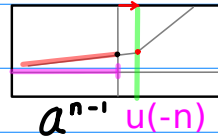

(2') 1001

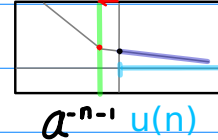

(5') 1100

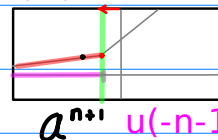

(8') 1111

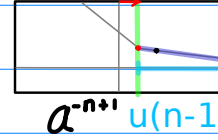

(7') 1110

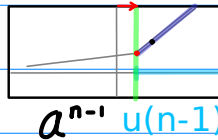

(6') 1101

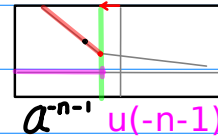

Shifted Range Flipping
= Exponent Shifting2
+ Range Flipping

$$a^n R(n) \longleftrightarrow a^{-n} R(-n)$$

$$a^n R(n) \longleftrightarrow a^{-sh2(n)} R(-n)$$

$$a^n \longleftrightarrow a^{-n}$$

$$a^n \longleftrightarrow a^{-n}$$

$$R(n) \longleftrightarrow R(-n)$$

$$a^n R(n) \longleftrightarrow a^{sh2(n)} R(-n)$$

B.II Range Shifting Range Flipping Range Complementing

(1) 0000

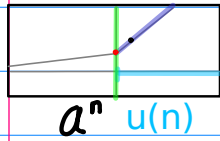

(7) 0110

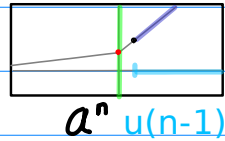

(5) 0100

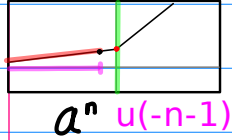

(3) 0010

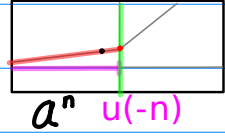

(2) 0001

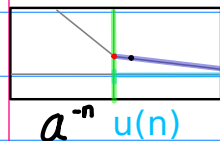

(8) 0111

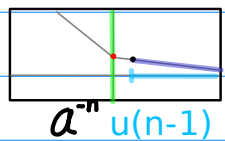

(6) 0101

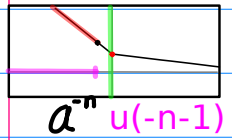

(4) 0011

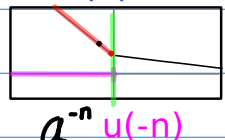

Range Shifting
= Range Flipping
+ Range Complementing

$$R(n) \longleftrightarrow \overline{R(-n)}$$

$$R(n) \longleftrightarrow R(-n)$$

$$R(n) \longleftrightarrow \overline{R(n)}$$

E.II Shifting2 Shifted Range Flipping Range Complementing

(1') 1000

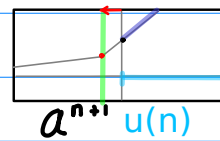

(7') 1110

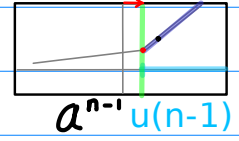

(5') 1100

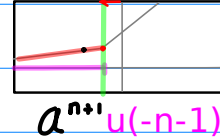

(3') 1010

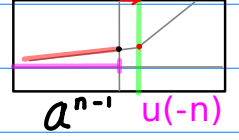

(2') 1001

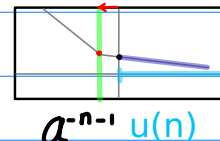

(8') 1111

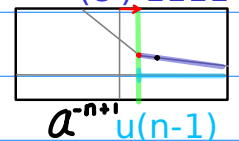

(6') 1101

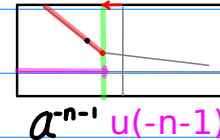

(4') 1011

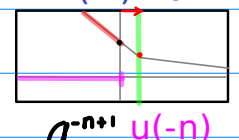

Shifted Range Flipping
= Exponent Shifting2
+ Range Flipping

$$a^n R(n) \longleftrightarrow a^{sh2(n)} \overline{R(-n)}$$

$$a^n R(n) \longleftrightarrow a^{sh2(n)} R(-n)$$

$$R(n) \longleftrightarrow \overline{R(n)}$$

C.II Complementary Inverting Base Inverting Range Complementing

F.II Complementary Inverting Base Inverting Range Complementing

(1) 0000

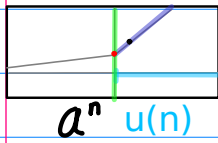

$a^{-n} u(-n-1)$

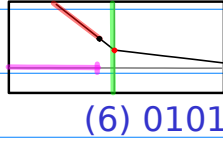

(6) 0101

(1') 1000

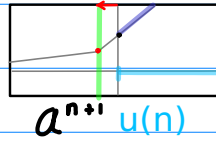

$a^{-n-1} u(-n-1)$

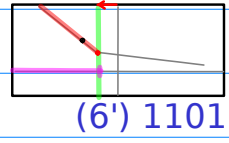

(6') 1101

(5) 0100

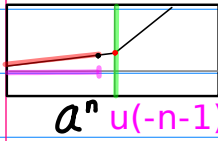

(2) 0001

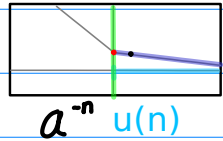

(5') 1100

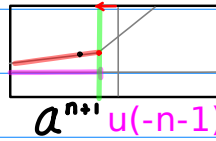

(2') 1001

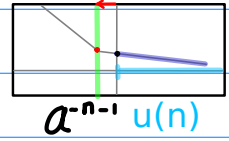

(3) 0010

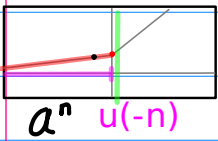

(8) 0111

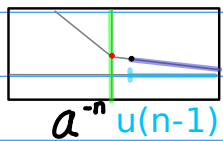

(3') 1010

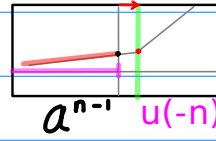

(8') 1111

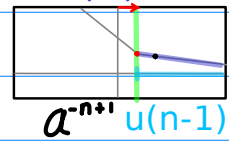

(7) 0110

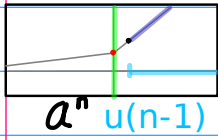

(4) 0011

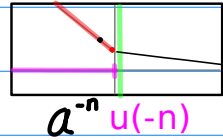

(7') 1110

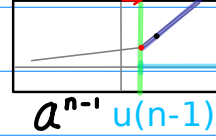

(4') 1011

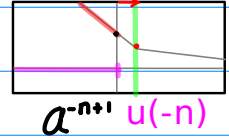

$$a^n R(n) \longleftrightarrow a^{-n} \overline{R(n)}$$

$$a^n R(n) \longleftrightarrow a^{-n} \overline{R(n)}$$

$$a^n \longleftrightarrow a^{-n}$$

$$R(n) \longleftrightarrow \overline{R(n)}$$

$$a^n \longleftrightarrow a^{-n}$$

$$R(n) \longleftrightarrow \overline{R(n)}$$





