

# Z Transform (H.1)

## Definition

20170123

Copyright (c) 2016 Young W. Lim.

Permission is granted to copy, distribute and/or modify this document under the terms of the GNU Free Documentation License, Version 1.2 or any later version published by the Free Software Foundation; with no Invariant Sections, no Front-Cover Texts, and no Back-Cover Texts. A copy of the license is included in the section entitled "GNU Free Documentation License".

Based on  
Complex Analysis for Mathematics and Engineering  
J. Mathews

# z - Transform

$$X(z) = \sum_{k=-\infty}^{+\infty} x[k] z^{-k}$$

$$z = |r| e^{j2\pi F} = |r| e^{j\Omega}$$

$$x[n] \longleftrightarrow X(z)$$

One Sided z-transform

$$X(z) = \sum_{k=0}^{+\infty} x[k] z^{-k}$$

# Inverse z-Transform

$$X(z) = \mathcal{Z}\left[\{x_n\}_{n=0}^{\infty}\right] = \sum_{n=0}^{\infty} x_n z^{-n} = \sum_{n=0}^{\infty} x[n] z^{-n}$$

$$x_n = x[n] = \mathcal{Z}^{-1}[X(z)] = \frac{1}{2\pi i} \int_C X(z) z^{n+1} dz$$

# Admissible Form of $z$ -transform

$$X(z) = \sum_{k=0}^{\infty} x[n] z^{-n}$$

admissible  $z$ -transform

if  $X(z)$  is a rational function

$$X(z) = \frac{P(z)}{Q(z)} = \frac{b_0 + b_1 z^1 + b_2 z^2 + \dots + b_{p-1} z^{p-1} + b_p z^p}{a_0 + a_1 z^1 + a_2 z^2 + \dots + a_{q-1} z^{q-1} + a_q z^q}$$

$P(z)$  : a polynomial of degree  $p$

$Q(z)$  : a polynomial of degree  $q$

D: Simply connected domain

C: Simple closed contour (CCW) in D

if  $f(z)$  is analytic inside C and on C  
except at the points  $z_1, z_2, \dots, z_k$  in C

then

$$\frac{1}{2\pi i} \int_C f(z) dz = \sum_{j=1}^k \text{Res}(f(z), z_j)$$

$$\oint_C f(z) dz = 2\pi i \sum_{k=1}^n \text{Res}(f(z), z_k)$$

finite number  $k$  of  
singular points  $z_k$

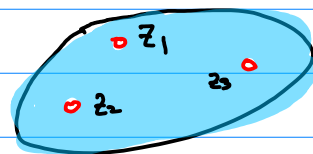

$$\oint_C f(z) dz = 0$$

if  $f(z)$  is continuous in  $D$  and

$f(z) = F'(z)$  :  $F(z)$  is an antiderivative of  $f(z)$

fundamental theorem of calculus

$$\oint_C f(z) dz = 0$$

if  $f(z)$  is analytic within and on  $C$

no singularity

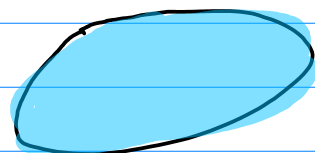

$$f(z) = \sum_{n=n_1}^{\infty} a_n^{(m)} (z - z_m)^n$$

$$\begin{aligned} a_n^{(m)} &= \frac{1}{2\pi i} \oint_C \frac{f(z')}{(z' - z_m)^{n+1}} dz' \\ &= \sum_k \operatorname{Res} \left( \frac{f(z)}{(z - z_m)^{n+1}}, z_k \right) \quad z_k \text{ within } C \\ &= \frac{1}{n!} f^{(n)}(z_m) \quad n \geq 0 \end{aligned}$$

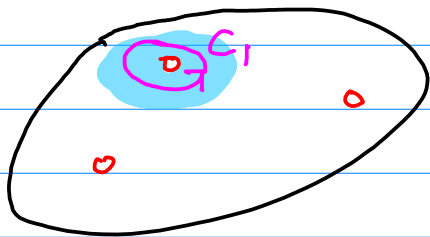

$a_n^{(0)}$  expansion at  $z_0$

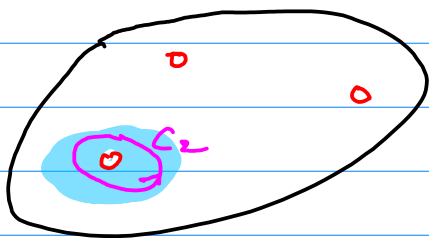

$a_n^{(1)}$  expansion at  $z_1$

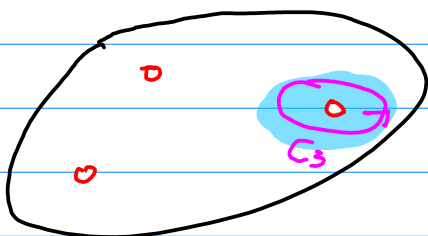

$a_n^{(2)}$  expansion at  $z_2$



$$a_n^{(m)} = \text{Res}(f(z), z_m)$$

the residue of  $f(z)$  at  $z_m$  using  $C_m$

assumed that

there are several ( $m$ ) singularities (poles) of  $f(z)$  in a region

but that

$C$  is taken to enclose only the pole  $z_m$  :  $C_m$

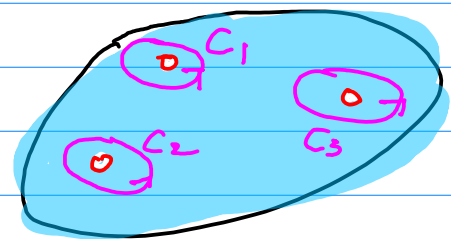
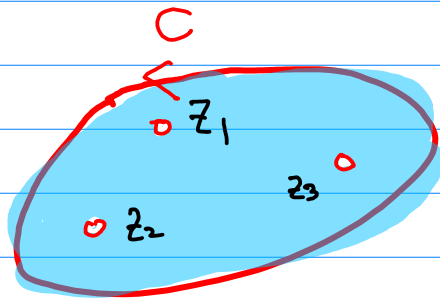

## Laurent's Theorem

$f$ : analytic within the annular domain  $D$

$$r < |z - z_0| < R$$

then

$$f(z) = \sum_{k=-\infty}^{+\infty} a_k (z - z_0)^k, \text{ valid for } r < |z - z_0| < R$$

$$a_k = \frac{1}{2\pi i} \oint_C \frac{f(s)}{(s - z_0)^{k+1}} ds, \quad k = 0, \pm 1, \pm 2, \dots$$

$C$ : a simple closed curve  
that lies entirely within  $D$   
that encloses  $z_0$

$$a_{-1} = \frac{1}{2\pi i} \oint_C f(s) ds \quad \rightarrow \quad \oint_C f(s) ds = 2\pi i \cdot a_{-1}$$

$$a_{-1} = \frac{1}{2\pi i} \oint_C f(s) ds = \text{Res}(f(z), z_0)$$

$$= \begin{cases} \lim_{z \rightarrow z_0} (z - z_0) f(z) & \text{(simple)} \\ \frac{1}{(n-1)!} \lim_{z \rightarrow z_0} \frac{d^{n-1}}{dz^{n-1}} (z - z_0)^n f(z) & \text{(order } n) \end{cases}$$

## Cauchy's Residue Theorem

$f(z)$ : **analytic** on and within  $C$   
except a finite number of **singular points**  
 $z_1, z_2, \dots, z_n$  within  $C$

then

$$\int_C f(z) dz = 2\pi i \sum_{k=1}^n \text{Res}(f(z), z_k)$$

$D$ : a simply connected domain

$C$ : a simple closed contour in  $D$

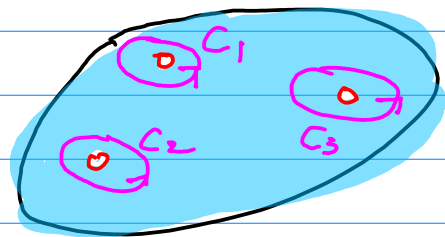
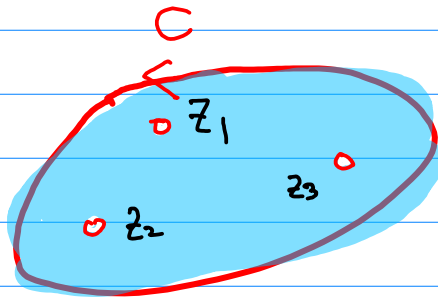

$z_1$

$$f(z) = \sum_{k=-\infty}^{+\infty} a_k (z - z_1)^k$$

$$a_{-1}^{z_1} = \frac{1}{2\pi i} \oint_{C_1} f(s) ds = \text{Res}(f(z), z_1)$$

$z_2$

$$f(z) = \sum_{k=-\infty}^{+\infty} a_k (z - z_2)^k$$

$$a_{-1}^{z_2} = \frac{1}{2\pi i} \oint_{C_2} f(s) ds = \text{Res}(f(z), z_2)$$

$z_3$

$$f(z) = \sum_{k=-\infty}^{+\infty} a_k (z - z_3)^k$$

$$a_{-1}^{z_3} = \frac{1}{2\pi i} \oint_{C_3} f(s) ds = \text{Res}(f(z), z_3)$$

$z_1$

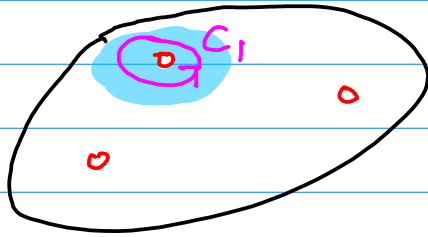

Laurent series expansion at  $z_1$

$$f(z) = \sum_{k=-\infty}^{+\infty} a_k (z - z_1)^k$$

$$a_{-1} = \frac{1}{2\pi i} \oint_{C_1} f(s) ds = \text{Res}(f(z), z_1)$$

$z_2$

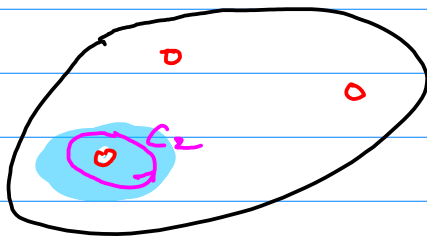

Laurent series expansion at  $z_2$

$$f(z) = \sum_{k=-\infty}^{+\infty} a_k (z - z_2)^k$$

$$a_{-1} = \frac{1}{2\pi i} \oint_{C_2} f(s) ds = \text{Res}(f(z), z_2)$$

$z_3$

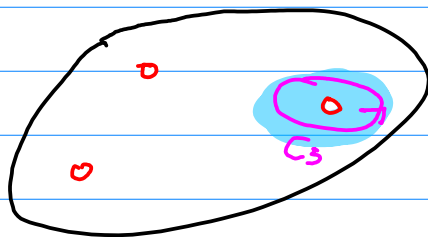

Laurent series expansion at  $z_3$

$$f(z) = \sum_{k=-\infty}^{+\infty} a_k (z - z_3)^k$$

$$a_{-1} = \frac{1}{2\pi i} \oint_{C_3} f(s) ds = \text{Res}(f(z), z_3)$$

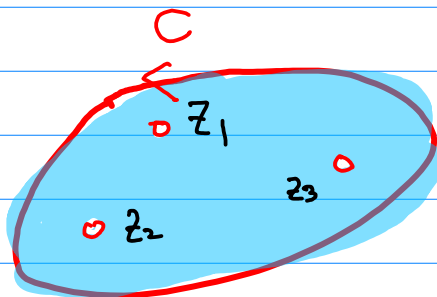

$$\int_C f(z) dz = 2\pi i \sum_{k=1}^n \text{Res}(f(z), z_k)$$

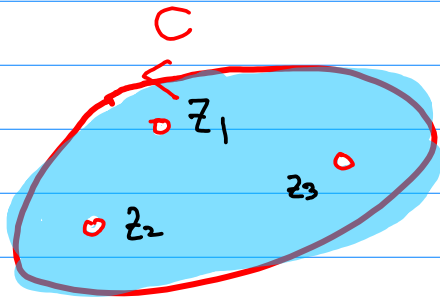

$$\int_C f(z) dz = 2\pi i \operatorname{Res}(f(z), z_1) + 2\pi i \operatorname{Res}(f(z), z_2) + 2\pi i \operatorname{Res}(f(z), z_3)$$

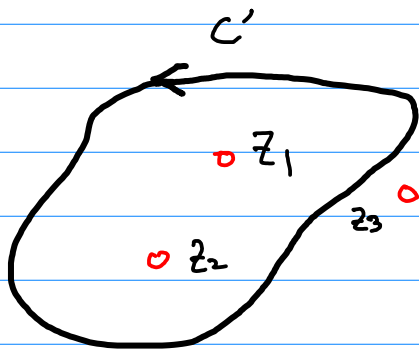

$$\int_{C'} f(z) dz = 2\pi i \operatorname{Res}(f(z), z_1) + 2\pi i \operatorname{Res}(f(z), z_2)$$

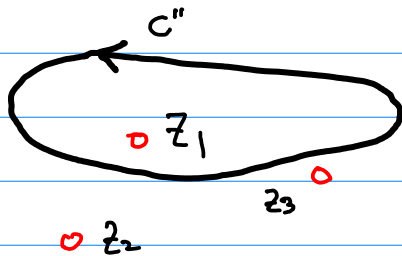

$$\int_{C''} f(z) dz = 2\pi i \operatorname{Res}(f(z), z_1)$$

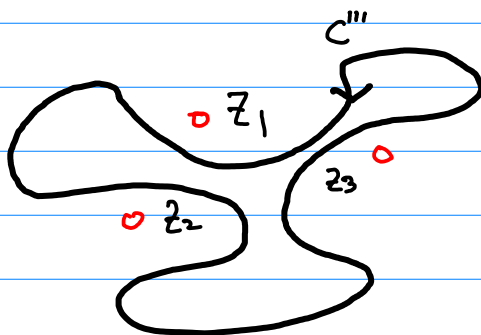

$$\int_{C'''} f(z) dz = 0$$

# Different $D$ , Different Laurent Series

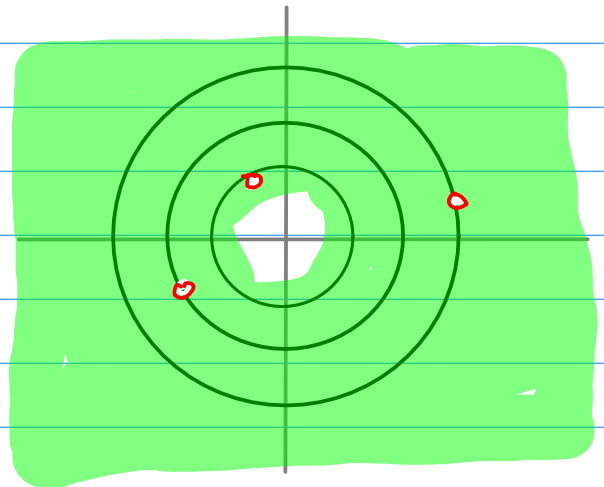
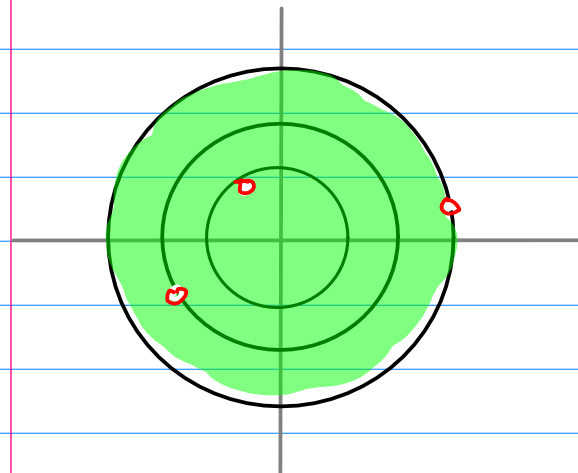
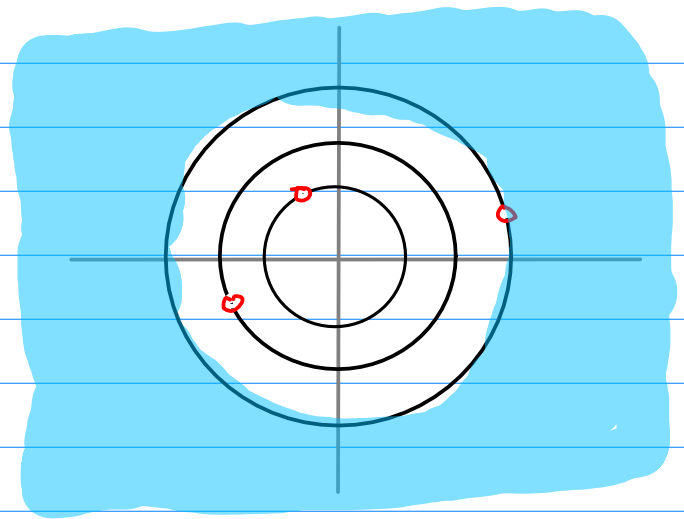
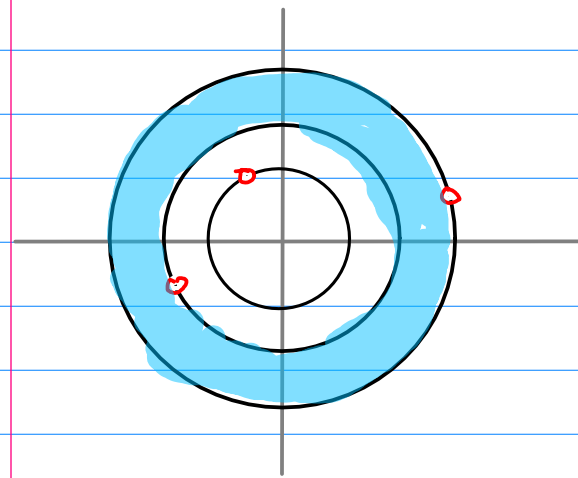
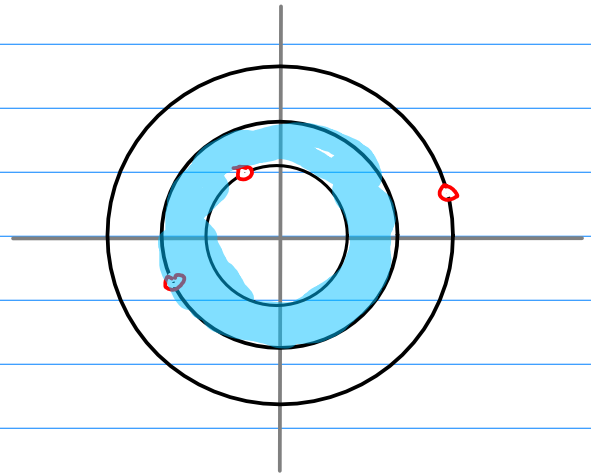
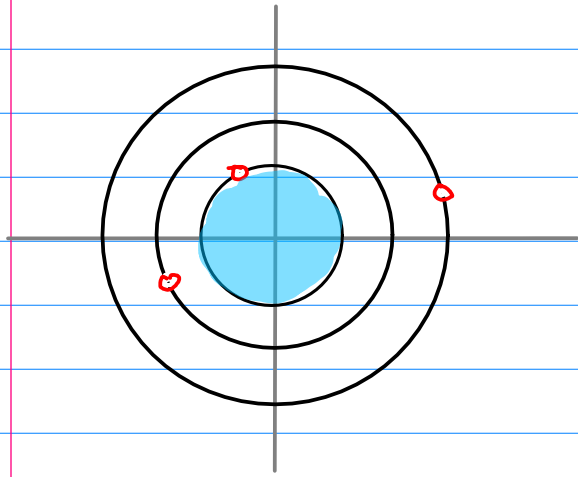

$z$ -transform

$$f(z) = \frac{12}{z(2-z)(1+z)} = \frac{4}{z} \left( \frac{1}{1+z} + \frac{1}{2-z} \right)$$

pole:  $z=0$ ,  $z=2$ ,  $z=-1$

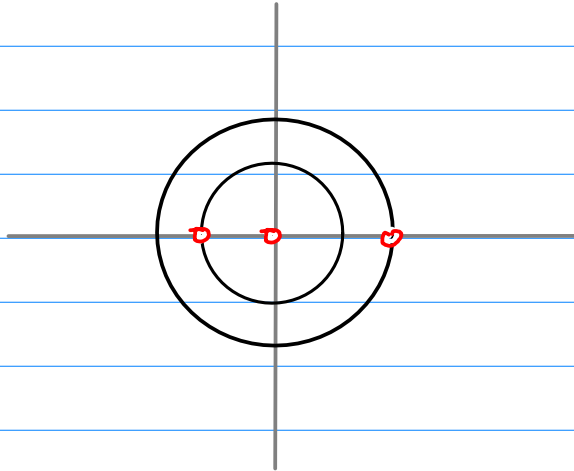

$$0 < |z| < 1$$

$$f(z) = -3 + 9z/2 - 15z^2/4 + 33z^3/8 + \dots + 6/z$$

$$|z| > 2$$

$$\frac{1}{1+z} = \frac{1}{z} \frac{1}{(1+z^{-1})} \quad \frac{1}{2+z} = -\frac{1}{z} \frac{1}{1-2z^{-1}}$$

$$f(z) = -(12/z^3) (1 + 1/z + 3/z^2 + 5/z^3 + 11/z^4 + \dots)$$



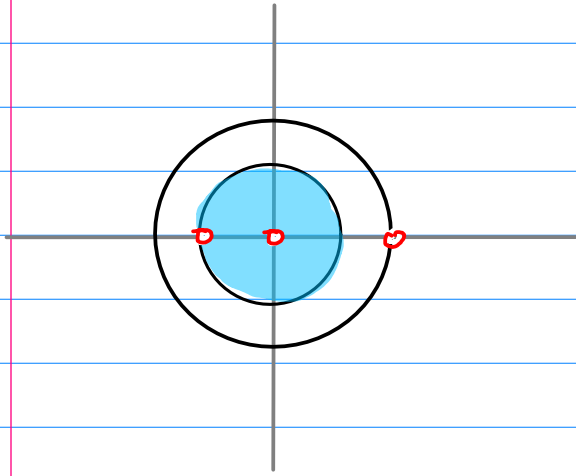

$$0 < |z| < 1$$

$$f(z) = -3 + 9z/2 - 15z^2/4 + 33z^3/8 + \dots + 6/z$$

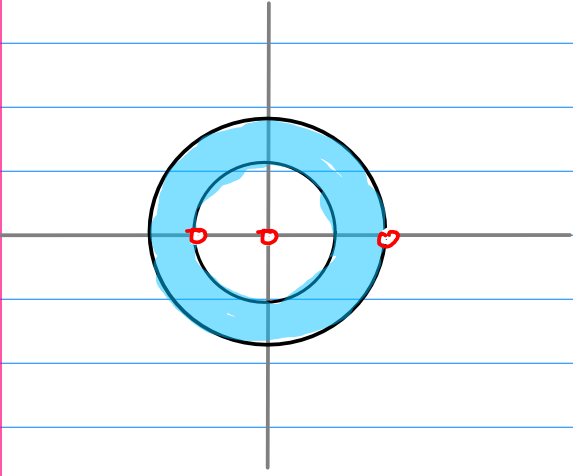

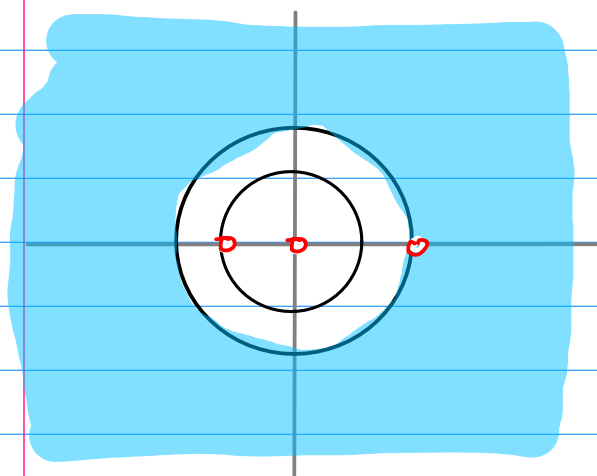

$$|z| > 2$$

$$\frac{1}{1+z} = \frac{1}{z} \frac{1}{(1+z^{-1})}$$

$$\frac{1}{2+z} = -\frac{1}{z} \frac{1}{1-2z^{-1}}$$

$$f(z) = \frac{-1}{(z-1)(z-2)} = \frac{1}{z-1} - \frac{1}{z-2}$$

$$D_1: |z| < 1$$

$$D_2: 1 < |z| < 2$$

$$D_3: 2 < |z|$$

$$\textcircled{1} D_1 \quad |z| < 1, \quad \left|\frac{z}{2}\right| < 1$$

$$\begin{aligned} f(z) &= \frac{1}{z-1} - \frac{1}{z-2} = \frac{-1}{1-z} + \frac{1}{1-\left(\frac{z}{2}\right)} \\ &= -\sum_{n=0}^{\infty} z^n + \sum_{n=0}^{\infty} \frac{z^n}{2^{n+1}} = \sum_{n=0}^{\infty} (2^{-n-1} - 1)z^n \quad |z| < 1 \end{aligned}$$

$$\textcircled{2} D_2 \quad 1 < |z| < 2 \Rightarrow \left|\frac{1}{z}\right| < 1, \quad \left|\frac{z}{2}\right| < 1$$

$$\begin{aligned} f(z) &= \frac{1}{z-1} - \frac{1}{z-2} = \frac{1}{z} \cdot \frac{1}{1-\left(\frac{1}{z}\right)} + \frac{1}{2} \frac{1}{1-\left(\frac{z}{2}\right)} \\ &= \sum_{n=0}^{\infty} \frac{1}{z^{n+1}} + \sum_{n=0}^{\infty} \frac{z^n}{2^{n+1}} \\ &= \sum_{n=1}^{\infty} \frac{1}{z^n} + \sum_{n=0}^{\infty} \frac{z^n}{2^{n+1}} \end{aligned}$$

$$\textcircled{3} D_3 \quad 2 < |z| \quad \left|\frac{z}{2}\right| < 1 \quad \left|\frac{1}{z}\right| < 1$$

$$\begin{aligned} f(z) &= \frac{1}{z-1} - \frac{1}{z-2} = \frac{1}{z} \frac{1}{1-\left(\frac{1}{z}\right)} - \frac{1}{z} \frac{1}{1-\left(\frac{z}{2}\right)} \\ &= \sum_{n=0}^{\infty} \frac{1}{z^{n+1}} - \sum_{n=0}^{\infty} \frac{z^n}{z^{n+1}} = \sum_{n=0}^{\infty} \frac{1-2^n}{z^{n+1}} \\ &= \sum_{n=1}^{\infty} \frac{1-2^{n-1}}{z^n} \end{aligned}$$

①  $D_1$   $|z| < 1$ ,  $|\frac{z}{2}| < 1$

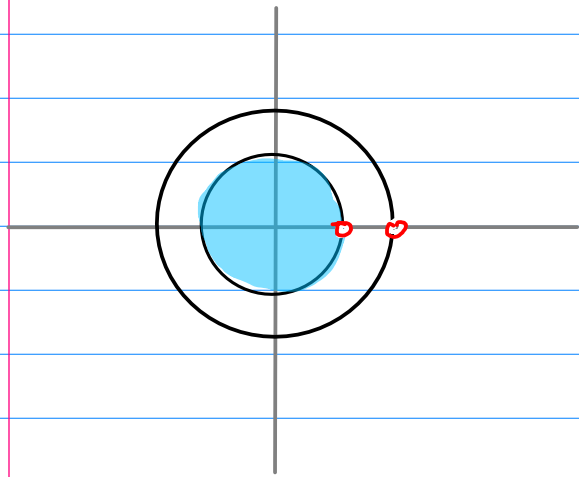

$$f(z) = \frac{1}{z-1} - \frac{1}{z-2} = \frac{-1}{1-z} + \frac{1}{1-\left(\frac{z}{2}\right)}$$

$$= -\sum_{n=0}^{\infty} z^n + \sum_{n=0}^{\infty} \frac{z^n}{2^{n+1}} = \sum_{n=0}^{\infty} (2^{-n-1} - 1)z^n \quad |z| < 1$$

$$\textcircled{2} \quad D_2 \quad 1 < |z| < 2 \Rightarrow \left| \frac{1}{z} \right| < 1, \quad \left| \frac{z}{2} \right| < 1$$

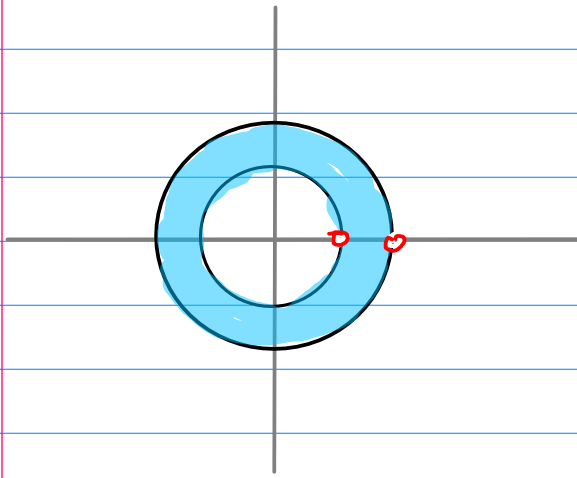

$$\begin{aligned} f(z) &= \frac{1}{z-1} - \frac{1}{z-2} = \frac{1}{z} \cdot \frac{1}{1-\left(\frac{1}{z}\right)} + \frac{1}{2} \frac{1}{1-\left(\frac{z}{2}\right)} \\ &= \sum_{n=0}^{\infty} \frac{1}{z^{n+1}} + \sum_{n=0}^{\infty} \frac{z^n}{2^{n+1}} \\ &= \sum_{n=1}^{\infty} \frac{1}{z^n} + \sum_{n=0}^{\infty} \frac{z^n}{2^{n+1}} \end{aligned}$$

③  $D_3 \quad 2 < |z| \quad \left| \frac{2}{z} \right| < 1 \quad \left| \frac{1}{z} \right| < 1$

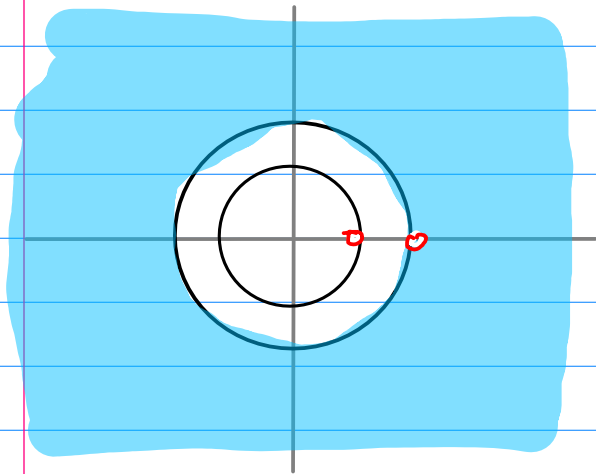

$$\begin{aligned} f(z) &= \frac{1}{z-1} - \frac{1}{z-2} = \frac{1}{z} \frac{1}{1-(\frac{1}{z})} - \frac{1}{z} \frac{1}{1-(\frac{2}{z})} \\ &= \sum_{n=0}^{\infty} \frac{1}{z^{n+1}} - \sum_{n=0}^{\infty} \frac{2^n}{z^{n+1}} = \sum_{n=0}^{\infty} \frac{1-2^n}{z^{n+1}} \\ &= \sum_{n=1}^{\infty} \frac{1-2^{n-1}}{z^n} \end{aligned}$$

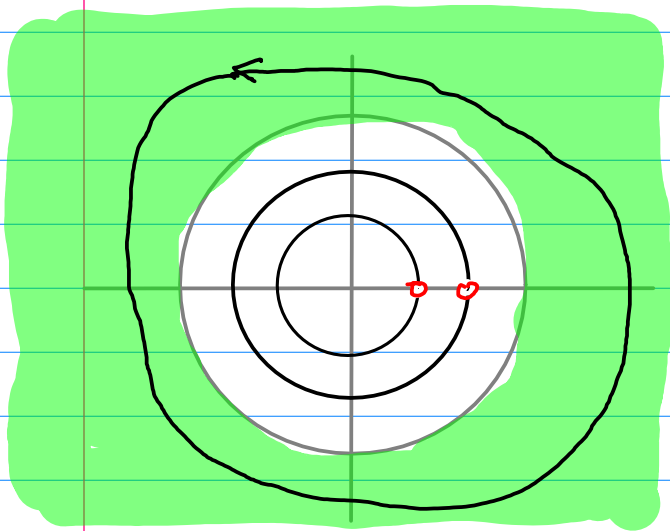

$$x[n]$$

$$= \frac{1}{2\pi i} \int_C \boxed{X(z) z^{n-1}} dz$$

$$= \sum_{j=1}^k \text{Res}(\boxed{X(z) z^{n-1}}, z_j)$$

$$X(z) = \frac{-1}{(z-1)(z-2)}$$

$$X(z) z^{n-1} = \frac{-1}{(z-1)(z-2)} z^{n-1}$$

$$\text{Res}(\boxed{X(z) z^{n-1}}, 1) = (z-2) \frac{-1}{(z-1)(z-2)} z^{n-1} \Big|_{z=1} = 1$$

$$\text{Res}(\boxed{X(z) z^{n-1}}, 2) = (z-1) \frac{-1}{(z-1)(z-2)} z^{n-1} \Big|_{z=2} = -2^{n-1}$$

$$x[n] = 1 - 2^{n-1}$$



$$f(z) = \sum_{n=n_1}^{\infty} a_n (z - z_m)^n$$

$$a_n = \frac{1}{2\pi i} \oint_C \frac{f(z')}{(z' - z_m)^{n+1}} dz'$$

$$= \sum_k \text{Res} \left( \frac{f(z)}{(z - z_m)^{n+1}}, z_k \right)$$



$C$  is in the same region of analyticity of  $f(z)$   
typically a circle centered on  $z_m$

$z_k$  within  $C$  : singularities of  $\frac{f(z)}{(z - z_m)^{n+1}}$

$n_1 = n_{f,m}$  depends on  $f(z)$ ,  $z_m$

$a_n$  depends on  $f(z)$ ,  $z_m$ , region of analyticity

Whether  $f(z)$  is singular at  $z = z_m$  or not

or at other points between  $z$  and  $z_m$

We can expand  $f(z)$  about any point  $z_m$

over powers of  $(z - z_m)$ .

$$f(z) = \sum_{n=-\infty}^{\infty} a_n^{(m)} (z - z_m)^n$$

$$a_n^{(m)} = \frac{1}{2\pi i} \oint_C \frac{f(z')}{(z' - z_m)^{n+1}} dz'$$

$$= \sum_k \operatorname{Res} \left( \frac{f(z)}{(z - z_m)^{n+1}}, z_k \right)$$

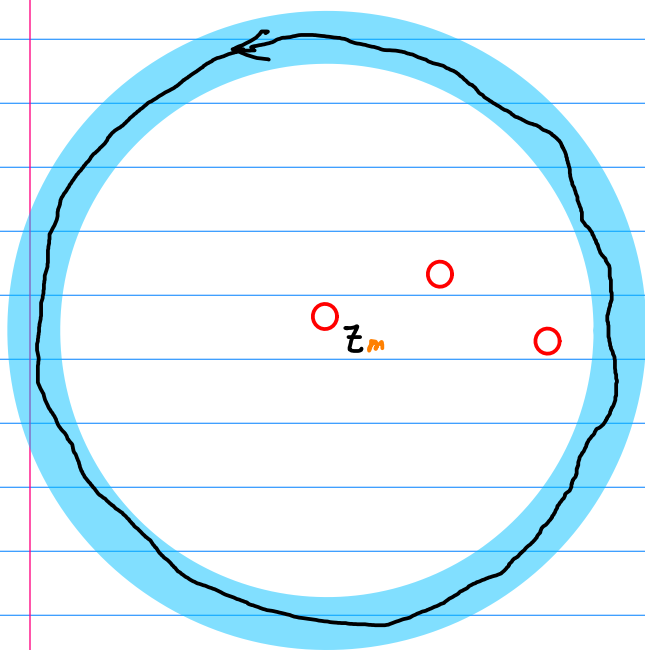
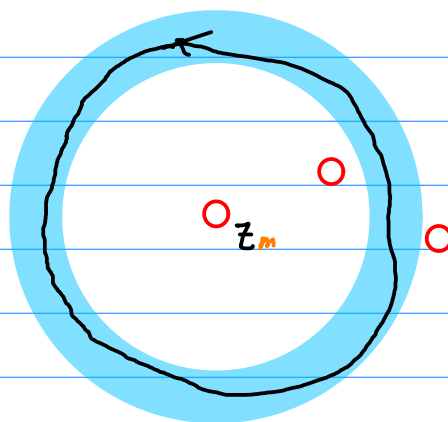
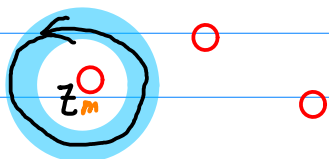

$$f(z) = \sum_{n=n_1}^{\infty} a_n^{\{m\}} (z - z_m)^n$$

$$a_n^{\{m\}} = \frac{1}{2\pi i} \oint_C \frac{f(z')}{(z' - z_m)^{n+1}} dz'$$

$$= \sum_k \operatorname{Res} \left( \frac{f(z)}{(z - z_m)^{n+1}}, z_k \right)$$

Analytic at  $z_m$

$$n_1 \geq 0$$

$$\text{general } n_1, \quad z_m = 0$$

Taylor Series

MacLaurin Series

Singular at  $z_m$

$$\text{general } n_1$$

$$\text{general } n_1, \quad z_m = 0$$

Laurent Series

$z$ -Transform

$$f(z) = \sum_{n=-\infty}^{\infty} a_n^{(m)} (z - z_m)^n$$

$$a_n^{(m)} = \frac{1}{2\pi i} \oint_c \frac{f(z')}{(z' - z_m)^{n+1}} dz'$$

$$= \sum_k \operatorname{Res} \left( \frac{f(z)}{(z - z_m)^{n+1}}, z_k \right)$$

$$z_m = 0$$

$$a_{-n}^{(0)} = h(n)$$

$$n \rightarrow -n$$

$$H(z) = \sum_{n=-\infty}^{\infty} h(-n) z^n$$

$$h(n) = \frac{1}{2\pi i} \oint_c \frac{H(z')}{z'^{n+1}} dz'$$

$$= \sum_k \operatorname{Res} \left( \frac{H(z)}{z^{n+1}}, z_k \right)$$

$$H(z) = \sum_{n=-\infty}^{\infty} h(n) z^{-n}$$

$$h(n) = \frac{1}{2\pi i} \oint_c H(z') z'^{n-1} dz'$$

$$= \sum_k \operatorname{Res} (H(z) z^{n-1}, z_k)$$

$C$  is in the same region of analyticity of  $f(z)$   
typically a circle centered on  $z_m$

$z_k$  within  $C$  : singularities of  $\frac{f(z)}{(z-z_k)^{n+1}}$

$C$  is in the same region of analyticity of  $H(z)$   
typically a circle centered on  $z_m$

generally a circle centered on the origin  
may enclose any or all singularities of  $H(z)$   
often the unit circle

$z_k$  within  $C$  : singularities of  $H(z)z^{n-1}$

$$H(z) = \sum_{n=-\infty}^{\infty} h(n) z^{-n} \quad z \in \text{R.O.C.}$$

$$h(n) = \frac{1}{2\pi i} \oint_C H(z') z'^{n-1} dz' \quad C \text{ in R.O.C.}$$

$$= \sum_k \text{Res}(H(z') z'^{n-1}, z_k)$$

- ① a power series representation of a function  $f(z)$  of a complex variable  $z$
- ② a transform  $H(z)$  of a sequence of 1

$$X(z) = \frac{z}{z - \frac{1}{2}} \quad \text{pole } z_0 = \frac{1}{2}$$

$$\begin{aligned} x[n] &= \text{Res} \left( X(z) z^{n-1}, z_0 \right) = \text{Res} \left( \frac{z}{z - \frac{1}{2}} z^{n-1}, \frac{1}{2} \right) \\ &= \text{Res} \left( \frac{z^n}{z - \frac{1}{2}}, \frac{1}{2} \right) = \lim_{z \rightarrow \frac{1}{2}} (z - \frac{1}{2}) \frac{z^n}{z - \frac{1}{2}} = \left( \frac{1}{2} \right)^n \end{aligned}$$

$$x[n] = \frac{1}{2^n} \quad n \geq 0$$

$$\begin{aligned} \left( \frac{1}{2} \right)^0 z^0 + \left( \frac{1}{2} \right)^1 z^{-1} + \left( \frac{1}{2} \right)^2 z^{-2} + \left( \frac{1}{2} \right)^3 z^{-3} + \dots &= \frac{1}{1 - \left( \frac{1}{2} z^{-1} \right)} \\ &= \frac{z}{z - \frac{1}{2}} \end{aligned}$$

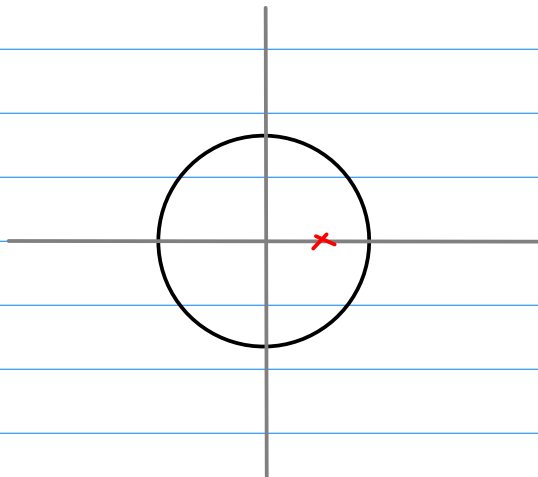

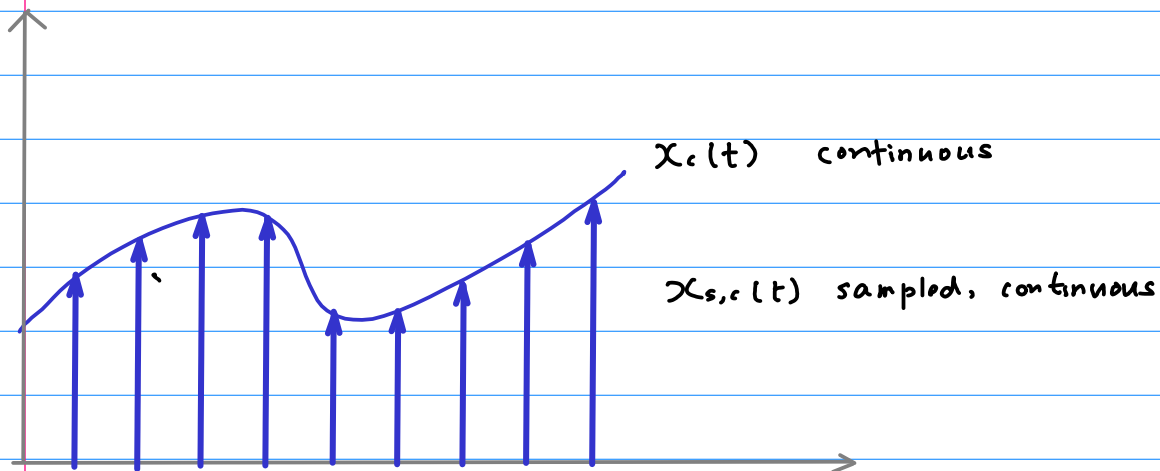

$$x_{s,c}(t) = \sum_{n=-\infty}^{+\infty} x(n) \delta_c(t - n\Delta t)$$

$$\begin{aligned} X_{s,c}(s) &= \mathcal{L}\{x_{s,c}(t)\} = \int_{-\infty}^{\infty} \boxed{\sum_{n=-\infty}^{+\infty} x(n) \delta_c(t - n\Delta t)} e^{-st} dt \\ &= \sum_{n=-\infty}^{+\infty} x(n) \int_{-\infty}^{\infty} \delta_c(t - n\Delta t) e^{-st} dt \\ &= \sum_{n=-\infty}^{+\infty} x(n) e^{-sn\Delta t} \quad e^{s\Delta t} \triangleq z \end{aligned}$$

$$X_{s,c}(s) = \sum_{n=-\infty}^{+\infty} x(n) z^{-n} \Big|_{z=e^{s\Delta t}}$$

$$X_{s,c}(s) = X(z) \Big|_{z=e^{s\Delta t}}$$



$$X_{s,c}(s) = \mathcal{L}\{x_{s,c}(t)\} = X(z) \Big|_{z=e^{s\Delta t}}$$

$x_{s,c}(t)$  an impulse train

whose coefficients are given by  $x[n] = x_c(n\Delta t)$

z-transform : a special Laurent series

$$z_m = 0$$

$$a_{-n}^{\{0\}} = h(n)$$

$$n \rightarrow -n$$

$$f(z) = \sum_{n=n_1}^{\infty} a_n^{\{m\}} (z - z_m)^n$$

$$a_n^{\{m\}} = \frac{1}{2\pi i} \oint_c \frac{f(z')}{(z' - z_m)^{n+1}} dz'$$

$$= \sum_k \operatorname{Res} \left( \frac{f(z)}{(z - z_m)^{n+1}}, z_k \right)$$

Time Reversal  $\leftarrow$  Laplace Transform

the transform functions

$$X(s) = \int \text{over negative powers } e^{-st} \quad \text{for } t > 0$$

$$X(z) = \int \text{over negative powers } z^{-n} \quad \text{for } n > 0$$

the time expansion functions

$$x(t) = \int \text{over negative powers } e^{-st} \quad \text{for } t > 0$$

$$x[n] = \int \text{over negative powers } z^{-n} \quad \text{for } n > 0$$

Time Reversal  $\leftarrow$   $z^{-1}$ : unit delay, char eq (modes in  $z^k$ )

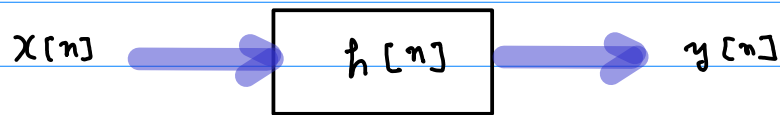

Stable system :  $h[n]$  must be absolutely summable

$$|e^{j\omega n}| = 1$$

$$|z^n| \quad z = 1$$

$$\infty > M_h > \sum_{n=-\infty}^{\infty} |h[n]| \quad \text{absolutely summable}$$

$$= \sum_{n=-\infty}^{+\infty} |h[n] e^{-j\omega n}|$$

$$\geq \left| \sum_{n=-\infty}^{+\infty} h[n] e^{-j\omega n} \right|$$

$$= \left| H(z) \Big|_{z=e^{j\omega}} \right|$$

$$\infty > \left| H(z) \Big|_{z=e^{j\omega}} \right|$$

a stable system,

$H(z)$  must converge on the unit circle  $|z|=1$

ROC (Region of Convergence) must include the unit circle

regardless of causality of  $h[n]$

$$H(z) \Big|_{|z|=1} = H(e^{j\hat{\omega}}) \quad \text{DTFT of } h[n]$$

discrete    all stable sequence must have convergent DTFTs

continuous    all stable signal must have convergent CTFTs

$$C \leftarrow \text{unit circle} \quad z = e^{j\hat{\omega}}$$

$ZT^{-1}$        $DTFT^{-1}$       identical formulas

$h[n]$  causal

$$H(z) = \sum_{n=-\infty}^{+\infty} h[n] z^{-n} = \sum_{n=0}^{+\infty} h[n] z^{-n} \quad n \in [0, \infty)$$

for finite values of  $n$ ,

each term must be finite as long as  $z \neq 0$

For the sum to converge,

$h[n] z^{-n}$  must vanish as  $n \rightarrow \infty$

$$|z| > r_h \quad z_h = r_h e^{j\theta}$$

$z_h^n$  is the largest magnitude

geometrically increasing component

$n^m z^n$  : the most general term

for impulse responses

$n \rightarrow \infty$   $z^n$  dominant over  $n^m$  for finite  $m$

Geometric components — as poles

$$\sum \{ z_0^n u[n] \} = \frac{1}{1 - \left(\frac{z_0}{z}\right)} = \frac{z}{z - z_0}$$

ROC of a causal sequence  $h[n]$

outside the radius of the largest magnitude pole of  $H(z)$

ROC of a causal signal  $h(t)$

to the right of the rightmost pole of  $H_c(s)$

if  $h[n]$  is a stable, causal sequence,

the unit circle must be included in the ROC

• Causal  $h[n]$

ROC: outside of  
a circle

• Stable  $h[n]$

all poles inside  
the unit circle

ROC circle must be

smaller than the unit circle

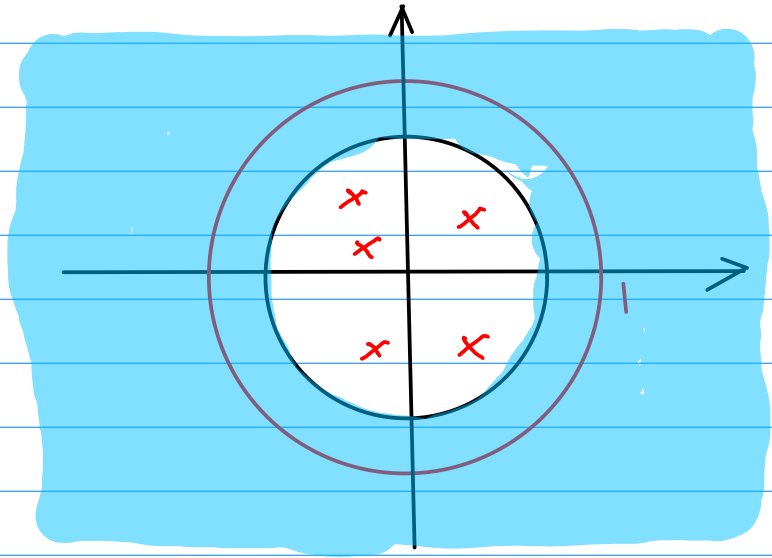

⇒ all the geometric components of  $h[n]$  : modes  
must decay with increasing  $n$

all the poles of  $H(z)$  must be within the unit circle

all the poles of  $H_c(s)$  must be in the left half plane

⊙ anti-causal  $h[n]$

ROC: inside of  
a circle

⊙ Stable  $h[n]$

all poles outside  
the unit circle

ROC circle must be

larger than the unit circle

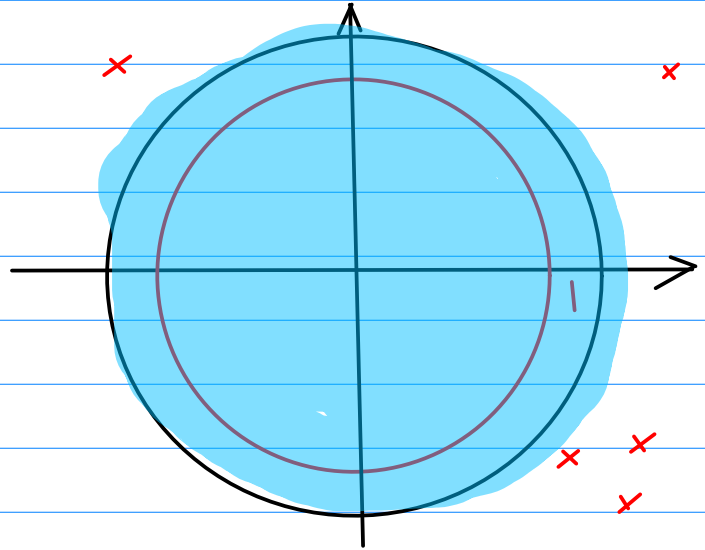

⇒ all the geometric components of  $h[n]$  : modes  
must decay with decreasing  $n$



• bi-causal  $h[n]$

$h_c[n] + h_{ac}[n]$

outside      inside

max mag < min mag

Overlapped ROC

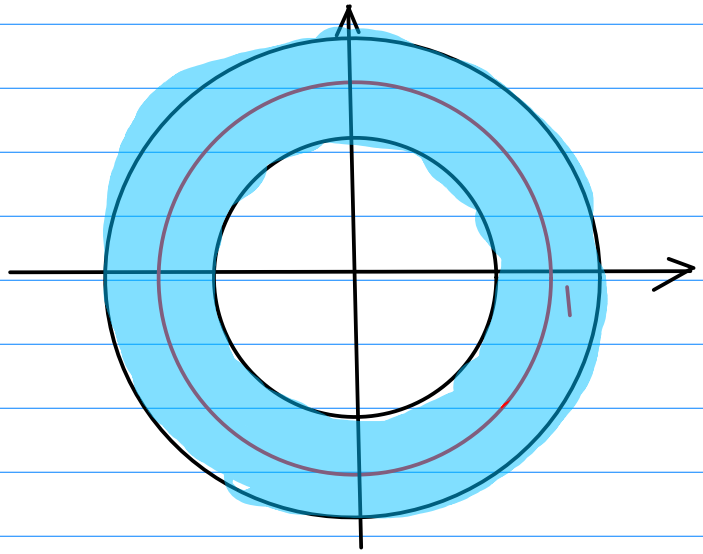

• Stable  $h[n]$

all poles outside

the unit circle

ROC circle must include the unit circle

## • bi-causal $h[n]$

$$h[n] = h_c[n] + h_{ac}[n]$$

causal comp.                      anti-causal comp

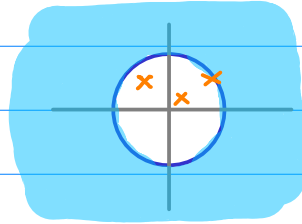

outside a circle

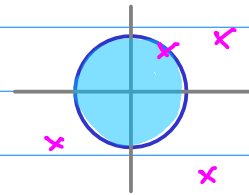

inside a circle

$$\text{max mag} < \text{min mag}$$

Overlapped ROC

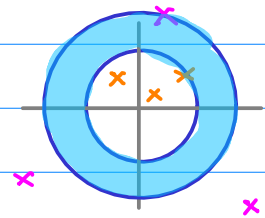

$$\text{max mag} > \text{min mag}$$

non-overlapping ROC

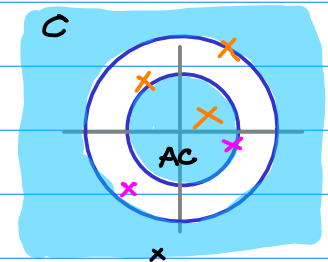

## • Stable $h[n]$

all poles outside the large circle  
inside the small circle

ROC circle must include the unit circle

only one annulus include the unit circle

only one stable sequence

# Existence of the z-Transform

$$X(z) = \sum_{n=0}^{\infty} x[n]z^{-n} = \sum_{n=0}^{\infty} \frac{x[n]}{z^n}$$

the existence of the z-transform is guaranteed if

$$|X(z)| \leq \sum_{n=0}^{\infty} \frac{|x[n]|}{|z|^n} < \infty \quad \text{for some } |z|$$

any signal  $x[n]$  that grows no faster than an exponential signal  $r_0^n$ , for some  $r_0$  satisfies the above condition

if  $|x[n]| \leq r_0^n$  for some  $r_0$

$$\text{then } |X(z)| \leq \sum_{n=0}^{\infty} \left(\frac{r_0}{|z|}\right)^n = \frac{1}{1 - \frac{r_0}{|z|}} \quad |z| > r_0$$

therefore  $X(z)$  exists for  $|z| > r_0$

Almost all practical signals satisfy this condition

$$|x[n]| \leq r_0^n \quad \text{for some } r_0$$

and z-transformable

Some signals (e.g.  $r^{n^2}$ ) grow faster than

the exponential signal  $r_0^n$  (for any  $r_0$ )

and do not satisfy this condition

and are not z-transformable

Such signals are of little practical or theoretical interest

Even such signals over a finite interval are z-transformable

# Region of Convergence

Laplace Transform	$Ae^{\alpha t}u(t)$	$\alpha > 0$
z - Transform	$A\alpha^n u[n]$	$ \alpha  > 0$
DTFT (X)		

$$X(z) = A \sum_{n=-\infty}^{\infty} \alpha^n u[n] z^{-n} = A \sum_{n=0}^{\infty} \alpha^n z^{-n} = A \sum_{n=0}^{\infty} \left(\frac{\alpha}{z}\right)^n$$

converge  $\left|\frac{\alpha}{z}\right| < 1$   $|z| > |\alpha|$   
open exterior of  
a circle of radius  $|\alpha|$

the sum of a geometric series

$$X(z) = A \frac{1}{1 - \frac{\alpha}{z}} = \frac{A}{1 - \alpha z^{-1}} = A \frac{z}{z - \alpha} \quad |z| > |\alpha|$$

DTFT

$$X(j\hat{\omega}) = \sum_{n=-\infty}^{+\infty} x[n] e^{-j\hat{\omega}n}$$

# DTFT

DTFT of the unit sequence  $u[n]$

$$X(e^{-j\hat{\omega}n}) = \sum_{n=-\infty}^{+\infty} u[n] e^{-j\hat{\omega}n} = \sum_{n=0}^{\infty} e^{-j\hat{\omega}n}$$

not converge

$$\hat{\omega} = 0 \quad \sum_{n=0}^{\infty} 1^n \quad \text{diverge}$$

$$\hat{\omega} = \pi \quad \sum_{n=0}^{\infty} (-1)^n \quad \text{oscillates}$$

$$\hat{\omega} = \frac{\pi}{2} \quad \sum_{n=0}^{\infty} (j)^n$$

The DTFTs of some commonly used functions do not exist in the strict sense.

But even though the DTFT does not exist, the  $z$ -transform does exist.

$$X(z) = \sum_{n=-\infty}^{+\infty} u[n] z^{-n} = \sum_{n=0}^{\infty} z^{-n}$$

$$|z| > 1 \quad X(z) = \frac{z}{z-1} = \frac{1}{1-z^{-1}}$$

$$X(z) = \frac{z}{z-1} \quad \text{pole } z=1, \quad \text{zero } z=0$$

$$X(z) = \frac{1}{1-z^{-1}} \quad \text{useful when a system is synthesized from a } z\text{-domain transfer function}$$

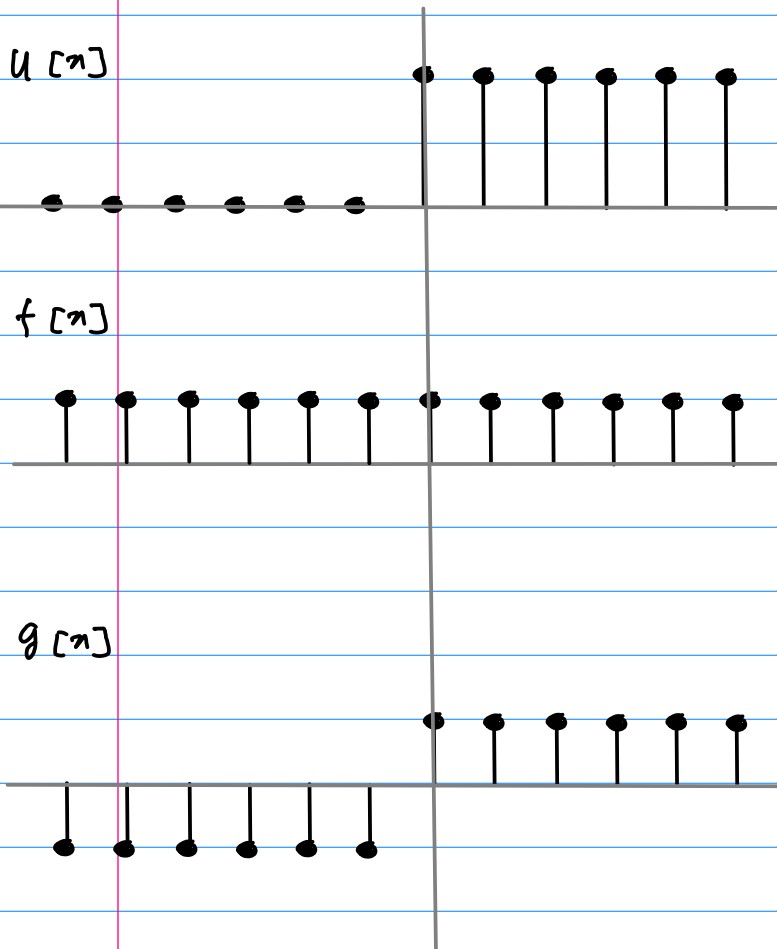

$$f[n] = \frac{1}{2} \quad -\infty < n < \infty$$

$$g[n] = \begin{cases} \frac{1}{2} & n \geq 0 \\ -\frac{1}{2} & n < 0 \end{cases}$$

$$u[n] = f[n] + g[n]$$

$$\delta[n] = g[n] - g[n-1]$$

$$1 = G(e^{j\omega}) - e^{-j\omega} G(e^{j\omega})$$

$$G(e^{j\omega}) = \frac{1}{1 - e^{-j\omega}}$$

$$F(e^{j\omega}) = \pi \sum_{k=-\infty}^{+\infty} \delta(\omega - 2\pi k) \quad (\text{impulse train})$$

$$U(e^{j\omega}) = \frac{1}{1 - e^{-j\omega}} + \pi \sum_{k=-\infty}^{+\infty} \delta(\omega - 2\pi k)$$

# Discrete Time Exponential $r^n$

continuous time exponential  $e^{\lambda t}$

$$\begin{aligned}e^{\lambda t} &= r^t & (e^\lambda)^t &= r^t \\e^\lambda &= r \\ \lambda &= \ln r\end{aligned}$$

$$\begin{aligned}e^{-0.03t} &= (0.9703)^t \\ 4^t &= e^{1.386t}\end{aligned}$$

continuous time analysis  $e^{\lambda t}$

discrete time analysis  $r^n$

$$\begin{aligned}e^{\lambda n} &= r^n & (e^\lambda)^n &= r^n \\e^\lambda &= r \\ \lambda &= \ln r\end{aligned}$$

$e^{\lambda n}$

Exponentially grows if  $\text{Re } \lambda > 0$  ( $\lambda$  in RHP)

exponentially decays if  $\text{Re } \lambda < 0$  ( $\lambda$  in LHP)

Oscillates or constant if  $\text{Re } \lambda = 0$  ( $\lambda$  in imag axis)

the location of  $\lambda$  in the complex plain indicates whether

①  $e^{\lambda t}$  will grow exponentially

②  $e^{\lambda t}$  will decay exponentially

③  $e^{\lambda t}$  will oscillates with constant amplitude

constant signal : oscillation with zero frequency

$e^{j\Omega n}$   $\lambda = j\Omega$  imaginary axis

(constant amplitude oscillating signal)

$$e^{j\Omega n} = (e^{j\Omega})^n = \gamma^n \quad \gamma = e^{j\Omega} \quad |\gamma| = 1$$

$\lambda = j\Omega$  imaginary axis  $\rightarrow |\gamma| = 1$  unit circle

if  $\gamma$  lies on the unit circle,

$\gamma^n$  oscillates with constant amplitude

the imaginary axis in the  $\lambda$  plane

the unit circle in the  $\gamma$  plane



$e^{\lambda n}$      $\lambda = a + jb$  in the LHP ( $a < 0$ )  
exponentially decaying

$$r = e^{\lambda} = e^{a+jb} = e^a e^{jb}$$

$$|r| = |e^{\lambda}| = |e^a \cdot e^{jb}| = |e^a| = e^a$$

$|r| = e^a < 1$     inside the Unit circle

$r^n$  : exponentially decaying

$|r| = e^a > 1$     outside the Unit circle

$r^n$  : exponentially growing

$\lambda$ -plane

the imaginary axis

the LHP

the RHP



$z$ -plane

the unit circle

inside of the unit circle

outside of the unit circle

