

# Laurent Series and z-Transform

## - Geometric Series

### Applications



20210112 Tue

Copyright (c) 2016 - 2020 Young W. Lim.

Permission is granted to copy, distribute and/or modify this document under the terms of the GNU Free Documentation License, Version 1.2 or any later version published by the Free Software Foundation; with no Invariant Sections, no Front-Cover Texts, and no Back-Cover Texts. A copy of the license is included in the section entitled "GNU Free Documentation License".

# Unshifted Geometric Sequences

Causal

$$\frac{1}{1 - az} \rightarrow u(n)$$

Anti-causal

$$\frac{1}{1 - az^{-1}} \rightarrow u(-n)$$

Positive Exponent

$$az, az^{-1} \rightarrow a^n$$

Negative Exponent

$$a^{-1}z, az^{-1} \rightarrow a^{-n}$$

Positive Exponent

unshifted

$$\frac{1}{1 - az} \quad |z| < a^{-1} \quad a^n u(n)$$

complementary

$$\frac{az}{1 - az} \quad |z| < a^{-1} \quad a^n u(n-1)$$

unshifted

$$-\frac{az^{-1}}{1 - az^{-1}} \quad |z| > a^{-1} \quad a^n u(-n-1)$$

complementary

$$-\frac{1}{1 - az^{-1}} \quad |z| > a^{-1} \quad a^n u(-n)$$

Negative Exponent

unshifted

$$\frac{1}{1 - a^{-1}z} \quad |z| < a \quad a^{-n} u(n)$$

complementary

$$\frac{a^{-1}z}{1 - a^{-1}z} \quad |z| < a \quad a^{-n} u(n-1)$$

unshifted

$$-\frac{az^{-1}}{1 - az^{-1}} \quad |z| > a \quad a^{-n} u(-n-1)$$

complementary

$$-\frac{1}{1 - az^{-1}} \quad |z| > a \quad a^{-n} u(-n)$$

# Numbering the basic elements - (1) CR

## unshifted geometric sequences

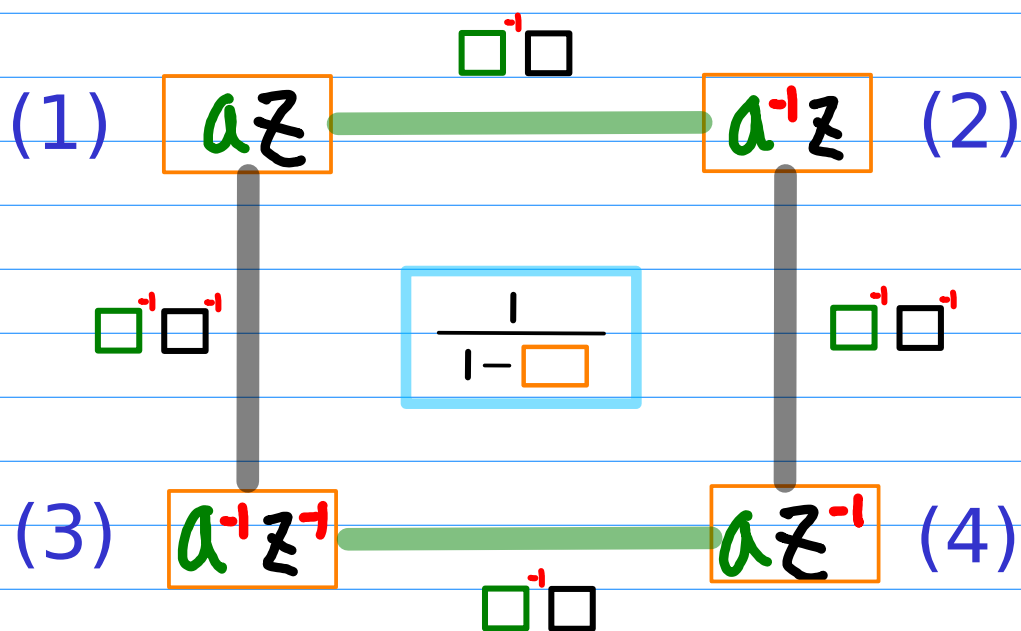

## complementary geometric sequences

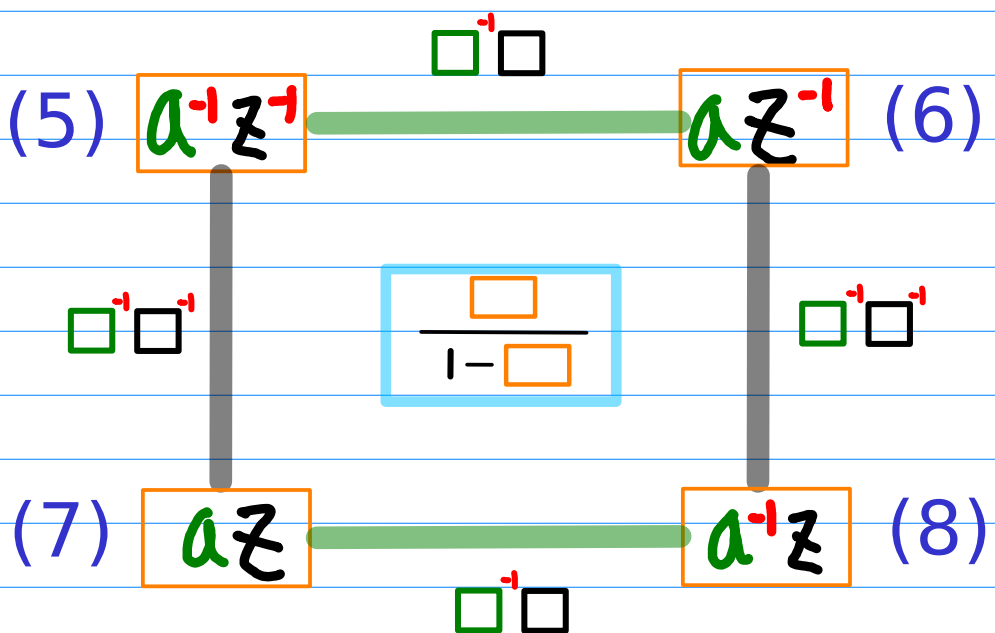

# Numbering the basic elements - (2) Power

## unshifted geometric sequences

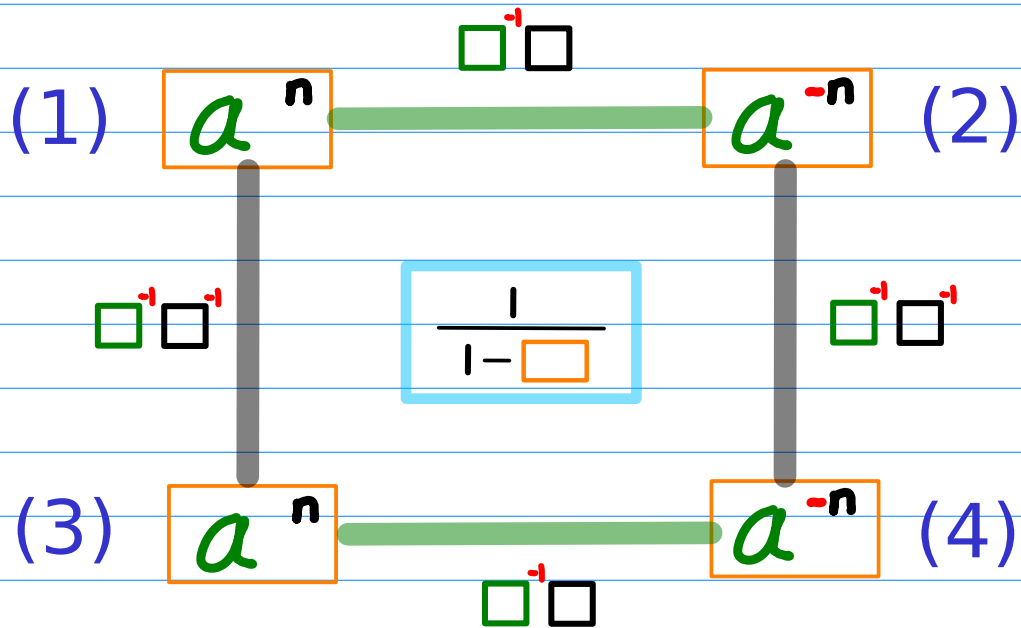

## complementary geometric sequences

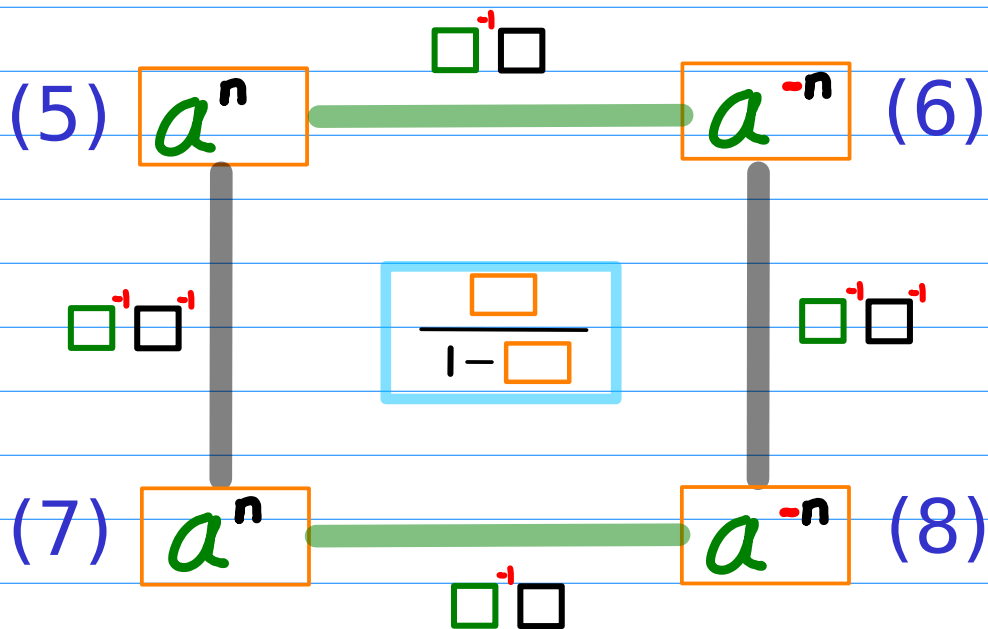

# Numbering the basic elements - (3) Range

## unshifted geometric sequences

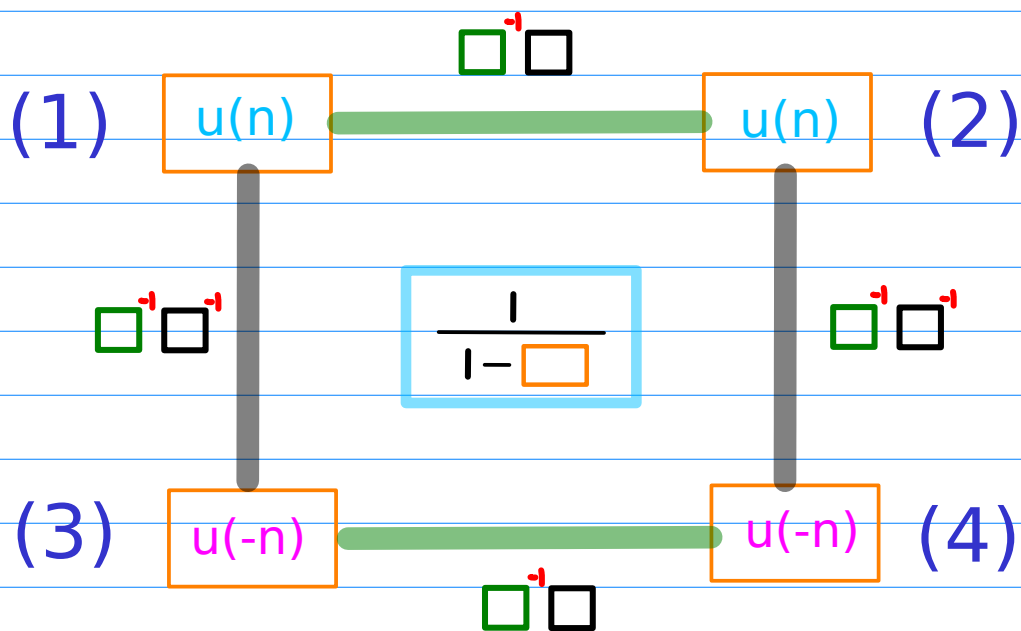

## complementary geometric sequences

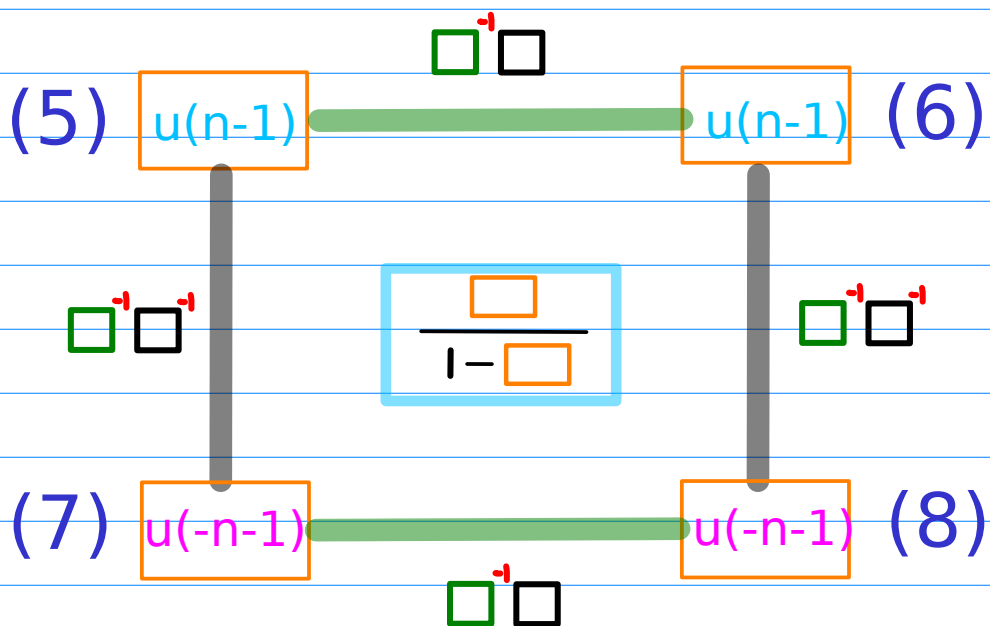

# Inverse Relations

inverse power  $\square^{\prime} \square$

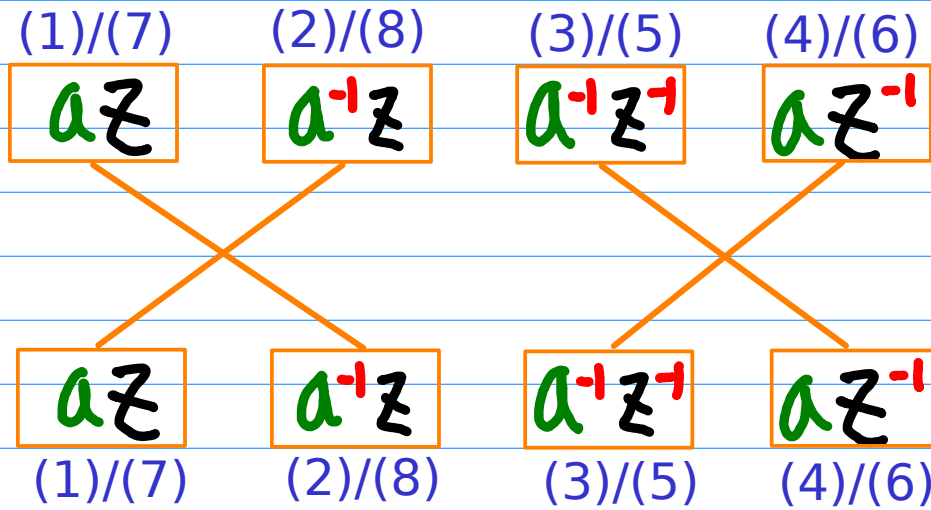

complementary  $\square^{\prime} \square^{\prime}$

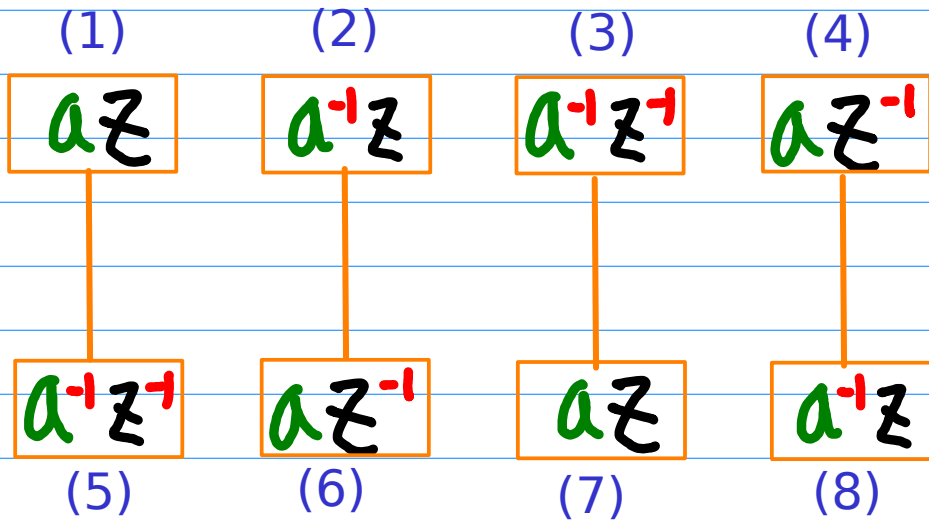

# Geometric Series Form Combinations with a unit start term unshifted

(1)  $\frac{1}{1 - az}$   $a^n u(n)$

(2)  $\frac{1}{1 - a^{-1}z}$   $a^{-n} u(n)$

(3)  $-\frac{1}{1 - a^{-1}z^{-1}}$   $-a^n u(-n)$

(4)  $-\frac{1}{1 - az^{-1}}$   $-a^{-n} u(-n)$

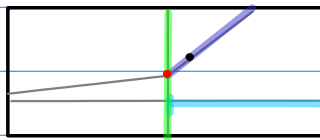

$a^n u(n)$

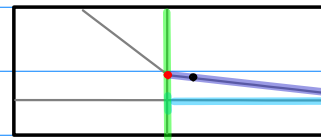

$a^{-n} u(n)$

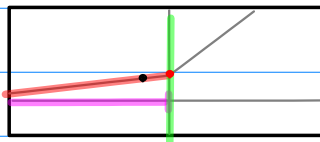

$a^n u(-n)$

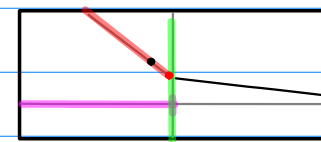

$a^{-n} u(-n)$



# Geometric Series Form Combinations with a common-ratio start term **unshifted, complementary**

$$(5) \quad \frac{a^{-1}z^{-1}}{1 - a^{-1}z^{-1}} \quad -a^n u(-n-1)$$

$$(6) \quad \frac{az^{-1}}{1 - az^{-1}} \quad -a^{-n} u(-n-1)$$

$$(7) \quad \frac{az}{1 - az} \quad a^n u(n-1)$$

$$(8) \quad \frac{a^{-1}z}{1 - a^{-1}z} \quad a^{-n} u(n-1)$$

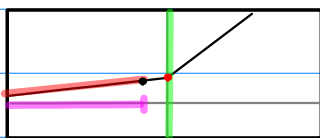

$$a^n u(-n-1)$$

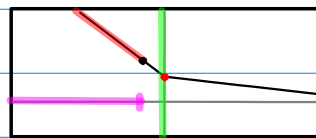

$$a^{-n} u(-n-1)$$

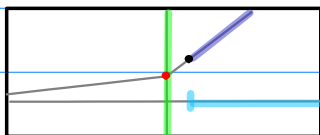

$$a^n u(n-1)$$

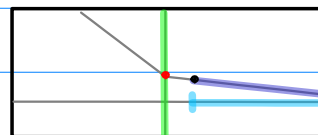

$$a^{-n} u(n-1)$$

# Complementary Relations

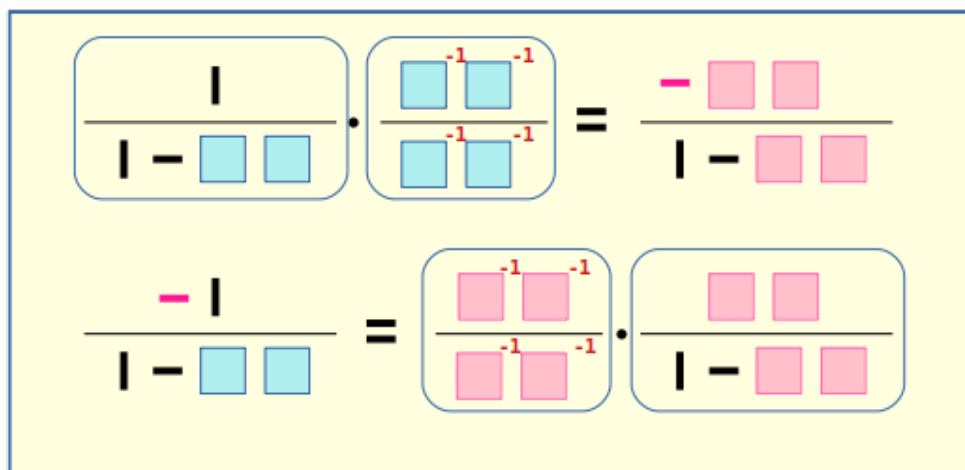
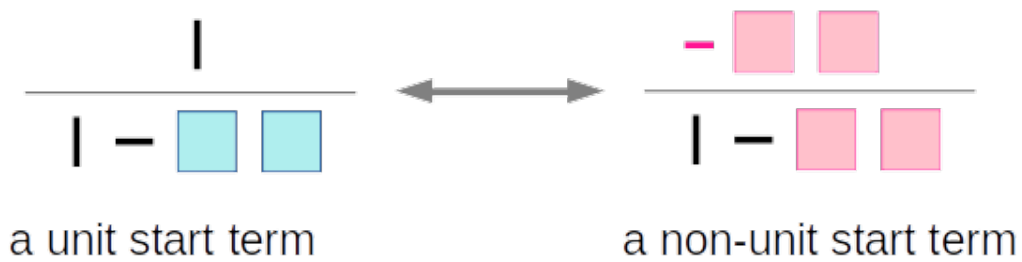
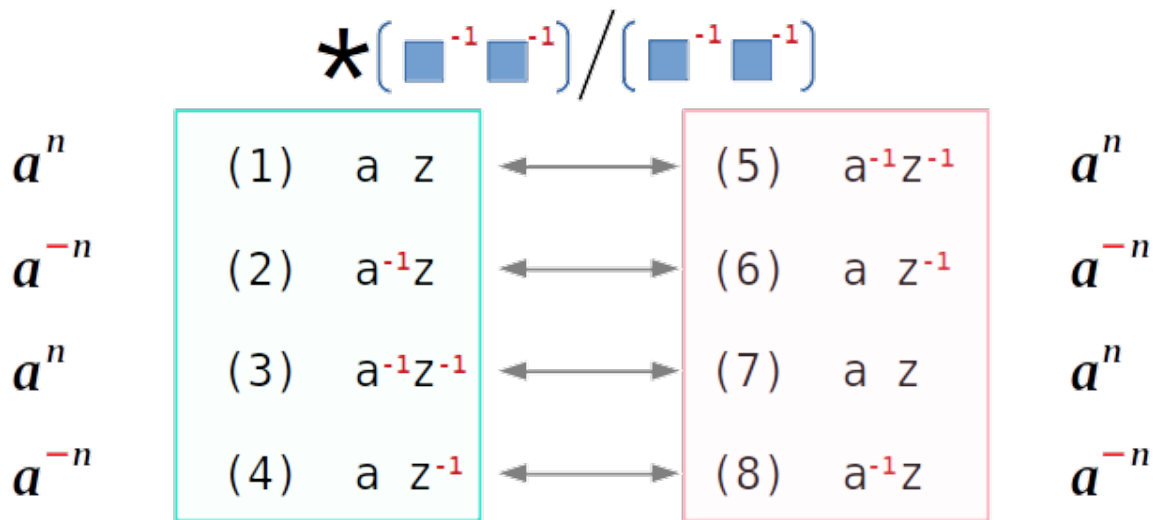

$$* \left( \begin{array}{cc} \square^{-1} & \square^{-1} \end{array} \right) / \left( \begin{array}{cc} \square^{-1} & \square^{-1} \end{array} \right)$$

$$(1) \quad a^{+1} z^{+1} \quad a^{+n} \cdot u(n)$$

$$(2) \quad a^{-1} z^{+1} \quad a^{-n} \cdot u(n)$$

$$(3) \quad a^{-1} z^{-1} \quad a^{+n} \cdot u(-n)$$

$$(4) \quad a^{+1} z^{-1} \quad a^{-n} \cdot u(-n)$$

$$(5) \quad a^{-1} z^{-1} \quad a^{+n} \cdot u(-n-1)$$

$$(6) \quad a^{+1} z^{-1} \quad a^{-n} \cdot u(-n-1)$$

$$(7) \quad a^{+1} z^{+1} \quad a^{+n} \cdot u(n-1)$$

$$(8) \quad a^{-1} z^{+1} \quad a^{-n} \cdot u(n-1)$$



a unit start term

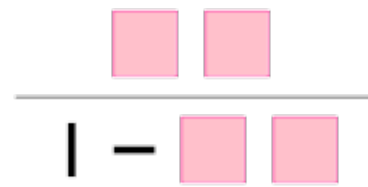

a non-unit start term

Positive Exponent	Negative Exponent
(1)	(2)
(3)	(4)
(5)	(6)
(7)	(8)

$u(n)$	(1)	(2)	Causal
$u(-n)$	(3)	(4)	Anti-Causal
$u(-n-1)$	(5)	(6)	Anti-Causal
$u(n-1)$	(7)	(8)	Causal

ranges include the origin	(1)	(2)	$u(n)$
	(3)	(4)	$u(-n)$
ranges exclude the origin	(5)	(6)	$u(-n-1)$
	(7)	(8)	$u(n-1)$

Complement Type I

$u(n)$	(1)	(2)	Causal
$u(-n)$	(3)	(4)	Anti-Causal
$u(-n-1)$	(5)	(6)	Anti-Causal
$u(n-1)$	(7)	(8)	Causal

Complement Type II

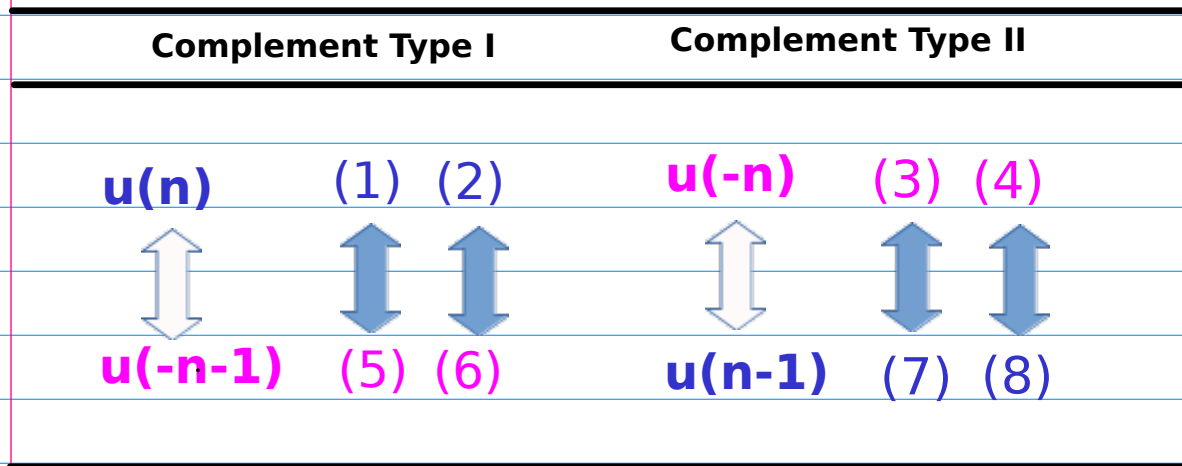

Complement Type I

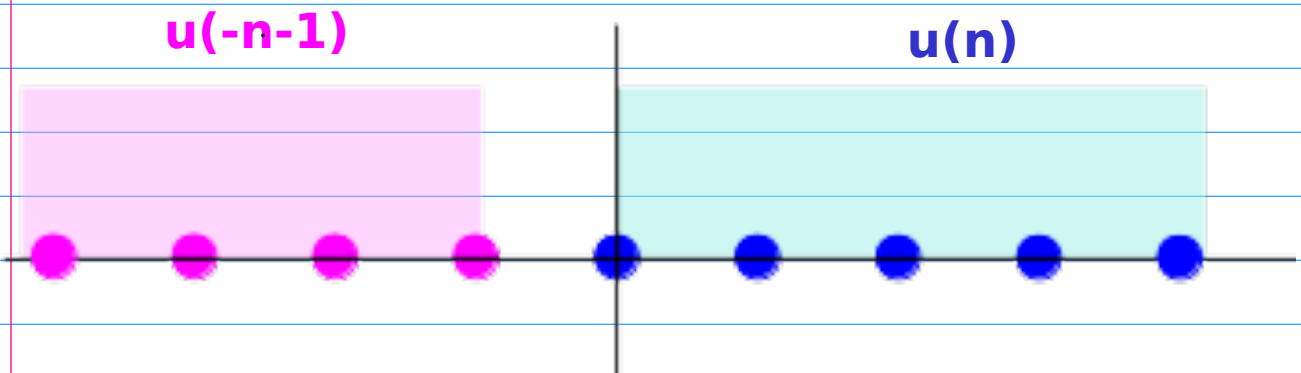

Complement Type II

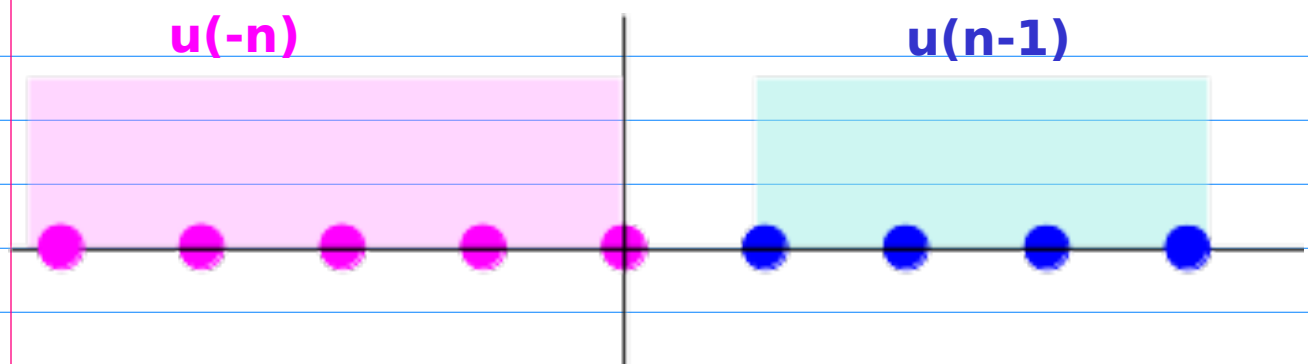

<b>Causal</b>	$u(n)$	(1)	(2)
	$u(n-1)$	(7)	(8)
<b>Anti-Causal</b>	$u(-n-1)$	(5)	(6)
	$u(-n)$	(3)	(4)

<b>Complement Type I</b>	$u(n)$	(1)	(2)
	$u(-n-1)$	(5)	(6)
<b>Complement Type II</b>	$u(-n)$	(3)	(4)
	$u(n-1)$	(7)	(8)

		<b>Positive Exponent</b>	<b>Negative Exponent</b>
<b>Complement Type I</b>	$u(n)$	(1)	(2)
	$u(-n-1)$	(5)	(6)
<b>Complement Type II</b>	$u(-n)$	(3)	(4)
	$u(n-1)$	(7)	(8)

# Shifted Geometric Sequences

## Exponent Shifting

$$* a$$

$$a^{n+1} \leftarrow a^n$$

Left Shift

$$a^{-n+1} \leftarrow a^{-n}$$

Right Shift

$$* a^{-1}$$

$$a^{n-1} \leftarrow a^n$$

Right Shift

$$a^{-n-1} \leftarrow a^{-n}$$

Left Shift

## Exponent & Range Shifting

$$* z$$

$$n \leftarrow n-1$$

Right Shift

$$* z^{-1}$$

$$n \leftarrow n+1$$

Left Shift

## Positive Exponent

Left Shifted

$$\frac{a}{1-az} \quad |z| < a^{-1} \quad a^{n+1} u(n)$$

Right Shifted

$$\frac{z}{1-az} \quad |z| < a^{-1} \quad a^{n-1} u(n-1)$$

Left Shifted

$$- \frac{z^{-1}}{1-az^{-1}} \quad |z| > a^{-1} \quad a^{n+1} u(-n-1)$$

Right Shifted

$$- \frac{a^{-1}}{1-az^{-1}} \quad |z| > a^{-1} \quad a^{n-1} u(-n)$$

## Negative Exponent

$$\frac{a^{-1}}{1-a^{-1}z} \quad |z| < a \quad a^{-n-1} u(n)$$

$$\frac{z}{1-a^{-1}z} \quad |z| < a \quad a^{-n+1} u(n-1)$$

$$- \frac{z^{-1}}{1-az^{-1}} \quad |z| > a \quad a^{-n-1} u(-n-1)$$

$$- \frac{a}{1-az^{-1}} \quad |z| > a \quad a^{-n+1} u(-n)$$

multiplying  $a$  or  $a^{-1}$

multiplying  $z$  or  $z^{-1}$

## Exponent Shifting

$$* a$$

$$a^{n+1} \leftarrow a^n$$

Left Shift

$$a^{-n+1} \leftarrow a^{-n}$$

Right Shift

$$* a^{-1}$$

$$a^{n-1} \leftarrow a^n$$

Right Shift

$$a^{-n-1} \leftarrow a^{-n}$$

Left Shift

## Exponent & Range Shifting

$$* z$$

$$n \leftarrow n-1$$

Right Shift

$$* z^{-1}$$

$$n \leftarrow n+1$$

Left Shift



# Combinations of Shifted Geometric Series (1)

Positive Exponent

/z  $n \leftarrow n+1$

\*z  $n \leftarrow n-1$

(1)  $\frac{1}{1-az} \quad |z| < a^{-1}$   $\xrightarrow{*a}$   $\frac{a}{1-az} \quad |z| < a^{-1}$  **Left Shifted**  
 $a^n u(n)$   $\xrightarrow{/z}$   $a^{n+1} u(n)$

(7)  $\frac{az}{1-az} \quad |z| < a^{-1}$   $\xrightarrow{/a}$   $\frac{z}{1-az} \quad |z| < a^{-1}$  **Right Shifted**  
 $a^n u(n-1)$   $\xrightarrow{*z}$   $a^{n-1} u(n-1)$

(5)  $-\frac{a^{-1}z^{-1}}{1-a^{-1}z^{-1}} \quad |z| > a^{-1}$   $\xrightarrow{*a}$   $-\frac{z^{-1}}{1-a^{-1}z^{-1}} \quad |z| > a^{-1}$  **Left Shifted**  
 $a^n u(-n-1)$   $\xrightarrow{/z}$   $a^{n+1} u(-n-1)$

(3)  $-\frac{1}{1-a^{-1}z^{-1}} \quad |z| > a^{-1}$   $\xrightarrow{/a}$   $-\frac{a^{-1}}{1-a^{-1}z^{-1}} \quad |z| > a^{-1}$  **Right Shifted**  
 $a^n u(-n)$   $\xrightarrow{*z}$   $a^{n-1} u(-n)$

Causal	$u(n)$	(1)	(2)
	$u(n-1)$	(7)	(8)
Anti-Causal	$u(-n-1)$	(5)	(6)
	$u(-n)$	(3)	(4)

# Combinations of Shifted Geometric Series (2)

**Negative Exponent**

/z  $n \leftarrow n+1$

\*z  $n \leftarrow n-1$

(2)  $\frac{1}{1-a^1z} \quad |z| < a$   $\xrightarrow{/a}$   $\frac{a^{-1}}{1-a^1z} \quad |z| < a$  **Left Shifted**  
 $a^{-n} u(n)$   $\xrightarrow{/z}$   $a^{-n-1} u(n)$

(8)  $\frac{a^1z}{1-a^1z} \quad |z| < a$   $\xrightarrow{*a}$   $\frac{z}{1-a^1z} \quad |z| < a$  **Right Shifted**  
 $a^{-n} u(n-1)$   $\xrightarrow{*z}$   $a^{-n+1} u(n-1)$

(6)  $-\frac{a^1z^{-1}}{1-a^1z^{-1}} \quad |z| > a$   $\xrightarrow{/a}$   $-\frac{z^{-1}}{1-a^1z^{-1}} \quad |z| > a$  **Left Shifted**  
 $a^{-n} u(-n-1)$   $\xrightarrow{/z}$   $a^{-n-1} u(-n-1)$

(4)  $-\frac{1}{1-a^1z^{-1}} \quad |z| > a$   $\xrightarrow{*a}$   $-\frac{a}{1-a^1z^{-1}} \quad |z| > a$  **Right Shifted**  
 $a^{-n} u(-n)$   $\xrightarrow{*z}$   $a^{-n+1} u(-n)$

Causal	$u(n)$	(1)	(2)
	$u(n-1)$	(7)	(8)
Anti-Causal	$u(-n-1)$	(5)	(6)
	$u(-n)$	(3)	(4)

# Graphs of Shifted Geometric Series (1)

Positive Exponent

$/z \quad n \leftarrow n+1$

$*z \quad n \leftarrow n-1$

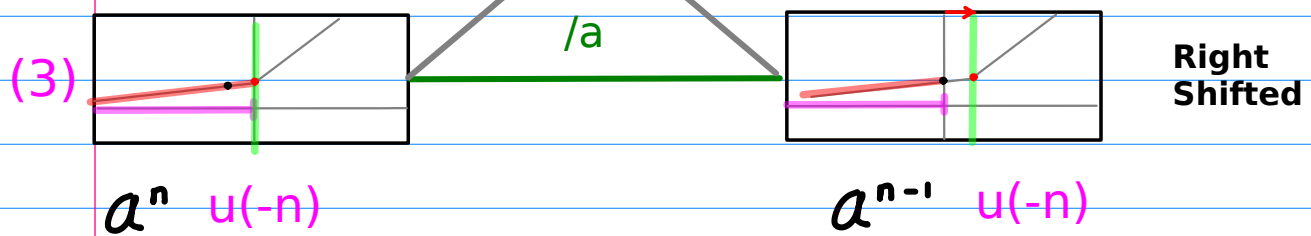
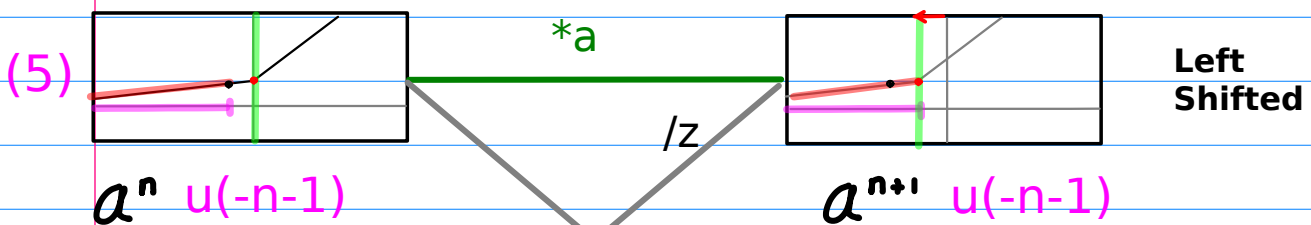
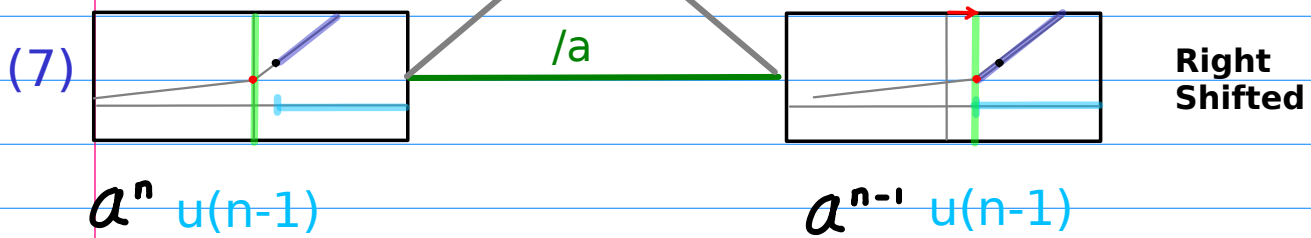
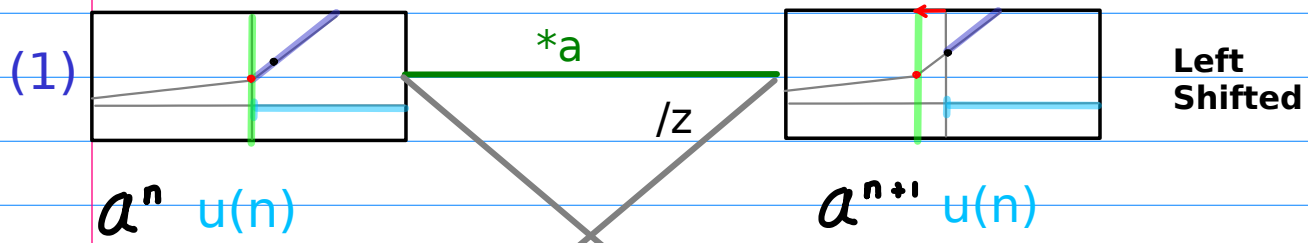

Causal	$u(n)$	(1)	(2)
	$u(n-1)$	(7)	(8)
Anti-Causal	$u(-n-1)$	(5)	(6)
	$u(-n)$	(3)	(4)

# Graphs of Shifted Geometric Series (2)

Negative Exponent

$/z \quad n \leftarrow n+1$

$*z \quad n \leftarrow n-1$

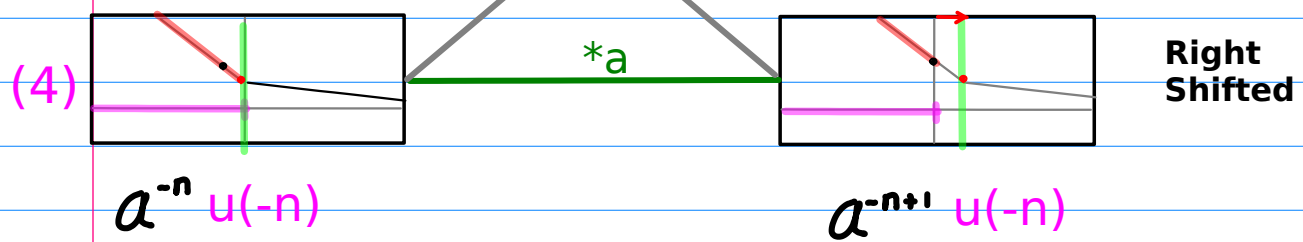
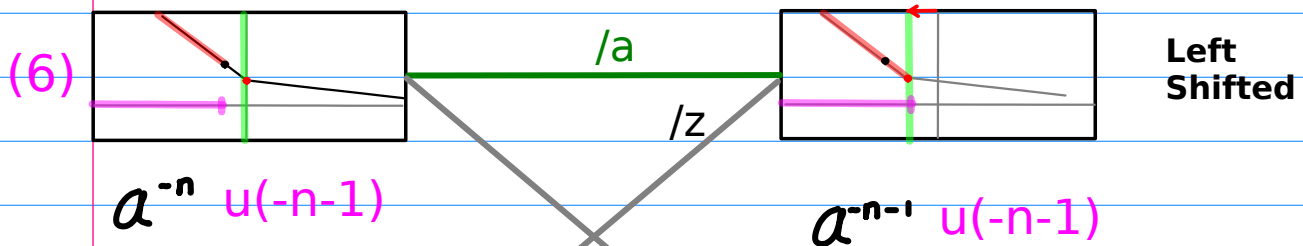
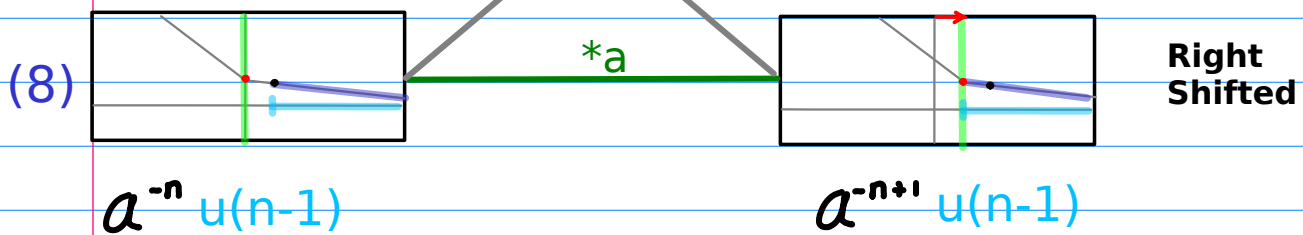
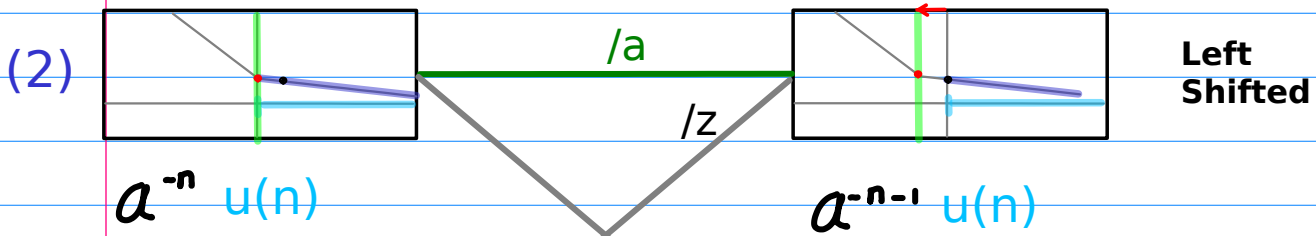

Causal	$u(n)$	(1)	(2)
	$u(n-1)$	(7)	(8)
Anti-Causal	$u(-n-1)$	(5)	(6)
	$u(-n)$	(3)	(4)

# Shifting Geometric Series by $*a$ or $/a$

$$\star \left( \boxed{\phantom{z}}^{-1} \boxed{\phantom{z}}^{-1} \right) / \left( \boxed{\phantom{z}}^{-1} \boxed{\phantom{z}}^{-1} \right)$$

<p>(1) <math>a^{+1} z^{+1}</math>    <math>a^{+n} \cdot u(n)</math>  <math>\boxed{* a}</math>    <math>\boxed{a^{+n+1} \cdot u(n)}</math></p> <p>(2) <math>a^{-1} z^{+1}</math>    <math>a^{-n} \cdot u(n)</math>  <math>\boxed{/ a}</math>    <math>\boxed{a^{-n-1} \cdot u(n)}</math></p>	<p>(5) <math>a^{-1} z^{-1}</math>    <math>a^{+n} \cdot u(-n-1)</math>  <math>\boxed{* a}</math>    <math>\boxed{a^{+n+1} \cdot u(-n-1)}</math></p> <p>(6) <math>a^{+1} z^{-1}</math>    <math>a^{-n} \cdot u(-n-1)</math>  <math>\boxed{/ a}</math>    <math>\boxed{a^{-n-1} \cdot u(-n-1)}</math></p>
<p>(3) <math>a^{-1} z^{-1}</math>    <math>a^{+n} \cdot u(-n)</math>  <math>\boxed{/ a}</math>    <math>\boxed{a^{+n-1} \cdot u(-n)}</math></p> <p>(4) <math>a^{+1} z^{-1}</math>    <math>a^{-n} \cdot u(-n)</math>  <math>\boxed{* a}</math>    <math>\boxed{a^{-n+1} \cdot u(-n)}</math></p>	<p>(7) <math>a^{+1} z^{+1}</math>    <math>a^{+n} \cdot u(n-1)</math>  <math>\boxed{/ a}</math>    <math>\boxed{a^{+n-1} \cdot u(n-1)}</math></p> <p>(8) <math>a^{-1} z^{+1}</math>    <math>a^{-n} \cdot u(n-1)</math>  <math>\boxed{* a}</math>    <math>\boxed{a^{-n+1} \cdot u(n-1)}</math></p>

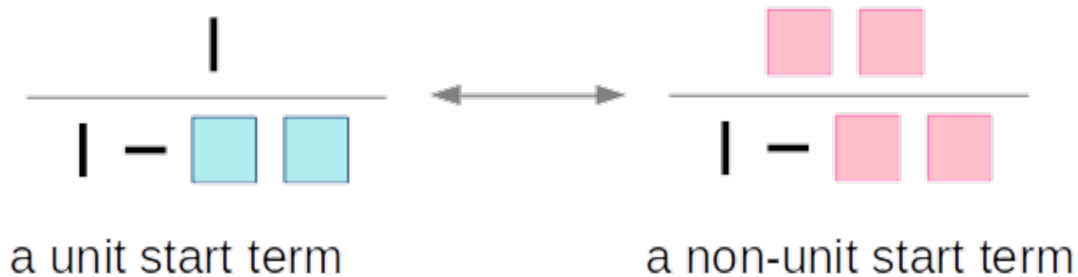

# Shifting Geometric Series by $*z$ or $/z$

$$* \left( \begin{array}{c} \blacksquare^{-1} \blacksquare^{-1} \end{array} \right) / \left( \begin{array}{c} \blacksquare^{-1} \blacksquare^{-1} \end{array} \right)$$

<p>(1) <math>a^{+1} z^{+1}</math> <math>a^{+n} \cdot u(n)</math>  <math>* z</math> <math>a^{+n-1} \cdot u(n-1)</math></p> <p>(2) <math>a^{-1} z^{+1}</math> <math>a^{-n} \cdot u(n)</math>  <math>* z</math> <math>a^{-n+1} \cdot u(n-1)</math></p>	<p>(5) <math>a^{-1} z^{-1}</math> <math>a^{+n} \cdot u(-n-1)</math>  <math>* z</math> <math>a^{+n-1} \cdot u(-n)</math></p> <p>(6) <math>a^{+1} z^{-1}</math> <math>a^{-n} \cdot u(-n-1)</math>  <math>* z</math> <math>a^{-n+1} \cdot u(-n)</math></p>
<p>(3) <math>a^{-1} z^{-1}</math> <math>a^{+n} \cdot u(-n)</math>  <math>/ z</math> <math>a^{+n+1} \cdot u(-n-1)</math></p> <p>(4) <math>a^{+1} z^{-1}</math> <math>a^{-n} \cdot u(-n)</math>  <math>/ z</math> <math>a^{-n-1} \cdot u(-n-1)</math></p>	<p>(7) <math>a^{+1} z^{+1}</math> <math>a^{+n} \cdot u(n-1)</math>  <math>/ z</math> <math>a^{+n+1} \cdot u(n)</math></p> <p>(8) <math>a^{-1} z^{+1}</math> <math>a^{-n} \cdot u(n-1)</math>  <math>/ z</math> <math>a^{-n-1} \cdot u(n)</math></p>

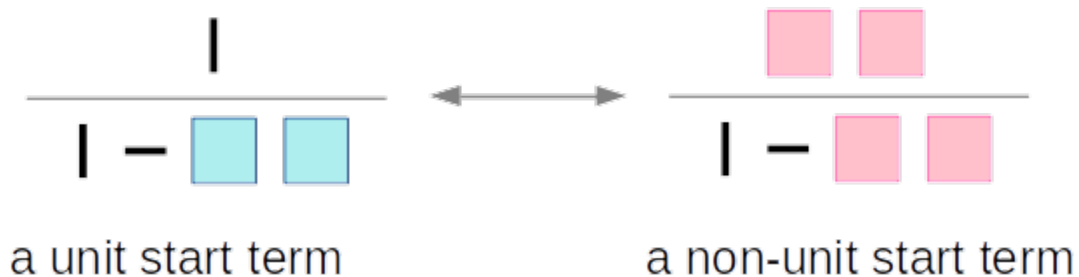

$u(n)$	(1)	(2)
$u(-n)$	(3)	(4)
$u(-n-1)$	(5)	(6)
$u(n-1)$	(7)	(8)

(1) $a^{+1} z^{+1}$	$a^{+n} \cdot u(n)$	(2) $a^{-1} z^{+1}$	$a^{-n} \cdot u(n)$
$* a$	$a^{+n+1} \cdot u(n)$	$/ a$	$a^{-n-1} \cdot u(n)$
(3) $a^{-1} z^{-1}$	$a^{+n} \cdot u(-n)$	(4) $a^{+1} z^{-1}$	$a^{-n} \cdot u(-n)$
$/ a$	$a^{+n-1} \cdot u(-n)$	$* a$	$a^{-n+1} \cdot u(-n)$
(5) $a^{-1} z^{-1}$	$a^{+n} \cdot u(-n-1)$	(6) $a^{+1} z^{-1}$	$a^{-n} \cdot u(-n-1)$
$* a$	$a^{+n+1} \cdot u(-n-1)$	$/ a$	$a^{-n-1} \cdot u(-n-1)$
(7) $a^{+1} z^{+1}$	$a^{+n} \cdot u(n-1)$	(8) $a^{-1} z^{+1}$	$a^{-n} \cdot u(n-1)$
$/ a$	$a^{+n-1} \cdot u(n-1)$	$* a$	$a^{-n+1} \cdot u(n-1)$

(1) $a^{+1} z^{+1}$	$a^{+n} \cdot u(n)$	(2) $a^{-1} z^{+1}$	$a^{-n} \cdot u(n)$
$* z$	$a^{+n-1} \cdot u(n-1)$	$* z$	$a^{-n+1} \cdot u(n-1)$
(3) $a^{-1} z^{-1}$	$a^{+n} \cdot u(-n)$	(4) $a^{+1} z^{-1}$	$a^{-n} \cdot u(-n)$
$/ z$	$a^{+n+1} \cdot u(-n-1)$	$/ z$	$a^{-n-1} \cdot u(-n-1)$
(5) $a^{-1} z^{-1}$	$a^{+n} \cdot u(-n-1)$	(6) $a^{+1} z^{-1}$	$a^{-n} \cdot u(-n-1)$
$* z$	$a^{+n-1} \cdot u(-n)$	$* z$	$a^{-n+1} \cdot u(-n)$
(7) $a^{+1} z^{+1}$	$a^{+n} \cdot u(n-1)$	(8) $a^{-1} z^{+1}$	$a^{-n} \cdot u(n-1)$
$/ z$	$a^{+n+1} \cdot u(n)$	$/ z$	$a^{-n-1} \cdot u(n)$

<b>Causal</b>	$u(n)$	(1)	(2)
	$u(n-1)$	(7)	(8)
<b>Anti-Causal</b>	$u(-n-1)$	(5)	(6)
	$u(-n)$	(3)	(4)

(1)	$a^{+1} z^{+1}$	$a^{+n} \cdot u(n)$	(2)	$a^{-1} z^{+1}$	$a^{-n} \cdot u(n)$
	$* a$	$a^{+n+1} \cdot u(n)$		$/ a$	$a^{-n-1} \cdot u(n)$
(7)	$a^{+1} z^{+1}$	$a^{+n} \cdot u(n-1)$	(8)	$a^{-1} z^{+1}$	$a^{-n} \cdot u(n-1)$
	$/ a$	$a^{+n-1} \cdot u(n-1)$		$* a$	$a^{-n+1} \cdot u(n-1)$
(5)	$a^{-1} z^{-1}$	$a^{+n} \cdot u(-n-1)$	(6)	$a^{+1} z^{-1}$	$a^{-n} \cdot u(-n-1)$
	$* a$	$a^{+n+1} \cdot u(-n-1)$		$/ a$	$a^{-n-1} \cdot u(-n-1)$
(3)	$a^{-1} z^{-1}$	$a^{+n} \cdot u(-n)$	(4)	$a^{+1} z^{-1}$	$a^{-n} \cdot u(-n)$
	$/ a$	$a^{+n-1} \cdot u(-n)$		$* a$	$a^{-n+1} \cdot u(-n)$

(1)	$a^{+1} z^{+1}$	$a^{+n} \cdot u(n)$	(2)	$a^{-1} z^{+1}$	$a^{-n} \cdot u(n)$
	$* z$	$a^{+n-1} \cdot u(n-1)$		$* z$	$a^{-n+1} \cdot u(n-1)$
(7)	$a^{+1} z^{+1}$	$a^{+n} \cdot u(n-1)$	(8)	$a^{-1} z^{+1}$	$a^{-n} \cdot u(n-1)$
	$/ z$	$a^{+n+1} \cdot u(n)$		$/ z$	$a^{-n-1} \cdot u(n)$
(5)	$a^{-1} z^{-1}$	$a^{+n} \cdot u(-n-1)$	(6)	$a^{+1} z^{-1}$	$a^{-n} \cdot u(-n-1)$
	$* z$	$a^{+n-1} \cdot u(-n)$		$* z$	$a^{-n+1} \cdot u(-n)$
(3)	$a^{-1} z^{-1}$	$a^{+n} \cdot u(-n)$	(4)	$a^{+1} z^{-1}$	$a^{-n} \cdot u(-n)$
	$/ z$	$a^{+n+1} \cdot u(-n-1)$		$/ z$	$a^{-n-1} \cdot u(-n-1)$



<b>Complement Type I</b>	$u(n)$	(1)	(2)
	$u(-n-1)$	(5)	(6)
<b>Complement Type II</b>	$u(-n)$	(3)	(4)
	$u(n-1)$	(7)	(8)

(1) $a^{+1} z^{+1}$	$a^{+n} \cdot u(n)$	(2) $a^{-1} z^{+1}$	$a^{-n} \cdot u(n)$
$* a$	$a^{+n+1} \cdot u(n)$	$/ a$	$a^{-n-1} \cdot u(n)$
(5) $a^{-1} z^{-1}$	$a^{+n} \cdot u(-n-1)$	(6) $a^{+1} z^{-1}$	$a^{-n} \cdot u(-n-1)$
$* a$	$a^{+n+1} \cdot u(-n-1)$	$/ a$	$a^{-n-1} \cdot u(-n-1)$
(3) $a^{-1} z^{-1}$	$a^{+n} \cdot u(-n)$	(4) $a^{+1} z^{-1}$	$a^{-n} \cdot u(-n)$
$/ a$	$a^{+n-1} \cdot u(-n)$	$* a$	$a^{-n+1} \cdot u(-n)$
(7) $a^{+1} z^{+1}$	$a^{+n} \cdot u(n-1)$	(8) $a^{-1} z^{+1}$	$a^{-n} \cdot u(n-1)$
$/ a$	$a^{+n-1} \cdot u(n-1)$	$* a$	$a^{-n+1} \cdot u(n-1)$

(1) $a^{+1} z^{+1}$	$a^{+n} \cdot u(n)$	(2) $a^{-1} z^{+1}$	$a^{-n} \cdot u(n)$
$* z$	$a^{+n-1} \cdot u(n-1)$	$* z$	$a^{-n+1} \cdot u(n-1)$
(5) $a^{-1} z^{-1}$	$a^{+n} \cdot u(-n-1)$	(6) $a^{+1} z^{-1}$	$a^{-n} \cdot u(-n-1)$
$* z$	$a^{+n-1} \cdot u(-n)$	$* z$	$a^{-n+1} \cdot u(-n)$
(3) $a^{-1} z^{-1}$	$a^{+n} \cdot u(-n)$	(4) $a^{+1} z^{-1}$	$a^{-n} \cdot u(-n)$
$/ z$	$a^{+n+1} \cdot u(-n-1)$	$/ z$	$a^{-n-1} \cdot u(-n-1)$
(7) $a^{+1} z^{+1}$	$a^{+n} \cdot u(n-1)$	(8) $a^{-1} z^{+1}$	$a^{-n} \cdot u(n-1)$
$/ z$	$a^{+n+1} \cdot u(n)$	$/ z$	$a^{-n-1} \cdot u(n)$

# Shifted Geometric Series (1)

by multiplying  $a$  or  $a^{-1}$

## Positive Exponent

$$\begin{array}{l} \leftarrow \\ (1) \end{array} \quad \boxed{\frac{1}{1-az} \quad |z| < a^{-1}} \quad a^n u(n) \times a \quad \boxed{\frac{a}{1-az} \quad |z| < a^{-1}} \quad a^{n+1} u(n)$$

$$\begin{array}{l} \rightarrow \\ (7) \end{array} \quad \boxed{\frac{az}{1-az} \quad |z| < a^{-1}} \quad a^n u(n-1) \times a^{-1} \quad \boxed{\frac{z}{1-az} \quad |z| < a^{-1}} \quad a^{n-1} u(n-1)$$

$$\begin{array}{l} \leftarrow \\ (5) \end{array} \quad \boxed{-\frac{a^1 z^1}{1-a^1 z^1} \quad |z| > a^{-1}} \quad a^n u(-n-1) \times a \quad \boxed{-\frac{z^1}{1-a^1 z^1} \quad |z| > a^{-1}} \quad a^{n+1} u(-n-1)$$

$$\begin{array}{l} \rightarrow \\ (3) \end{array} \quad \boxed{-\frac{1}{1-a^1 z^1} \quad |z| > a^{-1}} \quad a^n u(-n) \times a^{-1} \quad \boxed{-\frac{a^1}{1-a^1 z^1} \quad |z| > a^{-1}} \quad a^{n-1} u(-n)$$

## Negative Exponent

$$\begin{array}{l} \leftarrow \\ (2) \end{array} \quad \boxed{\frac{1}{1-a^1 z} \quad |z| < a} \quad a^{-n} u(n) \times a^{-1} \quad \boxed{\frac{a^1}{1-a^1 z} \quad |z| < a} \quad a^{-n-1} u(n)$$

$$\begin{array}{l} \rightarrow \\ (8) \end{array} \quad \boxed{\frac{a^1 z}{1-a^1 z} \quad |z| < a} \quad a^{-n} u(n-1) \times a \quad \boxed{\frac{z}{1-a^1 z} \quad |z| < a} \quad a^{-n+1} u(n-1)$$

$$\begin{array}{l} \leftarrow \\ (6) \end{array} \quad \boxed{-\frac{az^1}{1-a^1 z^1} \quad |z| > a} \quad a^{-n} u(-n-1) \times a^{-1} \quad \boxed{-\frac{z^1}{1-a^1 z^1} \quad |z| > a} \quad a^{-n-1} u(-n-1)$$

$$\begin{array}{l} \rightarrow \\ (4) \end{array} \quad \boxed{-\frac{1}{1-a^1 z^1} \quad |z| > a} \quad a^{-n} u(-n) \times a \quad \boxed{-\frac{a}{1-a^1 z^1} \quad |z| > a} \quad a^{-n+1} u(-n)$$

# Shifted Geometric Series (2)

by multiplying  $z$  or  $z^{-1}$

## Positive Exponent

(1)  $\leftarrow$   $\frac{az}{1-az} \quad |z| < a^{-1}$   $\overset{n \leftarrow n+1}{a^n u(n-1)} z^{-1}$   $\frac{a}{1-az} \quad |z| < a^{-1}$   $a^{n+1} u(n)$

(7)  $\rightarrow$   $\frac{1}{1-az} \quad |z| < a^{-1}$   $\overset{n \leftarrow n-1}{a^n u(n)} \times z$   $\frac{z}{1-az} \quad |z| < a^{-1}$   $a^{n-1} u(n-1)$

(5)  $\leftarrow$   $-\frac{1}{1-a^{-1}z^{-1}} \quad |z| > a^{-1}$   $\overset{n \leftarrow n+1}{a^n u(-n)} \times z^{-1}$   $-\frac{z^{-1}}{1-a^{-1}z^{-1}} \quad |z| > a^{-1}$   $a^{n+1} u(-n-1)$

(3)  $\rightarrow$   $-\frac{a^{-1}z^{-1}}{1-a^{-1}z^{-1}} \quad |z| > a^{-1}$   $\overset{n \leftarrow n-1}{a^n u(-n-1)} \times z$   $-\frac{a^{-1}}{1-a^{-1}z^{-1}} \quad |z| > a^{-1}$   $a^{n-1} u(-n)$

## Negative Exponent

(2)  $\leftarrow$   $\frac{a^{-1}z}{1-a^{-1}z} \quad |z| < a$   $\overset{n \leftarrow n+1}{a^{-n} u(n-1)} \times z^{-1}$   $\frac{a^{-1}}{1-a^{-1}z} \quad |z| < a$   $a^{-n-1} u(n)$

(8)  $\rightarrow$   $\frac{1}{1-a^{-1}z} \quad |z| < a$   $\overset{n \leftarrow n-1}{a^{-n} u(n)} \times z$   $\frac{z}{1-a^{-1}z} \quad |z| < a$   $a^{-n+1} u(n-1)$

(6)  $\leftarrow$   $-\frac{1}{1-a^{-1}z^{-1}} \quad |z| > a$   $\overset{n \leftarrow n+1}{a^{-n} u(-n)} \times z^{-1}$   $-\frac{z^{-1}}{1-a^{-1}z^{-1}} \quad |z| > a$   $a^{-n-1} u(-n-1)$

(4)  $\rightarrow$   $-\frac{a^{-1}z^{-1}}{1-a^{-1}z^{-1}} \quad |z| > a$   $\overset{n \leftarrow n-1}{a^{-n} u(-n-1)} \times z$   $-\frac{a^{-1}}{1-a^{-1}z^{-1}} \quad |z| > a$   $a^{-n+1} u(-n)$

Assume  $a > 1$

- (1)  $a^n u(n)$      $*a \leftarrow$      $a^{n+1} u(n)$
- (2)  $a^{-n} u(n)$      $/a \leftarrow$      $a^{-n-1} u(n)$
- (3)  $a^n u(-n)$      $/a \rightarrow$      $a^{n-1} u(-n)$
- (4)  $a^{-n} u(-n)$      $*a \rightarrow$      $a^{-n+1} u(-n)$
- (5)  $a^n u(-n-1)$      $*a \leftarrow$      $a^{n+1} u(-n-1)$
- (6)  $a^{-n} u(-n-1)$      $/a \leftarrow$      $a^{-n-1} u(-n-1)$
- (7)  $a^n u(n-1)$      $/a \rightarrow$      $a^{n-1} u(n-1)$
- (8)  $a^{-n} u(n-1)$      $*a \rightarrow$      $a^{-n+1} u(n-1)$

(1)	(2)	$*a$	$/a$	$\leftarrow$	$\leftarrow$
(3)	(4)	$/a$	$*a$	$\rightarrow$	$\rightarrow$
(5)	(6)	$*a$	$/a$	$\leftarrow$	$\leftarrow$
(7)	(8)	$/a$	$*a$	$\rightarrow$	$\rightarrow$

- (1)  $a^n u(n)$   $\quad *z \Rightarrow \quad a^{n-1} u(n-1)$
- (2)  $a^{-n} u(n)$   $\quad *z \Rightarrow \quad a^{-n+1} u(n-1)$
- (3)  $a^n u(-n)$   $\quad /z \Leftarrow \quad a^{n+1} u(-n-1)$
- (4)  $a^{-n} u(-n)$   $\quad /z \Leftarrow \quad a^{-n-1} u(-n-1)$
- (5)  $a^n u(-n-1)$   $\quad *z \Rightarrow \quad a^{n-1} u(-n)$
- (6)  $a^{-n} u(-n-1)$   $\quad *z \Rightarrow \quad a^{-n+1} u(-n)$
- (7)  $a^n u(n-1)$   $\quad /z \Leftarrow \quad a^{n+1} u(n)$
- (8)  $a^{-n} u(n-1)$   $\quad /z \Leftarrow \quad a^{-n-1} u(n)$

Assume  $a > 1$

(1) $a^n u(n)$	$a^{n+1} u(n)$
(2) $a^n u(n-1)$	$a^{n-1} u(n-1)$
(3) $a^n u(-n-1)$	$a^{n+1} u(-n-1)$
(4) $a^n u(-n)$	$a^{n-1} u(-n)$
$a^{-n} u(n)$	$a^{-n-1} u(n)$
$a^{-n} u(n-1)$	$a^{-n+1} u(n-1)$
$a^{-n} u(-n-1)$	$a^{-n-1} u(-n-1)$
$a^{-n} u(-n)$	$a^{-n+1} u(-n)$

$2^n u(n)$	$2^{n+1} u(n)$
$2^n u(n-1)$	$2^{n-1} u(n-1)$
$2^n u(-n-1)$	$2^{n+1} u(-n-1)$
$2^n u(-n)$	$2^{n-1} u(-n)$

$(\frac{1}{2})^{-n} u(n)$	$(\frac{1}{2})^{-n-1} u(n)$
$(\frac{1}{2})^{-n} u(n-1)$	$(\frac{1}{2})^{-n+1} u(n-1)$
$(\frac{1}{2})^{-n} u(-n-1)$	$(\frac{1}{2})^{-n-1} u(-n-1)$
$(\frac{1}{2})^{-n} u(-n)$	$(\frac{1}{2})^{-n+1} u(-n)$

$(\frac{1}{2})^n u(n)$	$(\frac{1}{2})^{n+1} u(n)$
$(\frac{1}{2})^n u(n-1)$	$(\frac{1}{2})^{n-1} u(n-1)$
$(\frac{1}{2})^n u(-n-1)$	$(\frac{1}{2})^{n+1} u(-n-1)$
$(\frac{1}{2})^n u(-n)$	$(\frac{1}{2})^{n-1} u(-n)$

$2^{-n} u(n)$	$2^{-n-1} u(n)$
$2^{-n} u(n-1)$	$2^{-n+1} u(n-1)$
$2^{-n} u(-n-1)$	$2^{-n-1} u(-n-1)$
$2^{-n} u(-n)$	$2^{-n+1} u(-n)$

$$(1) *a *z$$

$$(7) /a /z$$

$$(5) *a *z$$

$$(3) /a /z$$

$$(2) /a *z$$

$$(8) *a /z$$

$$(6) /a *z$$

$$(4) *a /z$$

↕  
↕

$$\leftarrow (1) *a = (7) /z \rightleftarrows$$

$$\Rightarrow (1) *z = (7) /a \rightarrow$$

$$\leftarrow (5) *a = (3) /z \rightleftarrows$$

$$\Rightarrow (5) *z = (3) /a \rightarrow$$

$$\leftarrow (2) /a = (8) /z \rightleftarrows$$

$$\Rightarrow (2) *z = (8) *a \rightarrow$$

$$\leftarrow (6) /a = (4) /z \rightleftarrows$$

$$\Rightarrow (6) *z = (4) *a \rightarrow$$

$$(1) *a *z$$

$$(5) *a *z$$

$$(3) /z /a$$

$$(7) /z /a$$

$$(2) /a *z$$

$$(6) /a *z$$

$$(4) *a /z$$

$$(8) *a /z$$

$$(1) a^n u(n) \begin{array}{c} *a \\ /z \end{array} a^{n+1} u(n)$$

$$(7) a^n u(n-1) \begin{array}{c} *z \\ /a \end{array} a^{n-1} u(n-1)$$

$$(5) a^n u(-n-1) \begin{array}{c} *a \\ /z \end{array} a^{n+1} u(-n-1)$$

$$(3) a^n u(-n) \begin{array}{c} *z \\ /a \end{array} a^{n-1} u(-n)$$

$$(2) a^{-n} u(n) \begin{array}{c} /a \\ /z \end{array} a^{-n-1} u(n)$$

$$(8) a^{-n} u(n-1) \begin{array}{c} *z \\ *a \end{array} a^{-n+1} u(n-1)$$

$$(6) a^{-n} u(-n-1) \begin{array}{c} /a \\ /z \end{array} a^{-n-1} u(-n-1)$$

$$(4) a^{-n} u(-n) \begin{array}{c} *z \\ *a \end{array} a^{-n+1} u(-n)$$

$\leftarrow (1) *a = (7) /z \quad \leftarrow (2) /a = (8) /z$   
 $\rightarrow (1) *z = (7) /a \quad \rightarrow (2) *z = (8) *a$   
 $\leftarrow (5) *a = (3) /z \quad \leftarrow (6) /a = (4) /z$   
 $\rightarrow (5) *z = (3) /a \quad \rightarrow (6) *z = (4) *a$

(1) *a	*z	(2) /a	*z
(5) *a	*z	(6) /a	*z
(3) /a	/z	(4) *a	/z
(7) /a	/z	(8) *a	/z

(1) *a	$\leftarrow$	(2) /a	$\leftarrow$
(5) *a	$\leftarrow$	(6) /a	$\leftarrow$
(3) /z	$\leftarrow$	(4) /z	$\leftarrow$
(7) /z	$\leftarrow$	(8) /z	$\leftarrow$

(1) *z	$\rightarrow$	(2) *z	$\rightarrow$
(5) *z	$\rightarrow$	(6) *z	$\rightarrow$
(3) /a	$\rightarrow$	(4) *a	$\rightarrow$
(7) /a	$\rightarrow$	(8) *a	$\rightarrow$



$\leftarrow (1) *a = (7) /z \quad \leftarrow (2) /a = (8) /z$   
 $\rightarrow (1) *z = (7) /a \quad \rightarrow (2) *z = (8) *a$   
 $\leftarrow (3) /z = (5) *a \quad \leftarrow (4) /z = (6) /a$   
 $\rightarrow (3) /a = (5) *z \quad \rightarrow (4) *a = (6) *z$

(1) *a	*z	(2) /a	*z
(3) /z	/a	(4) /z	*a
(5) *a	*z	(6) /a	*z
(7) /z	/a	(8) /z	*a

(1) *a	$\leftarrow$	(2) /a	$\leftarrow$
(3) /z	$\leftarrow$	(4) /z	$\leftarrow$
(5) *a	$\leftarrow$	(6) /a	$\leftarrow$
(7) /z	$\leftarrow$	(8) /z	$\leftarrow$

(1) *z	$\rightarrow$	(2) *z	$\rightarrow$
(3) /a	$\rightarrow$	(4) *a	$\rightarrow$
(5) *z	$\rightarrow$	(6) *z	$\rightarrow$
(7) /a	$\rightarrow$	(8) *a	$\rightarrow$

<b>Complement Type I</b>	$u(n)$	(1)	(2)
	$u(-n-1)$	(5)	(6)
<b>Complement Type II</b>	$u(-n)$	(3)	(4)
	$u(n-1)$	(7)	(8)

$$\begin{array}{l} (1) \quad a z \quad \mathbf{a}^n \\ (5) \quad a^{-1} z^{-1} \quad \mathbf{a}^n \end{array}$$

$$\begin{array}{l} (2) \quad a^{-1} z \quad \mathbf{a}^{-n} \\ (6) \quad a z^{-1} \quad \mathbf{a}^{-n} \end{array}$$

$$\begin{array}{l} (3) \quad a^{-1} z^{-1} \quad \mathbf{a}^n \\ (7) \quad a z \quad \mathbf{a}^n \end{array}$$

$$\begin{array}{l} (4) \quad a z^{-1} \quad \mathbf{a}^{-n} \\ (8) \quad a^{-1} z \quad \mathbf{a}^{-n} \end{array}$$

$$\begin{array}{l} (1) \quad a z \quad \mathbf{*a} \\ (5) \quad a^{-1} z^{-1} \quad \mathbf{*a} \end{array}$$

$$\begin{array}{l} (2) \quad a^{-1} z \quad \mathbf{/a} \\ (6) \quad a z^{-1} \quad \mathbf{/a} \end{array}$$

$$\begin{array}{l} (3) \quad a^{-1} z^{-1} \quad \mathbf{/a} \\ (7) \quad a z \quad \mathbf{/a} \end{array}$$

$$\begin{array}{l} (4) \quad a z^{-1} \quad \mathbf{*a} \\ (8) \quad a^{-1} z \quad \mathbf{*a} \end{array}$$

$$\begin{array}{l} (1) \quad a z \quad \mathbf{*z} \\ (5) \quad a^{-1} z^{-1} \quad \mathbf{*z} \end{array}$$

$$\begin{array}{l} (2) \quad a^{-1} z \quad \mathbf{*z} \\ (6) \quad a z^{-1} \quad \mathbf{*z} \end{array}$$

$$\begin{array}{l} (3) \quad a^{-1} z^{-1} \quad \mathbf{/z} \\ (7) \quad a z \quad \mathbf{/z} \end{array}$$

$$\begin{array}{l} (4) \quad a z^{-1} \quad \mathbf{/z} \\ (8) \quad a^{-1} z \quad \mathbf{/z} \end{array}$$

# Geometric Series Combinations

(1)

unit  
non-unit

$\frac{1}{1-az}$ $ z  < a^{-1}$	$a^n u(n)$
$-\frac{a^{-1}z^{-1}}{1-a^{-1}z^{-1}}$ $ z  > a^{-1}$	$-a^n u(-n-1)$

(2)

$\frac{1}{1-a^{-1}z}$ $ z  < a$	$(\frac{1}{a})^n u(n)$
$-\frac{az^{-1}}{1-az^{-1}}$ $ z  > a$	$-(\frac{1}{a})^n u(-n-1)$

(5)

(3)

unit  
non-unit

$-\frac{1}{1-a^{-1}z^{-1}}$ $ z  > a^{-1}$	$-a^n u(-n)$
$\frac{az}{1-az}$ $ z  < a^{-1}$	$a^n u(n-1)$

(6)

(4)

$-\frac{1}{1-az^{-1}}$ $ z  > a$	$-(\frac{1}{a})^n u(-n)$
$\frac{a^{-1}z}{1-a^{-1}z}$ $ z  < a$	$(\frac{1}{a})^n u(n-1)$

(7)

(8)

		Positive Exponent	Negative Exponent
Complement Type I	$u(n)$	(1)	(2)
	$u(-n-1)$	(5)	(6)
Complement Type II	$u(-n)$	(3)	(4)
	$u(n-1)$	(7)	(8)

# Shifted Combinations (I) by scaling $*a$ / $a$

(1)  $*a$

$\frac{a}{1-az}$ $ z  < a^{-1}$	$a^{n+1} u(n)$
$-\frac{z^{-1}}{1-a^{-1}z^{-1}}$ $ z  > a^{-1}$	$-a^{n+1} u(-n-1)$

(2) / $a$

$\frac{a^{-1}}{1-a^{-1}z}$ $ z  < a$	$(\frac{1}{a})^{n+1} u(n)$
$-\frac{z^{-1}}{1-a^{-1}z^{-1}}$ $ z  > a$	$-(\frac{1}{a})^{n+1} u(-n-1)$

(5)  $*a$

(3) / $a$

$-\frac{a^{-1}}{1-a^{-1}z^{-1}}$ $ z  > a^{-1}$	$-a^{n-1} u(-n)$
$\frac{z}{1-az}$ $ z  < a^{-1}$	$a^{n-1} u(n-1)$

(6) / $a$

(4)  $*a$

$-\frac{a}{1-az^{-1}}$ $ z  > a$	$-(\frac{1}{a})^{n-1} u(-n)$
$\frac{z}{1-a^{-1}z}$ $ z  < a$	$(\frac{1}{a})^{n-1} u(n-1)$

(7) / $a$

(8)  $*a$

	Positive Exponent	Negative Exponent		
Complement Type I	(1) $u(n)$	(2) $u(n)$	$*a$ $u(n)$	/ $a$ $u(n)$
	(5) $u(-n-1)$	(6) $u(-n-1)$	$*a$ $u(-n-1)$	/ $a$ $u(-n-1)$
Complement Type II	(3) $u(-n)$	(4) $u(-n)$	/ $a$ $u(-n)$	$*a$ $u(-n)$
	(7) $u(n-1)$	(8) $u(n-1)$	/ $a$ $u(n-1)$	$*a$ $u(n-1)$

# Shifted Combinations (II) by scaling $*z$ $/z$

(1)  $*z$

$\frac{z}{1-az}$ $ z  < a^{-1}$	$a^{n-1} u(n-1)$
$-\frac{a}{1-a^{-1}z^{-1}}$ $ z  > a^{-1}$	$-a^{n-1} u(-n)$

(2)  $*z$

$\frac{z}{1-a^{-1}z}$ $ z  < a$	$(\frac{1}{a})^{n-1} u(n-1)$
$-\frac{a}{1-az^{-1}}$ $ z  > a$	$-(\frac{1}{a})^{n-1} u(-n)$

(5)  $*z$

(3)  $/z$

$-\frac{z^{-1}}{1-a^{-1}z^{-1}}$ $ z  > a^{-1}$	$-a^{n+1} u(-n-1)$
$\frac{a}{1-az}$ $ z  < a^{-1}$	$a^{n+1} u(n)$

(6)  $*z$

(4)  $/z$

$-\frac{z^{-1}}{1-az^{-1}}$ $ z  > a$	$-(\frac{1}{a})^{n+1} u(-n-1)$
$\frac{a^{-1}}{1-a^{-1}z}$ $ z  < a$	$(\frac{1}{a})^{n+1} u(n)$

(7)  $/z$

(8)  $/z$

	Positive Exponent	Negative Exponent		
Complement Type I	(1) $u(n)$	(2) $u(n)$	$*z$ $u(n-1)$	$*z$ $u(n-1)$
	(5) $u(-n-1)$	(6) $u(-n-1)$	$*z$ $u(-n)$	$*z$ $u(-n)$
Complement Type II	(3) $u(-n)$	(4) $u(-n)$	$/z$ $u(-n-1)$	$/z$ $u(-n-1)$
	(7) $u(n-1)$	(8) $u(n-1)$	$/z$ $u(n)$	$/z$ $u(n)$

$a^n$

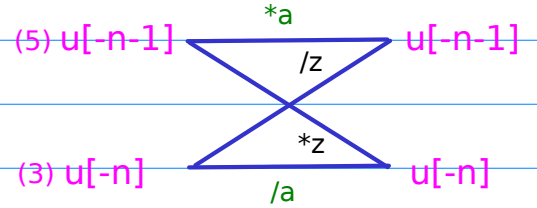
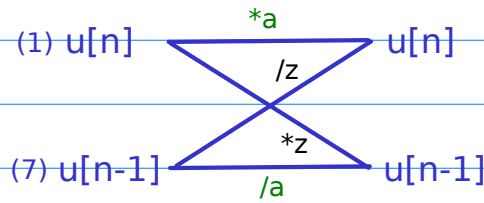
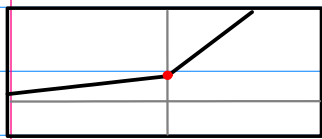

$a^{-n}$

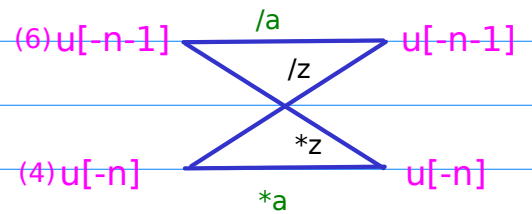
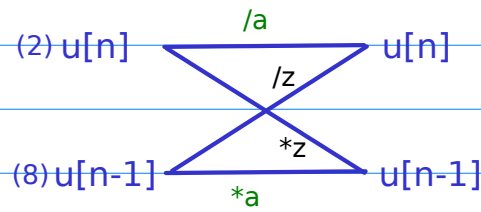
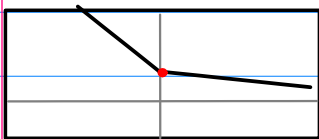

<b>Causal</b>	$u(n)$	(1)	(2)
	$u(n-1)$	(7)	(8)
<b>Anti-Causal</b>	$u(-n-1)$	(5)	(6)
	$u(-n)$	(3)	(4)

<b>Positive Exponent</b>	<b>Negative Exponent</b>
(1)	(2)
(3)	(4)
(5)	(6)
(7)	(8)

$$(1) a^n u(n) \begin{array}{c} *a \\ /z \\ *z \\ /a \end{array} a^{n+1} u(n)$$

$$(7) a^n u(n-1) \begin{array}{c} *z \\ /a \end{array} a^{n-1} u(n-1)$$

$$(5) a^n u(-n-1) \begin{array}{c} *a \\ /z \\ *z \\ /a \end{array} a^{n+1} u(-n-1)$$

$$(3) a^n u(-n) \begin{array}{c} *z \\ /a \end{array} a^{n-1} u(-n)$$

$$(2) a^{-n} u(n) \begin{array}{c} /a \\ /z \\ *z \\ *a \end{array} a^{-n-1} u(n)$$

$$(8) a^{-n} u(n-1) \begin{array}{c} *z \\ /a \end{array} a^{-n+1} u(n-1)$$

$$(6) a^{-n} u(-n-1) \begin{array}{c} /a \\ /z \\ *z \\ *a \end{array} a^{-n-1} u(-n-1)$$

$$(4) a^{-n} u(-n) \begin{array}{c} *z \\ /a \end{array} a^{-n+1} u(-n)$$

$a^n$

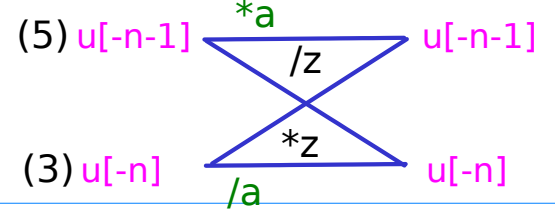
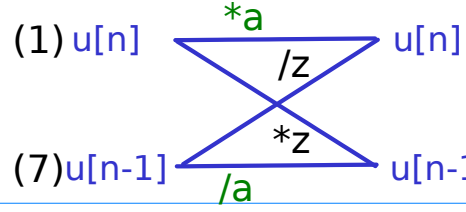
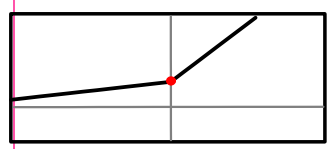

(1)  $*a$

$\frac{1}{1-az} \quad  z  < a^{-1}$	$\frac{a}{1-az} \quad  z  < a^{-1}$
$\frac{az}{1-az} \quad  z  < a^{-1}$	$\frac{z}{1-az} \quad  z  < a^{-1}$

(7)  $/a$

(1)  $*a$

$a^n u(n)$ $(a^0, a^1, a^2, \dots)$	$a^{n+1} u(n)$ $(a^1, a^2, a^3, \dots)$
$a^n u(n-1)$ $(a^1, a^2, a^3, \dots)$	$a^{n-1} u(n-1)$ $(a^0, a^1, a^2, \dots)$

(7)  $/a$

(1)  $*z$

$\frac{1}{1-az} \quad  z  < a^{-1}$	$\frac{z}{1-az} \quad  z  < a^{-1}$
$\frac{az}{1-az} \quad  z  < a^{-1}$	$\frac{a}{1-az} \quad  z  < a^{-1}$

(7)  $/z$

(1)  $*z$

$a^n u(n)$ $(a^0, a^1, a^2, \dots)$	$a^{n-1} u(n-1)$ $(a^0, a^1, a^2, \dots)$
$a^n u(n-1)$ $(a^1, a^2, a^3, \dots)$	$a^{n+1} u(n)$ $(a^1, a^2, a^3, \dots)$

(7)  $/z$

(5)  $*a$

$-\frac{a'z^{-1}}{1-a'z^{-1}} \quad  z  > a^{-1}$	$-\frac{z^{-1}}{1-a'z^{-1}} \quad  z  > a^{-1}$
$-\frac{1}{1-a'z^{-1}} \quad  z  > a^{-1}$	$-\frac{a'}{1-a'z^{-1}} \quad  z  > a^{-1}$

(3)  $/a$

(5)  $*a$

$-a^n u(-n-1)$ $-(\dots, \frac{1}{a^2}, \frac{1}{a^2}, \frac{1}{a^1})$	$-a^{n+1} u(-n-1)$ $-(\dots, \frac{1}{a^2}, \frac{1}{a^1}, \frac{1}{a^0})$
$-a^n u(-n)$ $-(\dots, \frac{1}{a^2}, \frac{1}{a^1}, \frac{1}{a^0})$	$-a^{n-1} u(-n)$ $-(\dots, \frac{1}{a^2}, \frac{1}{a^2}, \frac{1}{a^1})$

(3)  $/a$

(5)  $*z$

$-\frac{a'z^{-1}}{1-a'z^{-1}} \quad  z  > a^{-1}$	$-\frac{a'}{1-a'z^{-1}} \quad  z  > a^{-1}$
$-\frac{1}{1-a'z^{-1}} \quad  z  > a^{-1}$	$-\frac{z^{-1}}{1-a'z^{-1}} \quad  z  > a^{-1}$

(3)  $/z$

(5)  $*z$

$-a^n u(-n-1)$ $-(\dots, \frac{1}{a^2}, \frac{1}{a^2}, \frac{1}{a^1})$	$-a^{n-1} u(-n)$ $-(\dots, \frac{1}{a^2}, \frac{1}{a^2}, \frac{1}{a^1})$
$-a^n u(-n)$ $-(\dots, \frac{1}{a^2}, \frac{1}{a^1}, \frac{1}{a^0})$	$-a^{n+1} u(-n-1)$ $-(\dots, \frac{1}{a^2}, \frac{1}{a^1}, \frac{1}{a^0})$

(3)  $/z$



$a^{-n}$

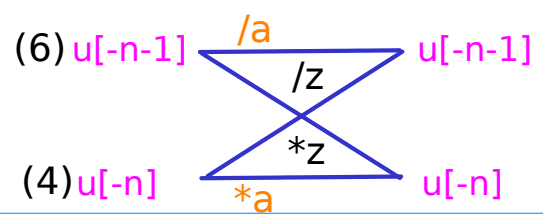
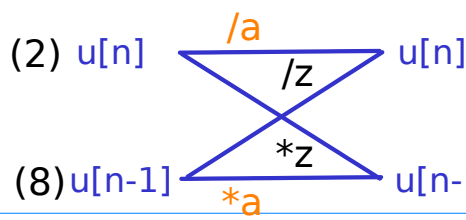
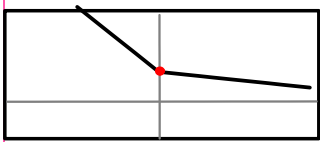

(2)  $/a$

$\frac{1}{1-a^{-1}z} \quad  z  < a$	$\frac{a^{-1}}{1-a^{-1}z} \quad  z  < a$
$\frac{a^{-1}z}{1-a^{-1}z} \quad  z  < a$	$\frac{z}{1-a^{-1}z} \quad  z  < a$

(2)  $/a$

$(\frac{1}{a})^n u(n)$ $(\frac{1}{a^0}, \frac{1}{a^1}, \frac{1}{a^2}, \dots)$	$(\frac{1}{a})^{n+1} u(n)$ $(\frac{1}{a^1}, \frac{1}{a^2}, \frac{1}{a^3}, \dots)$
$(\frac{1}{a})^n u(n-1)$ $(\frac{1}{a^1}, \frac{1}{a^2}, \frac{1}{a^3}, \dots)$	$(\frac{1}{a})^{n-1} u(n-1)$ $(\frac{1}{a^0}, \frac{1}{a^1}, \frac{1}{a^2}, \dots)$

(8)  $*a$

(8)  $*a$

(2)  $*z$

$\frac{1}{1-a^{-1}z} \quad  z  < a$	$\frac{z}{1-a^{-1}z} \quad  z  < a$
$\frac{a^{-1}z}{1-a^{-1}z} \quad  z  < a$	$\frac{a^{-1}}{1-a^{-1}z} \quad  z  < a$

(2)  $*z$

$(\frac{1}{a})^n u(n)$ $(\frac{1}{a^0}, \frac{1}{a^1}, \frac{1}{a^2}, \dots)$	$(\frac{1}{a})^{n-1} u(n-1)$ $(\frac{1}{a^2}, \frac{1}{a^1}, \frac{1}{a^3}, \dots)$
$(\frac{1}{a})^n u(n-1)$ $(\frac{1}{a^1}, \frac{1}{a^2}, \frac{1}{a^3}, \dots)$	$(\frac{1}{a})^{n+1} u(n)$ $(\frac{1}{a^1}, \frac{1}{a^2}, \frac{1}{a^3}, \dots)$

(8)  $/z$

(8)  $/z$

(6)  $/a$

$-\frac{az^{-1}}{1-az^{-1}} \quad  z  > a$	$-\frac{z^{-1}}{1-az^{-1}} \quad  z  > a$
$-\frac{1}{1-az^{-1}} \quad  z  > a$	$-\frac{a}{1-az^{-1}} \quad  z  > a$

(6)  $/a$

$-(\frac{1}{a})^n u(-n-1)$ $-(\dots, a^3, a^2, a^1)$	$-(\frac{1}{a})^{n+1} u(-n-1)$ $-(\dots, a^2, a^1, a^0)$
$-(\frac{1}{a})^n u(-n)$ $-(\dots, a^2, a^1, a^0)$	$-(\frac{1}{a})^{n-1} u(-n)$ $-(\dots, a^1, a^0, a^{-1})$

(4)  $*a$

(4)  $*a$

(6)  $*z$

$-\frac{az^{-1}}{1-az^{-1}} \quad  z  > a$	$-\frac{a}{1-az^{-1}} \quad  z  > a$
$-\frac{1}{1-az^{-1}} \quad  z  > a$	$-\frac{z^{-1}}{1-az^{-1}} \quad  z  > a$

(6)  $*z$

$-(\frac{1}{a})^n u(-n-1)$ $-(\dots, a^3, a^2, a^1)$	$-(\frac{1}{a})^{n-1} u(-n)$ $-(\dots, a^3, a^2, a^1)$
$-(\frac{1}{a})^n u(-n)$ $-(\dots, a^2, a^1, a^0)$	$-(\frac{1}{a})^{n+1} u(-n-1)$ $-(\dots, a^2, a^1, a^0)$

(4)  $/z$

(4)  $/z$

# Scale by **a**

## 1. Geometric Series

(1)

**\*a**

(2)

**/a**

	$\frac{1}{1-az} \quad  z  < a^{-1}$	$\frac{a}{1-az} \quad  z  < a^{-1}$	$\frac{1}{1-a^{-1}z} \quad  z  < a$	$\frac{a^{-1}}{1-a^{-1}z} \quad  z  < a$
Comp.ROC	$-\frac{a^{-1}z^{-1}}{1-a^{-1}z^{-1}} \quad  z  > a^{-1}$	$-\frac{z^{-1}}{1-a^{-1}z^{-1}} \quad  z  > a^{-1}$	$-\frac{az^{-1}}{1-az^{-1}} \quad  z  > a$	$-\frac{z^{-1}}{1-az^{-1}} \quad  z  > a$

(5)

**\*a**

(6)

**/a**

(3)

**/a**

(4)

**\*a**

	$-\frac{1}{1-a^{-1}z^{-1}} \quad  z  > a^{-1}$	$-\frac{a^{-1}}{1-a^{-1}z^{-1}} \quad  z  > a^{-1}$	$-\frac{1}{1-az^{-1}} \quad  z  > a$	$-\frac{a}{1-az^{-1}} \quad  z  > a$
Comp.ROC	$\frac{az}{1-az} \quad  z  < a^{-1}$	$\frac{z}{1-az} \quad  z  < a^{-1}$	$\frac{a^{-1}z}{1-a^{-1}z} \quad  z  < a$	$\frac{z}{1-a^{-1}z} \quad  z  < a$

(7)

**/a**

(8)

**\*a**

(1)	$a^n u(n)$	$\begin{array}{c} \xrightarrow{*a} \\ /z \\ \xrightarrow{*z} \end{array}$	$a^{n+1} u(n)$	(2)	$a^{-n} u(n)$	$\begin{array}{c} \xrightarrow{/a} \\ /z \\ \xrightarrow{*z} \end{array}$	$a^{-n-1} u(n)$
(7)	$a^n u(n-1)$	$\begin{array}{c} \xrightarrow{*z} \\ /a \end{array}$	$a^{n-1} u(n-1)$	(8)	$a^{-n} u(n-1)$	$\begin{array}{c} \xrightarrow{*a} \\ /z \end{array}$	$a^{-n+1} u(n-1)$
(5)	$a^n u(-n-1)$	$\begin{array}{c} \xrightarrow{*a} \\ /z \\ \xrightarrow{*z} \end{array}$	$a^{n+1} u(-n-1)$	(6)	$a^{-n} u(-n-1)$	$\begin{array}{c} \xrightarrow{/a} \\ /z \\ \xrightarrow{*z} \end{array}$	$a^{-n-1} u(-n-1)$
(3)	$a^n u(-n)$	$\begin{array}{c} \xrightarrow{*z} \\ /a \end{array}$	$a^{n-1} u(-n)$	(4)	$a^{-n} u(-n)$	$\begin{array}{c} \xrightarrow{*a} \\ /z \end{array}$	$a^{-n+1} u(-n)$

# Scale by **a**

## 2. Sequences

(1)

**\*a**

$a^n u(n)$
$- a^n u(-n-1)$

$a^{n+1} u(n)$
$- a^{n+1} u(-n-1)$

(2)

**/a**

$(\frac{1}{a})^n u(n)$
$-(\frac{1}{a})^n u(-n-1)$

$(\frac{1}{a})^{n+1} u(n)$
$-(\frac{1}{a})^{n+1} u(-n-1)$

Comp.ROC

(5)

**\*a**

$- a^n u(-n)$
$a^n u(n-1)$

$- a^{n-1} u(-n)$
$a^{n-1} u(n-1)$

(6)

**/a**

$-(\frac{1}{a})^n u(-n)$
$(\frac{1}{a})^n u(n-1)$

$-(\frac{1}{a})^{n-1} u(-n)$
$(\frac{1}{a})^{n-1} u(n-1)$

Comp.ROC

(3)

**/a**

(4)

**\*a**

(7)

**/a**

(8)

**\*a**

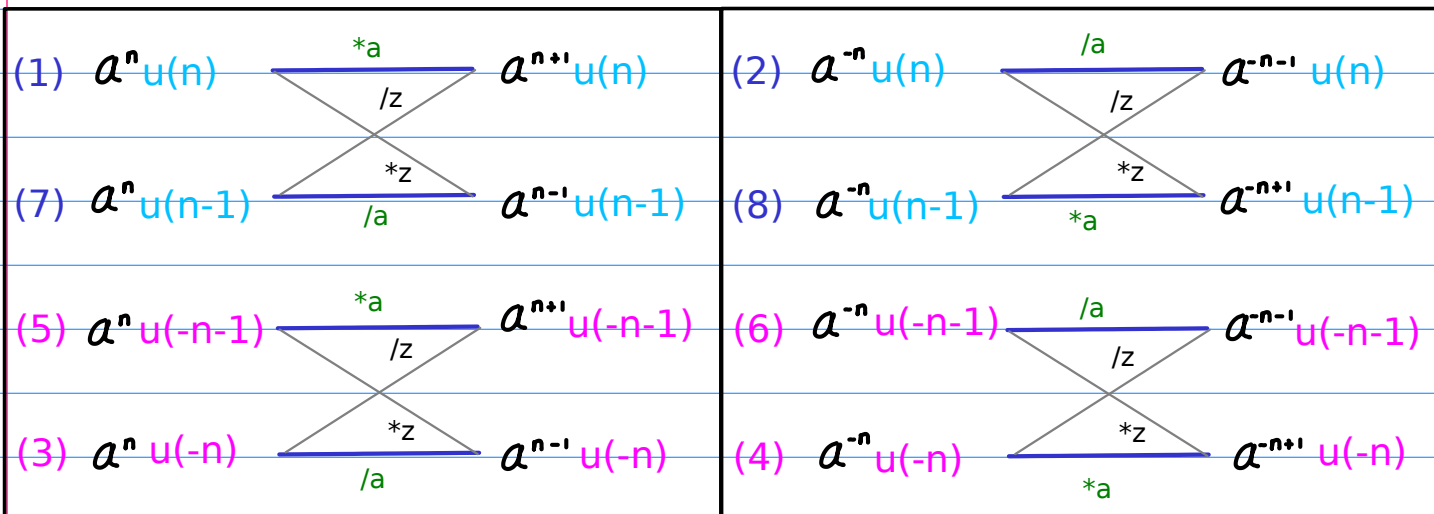

# Scale by **a**

## 3. Sequence values

(1)

**\*a**

$(a^0, a^1, a^2, \dots)$	$(a^1, a^2, a^3, \dots)$
$-(\dots, \frac{1}{a^2}, \frac{1}{a^3}, \frac{1}{a^4})$	$-(\dots, \frac{1}{a^2}, \frac{1}{a^3}, \frac{1}{a^4})$

(2)

**/a**

$(\frac{1}{a^0}, \frac{1}{a^1}, \frac{1}{a^2}, \dots)$	$(\frac{1}{a^1}, \frac{1}{a^2}, \frac{1}{a^3}, \dots)$
$-(\dots, a^3, a^2, a^1)$	$-(\dots, a^2, a^1, a^0)$

Comp.ROC

(5)

**\*a**

(3)

**/a**

$-(\dots, \frac{1}{a^2}, \frac{1}{a^3}, \frac{1}{a^4})$	$-(\dots, \frac{1}{a^3}, \frac{1}{a^4}, \frac{1}{a^5})$
$(a^1, a^2, a^3, \dots)$	$(a^0, a^1, a^2, \dots)$

(6)

**/a**

(4)

**\*a**

$-(\dots, a^2, a^1, a^0)$	$-(\dots, a^3, a^2, a^1)$
$(\frac{1}{a^1}, \frac{1}{a^2}, \frac{1}{a^3}, \dots)$	$(\frac{1}{a^0}, \frac{1}{a^1}, \frac{1}{a^2}, \dots)$

Comp.ROC

(7)

**/a**

(8)

**\*a**

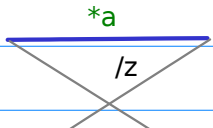
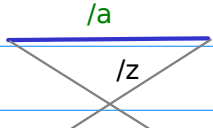
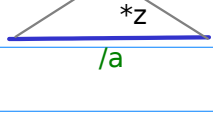
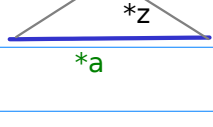
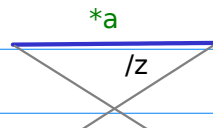
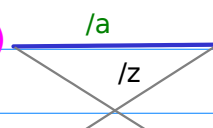
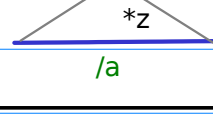
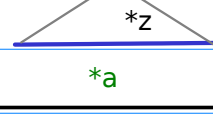
(1) $a^n u(n)$		$a^{n+1} u(n)$	(2) $a^{-n} u(n)$		$a^{-n-1} u(n)$
(7) $a^n u(n-1)$		$a^{n-1} u(n-1)$	(8) $a^{-n} u(n-1)$		$a^{-n+1} u(n-1)$
(5) $a^n u(-n-1)$		$a^{n+1} u(-n-1)$	(6) $a^{-n} u(-n-1)$		$a^{-n-1} u(-n-1)$
(3) $a^n u(-n)$		$a^{n-1} u(-n)$	(4) $a^{-n} u(-n)$		$a^{-n+1} u(-n)$

# Scale by **a**

## 4. Graphs

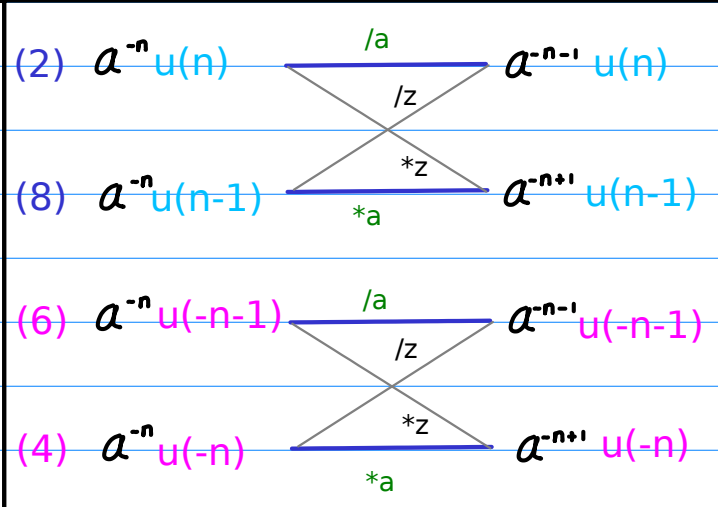
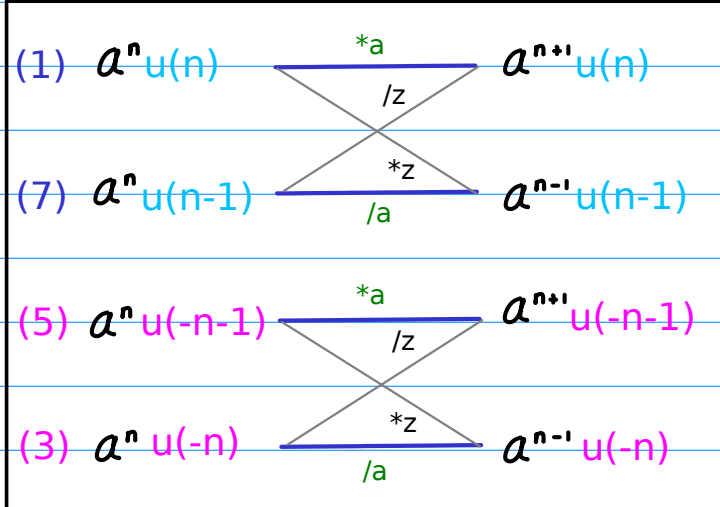
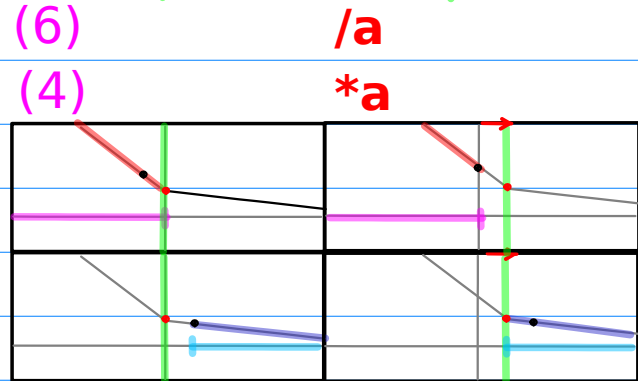
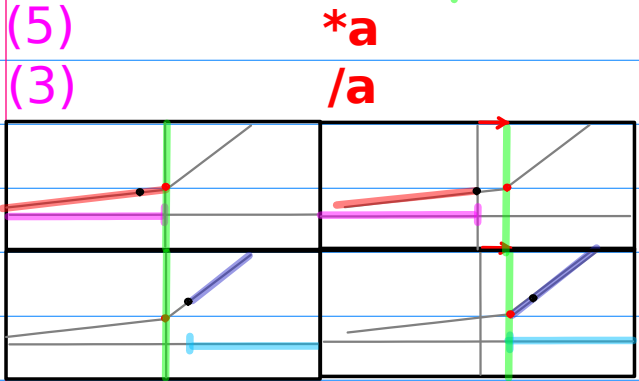
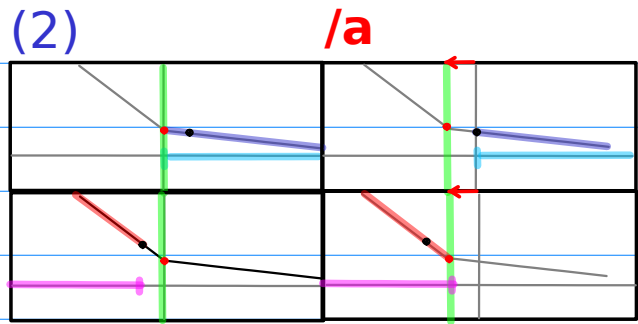
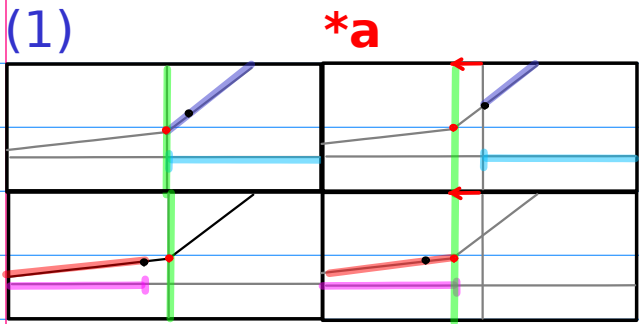

# Scale by **a**

## 5. Graphs - signs

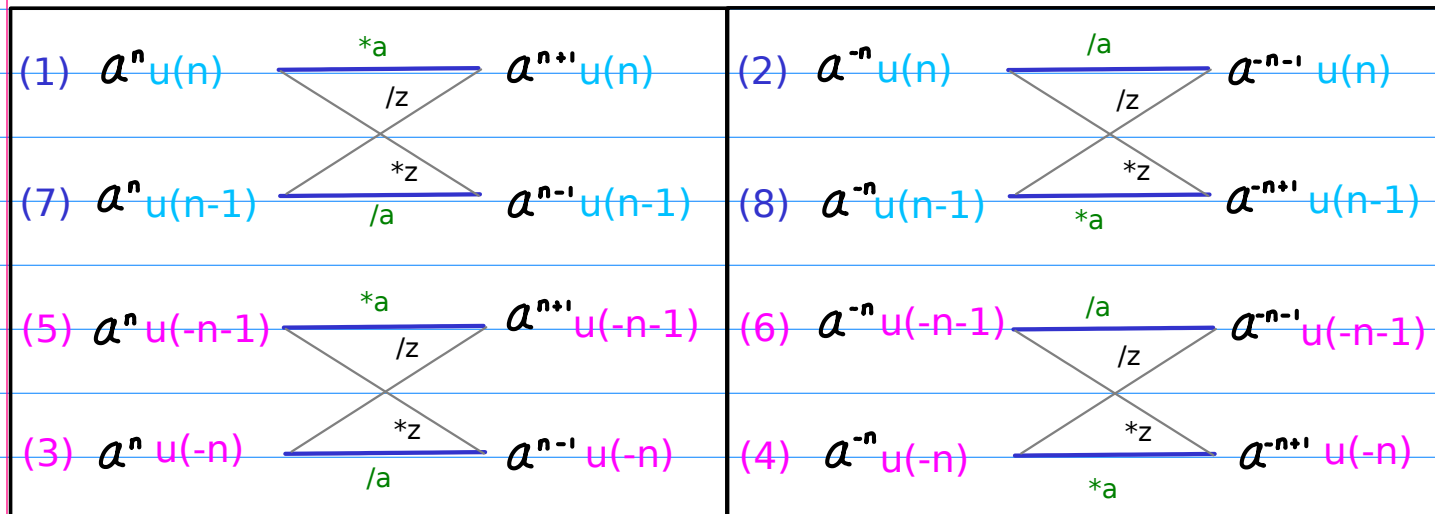
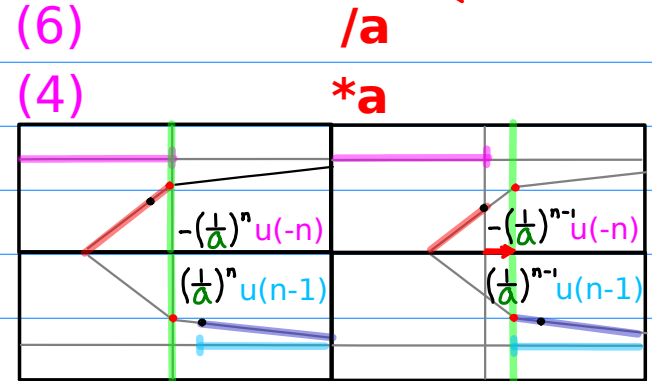
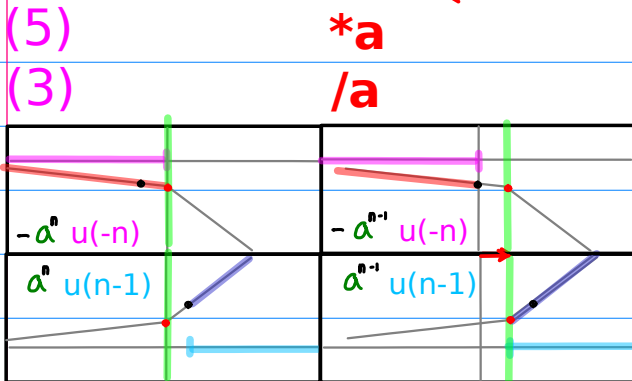
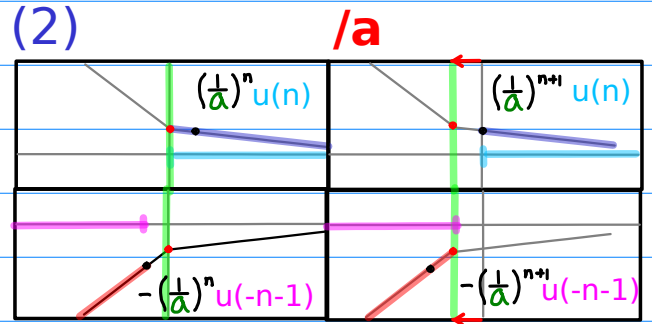
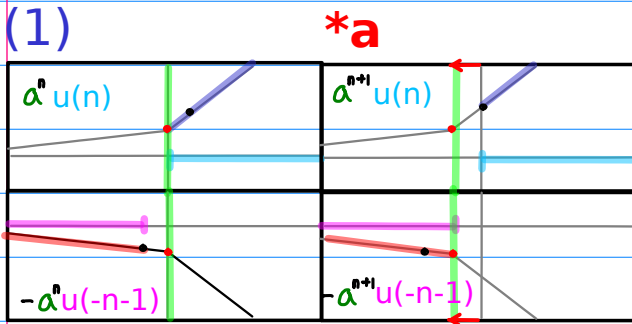

# Scale by **a**

## 6. Graphs - Exponents

(1) **\*a** ← SHL.Exp

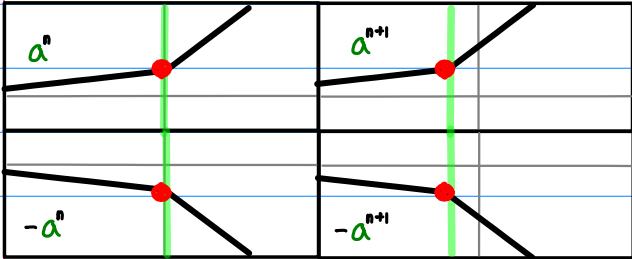

(2) **/a** ← SHL.Exp

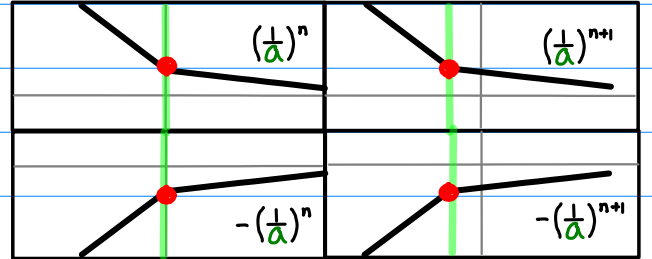

(5) **\*a** ← SHL.Exp

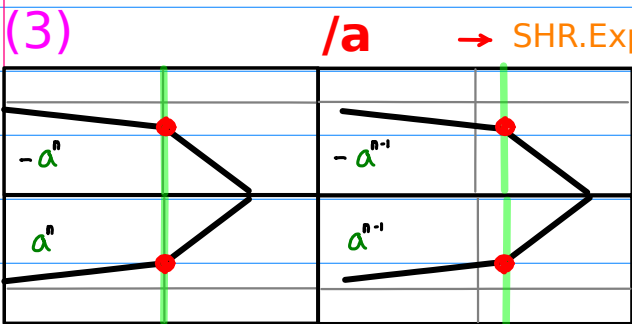

(6) **/a** ← SHL.Exp

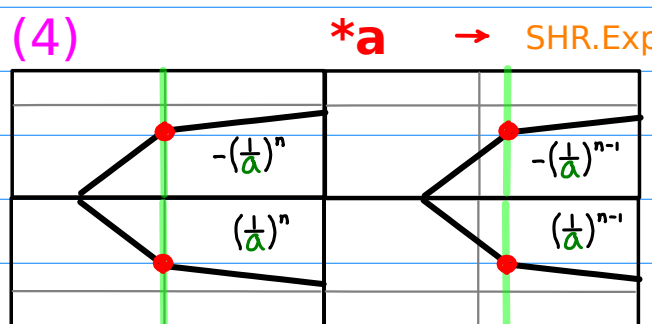

(3) **/a** → SHR.Exp

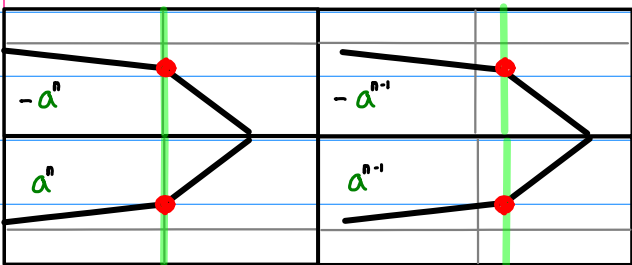

(4) **\*a** → SHR.Exp

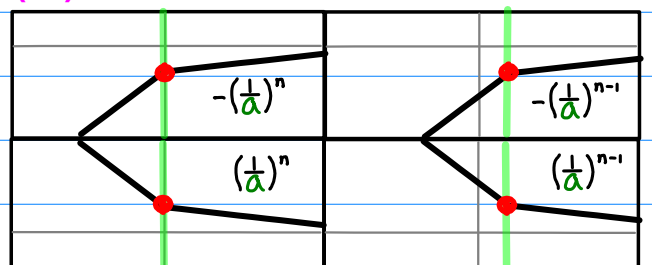

(7) **/a** → SHR.Exp

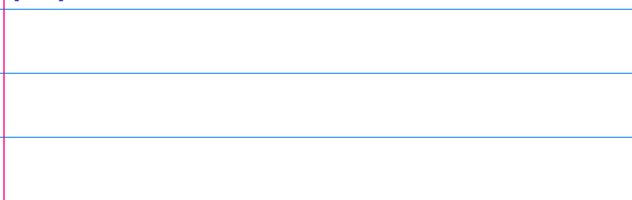

(8) **\*a** → SHR.Exp

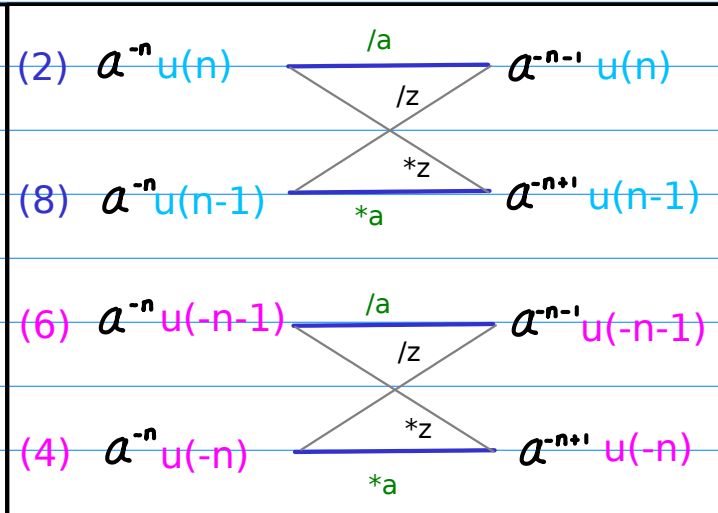
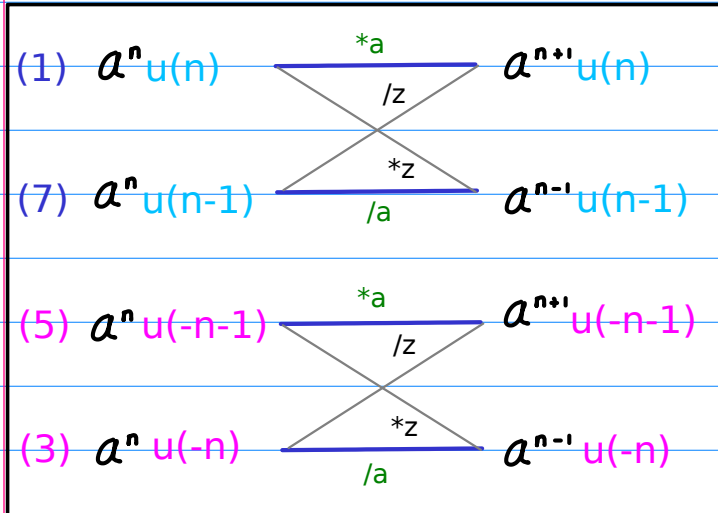
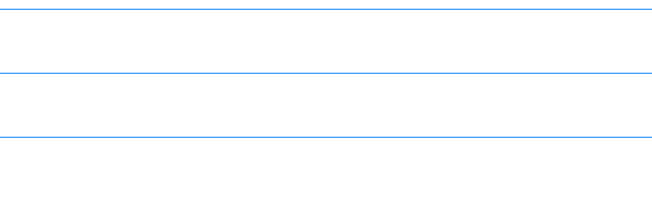

# Scale by **a**

## 7. Graphs - Ranges

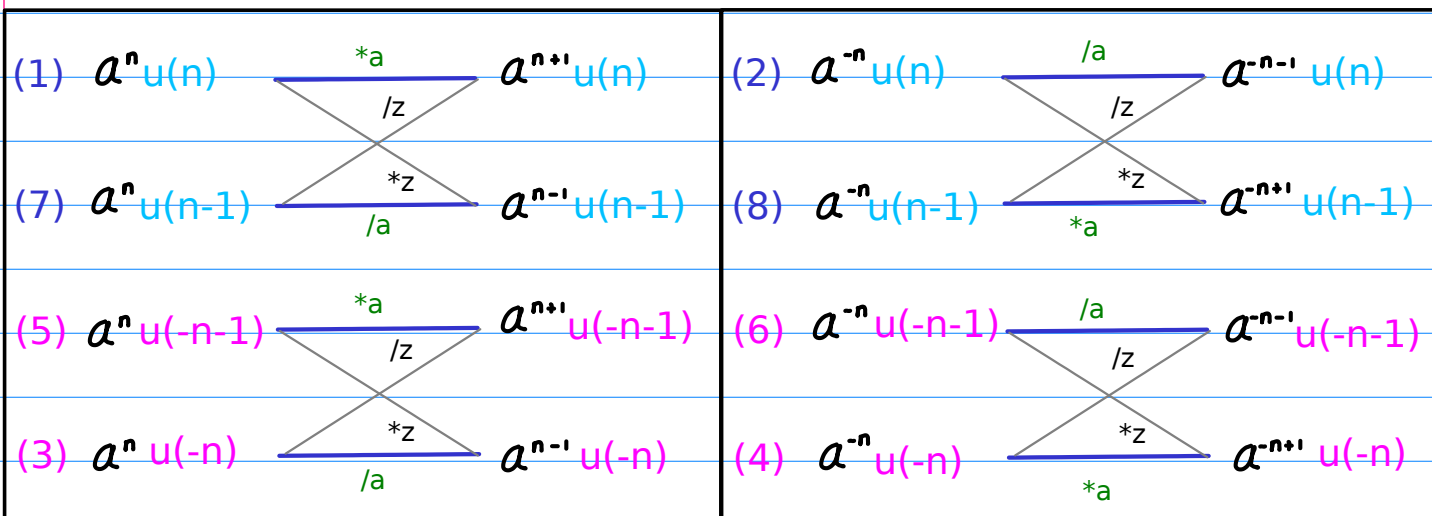
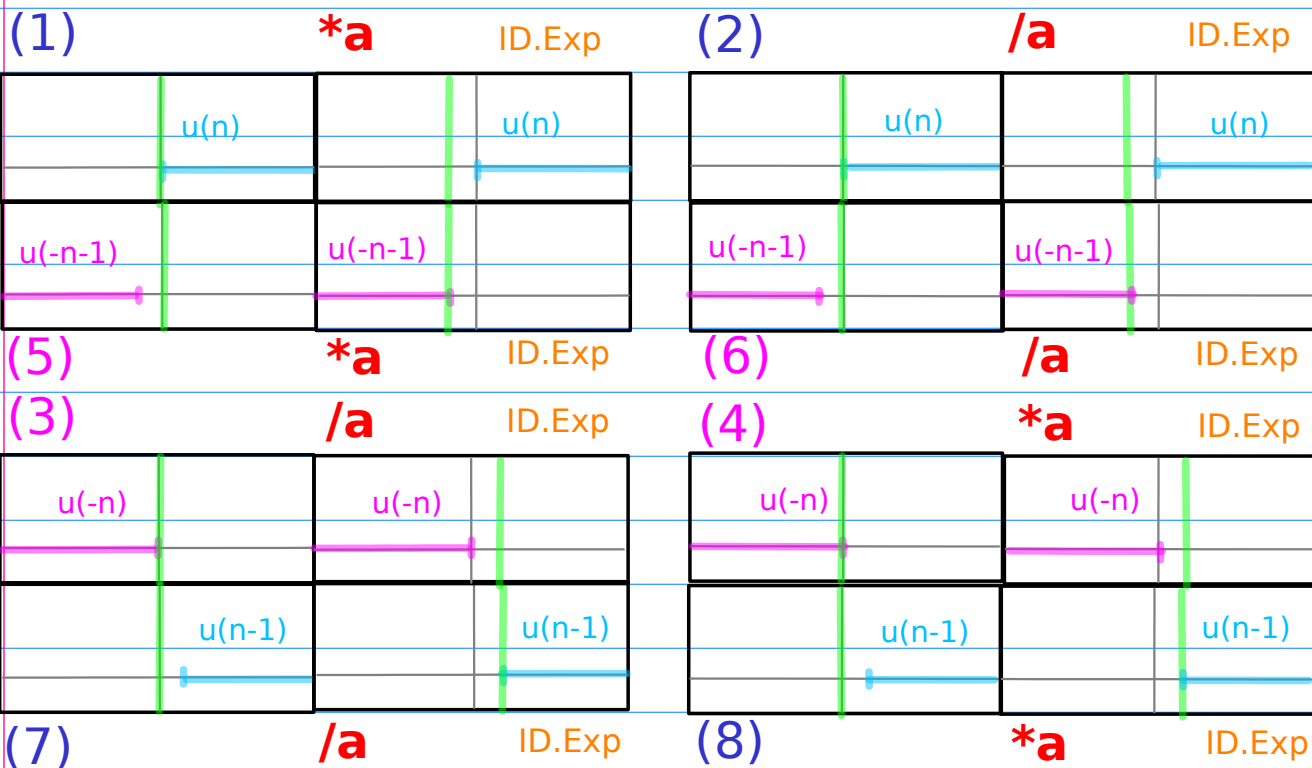



# Scale by $z$

## 1. Geometric Series

(1)

$*z$

$\frac{1}{1-az}$ $ z  < a^{-1}$	$\frac{z}{1-az}$ $ z  < a^{-1}$
$-\frac{a^{-1}z^{-1}}{1-a^{-1}z^{-1}}$ $ z  > a^{-1}$	$-\frac{a^{-1}}{1-a^{-1}z^{-1}}$ $ z  > a^{-1}$

(2)

$*z$

$\frac{1}{1-a^{-1}z}$ $ z  < a$	$\frac{z}{1-a^{-1}z}$ $ z  < a$
$-\frac{a^{-1}z^{-1}}{1-a^{-1}z^{-1}}$ $ z  > a$	$-\frac{a^{-1}}{1-a^{-1}z^{-1}}$ $ z  > a$

(5)

$*z$

$-\frac{1}{1-a^{-1}z^{-1}}$ $ z  > a^{-1}$	$-\frac{z^{-1}}{1-a^{-1}z^{-1}}$ $ z  > a^{-1}$
$\frac{az}{1-az}$ $ z  < a^{-1}$	$\frac{a}{1-az}$ $ z  < a^{-1}$

(6)

$*z$

$-\frac{1}{1-az^{-1}}$ $ z  > a$	$-\frac{z^{-1}}{1-az^{-1}}$ $ z  > a$
$\frac{a^{-1}z}{1-a^{-1}z}$ $ z  < a$	$\frac{a^{-1}}{1-a^{-1}z}$ $ z  < a$

(3)

$/z$

$-\frac{1}{1-a^{-1}z^{-1}}$ $ z  > a^{-1}$	$-\frac{z^{-1}}{1-a^{-1}z^{-1}}$ $ z  > a^{-1}$
$\frac{az}{1-az}$ $ z  < a^{-1}$	$\frac{a}{1-az}$ $ z  < a^{-1}$

(4)

$/z$

$-\frac{1}{1-az^{-1}}$ $ z  > a$	$-\frac{z^{-1}}{1-az^{-1}}$ $ z  > a$
$\frac{a^{-1}z}{1-a^{-1}z}$ $ z  < a$	$\frac{a^{-1}}{1-a^{-1}z}$ $ z  < a$

(7)

$/z$

(1) $a^n u(n)$	$*a$	$a^{n+1} u(n)$
(7) $a^n u(n-1)$	$/z$	$a^{n-1} u(n-1)$
(5) $a^n u(-n-1)$	$*z$	$a^{n+1} u(-n-1)$
(3) $a^n u(-n)$	$/a$	$a^{n-1} u(-n)$

(8)

$/z$

(2) $a^{-n} u(n)$	$/a$	$a^{-n-1} u(n)$
(8) $a^{-n} u(n-1)$	$/z$	$a^{-n-1} u(n-1)$
(6) $a^{-n} u(-n-1)$	$*z$	$a^{-n+1} u(-n-1)$
(4) $a^{-n} u(-n)$	$*a$	$a^{-n+1} u(-n)$

# Scale by $z$

## 2. Sequences

(1)

$*z$

$a^n u(n)$	$a^{n-1} u(n-1)$
$- a^n u(-n-1)$	$- a^{n-1} u(-n)$

(2)

$*z$

$(\frac{1}{a})^n u(n)$	$(\frac{1}{a})^{n-1} u(n-1)$
$- (\frac{1}{a})^n u(-n-1)$	$- (\frac{1}{a})^{n-1} u(-n)$

Comp.ROC

(5)

$*z$

$- a^n u(-n)$	$- a^{n+1} u(-n-1)$
$a^n u(n-1)$	$a^{n+1} u(n)$

(6)

$*z$

$- (\frac{1}{a})^n u(-n)$	$- (\frac{1}{a})^{n+1} u(-n-1)$
$(\frac{1}{a})^n u(n-1)$	$(\frac{1}{a})^{n+1} u(n)$

Comp.ROC

(3)

$/z$

(7)

$/z$

(4)

$/z$

(8)

$/z$

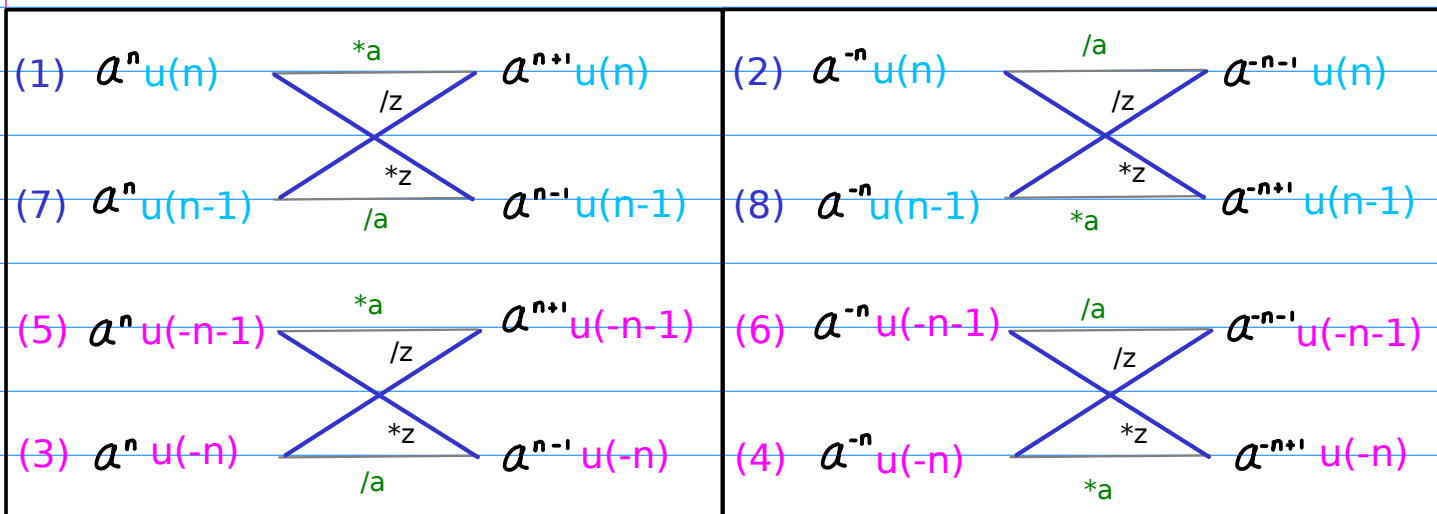

# Scale by $z$

## 3. Sequence values

(1)

$*z$

$(a^0, a^1, a^2, \dots)$	$(a^0, a^1, a^2, \dots)$
$-(\dots, \frac{1}{a^2}, \frac{1}{a^2}, \frac{1}{a^1})$	$-(\dots, \frac{1}{a^2}, \frac{1}{a^2}, \frac{1}{a^1})$

(2)

$*z$

$(\frac{1}{a^0}, \frac{1}{a^1}, \frac{1}{a^2}, \dots)$	$(\frac{1}{a^1}, \frac{1}{a^2}, \frac{1}{a^3}, \dots)$
$-(\dots, a^3, a^2, a^1)$	$-(\dots, a^3, a^2, a^1)$

Comp.ROC

(5)

$*z$

$-(\dots, \frac{1}{a^2}, \frac{1}{a^1}, \frac{1}{a^0})$	$-(\dots, \frac{1}{a^2}, \frac{1}{a^1}, \frac{1}{a^0})$
$(a^1, a^2, a^3, \dots)$	$(a^1, a^2, a^3, \dots)$

(6)

$*z$

$-(\dots, a^2, a^1, a^0)$	$-(\dots, a^2, a^1, a^0)$
$(\frac{1}{a^1}, \frac{1}{a^2}, \frac{1}{a^3}, \dots)$	$(\frac{1}{a^1}, \frac{1}{a^2}, \frac{1}{a^3}, \dots)$

Comp.ROC

(3)

$/z$

(7)

$/z$

(4)

$/z$

(8)

$/z$

(1) $a^n u(n)$	$*a$	$a^{n+1} u(n)$	(2) $a^{-n} u(n)$	$/a$	$a^{-n-1} u(n)$
(7) $a^n u(n-1)$	$/z$	$a^{n-1} u(n-1)$	(8) $a^{-n} u(n-1)$	$*z$	$a^{-n+1} u(n-1)$
(5) $a^n u(-n-1)$	$*a$	$a^{n+1} u(-n-1)$	(6) $a^{-n} u(-n-1)$	$/a$	$a^{-n-1} u(-n-1)$
(3) $a^n u(-n)$	$*z$	$a^{n-1} u(-n)$	(4) $a^{-n} u(-n)$	$*z$	$a^{-n+1} u(-n)$
	$/a$			$*a$	

# Scale by $z$

## 4. Graphs

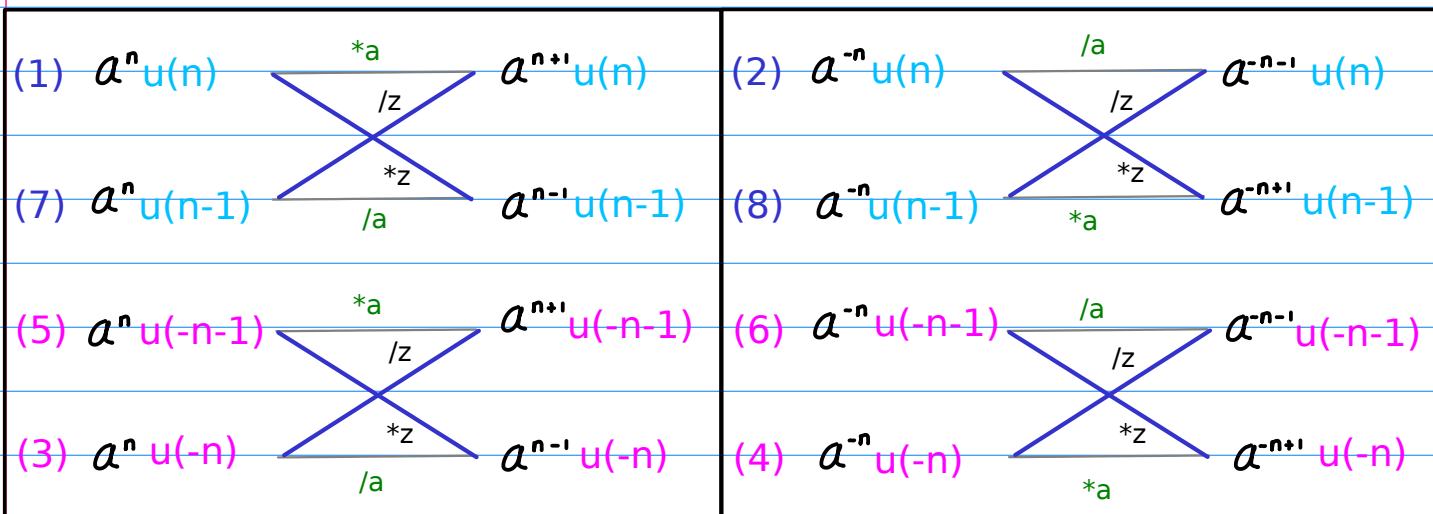
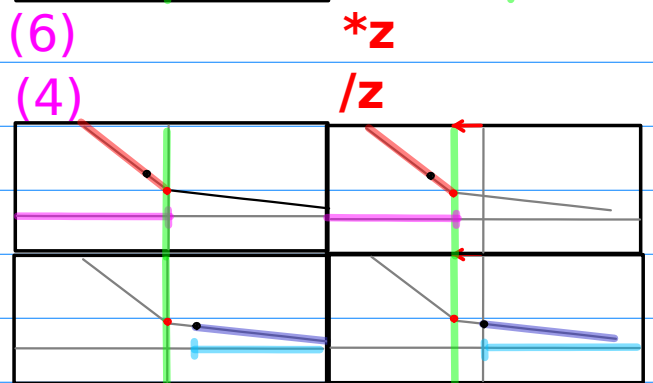
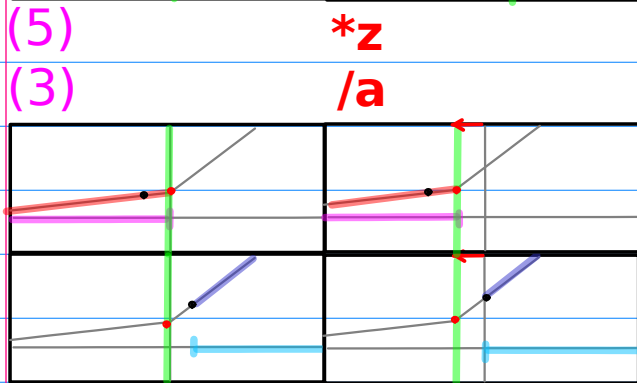
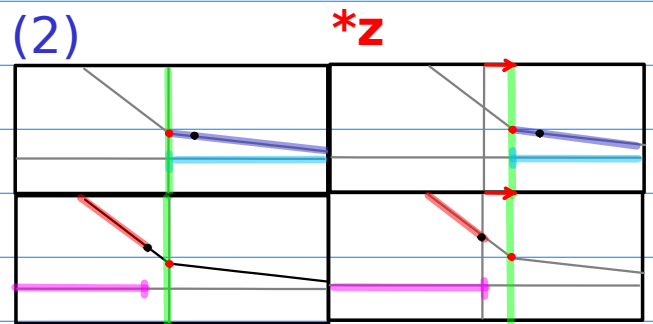
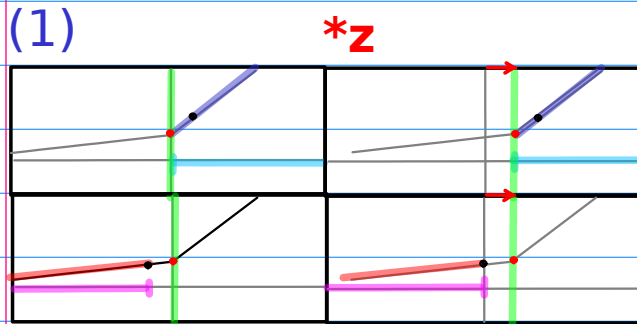

# Scale by $z$

## 5. Graphs - signs

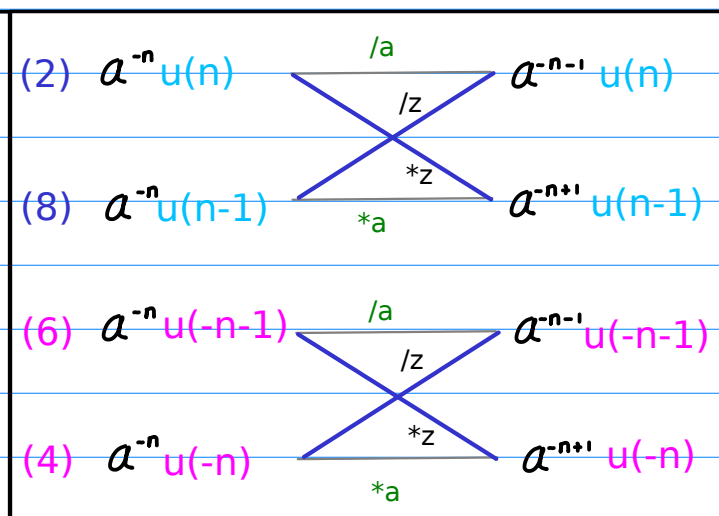
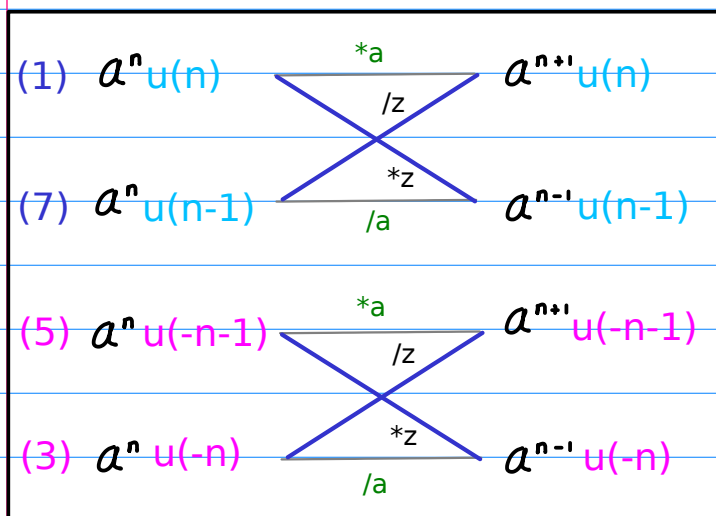
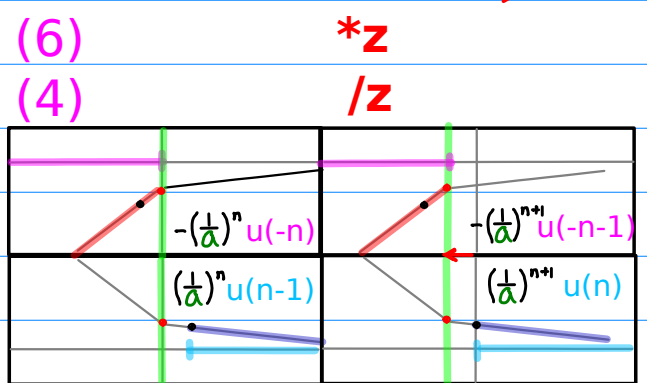
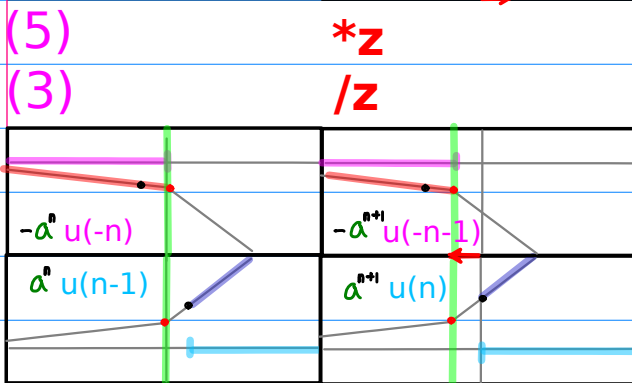
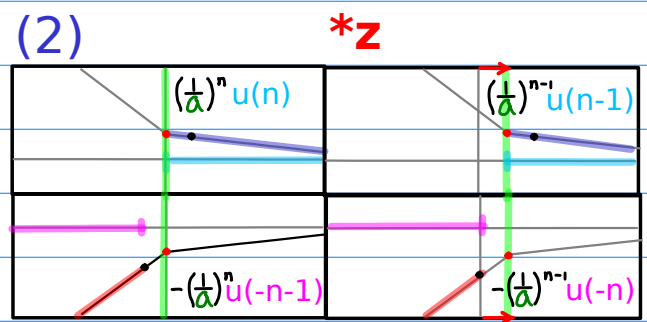
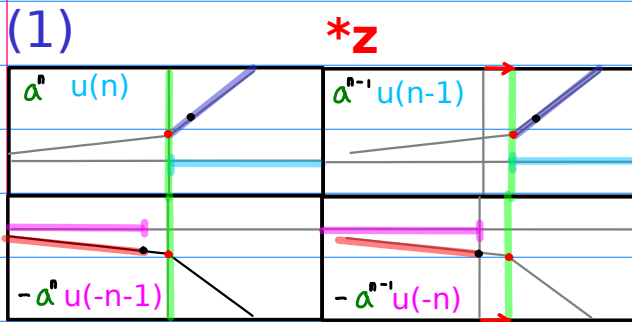

# Scale by $z$

## 6. Graphs - Exponents

(1)  $*z \rightarrow$  SHR.Exp (2)  $*z \rightarrow$  SHR.Exp

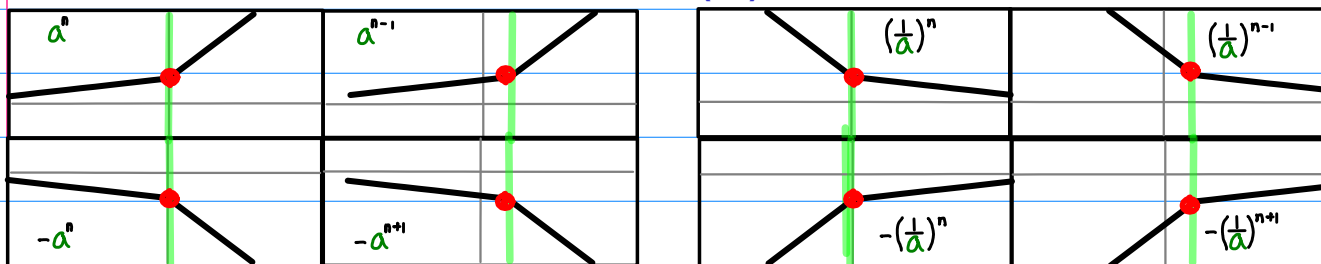

(5)  $*z \rightarrow$  SHR.Exp (6)  $*z \rightarrow$  SHR.Exp

(3)  $/z \leftarrow$  SHL.Exp (4)  $/z \leftarrow$  SHL.Exp

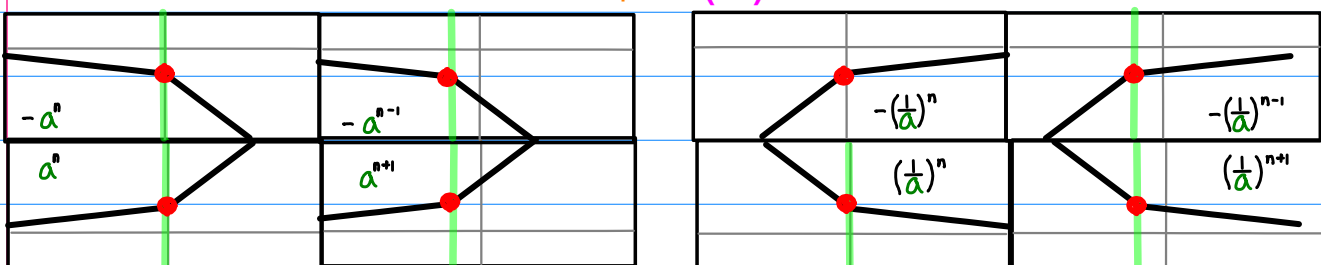

(7)  $/z \leftarrow$  SHL.Exp (8)  $/z \leftarrow$  SHL.Exp

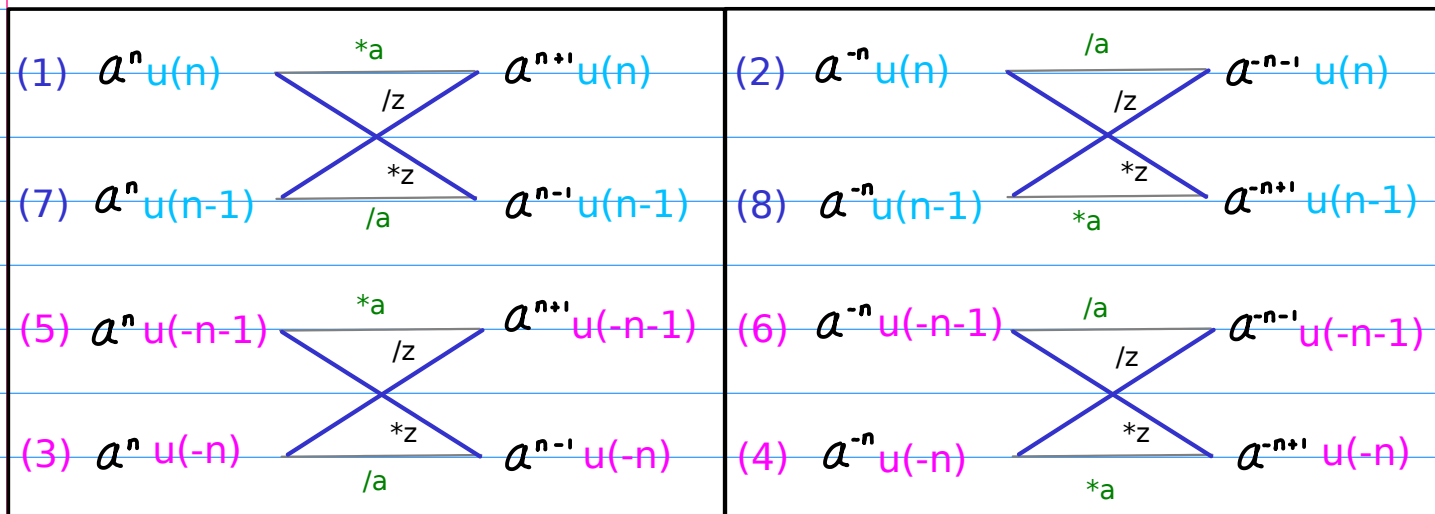

# Scale by $z$

## 7. Graphs - Ranges

