

SR Latch Forbidden State (A4)

Copyright (c) 2011-2013 Young W. Lim.

Permission is granted to copy, distribute and/or modify this document under the terms of the GNU Free Documentation License, Version 1.2 or any later version published by the Free Software Foundation; with no Invariant Sections, no Front-Cover Texts, and no Back-Cover Texts. A copy of the license is included in the section entitled "GNU Free Documentation License".

Please send corrections (or suggestions) to youngwlim@hotmail.com.

This document was produced by using OpenOffice and Octave.

NOR-based SR Latch

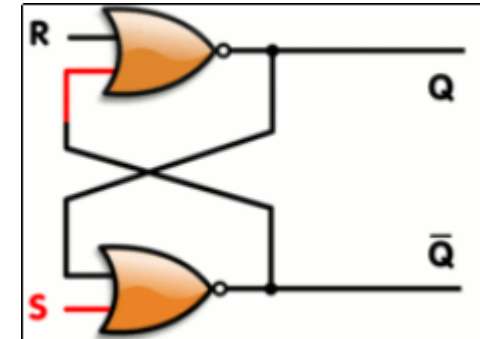
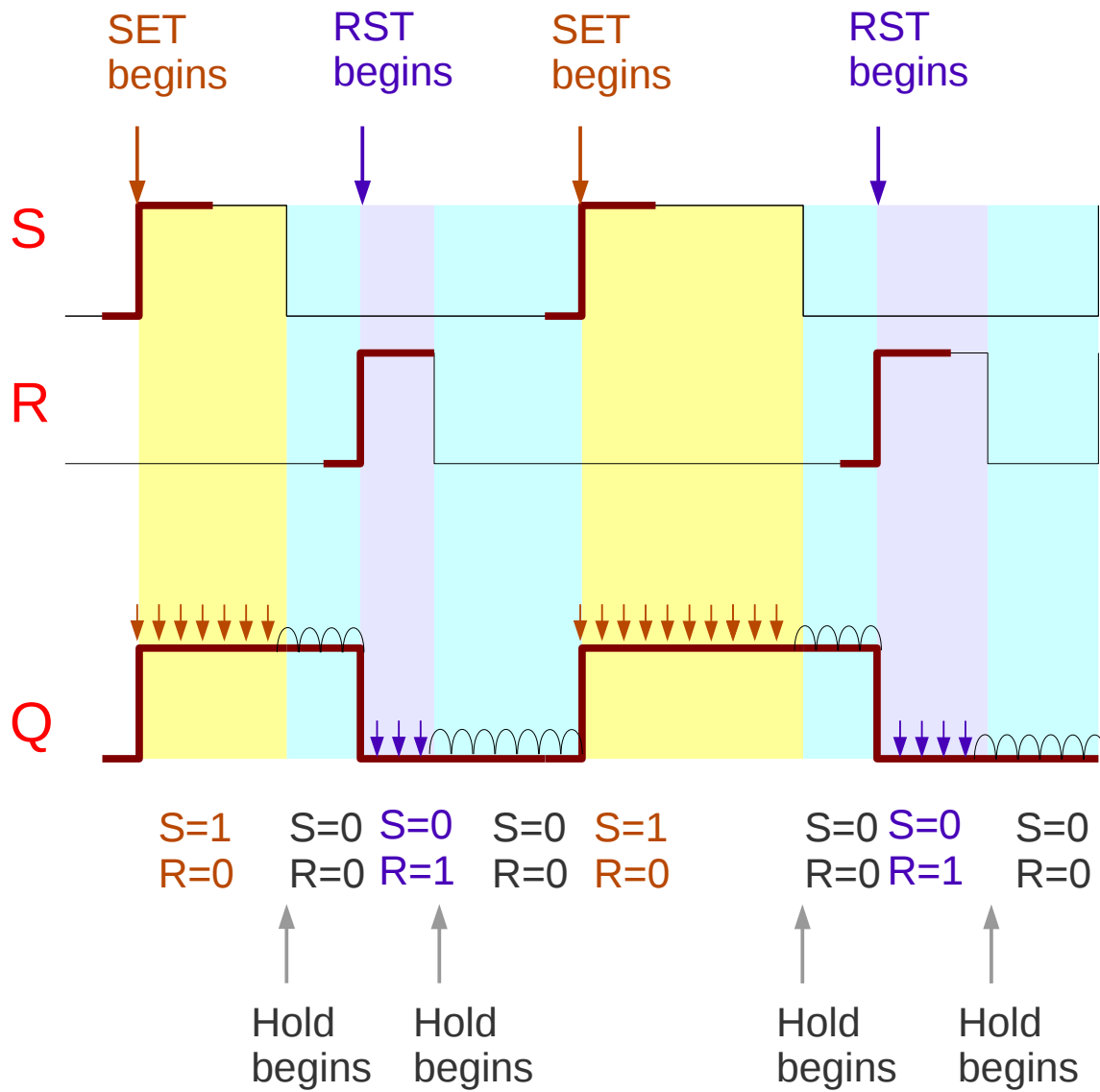

Gated SR Latch (SR=11)

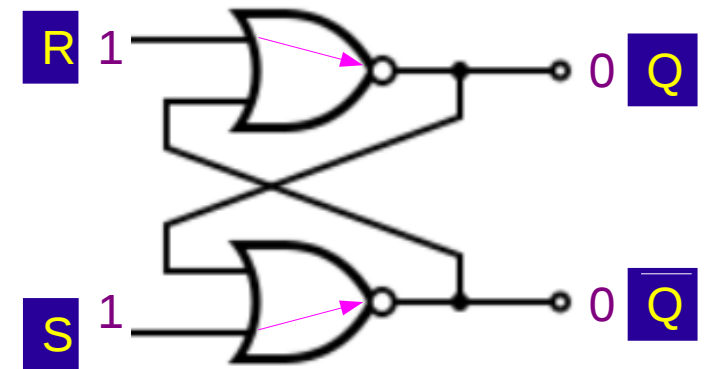
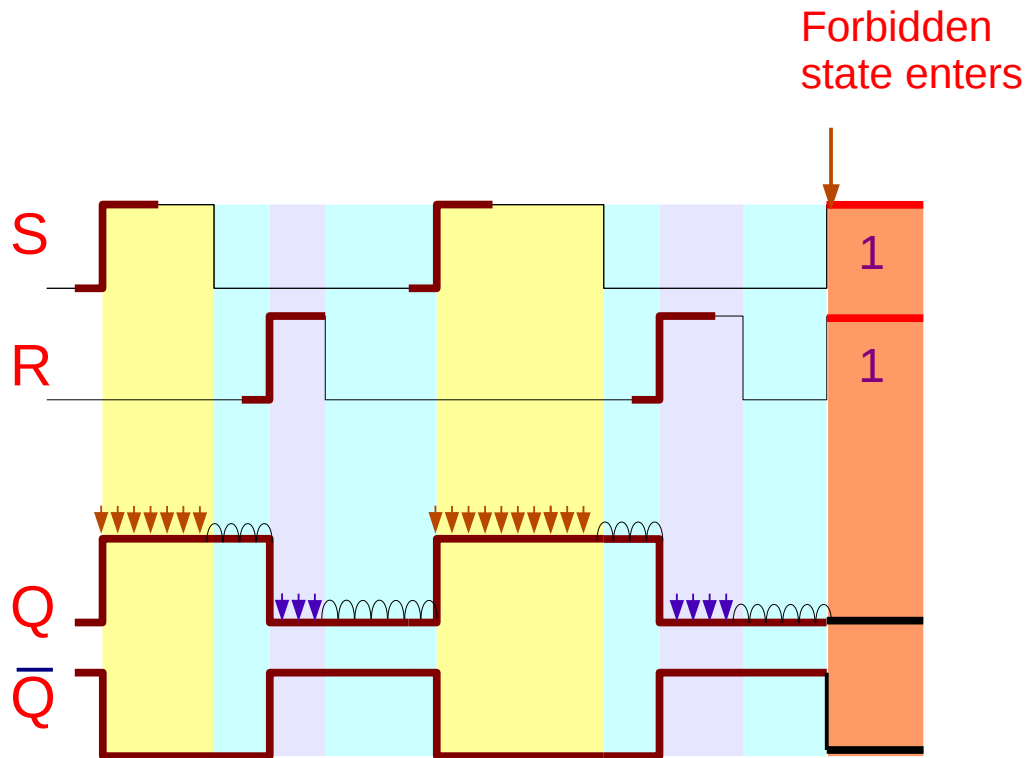

Gated SR Latch (SR=11 to 01)

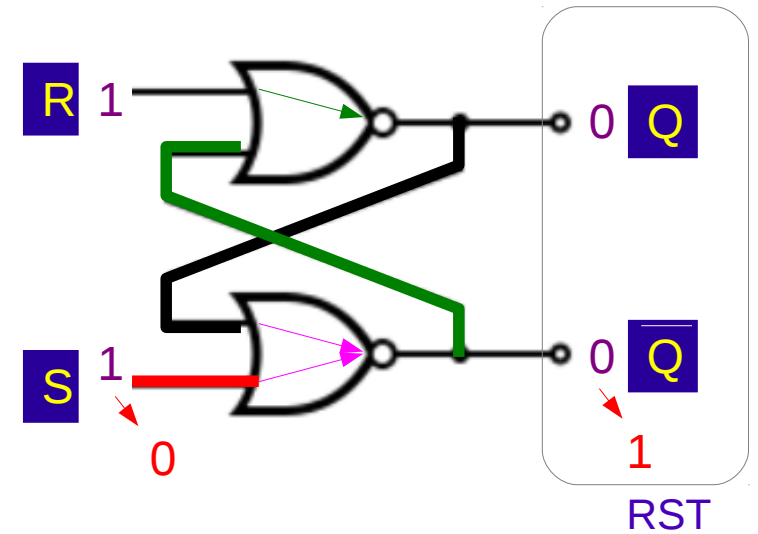
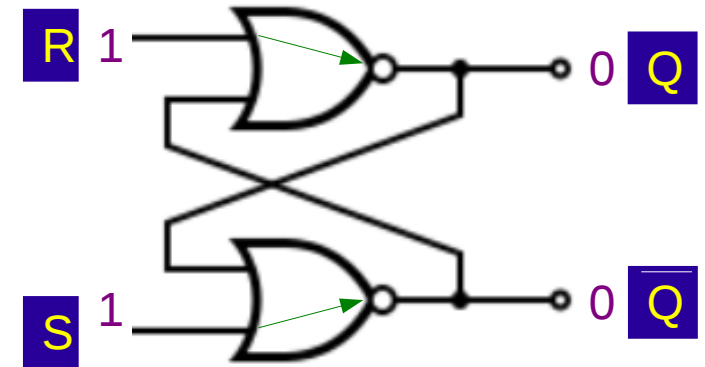
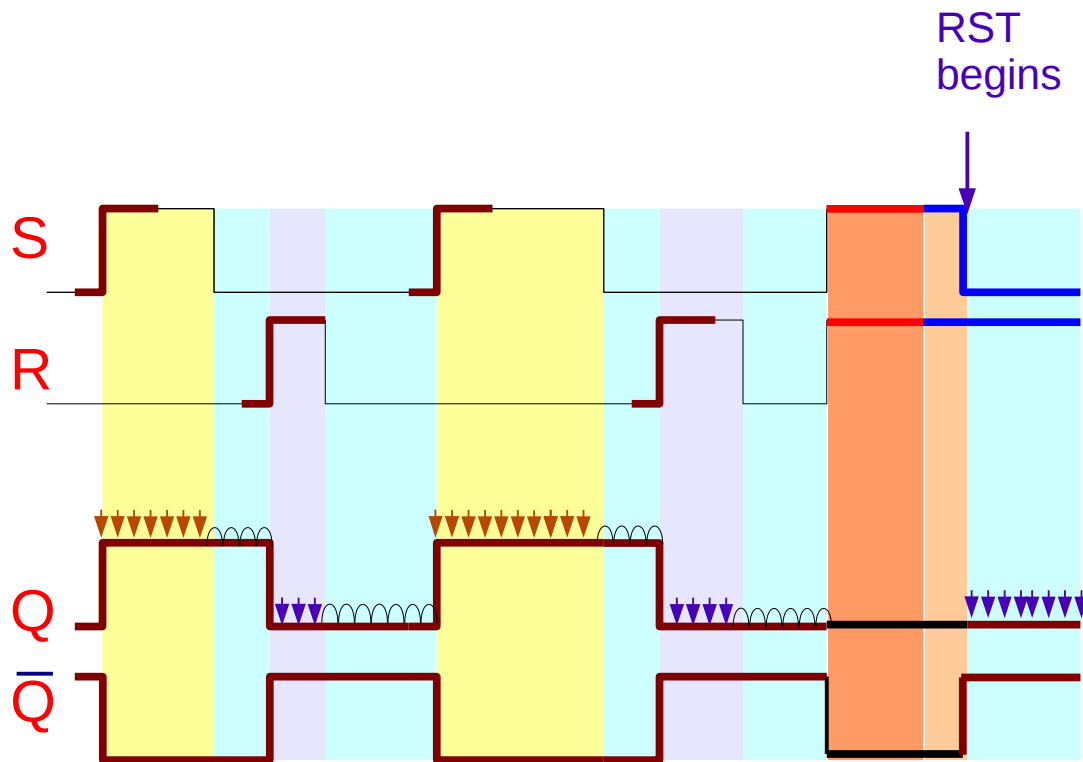

Gated SR Latch (SR=11 to 10)

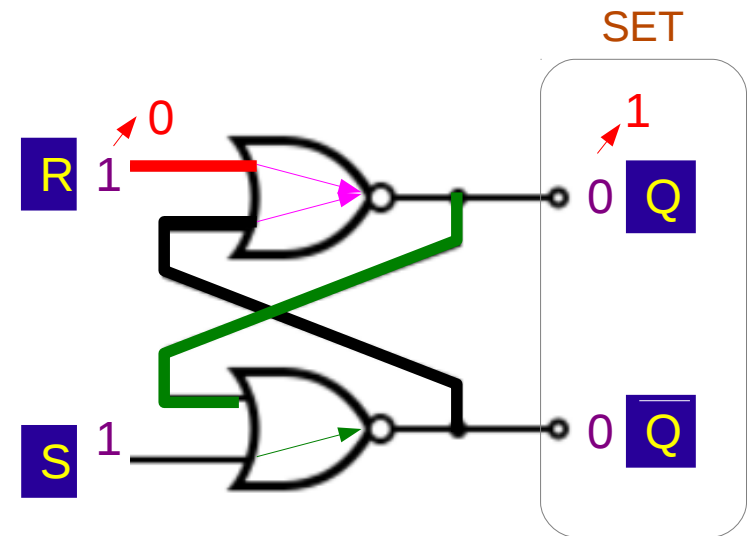
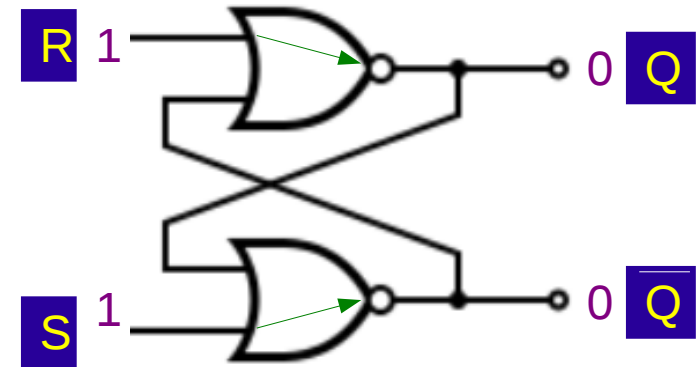
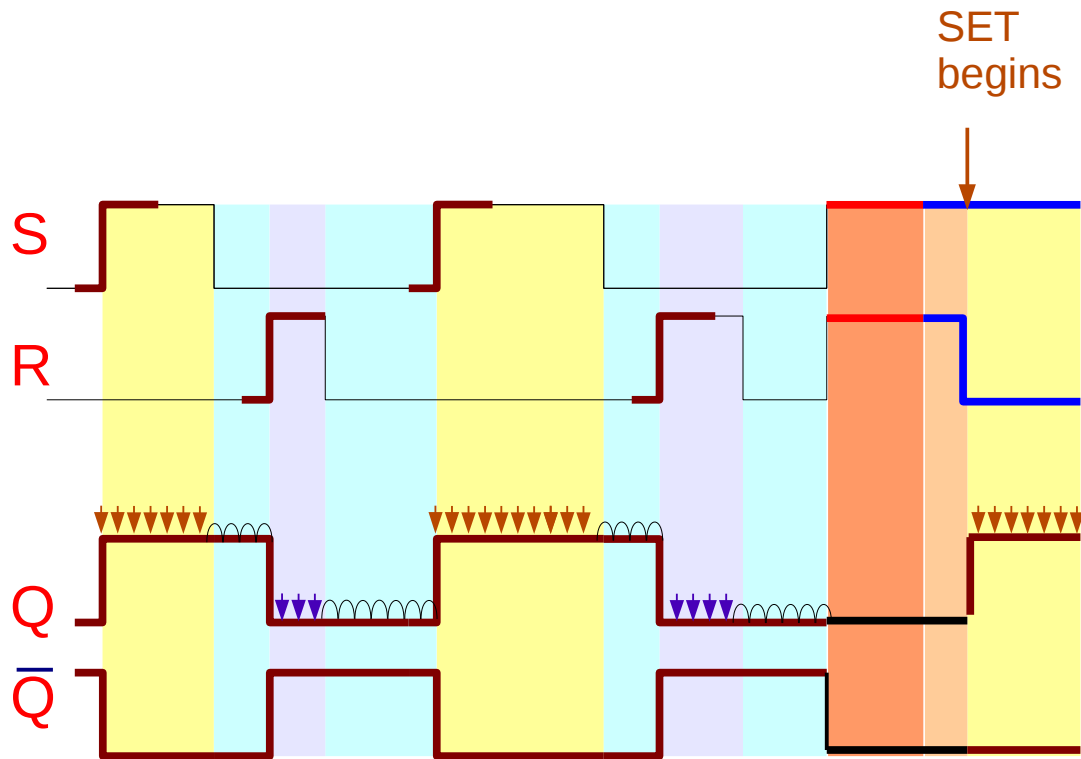

Gated SR Latch (SR=11 to 00)

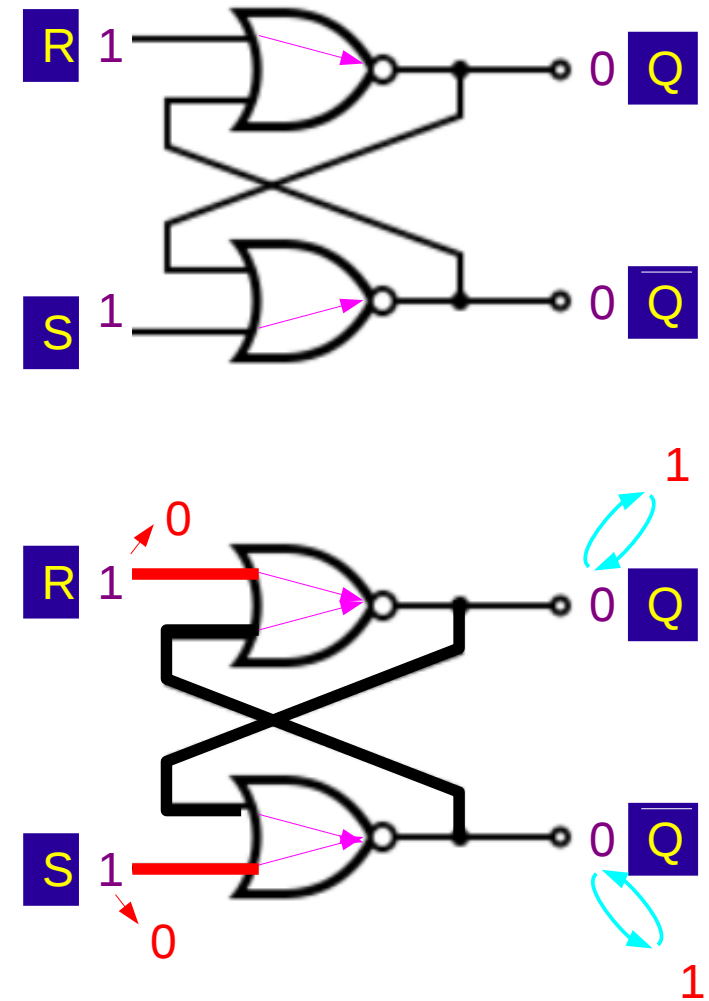
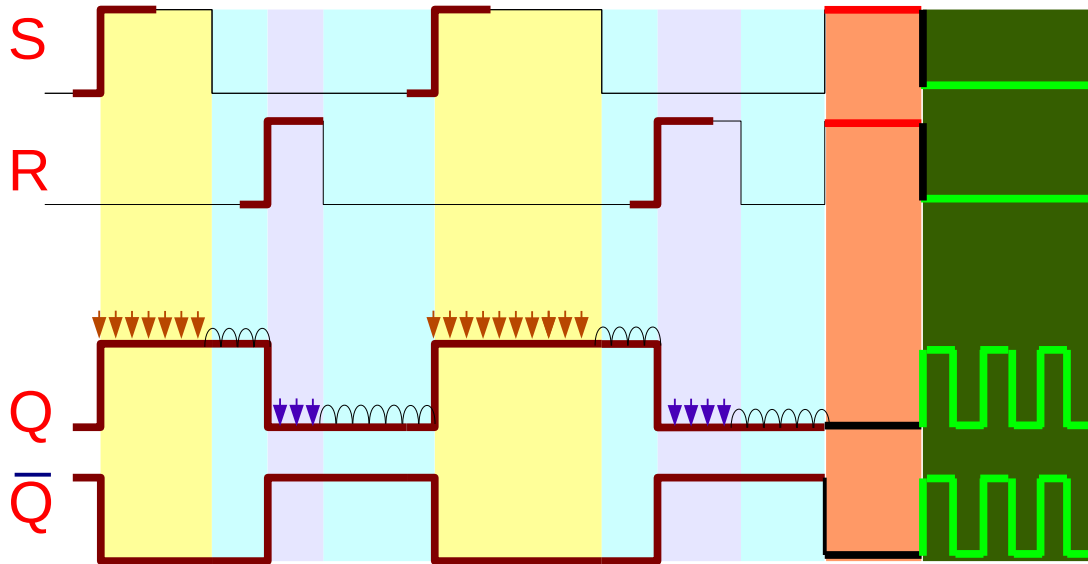

Gated SR Latch Oscillation State

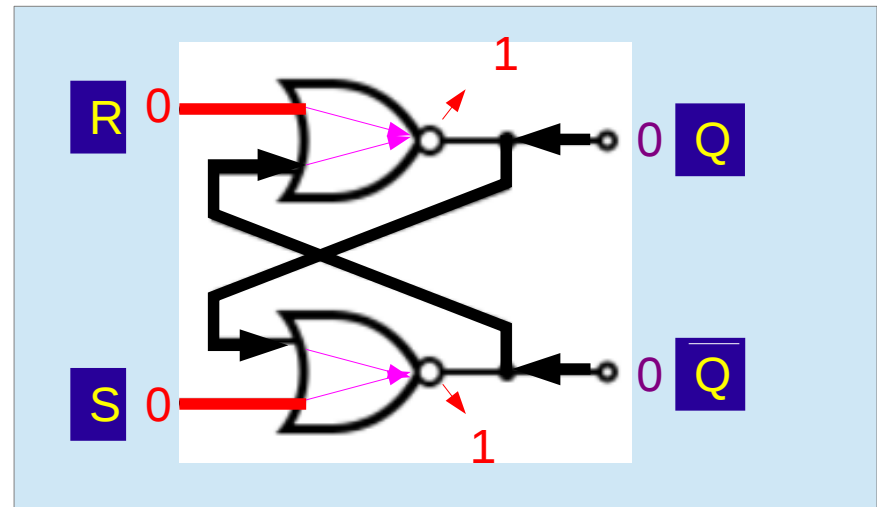
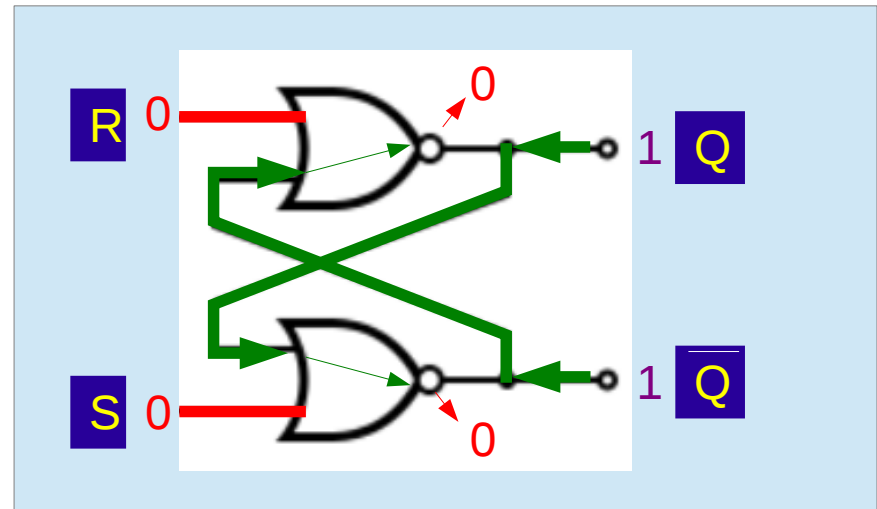
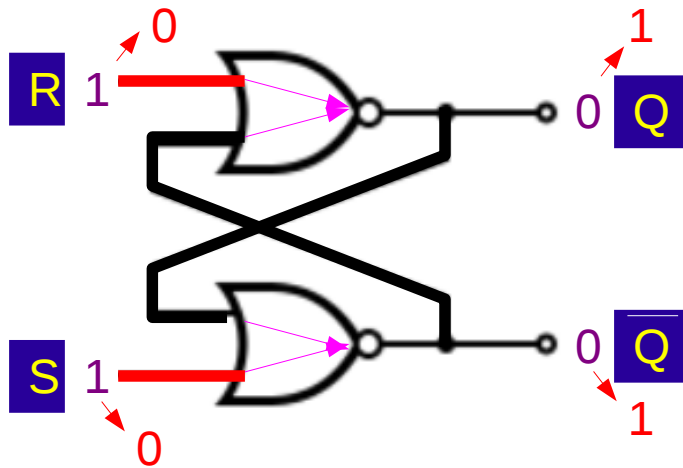
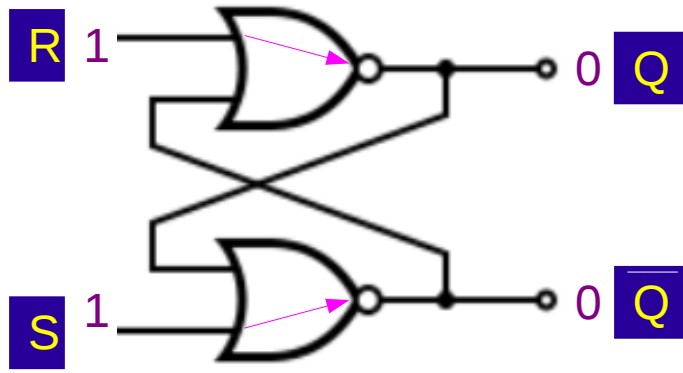

Forbidden State Transition

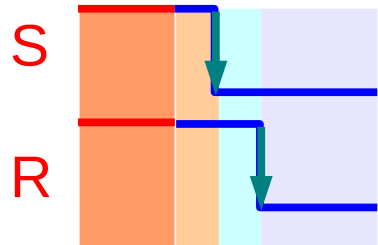

Forbidden St

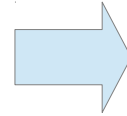

RESET, Hold

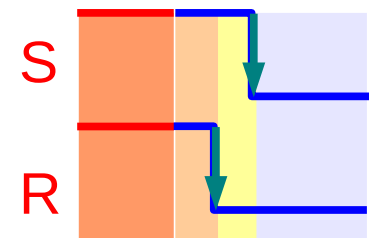

Forbidden St

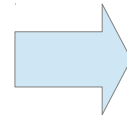

SET, Hold

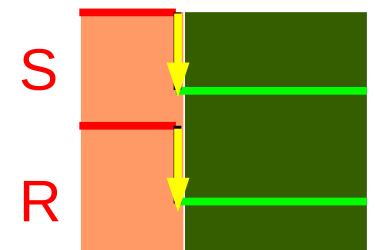

Forbidden St

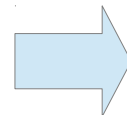

Oscillation

References

- [1] <http://en.wikipedia.org/>
- [2] M. M. Mano, C. R. Kime, "Logic and Computer Design Fundamentals", 4th ed.